

BIRLA CENTRAL LIBRARY  
PILANI [RAJASTHAN]

Class No. 627

Book No. D185H

Accession No. 32242





# HYDRAULIC TURBINES

*The quality of the materials used in the manufacture of this book is governed by continued postwar shortages.*





# HYDRAULIC TURBINES

WITH A CHAPTER ON  
CENTRIFUGAL PUMPS

BY

R. L. DAUGHERTY, A. B., M. E.

PROFESSOR OF MECHANICAL AND HYDRAULIC ENGINEERING, CALIFORNIA  
INSTITUTE OF TECHNOLOGY; FORMERLY PROFESSOR OF HYDRAULIC  
ENGINEERING, RENSSELAER POLYTECHNIC INSTITUTE.

THIRD EDITION  
REVISED, ENLARGED AND RESET

---

THIRTEENTH IMPRESSION

McGRAW-HILL BOOK COMPANY, INC.  
NEW YORK AND LONDON

~~C~~OPYRIGHT, 1913, 1920, BY THE  
M~~G~~RAW-HILL BOOK COMPANY, INC.

---

~~P~~RINTED IN THE UNITED STATES OF AMERICA

COMPOSITION BY THE MAPLE PRESS COMPANY, YORK, PA.  
PRINTED AND BOUND BY COMAC PRESS, INC., BROOKLYN, N. Y.

## PREFACE TO THE THIRD EDITION

Since this book was first written, practice has changed to such an extent that many statements, which were true at that time, are not true today. These portions have been entirely rewritten so as to present the very latest features in construction and practice. Also practically every other chapter has been altered and new matter and illustrations inserted, where it was thought that greater clearness could be so attained.

The presentation of the theory has been quite carefully considered and has been largely rewritten in order to be more effective. An attempt has been made to so arrange this that the fundamental principles could be grasped without going into a lot of technical details. If desired, certain portions of the latter, of theoretic interest only, can be omitted without breaking the continuity of thought.

Chapters have been added on turbine governors and on the methods of turbine design. The latter has been inserted in order to meet a demand for something on that subject. The methods that are given are those employed by the best designers at the present time. The procedure avoids the old "cut and try" practice on the one hand, as well as a highly theoretical treatment, that is of no practical value, on the other. It is rather a happy compromise between the two. The author is still of the opinion that the greater number of engineers are concerned with the construction and operating characteristics of turbines rather than with the details of their design. But there are some phases of turbine performance and construction that can be understood more completely, if approached from the view point of hydraulic design.

Questions and numerical problems have been added at the end of every chapter, in order to increase the usefulness of the book for instruction purposes. The questions are intended to call attention to the most important features presented in the chapter and also to bring out more clearly the thought there expressed. The problems are arranged so as to afford applications of the principles stated and are hence quite limited in character. If time available for the course permits, it is thought

*PREFACE*

that problems of a more general character are desirable. But it is believed that it is better for the instructor to prepare these to suit his individual course, and to vary them from year to year, rather than to incorporate such in the book.

The notation has been changed slightly in the present edition in order to conform more closely to the standard notation recommended by the Society for the Promotion of Engineering Education.

The author is indebted to many teachers and students, who have used the former editions, and also to engineers with whom he has discussed these matters for numerous suggestions which have been helpful to him in the preparation of the present volume.

R. L. D.

PASADENA, CALIF.,  
*February, 1920.*

## PREFACE TO THE SECOND EDITION

In addition to correcting typographical errors and rewriting two articles, the issuing of a second edition has afforded an opportunity to add new material which it is believed will increase the sphere of usefulness of the book. The discussion of several matters in the text has been amplified and there have been added numerous questions and problems. This together with the 15 tables of test data in Appendix C will afford much suitable material for instruction purposes.

The author wishes to acknowledge his indebtedness to Prof. E. H. Wood of Cornell University for his careful criticism of the first edition and to Prof. W. F. Durand of Leland Stanford University for much valuable assistance.

R. L. D.

ITHACA, N. Y.,  
*August*, 1914.

## PREFACE TO THE FIRST EDITION

The design of hydraulic turbines is a highly specialized industry, requiring considerable empirical knowledge, which can be acquired only through experience; but it is a subject in which comparatively few men are interested, as a relatively small number are called upon to design turbines. But with the increasing use of water power many men will find it necessary to become familiar with the construction of turbines, understand their characteristics, and be able to make an intelligent selection of a type and size of turbine for any given set of conditions. To this latter class this book is largely directed. However, a clear understanding of the theory, as here presented, ought to be of interest to many designers, since it is desirable that American designs be based more upon a mathematical analysis, as in Europe, and less upon the old cut and try methods.

The broad problem of the development of water power is treated in a very general way so that the reader may understand the conditions that bear upon the choice of a turbine. Thus the very important items of stream gauging and rating, rainfall and runoff, storage, etc., are treated very briefly, the detailed study of these topics being left for other works.

The purpose of the text is to give the following: A general idea of water-power development and conditions affecting the turbine operation, a knowledge of the principal features of construction of modern turbines, an outline of the theory and the characteristics of the principal types, commercial constants, means of selection of type and size of turbine, cost of turbines and water power and comparison with cost of steam power. A chapter on centrifugal pumps is also added. It is hoped that the book may prove of value both to the student as a text and to the practicing engineer as a reference. R. L. D.

CORNELL UNIVERSITY, ITHACA, N. Y.,

*August, 1913.*

# CONTENTS

|                   | PAGE |
|-------------------|------|
| PREFACE . . . . . | v    |

## CHAPTER I

|  |   |
|--|---|
| INTRODUCTION . . . . .   | 1 |
| Historical—The turbine—Advantage of turbine over water wheel—<br>Advantages of water wheel over turbine—Essentials of a water-<br>power plant—Questions. |   |

## CHAPTER II

|   |   |
|---|---|
| TYPES OF TURBINES AND SETTINGS . . . . .  | 7 |
| Classification of turbines—Action of water—Direction of flow—<br>Position of shaft—Arrangement of runners—The draft tube—<br>Flumes and penstocks—Questions |   |

## CHAPTER III

|  |    |
|--|----|
| WATER POWER . . . . .  | 15 |
| Investigation—Rating curve—The hydrograph—Rainfall and<br>run-off—Absence of satisfactory hydrograph—Variation of head—<br>Power of stream—Pondage and load curve—Storage—Storage and<br>turbine selection—Power transmitted through pipe line—Pipe line<br>and speed regulation—Questions and problems. |    |

## CHAPTER IV

|  |    |
|--|----|
| THE TANGENTIAL WATER WHEEL . . . . .   | 30 |
| Development—Buckets—General proportions—Speed regulation<br>—Conditions of use—Efficiency—Questions. |    |

## CHAPTER V

|   |    |
|---|----|
| THE REACTION TURBINE . . . . .  | 41 |
| Development—Advantages of inward flow turbine—General pro-<br>portions of types of runners—Comparison of types of runners—<br>Runners—Speed regulation—Bearings—Cases—Draft tube con-<br>struction—Velocities—Conditions of use—Efficiency—Questions. |    |



CONTENTS

CHAPTER VI

**TURBINE GOVERNORS . . . . . 74**  
 General principles—Types of governors—The compensated governor—Questions.

CHAPTER VII

**GENERAL THEORY . . . . . 80**  
 Equation of continuity—Relation between absolute and relative velocities—The general equation of energy—Effective head on wheel—Power and efficiency—Force exerted—Force upon moving object—Torque exerted—Power and head delivered to runner—Equation of energy for relative motion—Impulse turbine—Reaction turbine—Effect of different speeds—Forced vortex—Free vortex—Theory of draft tube—Questions and problems.

CHAPTER VIII

**THEORY OF THE TANGENTIAL WATER WHEEL . . . . . 105**  
 Introductory—The angle  $\alpha_1$ —The ratio of the radii—Force exerted—Power—The value of  $W$ —The value of  $k$ —Constant input—Variable speed—Best speed—Constant speed—Variable input—Observations on theory—Illustrative problem—Questions and problems.

CHAPTER IX

**THEORY OF THE REACTION TURBINE . . . . . 121**  
 Introductory—Simple theory—Conditions for maximum efficiency—Determination of speed for maximum efficiency—Losses—Relation between speed and discharge—Torque, power, and efficiency—Variable speed and constant gate opening—Constant speed and variable input—Runner discharge conditions—Limitations of theory—Effect of  $y$ —Questions and problems.

CHAPTER X

**TURBINE TESTING . . . . . 140**  
 Importance—Purpose of test—Measurement of head—Measurement of water—Measurement of output—Working up results—Determination of mechanical losses—Questions and problems.

CHAPTER XI

**GENERAL LAWS AND CONSTANTS . . . . . 150**  
 Head—Diameter of runner—Commercial constants—Diameter and discharge—Diameter and power—Specific speed—Determination of constants—Illustrative case—Uses of constants—Numerical illustrations—Questions and problems.

CHAPTER XII

**TURBINE CHARACTERISTICS . . . . . 164**  
 Efficiency as a function of speed and gate opening—Specific speed  
 an index of type—Illustrations of specific speed—Selection of a  
 stock turbine—Illustrative case—Variable load and head—Char-  
 acteristic curve—Use of characteristic curve—Questions and  
 problems.

CHAPTER XIII

**SELECTION OF TYPE OF TURBINE . . . . . 177**  
 Possible choice—Maximum efficiency—Efficiency on part-load—  
 Overgate with high-speed turbine—Type of runner as a function  
 of head—Choice of type for low head—Choice of type for medium  
 head—Choice of type for high head—Choice of type for very high  
 head—Questions and problems.

CHAPTER XIV

**COST OF TURBINES AND WATER POWER . . . . . 192**  
 General considerations—Cost of turbines—Capital cost of water  
 power—Annual cost of water power—Cost of power per horse-  
 power-hour—Sale of power—Comparison with steam power—  
 Value of water power—Questions and problems.

CHAPTER XV

**DESIGN OF THE TANGENTIAL WATER WHEEL . . . . . 204**  
 General dimensions—Nozzle design—Pitch of buckets—Design  
 of buckets—Dimensions of case—Questions and problems.

CHAPTER XVI

**DESIGN OF THE REACTION TURBINE . . . . . 211**  
 Introductory—General dimensions—Profile of runner—Outflow  
 conditions and clear opening—Layout of vane on developed cones—  
 Intermediate profiles—Pattern maker's sections—The case and  
 speed ring—The guide vanes—Questions and problems.

CHAPTER XVII .

**CENTRIFUGAL PUMPS . . . . . 230**  
 Definition—Classification—Centrifugal action—Notation—Defini-  
 tion of head and efficiency—Head imparted to water—Losses—  
 Head of impending delivery—Relation between head, speed and  
 discharge—Defects of theory—Efficiency of a given pump—  
 Efficiency of series of pumps—Specific speed of centrifugal pumps  
 —Conditions of service—Construction—Questions and problems.

|                                  |     |
|----------------------------------|-----|
| APPENDIX A . . . . .             | 249 |
| The retardation curve            |     |
| APPENDIX B . . . . .             | 251 |
| Stream lines in curved channels. |     |
| APPENDIX C . . . . .             | 256 |
| Test data.                       |     |
| INDEX . . . . .                  | 279 |

## NOTATION

- $A$  = total area of streams in square feet measured normal to absolute velocity.  
 $a$  = total area of streams in square feet measured normal to relative velocity.  
 $B$  = height of turbine runner in inches.  
 $c$  = coefficient of discharge in general.  
    =  $V_1/\sqrt{2gh}$ .  
 $c_c$  = coefficient of contraction.  
 $c_v$  = coefficient of velocity.  
 $c_r$  = coefficient of radial velocity.  
 $c_u$  = coefficient of tangential velocity.  
 $D$  = diameter of turbine runner in inches.  
 $e$  = efficiency.  
 $e_h$  = hydraulic efficiency.  
 $e_m$  = mechanical efficiency.  
 $e_v$  = volumetric efficiency.  
 $F$  = force in pounds.  
 $f$  = friction factor.  
 $g$  = acceleration of gravity in feet per second per second.  
 $H$  = total effective head =  $z + V^2/2g + p/w$ .  
 $H'$  = any loss in head in feet.  
 $h$  = head in feet.  
 $h'$  = head lost in friction in turbine or pump.  
 $h''$  = head converted into mechanical work or vice versa.  
 $K$  = any factor.  
 $K_1$  = capacity factor.  
 $K_2$  = power factor.  
 $k$  = any coefficient of loss.  
 $N$  = revolutions per minute.  
 $N_e$  = speed for maximum efficiency.  
 $N_s$  = specific speed =  $N_e\sqrt{\text{B.h.p.}}/h^{5/4}$ .  
 $m$  = abstract number.  
 $n$  = abstract number.  
 $O$  = axis of rotation.  
 $P$  = power.  
 $p$  = intensity of pressure in pounds per square foot.  
 $Q$  = total quantity in cubic feet.  
 $q$  = rate of discharge in cubic feet per second.  
 $R$  = resultant force.  
 $r$  = radius in feet.  
 $T$  = torque in foot-pounds.  
 $t$  = time in seconds.

$u$  = linear velocity of a point on wheel in feet per second.

$V$  = absolute velocity (or relative to earth) of water in feet per second.

$V_r$  = radial component of velocity =  $V \sin \alpha$ .

$V_u$  = tangential component of absolute velocity =  $V \cos \alpha$ .

$v$  = velocity of water relative to wheel in feet per second.

$W$  = pounds of water per second =  $wq$ .

$w$  = density of water in pounds per cubic foot.

$x = r_2/r_1$ .

$y = A_1/a_2$ .

$\alpha$  = angle between  $V$  and  $u$  (measured between positive directions).

$\beta$  = angle between  $v$  and  $u$  (measured between positive directions).

$\phi$  = ratio  $u_1/\sqrt{2gh}$ .

$\phi_s$  = value of  $\phi$  for maximum efficiency.

$\omega$  = angular velocity =  $u/r$ .

The subscript (1) refers to the point of entrance and the subscript (2) refers to the point of outflow in every case.

# HYDRAULIC TURBINES

## CHAPTER I

### INTRODUCTION

1. **Historical.**—Water power was utilized many centuries ago in China, Egypt, and Assyria. The earliest type of water wheel was a crude form of the current wheel, the vanes of which dipped down into the stream and were acted upon by the impact of the current (Fig. 1). A large wheel of this type was used to pump the water supply of London about 1581. Such a wheel could utilize but a small per cent. of the available energy of the stream. The current wheel, while very inefficient and limited in its scope, is well suited for certain purposes and is not yet obsolete. It is still in use in parts of the United States,

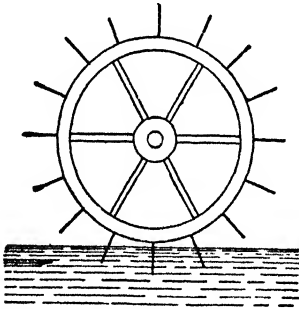

FIG. 1.—Current wheel.

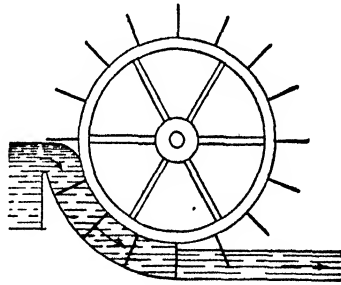

FIG. 2.—Breast wheel.

in China, and elsewhere for pumping small quantities of water for irrigation.

The undershot water wheel was produced from the current wheel by confining the channel so that the water could not escape under or around the ends of the vanes. This form of wheel was capable of an efficiency of 30 per cent. and was in wide use up to about 1800.

The breast wheel (Fig. 2) utilized the weight of the water rather than its velocity with an efficiency as high as 65 per cent. It was used up to about 1850.

The overshot water wheel (Fig. 3) also utilized the weight of the water. When properly constructed it is capable of an efficiency of between 70 and 90 per cent. which is as good as the modern turbine. The overshot water wheel was extensively used up to 1850 when it began to be replaced by the turbine, but it is still used as it is well fitted for some conditions.

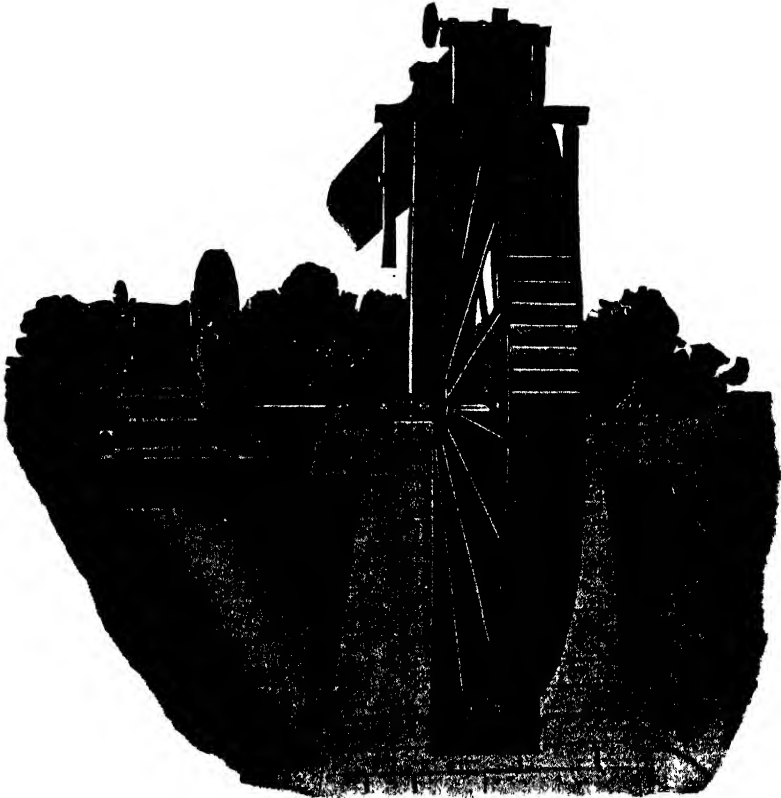

Fig. 3.—I. X. L. steel overshot water wheel. (Made by Fitz Water Wheel Co.)

**2. The Turbine.**—The turbine will be more completely described in a later chapter but in brief it operates as follows: A set of stationary guide vanes direct the water flowing into the rotating wheel and, as the water flows through the runner, its velocity is changed both in direction and in magnitude. Since a force must be exerted upon the water to change its velocity in any way, it follows that an equal and opposite force must be exerted by the water upon the vanes of the wheel. A turbine may be defined as a water wheel in which a motion of the water relative to its buckets is essential to its action.

The term "water wheel" has several shades of meaning in American usage. First it may be employed in its most general sense to indicate any rotary prime mover operated by water. It may thus be applied to the turbine, since the latter is a special type of water wheel, according to the definition in the preceding paragraph. Second it may be used to designate the types of machines described in Art. 1 in order to distinguish them from

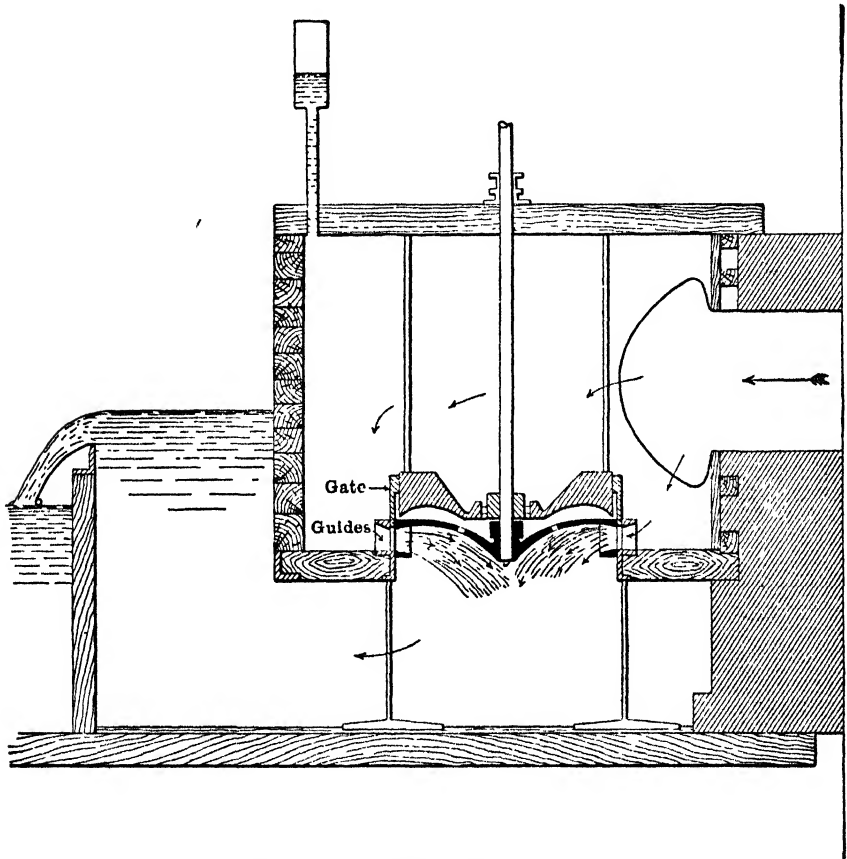

FIG. 4.—Francis turbine in flume.

the modern turbine. Third it may be understood to indicate impulse turbines of the Pelton type as contrasted with turbines of the reaction type. In this book the term is used in the first or second sense only, the context making it clear which is meant in any case.

The original inward flow turbine of James B. Francis (1849) is shown in Figs. 4 and 5. In Fig. 6 are shown two views of an



inward flow runner of this general type which was constructed about 1900. This style is now obsolete.

**3. Advantage of Turbine over Water Wheel.**—The water wheel has been supplanted by the turbine because:

1. The latter occupies smaller space.
2. A higher speed may be obtained.
3. A wider range of speeds is possible.

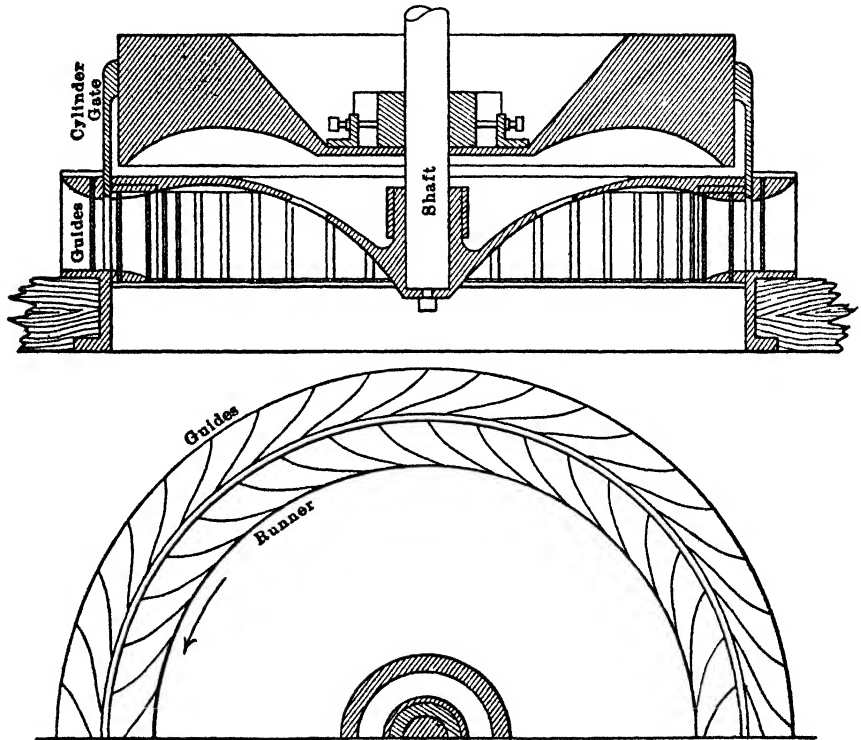

FIG. 5.—Francis turbine.

4. It can be used under a wide range of head, whereas the head for an overshot wheel should be only a little more than the diameter of the wheel.

5. A greater capacity may be obtained without excessive size.

6. It can work submerged.

7. There is less trouble with ice.

8. It is usually cheaper.

**4. Advantages of Water Wheel over Turbine.**—For small plants the turbine is often poorly designed, cheaply made,

unwisely selected, and improperly set. It may thus be very inefficient and unsatisfactory. In such cases the overshot water wheel may be better. The latter has a very high efficiency when the water supply is much less than its normal value. It is adapted for heads which range from 10 to 40 ft. and for quantities of water from 2 to 30 cu. ft. per second.<sup>1</sup>

An overshot wheel on the Isle of Man is 72 ft. in diameter and develops 150 h.p. Another at Troy, N. Y., was 62 ft. in

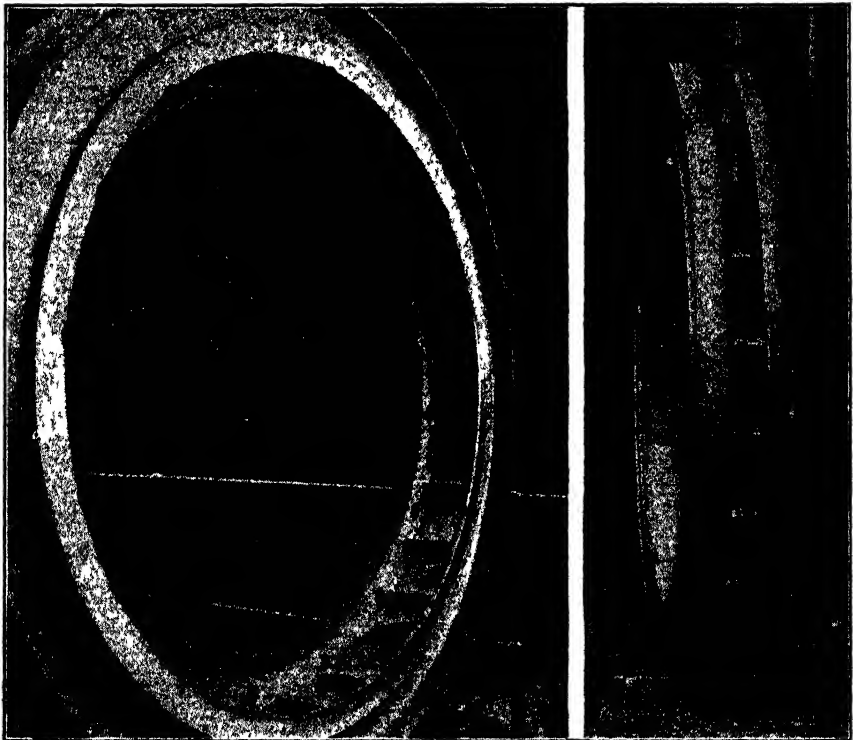

Fig. 6.—Pure radial inward flow runner of the original Francis type.

diameter, 22 ft. wide, weighed 230 tons, and developed 550 h.p. The latter is now in a state of ruin.

**5. Essentials of a Water-power Plant.**—A water-power plant requires some or all of the following:

1. *A Storage Reservoir.*—This may hold enough water to run the plant for several months or more. In many cases it may be totally lacking.

<sup>1</sup> See "Test of Steel Overshot Water Wheel," by C. R. Weidner, *Eng. News*, Jan. 2, 1913, Vol. LXIX, No. 1. A later test of this I.X.L. wheel after ball bearings were substituted gave an efficiency of 92 per cent.

2. *A Dam.*—This may create most of the head available or it may merely create a small portion of it and be erected primarily to provide a storage reservoir or mill pond or to furnish a suitable intake for the water conduit. In some cases the dam may be no more than a diversion wall to deflect a portion of the current into the intake.

3. *Intake Equipment.*—This usually consists of racks or screens to keep trash from being carried down to the wheels and of head gates so that the water may be shut off, if need be.

4. *The Conduit.*—The water may be conducted by means of an open channel called a canal or flume, or through a tunnel, or by means of a closed pipe under pressure, which is called a penstock if it leads direct to the turbines.

5. *The Forebay.*—A small equalizing reservoir is often placed at the end of the conduit from the main intake and the water is then led from this to the turbines through the penstock. This is called the forebay and is also referred to as the headwater. In the case of a plant without any storage reservoir the body of water at the intake is often termed the forebay.

6. *The Turbine.*—The turbine with its case or pit and draft tube, if any, comprise the setting.

7. *The Tail Race.*—The body of water into which the turbine discharges is called the tail water. The channel conducting the water away is the tail race.

## 6. QUESTIONS

1. What is a turbine? What is a water wheel?
2. Under what circumstances would a current wheel be used? Could a turbine be used under the same conditions? What is the advantage of the undershot wheel over the current wheel?
3. Under what circumstances would an overshot water wheel be used? Could a turbine be used under the same conditions? Could an overshot wheel replace any turbine?
4. What elements would be found in every water-power plant? What elements may be in some and lacking in others? What is the difference between a storage reservoir and a forebay?

## CHAPTER II

### TYPES OF TURBINES AND SETTINGS

**7. Classification of Turbines.**—Turbines are classified according to:

1. Action of Water
  - (a) Impulse (or pressureless).
  - (b) Reaction (or pressure).
2. Direction of Flow
  - (a) Radial outward
  - (b) Radial inward
  - (c) Axial (or parallel)
  - (d) Mixed (radial inward and axial).
3. Position of Shaft
  - (a) Vertical.
  - (b) Horizontal.

**8. Action of Water.**—In the impulse turbine the wheel passages are never completely filled with water. Throughout the flow the water is under atmospheric pressure. The energy of the water leaving the stationary guides and entering the runner is all kinetic. During flow through the wheel the absolute velocity of the water is reduced as the water gives up its kinetic energy to the wheel. In Europe a type of impulse turbine commonly used is called the Girard turbine. In the United States practically the only impulse turbine is the tangential water wheel or impulse wheel, more commonly known as the Pelton wheel. (See Fig. 7.)

In the reaction turbine the wheel passages are completely filled with water under a pressure which varies throughout the flow. The energy of the water leaving the stationary guide vanes and entering the runner is partly pressure energy and partly kinetic energy.<sup>1</sup> During flow through the wheel both the pressure and the absolute velocity of the water are reduced as the water gives up its energy to the wheel.

<sup>1</sup>Strictly speaking, the water possesses only kinetic energy but transmits pressure energy.

Impulse and reaction turbines were so called because in primitive types the force on the former was due to the "impulse" of water striking it while the force on the latter was the "reaction" of the streams leaving it. But these terms are not very appropriate for the forces in question, since in either case the dynamic force is due to a change produced in the velocity of the water and the distinction is largely artificial. And in modern turbines the so-called "impulse" at entrance and "reaction" at outflow may be effective in either type.

A far better classification is as pressureless and pressure turbines. Another classification is as partial and complete admission turbines, as in the former type the water is admitted

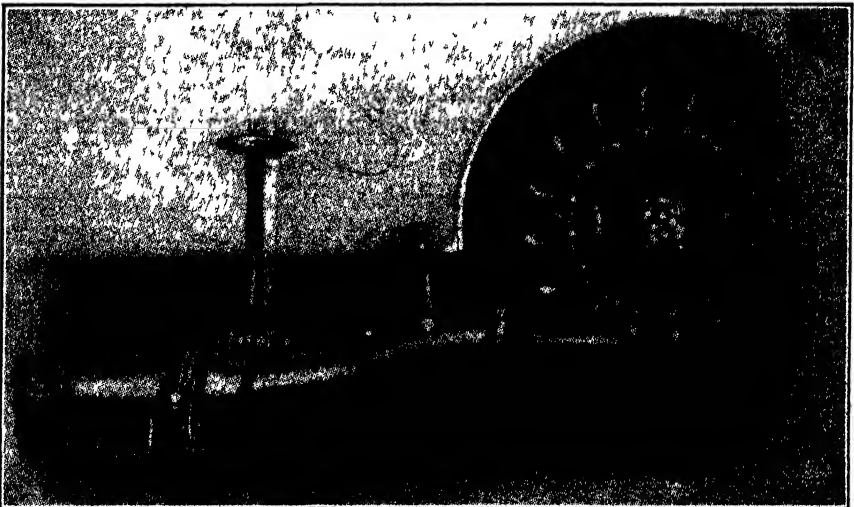

FIG. 7.—Tangential water wheel with deflecting nozzle.

at only a portion of the circumference while in the latter type it is necessarily admitted around the entire circumference.

**9. Direction of Flow.**—Radial flow means that the path of a particle of water as it flows through the runner lies in a plane which is perpendicular to the axis of rotation. If the water enters at the inner circumference of the runner and discharges at the outer circumference we have an outward flow type known as the Fourneyron turbine. (See Fig. 78.)

If the water enters at the outer circumference of the runner and discharges at the inner circumference we have an inward flow type as in the original Francis turbine shown in Figs. 4 and 5.

If a particle of water remains at a constant distance from the axis of rotation as it flows through the runner we have what is known as axial or parallel flow. The type of turbine falling in this class is commonly called the Jonval turbine and is used to some extent in Europe.

If the water enters a wheel radially inward and then during its flow through the runner turns and discharges axially we have a mixed flow turbine. This is known as the American type of turbine and is also called a Francis turbine, though it is not identical with the one built by Francis.

Modern reaction turbines are practically all inward flow turbines of the mixed flow type and to this type our discussion will be confined.

**10. Position of Shaft.**—The distinction as to position of shaft is obvious. The vertical shaft turbines are, however, further classified as right-hand or left-hand turbines according to the direction of rotation. If, in looking down upon the wheel from above, the rotation appears clockwise it is called a right-hand turbine. The reverse of this is a left-hand turbine.

So far as efficiency of the runner alone is concerned there is little difference between vertical and horizontal turbines. Other things being equal, the hydraulic losses should be identical in either case, but there might be some difference in the friction of the bearings. As the latter is only a relatively small item, a reasonable variation in its value would have but slight effect on the efficiency.

But when we consider the runner and draft tube together, we may find a difference, since the draft tubes are not necessarily equally efficient in the two cases. The single-runner, vertical-shaft turbine, as shown in Fig. 9, is readily seen to lend itself to a more efficient draft tube construction than the horizontal-shaft unit, as shown in Fig. 11, with the necessary sharp quarter turn near the runner where the velocity of the water is still high. If the velocity of discharge from the runner is low, the difference in the two cases may be insignificant, but, where the velocity of the water is relatively high, the draft tube for the vertical-shaft wheel may be decidedly better.

In general a horizontal shaft is more desirable from the standpoint of the station operator on account of greater accessibility and less bearing trouble, but the latter is of less significance in recent years due to the greater perfection that has been ob-

tained in the construction of suspension bearings for such service. A vertical-shaft turbine occupies much less floor space, but often requires more excavation and a higher building.

The vertical shaft turbine is used where it is necessary to set the turbine down by the water while the generator or other machinery that it drives must be above. Since such conditions are usually met with in low-head plants, it will be found that ordinarily the vertical setting is used only for low heads. (See Fig. 8.)

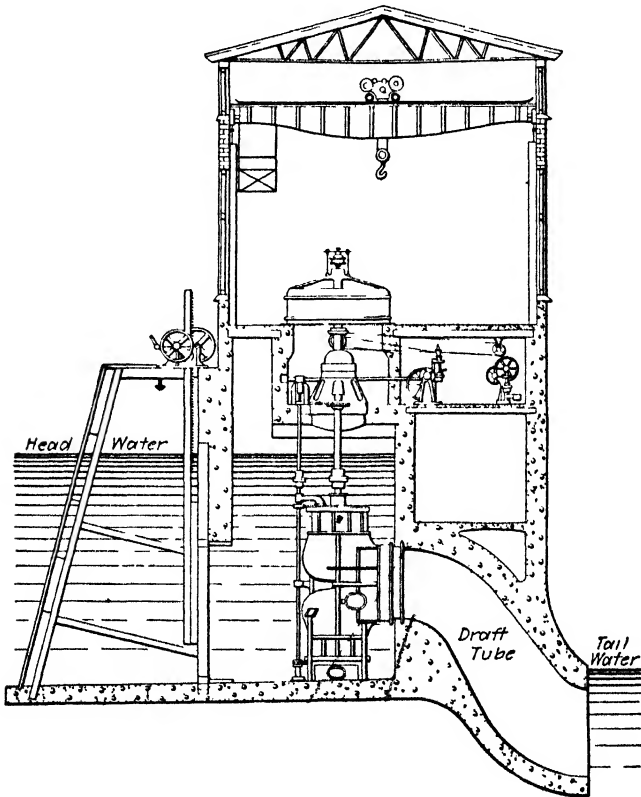

FIG. 8.—Pair of vertical shaft turbines in open flume.

The horizontal shaft turbine is used where the turbine can be set above the tail water level and if the generator or other machinery that it drives can be set at the same elevation. This is almost always the case with a high-head plant and is also quite frequently the case with a low-head plant. (See Fig. 10.)

These statements are purely general and there are many exceptions.

11. Arrangement of Runners.—A turbine may be mounted up as an independent unit with its own bearings, usually two in number, and connected to whatever it drives by means of a

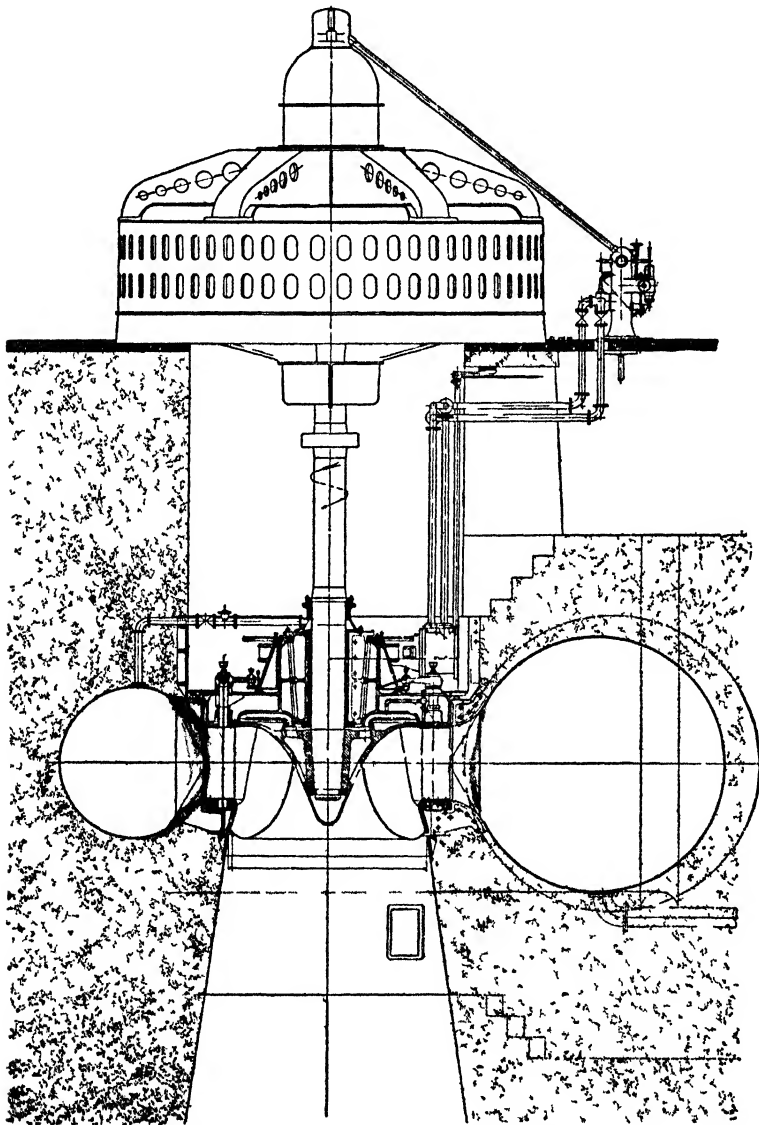

FIG. 9.—Vertical shaft turbine with spiral case.

coupling, belt, or other device. But some horizontal-shaft hydro-electric machines are set up as three-bearing units, so that neither the turbine nor the generator are independent of each



other. Recent practice is to reduce this to two bearings, as it is more compact and the problem of alignment is simplified. The generator is mounted between the two bearings and the turbine runner, which is relatively light, is overhung on the end of the generator shaft. Sometimes there are two runners for one generator and in this case one may be overhung on either end. The former is called the single-overhung and the latter the double-overhung construction.

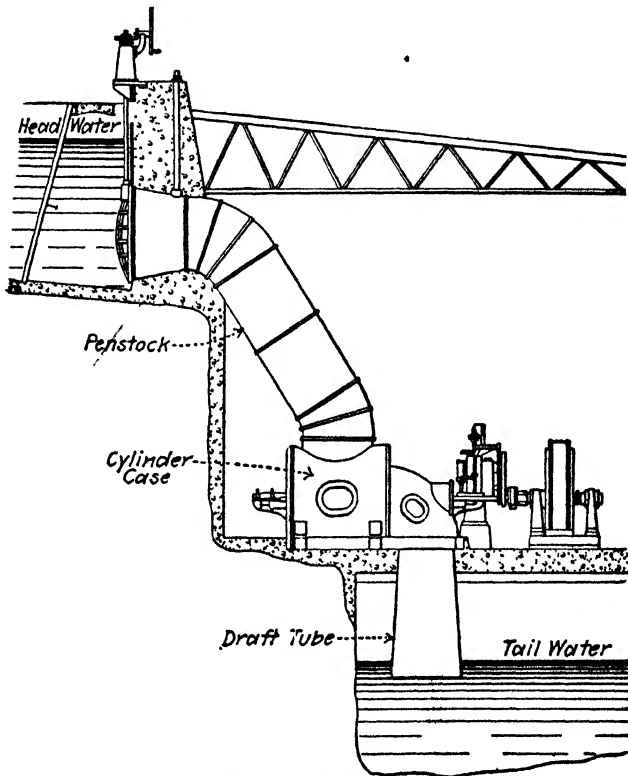

FIG. 10.—Horizontal shaft turbine in case.

The double-overhung type is found only with horizontal-shaft units and naturally requires two separate cases and two draft tubes. On the other hand with either a horizontal or vertical shaft we may have two runners discharge into a common draft chest and tube as in Fig. 8. If open flume construction is not employed this likewise requires two separate cases. We may also have only one case and two separate draft tubes for a single runner with a double discharge, as in Fig. 51, page 53.

Multiple runner units are used to some extent but present practice favors single runners of larger size for vertical shaft installations, as in Fig. 9. For horizontal shafts also four or more runners have been employed but the preference is for one runner of either the single or double discharge type or two runners with separate draft tubes.

**12. The Draft Tube.**—Occasionally reaction turbines have been set so as to discharge above the tail water; in such cases the

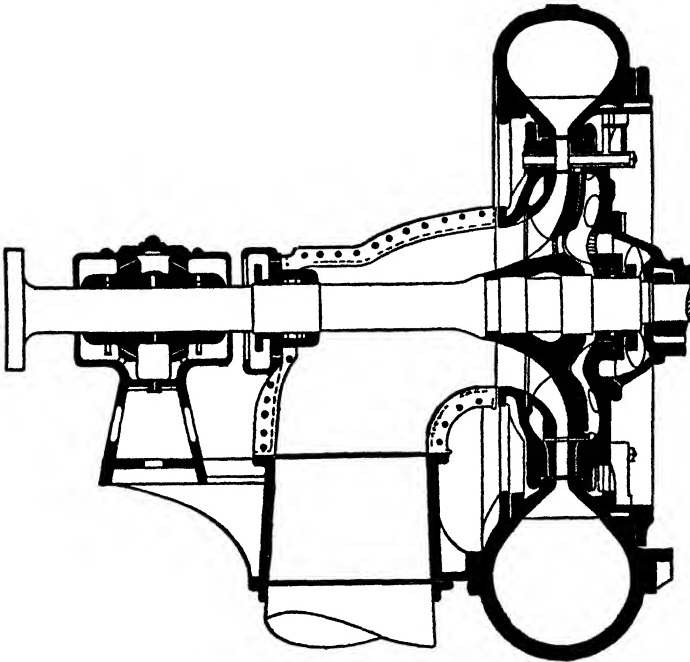

FIG. 11.—Horizontal shaft turbine showing draft elbow.

fall from the point of discharge to the water was lost. To avoid this loss turbines have been submerged below the tail water level as in Fig. 4, page 3. By the use of a draft tube (or suction tube), as in Fig. 8 and Fig. 10, it is possible to set the turbine above the tail water without suffering any loss of head. This is due to the fact that the pressure at the upper end of the draft tube is less than the atmospheric pressure. This suction compensates for the loss of pressure at the point of entrance to the turbine guides.

As will be shown later, when the theory is presented, the use of a draft tube that diverges or flares may result in a small increase in efficiency. The chief advantage of the draft tube, however, is

that it allows the turbine to be set above the tail water where it is more accessible and yet does not cause any sacrifice in head. It is this that permits a horizontal shaft turbine to be installed without any loss of head.

Since the wheel passages of an impulse turbine must be open to the air it is readily seen that the use of a draft tube in the usual sense of the word is not possible. However, as will be seen later, the impulse turbine is better suited for comparatively high heads so that the loss from the wheel to the tail water is a relatively unimportant item.

**13. Flumes and Penstocks.**—If the turbine be used under a head of about 30 ft. or less a flume may conduct the water to an open pit as in Fig. 4 and Fig. 8. If the head is much greater than this it becomes uneconomical and a penstock is used as in Fig. 10. The turbine must then be enclosed in a water-tight case. Various forms of cases will be described in Chapter V.

For penstocks where the pressure head is less than about 230 ft. (100 lb. per square inch) wood-stave pipe is frequently used. It is cheaper than metal pipe for similar service.

Cast-iron pipe is used for heads up to about 400 ft. It is not good in large diameters nor for high pressures on account of porosity, defects in casting, and low tensile strength. Its advantages are durability and the possibility of readily obtaining odd shapes if such are desired.

For high heads, steel pipe, either riveted or welded, is used. It is cheaper than cast iron in large sizes but it corrodes more rapidly.

#### 14. QUESTIONS

1. In what ways may turbines be classified? How many of these are found in current practice? Explain the features of each.

2. What are the differences between impulse and reaction turbines? What types of each are now used? Explain the various directions of flow that may be used.

3. What are the relative merits of horizontal and vertical shaft turbines? When would each ordinarily be used?

4. What arrangements of runners may we have for vertical shaft units? For horizontal shaft units? What is meant by single- and double-overhung construction?

5. What two functions does the draft tube fulfill? How does it prevent loss of head?

## CHAPTER III

### WATER POWER

**15. Investigation.**—Before a water-power plant is erected a careful study should be made of the stream to determine the horse-power that may be safely developed. It is important to know not only the average flow but also both extremes. The extreme low-water stage and its duration will determine the amount of storage or auxiliary power that may be necessary. The extreme high-water stage will fix the spillway capacities of dams, determine necessary elevations of machines, and other facts essential to the safety and continuous operation of the plant.

**16. Rating Curve.**—The first step in such an investigation is the establishment of a rating curve. (See Fig. 12.) To determine

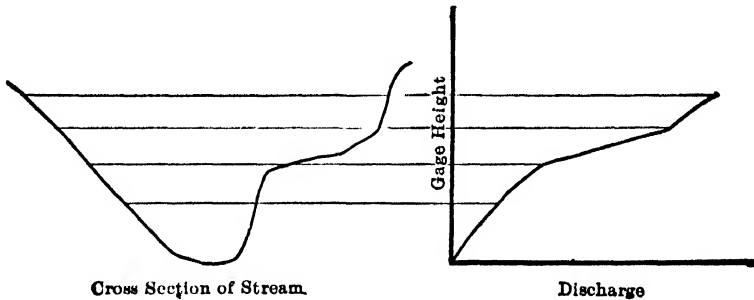

FIG. 12.—Rating curve.

the discharge of the stream a weir, current meter, floats, or other means may be employed according to circumstances.<sup>1</sup>

By measuring the flow of the stream for different stages a rating curve is readily drawn. This will not be a smooth curve if there are abrupt changes in the area of the section. A given gage height may really represent a range of flows depending upon whether the river is rising or falling, the flow being greater if the stream is rising and less if it is falling. This is because the hydraulic gradient is different in the two cases.<sup>2</sup> If possible,

<sup>1</sup> Hoyt and Grover, "River Discharge."

Water Supply Papers No. 94 and No. 95 of the U. S. G. S.

<sup>2</sup> Mead, "Water-power Engineering," p. 201.

the points for the rating curve should be taken when the river is neither rising nor falling. The discharges from the rating curve for gage readings taken under all conditions will be more or less in error, but in the end such errors will usually balance each other and be unimportant.

If the bed of the stream changes, as it frequently does in sandy or alluvial soil, the rating curve will also change and must be determined anew from time to time. Sometimes a special permanent control station may be constructed to avoid this.

**17. The Hydrograph.**—When gage readings are taken regularly and frequently for any length of time and the corresponding

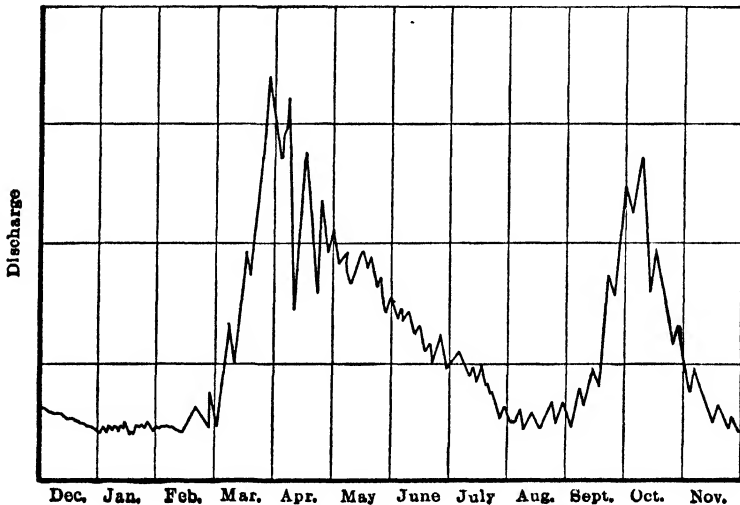

FIG. 13.—Hydrograph.

discharges secured from the rating curve a history of the flow may be plotted as in Fig. 13. Such a curve is called a hydrograph. This curve is extremely useful in the study of a water-power proposition. To be satisfactory it should cover a period of several years since the flow will vary from year to year. Since it is very important to know the extremes also, it should cover both a very dry year and a very wet one as well as the more normal periods.

**18. Rainfall and Run-off.**—Rainfall records are usually available for many years back and are a valuable aid in extending the scope of the hydrograph taken, provided a relation between rainfall and run-off can be estimated. If the ground be frozen, or the slopes steep and stony, or the ground saturated and the

rain violent nearly all the water that falls upon the drainage basin may appear in the stream as run-off. On the other hand, if the soil be dry and the land such that opportunity is given it, all the rain may be absorbed and none of it appear in the stream. Usually the conditions are such that the relation is between these two extremes. In a general way it may be said to lie between the two curves shown in Fig. 14.<sup>1</sup>

The relation between rainfall and run-off is very complicated and only partially understood at present. For more information consult Water Supply Papers of the U. S. G. S. and other sources.

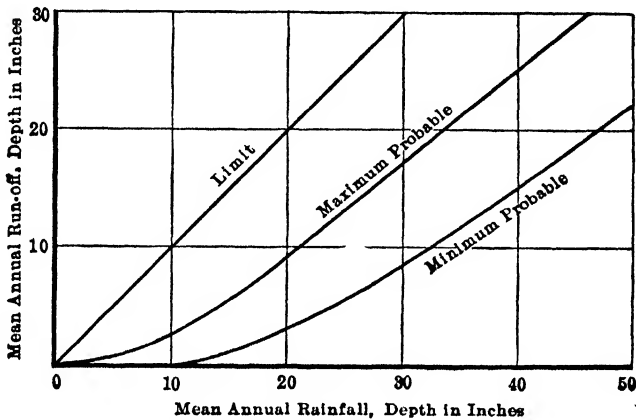

FIG. 14.—Relation of rainfall to run-off.

**19. Absence of Satisfactory Hydrograph.**—If no hydrograph of the stream is available and there is no time to secure one, a study of the stream may be made by comparison with the hydrographs of adjacent streams. It is well, however, to take a hydrograph for a year, if possible, in order to be able to check the comparison.

If no hydrographs of adjacent streams are available, it is necessary to use the rainfall records and make a thorough study of the physical conditions of the water shed. If the relation between rainfall and run-off can be estimated, then fairly satisfactory conclusions may be drawn, provided a hydrograph for one year can be used to work from. Where there is not time to take a year's record it is well to be very conservative and provide for future extension of power if it is later found to be warranted.

**20. Variation of Head.**—Since the discharge of any stream is usually a widely varying quantity, it follows that the water

<sup>1</sup> F. H. Newell, Proc. Eng. Club of Phila., Vol. XII, 1895.

level at any point must vary. If the turbine be of the reaction type set in the usual way, the total head acting upon the wheel will be the fall from the surface of the head water to the surface of the tail water with the pipe line loss deducted. If, in times of high water, the head water level rose the same amount as the tail water level the net head under which the turbine operated would remain constant. But, under the usual conditions, the tail water level rises more than the head water level and the net head under which the turbine operates becomes less. This is illustrated in Fig. 15 where three rates of flow are shown.

At high water the horse-power of the stream may be large even though the fall be reduced, owing to the increased quantity of

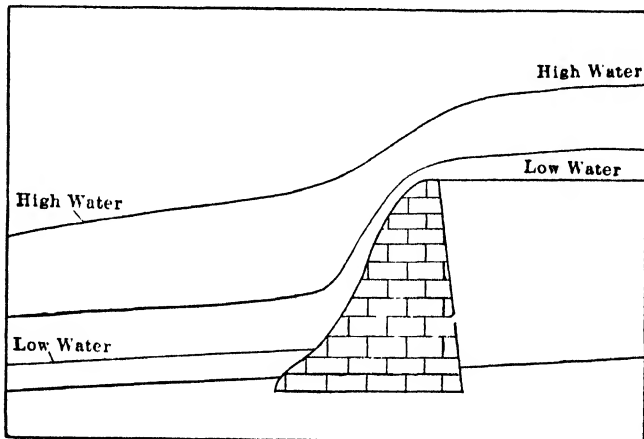

FIG. 15.—Decrease of available head at high water.

water. But the horse-power of the turbine may be seriously diminished. A turbine is only a special form of orifice and therefore the discharge through it is proportional to the square root of the head. If then the discharge through it be reduced due to the lower head, the horse-power input to the turbine is decreased. If the best efficiency is to be obtained, the speed also should vary as the square root of the head. But usually the turbine is compelled to run at constant speed and this causes a further reduction of the power of the turbine since the efficiency is lowered. (The speed should be the best for low water because economy of water is then important.) It is thus seen that the decrease of the head at high water causes a loss of power and a drop in efficiency. This change of head will be an insignificant item for a high-head plant but may be very serious for a low-head plant.

**21. Power of Stream.**—If the conditions are such that there is no appreciable change in head, the hydrograph with a suitable scale may represent the power of the stream also. But if the head varies to any extent with the flow then the power curve must be computed from the hydrograph by using the heads that would be

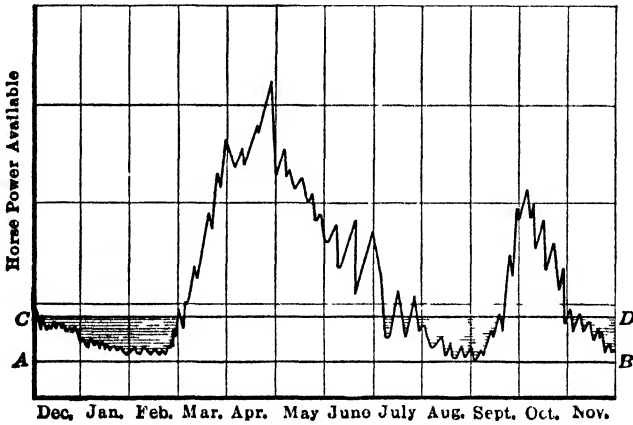

FIG. 16.—Power curve of a stream.

obtained at various stages of flow. Or the hydrograph itself may still be used as a power curve if the power scale that is used is made to vary as the head varies instead of being uniform.

If Fig. 16 represents the power curve of a stream then *A-B* represents the greatest power that the stream can be counted upon to furnish at all times.

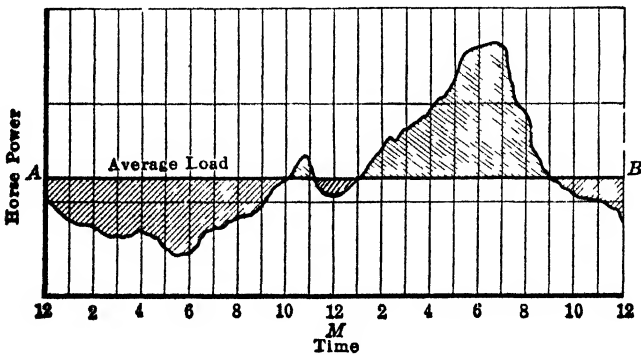

FIG. 17.

**22. Pondage and Load Curve.**—By pondage is meant the storing of a limited amount of water. If the plant be operated 24 hours on a steady load then pondage is of little value except for equalizing the flow of water when the stream is low. But if the



plant be operated for only a portion of the 24 hours or if the load be variable as shown by the load curve in Fig. 17, then the water that is not used when the load is light may be stored and used when the load is heavy. If the pondage be ample, the average load carried by the plant may then be equal to  $A-B$  in Fig. 16, while the peak load may be much greater.

**23. Storage.**—By storage is meant the storing of a considerable quantity of water, so that it varies from pondage in degree only. Pondage indicates merely sufficient capacity to supply water for a few hours or perhaps a few days, but storage implies a capacity which can supply water needed during a dry spell of several weeks or months or more. The effect of storage is to enable the minimum power of the stream to be raised from  $A-B$  to  $C-D$  (Fig. 16). The greater the storage capacity the higher  $C-D$  is placed until it equals the average power of the stream. The water for the turbines may be drawn direct from the storage reservoir (in which case the head varies) or the reservoir may be used as a stream feeder only.

A plant operating under a low head requires a relatively large amount of water for a given amount of power. A storage basin for such a plant would require a very large capacity if it were to furnish power for any length of time. But a low head is usually found in a fairly flat country where it is possible to construct a storage reservoir of limited capacity only, and often none at all, on account of flooding the surrounding country. But for a high head the conditions are different as only a relatively small amount of water is required so that the capacity of the storage reservoir need not be excessive. The higher the head, the more valuable a cubic foot of water becomes. The topography of a country where a high head can be developed is usually such that storage reservoirs of large capacity can be constructed at reasonable cost. A low-head plant usually possesses pondage only—a high-head plant usually possesses storage.

**24. Storage and Turbine Selection.**—If a plant possesses neither storage nor pondage, or the stream flow may not be interrupted because of other water rights, the economy of water when the turbine is running under part load is of no importance. The efficiency at full load is all that is of interest. But if the plant does have pondage or storage in any degree the economy of water under all loads is of importance. The more extensive the pondage the more valuable a high efficiency on all loads becomes.

Thus the question of storage has an important bearing in turbine selection.

**25. Power Transmitted through Pipe Line.**—Suppose that a nozzle, whose area can be varied, is placed at the end of a pipe line  $B-C$  (Fig. 18). With the nozzle closed we have a pressure head at  $C$  of  $CX$  which is equal to the static head. The hydraulic

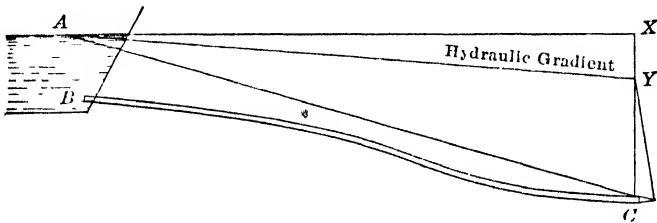

FIG. 18.—Varying rates of flow in pipe line.

gradient is then a horizontal line. If the nozzle be partially opened, so that flow takes place, the losses in the pipe line as well as the velocity head in the pipe cause the pressure to drop to  $CY$ . A further opening of the nozzle would cause the pressure to drop to a lower value. If the nozzle were removed the pres-

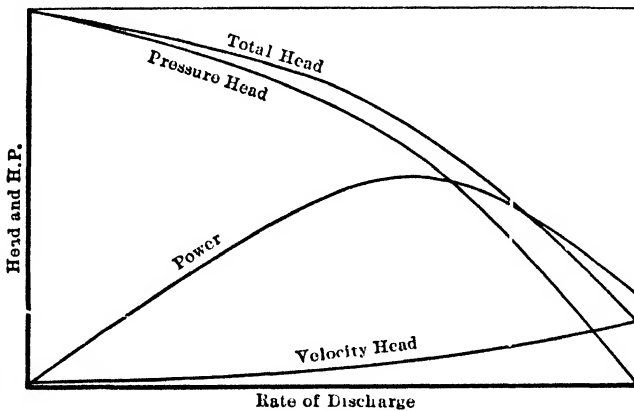

FIG. 19.—Head and power at end of pipe line.

sure at  $C$  is then atmospheric only, which we ordinarily call zero pressure. The hydraulic gradient is then  $A-C$ .

Head is the amount of energy per pound of water. The head at  $C$  is the elevation head, taken as zero, plus the pressure head, plus the velocity head. When the discharge is zero the head is a maximum, being equal to  $CX$ . When the nozzle is removed the discharge is a maximum but the head at  $C$  is a minimum, being

only the velocity head. For any intermediate value of discharge the head will be intermediate between these two extremes.

The power transmitted through the pipe line and delivered at  $C$  is a function of both the quantity of water and the head. It is zero when the discharge is zero and very small when the discharge is a maximum. The power becomes a maximum for a discharge between these two extremes as is shown in Fig. 19. Let the rate of discharge through the pipe be denoted by  $q$ , the net head at  $C$  by  $h$ , the loss of head by  $H'$ , and the height  $CX$  by  $z$ . If the loss of head in the pipe be assumed proportional to the square of the velocity of flow we may write  $H' = Kq^2$ , where  $K$  is a constant whose value depends upon the length, size, and nature of the pipe. Then

$$\text{Power} = qh = q(z - H') = qz - Kq^3$$

$$\text{Differentiating } d(\text{Power})/dq = z - 3Kq^2 = 0$$

$$\text{Or } z = 3Kq^2 = 3H'.$$

Thus the power delivered by a given pipe line is a maximum when the flow of water is such that one-third the head available is used up in pipe friction, leaving the net head only two-thirds of that available.

The efficiency of the pipe line is expressed by  $h/z$ . Thus in the case where the pipe line is delivering its maximum power, its efficiency is only  $66\frac{2}{3}$  per cent. But if economy in the use of water is an object the discharge through the pipe would be kept at a lower value than this so as to prevent so much of the energy of the water being wasted. For a given quantity of water, this means that a larger pipe would be used, so that its efficiency would be higher. In a similar manner, if a given amount of power is required, the smallest pipe that can be used will be of such a size that its efficiency is  $66\frac{2}{3}$  per cent. As the pipe is made larger than this, its efficiency rises and the amount of water required decreases.<sup>1</sup>

The most economical size of pipe may be found as shown in Fig. 20. One curve represents the annual value of the power lost

<sup>1</sup> It should be noted that in this paragraph there are three separate mentioned. First the size of the pipe is fixed and different rates of discharge are assumed to flow through it. Second the quantity of water available is fixed and the size of the pipe is the variable. Third the power delivered is fixed and the size of the pipe is varied.

in pipe friction, the other the annual fixed charge on the pipe. This includes interest on the money expended, depreciation, repairs, etc. The total cost of the pipe per year is the curve whose ordinates are the sums of the other two. The size of pipe for which this sum is a minimum is the most economical.

If the rate of discharge is not constant, careful study must be made of the load curve in order to determine what value of the rate of discharge will give the average power lost. For the typical load curve this value may often be found to be about 80 per cent. of the maximum flow.

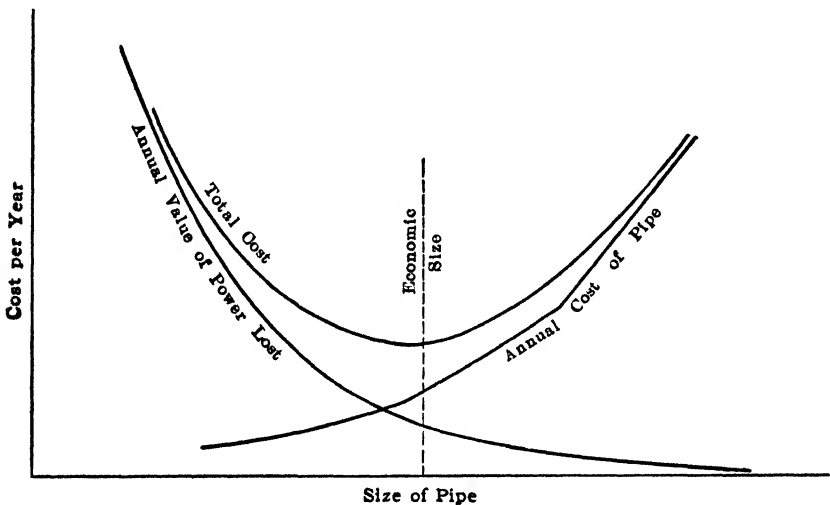

FIG. 20.—Determination of economic size of pipe.

It must be noted that this solution may not always be the most practical because of other considerations. For instance the velocity of the water may be too high and thus give rise to trouble due to water hammer. Again if the loss of head is too large a percentage of the head available, the variation of the net head between full discharge and no discharge may be considerable. This might cause trouble in governing the turbine.

**26. Pipe Line and Speed Regulation.**—A fundamental proposition in mechanics is that

$$\text{input} = \text{output} + \text{losses} + \text{gain in energy.}$$

If the speed of a turbine is to remain constant it follows that the input must always be equal to the power output plus the losses. As the power output varies, therefore, the quantity of water sup-

plied to the turbine must vary. It is thus apparent that a turbine does not run under an absolutely constant head at all loads. By referring to Fig. 19 it is seen that when the turbine is using only a small quantity of water the head will be higher than when it is carrying full load.

If the load on a turbine is rapidly reduced the quantity of water supplied to it must be very quickly decreased in order to keep the speed variation small. This means that the momentum of the entire mass of water in the penstock and draft tube must be suddenly diminished. If the penstock be long a big rise in pressure may be produced so that momentarily the pressure may be greater than the static pressure. This increase in pressure may be sufficient to even cause an increase in the power input for a very brief interval of time. On the other hand, if the load on the turbine be suddenly increased, the water in the penstock and draft tube must be accelerated and this causes a temporary drop in pressure below the normal value, and for the time being the power input to the turbine may be diminished below its former value. The longer the pipe line and the higher the maximum velocity of flow, the worse these effects become. It is thus seen that the speed regulation depends upon the penstock and draft tube as well as upon the governor and the turbine.<sup>1</sup>

If the velocity of the water is checked too suddenly a dangerous water hammer may be produced. In order to avoid an excessive rise in pressure, relief valves are often provided. Automatic relief valves are analogous to safety valves on boilers; they do not open until a certain pressure has been attained. Mechanically operated relief valves are opened by the governor at the same time the turbine gates are closed and afford the water a by-pass so that there is no sudden reduction of flow. To prevent waste of water these by-passes may be slowly closed by some auxiliary device. Another means of equalizing these pressure variations is to place near the turbine a stand pipe or a surge chamber, with compressed air in its upper portion, or open to the atmosphere if it can be made high enough. These have the advantage over the relief valves that they are not only able to prevent the pressure in-

<sup>1</sup> A case may be cited where the length of a conduit was 7.76 miles, the average cross-section 100 sq. ft., and the maximum velocity 10 ft. per second. The amount of water in the conduit was, therefore, 128,125 tons and with the velocity of 10 ft. per second there would be in round numbers 200,000 ft.-tons of kinetic energy.

crease from being excessive but they are able to supply water in case of an increasing demand and thus prevent too big a pressure drop.<sup>1</sup>

## 27. QUESTIONS AND PROBLEMS

1. Before a water power plant is built what information should be obtained regarding the stream? How may this be determined?

2. What is the rating curve of a stream? How is it obtained? What use is made of it? Is it always the same?

3. What is the hydrograph? How is it obtained? What is its use?

4. What use may be made of rainfall records, if a hydrograph of the stream has been obtained by direct measurement? What use may be made of rainfall records, if no hydrograph is in existence?

5. Is the head on a water power plant constant? What causes this? Do the head water levels and the tail water levels change at the same rate? Why? What effect does this have on the power and efficiency of the turbine? What types of plants are most seriously affected?

6. How is the power of a stream to be determined? What effect does pondage have upon this? What is the difference between pondage and storage and how do they differ in their effects upon the extent of the power development?

7. As the flow of water through a given pipe increases, how do the head and power delivered change? How does the efficiency vary? For what condition is the power a maximum? Is this desirable?

8. If a given rate of discharge is to be used for power, how may the proper size of pipe be determined? Are there several factors that need to be considered?

9. If a given amount of power is required and the water supply is ample, how can the smallest size of pipe that would serve be found? What would limit the largest size that might be used?

10. How does the head on a turbine change with the load the wheel carries? What effect does the pipe line have upon speed regulation?

11. What devices are employed to care for the condition when the governor suddenly diminishes the water supply? What may be used to care for a sudden demand?

12. The following table gives the results of a current meter traverse of a stream: Velocity of water in ft. per second equals 2.2 times revolutions per second of the meter plus 0.03.

From this data compute the area, rate of discharge, and mean velocity of the stream. (The mean velocity in a vertical ordinate will be found at about 0.6 the depth. The mean velocity is obtained with a slightly greater degree of accuracy by taking the mean of readings at 0.2 and 0.8 the depth.

<sup>1</sup> See "Control of Surges in Water Conduits," by W. F. Durand, *Journal A. S. M. E.*, June, 1911; "The Differential Surge Tank," by R. D. Johnson, *Trans. A. S. C. E.*, Vol. 78, p. 760, 1915; and "Pressure in Penstocks caused by the Gradual Closure of Turbine Gates," by N. R. Gibson, *Proc. A. S. C. E.*, Vol. 45, Apr., 1919.

| Distance from initial point | Depth of stream | Depth of observation | Time in seconds | Revolutions | Distance from initial point | Depth of stream | Depth of observation | Time in seconds | Revolutions |
|-----------------------------|-----------------|----------------------|-----------------|-------------|-----------------------------|-----------------|----------------------|-----------------|-------------|
| 2                           | 0.0             | ....                 | ..              | ..          | 70                          | 1.4             | 0.28                 | 40              | 20          |
| 5                           | 0.7             | 0.42                 | 60              | 10          |                             |                 | 1.12                 | 43              | 10          |
| 10                          | 1.0             | 0.60                 | 48              | 10          | 75                          | 1.2             | 0.24                 | 57              | 30          |
| 15                          | 1.0             | 0.60                 | 48              | 15          |                             |                 | 0.96                 | 50              | 15          |
| 20                          | 0.9             | 0.54                 | 48              | 20          | 80                          | 1.3             | 0.26                 | 51              | 20          |
| 25                          | 1.5             | 0.30                 | 48              | 20          |                             |                 | 1.04                 | 44              | 10          |
|                             |                 | 1.20                 | 42              | 15          | 85                          | 1.4             | 0.28                 | 52              | 20          |
| 30                          | 1.7             | 0.34                 | 41              | 30          |                             |                 | 1.12                 | 43              | 10          |
|                             |                 | 1.36                 | 48              | 30          | 90                          | 1.2             | 0.24                 | 49              | 20          |
| 35                          | 1.9             | 0.38                 | 45              | 30          |                             |                 | 0.96                 | 53              | 15          |
|                             |                 | 1.52                 | 50              | 20          | 95                          | 1.3             | 0.26                 | 40              | 15          |
| 40                          | 1.8             | 0.36                 | 45              | 30          |                             |                 | 1.04                 | 39              | 10          |
|                             |                 | 1.44                 | 43              | 20          | 100                         | 1.1             | 0.22                 | 45              | 20          |
| 45                          | 1.7             | 0.34                 | 49              | 30          |                             |                 | 0.88                 | 56              | 15          |
|                             |                 | 1.36                 | 45              | 20          | 105                         | 1.0             | 0.20                 | 45              | 20          |
| 50                          | 1.6             | 0.32                 | 42              | 30          |                             |                 | 0.80                 | 55              | 15          |
|                             |                 | 1.28                 | 43              | 20          | 110                         | 1.2             | 0.24                 | 46              | 20          |
| 55                          | 1.5             | 0.30                 | 50              | 30          |                             |                 | 0.96                 | 59              | 10          |
|                             |                 | 1.20                 | 49              | 20          | 115                         | 1.2             | 0.24                 | 41              | 15          |
| 60                          | 1.6             | 0.32                 | 53              | 30          |                             |                 | 0.96                 | 58              | 10          |
|                             |                 | 1.28                 | 52              | 15          | 120                         | 0.8             | 0.48                 | 55              | 5           |
| 65                          | 1.4             | 0.28                 | 55              | 30          | 125                         | 0.9             | 0.54                 | 47              | 5           |
| .....                       | .....           | 1.12                 | 55              | 15          | 130                         | 1.1             | 0.66                 | 42              | 2           |
| .....                       | .....           | .....                | .....           | .....       | 135                         | 1.1             | .....                | .....           | .....       |
| .....                       | .....           | .....                | .....           | .....       | 140                         | 0.0             | .....                | .....           | .....       |

The area between two ordinates may be taken as the product of the distance between them by half the sum of the two depths. The mean velocity in such an area may be taken as half the sum of the mean velocities of the ordinates. The product of area and mean velocity gives the discharge through the area. The sum of all such partial areas and discharges gives the total area and total discharge of the stream. The total discharge divided by the total area gives the mean velocity of the stream.)

Ans. 171.8 sq. ft., 146.8 cu. ft. per second.

13. The traverse of the stream given in problem (12) was made May 14, 1913 when the gage height was 1.21 ft. Other ratings had been made as noted.

| Date                   | Width, ft. | Area, sq. ft. | Mean velocity, ft. per sec. | Gage height, ft. | Discharge, sec.-ft. |
|------------------------|------------|---------------|-----------------------------|------------------|---------------------|
| November 3, 1906.....  | 138        | 485           | .....                       | 3.10             | 1345                |
| May 10, 1908.....      | 138        | 345           | .....                       | 2.32             | 758                 |
| September 4, 1908..... | 60         | 45            | .....                       | 0.57             | 24                  |
| July 24, 1909.....     | 138        | 157           | .....                       | 1.12             | 150                 |
| November 19, 1909..... | 72         | 60            | .....                       | 0.74             | 51                  |
| May 12, 1910.....      | 138        | 226           | .....                       | 1.63             | 364                 |
| October 11, 1911.....  | 138        | 165           | .....                       | 1.32             | 202                 |
| July 30, 1912.....     | 78         | 49            | .....                       | 0.70             | 42                  |
| May 14, 1913.....      | 138        | 172           | .....                       | 1.21             | .....               |

It will be noted that the data is not always consistent, due to changes in the bed of the stream. From the data given draw to scale the probable outline of the cross-section of the stream. Plot values of area, mean velocity, and discharge against gage height. (The area and velocity curves can be extended with greater assurance than the discharge curve. By computing values of discharge from these two, the discharge curve may be produced beyond readings taken.)

14. The daily gage heights of the stream of the preceding problem for 1912 are given below. Plot the hydrograph. Note values of maximum, minimum, and average flow, and the duration of the minimum flow.

| Day | Jan. | Feb.  | Mar. | Apr.  | May  | June  | July | Aug. | Sept. | Oct. | Nov. | Dec. |
|-----|------|-------|------|-------|------|-------|------|------|-------|------|------|------|
| 1   | 1.10 | 1.48  | 6.50 | 2.30  | 2.70 | 1.32  | 0.89 | 0.80 | 1.04  | 1.22 | 1.48 | 1.31 |
| 2   | 1.20 | 1.46  | 5.70 | 2.90  | 2.30 | 1.25  | 0.85 | 0.74 | 1.25  | 1.24 | 1.60 | 1.34 |
| 3   | 1.10 | 1.48  | 4.60 | 3.80  | 2.20 | 2.30  | 0.82 | 0.76 | 1.34  | 1.16 | 1.48 | 2.30 |
| 4   | 1.30 | 1.38  | 2.00 | 2.90  | 2.16 | ..... | 0.90 | 0.79 | 1.14  | 1.12 | 1.42 | 1.90 |
| 5   | 1.05 | 1.35  | 1.80 | 2.60  | 1.90 | 1.55  | 0.86 | 0.74 | 1.06  | 1.14 | 1.31 | 1.70 |
| 6   | 1.10 | 1.32  | 1.55 | 2.40  | 1.85 | 1.50  | 0.84 | 0.71 | 1.01  | 1.09 | 1.28 | 2.10 |
| 7   | 2.20 | 1.30  | 1.15 | 2.35  | 1.95 | 1.80  | 0.80 | 0.71 | 0.92  | 1.01 | 1.31 | 2.10 |
| 8   | 2.55 | 1.52  | 1.04 | 2.90  | 2.15 | 1.55  | 0.76 | 0.71 | 0.02  | 0.95 | 2.00 | 1.60 |
| 9   | 2.30 | 1.58  | 1.90 | 2.45  | 2.40 | 1.38  | 0.74 | 0.74 | 0.95  | 1.14 | 1.70 | 1.70 |
| 10  | 2.50 | 1.58  | 1.95 | 2.25  | 2.20 | 1.29  | 0.72 | 0.79 | 0.91  | 1.05 | 1.55 | 1.65 |
| 11  | 1.85 | 1.44  | 1.70 | 2.15  | 1.95 | 1.24  | 0.74 | 2.35 | 0.92  | 1.09 | 1.50 | 1.55 |
| 12  | 2.00 | 1.48  | 1.70 | 2.10  | 1.80 | 1.21  | 0.74 | 1.50 | 0.90  | 1.10 | 1.41 | 1.49 |
| 13  | 1.85 | 1.52  | 3.60 | 2.05  | 1.80 | 1.21  | 0.72 | 1.05 | 0.90  | 1.11 | 1.42 | 1.35 |
| 14  | 1.85 | 1.60  | 3.10 | 2.00  | 1.70 | 1.15  | 0.88 | 1.20 | 0.85  | 1.08 | 1.50 | 1.48 |
| 15  | 2.00 | 1.50  | 3.20 | 2.05  | 2.00 | 1.12  | 0.88 | 1.00 | 0.85  | 1.01 | 1.46 | 1.35 |
| 16  | 1.80 | 1.52  | 4.50 | ...   | 2.30 | 1.15  | 0.83 | 0.95 | 0.88  | 0.95 | 1.39 | 1.40 |
| 17  | 1.75 | 1.55  | 3.20 | 2.35  | 2.00 | 1.09  | 0.80 | 1.42 | 0.86  | 0.89 | 1.38 | 1.38 |
| 18  | 1.85 | 1.58  | 3.00 | 3.00  | 1.80 | 1.11  | 1.00 | 1.15 | 0.94  | 0.91 | 1.94 | 1.34 |
| 19  | 2.20 | 1.56  | 2.80 | 3.06  | 1.70 | 1.05  | 0.98 | 1.42 | 1.15  | 1.01 | 1.28 | 2.25 |
| 20  | 2.80 | 1.55  | 2.60 | 2.70  | 1.65 | 1.02  | 0.84 | 1.30 | 1.14  | 0.96 | 1.38 | 2.10 |
| 21  | 2.86 | 1.58  | 2.25 | 2.35  | 1.60 | 1.06  | 0.85 | 1.12 | 1.01  | 0.96 | 1.28 | 1.90 |
| 22  | 6.30 | 2.42  | 2.30 | 2.10  | 1.60 | 1.02  | 1.02 | 1.20 | 1.04  | 0.92 | 1.26 | 1.75 |
| 23  | 3.35 | 2.29  | 1.95 | 2.25  | 1.48 | 0.94  | 0.95 | 1.06 | 1.01  | 1.35 | 1.22 | 1.70 |
| 24  | 2.55 | 2.30  | 2.05 | 2.10  | 1.43 | 0.95  | 0.76 | 1.14 | 1.18  | 2.80 | 1.36 | 1.60 |
| 25  | 2.16 | 2.22  | 2.22 | 2.10  | 1.45 | 0.95  | 0.84 | 1.04 | 2.05  | 2.60 | 1.70 | 1.55 |
| 26  | 1.95 | 2.20  | 1.95 | 1.90  | 1.70 | 0.94  | 0.84 | 0.99 | 1.70  | 2.25 | 1.60 | 1.60 |
| 27  | 1.95 | 2.05  | 2.00 | 2.00  | 1.55 | 0.98  | 0.81 | 0.96 | 1.45  | 1.95 | 1.50 | 1.70 |
| 28  | 1.80 | 2.60  | 2.20 | 1.90  | 1.40 | 0.88  | 0.80 | 1.04 | 1.32  | 1.80 | 1.42 | 1.80 |
| 29  | 1.68 | 2.60  | 4.20 | 1.80  | 1.42 | 0.90  | 0.79 | 1.00 | 1.28  | 1.70 | 1.40 | 1.65 |
| 30  | 1.60 | ..... | 3.60 | 3.20  | 1.65 | 0.89  | 0.75 | 0.91 | 1.26  | 1.60 | 1.35 | 1.70 |
| 31  | 1.62 | ..... | 3.00 | ..... | 1.38 | ..... | 0.72 | 0.99 | ..... | 1.50 | .... | 2.50 |

15. The following table gives the rainfall record in a certain vicinity for several years, and also the estimated run-off. The relation of rainfall to run-off is not only different for different drainage basins, but for a given drainage basin it varies according to the time of year and the extent of the rainfall. There is thus no constant relation between the two in the table.<sup>1</sup>

With these records construct a hydrograph for the estimated average

<sup>1</sup> See Kuichling's Rainfall-Run-off Diagrams in the report on the New York State Barge Canal of 1900.



monthly rate of discharge of a stream with a drainage basin of 20 square miles.

|            | 1907                |                    | 1908                |                    | 1909                |                    | 1910                |                    | 1911                |                    | 1912                |                    |
|------------|---------------------|--------------------|---------------------|--------------------|---------------------|--------------------|---------------------|--------------------|---------------------|--------------------|---------------------|--------------------|
|            | Rainfall,<br>inches | Run-off,<br>inches | Rainfall,<br>inches | Run-off,<br>inches | Rainfall,<br>inches | Run-off,<br>inches | Rainfall,<br>inches | Run-off,<br>inches | Rainfall,<br>inches | Run-off,<br>inches | Rainfall,<br>inches | Run-off,<br>inches |
| Jan.....   | 3.05                | 1.9                | 3.21                | 2.0                | 4.14                | 2.2                | 1.15                | 1.0                | 2.85                | 1.8                | 4.91                | 3.5                |
| Feb.....   | 1.95                | 1.8                | 4.61                | 3.5                | 5.17                | 4.0                | 1.84                | 1.7                | 2.11                | 1.8                | 4.04                | 3.0                |
| March....  | 1.91                | 2.6                | 4.04                | 4.0                | 3.74                | 3.6                | 1.48                | 2.3                | 2.98                | 3.2                | 5.16                | 4.7                |
| April..... | 2.19                | 2.2                | 3.78                | 3.1                | 4.91                | 3.6                | 5.96                | 4.0                | 2.82                | 2.6                | 5.71                | 3.9                |
| May.....   | 2.72                | 1.2                | 4.98                | 2.0                | 2.94                | 1.3                | 2.58                | 1.2                | 1.33                | 0.9                | 3.15                | 1.3                |
| June.....  | 2.73                | 0.8                | 1.53                | 0.6                | 3.50                | 0.9                | 3.47                | 0.9                | 7.98                | 2.3                | 1.32                | 0.6                |
| July.....  | 2.74                | 0.4                | 3.44                | 0.4                | 1.86                | 0.3                | 2.00                | 0.3                | 3.03                | 0.4                | 3.14                | 0.4                |
| Aug.....   | 2.55                | 0.4                | 2.66                | 0.4                | 3.66                | 0.5                | 2.80                | 0.4                | 5.70                | 0.9                | 6.30                | 1.0                |
| Sept.....  | 6.88                | 1.7                | 4.04                | 0.8                | 2.73                | 0.5                | 3.38                | 0.6                | 3.57                | 0.7                | 4.49                | 0.9                |
| Oct.....   | 4.69                | 1.7                | 1.40                | 0.5                | 1.28                | 0.4                | 1.20                | 0.4                | 5.33                | 1.2                | 3.56                | 0.8                |
| Nov.....   | 4.70                | 1.6                | 2.51                | 0.8                | 1.75                | 0.6                | 3.15                | 1.0                | 3.06                | 1.0                | 2.32                | 0.8                |
| Dec.....   | 4.88                | 2.5                | 0.00                | 0.5                | 2.93                | 1.4                | 1.93                | 1.1                | 3.20                | 1.6                | 4.02                | 2.0                |

16. The present capacity of the Lake Spaulding reservoir of the Pacific Gas and Electric Co. is 2,000,000,000 cu. ft. (it will eventually be twice this), the present flow is 300 cu. ft. per second, and the net head on the power house is approximately 1300 ft. If the plant runs at full load continuously and there is no stream flow into the lake, how long would this water last? If this same storage capacity were available for a plant of the same power under a head of 40 ft., what rate of discharge would be required and how long would the water last? (It is worth noting that the surface area of Lake Spaulding is 1.3 square miles and the total drop in the water surface would be 56 feet if the sides were vertical. Actually the drop is greater. No such drop in level would be found in connection with a plant under a 40-ft. head. If we assume the drop in level to be 10 ft., for example, the surface area of the storage reservoir would have to be 233 square miles. Also the lowering of the head on the plant in the latter case would make it necessary to use more water and hence shorten the time as computed.)

*Ans.* 77.2 days, 9750 cu. ft. per second, 2.4 days.

17. The difference in elevation between the surface of the water in a storage reservoir and the intake to a turbine was 132.4 ft. During a test the pressure at the latter point was 126.6 ft. and the discharge 44.5 cu. ft. per second, giving a velocity head in a 30 in. intake of 1.3 ft. What was the efficiency of the pipe line? What was the value of the power delivered?

*Ans.* 96.6 per cent., 647 h.p.

18. Assuming the loss of head to be proportional to the square of the rate of discharge, what is the maximum power the pipe in problem (17) could deliver? How many cubic feet of water per second are consumed per horsepower in problems (17) and (18)? *Ans.* 1400 h.p., 0.069, 0.068.

19. The pipe line in problem (17) was 5 ft. in diameter. From the test data the loss of head may be computed as

$$H' = 5.63V^2/d = 18,100/d^5$$

where  $d$  is in feet and the rate of discharge is supposed to be 44.5 cu. ft. per second in every case. Assume this expression to be true for similar pipes of different sizes, the cost of 3, 4, 5, and 6 ft. riveted steel pipes to be \$4.25, \$7.50, \$12.50, and \$18.00 per foot respectively, and the length of pipe to be 2000 ft. If the value of a horsepower per year is \$20, the interest and depreciation rate 7 per cent., and the rate of discharge 44.5 cu. ft. per second, what is the most economical size of pipe? *Ans.* 5 ft.

## CHAPTER IV

### THE TANGENTIAL WATER WHEEL

**28. Development.**—The tangential water wheel is the type of impulse turbine used in this country. Its theory and characteristics are precisely the same as those for the Girard impulse turbine, used abroad, and the two differ only in appearance and mechanical construction. It is used rather than the Girard turbine, because of the advantages offered by its superior type

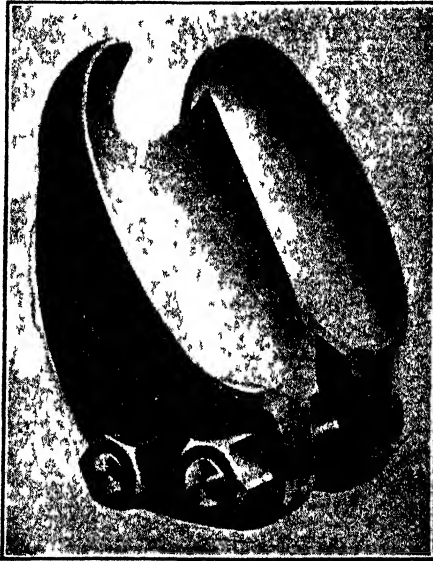

FIG. 21.—Doble ellipsoidal bucket.

of construction. The tangential wheel is also called an impulse wheel or a Pelton wheel in honor of the man who contributed to its early development. The use of the term "Pelton water wheel" does not necessarily imply, therefore, that it is the product of the particular company of that name.

The development of this wheel was begun in the early days in California but the present wheel is a product of the last 20 years. For the purpose of hydraulic mining in 1849 numerous water powers of fairly high head were used, some of the jets being as

much as 2000 h.p. When the gold was exhausted many of these jets were then used for power purposes. The first wheels were very crude affairs, often of wood, with flat plates upon which the water impinged. The ideal maximum efficiency of a wheel with flat vanes is only 50 per cent. The next improvement was the use of hemispherical cups with the jet striking them right in the center. A man by the name of Pelton was running one of these wheels one day when it came loose on its shaft and slipped over so that the water struck it on one edge and was dis-

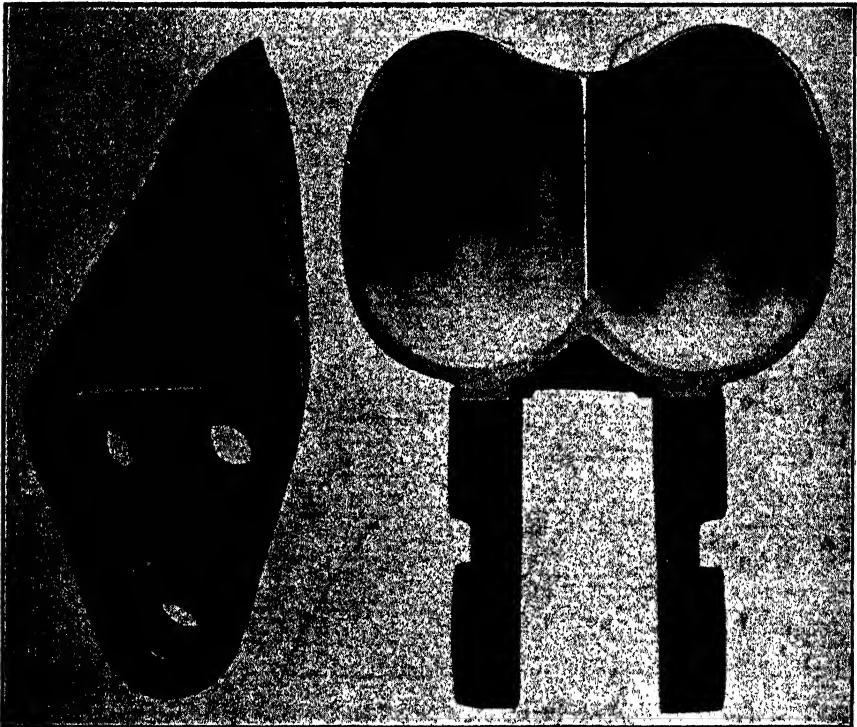

FIG. 22.—Allis-Chalmers bucket. (Courtesy of Allis-Chalmers Mfg. Co.)

charged from the other edge. The wheel was observed to pick up in power and speed and this led to the development of the split bucket.

**29. Buckets.**—The original type of Pelton bucket may be seen in Fig. 76, page 88, the Doble ellipsoidal bucket is shown in Fig. 21, the Allis-Chalmers type in Fig. 22, while the recent Pelton bucket may be seen in Fig. 23. In every case the jet strikes the dividing ridge and is split into two halves. The better buckets are made of bronze or steel, the cheaper ones for

low heads of cast iron. They are all polished inside and the "splitter" ground to a knife edge so as to reduce friction and eddy losses within the bucket. They may weigh as much as 430 lb. apiece and be from 24 to 30 in. in width.

The buckets are bolted onto a rim. The interlocking chain type is shown in Figs. 23 and 24. With this design each bolt serves two buckets in such a fashion that the latter are connected



FIG. 23 —Pelton bucket (Courtesy of Pelton Water Wheel Co.)

as a chain. The advantage gained is one of compactness, it being possible to place the buckets somewhat closer together.

**30. General Proportions.**—It has been found that for the best efficiency the area of the jet should not exceed 0.1 the projected area of the bucket, or the diameter of the jet should not exceed 0.3 the width of the bucket.<sup>1</sup> If this ratio is exceeded the buckets are crowded and the hydraulic friction loss becomes excessive. It is evident also that there must be some relation between size of jet and the size of the wheel. For a given size jet there is no

<sup>1</sup> W. R. Eckart, Jr., Proc. of Inst. of Mech. Eng. (London), Jan. 7, 1910.

upper limit as to size of wheel so far as the hydraulics is concerned. In special cases, where a low r.p.m. was desired, diameters as large as 35 ft. have been used when the diameter of the jet was only a few inches. But there is a lower limit for the ratio of wheel diameter to jet diameter. Obviously, for instance, the wheel could not be as small as the jet. The considerations which influence this matter will be further considered in Chapter VII, but for the present it will be sufficient to state that a ratio as low as 9 may be used without an excessive loss of efficiency.<sup>1</sup> (The nominal diameter is that of a circle tangent to the center

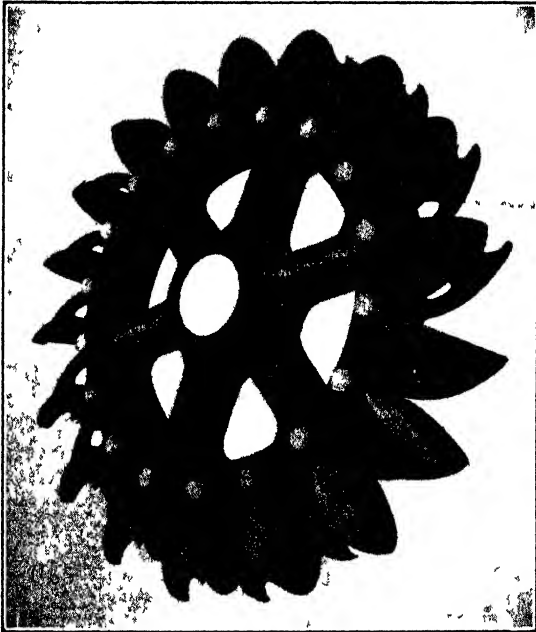

FIG. 24.—Pelton tangential water wheel runner showing interlocking chain-type construction. (Made by Pelton Water Wheel Co.)

line of the jet.) The more common value, and one which involves no sacrifice of efficiency, is 12. From that we get a very convenient rule that the diameter of the wheel in feet equals the diameter of the jet in inches. The size of jet necessary to develop a given amount of power under any head may be computed and then the diameter of wheel necessary is known at once.

The r.p.m. of the wheel can be computed by taking the peripheral speed as 0.47 of the jet velocity or  $0.45 \sqrt{2gh}$ .

<sup>1</sup>S. J. Zowski, "Water Turbines," published by Engineering Society, Univ. of Mich., 1910.

The use of one jet only upon a single wheel is to be preferred if it is possible. However, two jets are often used upon one wheel though at some sacrifice of efficiency. For a given size wheel the horsepower of one jet is limited by the maximum size of the jet that may be employed. If a greater horsepower is desired it is necessary to use two or more jets upon the one wheel or to use a larger wheel with a single jet. The larger wheel

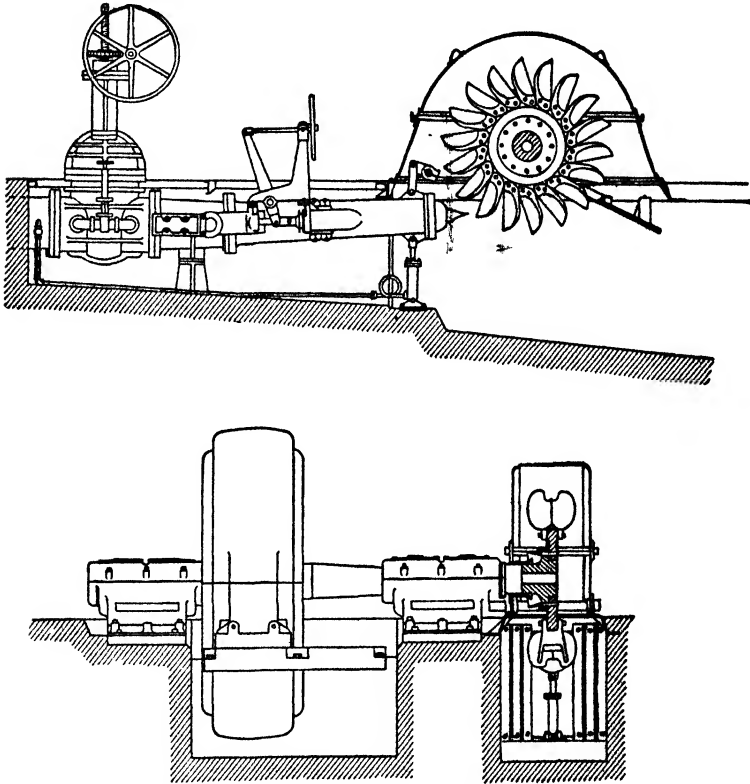

FIG. 25.—Tangential water wheel unit with deflecting nozzle.

means a lower r.p.m. and a higher cost both of the wheel and the generator if a direct connected unit is used. In case this additional expense is not justified by the increased efficiency of the single jet wheel the duplex nozzle would be used.

The tangential water wheel is almost always set with a horizontal shaft and, if direct connected to a generator, is overhung so that the unit has only two bearings (Fig. 25). It is quite common for two wheels to drive a single generator mounted between them in which case we have the double-overhung type.

**31. Speed Regulation.**—Various means have been adopted to regulate the power input to the tangential water wheel but the following are the only ones that are of any importance. The

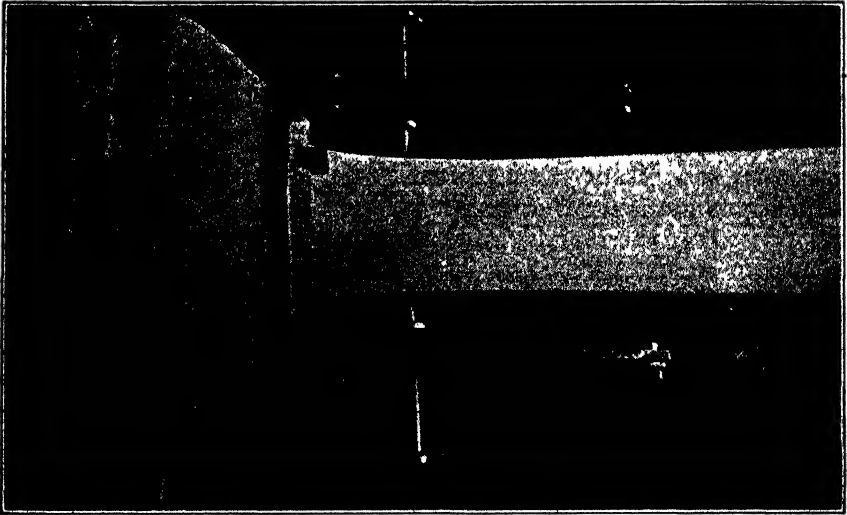

FIG. 26.—5286 h.p. Jet, from  $7\frac{1}{2}$  in. needle nozzle. Head = 822 ft. Jet velocity = 227.4 ft. per second.

use of any throttle valve in the pipe line is wasteful as it destroys a portion of the available head and thus requires more water to be used for a given amount of power than would otherwise be the case. The ideal mode of governing, so far as economy of water

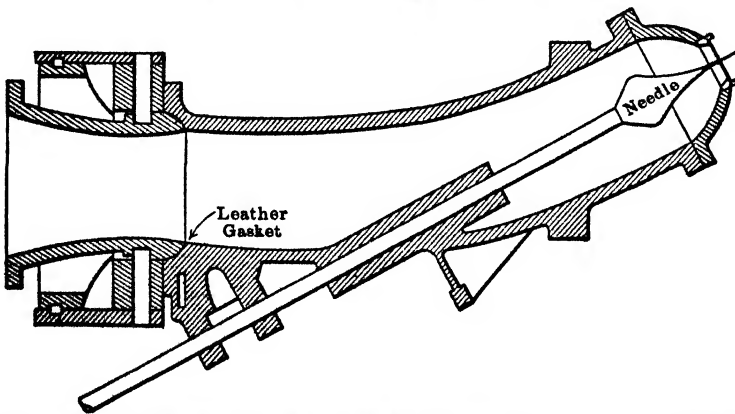

FIG. 27.—Deflecting needle nozzle. (After drawing by Prof. W. R. Eckart, Jr.)

is concerned, would not affect the head but would merely vary the water used in direct proportion to the power demanded.

The needle nozzle (Fig. 27) accomplishes this result very nearly



As the needle is moved back and forth it varies the area of the opening and thus varies the amount of water discharged. The coefficient of velocity is a maximum when the nozzle is wide open but it does not decrease very seriously for the smaller nozzle openings. (See Fig. 89.) Thus the velocity of the jet is very nearly the same for all values of discharge. The efficiency of a well-constructed needle nozzle is very high, being from 95 to 98 per cent.<sup>1</sup> The needle nozzle is nearly ideal for economy of water but may not always permit close speed regulation. If the pipe line is not too long, the velocity of flow low, and the changes of load small and gradual, the needle nozzle may be very satisfactory. In case it is used the penstock is usually provided with a standpipe or a surge tank.

If the pipe line is long, the velocity of flow high, and the changes of load severe, dangerous water hammer might be set up if the discharge were changed too quickly. It might therefore be difficult to secure close speed regulation with the needle nozzle as the governors would have to act slowly. The deflecting nozzle, shown in Fig. 7, page 8, is much used for such cases. The nozzle is made with a ball-and-socket joint so that the entire jet can be deflected below the wheel if necessary. The governor sets the nozzle in such a position that just enough water strikes the buckets to supply the power demanded. The rest of the water passes below the buckets and is wasted. Since there is no change in the flow in the pipe line the governor may accomplish any degree of speed regulation desired as there is little limit to the rapidity with which the jet may be deflected. Such a nozzle is usually provided with a needle also which is regulated by hand. Fig. 27 is really of this type. In another type the body of the nozzle is stationary and only the tip is moved. The needle stem must be equipped with a guide in this moving part and also be fitted with a universal joint so that the needle point may always remain in the center of the jet. The station attendant sets the needle from time to time according to the load that he expects to carry. However, the device is wasteful of water unless carefully watched. If other water rights prevent the flow of a stream from being interfered with it may be satisfactory.

In some modern plants the operator can control the position of the needle from the switchboard and by careful attention very

<sup>1</sup> W. R. Eckart, Jr., *Inst. of Mech. Eng. (London)*, Jan. 7, 1910.  
*Bulletin* No. 6, Abner Doble Co.

little water is wasted. Since the experience is that loads increase slowly, the operator need have little trouble in keeping the unit up to speed.

The combined needle and deflecting nozzle may possess the advantages of both of the above types, by having the needle automatically operated. If the load on the wheel is reduced

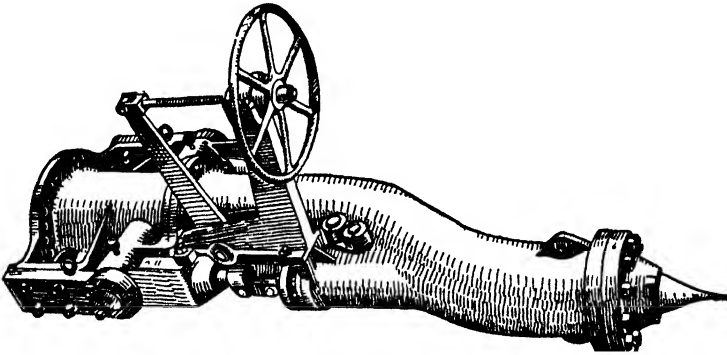

FIG. 28 —Deflecting needle nozzle for 8000 h.p. wheel.

the governor at once deflects the jet thus preventing any increase of speed. Then a secondary relay device slowly closes the needle nozzle and, as it does so, the nozzle is gradually brought back to its original position where all the water is used upon the wheel. Thus close speed regulation is accomplished with very little waste of water.

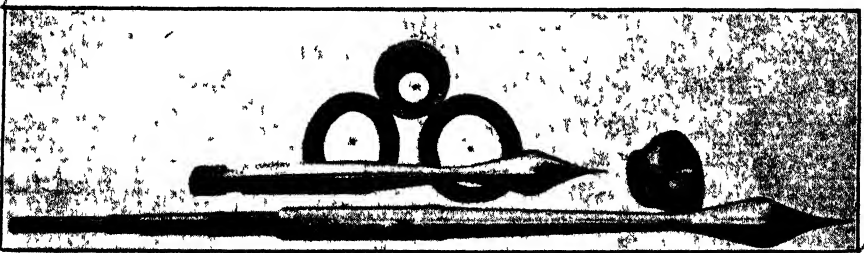

FIG. 29.—Needles and nozzle tips. (Courtesy of Pelton Water Wheel Co.)

The needle nozzle with auxiliary relief shown in Fig. 30 and Fig. 31 accomplishes the same results as the above. When the needle of the main nozzle is closed the auxiliary nozzle underneath it is opened at the same time. This discharges an equivalent amount of water which does not strike the wheel. This auxiliary nozzle is then slowly closed by means of a dash-pot mechanism. While

both of these types relieve the pressure in case of a decreasing load they are unable to afford any assistance in the case of a rapid demand for water. The deflecting nozzle alone is the only type that is perfect there.

**32. Conditions of Use.**—The tangential water wheel is best adapted for high heads and relatively small quantities of water. By that is meant that the choice of the type of turbine is a function of the capacity as well as the head. For a given head the larger the horsepower, the less reason there is for using this type of wheel.

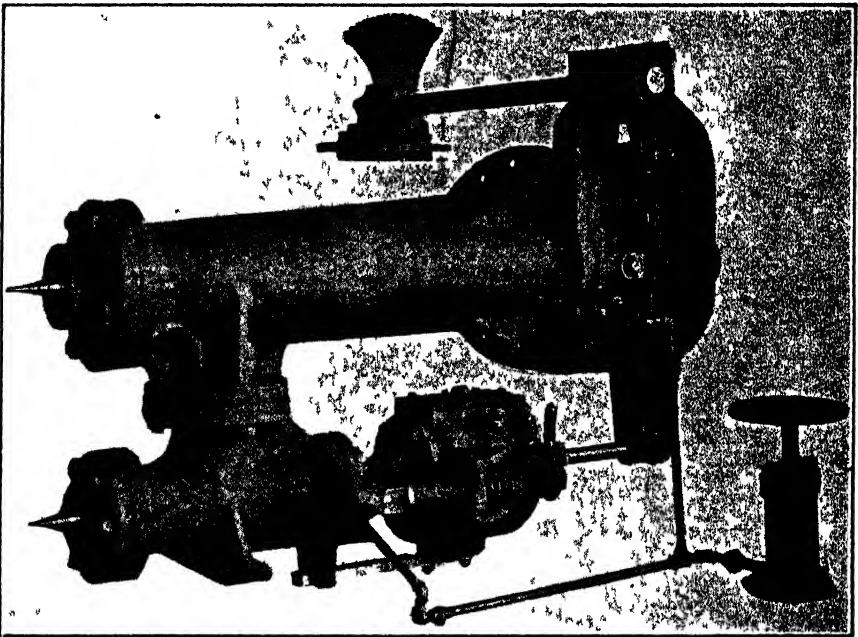

FIG. 30.—Auxiliary relief needle nozzle.  
(Made by Pelton Water Wheel Co.)

In Switzerland a head as high as 5412 ft. has been used for 5 wheels of 3000 h.p. each. The jets are 1.5 in. in diameter and the wheels, which run at 500 r.p.m., are 11.5 ft. in diameter. There are several installations in this country under heads of about 2100 ft. There are numerous cases of heads between 1000 and 2000 ft. but probably the majority of the installations are for heads of about 1000 ft.

The largest power developed by a single jet upon a single wheel is 15,000 h.p. The jet is 8 in. in diameter and the wheel runs at 375 r.p.m. under a head of about 1700 ft.

The largest jet employed upon any Pelton wheel is about  $10\frac{1}{4}$  in. in diameter. The net head is 506 ft. in this case. There are a number of large jets of 9 in. or over used for heads from 900 to 1500 ft.

**33. Efficiency.**—The efficiency of the tangential water wheel is about the same as that of the average reaction turbine. From 75 to 85 per cent. may reasonably be expected though lower values are often obtained, due to poor design.

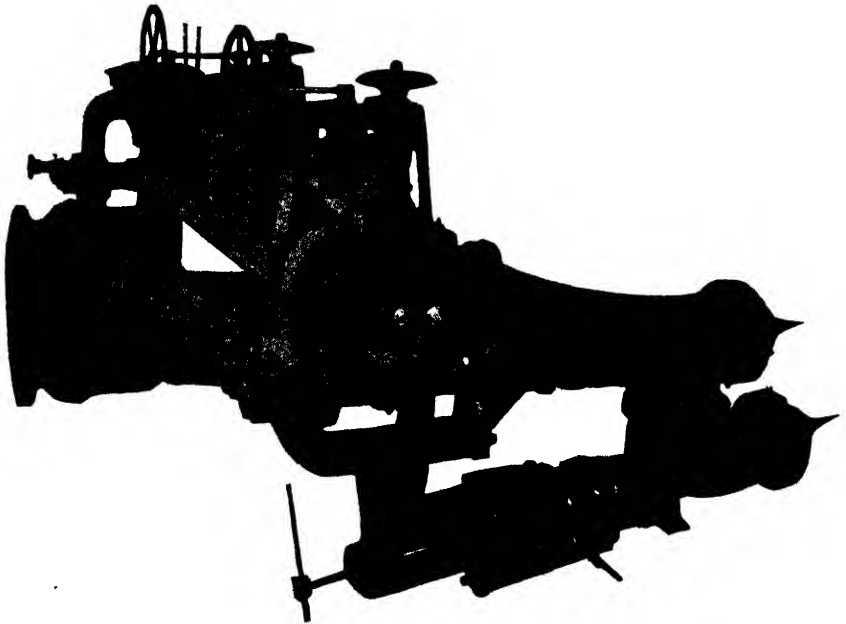

FIG. 31.—Auxiliary relief needle nozzle for use with 10,000 kw. tangential water wheel. (Made by Pelton Water Wheel Co.)

### 34. QUESTIONS AND PROBLEMS

1. Of what materials are impulse wheel buckets constructed? How are they secured to the rim? What is the advantage of "chain type" construction? What should be the relation between the size of the jet and the size of the bucket?

2. When would two or more jets be used upon a Pelton wheel? What is the relation between the diameter of the wheel and the diameter of the jet? How may the speed of rotation of a wheel of given diameter be computed, if the head is known? What fixes the diameter of the jet that is to be employed, assuming that it is not limited by any wheel size?

3. What is meant by single-overhung and double-overhung construction? What is the advantage of the latter? How is the shaft usually placed?

4. What is the needle nozzle, the deflecting nozzle, and the deflecting

needle nozzle? What is the needle nozzle with auxillary relief and how does it operate?

5. What are the relative merits of the different methods of governing the tangential water wheel?

6. What are the conditions of use of impulse wheels in regard to head, power, size of jet, etc.? What efficiency should be expected?

7. It is desired to develop 3880 h.p. with a Pelton wheel under a head of 900 ft. Assuming the efficiency of the wheel to be 82 per cent. and the velocity coefficient of the nozzle to be 0.98, what will be the diameter of the jet? What will then be a reasonable diameter for the wheel and its probable speed of rotation? *Ans.* 6 in., 6 ft., 345 rev. per min.

8. How small could the wheel be made in the preceding problem? What would then be its speed of rotation? If a higher speed than this is desired for the same horsepower, what construction could be employed?

9. A Pelton wheel runs at a constant speed under a head of 625 ft. The cross-section area of the jet is 0.200 sq. ft. and the nozzle friction loss is to be neglected. Suppose a throttle valve in the pipe reduces the head at the base of the nozzle from 625 ft. to 400 ft. Under these conditions the efficiency of the wheel (the speed of the wheel no longer being proper for the head) is known to be 50 per cent. Find the rate of discharge, power of jet, and power output of wheel.

*Ans.* 32.08 cu. ft. per second, 1458 h.p., 729 h.p.

10. A Pelton wheel runs at a constant speed under a head of 625 ft. The cross-section area of the jet is 0.200 sq. ft. and the nozzle friction loss is to be neglected. Suppose the needle of the nozzle is so adjusted as to reduce the area of the jet from 0.200 to 0.0732 sq. ft. Under these conditions the efficiency of the wheel is known to be 70 per cent. Find the rate of discharge, power of jet, and power output of wheel.

*Ans.* 14.67 cu. ft. per second, 1041 h.p., 729 h.p.

11. Compare the water consumed per horsepower output for the wheel in the preceding two problems. Compute the overall efficiency in each case using the head of 625 ft. *Ans.* 32 per cent., 70 per cent.

## CHAPTER V

### THE REACTION TURBINE

**35. Development.**—The primitive type of reaction turbine known as Barker's Mill is shown in Fig. 32. The reaction of the jets of water from the orifices causes the device to rotate. In order to improve the conditions of flow the arms were then curved and it became known in this form as the Scotch turbine. Then three or more arms were used in order to increase the power, and with still further demands for power more arms were added and the orifices made somewhat larger until the final result was a complete wheel. In 1826 a French engineer, Fourneyron, placed stationary guide vanes within the center to direct the water as it flowed into the wheel and we then had the outward flow turbine. In 1843 the first Fourneyron turbines were built in America.

The axial flow turbine commonly called the Jonval was also a European design introduced into this country in 1850.

An inward flow turbine was proposed by Poncelet in 1826 but the first one was actually built by Howd, of New York, in 1838. The latter obtained a patent and installed several wheels of crude workmanship in the New England mills. In 1849 James B. Francis designed a turbine under this patent but his wheel was of superior construction. Furthermore he conducted accurate tests, published the results, analyzed them, and formulated rules for turbine runner design. He thus brought this type of wheel to the attention of the engineering world and hence his name became attached to it.

The original Francis turbine is shown in Fig. 5, page 4, and in Fig. 6, page 5, may be seen photographs of a radial inward flow runner of this type though of more recent date. As may be seen in Fig. 4, page 3, the water has to turn and flow away

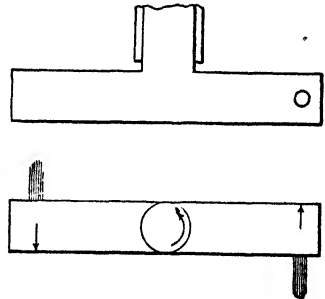

FIG. 32.—Barker's mill.

axially after its discharge and hence the original design was gradually modified so that the water began to turn before its discharge from the runner. The Swain turbine (1855) shows this evolution and the McCormick runner (1876) carries it still further. The latter is the prototype of the modern high speed mixed flow runner. The nearest approach to the original Francis runner in present practice is to be seen in Fig. 34, Type I, and in Fig. 36. The pure radial flow turbine is no longer built, but since all the modern inward mixed flow turbines may be said to have grown out of it, they are today quite generally known as Francis turbines.

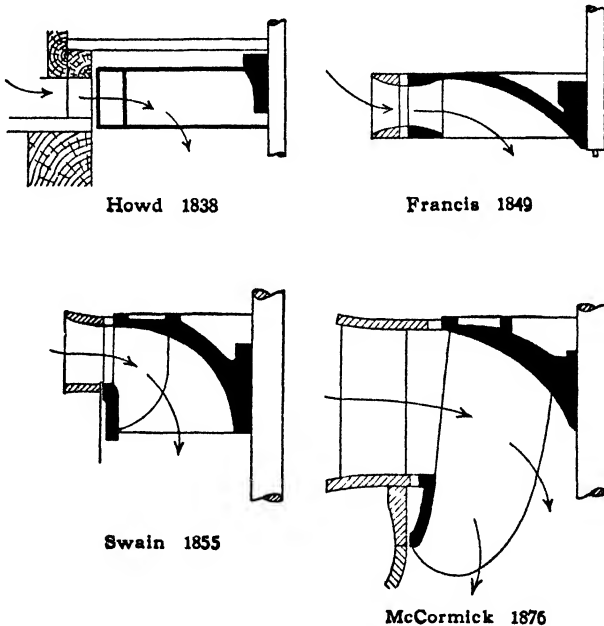

FIG. 33.—Evolution of the modern turbine.

The high-speed mixed flow runner, illustrated by the original McCormick type in Fig. 33, arose as the result of a demand for higher speed and power under the low falls first used in this country. Higher speed of rotation could be obtained by using runners of smaller diameter, but higher power required runners of larger diameter, so long as the same designs were adhered to. So in order to increase the capacity of a wheel of the same or smaller diameter, the design was altered by making the depth of the runner greater (*i.e.*, the dimension *B*, Fig. 34, was increased). The area of the waterway through the runner was

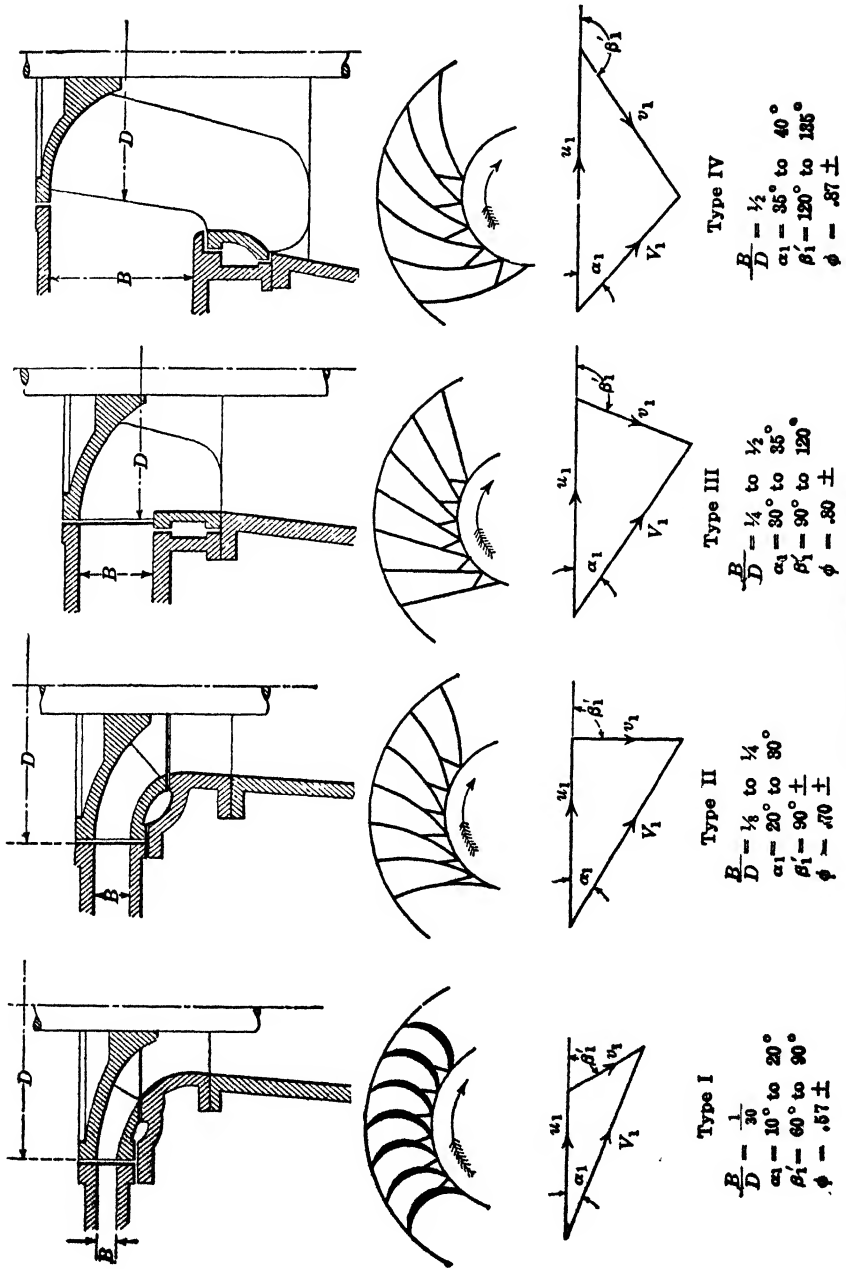

Fig. 34.—Types of runners.



also increased slightly by using fewer vanes and it was then desirable to extend these further in toward the center. As that left a very small space in the center for the water to discharge through, it was necessary for the runner to discharge the greater part of the water axially. Type IV of Fig. 34 shows the high-speed high-capacity runner of today.

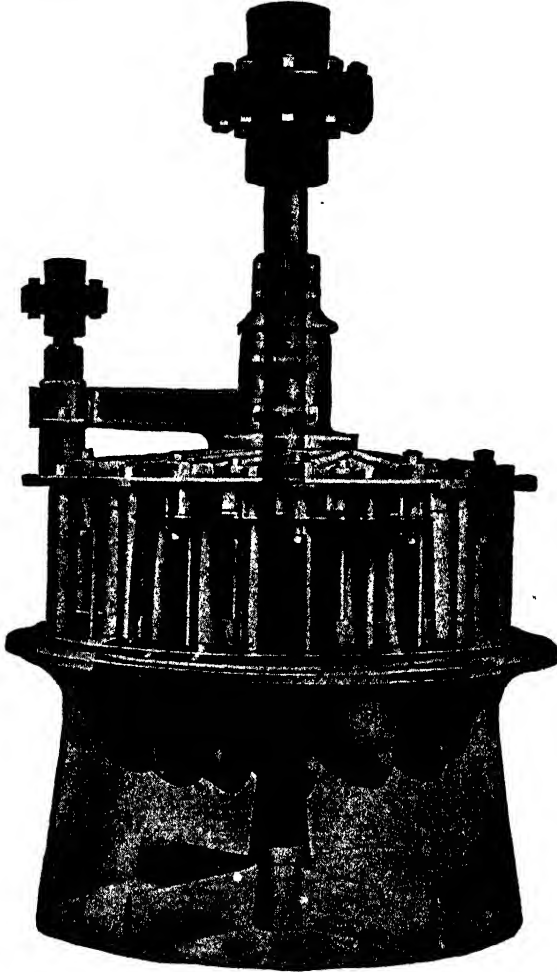

FIG. 35.—Leffel turbine for open flume. (*Made by James Leffel and Co.*)

As civilization moved from the valleys, where the low falls were found, up into the more mountainous regions, and as means of transmitting power were introduced, it became desirable to develop higher heads, and in 1890 a demand arose for high-head wheels which American builders were not able to supply. For a time European designs were used and then it was seen that

a type similar to the original Francis turbine was well suited to those conditions. This is shown by Type I of Fig. 34.

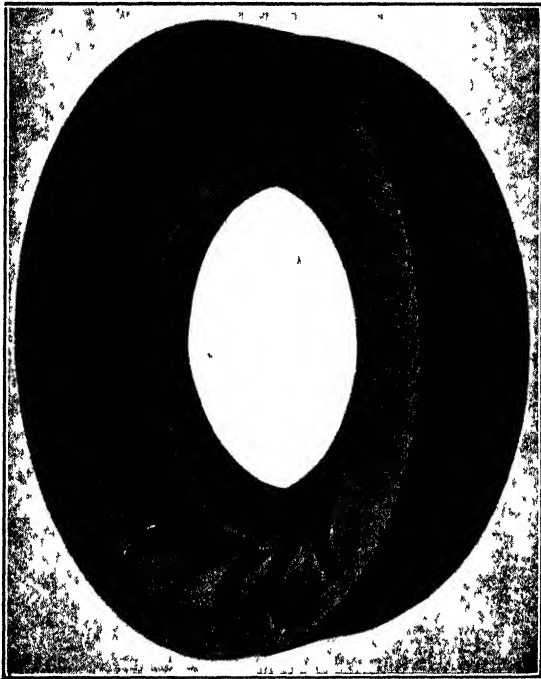

FIG. 36.—42" Francis runner. 8000 h.p., 600 ft. head.  
(Made by Platt Iron Works Co.)

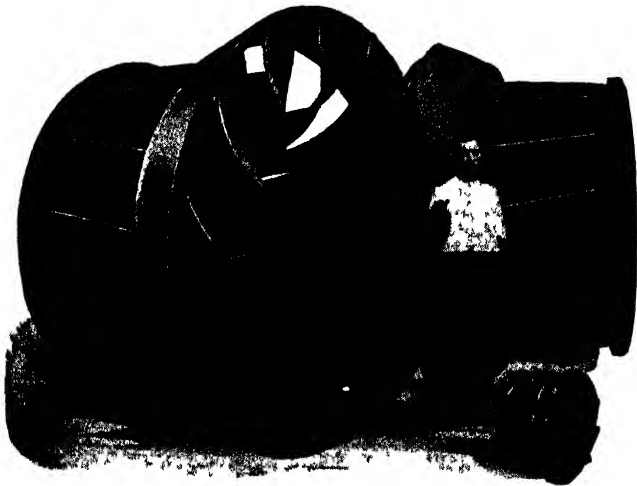

FIG. 37.—Turbine runners of the Allis-Chalmers Mfg. Co.

At present the range of common American practice is covered by the four types shown in Fig. 34, though in a few cases extreme

designs have passed beyond these limits. American turbines in the past were developed by "cut and try" methods, European turbines largely by mathematical analysis. At the present time the best turbines in this country are designed from rational theory supplemented by experimental investigation.

**36. Advantages of Inward Flow Turbine.**—The Fourneyron turbine has a high efficiency on full load and is useful in some cases where a low speed is desired, but it has been supplanted by the Francis turbine for the following reasons:

1. The inward flow turbine is much more compact, the runner can be cast in one piece, and the whole construction is better mechanically.

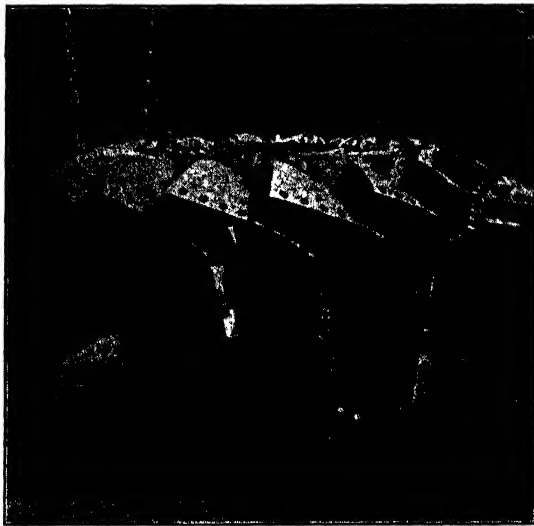

(From a photograph by the author.)

FIG. 38.—Construction of a built-up runner.

2. Since the turbine is more compact and smaller, the construction will be much cheaper. The smaller runner will permit of a higher r.p.m. and that means a cheaper generator can be used.

3. The gates for governing are more accessible and it is easier to construct them so as to minimize the losses. Thus the efficiency of the turbine on part load is better than is the case with the outward flow type.

4. It is easier to secure the converging passages that are necessary through the runner.

5. A draft tube can be more conveniently and effectively used.

**37. General Proportions of Types of Runners.**—It has already been seen how the need for varying the capacity of runners without changing their diameters has led to altering the height  $B$  and the general profile as illustrated in Fig. 34. The increased volume of water through the higher capacity runners also requires a larger diameter of draft tube, as well as a higher velocity

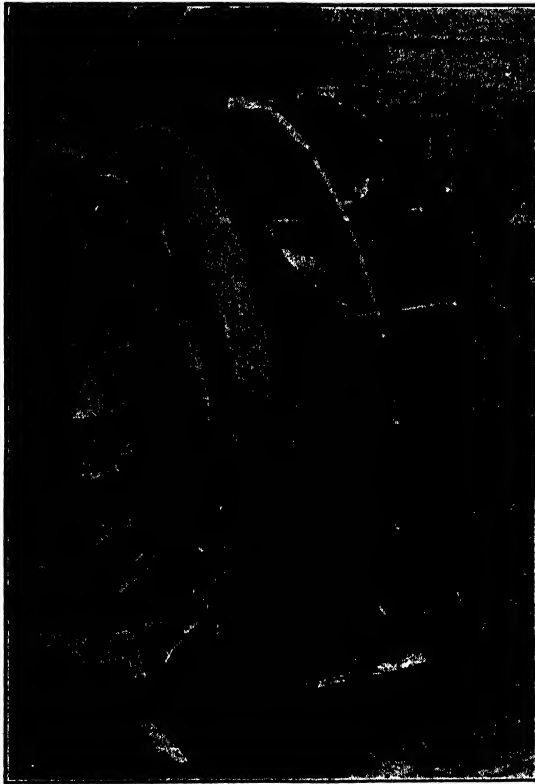

*(From a photograph by the author.)*

FIG. 39.—Double-discharge runner.

of flow at this section, and in extreme types the flow through the runner is not merely inward and downward but for those particles of water nearest the band or ring it is inward, downward, and outward.

But the quantity of water which will flow through the runner depends not only upon the area at inlet but also upon the velocity of the water. If we confine our attention to the circumferential area of the runner at entrance we are concerned with the velocity normal to it and this is the radial component of velocity. Hence we increase the capacity of the runner by making the radial

component of the velocity of the water larger. This causes the angle  $\alpha_1$  to be increased as may be seen in Fig. 34. The angle  $\alpha_1$  is determined by the guide vanes.

It is convenient to express the peripheral velocity of the runner  $u_1$  as equal to  $\phi\sqrt{2gh}$ . The value of  $\phi$  which gives the most efficient speed for a given turbine is denoted by  $\phi_e$  and values of  $\phi_e$  for different turbines range from about 0.55 to about 0.90 according to the design.<sup>1</sup> If the value of  $\phi$  is higher than this it is probable that the speed is higher than the best speed or that the nominal diameter for which  $u_1$  is computed is larger than the real diameter. Values of  $\phi_e$  may be varied in the design by altering certain angles and areas of the runner.

Since it is desirable, in general, to increase or decrease the rotative speed and the capacity simultaneously, the custom is to so proportion the runners that low values of  $\phi_e$  are found with turbines of Type I, Fig. 34, while high values are found with those of Type IV. Thus a low-capacity runner also has a low peripheral speed for a given head, while a high-capacity runner would have a higher peripheral speed. Thus for a given diameter of runner under a given head both power and speed of rotation increase from Type I to Type IV. If, on the other hand, the power is fixed, the diameter of runner of Type IV would be much smaller than that of Type I. Hence the rotative speed of the former would be higher due to the smaller diameter as well as the increased linear velocity. For this reason this type is called a high-speed runner, while Type I is a low-speed runner. Both capacity and speed are involved in a single factor variously known as the specific speed, characteristic speed, unit speed, and type characteristic. It is  $N_s = N_e\sqrt{B.hp.}/h^{5/4}$ , the derivation of which will be given later. ( $N_e$  is the speed for highest efficiency.) As the capacity and speed increase, this factor increases. Hence a "high-speed" turbine is really a high specific speed turbine and a "low-speed" turbine is a low specific speed turbine. The value of  $N_s$  is an index of the type of turbine. Values of  $N_s$  for reaction turbines range from 10 to 100, though the latter limit is occasionally exceeded.

The vector diagrams of the velocities at entrance are drawn to the same scale in Fig. 34 as if all four types were under the same head. It may be seen that as we proceed from Type I to Type IV,  $u_1$ ,  $\alpha_1$ , and  $\beta'_1$  increase, while  $V_1$  decreases. Since the angle

<sup>1</sup> "Water Turbines," by S. J. Zowski is the source of much of Fig. 34.

$\beta_1$  is the angle which the relative velocity of the water makes at entrance, the vane angle  $\beta'_1$  should be made equal to it.

**38. Comparison of Types of Runners.**—As a means of illustrating the differences between the various types of runners the following tables are presented:

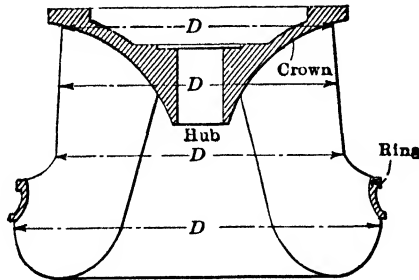

FIG. 40.—Methods of specifying runner diameter.

TABLE 1.—COMPARISON OF 12-IN. WHEELS UNDER 30-FT. HEAD

| Type                        | Discharge,<br>cu. ft. per<br>minute | H.p. | R.p.m. |
|-----------------------------|-------------------------------------|------|--------|
| Tangential water wheel..... | 7.9                                 | 0.37 | 380    |
| Reaction turbines:          |                                     |      |        |
| Type I.....                 | 99.0                                | 4.3  | 460    |
| Type II.....                | 329.0                               | 14.9 | 554    |
| Type III.....               | 741.0                               | 33.4 | 600    |
| Type IV.....                | 1209.0                              | 55.5 | 730    |

TABLE 2.—COMPARISON OF WHEELS TO DEVELOP 15 H.P. UNDER 30-FT. HEAD

| Type                        | Diameter, in. | R.p.m. |
|-----------------------------|---------------|--------|
| Tangential water wheel..... | 60            | 55     |
| Reaction turbines:          |               |        |
| Type I.....                 | 21            | 274    |
| Type II.....                | 12            | 554    |
| Type III.....               | 8             | 900    |
| Type IV.....                | 6             | 1460   |

It will be seen that the tangential water wheel is a low-speed, low-capacity type, while the reaction turbine of Type IV is a high-speed, high-capacity runner. This may be contrary to the popular impression, but these terms as used here have only relative

meanings. Under high heads where the r.p.m. would naturally be high the relatively lower speed of the tangential water wheel is of advantage, while under the low heads the relatively higher speed of the reaction turbine is of advantage. This difference of speed exists even when the runners are of the same diameter as seen by the first table. But when the diameters are made such as to give the same power as in the second table the difference be-



FIG. 41.—13,500 h p. runner. Head = 53 ft., speed = 94 r.p.m. (Made by I. P. Morris Co.)

comes much greater. It must be understood that these tables do not prove one type of wheel to be any better than another but merely show what may be obtained. If the tangential water wheel or Type I of the reaction turbines appear in an unfavorable light it is only because the head and horsepower are not suitable for them.

**39. Runners.**—Runners may be cast solid or built up, but the majority are cast solid as the construction is more substantial. Occasionally a very large runner may be cast in sections. Built up wheels have the vanes shaped from steel plates and the crown, hubs, and rings are cast to them, as shown in Fig. 38. The best runners are made of bronze. Cast steel is used for very

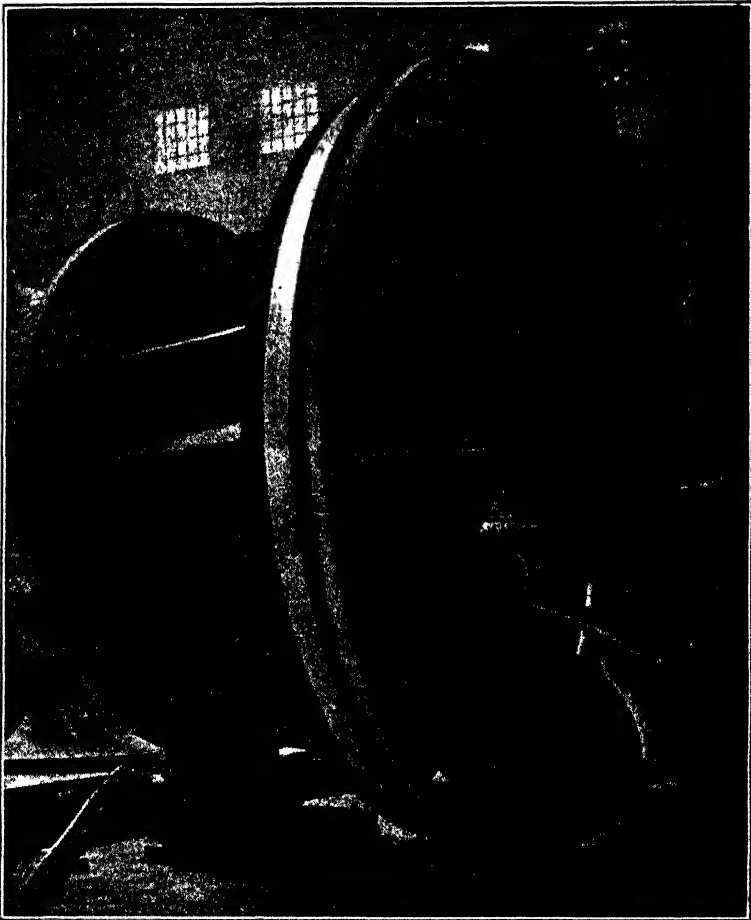

FIG. 42.—10,000 h.p. runner at Keokuk, Ia. Head = 32 ft., speed = 57.7 r.p.m. (*Made by Wellman-Seaver-Morgan Co.*)

high heads in some cases, while cheaper runners are made of cast iron. Very naturally the large runners are made of the latter metal.

Runners may be divided into two broad classes of single and double discharge runners. Figs. 36 and 42 are of the first type and Fig. 39 of the second. The latter is essentially two single



discharge runners placed back to back and requires two draft tubes as the water is discharged from both sides. It is used only for horizontal shaft units, while the single discharge runner may be used for either horizontal or vertical shaft turbines.

Turbines are often rated according to the diameter of the runner in inches. This diameter is easily fixed in many cases, but for one of the type shown in Fig. 40 either one of four dimensions may be used. Different makers follow different practices in this regard but the usual method is to measure the diameter at a point about halfway down the entrance height.

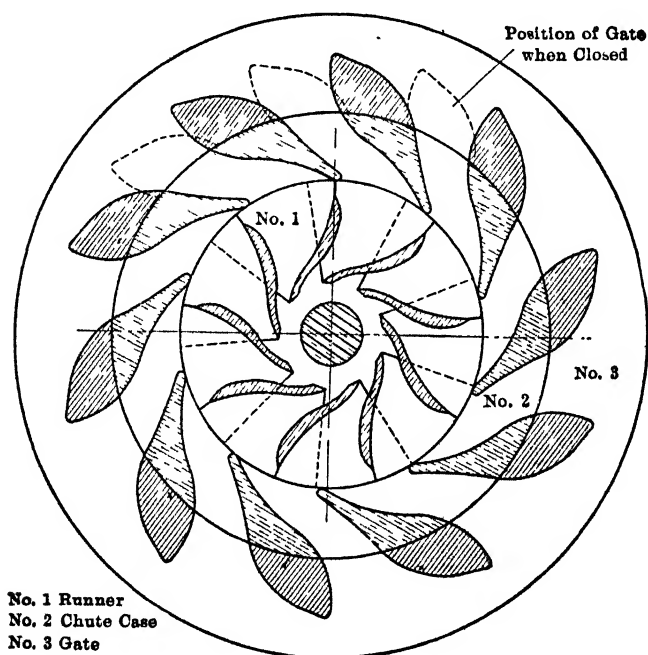

FIG. 43.—Register gate.

**40. Speed Regulation.**—The amount of water supplied to the reaction turbine is regulated by means of gates of which there are three types.

The cylinder gate is shown in Fig. 5, page 4. It is the simplest and cheapest form of gate and also the poorest, although, when closed, it will not leak as badly as the others. When the gate is partially closed there is a big shock loss in the water entering the turbine runner due to the sudden contraction and the sudden expansion of the stream that must take place. With this type of

gate the efficiency on part load is relatively low and the maximum efficiency is obtained when the gate is completely raised.

A better type of gate is the register gate shown in Fig. 43. With this type the guide vanes are made in two parts, the inner portion next to the runner is stationary, the outer portion is on a ring which may be rotated far enough to shut the water off entirely, if necessary, as shown by the dotted lines. While this is more



(Courtesy of Allis-Chalmers Co.)

FIG. 44.—View of guide vanes and shifting ring.

efficient than the preceding type there is still a certain amount of eddy loss that cannot be avoided. It is seldom used.

The wicket gate, also called the swing gate or the pivoted guide vane, is shown in Fig. 45. This is the best type and also the most expensive. As the vanes are rotated about their pivots the area of the passages through them is altered. The vanes may be closed up so as to shut off the water if necessary. Of course the angle,  $\alpha_1$ , is altered and a certain amount of eddy loss may also result but it is less than occasioned by either of the

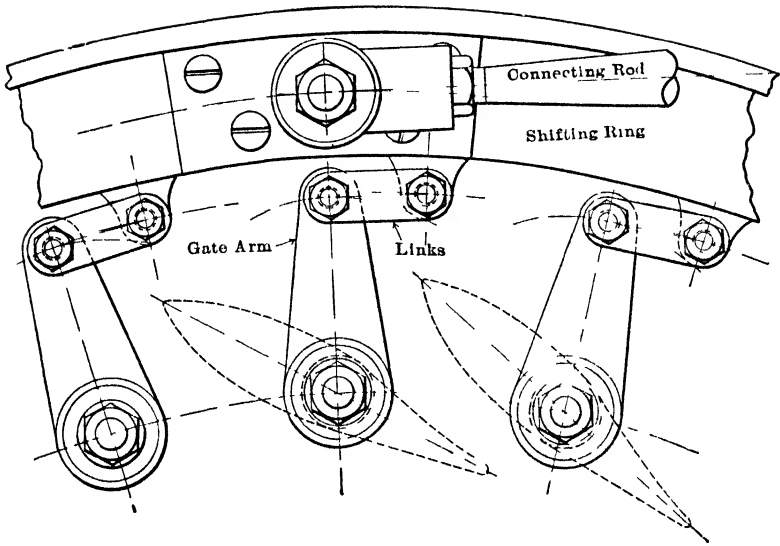

FIG. 45.—Wicket gate with all operating parts outside.

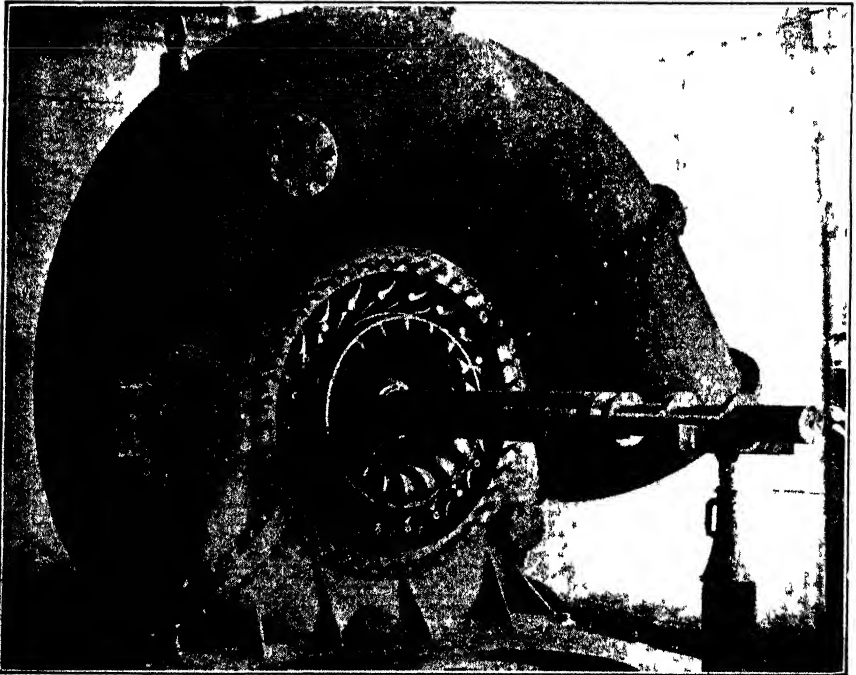

FIG. 46.—Wicket gates and runner in turbine made by Platt Iron Works Co.

other forms. The maximum efficiency is obtained before the gates are opened to the greatest extent.

The connecting rod from the relay governor operates a shifting ring. This in turn, by means of links, rotates the vanes. These

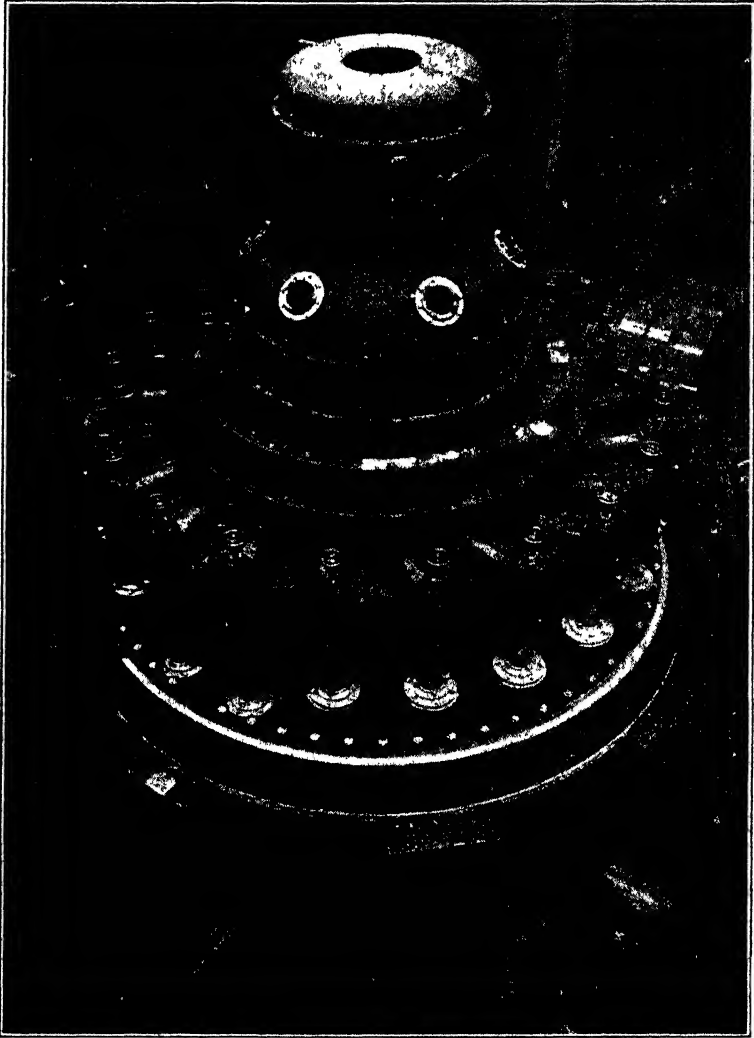

FIG. 47.—10,000 h.p. turbine at Keokuk, Ia. (*Made by Wellman-Seaver-Morgan Co.*)

links are shown in Figs. 45, 47, and 48. Often the shifting ring and links are inside the case, but the better, though more expensive, type has the working parts outside the case.

In order to prevent shock in the penstock when the governor quickly closes the gates, many turbines are provided with

mechanically operated relief valves, as in the left hand side of Fig. 49. This valve is opened at the same time the gates are closed, thus by-passing the water. The relief valve may be so arranged with a dash-pot mechanism that it will slowly close.

**41. Bearings.**—For small vertical shaft turbines a step bearing made of *lignum vitæ* is used under water, as at the bottom of the runner in Fig. 35. This wood gives good results for such service and wears reasonably well. For larger turbines a thrust bearing is usually provided to which oil is supplied under pressure. Roller bearings are also used with the rollers running in an oil bath, as in Fig. 50. Sometimes rollers are provided in the former type but act only when the pressure fails, and again roller bear-

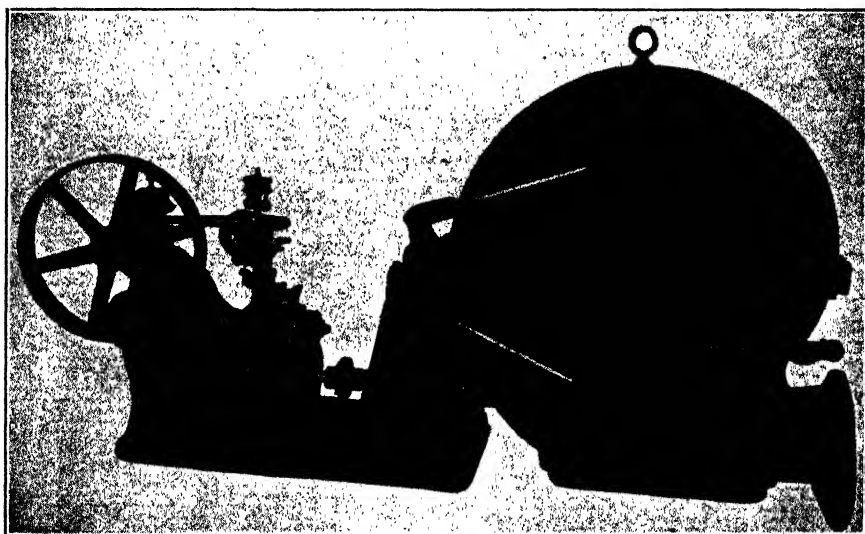
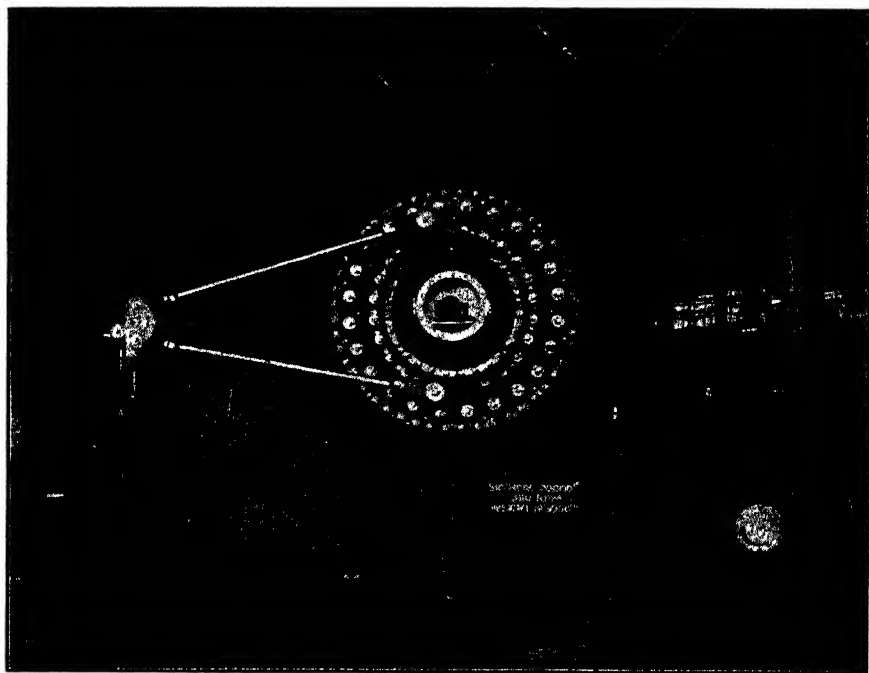

FIG. 48.—Shifting ring and links on a wicket gate spiral case turbine. (*Made by Platt Iron Works Co.*)

ings may sometimes be supplied with oil under pressure between two bearing surfaces in case the rollers fail. The Kingsbury bearing is fitted with a number of metal shoes so mounted that their bearing surfaces are not quite level. Thus as they advance through the oil bath a wedge-shaped film of oil is forced in between these shoes and the other surface. Such a bearing is preferably located at the top of the shaft in which case it is called a suspension bearing, though it may be placed between the generator and the runner.

A horizontal turbine set in an open flume often has *lignum vitæ* bearings as the water is a sufficient lubricant. However



*(Courtesy of Pelton Water Wheel Co.)*

FIG. 49.—Spiral case turbine with relief valve.

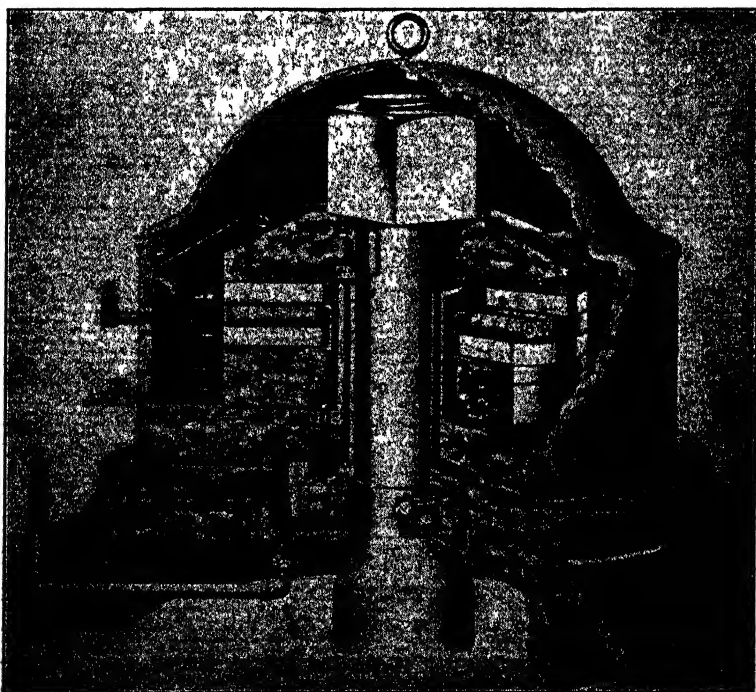

*(Courtesy of Electric Machinery Co.)*

the water must be clear; gritty water would destroy the bearings. If the turbine is in a case so that the bearings are accessible the usual types of bearings are used. It must not be forgotten that even though the shaft be horizontal a very considerable end thrust must be allowed for due to the reaction of the streams discharged from the runner. That is one reason for using runners in pairs. Also a single runner is often used which has a double discharge. (See Fig. 51.) Single discharge runners are often provided with some form of automatic hydraulic balancing piston to equalize the thrust.

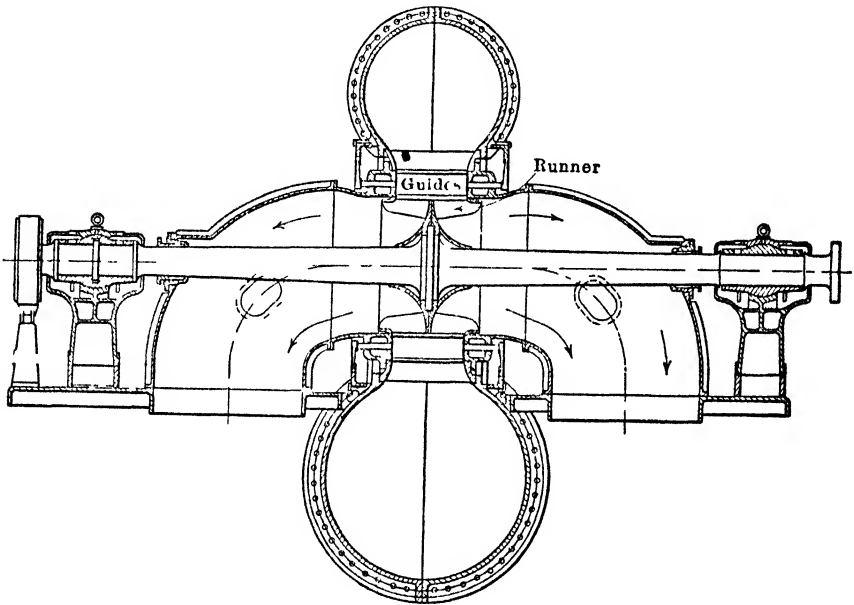

FIG. 51.—Double discharge runner in spiral case.

As the leakage of water through the gates, when closed, may be sufficient to keep the turbine running slowly under no-load, large units are often provided with brakes so they can be stopped.

**42. Cases.**—For low heads turbines may be used in open flumes without cases. Fig. 4, page 3, Fig. 8, page 10, and Fig. 35, page 41, are of this character. Fig. 52 shows such a type consisting of four wheels on a horizontal shaft.

Cases may also be used for very low heads and are always used for high heads. The cheapest cases are the cylinder cases (Fig. 10, page 12), and the globe cases (Fig. 53). These cases are undesirable because they permit of considerable eddy loss as the water flows into them and around in them to the guides.

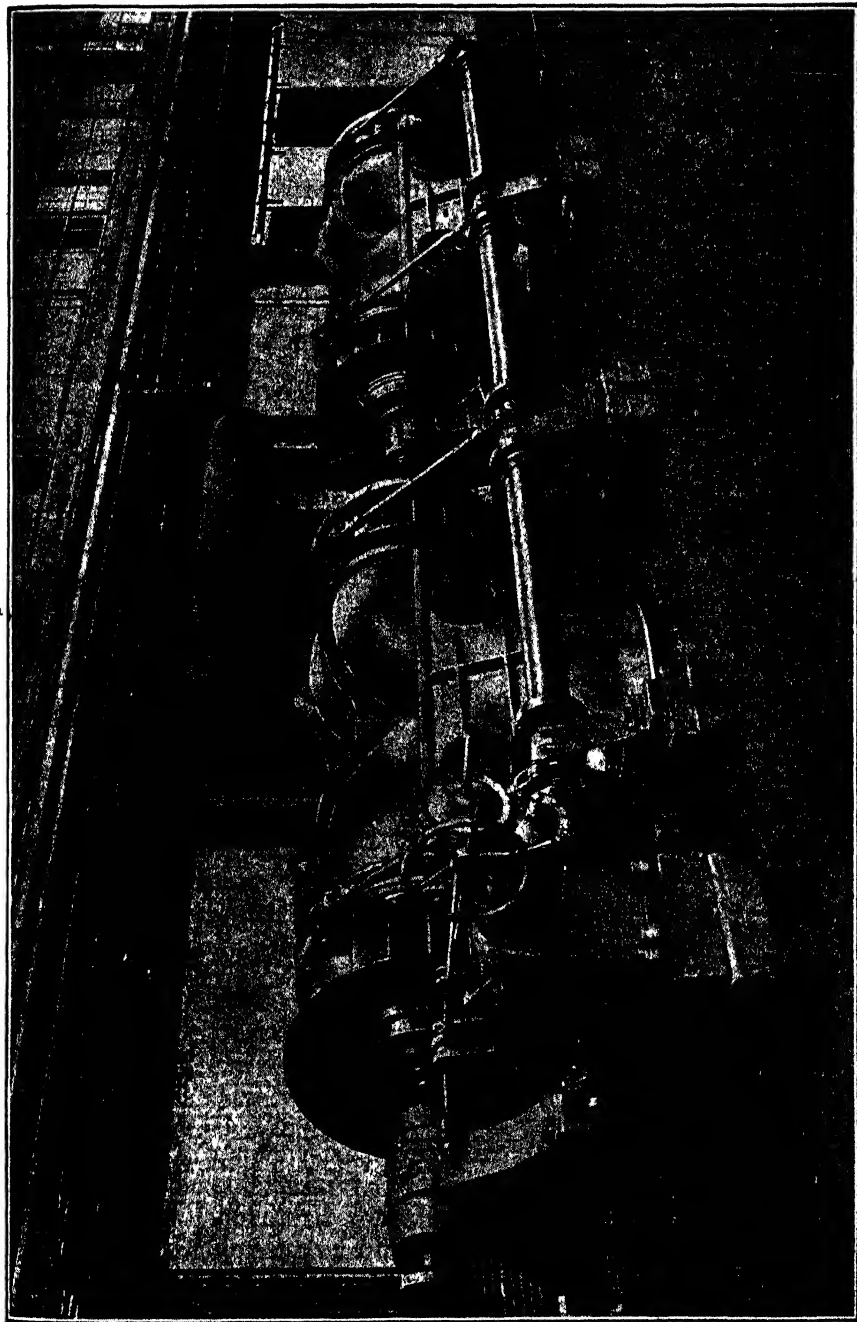

Fig. 52.—Allis-Chalmers turbine for open flume.



The cone case shown in Fig. 54 is a very desirable type. It can be seen that the water suffers no abrupt changes in velocity as it flows from the penstock to the guides, but instead is uniformly accelerated.

The spiral case, illustrated by Fig. 55, is considered the best type. The area of the waterway decreases as the case encircles the guides, because only a limited portion of the water flows clear

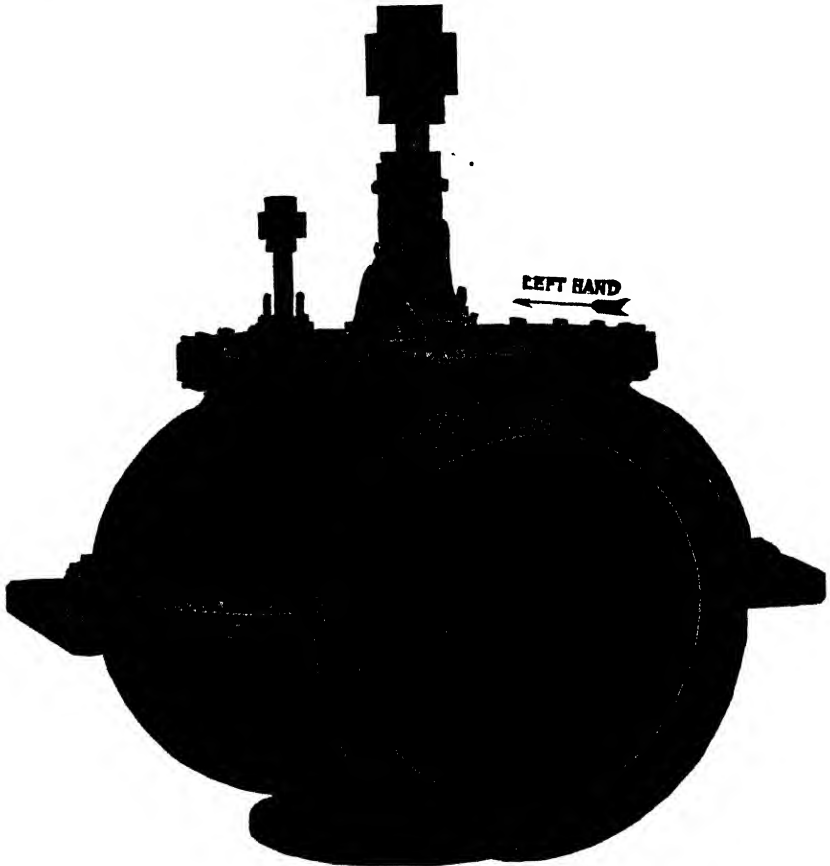

FIG. 53.—Turbine in globe case. (*Made by James Leffel and Co.*)

around to enter the further part of the circumference. Thus the average velocity throughout the case is kept the same. The case is also designed to accelerate the water somewhat as it leaves the penstock and flows to the guides.

Globe and spiral cases for low heads are made of cast iron. For higher heads they are made of cast steel as in Fig. 56. Cylinder cases (Fig. 10, page 12), are usually made of riveted sheet steel. Some very nice spiral cases are now made by several firms of

riveted steel, as may be seen in Fig. 57. Recent practice with large vertical shaft units is to form the case of reinforced concrete as in Fig. 58. The weight of the turbine and generator is carried by the "pit liner," which is set into the concrete, and this in turn

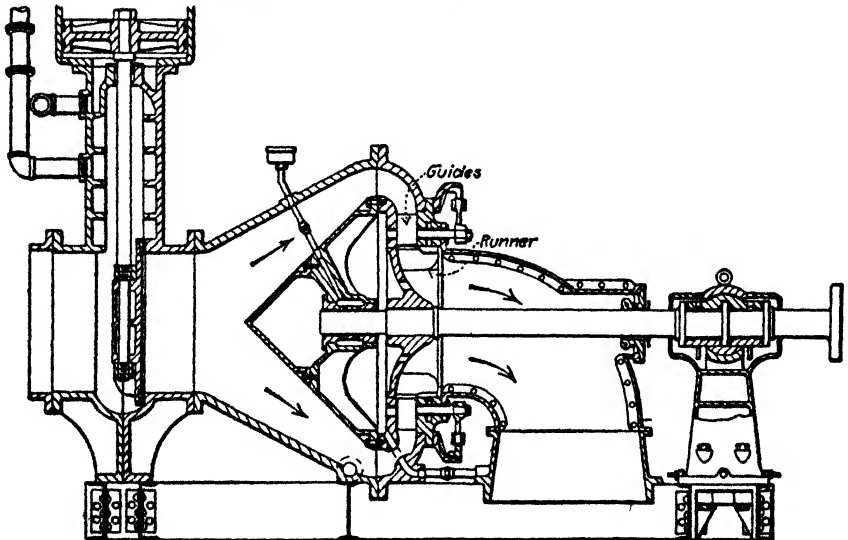
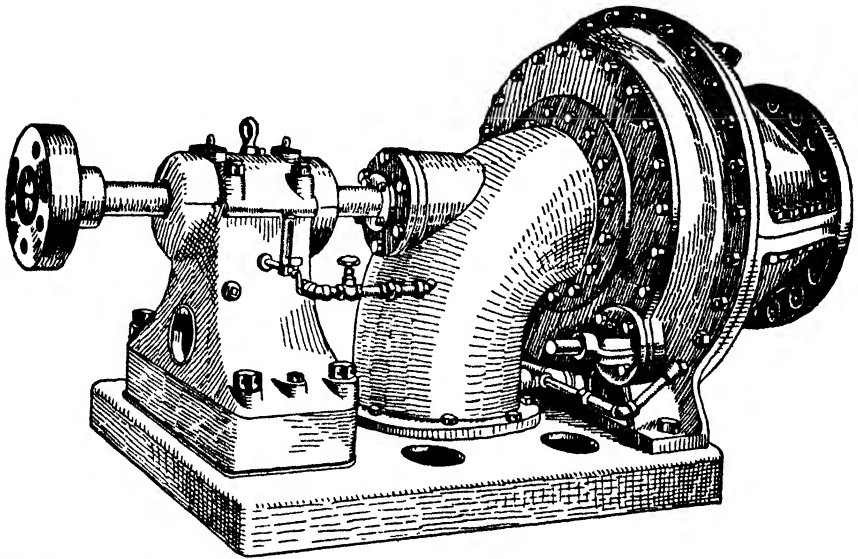

FIG. 54.—Cone case turbine.

rests upon the "speed ring." The latter consists of an upper and a lower flange, as shown, which are joined together by vanes so shaped as to conform to the free stream lines of the water flowing from the case into the guide vanes. Thus they offer less re-

sistance to the flow of the water than the round columns that were once employed. The speed ring vanes are also shown in

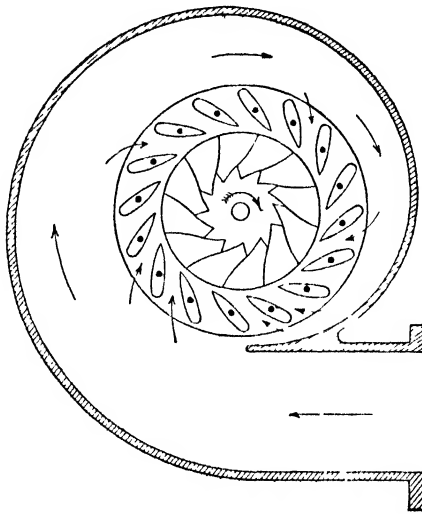

FIG. 55.—Spiral case turbine.



FIG. 56.—Cast steel spiral casings at Niagara Falls. 14,000 h.p. at 180 ft. head.  
(Made by Wellman-Seaver-Morgan Co.)

Figs. 59 and 60. In some instances the case is of sheet metal surrounded by concrete as in Fig. 60.

43. Draft Tube Construction.—It must be borne in mind that the draft tube fulfills two distinct functions. First, it connects

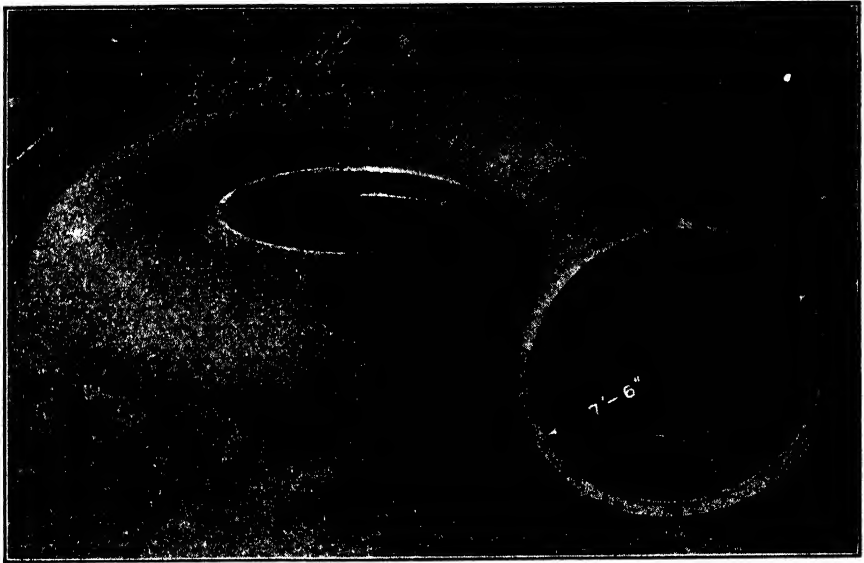

(Courtesy of S. Morgan Smith Co.)

FIG. 57.—Spiral case of riveted steel plates.

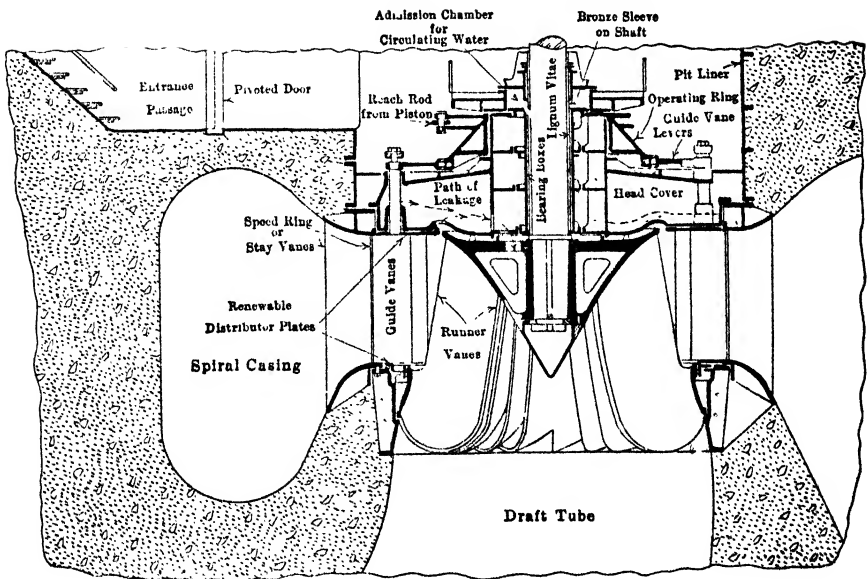
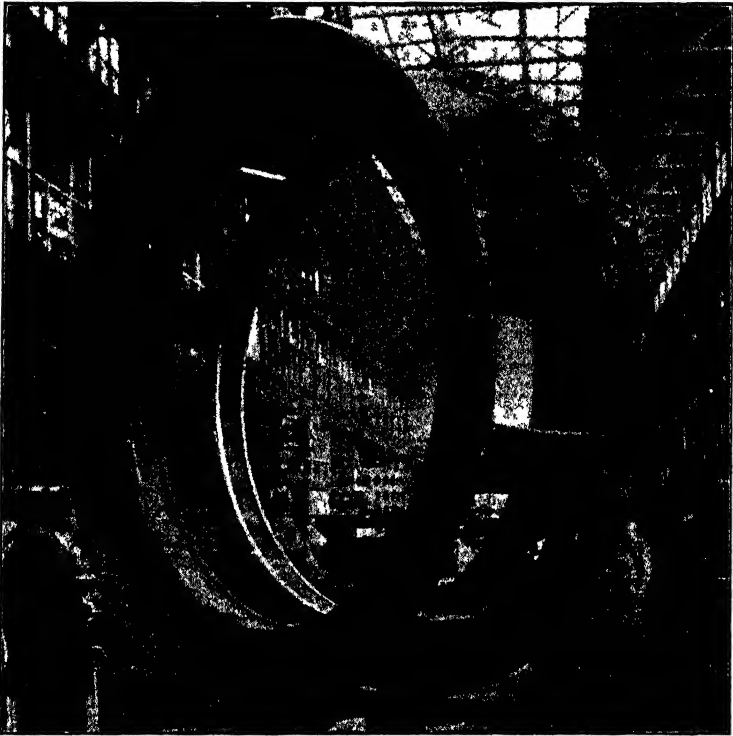

FIG. 58.—Typical large vertical shaft unit.

the turbine runner with the tail water and, since it is air tight, it prevents any loss of head due to the elevation of the wheel.

Second, it may be made to reduce the outflow loss and thus to improve the efficiency of the plant.

For the first purpose alone the tube might be made of a uniform cross-section, but in practice it is always made diverging so as to accomplish the second object as well. In fact, even if the runner should be set below the tail-water level, a draft tube would be of value for the second purpose. This was proven many years ago when Francis tested an outward-flow turbine with a "diffuser" surrounding the runner and found that the



(Courtesy of Allis-Chalmers Mfg Co)

FIG. 59.—Speed ring.

latter improved the efficiency by 3 per cent. As has been pointed out in Art. 37, the higher the capacity of a runner of given diameter the greater the velocity of the water must be at the point of outflow from it into the draft tube. This velocity represents kinetic energy which would otherwise be carried away and many modern wheels of an extreme high-capacity type would not have favorable efficiencies at all if it were not for the use of a suitable draft tube.

The reason for this gain in efficiency may be seen in either of the following ways. First, the total power available is that due to the fall from head-water level to tail-water level. The power of the turbine is less than this by an amount equal to that lost in the intake, penstock, and draft tube. Anything which reduces the loss outside the turbine adds just that much more to

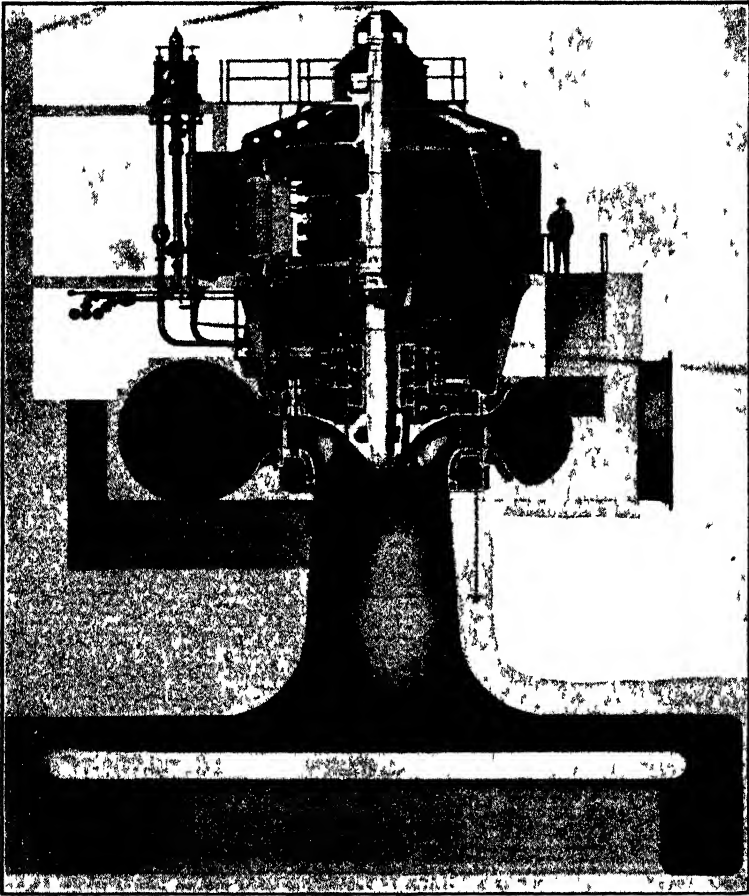

(Courtesy of *Allis-Chalmers Mfg Co*)

FIG. 60.—Turbine for Niagara Falls Power Co., 37,500 h.p., 214 ft. head, 150 r.p.m.

the power which the water can give up within the turbine. The velocity head with which the water leaves the lower end of the draft tube represents kinetic energy which is lost, and the less this discharge loss becomes, the better the efficiency of the turbine. From another standpoint the pressure at the upper end of the draft tube depends not only upon the elevation of this

point above the tail-water level but also upon the velocity of the water at that section and the losses within the tube, including the discharge loss at its mouth. The less this loss, the lower the pressure at the upper end. And the less the pressure at the point of outflow from the turbine runner, the better will be its performance.

Draft tubes are usually made of riveted steel plates as in Fig. 10, page 12, or are moulded in concrete as in Fig. 8, page 10.

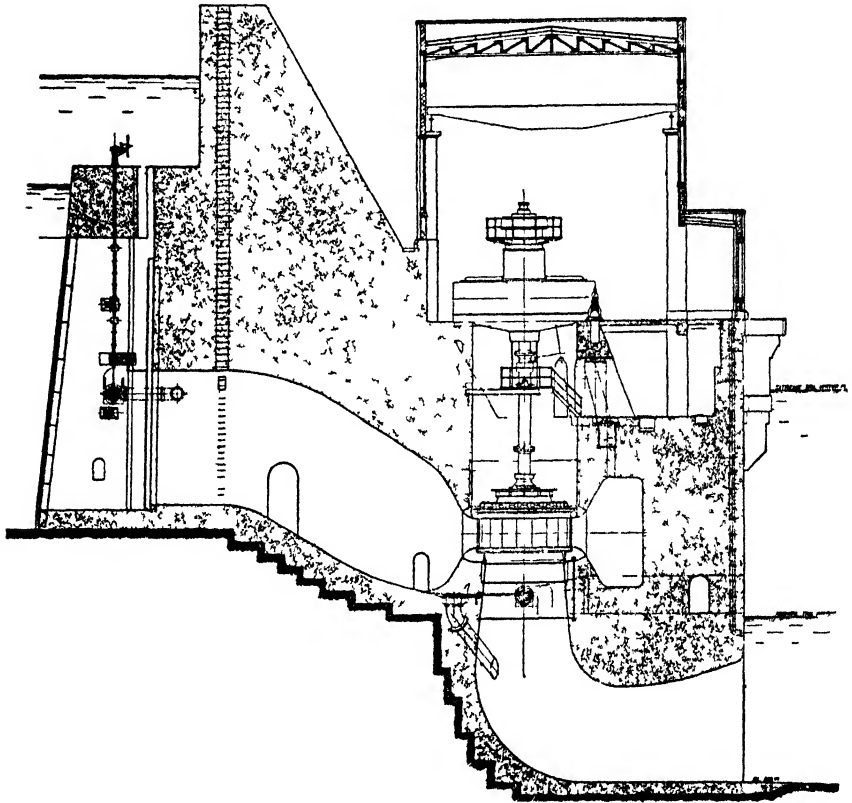
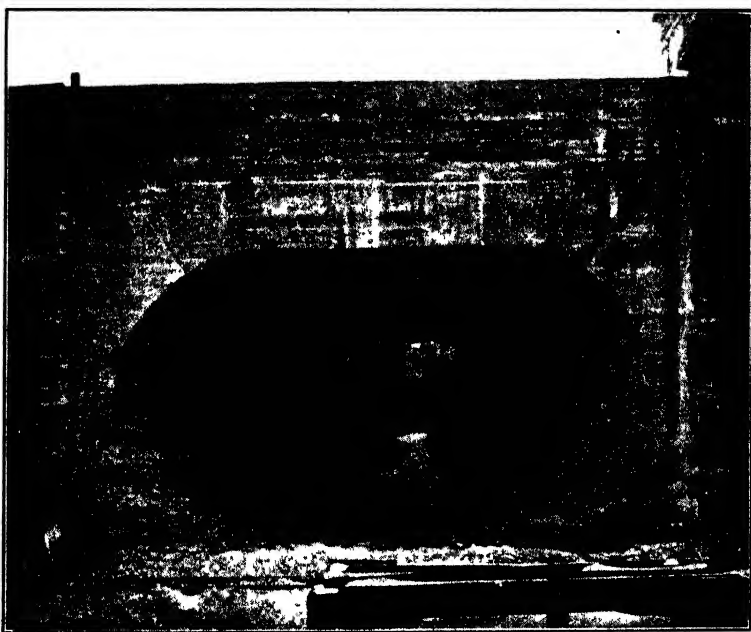

FIG 61 —Draft tube with quarter turn

The tube should preferably be straight but where the setting does not permit of enough room for this without excessive cost of excavation the tube is often turned so as to discharge horizontally as in Fig. 61. If the tube is large in diameter it may be necessary to make the horizontal portion of some other section than circular as in Fig. 62, in order that the vertical dimension may not be too great. A good form of section to use is oval.

The draft tube is commonly made as a frustum of a cone with a

vertex angle of  $8^\circ$ . If the section becomes some other shape, the tube is so made that the area increases at a similar rate to what it would if it were circular. The conical form has been largely employed chiefly because of ease of manufacture, but when draft tubes are moulded in concrete other forms may be used. A form that is theoretically good is "trumpet shaped," somewhat as in Fig. 60, so that the velocity of the water may be made to decrease uniformly along the length of the tube. In any event the draft tube should be so made as to secure a gradual reduction of velocity from the runner to the mouth.



(Courtesy of Wellman-Seaver-Morgan Co.)

FIG. 62.—Mouth of draft tube at Cedar Rapids.

The most recent innovation in draft tube construction is shown in Figs. 60 and 63. At the lower end of a comparatively short draft tube is a conoidal portion through which the water passes just before impinging on a circular plate which is concentric with the tube. The water turns and flows out along this plate around its entire circumference through an annular opening into a collecting chamber and from thence through a horizontal diverging tube to the tail race. As the water flows through the conoidal portion of the tube and impinges on the plate, its velocity is greatly reduced. This portion is called by the in-



ventor, W. M. White, a "hydraucone." As the water turns and flows through the annular opening, its velocity is increased and is then decreased again as it enters the collecting chamber. The velocity is still further decreased as the water flows to the tail race through the horizontal tube. A design by Lewis F. Moody differs from the above in that the collecting chamber is a spiral, somewhat like the spiral case, so proportioned that the water is continuously decelerated throughout the flow.

Bearing in mind that one function of the draft tube is to efficiently convert velocity head into pressure head, we see the

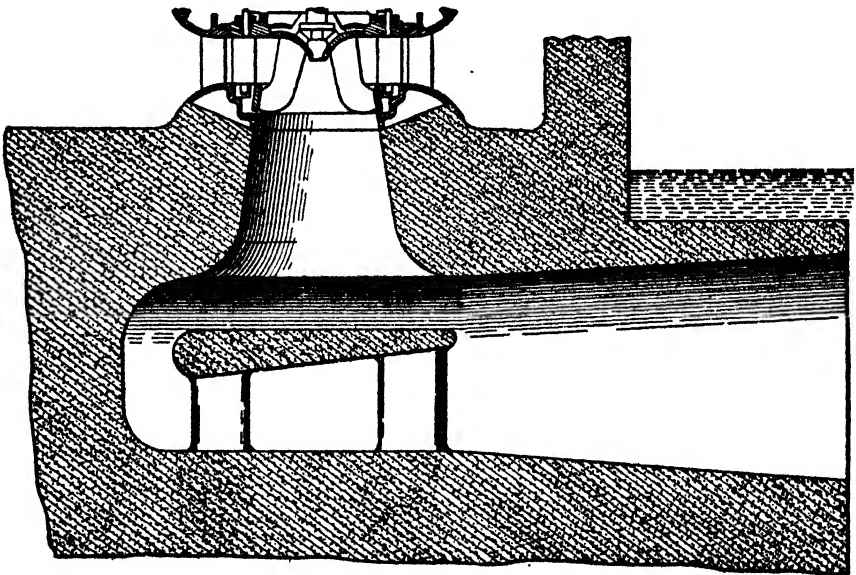

FIG. 63.—Draft tube with hydraucone.

limitations of the ordinary construction. In order to secure the diffusion desired, the length of the tube may be such that the expense of excavation is prohibitive and hence the tube is turned from vertical to horizontal with a bend of short radius. But such a bend inevitably induces eddy losses which interfere with the efficient performance of the tube. Furthermore velocity head cannot usually be converted into pressure head without a great deal of loss unless the flow of the water be smooth. Since the discharge from a turbine runner is usually quite turbulent, this alone would limit the value of a draft tube, even if it were straight. If the device just described is properly proportioned, then, as the result of hydrodynamic laws for which we have not

room here,<sup>1</sup> the flow may be turned from vertical to horizontal in a very small space with less loss of energy than otherwise. Another peculiarity of the hydraucone is that it can convert the velocity head of turbulent water into pressure head efficiently. Then when this water is accelerated, as it leaves through the annular opening, it flows away with smooth stream lines and is in proper shape for the ultimate conversion in the diverging horizontal tube. One of the things which limits the high-speed high-capacity type of runner is the inability of the draft tube to recover the kinetic energy of the water leaving the runner, especially in view of the fact that with this type the water leaves with some considerable "whirl." This new development may

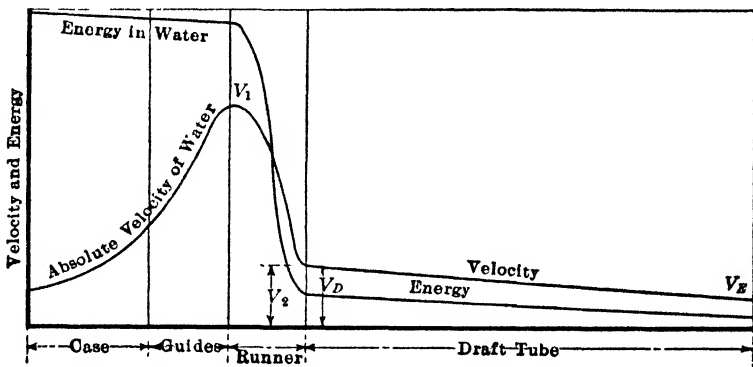

FIG. 64.—Velocity and energy transformations in turbine.

make it possible to extend the present limits of turbine runner design.

**44. Velocities.**—The velocities at different points are indicated by Fig. 64.<sup>2</sup> The velocity of flow in the penstock is determined by the consideration of the cost and other conditions in each case. The mean velocity of flow allowable in the turbine cash is as follows:

If the case is cylindrical the velocity should be as low as  $0.08$  to  $0.12\sqrt{2gh}$  where  $h$  is the effective head. If a spiral case is used the velocity may be from  $0.15$  to  $0.24\sqrt{2gh}$ . For heads of several hundred feet the value of  $0.15$  is used to reduce wear on the case,  $0.20$  is used for moderate heads, and  $0.24$  is used for low heads.

The velocity at entrance to the turbine runner,  $V_1 = 0.6$  to

<sup>1</sup> *The Journal of the Association of Engineering Societies*, vol. 27, p. 39.

<sup>2</sup> Mead's "Water Power Engineering."

$0.8\sqrt{2gh}$ . The velocity at the point of discharge,  $V_2 =$  from  $0.10$  to  $0.40\sqrt{2gh}$ . These values depend entirely upon the design of the turbine and are not arbitrarily assigned.

The velocity at entrance to the upper end of the draft tube should equal the velocity with which the water leaves the turbine, otherwise a sudden change in velocity will take place. Velocity of discharge from the lower end of the draft tube may be about  $0.10$  to  $0.15\sqrt{2gh}$ . The value of the latter is determined by the value of the velocity at the upper end and by the length and the amount of flare to be given the tube.

**45. Conditions of Use.**—The reaction turbine is best adapted for a low head or a relatively large quantity of water. As was stated in Art 32, the choice of a turbine is a function of capacity as well as head. For a given head the larger the horse-power the more reason there will be for using a reaction turbine.

The use of a reaction turbine under high heads is accompanied by certain difficulties. It is necessary to build a case which is strong enough to stand the pressure; also the case, guides, and runner may be worn out in a short time by the water moving at high velocities. This depends very much upon the quality of the water. Thus a case is on record where a wheel has been operating for six years under a head of 260 ft. with clear water and the turbine is still in excellent condition. Another turbine made by the same company and according to the same design was operated under a head of 160 ft. with dirty water. In four years it was completely worn out and was replaced with an impulse wheel. The tangential water wheel has the advantage that the relative velocity of flow over its buckets is less for the same head and thus the wear is less. Also repairs can be more readily made.

The runners of reaction turbines and the buckets of impulse wheels will not last long if their design is imperfect. This is due to the fact that wherever there is an eddy or wherever there is a point of extremely low pressure, the air that is in solution in the water will always tend to be liberated at that point. And as water tends to absorb more oxygen in proportion to nitrogen than is in the air, the result is that the liberated mixture is rich in oxygen and hence readily attacks and pits the metal. Fig. 6, page 5, shows a turbine runner that has had holes eaten in it because of this reason. Thus a defective design not only produces a runner of lower efficiency because of the eddy losses within the water, but such eddies shorten the life of the wheel.

Also great care should be used in designing so that the velocity along any stream line does not cause the pressure to approach the vapor pressure of the water too closely, otherwise the same action will take place. With the reaction turbine it is possible to design a runner free from eddies for one gate opening only. The operation of reaction turbines at part gate for long periods of time must inevitably shorten the life of the runner.

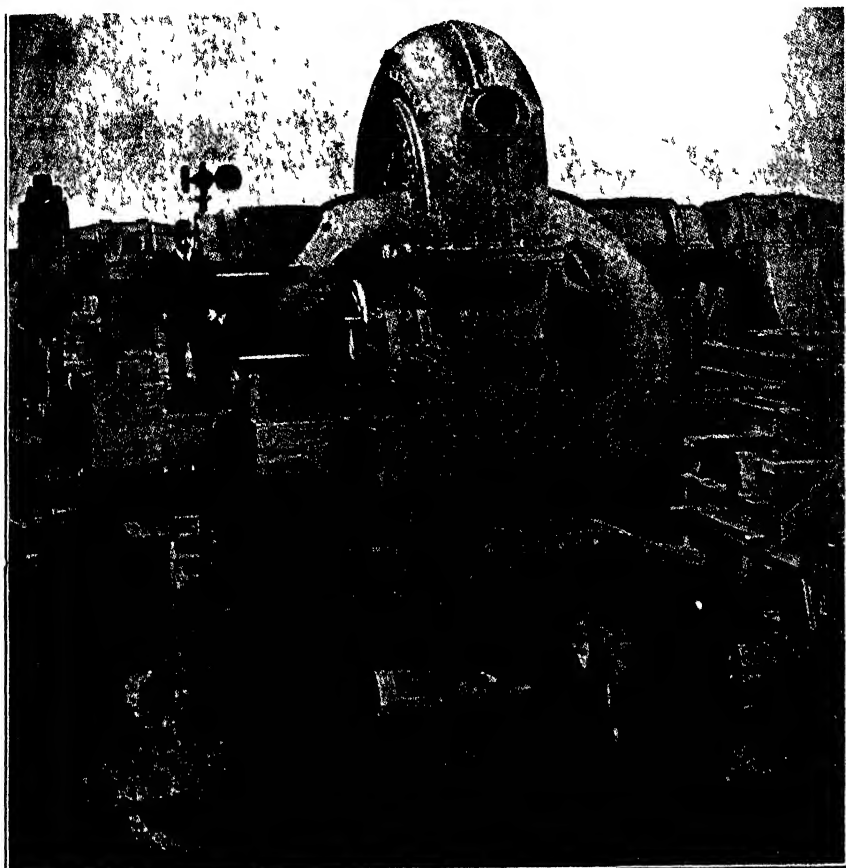

FIG. 65.—22,500 h.p. turbine for Pacific Coast Power Co.  
(Made by Allis-Chalmers Mfg. Co.)

Reaction turbines are used under very low heads in some instances. The lowest head on record is 16 in. but several feet is the usual minimum. The highest head yet employed for a reaction turbine is 800 ft. The latter is used for two 22,500 h.p. units built by the Pelton Water Wheel Co.

The most powerful turbine in the world will develop 52,500

h.p. Two such units, built by the Allis-Chalmers Mfg. Co., will be installed at the Chippewa Development of the Hydro-Electric Power Commission of Ontario. The head is 320 ft.

In Fig. 60 is shown a turbine of 37,500 h.p., which is similar in type to the above. This wheel runs under a head of 214 ft. and is for the Niagara Falls Power Co.

There are at present quite a number of turbines in operation whose power ranges from 20,000 to 30,000 h.p.

The power of a turbine depends not only upon its size but also upon the head under which it operates. The turbines above are the most powerful, but they are not the largest in point of size. The largest turbines so far are the 10,800 h.p. turbines of the Cedars Rapids (Canada) Mfg. and Power Co., which run at 56.6 r.p.m. under a head of 30 ft. The rated diameter is 143 in., but the maximum diameter (see Fig. 40) is 17 ft. 8 in. The runner weighs 160,000 lb., the revolving part of the generator and the shaft, 390,000 lb., while the suspension bearing weighs 300,000 lb. The total weight of the entire unit is 1,615,000 lb.

The largest runners in this country are those of the Mississippi River Power Co. at Keokuk, Ia. They develop 10,000 h.p. at 57.7 r.p.m. under a head of 32 ft. They are slightly smaller than those at Cedars Rapids. (See Figs. 42 and 47.) The I. P. Morris Co. built eight of these wheels and the Wellman-Seaver-Morgan Co. seven. These two concerns likewise built the Cedars Rapids turbines.

**46. Efficiency.**—The efficiency obtained from the average reaction turbine may be from 80 to 85 per cent. Under favorable conditions with large capacities higher efficiencies up to about 90 per cent. or more may be realized. For small powers or unfavorable conditions 75 per cent. is all that should be expected.

#### 47. QUESTIONS

1. What was the origin of the Fourneyron turbine? What is the Jonval turbine? What was the origin of the Francis turbine?

2. What is the Swain turbine? What is the McCormick turbine? Why were they developed? What is the modern Francis turbine? Why is this name attached to all inward flow turbines at present?

3. Sketch the profiles of different types of modern turbine runners and explain why they are so built.

4. Why has the inward flow turbine superseded the outward flow turbine?

5. How does the angle  $\alpha_1$  vary with different types of runner and why? How does the factor  $\phi$ , vary and why?

6. For a given head and diameter of runner explain how the power varies with different types. For a given head and power explain how the rotative speed varies.

7. Draw typical vector diagrams for the velocities at entrance to the different types of turbine runners. Show how the vane angle varies.

8. How are turbine runners constructed? What materials are used? What classes of runners are there?

9. What are the different kinds of gates used for governing reaction turbines, and what are their relative merits?

10. What means are provided to save the penstock from water hammer, when the gates of a reaction turbine are quickly closed? How are the gates of a turbine operated?

11. What kinds of bearings are used for horizontal shaft turbines? For vertical shaft turbines? What means may be provided to take care of end thrust in either type?

12. What types of cases are used for turbines? What are the cheapest forms and what are the best? What are speed rings?

13. What is the purpose of a draft tube and how are they constructed?

14. What different factors may cause a turbine runner to wear out? Under what range of heads are reaction turbines now used?

15. What horsepower is developed by the most powerful turbine? What is the largest in point of size? Why is not the largest one also the most powerful? What efficiencies should be expected from reaction turbines?

## CHAPTER VI

### TURBINE GOVERNORS

**48. General Principles.**—All governors depend primarily upon the action of rotating weights. Thus the governor head in Fig. 66 is rotated by some form of drive so that its speed is directly proportional to that of the machine which it regulates. The higher the speed of rotation, the farther the balls stand from the axis, and the higher will the collar be raised on the vertical spindle. The collar in turn transmits motion to some element of the mechanism which effects the speed regulation.

Let  $W$  be the weight of each ball,  $2KW$  that of the center weight,  $h$  the height of the “cone” in inches,  $x$  the ratio of the

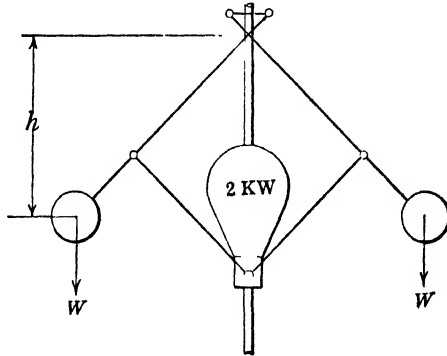

FIG. 66.—Governor head.

velocity of the collar to the vertical velocity of the balls, and  $N$  the revolutions per minute of the governor head. Also let the force which opposes the motion of the collar, due to the friction of the moving parts of the governor mechanism actuated by it, be denoted by  $2fW$ . Then the following equation may be found to hold:

$$N^2h = 35,200 [1 + x(K \pm f)].$$

Considering the right hand member of the above as constant for the moment, it may be seen that for every value of  $h$  there must be a definite value of  $N$ . For different loads on the machine it

is necessary that the gates and gate mechanism occupy different positions and, if this requires different positions of the collar of the governor head, it may be seen that the speed must decrease as the load increases.<sup>1</sup>

If the change of speed from no load to full load be denoted by  $\Delta N$  and  $N$  be interpreted as the average speed, the coefficient of speed regulation is  $\Delta N/N$ . This coefficient may be reduced to a very small value by careful design of the governor. The essentials of a good governor are:

1. Close regulation or a small value of  $\Delta N/N$ .
2. Quickness of regulation.
3. Stability or lack of hunting.
4. Power to move parts or to resist disturbing forces.

To some extent certain of these requirements conflict with others

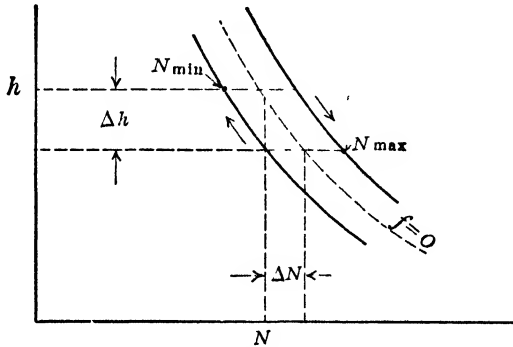

FIG. 67.

so that the final design is something of a compromise. Close regulation may be obtained by so proportioning the arms that  $x$  is a variable in such a way as to permit  $h$  to change but little for the different collar positions. Stability and power may be secured by making the center weight,  $2KW$ , sufficiently heavy. This weight is often replaced by a spring, which exerts an equivalent force. The importance of a large value of  $K$  is seen when we consider its relation to the friction. The latter changes sign according to the direction of motion, and may also change

<sup>1</sup> A constant speed or asynchronous governor could be constructed by so arranging it that  $h$  remained constant as the balls changed their position, but such a governor would lack stability as it might be in equilibrium with the collar in any position for a given speed. Then or a slight change in speed the governor would move over to its extreme position which would be limited by a stop. Such governors have been built, however, and are practicable if a strong dash pot is used to prevent their "hunting."



in value from time to time, so that the larger the value of  $K$  the smaller will be the effect of friction, and the closer together will the two curves of Fig. 67 be. We can also see the great necessity for keeping  $f$  as small as possible, and this requirement leads us to the use of the relay governor.

The operation of the nozzles of impulse wheels or of the gates of reaction turbines requires a considerable force to be exerted. The governor head could not do this directly without being of prohibitive size and hence it does nothing more than set some relay device into action, the latter furnishing the power to operate the regulating mechanism.

**49. Types of Governors.**—There are two fundamental types of water wheel governors:

(a) Mechanical governors.

(b) Hydraulic governors.

With the first type the governor head causes some form of clutch to be engaged so that the gates are operated by the power of the turbine itself. This is the least expensive but has the disadvantage that the operation of the gates adds just that much more to a demanded load. The second type of governor costs more but is always used in the best plants. The governor head in this case merely operates a pilot valve which admits a liquid under pressure to one side or the other of a piston in a cylinder. This piston and cylinder is known as the servo-motor and operates the gates.

The liquid used to operate the servo-motor is stored under air pressure in a tank into which it is pumped. The power for operating the gates also comes from the turbine in this instance but it is spread over the entire period of operation instead of being concentrated just when the load is changing. Oil is commonly used as the working fluid and is very satisfactory except for its cost. Some effort, which is meeting with success, is being made to produce emulsions consisting principally of water but which will be similar to oil in its action. If water alone is used, it should be carefully filtered and circulated over and over again. Occasionally water has been used under penstock pressure and, of course direct from the penstock, but the grit and sediment in it is very bad for the operating parts of the governor.

**50. The Compensated Governor.**—It has already been pointed out in Art. 26 that the inertia of the water in the penstock and

draft tube makes close speed regulation difficult, since often the immediate result of a change of gate position is directly opposite to that desired. With the simple type of governor the latter would continue to operate in the same direction under these circumstances and would thus move far beyond the proper point. Finally when the hydraulic conditions would readjust themselves the governor would then be compelled to move back, but would this time pass to the other side of the proper place. Thus the governor would continually "hunt" and maintain a constant oscillation of flow in the pipe line.

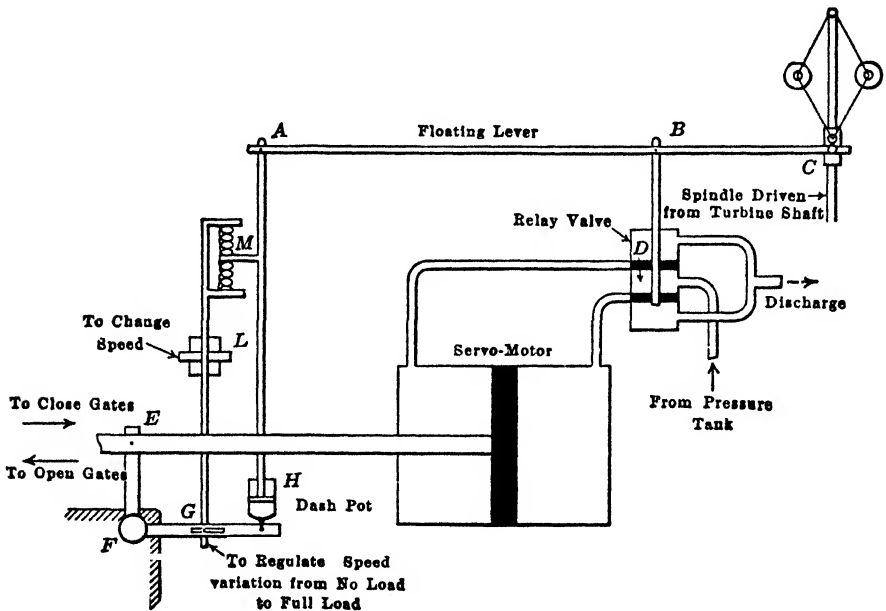
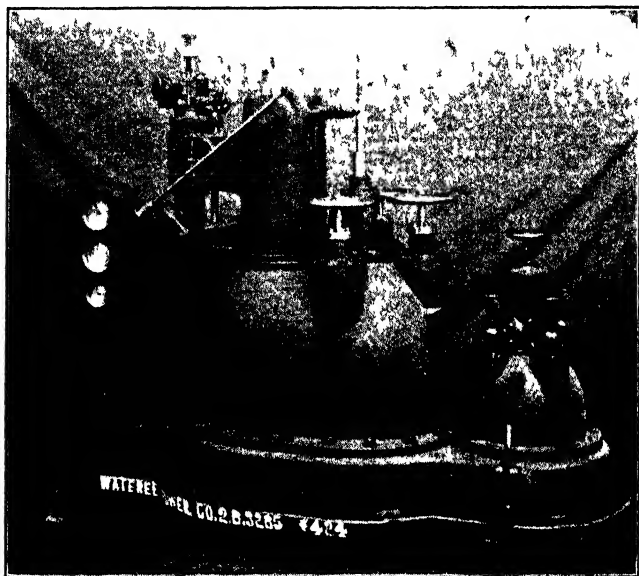

Fig. 68.—Compensated floating lever governor.

To prevent such action a waterwheel governor is usually "compensated" so that it will slowly approach its proper place and practically remain there. Such a governor is also said to be "dead beat." In Fig. 68 may be seen the essential features of the floating-lever compensated governor. If, for example, the wheel speed increases, the balls of the governor raise the collar, C, to which is attached the floating lever. The latter for the moment pivots about A and through the link at B raises the relay valve, D. This action admits oil (or other fluid) to the left-hand side of the servo-motor piston and exhausts it from the right-hand side, thus compelling the piston to move to the right and decrease the turbine gate opening. But at the same time

the bell-crank *EFG*, which is attached to the gate connecting rod at *E*, is rotated about *F* so the arm *G* is lowered. This pulls down the pivot *A*, which causes *B* to be lowered, thus closing the relay valve ports and stopping the motion. Thus the governor is prevented from over-travelling. Of course, if the gates have not been moved far enough, this action can be repeated.

The dash pot, *H*, will not cause the pivot *A* to be moved unless the governor acts quickly. If the governor changes slowly, there is little need for the compensating action and hence the dash pot does not then transmit the motion. But there is a



(Courtesy of Allis-Chalmers Mfg Co.)

Fig 69 —Hydraulic turbine governor

second rod from *G* which is connected with the other vertical rod by springs at *M*. This will serve to stop the motion in such a case though it does not move *A* as much, since it has a shorter radius arm.

For a given speed of the governor head, and hence for a given position of the collar *C*, moving *A* will tend to shift the relay valve and hence change the position of the turbine gates. But if the turbine gates are changed, without any corresponding change in load, the turbine speed will vary. The length of the rod from *G* to *M* is adjustable by turning a wheel *L* into which the two ends of the rods are fitted with right and left handed threads. Hence the speed of the turbine can be varied within

certain limits by  $L$ , which is convenient for synchronizing, for instance. Generally  $L$  is turned by a very small electric motor which can be operated from the switchboard.

At full-load on the turbine the servo-motor piston is at the opposite end of the stroke from no-load and hence the pivot  $A$  has a corresponding vertical travel. The amount of this travel can be altered by changing the radius of the connection at  $G$ . Considering  $B$  as fixed (as it must be if the relay valve is closed in both cases) it is evident that changing the amount of travel of  $A$  will change the amount of travel of the collar  $C$ . Remembering that different positions of collar  $C$  correspond to definite values of  $N$ , it is clear that changing the amount of travel of the collar  $C$  from no-load to full-load will vary the speed regulation.

Other adjustments that can be made to secure the proper degree of sensitiveness for the hydraulic conditions are to vary the springs at  $M$  and to change the speed of the dash pot.

One of the recent changes in governor construction for vertical type turbines is to mount the rotating weight on the turbine shaft itself. This eliminates any lost motion between the turbine and governor head.

### 51. QUESTIONS

1. With the usual type of governor, why must the speed vary to a slight extent from no-load to full-load? Which way does the speed change as the load increases? Why?
2. What qualifications are essential in a good governor and how may they be obtained? What is the effect of friction on the operation of the governor?
3. Why is the speed range for a decreasing load different from that for an increasing load? What is the purpose of the center weight or the spring loading in governors?
4. What is a relay governor? Why is it necessary for water wheels? How is it operated?
5. What are the relative merits of different types of relay governors? What are the relative merits of the fluids used in hydraulic governors?
6. What is the compensated governor? Why is it necessary? Describe the action of one?
7. Describe the adjustments that can be made on a floating lever governor.

## CHAPTER VII

### GENERAL THEORY

**52. Equation of Continuity.**—In a stream with steady flow (conditions at any point remaining constant with respect to time) the equation of continuity may be applied. This is that the rate of discharge is the same for all cross-sections so that  $q = AV = av = \text{constant}$ , and in particular

$$q = A_1V_1 = a_1v_1 = a_2v_2 \quad (1)$$

**53. Relation between Absolute and Relative Velocities.**—The absolute velocity of a body is its velocity relative to the earth. The relative velocity of a body is its velocity relative to some other body which may itself be in motion relative to the earth. The absolute velocity of the first body is the vector sum of its velocity relative to the second body and the velocity of the second body. The relation between the three velocities  $u, v, V$  is shown

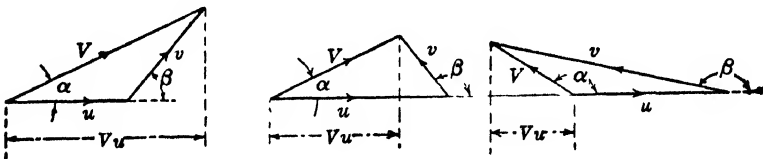

FIG. 70.—Relation between relative and absolute velocities.

by the vector triangles in Fig. 70. The tangential component of  $V$  is

$$V_u = V \cos \alpha = u + v \cos \beta \quad (2)$$

**54. The General Equation of Energy.**—Energy may be transmitted across a section of a flowing stream in any or all of the three forms known as potential energy, kinetic energy, or pressure energy.<sup>1</sup> Since head is the amount of energy per unit weight of water, the total head at any section

$$H = z + \frac{V^2}{2g} + \frac{p}{w} \quad (3)$$

<sup>1</sup> L. M. Hoskins, "Hydraulics," Chapter IV.

There can be no flow without some loss of energy so that the total head must decrease in the direction of flow by the amount of head lost or

$$H_1 - H_2 = \text{Head lost} \quad (4)$$

Suffixes (1) and (2) may here denote any two points.

In flowing through the runner of a turbine the water gives up energy to the vanes in the form of mechanical work and a portion of the energy is lost in hydraulic friction and is dissipated in the form of heat. Thus the head lost by the water equals  $h'' + h'$ . And if suffixes (1) and (2) are restricted to the points of entrance to and discharge from the runner, equation (4) may be written

$$\left(z_1 + \frac{V_1^2}{2g} + \frac{p_1}{w}\right) - \left(z_2 + \frac{V_2^2}{2g} + \frac{p_2}{w}\right) = h'' + h' \quad (5)$$

**55. Effective Head on Wheel.**—Obviously the turbine should not be charged up with head which is lost in the pipe line, so the

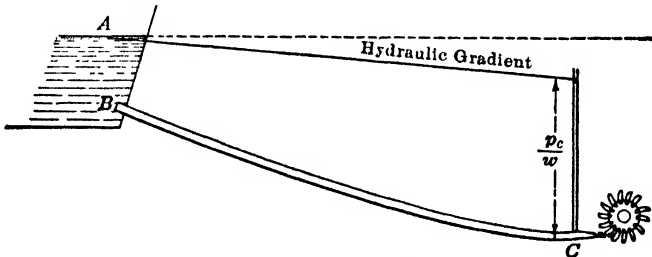

FIG. 71.—Effective head for tangential water wheel.

value of  $h$  should be the total fall available minus the penstock losses. Thus if  $Z$  is total fall available from head water to tail water,  $H'$  the head lost in the penstock or other places outside the water wheel, and  $h$  the net head actually supplied the turbine, we have

$$h = Z - H' \quad (6)$$

The head supplied to the impulse wheel in Fig. 71 is the head measured at the base of the nozzle. Thus for the tangential water wheel

$$h = H_c = \frac{p_c}{w} + \frac{V_c^2}{2g} \quad (7)$$

The reaction turbine, shown in Fig. 72, is able to use the total fall to the tail-water level by virtue of its employment of the draft tube. Hence the total head supplied to the wheel at  $C$

is measured above the tail-water level as a datum plane. Thus for the reaction turbine

$$h = H_c = z_c + \frac{p_c}{w} + \frac{V_c^2}{2g} \quad (8)$$

The turbine with its draft tube, which in a sense is as much an appurtenance of the runner as the guide vanes, is here charged with the total amount of the energy supplied to it. The kinetic energy of the water at discharge from the mouth of the draft tube  $E$  is a loss for which the runner and draft tube may be said to be responsible in part, though some loss there is inevitable, but the trouble is that the setting of the turbine, over which the turbine builder has little control, limits the design of the draft tube and

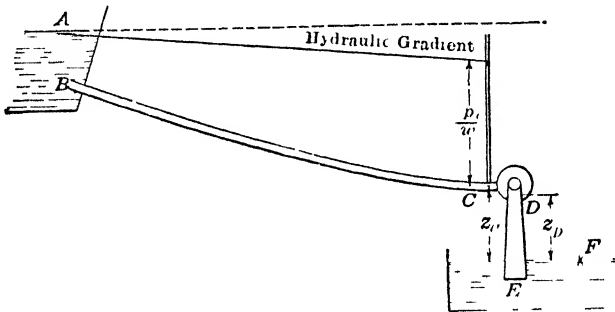

FIG. 72.—Effective head for reaction turbine.

hence the manufacturer may not be able to reduce this discharge loss to a desired value. Two similar runners installed under different settings might yield different efficiencies because of this. Consequently turbine builders desire some method which will make the measured efficiency of a runner independent of the conditions of the setting over which their designers have no control. This second method is to charge up the turbine with all losses within the draft tube but to credit it with the velocity head at the point of discharge. Thus

$$h = H_c - H_E = z_c + \frac{p_c}{w} + \frac{V_c^2}{2g} - \frac{V_E^2}{2g} \quad (9)$$

It is believed that equation (8) is rational and scientifically correct, but that equation (9) may be commercially more desirable.<sup>1</sup> In general the actual numerical difference between the values of  $h$  computed by these two methods will be small.

<sup>1</sup> For discussion on this point see "Investigation of the Performance of a

**56. Power and Efficiency.**—Since head is the amount of energy per unit weight of water it follows that by multiplying by the total weight of water per unit time we have energy per unit time and this is power. Thus

$$\text{Power} = WH = \text{pounds per second} \times \text{feet} \quad (10)$$

In this expression  $H$  may be interpreted as in (3) or it may be replaced by  $h''$  or any other head according to what is wanted.

But also power equals force applied times the velocity of the point of application. Thus

$$\text{Power} = Fu = \text{pounds} \times \text{feet per second} \quad (11)$$

where  $F$  represents the total force applied.

Torque,  $T$ , equals  $F \times r$  and angular velocity  $\omega = \frac{u}{r}$

Since then  $Fu = T\omega$  it is evident that

$$\text{Power} = T\omega = \text{foot pounds per second} \quad (12)$$

Any of these three expressions for power may be used according to circumstances. While (11) is the most obvious to many, it will be found that in hydraulics (10) is usually more convenient.

(The following simplifications for horsepower of a turbine are convenient. Using the  $h$  of Art. 55,

$$\text{B.h.p.} = 62.5 qhe/550 = qhe/8.8.$$

For estimations, the value of the efficiency may be assumed as 0.80 in which case our expression becomes  $\text{h.p.} = qh/11.$ )

The word "efficiency" is always understood to mean total efficiency. It is the ratio of the developed or brake power to the power delivered in the water to the turbine based on the head  $h$  of Art. 55.

Reaction Turbine," by R. L. Daugherty, *Trans. Am. Soc. of C. E.*, vol. 78, p. 1270 (1915).

It may be noted that it might be desirable under some circumstances to eliminate the draft tube losses altogether and compute the efficiency of the runner alone. This would necessitate the measurement of the head at  $D$  in order to take the difference between it and the head at  $C$ . The practical difficulty here is that, due to the turbulent and often rotary motion of the water at this point, it is impossible to measure the pressure with any degree of accuracy. Likewise the velocity head cannot be computed, since the actual velocity under the conditions of flow will not be equal to the rate of discharge divided by the cross-section area. This same consideration holds in regard to the computation of the velocity head at  $E$ .



Mechanical efficiency is the ratio of the power delivered by the machine to that delivered to its shaft by the runner. The difference between these two powers is that due to mechanical losses.

Hydraulic efficiency is the ratio of the power actually delivered to the shaft to that supplied in the water to the runner. The difference between these two is due to hydraulic losses.

Volumetric efficiency is the ratio of the water actually passing through the runner to that supplied. The difference between these two quantities is the leakage through the clearance spaces.

The total efficiency is the product of these three. Thus

$$e = e_m \times e_h \times e_v.$$

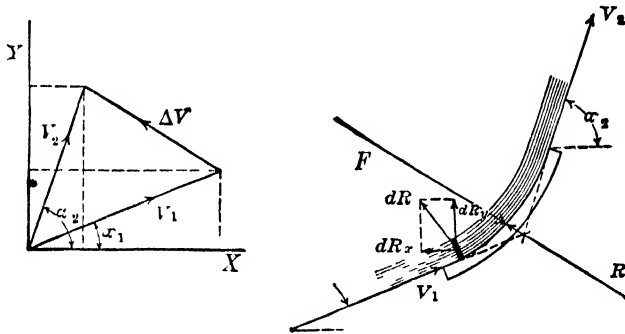

FIG. 73.

**57. Force Exerted.**—Whenever the velocity of a stream of water is changed either in direction or in magnitude, a force is required. By the law of action and reaction an equal and opposite force is exerted by the water upon the body producing this change. This is called a dynamic force.

Let  $R$  be the resultant force exerted by any body upon the water and  $R_x$  and  $R_y$  be its components parallel to  $x$  and  $y$  axes. Also let us here consider  $\alpha$  as the angle made by  $V$  with the  $x$  axis. The force exerted by the water upon the body will be denoted by  $F$ . Its value may be found in either of the two ways shown below. The first depends upon the principle that the resultant of all the external forces acting on a body is equal to the mass times the acceleration or  $R = m \frac{dV}{dt}$ . The second is based upon the principle that the resultant of all the external

forces acting on a body or system of particles is equal to the time rate of change of momentum of the system or  $R = \frac{d(mV)}{dt}$ .

(a) *Force Equals Mass Times Acceleration.*—Let  $dR$  be the force exerted upon the elementary mass shown in Fig. 73. Let the time rate of flow be  $dm/dt$ , where  $m$  denotes mass. Then in an interval of time  $dt$  there will flow past any section the mass  $(dm/dt) dt$ , which will be the amount considered. Thus

$$dR = dm \frac{dV}{dt} = \left( \frac{dm}{dt} \cdot dt \right) \frac{dV}{dt} = \frac{dm}{dt} \left( \frac{dV}{dt} \cdot dt \right)$$

Our discussion will be restricted to the case where the flow is steady in which case  $dm/dt$  is constant and equal to  $W/g$ . Therefore, since  $(dV/dt)dt = dV$ ,

$$dR = \frac{W}{g} dV.$$

The summation of all such forces along the vane shown will give the total force. But, since integration is an algebraic and not a vector summation and in general these various elementary forces will not be parallel, it is necessary to take components along any axes. Thus

$$R_x = \frac{W}{g} \int_1^2 dV_x = \frac{W}{g} V_x \Big|_1^2$$

Now at point (1) the value of  $V_x$  is  $V_1 \cos \alpha_1$  and at (2) it is  $V_2 \cos \alpha_2$ . Inserting these limits and noting from Fig. 72 that  $V_2 \cos \alpha_2 - V_1 \cos \alpha_1 = \Delta V_x$ , we have

$$R_x = \frac{W}{g} (V_2 \cos \alpha_2 - V_1 \cos \alpha_1) = \frac{W}{g} \Delta V_x$$

(b) *Force Equals Time Rate of Change of Momentum.*—Consider the filament of a stream in Fig. 74 which is between two cross sections  $M$  and  $N$  at the beginning of a time interval  $dt$ , and between the cross-sections  $M'$  and  $N'$  at the end of the interval. Denote by  $ds_1$  and  $ds_2$  the distances moved by particles at  $M$  and  $N$  respectively. Let  $A_1$  be the cross-section area at  $M$ ,  $V_1$  the velocity of the particles, and  $\alpha_1$  the angle between the direction of  $V_1$  and any convenient  $x$  axis. Let the same letters with subscript (2) apply at  $N$ .

At the beginning of the interval the momentum of the portion of the filament under consideration is the sum of the momentum

of the part between  $M$  and  $M'$  and that of the part between  $M'$  and  $N$ . At the end of the interval its momentum is the sum of the momentum of the part between  $M'$  and  $N$  and that of the part between  $N$  and  $N'$ . In the case of steady flow and with the vane at rest or moving with a uniform velocity in a straight line, the momentum of the part between  $M'$  and  $N$  is constant. Hence the change of momentum is the difference between the momentum of the part between  $N$  and  $N'$  and that of the part between  $M$  and  $M'$ . Noting that  $wA_1ds_1 = wA_2ds_2$ , since the flow is steady, the change in the  $x$  component of the momentum during  $dt$  is then

$$\frac{wA_1ds_1}{g} (V_2 \cos \alpha_2 - V_1 \cos \alpha_1).$$

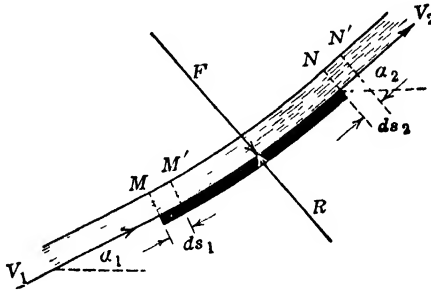

FIG. 74.

If the rate of flow be denoted by  $W$  (lb. per sec.), then

$$wA_1ds_1 = Wdt$$

and the time rate of change of the  $x$  component of the momentum is

$$\frac{W}{g} (V_2 \cos \alpha_2 - V_1 \cos \alpha_1).$$

Thus the  $x$  component of the resultant force is

$$R_x = \frac{W}{g} (V_2 \cos \alpha_2 - V_1 \cos \alpha_1) = \frac{W}{g} \Delta V_x.$$

This method has the advantage that it may be extended to the case where the flow is unsteady, if desired. In this event the two masses at the ends would be unequal and the momentum of the portion from  $M'$  to  $N$  would be variable. In the case of a series of vanes on a rotating wheel running at a uniform angular velocity the momentum of the water on any one vane

will be changing. But for the wheel as a whole, the momentum of the water on all the vanes will be constant so long as the flow is steady.

The method in (a) pictures the total force as the vector sum of all the elementary forces along the path of the stream. The method in (b) shows that the total force is independent of the path and depends solely upon the initial and terminal conditions.

Since the force exerted by the water upon the object is equal and opposite to  $R$ , we have

$$F_x = \frac{W}{g} (V_1 \cos \alpha_1 - V_2 \cos \alpha_2) = -\frac{W}{g} \Delta V_x \quad (13)$$

In a similar manner the  $y$  component of  $F$  will be

$$F_y = \frac{W}{g} (V_1 \sin \alpha_1 - V_2 \sin \alpha_2) = -\frac{W}{g} \Delta V_y \quad (14)$$

Since  $F = \sqrt{F_x^2 + F_y^2}$  and  $\Delta V = \sqrt{\Delta V_x^2 + \Delta V_y^2}$ , the value of the resultant force is

$$F = \frac{W}{g} \Delta V \quad (15)$$

The direction of  $R$  will be the same as that of  $\Delta V$  and the direction of  $F$  will be opposite to it. It is because  $F$  and  $\Delta V$  are in opposite directions that the minus sign appears in the last members of equations (13) and (14). Note that  $\Delta V$  is the *vector difference* between  $V_1$  and  $V_2$ .

**58. Force upon Moving Object.—**

The force exerted by a stream upon any object may be computed by the equations of the preceding article, whether the object is stationary or moving. The principal difference is that in the latter case the determination of  $\Delta V$  may be more difficult. Thus in Fig. 75 assume the initial velocity of the stream  $V_1$ , the velocity of the object  $u_1$ , the angle between them  $\alpha_1$ , and the shape of the object to be given. The relative velocity  $v_1$  can be determined by the vector triangle. Its direction is also determined by this triangle and is not necessarily the same as that of the vane or object struck by the water. But the direction of the relative velocity of the water leaving is determined by the shape of the object, since  $v_2$  is tangent to the surface

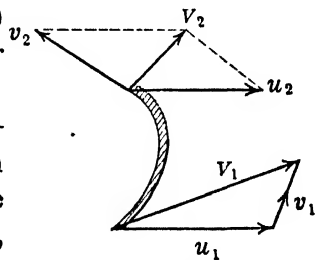

FIG. 75.

at this point. The magnitude of  $v_2$  may be some function of  $v_1$ . Then knowing  $u_2$ , which is not necessarily equal to  $u_1$  however, the magnitude and direction of  $V_2$  can be computed from the vector triangle. The  $\Delta V$  desired is the vector difference between  $V_1$  and this  $V_2$ .

In case the stream is confined so that its cross-section is known, the magnitude of  $v_2$  may be computed directly from the equation of continuity.

The remaining difficulty is the one of determining the amount of water acting upon the body per unit time. The rate of discharge in the stream flowing upon the object is  $A_1V_1$  so that  $W = wA_1V_1$ . But this may not be the amount of water striking the object per second. For instance if the object is moving in



FIG. 76.—View showing action of jet on several buckets.

the same direction as the water and with the same velocity, it is clear that none of the water will strike it. The amount of water which will flow over any object is proportional to the velocity of the water relative to the object itself. If we denote by  $W'$  the pounds of water striking the moving object per second, and by  $a_1$  the cross-section area normal to  $v_1$ , then  $W' = wa_1v_1$ .

If we consider a wheel with a number of vanes acted upon by the water, the above is true for one vane only. The reason that less water strikes one vane per second than issues from the nozzle in the same time is that the vane is moving away from the nozzle and thus there is an increasing volume of water between the two. But for the wheel as a whole the entire amount of water may be used, since one vane replaces another so that the volume of water

from the nozzle to the wheel remains constant. If one vane uses less water than is discharged from the nozzle in any given time interval and yet the wheel as a whole uses the entire amount of water, it means that the water must be acting upon more than one bucket at the same instant. This is shown in Fig. 76.

**59. Torque Exerted.**—When a stream flows through a turbine runner in such a way that its distance from the axis of rotation remains unchanged, the dynamic force can be computed from the principles of Art. 57. But when the radius to the stream varies, it is not feasible to compute a single resultant force. And, if it were, it would then be necessary to determine the location of its line of action in order to compute the torque exerted by it. Hence we find the total torque directly by other means.

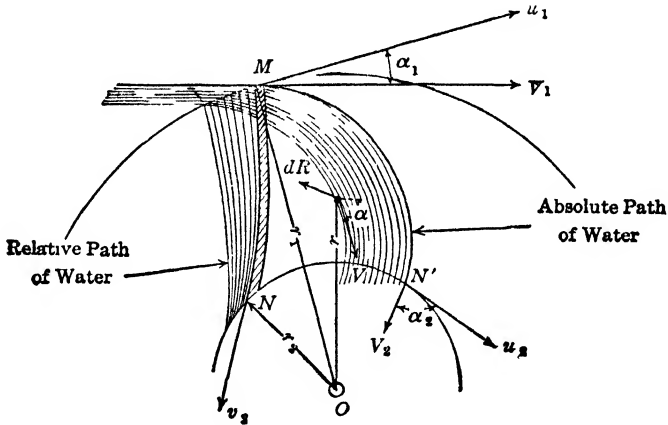

FIG 77.

A fundamental proposition of mechanics is that the time rate of change of the angular momentum (moment of momentum) of any system of particles with respect to any axis is equal to the torque of the resultant external force on the system with respect to the same axis.<sup>1</sup>

In Fig. 77 let  $MN$  represent a vane of a wheel which may rotate about an axis  $O$  perpendicular to the plane of the paper. Water enters the wheel at  $M$  and, since the wheel is in motion, by the time the water arrives at  $N$  on the vane that point of the vane will have reached position  $N'$ . Thus the absolute path of the water is really  $MN'$ .

<sup>1</sup> See the author's "Hydraulics," Art. 112. This proposition is analogous to force = time rate of change of momentum, but here we deal with moments on both sides.

Let us consider an elementary volume of water forming a hollow cylinder, or a portion thereof, concentric with  $O$ . Let the time rate of mass flow be  $dm/dt$ . Then in an interval of time  $dt$ , there will flow across any cylindrical section the mass  $(dm/dt)dt$ . Let this be the mass of the elementary volume of water we are to consider. Let the radius to this elementary cylinder be  $r$ . Only the tangential component of the velocity will appear in a moment equation, hence the angular momentum of this cylinder of water will be mass  $\times$  radius  $\times$  tangential velocity or  $(dm/dt) dt \times r \times V \cos \alpha$ , and the time rate of change of momentum, which is equal to torque, will be

$$dT' = \left(\frac{dm}{dt} dt\right) \frac{d(rV \cos \alpha)}{dt} = \left(\frac{dm}{dt}\right) \cdot d(rV \cos \alpha).$$

In the case of steady flow  $(dm/dt)$  is constant and equal to  $W/g$  and

$$T' = \frac{W}{g} \int_1^2 d(rV \cos \alpha).$$

Integrating between limits we have the value of the torque exerted by the wheel upon the water, or by changing signs, the value of the torque  $T$  exerted by the water upon the wheel. Thus

$$T = \frac{W}{g} (r_1 V_1 \cos \alpha_1 - r_2 V_2 \cos \alpha_2) \quad (16)$$

Representing the tangential component of the velocity of the water, often called the "velocity of whirl," by  $V_u$ , since it is in the direction of  $u$ , we have

$$T = \frac{W}{g} (r_1 V_{u1} - r_2 V_{u2}) \quad (17)$$

It is immaterial in the application of this formula whether the water flows radially inward, as in Fig. 76, radially outward, or remains at a constant distance from the axis. In any event  $r_1$  is the radius at entrance and  $r_2$  is that at exit.

A shorter method of proving the above is analogous to method (b) of Art. 57. During an interval of time  $dt$  the wheel has received angular momentum at  $M$  of  $dmr_1 V_1 \cos \alpha_1$  and given up angular momentum at  $N'$  of  $dmr_2 V_2 \cos \alpha_2$ , assuming the flow to be steady. And, since  $dm = (W/g)dt$  for steady flow, the time rate of change of angular momentum is  $(W/g)(r_1 V_1 \cos \alpha_1 - r_2 V_2 \cos \alpha_2)$ .

It is also possible to consider  $F_x$  of equation (13) to be made up of two forces concentrated at the points of entrance and exit. The former is  $(W/g)V_1 \cos \alpha_1$  at radius  $r_1$  and the latter is  $(W/g)V_2 \cos \alpha_2$  at radius  $r_2$ . Taking the moments of these two tangential forces, we get equation (16) at once.

**60. Power and Head Delivered to Runner.**—If the flow is steady and the speed of the wheel uniform, an expression for the power developed by the water is readily obtained. From Art. 56

$$\text{Power} = Wh'' = T\omega.$$

Using the value of  $T$  given by (16) and noting that  $r\omega = u$ ,

$$\text{Power} = Wh'' = \frac{W}{g} (u_1 V_1 \cos \alpha_1 - u_2 V_2 \cos \alpha_2) \quad (18)$$

This is the power actually developed on the runner by the water. It is analogous to the indicated power of a steam engine. The power output of the turbine is less than this by an amount equal to the friction of the bearings and other mechanical losses, such as windage or the disk friction of a runner in water in the clearance spaces.

Eliminating the  $W$  from the equation above we have the head actually utilized by the runner. Thus

$$h'' = e_h h = \frac{1}{g} (u_1 V_{u1} - u_2 V_{u2}) \quad (19)$$

As just seen, the hydraulic efficiency is equal to  $h''/h$ . The net head  $h$  supplied to the turbine is used up in the following ways:

$$h = h'' + k \frac{V_2^2}{2g} + m \frac{V_2^2}{2g} + k'' \frac{V_1^2}{2g} \quad (20)$$

Of these items  $h''$  is the head converted into mechanical work, the second term represents the energy dissipated in the form of heat due to internal friction and eddy losses within the runner, the third term is the kinetic energy lost at discharge, and the fourth term represents the loss in the nozzle of a Pelton wheel or the case and guides of a reaction turbine. The factor  $m$  in the above may be unity in the case of an impulse wheel or a reaction turbine without a diverging or proper draft tube. For a reaction turbine with an efficient draft tube it will be less than unity.

**61. Equation of Energy for Relative Motion.**—Using the value of  $h''$  given by (19) in (5) we have

$$\left( z_1 + \frac{V_1^2}{2g} + \frac{p_1}{w} \right) - \left( z_2 + \frac{V_2^2}{2g} + \frac{p_2}{w} \right) = \frac{1}{g} (u_1 V_{u1} - u_2 V_{u2}) + h'$$



All of the absolute velocities will be replaced in terms of relative velocities as follows:

$$\begin{aligned} V_1^2 &= v_1^2 + u_1^2 + 2u_1v_1 \cos \beta_1 \\ V_2^2 &= v_2^2 + u_2^2 + 2u_2v_2 \cos \beta_2 \\ V_{u_1} &= u_1 + v_1 \cos \beta_1 \\ V_{u_2} &= u_2 + v_2 \cos \beta_2 \end{aligned}$$

The substitution of these values gives us

$$\left( z_1 + \frac{v_1^2 - u_1^2}{2g} + \frac{p_1}{w} \right) - \left( z_2 + \frac{v_2^2 - u_2^2}{2g} + \frac{p_2}{w} \right) = h' \quad (21)$$

This equation serves to establish a relation between points (1) and (2). If the wheel is at rest  $u_1$  and  $u_2$  become zero,  $v_1$  and  $v_2$  become absolute velocities and equation (21) becomes the equation of energy in its usual form as in (4).

**62. Impulse Turbine.**—The following numerical solution is given to illustrate the application of the foregoing principles. This impulse turbine is of the outward flow type known as the

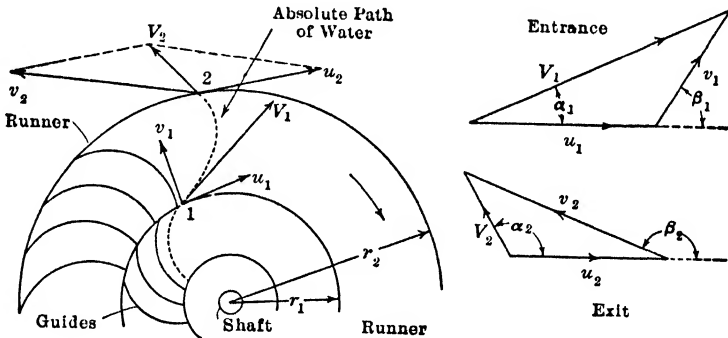

FIG. 78.—Outward flow turbine.

Girard turbine. Obviously the direction of flow makes no difference in the theory.

By construction,  $\alpha_1 = 18^\circ$ ,  $\beta_2 = 165^\circ$ ,  $r_1 = 2.0$  ft.,  $r_2 = 2.5$  ft. The hydraulic friction loss in flow through the runner will be taken as proportional to the square of the relative velocity so that  $h' = k \frac{v_2^2}{2g}$ , where  $k$  is an empirical constant. Assume  $k = 0.4$ . Suppose  $h = 350$  ft.,  $N = 260$  r.p.m.,  $q = 100$  cu. ft. per second. Find relative velocity at entrance to runner, relative velocity and magnitude and direction of absolute velocity at exit from runner, head utilized by wheel, hydraulic efficiency, losses, and the horsepower. (See Fig. 78.)

$$V_1 = \sqrt{2gh} = 8.025\sqrt{350} = 150 \text{ ft. per second.}$$

$$u_1 = 2\pi r_1 N/60 = 54.4 \text{ ft. per second.}$$

$$u_2 = (r_2/r_1)u_1 = 68.0 \text{ ft. per second.}$$

By trigonometry  $v_1 = 99.55 \text{ ft. per second.}$

Suppose the flow is in a horizontal plane so that  $z_1 = z_2$ . Since it is an impulse turbine the pressure throughout the runner will be atmospheric. Thus  $p_1 = p_2$ .

Equation (21) then becomes

$$\begin{aligned} (1+k)v_2^2 &= v_1^2 + u_2^2 - u_1^2 \\ 1.4 v_2^2 &= 9910 + 4624 - 2960 = 11,574 \\ v_2 &= 90.9 \text{ ft. per second.} \end{aligned}$$

By trigonometry  $V_2 = 30.6 \text{ ft. per second, } \alpha_2 = 130^\circ$

$$V_{u_1} = V_1 \cos \alpha_1 = 150 \times 0.951 = 143$$

$$V_{u_2} = u_2 + v_2 \cos \beta_2 = 68.0 - 90.9 \times 0.966 = -19.7$$

$$\text{(Also } V_{u_2} = V_2 \cos \alpha_2 = 30.6 \times (-0.639) = -19.7)$$

$$h'' = \frac{1}{g} (u_1 V_{u_1} - u_2 V_{u_2})$$

$$= \frac{1}{32.2} (54.4 \times 143 + 68 \times 19.7) = 283 \text{ ft.}$$

Hydraulic efficiency =  $h''/h = 283/350 = 0.81$ .

$$\text{Hydraulic friction loss} = k \frac{v_2^2}{2g} = 0.4 \frac{8270}{64.4} = 51.3 \text{ ft.}$$

$$\text{Discharge loss} = \frac{V_2^2}{2g} = \frac{940}{64.4} = 14.6 \text{ ft.}$$

$$\text{Power} = \frac{Wh''}{550} = \frac{100 \times 62.5 \times 283}{550} = 3220 \text{ h.p.}$$

**63. Reaction Turbine.**<sup>1</sup>—Another numerical case will be given to illustrate the application of the foregoing principles to the reaction turbine. The turbine used here is the Fourneyron or outward flow type, though the theory applies to any type.

By construction,  $\alpha_1 = 18^\circ$ ,  $\beta_2 = 165^\circ$ ,  $r_1 = 2.0 \text{ ft.}$ ,  $r_2 = 2.5 \text{ ft.}$ ,  $A_1 = 1.36 \text{ sq. ft.}$ ,  $a_2 = 1.425 \text{ sq. ft.}$  Assume  $k = 0.2$  ( $h' = k \frac{v_2^2}{2g}$ ).

<sup>1</sup> See Art. 8. If the area  $a_2$  is made small enough the wheel passages will be completely filled with water under pressure. We then have a reaction turbine. Note that

$$H_1 = \frac{V_1^2}{2g} + \frac{p_1}{w}, \text{ so that } V_1 \text{ is not equal to } \sqrt{2gH_1}.$$

Suppose  $h = 350$  ft.,  $N = 525$  r.p.m., and  $q = 164.5$  cu. ft. per second. Find head utilized by turbine, hydraulic efficiency, losses, pressure at guide outlets (entrance to turbine runner), and the horsepower.

Since the wheel passages are completely filled the areas of the streams,  $A_1$  and  $a_2$  are known, thus

$$V_1 = q/A_1 = 164.5/1.36 = 121 \text{ ft. per second.}$$

$$v_2 = (A_1/a_2) V_1 = 115.5 \text{ ft. per second.}$$

For the above r.p.m.  $u_1 = 110$  ft. per second,  $u_2 = 137.5$  ft. per second.

$$V_{u1} = V_1 \cos \alpha_1 = 115.$$

$$V_{u2} = u_2 + v_2 \cos \beta_2 = 137.5 - 115.5 \times 0.966 = 26.0.$$

$$h'' = \frac{1}{g} (u_1 V_{u1} - u_2 V_{u2}) = \frac{1}{32.2} (110 \times 115 - 137.5 \times 26) = 282 \text{ ft.}$$

$$\text{Hydraulic efficiency} = 282/350 = 0.805.$$

$$\text{Hydraulic friction loss} = k \frac{v_2^2}{2g} = 0.2 \frac{13350}{64.4} = 41.5 \text{ ft.}$$

$$\text{By trigonometry } V_2 = 38.8 \text{ ft. per second.}$$

$$\text{Discharge loss} = \frac{V_2^2}{2g} = \frac{1505}{64.4} = 23.4 \text{ ft.}$$

Since  $v_2$  is determined by the area  $a_2$  we do not have the use for equation (21) that we did in the case of the impulse turbine. By it, however, we can compute the difference in pressure between entrance to and discharge from the runner. Thus from (21), taking  $z_1 = z_2$ ,

$$\frac{p_1}{w} - \frac{p_2}{w} = \frac{(1+k)v_2^2 - u_2^2 - v_1^2 + u_1^2}{2g} = 122 \text{ ft.}$$

(If the turbine discharges into the air then  $\frac{p_2}{w} = 0$  and  $\frac{p_1}{w} = 122$  ft.) This pressure difference may also be computed from equation (5).

$$\text{Power} = \frac{Wh''}{550} = \frac{62.5 \times 164.5 \times 282}{550} = 5270 \text{ h.p.}$$

**64. Effect of Different Speeds.**—If a wheel is run at different speeds under the same head, the quantities  $v_1$ ,  $v_2$ ,  $V_2$ ,  $\alpha_2$ ,  $h''$ , efficiency, and power all vary. In Fig. 79 may be seen the velocity diagrams for entrance and discharge from a wheel at five

different speeds from standstill to run-away and photographs<sup>1</sup> of the wheel at these speeds. The relations for a reaction turbine would be very similar to these for the impulse wheel. The most important change is that in the quantities  $\alpha_2$  and  $V_2$ . When the wheel is at rest,  $\alpha_2 = \beta_2$  and  $V_2 = v_2$ . As the speed increases  $\alpha_2$  decreases, passes through  $90^\circ$ , and approaches  $0^\circ$ . The value of  $V_2$  decreases to a minimum and then increases again.

From equation (20) it may be seen that, other losses being equal, the maximum efficiency would be obtained when the discharge loss is a minimum. It can be seen that  $V_2$  is very small when either  $v_2 = u_2$  or  $\alpha_2 = 90^\circ$ . A means of computing the speed necessary for this will be given later. Neither of these gives the actual mathematical minimum but they are very close to it.

The torque exerted on the wheel by the water may be seen to decrease as the wheel speed increases. In equation (17)  $W$  and  $V_{u1}$  are practically constant, though they vary slightly in the case of the reaction turbine. But  $V_{u2}$  continuously increases algebraically. It has its maximum negative value when the wheel is at standstill, it is zero when the speed is such that  $\alpha_2 = 90^\circ$ , and it attains its maximum positive value when the turbine is at run-away speed. This is the maximum speed which the wheel can reach under a given head and is attained when all external load is removed. Under these circumstances the torque exerted by the water is just sufficient to overcome the mechanical losses of the turbine. The run-away speed of the wheel is thus strictly limited by hydraulic conditions.

In the ideal case the maximum possible speed of the Pelton wheel would be when the velocity of the buckets equalled the velocity of the jet. But under these conditions  $\Delta V$  of equation (15) would equal zero. Consequently the wheel must run at a speed somewhat less than this as some power is required to overcome the mechanical losses at this speed. For the impulse wheel the maximum value of  $\phi$  usually attained is about 0.80 at run-

<sup>1</sup> These photos also show the needle in the center of the jet. The piece at the side of the buckets toward the lower right hand side of the case is the "stripper," its function being to deflect water that might otherwise be carried around with the wheel up into the upper part of the case. The buckets pass through this with a relatively small clearance. A close inspection of the views of the wheels and the water leaving it will give one a fair idea of the variation in velocities.

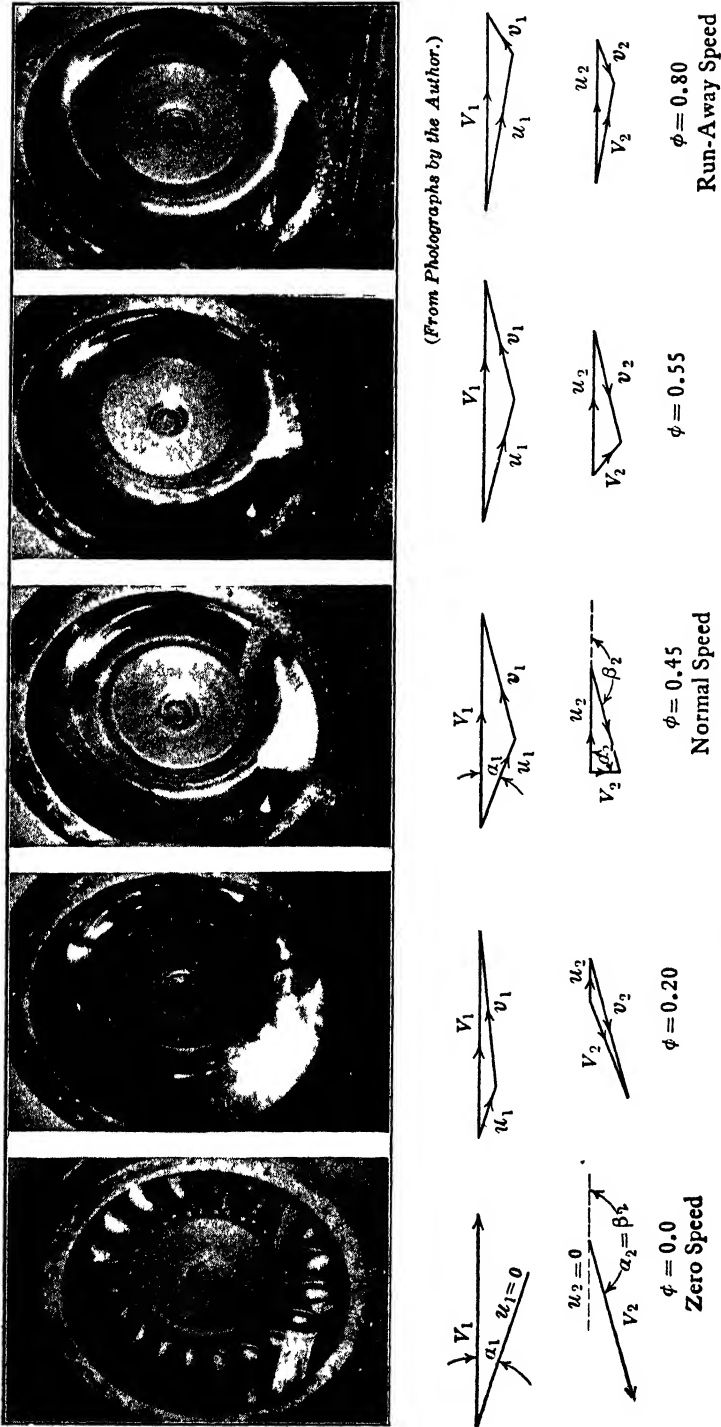

FIG. 79.—42" Impulse wheel at different speeds under same head.

away. For the reaction turbine it is about 1.3. The relations in the latter case are somewhat more complex but are similar to those for the Pelton type.

**65. Forced Vortex.**—A *forced* vortex is produced when a liquid is compelled to rotate by means of external forces applied to it. Thus, if the vessel  $XY$  of Fig. 80, is rotated about the axis  $O-O$ , the water filling the vessel will tend to rotate at the same speed with it and we will have a forced vortex.

The pressure within this body of water will then vary as shown by the curve  $CD$ . The law of variation may be found as follows

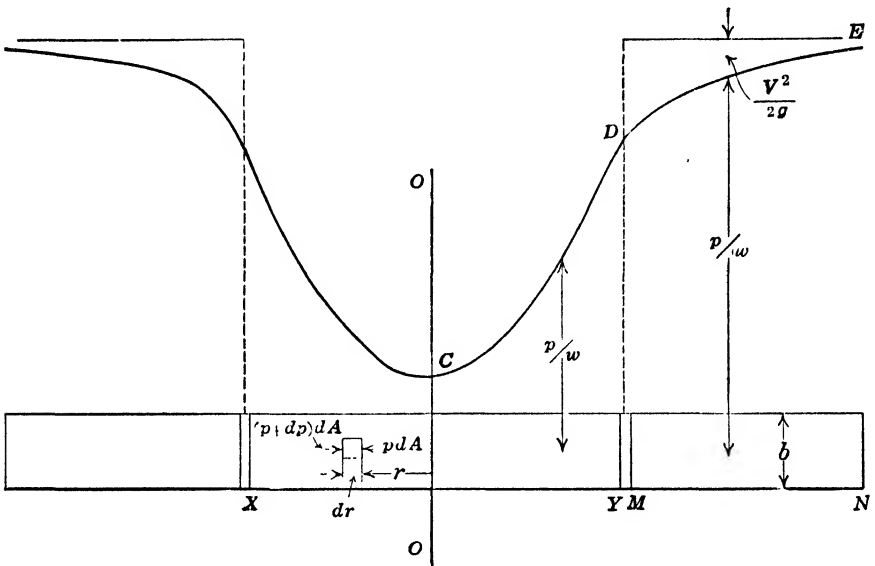

FIG. 80.—Forced and free vortices.

Consider an elementary volume, whose length along the radius is  $dr$  and whose area normal to this is  $dA$ , and which rotates at an angular velocity  $\omega$  at radius  $r$ . The difference in the pressures on the two faces, which is the resultant force acting, is equal to  $dp \times dA$ , and the acceleration of the mass is  $\omega^2 r$ , directed toward the axis of rotation. Thus

$$\begin{aligned} dp dA &= (w dA dr / g) \omega^2 r \\ dp &= (w \omega^2 / g) r dr \\ p &= (w \omega^2 / g) r^2 / 2 + \text{constant.} \end{aligned}$$

To find the value of the constant of integration, let  $p_0$  be the pressure when  $r$  equals zero. Thus the constant is equal to  $p_0$ , and

$$\begin{aligned} \frac{p}{w} &= \frac{r^2\omega^2}{2g} + \frac{p_0}{w} \\ &= \frac{u^2}{2g} + \frac{p_0}{w} \end{aligned} \quad (22)$$

From this it may be seen that the curve is a parabola. If the vessel is open, but with sides high enough so that the water cannot overflow, the surface of the water will become a paraboloid, since the pressure variation along the radius is the same whether the water be confined or not.

This equation is really a special case of equation (21) with  $v_1$  and  $v_2$  equal to zero, since there is no flow of water. If water flows then equation (21) must be employed. Flow may occur in either direction. It may be noted that the energy of the water is not constant along the radius, as both the pressure and the velocity of the water increase. This is possible because, due to the action of external forces, energy is being delivered to (or taken from) the water.

An important application of equations (21) and (22) is in connection with the centrifugal pump. The vessel  $XY$  of Fig. 80 may be said to be a crude illustration of the impeller of such a pump. But the equations are also of value in determining the conditions of flow through turbine runners, of either the impulse or reaction type.

**66. Free Vortex.**—A *free* vortex is produced when a liquid rotates by virtue of its own angular momentum, previously derived from some source, and is free from the action of external forces. Thus in Fig. 80, if the rotating vessel  $XY$  is surrounded by a stationary vessel  $MN$  into which the water can pass from  $XY$ , the water will still tend to rotate and, neglecting friction, we will have a free vortex.

The pressure within the free vortex will vary as shown by the curve  $DE$ . The law of variation may be found as follows: Since no external forces are applied, the resultant torque exerted is zero, and hence the angular momentum is constant (Art. 59). Since angular momentum is proportional to  $rV \cos \alpha$  or  $rV_u$ , it follows that

$$rV \cos \alpha = rV_u = \text{constant} \quad (23)$$

the value of the constant being the value obtained from the numerical value of these factors at the point of entrance.

Considering the radial component of the velocity  $V_r$ , we have

$q = 2\pi rb \times V_r = \text{constant}$ , from the equation of continuity. Hence

$$rbV \sin \alpha = rbV_r = \text{constant} \quad (24)$$

the value of this constant being proportional to  $q$ .

The total velocity  $V$  is the resultant of these two components so that

$$V^2 = V_u^2 + V_r^2 \quad (25)$$

Since no energy is delivered to (or taken from) the water, the value of the effective head  $H$  must remain constant. Thus

$$H = z + \frac{V^2}{2g} + \frac{p}{w} = \text{constant},$$

the value of this constant being determined by the total head of the water initially. Taking the datum plane such that  $z = 0$ , we have

$$\frac{p}{w} = H - \frac{V^2}{2g} = H - \frac{V_u^2}{2g} - \frac{V_r^2}{2g} \quad (26)$$

The flow of the water may be in either direction. Actual friction losses will modify the resulting values of the pressure and also of  $V_u$ , but cannot alter  $V_r$ . If  $b$  is constant,  $V_u$  and  $V_r$  vary in the same proportion, neglecting friction, so that  $\alpha$  is constant and the path of the water is the equi-angular or logarithmic spiral.

The free vortex is found in the casing surrounding the impeller of some types of centrifugal pumps. It is also found in the water in a spiral case approaching a turbine runner, and the above equations have many applications.

For example equations (23), (24), and (25) show that the velocity of the water varies inversely as the radius of curvature of its path. Hence if the vanes of turbine runners are so shaped that the stream lines have sharp curvatures, the velocity of the water will be excessive and, from equation (26), it may be seen that the pressure will be reduced. This may result in the pressure becoming so low that erosion will result, as mentioned in Art. 45. For the same reason it is undesirable to let the water discharged from a turbine runner flow direct toward the axis, as in the pure radial inward flow turbine. For if the water leaving the runner had any "whirl" this would increase as the axis was approached and, according to the equation, would become infinity, while the pressure would be



minus infinity, when the radius equalled zero. While these limits could not be reached, the vaporization of the water that would actually take place would induce corrosion and also cause additional eddy losses. Hence the water is turned at discharge as has been shown in Fig. 34, page 43, and the central space is often taken up with a cone.

**67. Theory of the Draft Tube.**—The flow of water through a draft tube is no different in principle from the flow through any

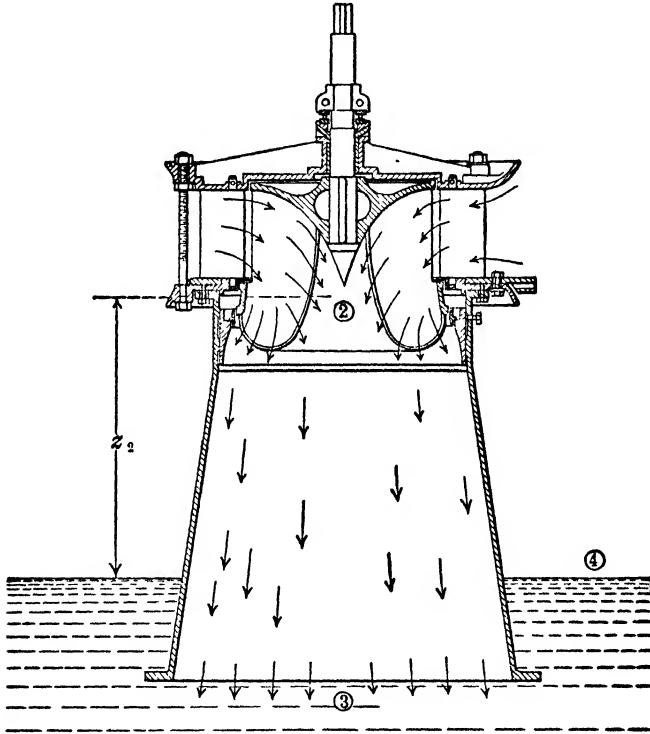

FIG. 81.

other conduit and hence Bernoulli's theorem, otherwise known as the general equation of energy of Art. 54, may be applied to it. Equation (4) however has been stated only for the case of steady flow and for the present purpose we are concerned with any condition of flow that may exist. Hence we shall add another term called the acceleration head, which is the head necessary to accelerate the velocity of the water when the rate of discharge is changed by the action of the governor. Let this head be denoted by  $h_{acc}$ , while the loss of head in friction,  $H'$ , is divided into its two separate factors,  $h_f$  the friction loss in the tube, and

$V_3^2/2g$ , the velocity head lost at discharge from the mouth of the draft tube. Thus referring to Fig. 81, we have

$$H_2 = z_2 + \frac{V_2^2}{2g} + \frac{p_2}{w}$$

$$H_4 = 0 + 0 + \frac{p_a}{w}$$

where  $p_2$  denotes absolute pressure and  $p_a$  denotes atmospheric pressure. Then

$$H_2 - H_4 = H' + h_{acc}$$

Or

$$z_2 = \frac{p_a}{w} - \frac{p_2}{w} - \frac{V_2^2}{2g} + h_f + \frac{V_3^2}{2g} + h_{acc} \quad (27)$$

The solution of this equation will give the allowable height of the turbine runner above the tail-water level. Or the equation can equally well be used to determine the pressure for any given elevation. In the above,

$\frac{p_a}{w}$  is governed by the altitude and local variations but is approximately equal to 34 ft. of water.

$\frac{p_2}{w}$  cannot be less than the vapor pressure of the water at that temperature as determined from the steam tables and should be from at least 2 to 4 ft. of water more.

$V_2$  is a function of the design and type of the runner. The higher the capacity and speed of the type the higher will be the value of  $V_2$ . It is also a function of the head under which the turbine runs, because all velocities vary as the square root of the head. Also if  $\alpha_2$  is not  $90^\circ$ , the value of  $V_2$  will be greater than  $q$  divided by draft tube area.

$h_f$  depends upon the construction of the draft tube. Ordinarily it may be assumed as about 15 to 25 per cent. of  $V_2^2/2g$ .

$V_3$  is controlled by the setting of the plant for that fixes the allowable length of the draft tube. It is also a function of the construction of the draft tube and the head under which the turbine operates.

$h_{acc}$  is determined by the action of the governor and it may be either plus or minus in value. The negative value is the one to use in the above equation.

It can be seen from the foregoing that two types of turbines with different discharge velocities would have different limiting

values of  $z_2$  under the same head. And the same runner would also require a lower setting under a higher head because of the change in this same item.

If the turbine is set higher than the limiting value, as determined by this equation, the efficiency of conversion in the draft tube will be lost due to the vaporization and subsequent recondensation of the water. Also corrosion of the runner will take place because of the liberation of oxygen. Again if the height is very close to the allowable limit for steady flow, the sudden closure of the turbine gates by the governor may cause the pressure at discharge from the runner to drop to such a low value that the water vaporizes. But an instant later the water will surge back up the draft tube, striking the runner a decided blow.

### 68. QUESTIONS AND PROBLEMS

1. How is the effective head to be measured on the Pelton wheel and on the reaction turbine? Why are two values possible in the latter case? What are the definitions of the various efficiencies that may be dealt with?

2. What is the procedure for computing the force exerted by a stream upon a moving object? What are the reasons for the difference between  $W$  and  $W'$ ?

3. What becomes of the total energy supplied in the water to the wheel? As the speed of a wheel varies, under a constant head, the torque exerted on it, and consequently its power, varies. Since the power supplied in the water is constant, what becomes of the difference between the two?

4. What are the fundamental differences between the solution of the problem of the impulse wheel and of the reaction turbine?

5. As the speed of a wheel changes how do  $V_2$  and  $\alpha_2$  vary? Of what significance is this? What limits the maximum speed of a Pelton wheel under a given head?

6. What is a forced vortex? How does the pressure vary in it? What examples of it are found?

7. What is a free vortex? How does the velocity vary in it? How does the pressure vary? What common examples of this are found?

8. What conclusions can one draw from the equations for the free vortex that have an important practical application?

9. Derive the equation for the maximum allowable height of a turbine runner and discuss the items that affect this value?

10. What is the effect of the action of the governor upon the conditions within the draft tube? What will be the effect if a turbine runner is set too high?

11. In the test of a reaction turbine the following readings were taken (see Fig. 72): Pressure at entrance,  $p_C/w = 126.6$  ft.,  $z_C = 12.6$  ft., diameter at  $C = 30$  in., diameter at  $E = 60$  in., and rate of discharge = 44.5 cu. ft. per second. Compute the head on the turbine by each of the two methods given.

*Ans.* 140.5 ft.

12. A jet of water 2 in. in diameter and with a velocity of 100 ft. per second issues from a nozzle on the end of a 6-in. pipe and strikes a flat plate normally. Find: (a) Power of jet, (b) thrust exerted on pipe, (c) force exerted on plate.

*Ans.* (a) 38.4 h.p., (b) 376 lb., (c) 423 lb.

13. Suppose the jet in problem (12) strikes a vane which deflects it  $60^\circ$  without loss of velocity. Find (a) component of force in direction of jet, (b) component normal to jet, (c) magnitude and direction of total force. Solve also assuming the terminal velocity to be reduced to 80 ft. per second, all other factors remaining the same.

*Ans.* (a) 211 lb., (b) 365 lb., (c) 422 lb. at  $60^\circ$  with  $V_1$ .

(a) 254 lb., (b) 293 lb., (c) 388 lb. at  $49^\circ 08'$ .

14. Solve problem (13) assuming the angle of deflection to be  $180^\circ$ . What difference does the angle make in the magnitude of each force? What difference is there in the effect of friction in each instance?

*Ans.* (a) 844 lb., (b) 0, (c) 844 lb. at  $0^\circ$  with  $V_1$ .

(b) 760 lb.

15. Suppose the vane in problem (14) moves in the same direction as the jet with a velocity  $u$ , and that friction loss is such that  $v_2 = 0.8v_1$ . When  $u$  has values of 0, 30, 44.4, 70 and 100 ft. per second, find: (a) Values of the lb. of water per second striking the vane, (b) values of absolute velocity at discharge, (c) values of the force exerted.

*Ans.* (a) 136.3, 95.3, 75.7, 40.8, and 0 lb. per second.

(b)  $-80, -26, 0, +46$ , and  $+100$  ft. per second.

(c) 760, 372, 234, 68.5, and 0 lb.

16. Solve problem (15) if the jet is upon a wheel equipped with similar vanes. Find the power delivered to the shaft at each speed. What becomes of the difference between this and the power of the jet?

*Ans.* 760, 532, 422, 228, and 0 lb.

0, 29.0, 34.0, 29.0, and 0 h.p.

17. For a turbine runner,  $V_1 = 70$  ft. per second,  $V_2 = 20$  ft. per second,  $r_1 = 2$  ft.,  $r_2 = 3$  ft.,  $\alpha_1 = 20^\circ$ ,  $\alpha_2 = 80^\circ$ , and  $W = 300$  lb. per second. (a) Find torque exerted upon the wheel. (b) If  $u_1 = 50$  ft. per second, find the power.

*Ans.* (a) 1128 ft. lb., (b) 51.3 h.p.

18. For a turbine runner,  $V_1 = 70$  ft. per second,  $V_2 = 20$  ft. per second,  $p_1/w = 25$  f.,  $p_2/w = -25$  ft. Assume friction loss  $(kv_2^2/2g)$  in flow through runner as 5.78 ft. and that there is no difference in elevation. (a) Find head utilized by runner, (b) If  $W = 300$  lb. per second, find the power.

*Ans.* (a) 94.2 ft., (b) 51.3 h.p.

19. For the impulse turbine in Art. 62 it will be found that  $v_2 = u_2$  when  $u_1 = 68.4$  ft. per second. Find the r.p.m., efficiency, losses, and horsepower. Compare with values given in Art. 62.

*Ans.* 326 r.p.m.,  $e = 0.845$ , 3365 h.p.

20. For the reaction turbine in Art. 63 it will be found that  $\alpha_2 = 90^\circ$  if  $u_1 = 86.3$  ft. per second. At that speed the rate of discharge will be found (by method given later) to be 159 cu. ft. per second. Find the r.p.m., efficiency, losses, and horsepower. Compare with values given in Art. 63.

*Ans.* 412 r.p.m.,  $e = 0.852$ , 5380 h.p.

21. Compare the best r.p.m. of the impulse turbine with the best r.p.m. of the reaction turbine in Problems (19) and (20). Compare the values of  $v_2$

in Problems (19) and (20). Why are these different? What effect has this upon the best speed?

**22.** Water enters the spiral case of a turbine with a velocity of 10 ft. per second. (a) Considering this velocity as tangential at a radius of 9 ft., which is the distance from the runner axis to the center of the case near the point of intake, what is the tangential component of the velocity at entrance to the speed ring vanes, the outer radius of which is 7 ft.? (b) If the height of the vanes at this point is 5 ft., find the radial component of the velocity if the turbine discharges 900 cu. ft. per second. (c) What should be the angle of the speed ring vanes at this point? (d) What should be the angle of entrance to the turbine guide vanes, if the radius is 6 ft., and the height is 3 ft.?  
*Ans.* (a) 12.85 ft. per second, (b) 4.09 ft. per second.

**23.** A turbine running under a head of 200 ft. is of such a design that  $V_2^2/2g = 7$  per cent. of  $h$  and  $V_3^2/2g = 1$  per cent. of  $h$ . If the minimum pressure allowable is 3 lb. per sq. in., what is the maximum height the runner may be set above the tail-water level, assuming the draft tube loss to be 25 per cent. and the maximum negative acceleration head to be 50 per cent. of  $V_2^2/2g$ ? What will be the result if this same turbine is used under a head of 50 ft.?  
*Ans.* 11.6 ft., 23.2 ft.

**24.** A turbine running under a head of 50 ft. is of such a design that  $V_2^2/2g = 20$  per cent. and  $V_3^2/2g = 2$  per cent. of  $h$ . If the minimum pressure allowable is 3 lb. per sq. in., what is the allowable height the runner may be set above tail-water level, assuming the draft tube loss to be 25 per cent. of  $V_2^2/2g$  and the maximum negative acceleration head to be 50 per cent. of  $V_2^2/2g$ ? Compare with second part of preceding problem.  
*Ans.* 15.6 ft.

## CHAPTER VIII

### THEORY OF THE TANGENTIAL WATER WHEEL

69. **Introductory.**—The tangential water wheel has been classed as an impulse turbine with approximately axial flow. The term tangential is applied because the center line of the jet is tangent to the path of the centers of the buckets. In this article the assumption will therefore be made that  $\alpha_1 = 0^\circ$  and that  $r_1 = r_2$ . It will be shown later that these assumptions are not entirely correct.

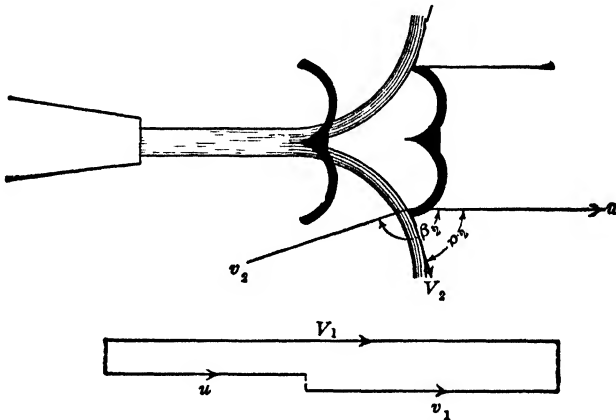

FIG. 82.

If the angle  $\alpha_1$  be assumed equal to zero then  $u_1$  and  $V_1$  are in the same straight line and  $v_1 = V_1 - u_1$ . The conditions at exit from the buckets are shown in Fig. 82. In applying equation 15 we desire to find only the component of the force tangential to the wheel since that is all that is effective in producing rotation. Therefore we shall find only the component of  $\Delta V$  along the direction of  $u_1$ . Thus, if  $F$  here denotes tangential force,

$$\begin{aligned} F &= \frac{W}{g} (V_1 - V_2 \cos \alpha_2) \\ &= \frac{W}{g} (V_1 - u_2 - v_2 \cos \beta_2) \end{aligned}$$

By equation (21) since  $z_1 = z_2$ ,  $p_1 = p_2$ ,  $u_1 = u_2$ ,  $(1 + k)v_2^2 = v_1^2$ ,

$$v_2 = \frac{v_1}{\sqrt{1+k}} = \frac{V_1 - u_1}{\sqrt{1+k}}$$

Substituting this value of  $v_2$  we obtain

$$F = \frac{W}{g} \left( 1 - \frac{\cos \beta_2}{\sqrt{1+k}} \right) (V_1 - u_1) \quad (28)$$

A more exact value for the force exerted may be found in Art. 72. The above is only an approximation.

Multiplying the force given above by the velocity of its point of application, we have the power developed. Thus

$$P = Fu_1 = \frac{W}{g} \left( 1 - \frac{\cos \beta_2}{\sqrt{1+k}} \right) (V_1 - u_1)u_1 \quad (29)$$

The power input to the wheel, including the nozzle, is  $Wh$ , where  $h$  is determined as in Art. 55. The power in the jet is  $WV_1^2/2g$  and is less than the former by the amount lost in friction in the nozzle.

Equation (28) is the equation of a straight line. It shows that  $F$  is a maximum when  $u_1$  is zero and that it decreases with the speed until it becomes zero when  $u_1 = V_1$ . Equation (29) is the equation of a parabola. It shows that the power is zero when  $u_1 = 0$  and again when  $u_1 = V_1$ . The vertex of the curve, which gives the maximum power and hence the maximum efficiency, is found when  $u_1 = 0.5V_1$ . Since in reality both of these curves are altered somewhat, when all the factors are considered, some of these statements require modification.

The actual speed for the highest efficiency has been found by test to be such that  $\phi_s = 0.45$  approximately, while the value of the efficiency is about 80 per cent. Both of these values vary somewhat with the design of the wheel and the conditions of use. But one can approximately compute the bucket speed and the power of any impulse wheel, provided the head and size of jet are known. The bucket speed  $u_1 = \phi\sqrt{2gh}$ , while the velocity of the jet  $V_1 = c_v\sqrt{2gh}$ . For a good nozzle with full opening, if equipped with a needle, the coefficient of velocity should be about 0.98. Thus the rate of discharge is determined. If the diameter of the wheel is known, or assumed as a function of the size of the jet, the rotative speed can be computed.

The reasons for the modifications of the simple theory given

above and an analysis of the characteristics of an actual wheel are given in the following parts of this chapter.

**70. The Angle  $\alpha_1$ .**—The angle  $\alpha_1$  is usually not zero as can be seen from Fig. 83. One bucket will be denoted by  $B$  and the bucket just ahead of it by  $C$ . Different positions of these buckets will be denoted by suffixes. The bucket enters the jet when it is at  $B_1$  and begins to cut off the water from the preceding bucket  $C_1$ . When the bucket reaches the position  $B_2$  the last drop of water will have been cut off from  $C_2$ , but there will be left a portion of the jet,  $MPXY$ , still acting upon it. The last drop of water  $X$  will have caught up with this bucket when it reaches position  $C_3$ . Thus while the jet has been striking it the bucket has turned

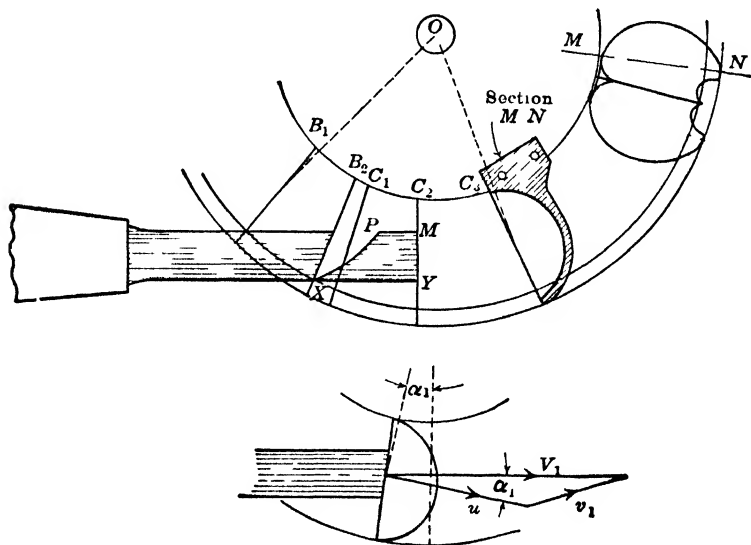

FIG. 83

through the angle  $B_1OC_3$ . The average value of  $\alpha_1$  will be taken as the angle obtained when the bucket occupies the mean between these two extreme positions. It is evident that position  $C_3$  will depend upon the speed of the wheel, and that the faster the wheel goes the farther over will  $C_3$  be. Thus the angle  $\alpha_1$  decreases as the speed of the wheel increases. The variation in the value of  $\alpha_1$  as worked out for one particular case is shown in Fig. 85.

**71. The Ratio of the Radii.**—It is usually assumed that  $r_1 = r_2$ . However inspection of the path of the water in Fig. 84 (a) will show that when the bucket first enters the jet  $r_2$  may be less than  $r_1$ . When the bucket has gotten further along  $r_2$  may be greater



than  $r_1$ . The value of  $x (= r_2/r_1)$  depends upon the design of the buckets, and its determination is a drafting-board problem which is not within the scope of this book. It is evident that a value of  $x$  must be a mean in the same way that a value of  $\alpha_1$  is a mean. And just as  $\alpha_1$  varies with the speed, so also does  $x$  vary with the speed. A little thought will show that when the wheel is running slowly compared with the jet velocity the value of  $x$  will be less than when the wheel is running at a higher speed. This may be verified by actual observation. When the wheel is running at its proper speed it is probably true that  $x$  is very nearly equal to unity. In any case the variation of the value of  $x$  from unity cannot be very great.

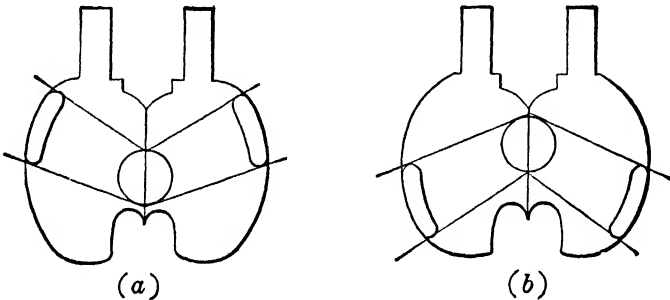

FIG. 84.—Radii for different bucket positions.

**72. Force Exerted.**—The force acting on the wheel may be determined by the principles of Art. 58, but, if the radii are not equal it will not be convenient to use equation (15) on account of the difficulty of locating the line of action of the force. However we can use equation (17) and by it determine a force at the radius  $r_1$  which shall be the equivalent of the real force. Dividing (17) by  $r_1$  and letting  $F$  denote tangential force we obtain

$$F = \frac{W}{g} (V_{u1} - xV_{u2})$$

$$V_{u1} = V_1 \cos \alpha_1$$

$$V_{u2} = u_2 + v_2 \cos \beta_2.$$

By equation (21)

$$(1 + k)v_2^2 = v_1^2 + u_2^2 - u_1^2.$$

By trigonometry

$$v_1^2 = V_1^2 - 2V_1u_1 \cos \alpha_1 + u_1^2.$$

Substituting this value of  $v_1$ , and with  $u_2 = xu_1$ ,

$$(1 + k)v_2^2 = V_1^2 - 2V_1u_1 \cos \alpha_1 + x^2u_1^2.$$

Substituting  $v_2$  from this in the expression for  $V_{u_2}$  we obtain

$$F = \frac{W}{g} \left[ V_1 \cos \alpha_1 - x^2u_1 - \frac{x \cos \beta_2}{\sqrt{1+k}} \sqrt{V_1^2 - 2V_1u_1 \cos \alpha_1 + x^2u_1^2} \right] \tag{30}$$

Equation (30) is a true expression for the force exerted. No great error is involved, however, by taking  $x = 1.0$ . If that is done the expression under the radical becomes the value of  $v_1$  and may be found graphically. For the sake of simplicity and ease in computation  $\alpha_1$  may be taken equal to zero and the equation then reduces to (28), but an exact value of  $F$  will not be obtained. There is little excuse for taking  $k = 0$ , as most writers do, for equation (28) is not simplified to any extent and the results are entirely incorrect.

**73. Power.**—With  $F$  as obtained from (30) the power is given by  $Fu_1$ . We may also compute  $h''$  and obtain the power by multiplying by  $W$ .

Since  $h'' = \frac{1}{g} u_1 (V_{u_1} - xV_{u_2})$  it is evident that the expression for  $h''$  is the same as (30) if  $u_1$  be substituted for  $W$ . Thus the expression for power has the same value no matter from which basis it is derived.

**74. The Value of  $W$ .**— $W$  is the total weight of water striking the wheel per second. It is obvious that the weight of water discharged from the nozzle is

$$W = w A_1 V_1.$$

Under normal circumstances all of this water acts upon the wheel. However for high values of the ratio  $u_1/V_1$  a certain portion of the water may go clear through without having had time to catch up with the bucket before the latter leaves the field of action. It is apparent, for instance, that if the buckets move as fast as the jet none of the water will strike them at all. For all speeds less than that extreme case a portion of the water only may fail to act. Thus referring to Fig. 83, it can be seen that if the wheel speed is high enough compared to the jet velocity the water at  $X$  may not have time to catch up with bucket  $C$ . The variation of  $W$  with speed is shown in a particular case by Fig. 85.

It may also be seen that the larger the jet compared to the diameter of the wheel the lower the value of  $u_1/V_1$  at which this loss will begin to occur and it is not desired to have it occur until the normal wheel speed is exceeded. Thus there is a limit to the size of jet that may be used for a given wheel, as stated in Art. 30. For a given diameter of wheel, as the size of the nozzle is increased, larger buckets must be used and they must also be spaced closer together.

**75. The Value of  $k$ .**—The value of  $k$  is purely empirical and must be determined by experiment. If the dimensions of the wheel are known and the mechanical friction and windage losses are determined or estimated, then from the test of the wheel the horse-power developed by the water may be obtained. The value of  $k$  is then the only unknown quantity and may be solved

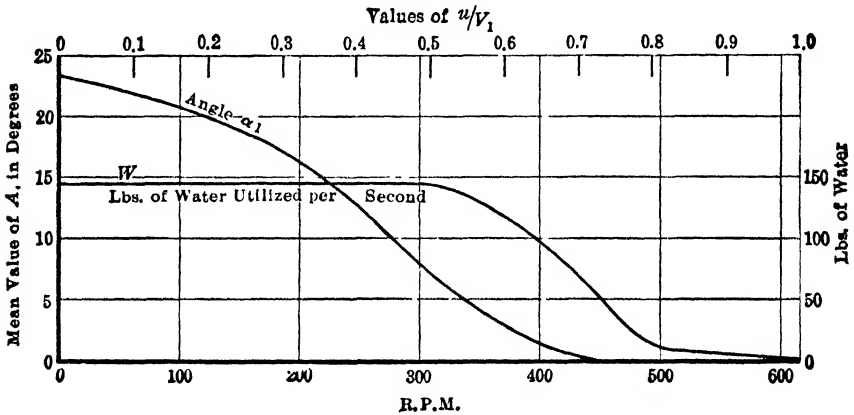

FIG. 85.—Values of  $\alpha_1$  and  $W$  for a certain wheel.

for. The value of  $k$  is probably not constant for all values of  $u_1/V_1$ . Some theoretical considerations, which need not be given here, have indicated that it could scarcely be constant and an experimental investigation has shown the author that  $k$  decreased as  $u_1/V_1$  increased. For a given wheel speed however it is nearly constant for various needle settings unless the jet diameter exceeds the limit set in Art. 30. The crowding of the bucket then increases the eddy losses and would require a higher value of  $k$ .

The value of  $k$  may be as high as 2.0 but the usual range of values is from 0.5 to 1.5.

**76. Constant Input—Variable Speed.**—The variation of torque and power with speed for different needle settings is shown by Fig. 86 and Fig. 87. With the wheel at rest the torque may

vary within certain limits as is shown by the curve for full nozzle opening. This is due to differences in  $\alpha_1$  and in  $x$  for various positions of the buckets. When running at a slow speed the brake reading was observed to fluctuate between the limits shown. At higher speeds this could not be detected. This action is here shown for only one nozzle opening but it exists for all. With a given nozzle opening the horsepower output is fixed and constant. The horsepower output varies with the speed. It will be noticed that the maximum efficiency is attained at slightly higher speeds

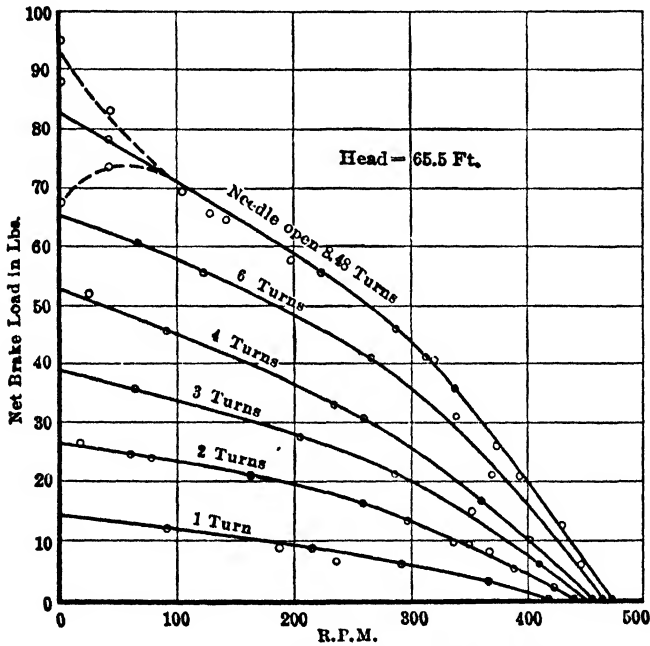

FIG. 86.—Relation between torque and speed.

for the larger nozzle openings than for the smaller. This is due, in part, to the fact that the mechanical losses, which are practically constant at any given speed, become of less relative importance as the power output increases.

Fig. 88 shows the variation of the different losses for a constant power input but a variable speed.<sup>1</sup>

**77. Best Speed.**—It is usually assumed that the best speed is the one for which the discharge loss is the least. As shown in Art. 64, the latter will be approximately attained either when  $u_2 = v_2$  or when  $\alpha_2 = 90^\circ$ . In the case of the impulse turbine the former

<sup>1</sup> The curves shown in this chapter are from the test of a 24-in. tangential water wheel by F. G. Switzer and the author.

assumption gives an easier solution. It will be found that  $u_2 = v_2$  if  $u_1$  is found from

$$kx^2u_1^2 + 2V_1u_1 \cos A_1 - V_1^2 = 0.*$$

An inspection of the curves in Fig. 88 will show that the highest efficiency is not obtained when the discharge loss is the least. So

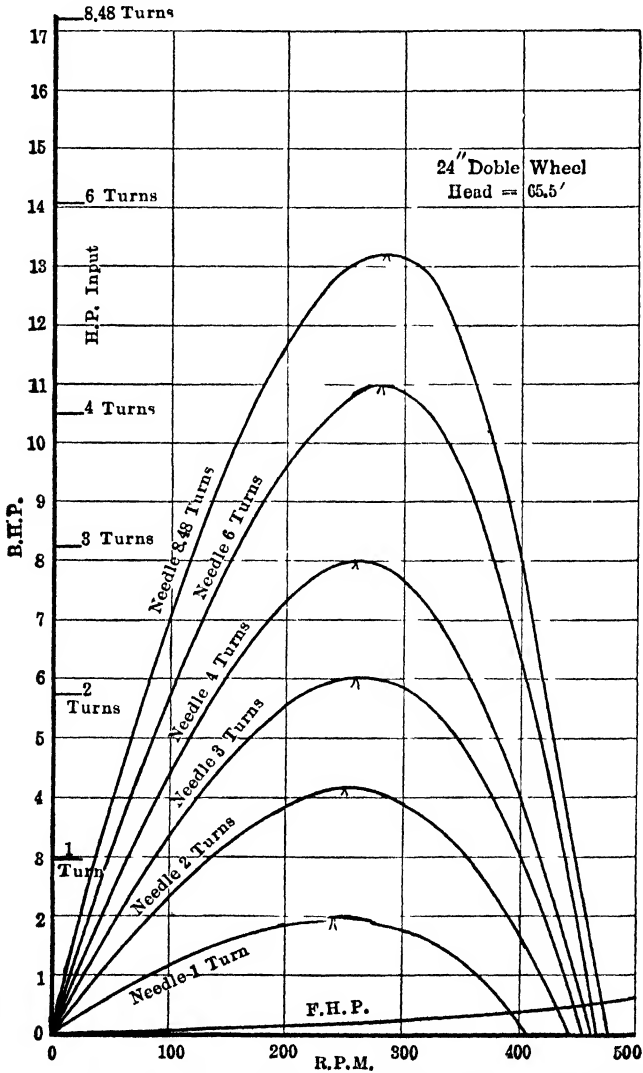

FIG. 87.—Relation between power and speed for different needle settings.

that, although the difference is not great, the above equation does not give the best speed. The hydraulic friction losses and

\* L. M. Hoskins, "Hydraulics," Art. 198, Art. 208.

the bearing friction and windage cause the total losses to become a minimum at a slightly higher speed. It does not seem possible to compute this in any simple way but it will be found that the best speed is usually such that  $u_1/V_1 = 0.45$  to  $0.49$ .

The speed of any turbine is generally expressed as  $u_1 = \phi\sqrt{2gh}$ . The coefficient of velocity of the nozzle will reduce the above

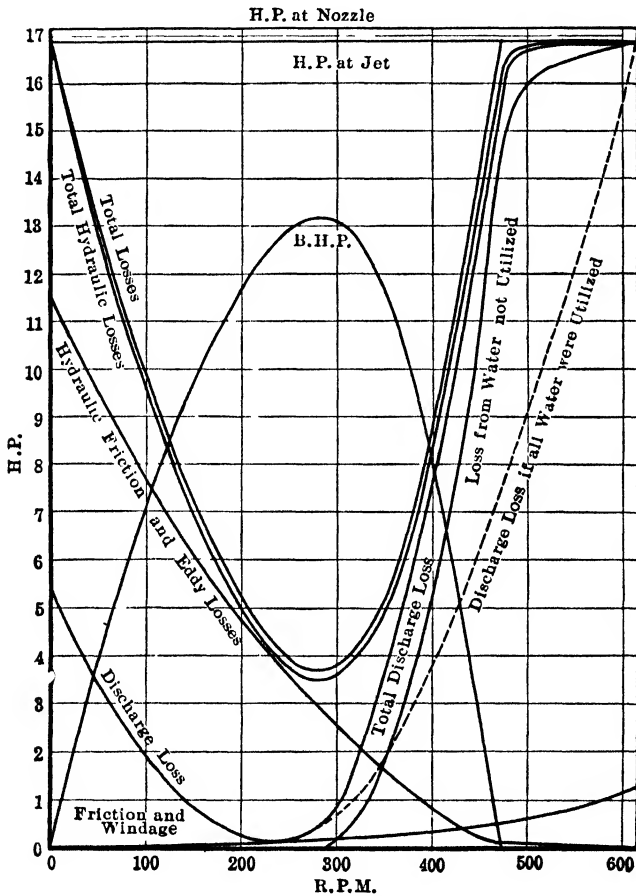

FIG. 88.—Segregation of losses for constant input and variable speed.

values slightly, so that the best speed is usually such that

$$\phi_c = 0.43 \text{ to } 0.47$$

**78. Constant Speed—Variable Input.**—The case considered in Art. 76 is valuable in showing us the characteristics of the wheel but the practical commercial case is the one where the speed is constant and the input varies with the load. From Fig. 87 it is

HYDRAULIC TURBINES

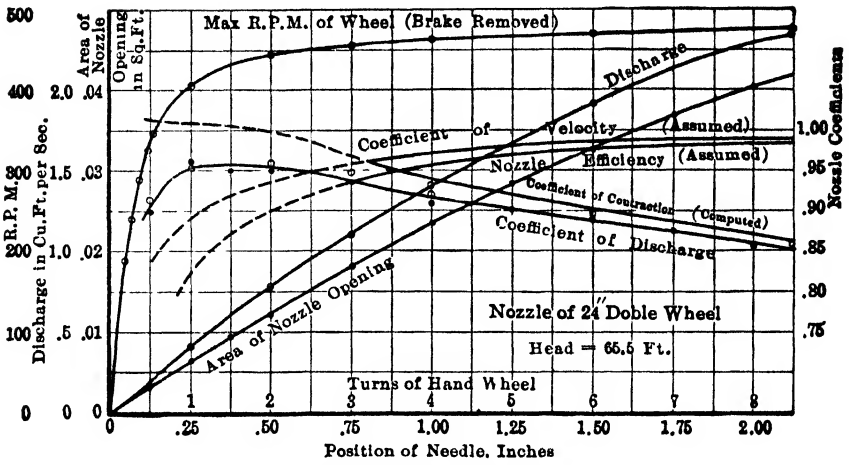

FIG. 89.—Nozzle coefficients and other data.

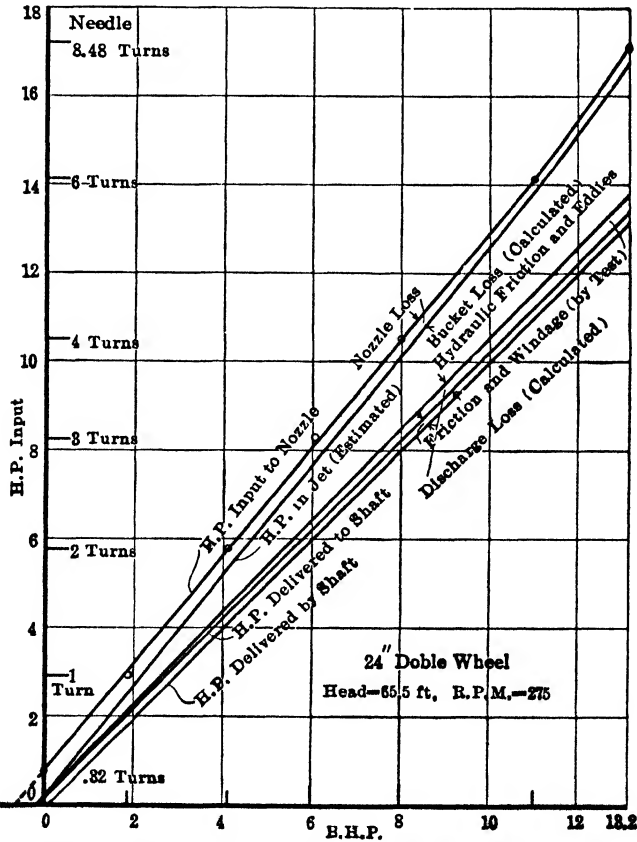

FIG. 90—Relation of input to output and segregation of losses for variable input and constant speed.

seen that the best speed is 275 r.p.m. That value was taken because the highest efficiency was obtained with the nozzle open six turns. For that value of  $N$  the curves in Fig. 90 were plotted. It will be noted that the relation between input and output is

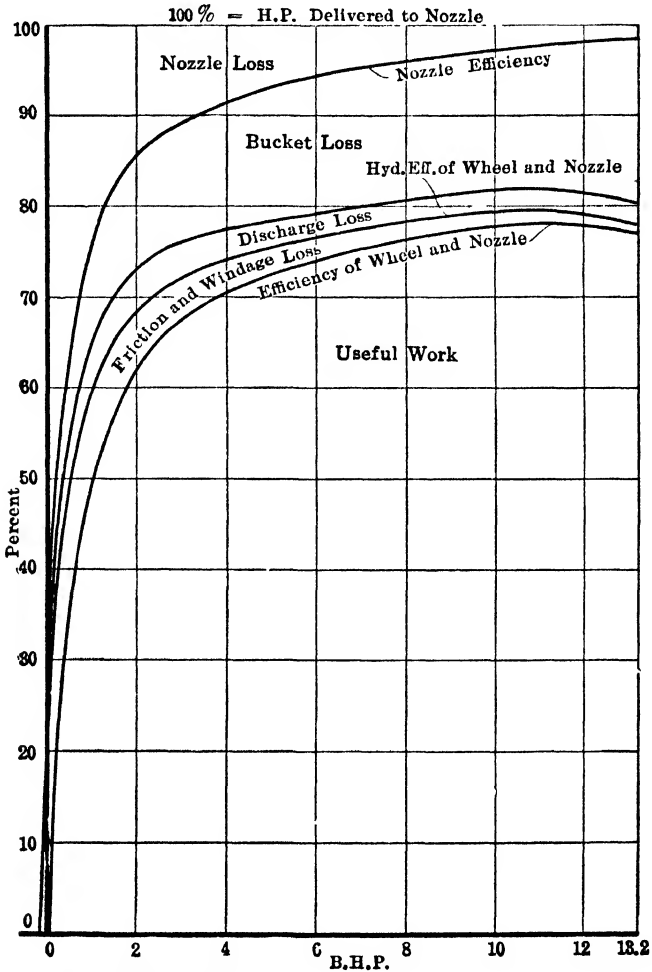

FIG. 91.—Efficiencies and per cent. losses at constant speed.

very nearly a straight line. Above six turns it bends up slightly because the wheel is then slightly overloaded.

The friction and windage was determined by a retardation run<sup>1</sup> and was assumed to be constant at all loads. The hydraulic losses were segregated by the theory already given (Art. 62). These results plotted in per cent. are shown in Fig. 91 and Fig. 92.

<sup>1</sup> See Art. 101.



**79. Observations on Theory.**—The theory as presented in this chapter is of value principally for the purpose of explaining the actual characteristics of Pelton wheels. Thus the determination of values of the angle  $\alpha_1$  is a rather tedious process,<sup>1</sup> and it is open to question whether the average value as defined in Art. 70 is really the proper one to use. But the important fact is that the angle is not zero and that it does vary. In similar manner the determination of the amount of water acting upon the wheel at speeds above normal, and the determination of the speed at which this waste of water begins, is difficult. But the consideration of the problem makes it clear why the curves for the force exerted are not straight lines, as may be seen in Fig. 86, and why the right-hand portion is steeper. In turn this explains why the actual power curves of Fig. 87 are distorted parabolas with the right-hand side much steeper than the left-hand side. Ideally the maximum speed of the wheel should be such that  $u_1 = V_1$ , but actually the run-away speed is such that  $\phi = 0.80$  approximately. This is due to the fact that the proportion of the water acting on the wheel at higher speeds would become so small that the force exerted would be less than that required to overcome the bearing friction and windage loss.

The losses computed by theory and in part determined by experiment are shown in Fig. 88. If it were not for the waste of water mentioned above, the discharge loss from the buckets would be as shown by the dotted line. Actually the loss of energy in this water is shown by the solid curve to the left of this, while the discharge loss from the buckets is only the intercept between the latter curve and the one to its left.

The theory, as illustrated in Fig. 90, shows that for a wheel at the proper speed the principle loss of energy is in the buckets. This emphasizes the importance of close attention to the proper design of the latter. The theory also shows that the individual losses tend to follow straight line laws. This means that the relation between input and output is also a straight line. When the size of the jet becomes too large for the particular wheel, the bucket losses increase more rapidly and hence the curve bends upward at this point, as shown. The relation between input and output is not exactly a straight line for loads less than that for maximum efficiency, but it is nearly so. This is of interest be-

<sup>1</sup> See "Theory of the Tangential Water Wheel," by R. L. Daugherty, in *Cornell Civil Engineer*, Vol. 22, p. 164 (1914).

cause, if only a very few points are determined by test, the complete curve can be drawn with a reasonable degree of accuracy.

The theory also shows that the hydraulic efficiency of the wheel alone is nearly constant from no-load to full-load at constant speed. And considering the efficiency of the wheel and nozzle

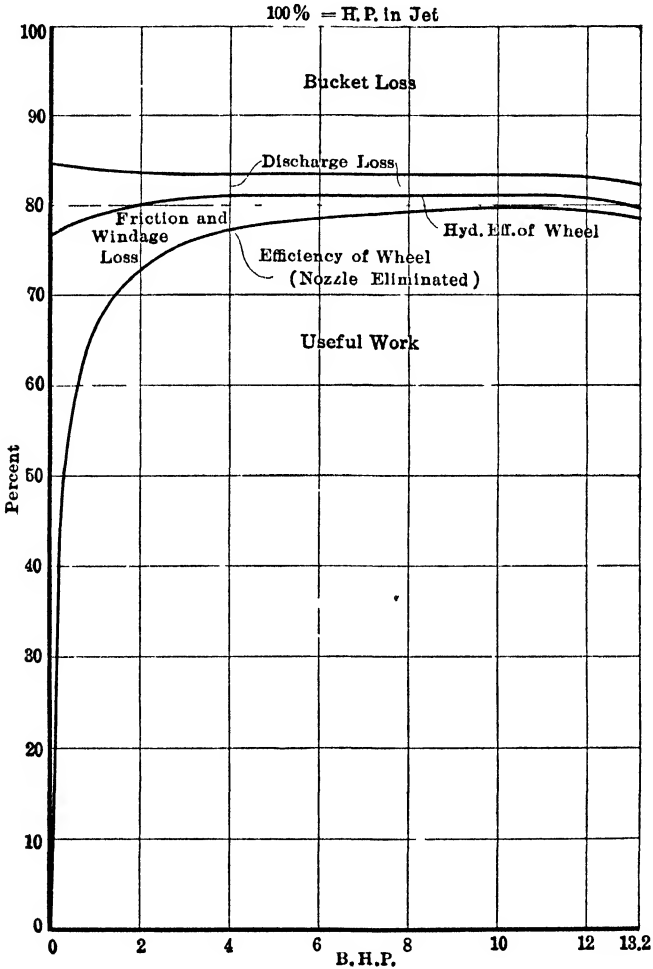

FIG. 92.—Efficiencies and per cent losses at constant speed based upon power in jet.

together the hydraulic efficiency does not begin to drop off rapidly until very small nozzle openings are reached. The reason for this is that the vector velocity diagrams upon which the theory is based are independent of the size of the jet. The variations shown in Fig. 92 are due to changes in  $c_v$  and  $k$ . This

is of practical importance as showing why impulse wheels have relatively flat efficiency curves.

**80. Illustrative Problem.**—Referring to Fig. 93 let the total fall to the mouth of the nozzle be 1000 ft. Suppose  $BC = 5000$  ft. of 30-in. riveted steel pipe and at  $C$  a nozzle be placed whose coefficient of velocity = 0.97. Suppose the diameter of the jet from the nozzle = 6 in. Let this jet act upon a tangential water wheel of the following dimensions: Diameter = 6 ft.,  $\alpha_1 = 12^\circ$ ,  $\beta_2 = 170^\circ$ . Assume  $k = 0.6$ ,  $\phi = 0.465$ , and assume bearing friction and windage = 3 per cent. of power input to shaft.

The problem of the pipe line is a matter of elementary hydraulics and a detailed explanation will not be given of the steps here employed. The coefficient of loss at  $B$  will be taken as

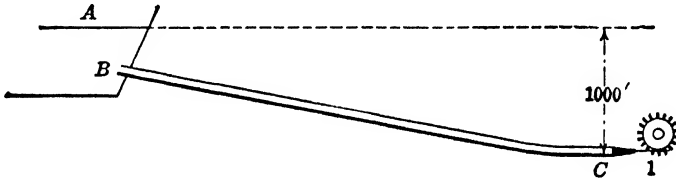

FIG. 93.

1.0, the coefficient of loss in the pipe will be assumed 0.03. The loss in the nozzle will be given by  $\left(\frac{1}{c_v^2} - 1\right) \frac{V_1^2}{2g}$ , where  $c_v$  = the coefficient of velocity and  $V_1$  the velocity of the jet. If  $V_o$  = the velocity in the pipe then the losses will be

$$\left(1 + 0.03 \frac{5000}{2.5}\right) \frac{V_o^2}{2g} + 0.063 \frac{V_1^2}{2g}$$

Taking  $H_A = 1000$  ft. and  $H_1 = \frac{V_1^2}{2g}$  then by equation (4) we

may solve for  $\frac{V_o^2}{2g} = 1.38$  ft. or  $\frac{V_1^2}{2g} = 861$  ft.

Thus  $V_o = 9.42$  ft. per second and  $V_1 = 235.5$  ft. per second.

Rate of discharge,  $q = 46.2$  cu. ft. per second.

The pressure head at nozzle,  $\frac{p_c}{w} = 914.5$  ft.

The wheel speed  $u_1 = 0.465 \times 8.025 \sqrt{915.88} = 113$  ft. per second.

Therefore  $N = 360$  r.p.m.

By methods illustrated in Art. 62,  $v_1 = 126.7$  ft. per second,  $v_2 = 100$  ft. per second, and  $V_{u2} = 14.5$ , assuming  $x = 1.0$ . Thus,  $h'' = \frac{u_1}{g} (V_{u1} - V_{u2}) = 757$  ft.

The means of obtaining the following answers will doubtless be obvious.

|                         |                    |
|-------------------------|--------------------|
| Total head available,   | $H_A = 1000$ ft.   |
| Head at nozzle,         | $H_c = 915.88$ ft. |
| Head in jet,            | $H_1 = 861$ ft.    |
| Head utilized by wheel, | $h'' = 757$ ft.    |

|                              |               |
|------------------------------|---------------|
| Total power available at $A$ | $= 5250$ h.p. |
| Power at nozzle ( $C$ )      | $= 4800$ h.p. |
| Power in jet                 | $= 4520$ h.p. |
| Power input to shaft         | $= 3970$ h.p. |
| Power output of wheel        | $= 3851$ h.p. |

|                                      |           |
|--------------------------------------|-----------|
| Hydraulic efficiency of wheel        | $= 0.878$ |
| Mechanical efficiency of wheel       | $= 0.970$ |
| Gross efficiency of wheel            | $= 0.852$ |
| Efficiency of nozzle                 | $= 0.941$ |
| Gross efficiency of wheel and nozzle | $= 0.801$ |
| Efficiency of pipe line $BC$         | $= 0.915$ |
| Overall efficiency of plant          | $= 0.733$ |

**81. QUESTIONS AND PROBLEMS**

1. With the simple theory of the tangential wheel what are the relations for torque and power as functions of speed? How may the speed and power of an impulse wheel be computed in practice?

2. What are the true conditions of flow in the Pelton water wheel and what assumptions are often made in order to simplify the theory?

3. When may a portion of the water discharged from a nozzle fail to act upon the wheel? Why? What changes in design will improve this condition?

4. Why is the relation between input and output at a constant speed and head not a straight line throughout its range? How does the hydraulic efficiency vary from no-load to full-load at constant speed? Why?

5. Suppose the dimensions of a tangential water wheel are:  $\beta_2 = 165^\circ$ ,  $\phi = 0.45$ ,  $k = 0.5$ , and the velocity coefficient of the nozzle = 0.98. If the diameter of the jet = 8 in. and the head on the nozzle 900 ft., compute the value of the force exerted on the wheel, assuming  $\alpha_1 = 0^\circ$  and  $x = 1.0$ .

6. Compute the force on the wheel in problem (5) assuming  $\alpha_1 = 20^\circ$ .

7. Compute the hydraulic efficiency of the wheel in problem (5). Is this dependent upon the value of the head?
8. Derive an equation for the hydraulic efficiency of a Pelton wheel, giving the result in terms of wheel dimensions and factors such as  $\phi$  and  $c_v$ .
9. Suppose it is desired to develop 2000 h.p. at a head of 600 ft. Assuming an efficiency of 80% what will be the size of jet required, and what will be the approximate diameter and r.p.m. of the wheel?

## CHAPTER IX

### THEORY OF THE REACTION TURBINE

**82. Introductory.**—The main purpose of this chapter is to explain the characteristics of reaction turbines. In turbine theory there are many variables and one must assume some of these and compute the rest, and according to what is assumed as known, the theory presented by various individuals will differ. Also there are matters of difference of detail. For instance one may assume the hydraulic friction losses through the entire turbine, including guides and runner, to be some function of the rate of discharge, while another will attempt to analyze these losses and compute them individually.

The turbine designer, desiring to obtain some definite performance, naturally assumes certain results and computes the dimensions necessary. For our present purpose, we shall do exactly the opposite of this and assume all the dimensions as known and endeavor to determine the characteristics of the given turbine.

**83. Simple Theory.**—A very simple theory is possible by assuming certain factors to be known as the result of experience. Thus, as in the case of the impulse wheel, the peripheral velocity of the runner may be represented as  $u_1 = \phi\sqrt{2gh}$ . And the speed at which the efficiency is a maximum is given by values of  $\phi_e$  ranging from 0.55 to 0.90 according to the type of the runner as in Fig. 34, page 43. This differs from the Pelton wheel not only in the numerical values of  $\phi_e$  but also in the much greater range that is possible.

The efficiency of the turbine may be assumed as from 80 to 90 per cent. according to the size and type of the runner, and hence the power may be computed if the rate of discharge is known. We here introduce another factor  $c$  such that  $V_1 = c\sqrt{2gh}$ . (This is really a velocity coefficient but there is no need to draw any distinction between it and the coefficient of discharge, since here the coefficient of contraction is unity.) It may be noted that in the reaction turbine the water is under pressure throughout its flow and hence the total energy of the water entering the runner is not all kinetic. Thus the coefficient  $c$  can never be unity. And again, since the water flows through a closed conduit all

the way from the case to the tail race it is evident that any loss of head in any part must cause a change in the rate of discharge. And since the losses within the turbine runner vary with the speed, it is evident that the rate of discharge, and hence of  $c$ , must also vary. This again is different from the impulse wheel, where the action of the wheel has no effect upon the velocity of the water from the nozzle. Thus the factor  $c$  is not only less than unity but it depends upon the design and type of the runner, and furthermore it varies with the speed of the latter. Because of this variation with the speed, we shall here give only the values obtained at speeds which result in the highest efficiency being obtained from the wheel. In practice  $c_e$  varies from 0.6 to 0.8 according to the type of runner. Then

$$q = A_1 \times c_e \sqrt{2gh}.$$

It may be of interest to note that as one proceeds from runners of Type I to Type IV of Fig. 34, page 43, one gets farther away from the impulse wheel in all respects. Not only are the resulting operating characteristics and conditions of service more unlike but the numerical factors are of increasing difference. Thus values of  $\phi_e$  for the reaction turbine are larger than for the impulse turbine and they increase in the direction mentioned. The pressure  $p_1$  is zero for the impulse turbine, but not for the reaction turbine. For the same head and setting, the value of  $p_1$  will increase from Type I to Type IV. But if  $p_1$  increases,  $V_1$  must decrease. Hence high values of  $c_e$  accompany low values of  $\phi_e$  and vice versa.

For the present we are assuming that values of  $\phi_e$  and  $c_e$  are to be chosen according to the type of runner concerned.

**84. Conditions for Maximum Efficiency.**—To obtain the best efficiency the water must enter the runner without shock and leave with as little velocity as possible. In order to enter without shock the vane angle must agree with the angle  $\beta_1$  determined by the velocity diagram and, in the case of the reaction turbine, the velocity  $v_1$  as determined by the velocity diagram should be equal in magnitude to that determined by the rate of discharge and the runner area  $a_1$ . In order to leave with as little velocity as possible the angle  $\alpha_2$  may be made equal to  $90^\circ$ , as has been shown in Art. 64. In the early type of turbine as built by Francis such an angle would make the water flow along a radius and hence such a discharge was called "radial" discharge. With the develop-

ment of the mixed flow type, this term is no longer appropriate but it is quite commonly used nevertheless. Such a condition is also spoken of as “perpendicular” discharge, from the fact that the absolute velocity of the water is normal to the linear velocity of the vane, and the term “axial” flow is also used from the fact that with the high-speed type of runner the flow is approximately parallel to the axis.

A further reason for the use of  $\alpha_2 = 90^\circ$  as desirable for a high efficiency of the reaction turbine is that otherwise the water would enter the draft tube with a whirling motion which would increase the losses within the latter.

**85. Determination of Speed for Maximum Efficiency.**—A runner of rational design would be so proportioned that there would be no shock at entrance for the same speed at which the discharge velocity would be normal to the vane velocity. That is  $\alpha_2 = 90^\circ$  and  $\beta'_1 = \beta_1$  at the same speed, where  $\beta'_1$  is the angle of the runner vane and  $\beta_1$  the angle of  $v_1$  as determined by the vector diagram. The following equations therefore apply only to such a runner.

From the velocity diagrams we have, if  $\beta'_1 = \beta_1$ .

$$V_1 \sin \alpha_1 = v_1 \sin \beta'_1$$

$$V_1 \cos \alpha_1 = u_1 + v_1 \cos \beta'_1$$

Eliminating  $v_1$  between these two equations we have

$$u_1 = \frac{\sin (\beta'_1 - \alpha_1)}{\sin \beta'_1} V_1 \tag{32}$$

as the relation between  $u_1$  and  $V_1$  when there is no abrupt change of velocity at entrance to the runner.

Since  $\alpha_2 = 90^\circ$  and hence  $V_{u_2} = 0$ , we have from equation (19)

$$e_h h = \frac{u_1 V_{u_1}}{g} = \frac{u_1 V_1 \cos \alpha_1}{g} \tag{33}$$

as the relation between  $u_1$  and  $V_1$  for which the discharge loss is a minimum.

Solving equations (32) and (33) simultaneously we have

$$u_1 = \sqrt{\frac{e_h 2gh \sin (\beta'_1 - \alpha_1)}{2 \sin \beta'_1 \cos \alpha_1}}$$

$$V_1 = \sqrt{\frac{e_h 2gh \sin \beta'_1}{2 \sin (\beta'_1 - \alpha_1) \cos \alpha_1}}$$



From this it follows that

$$\phi_e = \sqrt{\frac{e_h \sin (\beta'_1 - \alpha_1)}{2 \sin \beta'_1 \cos \alpha_1}} \quad (34)$$

$$c_e = \sqrt{\frac{e_h \sin \beta'_1}{2 \sin (\beta'_1 - \alpha_1) \cos \alpha_1}} \quad (35)$$

It must be borne in mind that the preceding equations apply only to a runner designed as stated. For any runner, whether of rational design or not, the value of  $\phi$  necessary to make  $\alpha_2 = 90^\circ$  can be determined by involving more dimensions than the above, and such an expression will now be derived. It will be assumed also that this is the most efficient speed for any runner, though this may not be strictly true if the entrance loss is not zero at this speed.

If  $\alpha_2 = 90^\circ$ ,  $V_{u2} = u_2 + v_2 \cos \beta_2 = 0$ . Since  $u_2 = xu_1$  and  $v_2 = (A_1/a_2) V_1 = yV_1$  from the equation of continuity, we may write

$$x u_1 + y V_1 \cos \beta_2 = 0 \quad (36)$$

as the relation between  $u_1$  and  $V_1$  for which  $\alpha_2 = 90^\circ$ . Solving this simultaneously with equation (33) we obtain

$$u_1 = \sqrt{\frac{e_h \cdot 2gh \cdot y \cos \beta_2}{-2x \cos \alpha_1}}$$

$$V_1 = \sqrt{\frac{e_h \cdot 2gh \cdot x}{-2y \cos \beta_2 \cos \alpha_1}}$$

From this it follows that

$$\phi_e = \sqrt{\frac{e_h y \cos \beta_2}{-2x \cos \alpha_1}} \quad (37)$$

$$c_e = \sqrt{\frac{e_h \cdot x}{-2y \cos \beta_2 \cos \alpha_1}} \quad (38)$$

From equation (33) we may write  $u_1 V_1 = e_h \cdot 2gh/2 \cos \alpha_1$  and from this it follows that

$$\phi_e c_e = e_h/2 \cos \alpha_1 \quad (39)$$

Values of  $e_h$  and  $\alpha_1$  change somewhat with different types of turbines but this shows that the factors  $\phi_e$  and  $c_e$  vary approximately inversely, as stated in Art. 83.

The equations of this article are all based upon assumptions which prescribe special relationships between  $c$  and  $\phi$ , and are

true only for a special value of  $\phi$ . A method of determining  $c$  for any value of  $\phi$  will be found in Art. 87.

**86. Losses.**—The net head supplied the turbine is used up in two ways; in hydraulic losses and in mechanical work delivered to the runner. The head utilized in mechanical work is  $h'' = \frac{1}{g}(u_1 V_{u_1} - u_2 V_{u_2})$ . In accordance with the usual method in hydraulics we may represent hydraulic friction loss in the runner by  $k v_2^2/2g$ ,  $k$  being an experimental constant. If the turbine discharges into the air or directly into the tail race the discharge loss is  $V_2^2/2g$ . In addition there may be a shock loss at entrance to the runner. The term *shock* is commonly applied here but the phenomena are rather those of violent turbulence. This turbulent vortex motion causes a large internal friction or eddy loss.

Referring to Fig. 94, the value of  $v_1$  and its direction are determined by the vectors  $u_1$  and  $V_1$ . Since the wheel passages

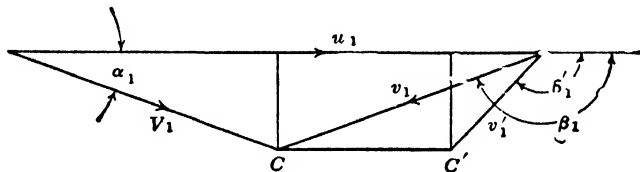

FIG. 94.

are filled in the reaction turbine, the relative velocity just after the water enters the runner is determined by the area  $a_1$  and its direction by the angle of the wheel vanes at that point. If all loss is to be avoided, these values should agree with those determined by the vector diagram; but that is possible for only one value of  $u_1$  for a given head. For any other condition the velocity  $v_1$  at angle  $\beta_1$  is forced to become  $v'_1$  at angle  $\beta'_1$ . This causes a loss of head which will be assumed to be equal to  $(CC')^2/2g$ . Since the area of the stationary guide outlets normal to the radius should equal the area of the wheel passages at entrance normal to the radius, the normal component (*i.e.*, perpendicular to  $u_1$ ) of  $v_1$ , should equal that of  $V_1$ . Therefore  $CC'$  is parallel to  $u_1$  and its value is easily found to be

$$CC' = u_1 - \frac{\sin(\beta'_1 - \alpha_1)}{\sin \beta'_1} V_1$$

If  $k' = \sin(\beta'_1 - \alpha_1) / \sin \beta'_1$ , then

$$\text{shock loss} = \frac{(u_1 - k'V_1)^2}{2g}$$

**87. Relation between Speed and Discharge.**—Equating the net head to the sum of all these items we have

$$h = k \frac{v_2^2}{2g} + \frac{V_2^2}{2g} + \frac{(u_1 - k'V_1)^2}{2g} + \frac{2(u_1V_{u_1} - u_2V_{u_2})}{2g}$$

All velocities can be expressed in terms of  $u_1$  and  $V_1$  as follows:

$$u_2 = xu_1, v_2 = yV_1, V_{u_1} = V_1 \cos \alpha_1,$$

$$V_{u_2} = u_2 + v_2 \cos \beta_2 = xu_1 + yV_1 \cos \beta_2,$$

$$V_2^2 = u_2^2 + v_2^2 + 2u_2v_2 \cos \beta_2 = x^2u_1^2 + y^2V_1^2 + 2xyu_1V_1 \cos \beta_2.$$

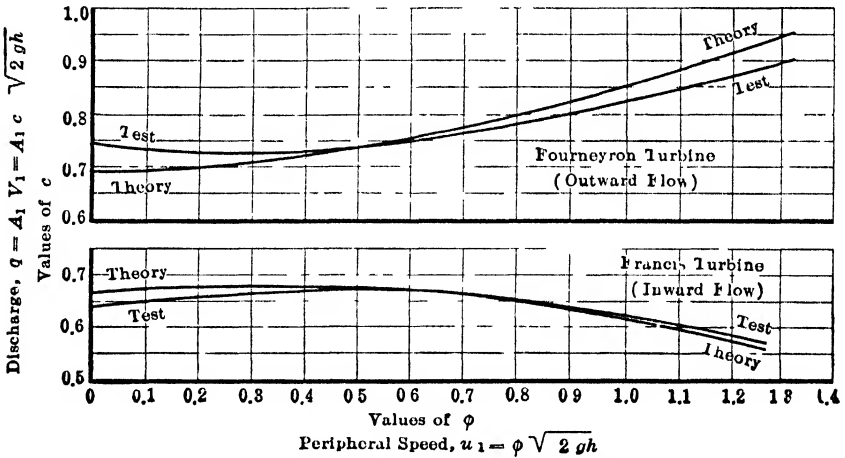

FIG. 95.—Comparison of the relation between  $c$  and  $\phi$  as determined by theory and by test.

Making these substitutions and reducing we obtain,

$$[(1 + k)y^2 + k'^2]V_1^2 + 2(\cos \alpha_1 - k')V_1u_1 + (1 - x^2)u_1^2 = 2gh.$$

From this equation  $V_1$  may be computed for any value of wheel speed,  $u_1$ . It is customary to express the wheel speed as  $u_1 = \phi\sqrt{2gh}$ , and we may also say  $V_1 = c\sqrt{2gh}$ . The use of these factors is more convenient in general. Introducing them our equation becomes

$$[(1 + k)y^2 + k'^2]c^2 + 2(\cos \alpha_1 - k')c\phi + (1 - x^2)\phi^2 = 1. \quad (40)$$

From this equation  $c$  may be computed for any value of  $\phi$ . For

the outward flow turbine (40) becomes a hyperbola concave upward, for the inward flow turbine it becomes an ellipse concave downward.

A comparison between the values of  $c$  as determined by this equation and as determined by experiment is shown in Fig. 95. One turbine was an outward flow turbine and the other was a radial inward flow turbine. Considering the imperfections and limitations of the theory, the agreement is remarkably close.

If the turbine discharges into an efficient draft tube the discharge loss may be represented by  $mV_2^2/2g$ , where  $m$  is a factor less than unity. If there were no internal friction and eddy losses within the tube, the value of  $m$  would depend only upon the areas of ends of the tube and would be equal to  $(A_2/A_3)^2$ . Actually  $m$  is greater than this due to hydraulic friction losses. And as the speed of the turbine departs from the normal value, it is probable that  $m$  increases still more and approaches unity. Introducing the discharge loss as  $mV_2^2/2g$  in the equation at the beginning of this article, we obtain as a substitute for equation (40),

$$[(m + k)y^2 + k'^2]c^2 + 2[\cos \alpha_1 - k' - (1 - m)xy \cos \beta_2]c\phi - [(2 - m)x^2 - 1]\phi^2 = 1 \quad (41)$$

It will be found that this equation will give slightly higher values of  $c$  than equation (40), which is to be expected. Thus the use of a diverging draft tube increases the power of the turbine not only by increasing its efficiency but also by increasing the quantity of water it can discharge.

If desired, equation (36), when put in terms of  $\phi$  and  $c$ , can be solved simultaneously with equations (40) or (41), thus giving a third method of computing the value of  $\phi_e$ . Also it is possible to derive a general equation for the efficiency of a reaction turbine and by calculus find the value of  $\phi$  for which the efficiency is a maximum. However the resulting equation is somewhat lengthy and, because it is of no practical value, will not be given here. Values of  $\phi$  determined by it will usually not differ much from those determined by the simpler approximate method of assuming that  $\alpha_2 = 90^\circ$ .

**88. Torque, Power and Efficiency.**—General equations for torque, power, and efficiency were derived in Chapter VII and the application of these illustrated by a numerical case in Art. 63. In that article the speed and rate of discharge of the turbine were assumed. In the present chapter methods are shown for com-

puting by theory the speed for maximum efficiency and the rate of discharge for any speed. From this point on the procedure is the same as in Chapter VII.

It is of course possible to make algebraic solutions for these quantities and the resulting equations then express results in terms of known factors and dimensions. Thus, to illustrate, the hydraulic efficiency is in general

$$e_h = h''/h = (u_1 V_1 \cos \alpha_1 - u_2 V_2 \cos \alpha_2)/gh.$$

For the reaction turbine in particular  $u_2 = xu_1$  and  $V_2 \cos \alpha_2 = u_2 + v_2 \cos \beta_2 = xu_1 + yV_1 \cos \beta_2$ . Substituting in the above we obtain  $e_h = [(\cos \alpha_1 - xy \cos \beta_2) V_1 u_1 - x^2 u_1^2]/gh$ . From this it follows that

$$e_h = 2(\cos \alpha_1 - xy \cos \beta_2) c\phi - 2x^2\phi^2 \quad (42)$$

A numerical result in a given case can be computed either by substituting the known quantities in the above equation or by computing the separate items of the general equation. The latter usually involves no more labor.

Equation (42) is of interest because it involves no arbitrary factors of loss. Thus if the relation between speed and discharge is known, as by experiment, the hydraulic efficiency can be computed, provided the proper wheel dimensions are known. Actually it is so difficult, as will be explained later, to determine the proper values of the runner dimensions, that the numerical accuracy of the result is doubtful. The hydraulic efficiency can probably be estimated more accurately than the separate factors in these equations. The equation is of very practical value however in showing that the hydraulic efficiency is independent of the head under which the turbine is run.

Equation (42) is perfectly general for any reaction turbine and is not restricted to the maximum efficiency. The value of the maximum efficiency will be obtained by using the values of  $\phi_c$  and  $c_c$  in the equation. Of course, since  $V_{u_2}$  is assumed to be zero for this case the value of the maximum efficiency can be computed much more directly than by the use of the above.

**89. Variable Speed—Constant Gate Opening.**—Since  $c$  varies with the speed the input for a fixed gate opening will not be constant for all speeds as it is in the case of the impulse turbine. The variation of the losses at full gate with the speed ranging from zero up to its maximum value is shown by Fig. 96. The horse-power

in each case was obtained by multiplying  $wq/550$  by the head lost as given by Art. 86.

The curves for the impulse turbine in Fig. 88 may also represent percentages by the use of a proper scale since the input is constant. But for the reaction turbine the percentage curves will be slightly different from those in Fig. 96. It will thus be true that the speed at which the efficiency is a maximum will be slightly different from the speed for which the power is the greatest.

The Francis turbine for which the curves in Fig. 95 and Fig. 96 were constructed had the following dimensions:

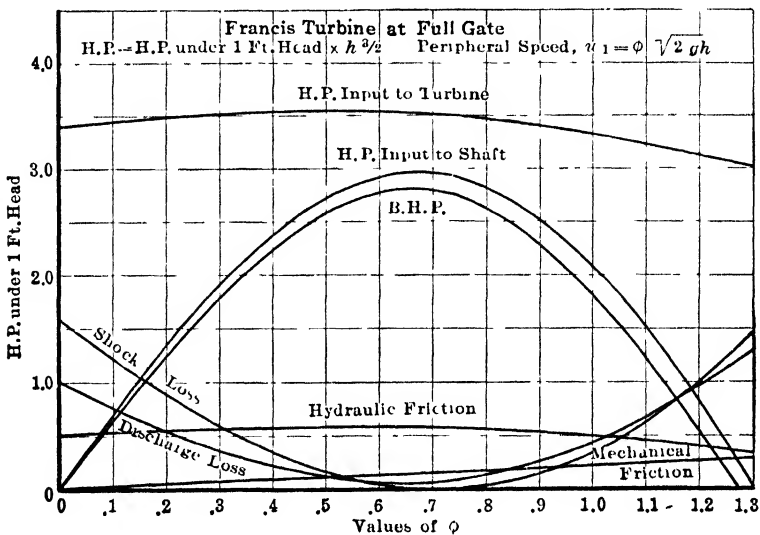

FIG. 96.—Losses at full gate and variable speed.

$$\alpha_1 = 13^\circ, \beta'_1 = 115^\circ, \beta_2 = 165^\circ, A_1 = 5.87 \text{ sq. ft.}, a_2 = 6.83 \text{ sq. ft.}, r_1 = 4.67 \text{ ft.}, r_2 = 3.99 \text{ ft.}$$

From this data  $x = 0.855, y = 0.860, k' = 1.08,$  and  $k = 0.5$  (assumed). Attention is called to the fact that the horse-power output was determined by an actual brake test while the horse-power input to shaft was computed from the theory given in the preceding article. The two differ by the amount of power consumed in bearing friction and other mechanical losses.

**90. Constant Speed—Variable Input.**—The relation between input and output and the segregation of losses for a cylinder gate turbine at constant speed is shown in Fig. 97. In the four tests the gate was raised  $\frac{1}{4}, \frac{1}{2}, \frac{3}{4},$  and  $\frac{4}{4}$  of its opening. With the turbine running on full gate but at an incorrect speed there is

a shock loss at entrance as shown in Art. 86. This loss is due to an abrupt change in the direction of the relative velocity of the water. When the turbine is running at the normal speed but with the gate partially closed there is a shock loss of a slightly different nature. A partial closure of the gates increases the value of  $V_1$  and the angle  $\alpha_1$  may be affected somewhat. However  $q$  will be reduced while  $\alpha_1$  remains the same and thus the

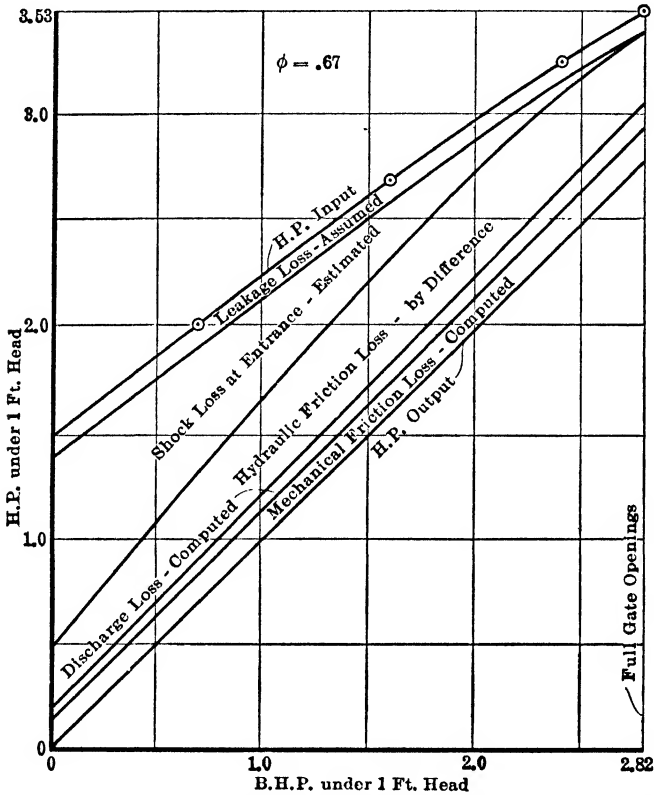

FIG. 97.—Losses for cylinder gate Francis turbine at constant speed.

velocity  $v_1$  must be suddenly reduced to  $v'_1$ . The loss of head due to this may be roughly represented by  $(v_1 - v'_1)^2/2g$ . While this expression may not give the exact value of the loss, yet it must be true that it will be of the nature shown by the curves.

This loss is known to be less in the case of the swing gate turbine than in the cylinder gate turbine. While both  $\alpha_1$  and  $V_1$  are altered in the case of the wicket gate, the transition in the runner is less abrupt and consequently the eddy losses are less.

There will always be a slight leakage through the clearance

spaces and such a loss is indicated in Fig. 97 though it was not possible to compute it with any exactness. It was merely added to show that it exists but it was not accounted for in Fig. 96. These results on a percentage basis are shown in Fig. 98.

The cylinder gate turbine is rather inefficient on light loads due to the big shock loss. The wicket gates do not occasion such large shock losses and hence reduce the input curve to a line more nearly parallel to the output line in Fig. 97, and thus improve the part load efficiency of the turbine. Also the cylinder gate turbine gives its best efficiency when the gate is completely raised and the

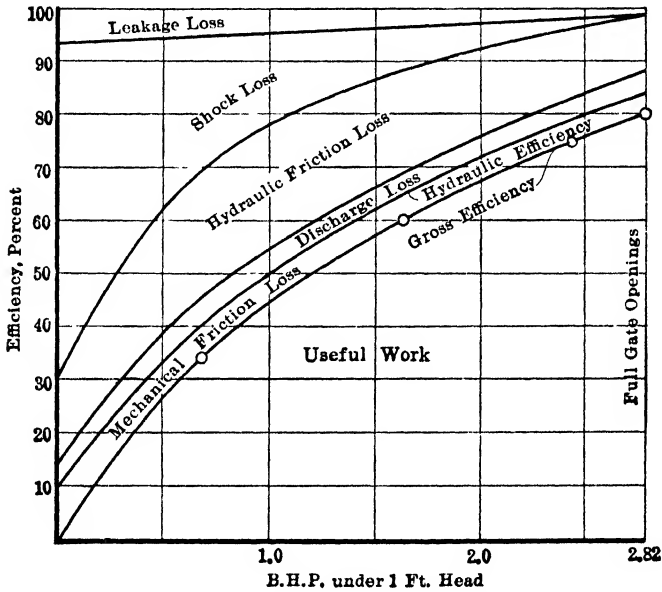

Fig. 98.—Cylinder gate turbine at constant speed.

power output has its greatest value. But the wicket gate turbine usually develops its best efficiency before the gates are fully open. There is thus left some overload capacity.

**91. Runner Discharge Conditions.**—The following theory, though open to certain objections, serves to explain the observed phenomena at the discharge from a turbine runner. A low specific speed type of runner, such as Type I in Fig. 34, page 43, will have stream lines through it which differ but little from one another, while a high specific speed type such as Fig. 99 will have stream lines which differ considerably. Thus in Fig. 99 stream line (a) next to the crown will have smaller radii at both entrance and outflow than stream line (c) next to the band.



Also the radii of points along the outflow edge vary considerably more in the case of the high specific speed runner. The radius of curvature of stream line (a) is much greater than that of line (c) and in accordance with equation (23) the velocity along line (a) will be less than along line (c). It must be noted that the lines shown in the drawing are really "circular" projections of the actual stream lines, by which is meant that the various points are revolved about the axis of the runner until they lie in the plane of the paper; and also a free vortex, while existing in the space between guides and runner, and

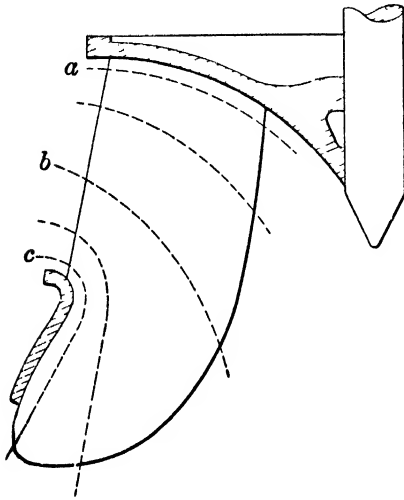

FIG. 99.

also in the draft tube, does not exist within the runner. But, considering the velocity component in the plane of the paper only, and considering the rotation about the centers of curvature of the lines drawn (and not about the axis of the runner), the equations of Art. 66 may be applied.

Since  $e_h = h''/h = (u_1V_{u1} - u_2V_{u2})/gh$ , we may write

$$u_2V_{u2} = u_1V_{u1} - gh'' \quad (43)$$

not only for the turbine as a whole, but for each individual

stream line. It has been stated that usually a runner is so designed that  $\alpha_2 = 90^\circ$ . With some runners observation shows that there is a slight whirl of the water across the entire draft tube at the point of maximum efficiency, but this might be expected, since the assumption that  $V_{u2}$  should equal zero is a mere approximation. With the low specific speed turbine it is possible to have  $\alpha_2 = 90^\circ$  for all stream lines at some speed which may or may not be exactly the most efficient, but it is difficult to do this with the high specific speed runner and still satisfy the equation above. Thus suppose the discharge is normal to  $u_2$  for stream line (b) in Fig. 99. Then for this stream line  $u_1V_{u1} = gh''$ . Considering line (c) both  $u_1$  and  $V_{u1}$  are larger for the reasons stated in the first paragraph. If  $V_{u2}$  is to be zero here also,  $h''$  must be larger. But the conditions here are not favorable to as high an efficiency as along line (b), because of the proximity to the boundary (which

in this instance is the band) and because of the sharper curvature. Hence by no proportioning can the water be compelled to flow as desired. Since  $u_1 V_{u1}$  is larger and  $h''$  is smaller than for line (b) it follows that the right hand member of the equation must be positive and hence there must be some whirl at the point of discharge in the direction of rotation of the runner. In similar fashion there may be a negative whirl at the point of discharge from line (a), but since  $u_1$ ,  $V_{u1}$ , and  $h''$  all decrease for this line, as compared with (b), it is possible that there may be little or no whirl here. All this reasoning has been verified by experimental observations.<sup>1</sup> This whirl of the water near the band decreases the efficiency of the draft tubes as constructed in the past and points the reason for the development of a new type of tube if turbines of higher specific speed are to be used. And unless more effective draft tubes are used, this shows that this factor tends to reduce the efficiency of the runner as the specific speed increases.

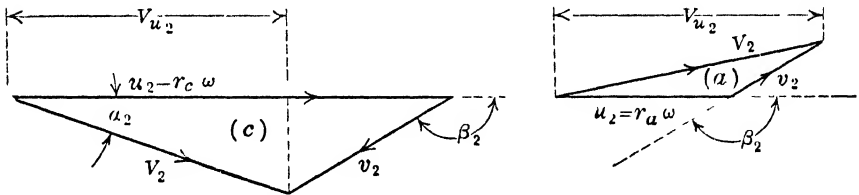

FIG. 100.

For the higher the specific speed the greater the variation in  $r_2$  for stream lines (a) and (c), and this has been shown to be undesirable.

At part gate on any turbine the efficiency and hence  $h''$  are known to be less than on full load, the latter being taken as the load for which the efficiency is a maximum. And if wicket gates are used the angle  $\alpha_1$  is less than at full load so that  $V_1 \cos \alpha_1$  would appear to be higher. Hence if the right hand side of equation (43) is equal to zero at full load, it would have a relatively large positive value for a partial opening of the turbine gates. Thus  $V_{u2}$  would be positive, which agrees with the vector diagram, since with a smaller rate of discharge the velocity  $v_2$  would be less while the wheel speed  $u_2$  is considered to be the same.

Since  $u_2 V_{u2}$  must have a large positive value for a small gate opening and  $u_2$  varies with the radius, it follows that  $V_{u2}$  is relatively small near the band and relatively large near the crown.

<sup>1</sup> See *Trans. A. S. C. E.*, Vol. LXVI, p. 378 (1910).

Since  $V_{u_2} = u_2 + v_2 \cos \beta_2$  and  $u_2$  is fixed, the value of  $v_2$  must decrease as the crown is approached ( $\cos \beta_2$  is negative) and may even become negative. This means that water is actually pumped back into the runner near the crown and out near the band. This shows the undesirability of a large variation in the radii of the discharge edge of a runner, and this latter is characteristic of the profile of the high specific speed runner. Hence this theory presents a reason why the part gate efficiency of a reaction turbine must be less as the specific speed increases.

The smaller the rate of discharge for a given head the less the value of  $v_2$  at any point on the outflow edge and hence the less the wheel speed necessary to make  $\alpha_2 = 90^\circ$  at this point. Thus with any turbine the speed for which the efficiency is a maximum decreases as the gate opening decreases.

**92. Limitations of Theory.**—The defects of this theory or any theory are as follows: In order to apply mathematics in any simple way it is necessary to idealize the conditions of flow by assuming that all the particles of water at any section move in the same direction and with the same velocity. Such is very far from being the case so what we use in our equations is the average direction and the average velocity of all the particles of water. That in itself could easily cause a discrepancy between our theory and the fact, because the theory is incomplete.

But even to determine accurately these average values that are used in the equations is a matter involving some difficulty. Thus, though the direction of the streams leaving the runner is influenced by the vane angle at that point, it cannot be said that the angle  $\beta_2$  is exactly equal to the vane angle at exit. In fact the author has roughly proved by study of a test where some special readings were observed that the two may differ by from 5 to 10 degrees, and that  $\beta_2$  varied regularly for different values of  $\phi$ . The same thing may be said about the area  $a_2$ . Some recent experiments in Germany<sup>1</sup> have shown that there may be a certain amount of contraction of the streams and that this contraction varies for different speeds. Thus the true value of  $a_2$  may be slightly less than the area of the wheel passages. These observations concerning  $\beta_2$  and  $a_2$  apply equally well to other angles and areas.

<sup>1</sup> *Zeitschrift des Vereins deutscher Ingenieure*, May 13, 1911.

In computing the results plotted in Fig. 95 the coefficients of  $c$  and  $\phi$  in equation (40) were treated as constant. It has just been shown that the real values of the angles and areas may vary slightly with the speed. Also it is stated in Art. 75 that the value of  $k$  is not constant at all speeds for the impulse turbine. While the conditions with the reaction turbine are very different, yet it is doubtless true that  $k$  is not strictly constant here. If it were known just how  $k$  and the dimensions used varied with the speed, the theoretical curve could be made to more nearly coincide with the actual curve. In addition the expression for shock loss is only an approximation. But even as it is the discrepancy is not serious.

By the use of the proper average dimensions the equations given may be successfully applied to a radial flow turbine. For the mixed flow turbine they will apply approximately. The

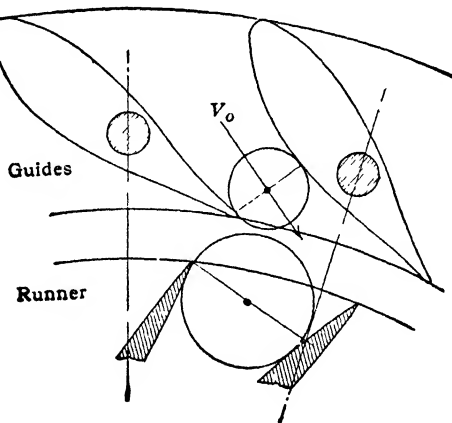

FIG. 101.

reasons for this are that with the mixed flow turbine the radius  $r_1$  varies through such a wide range of value that it is difficult to fix a proper mean value; likewise the vane angle at exit and also the area varies so radically that a mean value can scarcely be obtained with any accuracy. Even if these mean values could be obtained the theory would still be imperfect, for the reason stated in the first paragraph of this article.

The value of the angle  $\alpha_1$  may be taken as that of the angle shown in Fig. 101, though it may be seen that this is a mean for the various stream lines. The velocity of the water through the guide vanes may be denoted by  $V_0$  but, since the space between guides and runner is a free vortex, the velocity  $V_1$  is increased in

the ratio  $r_0/r_1$ . In all the discussion so far it has been inferred that the point (1) coincided with the outer radius of the runner. It is the velocity of this point that is given by the factor  $\phi$  and most of our empirical computations will be based upon this, for ease in computation. But if one wishes to compute certain results by applying the laws of hydrodynamics, such as equations (40), (41), and (42) for example, it is desirable to select the point (1) such that the most suitable mean values for use in the equations will be obtained.<sup>1</sup> Such a point is often said to be the center of the circle shown at entrance to the runner of Fig. 101. The diameter of this circle is the shortest line that can be drawn from the tip of one vane to the next vane.

A similar procedure should be followed for the point of discharge if the turbine were a pure radial flow turbine with all points on the outflow edge at the same radius. For the mixed flow type of turbine it can be proven that the discharge may be considered as concentrated at the center of gravity of the outflow area.

Because of the difficulties of applying the theory in a definite case numerical results are of doubtful accuracy. But the theory has other uses. Thus the theory shows why certain factors and dimensions must vary with the specific speed of the runner. It shows that the rate of discharge cannot be constant for a given runner at different speeds under a constant head and gate opening. It shows why certain conditions are desirable for efficiency and how the proper speed may be approximately computed. It explains the losses within a turbine and shows why certain characteristics vary as they do. It serves to give the reasons why there are fundamental differences in the operating characteristics of turbines of different types. In other words it will in general furnish the reason for any result found in practice. And beyond explaining these characteristics, it indicates the effect of any change in any direction.

**93. Effect of  $y$ .**—The ratio of  $A_1/a_2$  is expressed by  $y$ . If  $y$  is small enough the turbine will be an impulse turbine, the value of  $\phi$  giving the best speed will be about 0.45,  $p_1/w = 0$ , and  $c$  will equal 1.00 if the slight loss in the nozzle is neglected. (Ac-

<sup>1</sup> This procedure was not followed however in dealing with the Francis turbine for which the curves in this chapter were drawn. But this turbine is much more amenable to mathematical analysis than the runners of the present day.

tually  $c$  will be the coefficient of velocity of the nozzle and will be about 0.97). As the value of  $y$  increases, the turbine becomes a reaction turbine, the value of  $\phi$  increases,  $p_1/w$  increases, and  $c$  decreases. The general tendency of these factors is shown in Fig. 102.

It is thus seen that the design of a reaction turbine can be varied so as to secure quite a range of results.

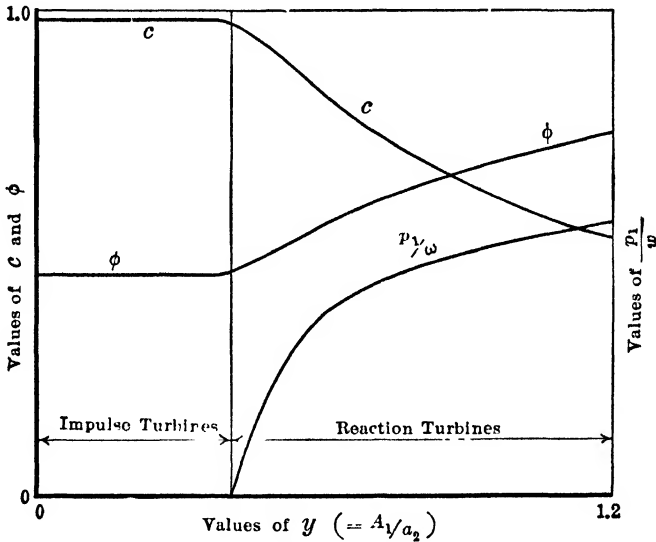

FIG. 102.

### 94. QUESTIONS AND PROBLEMS

1. Given the diameter  $D$  and the height  $B$  of a turbine runner, how can one approximately compute the speed and power for any head?
2. Why does the rate of discharge from a turbine runner vary with the speed under a fixed head? Why is the velocity of the water entering the runner less than  $\sqrt{2gh}$ ?
3. What are the conditions necessary for high efficiency of a reaction turbine? What effect does the draft tube have upon this also?
4. In what two ways may  $\phi_e$  be computed? What are the fundamental differences involved in these methods? Should the numerical results differ?
5. What are the various losses of the turbine and how may they be expressed? What is the effect of the draft tube in this?
6. How may a general equation between speed, discharge, and head be derived?
7. How may a general equation for the hydraulic efficiency of a reaction turbine be derived? What does it indicate?
8. From the curves, what are the differences between the variations in the losses for impulse and reaction turbines?

9. Explain why the discharge conditions for a high specific speed runner are less favorable than those for a low specific speed runner both being assumed to be running at their points of maximum efficiency.

10. Explain why the discharge conditions at part gate are less favorable for the high specific speed runner than for the low specific speed runner.

11. What are the limitations of turbine theory and why? What is the value of the theory?

12. What effect does the change in the ratio of the area through the guide vanes to that at outflow from the runner have upon the values of  $\phi$ ,  $c$ , and  $p_1/w$ ?

13. A turbine runner 36 in. in diameter and 12 in. high at entrance will run at what probable r.p.m. and develop what power under a head of 60 ft.? (Assume value of  $\alpha_1$ .) *Ans.*  $N = 317$ , B.h.p. = 890.

14. In problem (13) suppose the intake to the runner is at a height of 15 ft. above the tail-water level. What is the probable value of the pressure head at this point? *Ans.* 29 ft.

15. The dimensions of the original Francis runner were  $\alpha_1 = 13^\circ$ ,  $\beta'_1 = 115^\circ$ ,  $\beta_2 = 165^\circ$ ,  $A_1 = 5.87$  sq. ft.,  $a_2 = 6.83$  sq. ft.,  $r_1 = 4.67$  ft., and  $r_2 = 3.99$  ft. Compute the values of  $\phi_e$  and  $c_e$  by the first method given, assuming  $e_h = 0.83$ . Do these answers give shockless entrance? Do they give  $\alpha_2 = 90^\circ$ ? What dimensions could be changed to make both of these conditions be fulfilled at the speed computed? *Ans.*  $\phi_e = 0.678$ ,  $c_e = 0.628$ .

16. Compute the values of  $\phi_e$  and  $c_e$  for the Francis turbine in the preceding problem by the second method given? Do these answers give shockless entrance? Do they give  $\alpha_2 = 90^\circ$ ? What dimensions could be changed so as to fulfill both these conditions at this speed?

*Ans.*  $\phi_e = 0.643$ ,  $c_e = 0.663$ .

17. Francis noted that his runner was not quite properly designed and that there was some shock loss at entrance when running at the most efficient speed. By test the actual value of  $\phi_e$  was found to be 0.67. Compute the corresponding value of  $c_e$  and compare with the curve in Fig. 95. Assume  $k = 0.5$ .

*Ans.*  $c_e = 0.655$ .

18. Compute the hydraulic efficiency of the Francis turbine of problem (15) using the values of  $\phi$  and  $c$  given in problem (17) and compare with value given by curve in Fig. 98.

*Ans.* 0.825.

19. If this turbine discharges into a draft tube of such dimensions that  $m$  may be assumed equal to 0.3, compute the value of  $c$  for a value of  $\phi_e$  equal to 0.675. Compute the hydraulic efficiency. The value of  $\phi_e$  has been increased slightly here because of the presumption that the draft tube will increase the efficiency of the turbine. Compare with problems (17) and (18).

*Ans.*  $c_e = 0.66$ ,  $e_h = 0.833$ .

20. What is the percentage value of the discharge loss from the Francis turbine of problem (15), assuming  $\alpha_2 = 90^\circ$  and  $c_e = 0.66$ ? For this particular turbine, what is the possible gain in efficiency due to using a draft tube which would reduce the velocity to zero without loss of energy? (Note.  $V_2 \sin \alpha_2 = V_2$  for  $90^\circ$  and  $V_2 \sin \alpha_2 = v_2 \sin \beta_2 = yc\sqrt{2gh} \sin \beta_2$ .)

*Ans.* 2.15 per cent.

21. If the turbine in problem (17) is used under a head of 30 ft., find the

r.p.m., the quantity of water discharged, and the power delivered to the shaft. Find similar results for problem (19).

*Ans.*  $N = 60.2$ ,  $q = 169$ , h.p. = 475,  $N = 60.8$ ,  $q = 170.2$ , h.p. = 484.

**22.** If the turbine in the preceding problem were to be run at the same speed of 60.2 r.p.m., while the head decreased to 18 ft., find the rate of discharge, hydraulic efficiency and power.

*Ans.*  $\phi = 0.864$ ,  $c = 0.633$  by (40),  $q = 126.5$ ,  $e_h = 0.755$ , 195 h.p.



## CHAPTER X

### TURBINE TESTING

**95. Importance.**—Testing is necessary to accompany theory in order that the latter may be perfected until it becomes reliable enough to be useful. Unless the theory agrees with the facts it is not true theory but only an incorrect hypothesis. Only by means of theory and testing working hand in hand can improvements in design be readily brought about. Thus the ease of testing is a measure of the rate of development of any machine.

Again, if we are to thoroughly understand turbines, it will be necessary to make a thorough study of test data in order to appreciate the differences between different types. Unfortunately there is a scarcity of good and thorough test results.

The only public testing flume in the United States is the one at Holyoke, Mass. Nearly 3000 runners have been tested there and it has been an important factor in the development of modern turbines. The maximum head obtainable there is about 17 ft., also it is scarcely possible to test runners above 42 in. in diameter because of the limitations imposed by the depth of the flume.

An acceptance test should always be made when a turbine is purchased if it is possible to do so. Otherwise the purchaser will have no assurance that the specifications have been fulfilled. Thus a case may be cited where the power and efficiency of a tangential water wheel were both below that guaranteed as can be seen by the following:

|                | Efficiency | Normal h.p. | Maximum h.p. |
|----------------|------------|-------------|--------------|
| Guarantee..... | 0.800      | 3500        | 5225         |
| Test.....      | 0.720      | 2300        | 3500         |

In this table the normal horse-power means the power at which the maximum efficiency is obtained, any excess power over that being regarded as an overload. The actual efficiency is 8 per cent. less than that guaranteed and the wheel is really a 2300-h.p. wheel instead of a 3500-h.p. wheel. It is true that the

wheel could deliver 3500 h.p. but at an efficiency of only 67 per cent. Since that is the maximum power the 5225-h.p. overload could not be attained.

Another case may also be given where the facts are of a different nature.<sup>1</sup> A comparison of the guaranteed and test results for a reaction turbine is shown in Fig. 103. The efficiency secured was higher than that guaranteed, but it was also attained at a much higher horse-power. If the turbine were then run on the load specified it would be operating on part gate all the time and at a correspondingly low efficiency. This is a common failing in "cut and try" practice. A turbine of excess capacity is

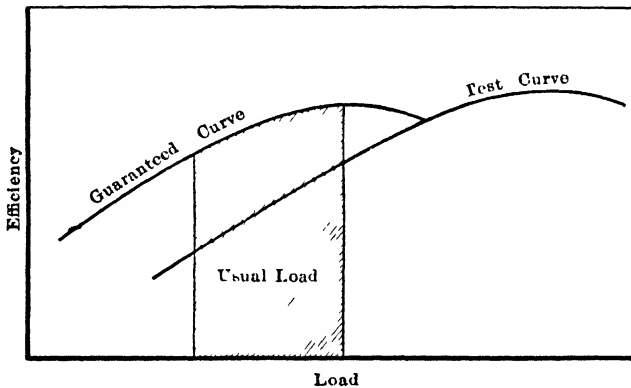

FIG. 103.

provided; it never lies down under any load put upon it and the owner is satisfied. Quite frequently also a turbine which must run at a certain speed is really adapted for a far different speed. Thus under the given conditions its efficiency may be very poor when the runner might really be excellent if operated at its proper speed. A test would show up these defects, otherwise they may remain unknown.

Another reason for making tests would be to determine the condition of the turbine after length of service. The effect of seven years' continuous operation upon a certain tangential water wheel is seen in Fig. 104. This drop in efficiency is due to roughening of the buckets, to wear of the nozzle, and to the fact that end play of the shaft together with the worn nozzle caused the jet to strike upon one side of the buckets rather than fairly in the center. It might be noted however that a 7-ft. wheel of the same make in the same plant showed no change in efficiency after

<sup>1</sup> *Trans. A. S. C. E.*, Vol. LXVI, p. 357.

the same length of service. With reaction turbines the guides and vanes become worn and the clearance spaces also wear so as to permit the leakage loss to increase.

As to whether efficiency is important or not depends upon circumstances. If there is an abundance of water in excess of the demand the only requirement is that the turbine deliver the power demanded. But where the water must be purchased, as it is in some cases, or where vast storage reservoirs are constructed at considerable expense it is desirable that water be used with the utmost economy.

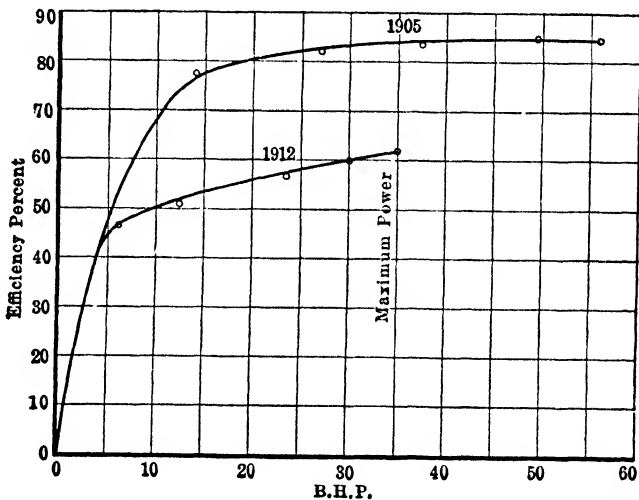

FIG. 104.—Effects of service upon a 42" tangential water wheel.

**96. Purpose of Test.**— The nature of the test will depend upon the purpose for which it is made. In a general way there are four purposes as follows:

1. *To Find Results for Particular Specified Conditions.* This will usually be an acceptance test to see if certain guarantees have been fulfilled. The guarantee will usually specify certain values of efficiency obtained at certain loads at a fixed speed under a given head. Occasionally several values of the head will be specified.

2. *To Find Best Conditions of Operation.* Such a test will cover a limited range of speed, load, and head; all of them, however, being in the neighborhood of the maximum efficiency point. A test of this nature will show what a given turbine is best fitted for,

3. *To Determine General Principles of Operation.*—This test is similar to the above except that it is more thorough. It should cover all speeds from zero to the maximum possible under no load. Various gate openings may be used and the head may also be varied. Such a test will enable one to understand the turbine better and could also be used to verify the theory.

4. *To Investigate Losses.*—This test would be similar to the preceding except that a number of secondary readings of velocities, pressures, etc., at various points might be taken. Such a test will be of interest chiefly to the designer.

**97. Measurement of Head.**—The head should be measured as close to the wheel as possible in order to eliminate pipe-line losses. The head to be used should be as specified in either equation (7) or (8) or (9) of Art. 55, according to circumstances. The pressure may be read by means of a pressure gage if it is high enough. For lower heads, a mercury column or a water column will give more accurate results. Care should be taken in making connections for the pressure reading so that the true pressure may be obtained. The reading of any piezometer tube will be correct only when the tube leaves at right angles to the direction of flow and when its orifice is flush with the walls of the pipe. No tube projecting within the pipe will give a true pressure reading, even though it be normal to the direction of flow.<sup>1</sup>

**98. Measurement of Water.**—The chief difficulty in turbine testing is the measurement of the water used. In some commercial plants the circumstances are such that it is scarcely possible to measure the water at all and in others the expense is prohibitive. The necessity of cheap and accurate means of determining the amount of water discharged is imperative.

The standard method of measurement is by means of a weir. For large discharges, however, the expense of constructing a suitable weir channel may be excessive, and, in case the turbine discharges directly into a river, it may be almost impossible to construct it. In the case of a turbine operating under a low head the increase in the tail-water level caused by the weir may cause a serious decrease in head below that normally obtained. This would make the test of little value. However, where it is feasible, the use of a weir is a very satisfactory method and should be provided for when the plant is constructed. It should be remembered, though, that all weir formulas and coefficients are purely

<sup>1</sup> Hughes and Safford, "Hydraulics," p. 104.

empirical in their nature and that the discharge as determined by them may be as much as 5 per cent. in error, unless standard proportions are carefully adhered to.<sup>1</sup>

In order to avoid the increase in the tail-water level the use of submerged orifices may be desirable in low-head plants. A submerged orifice will produce a certain elevation of the tail-water level, but it will not be as great as the weir. At present enough experimental data had not been gathered to make this method applicable in general, but perhaps in the future it may be used with fair success.

Either in the tail race or in the head race a Pitot tube, current meter, or floats may be used. These methods involve no disturbance of the head under which the turbine ordinarily operates, but they do require a suitable channel in which the observations can be taken. These instruments should be in the hands of a skilled observer who understands the sources of error attendant upon their use.<sup>2</sup>

The Pitot tube consists of a tube with an orifice facing the current. The impact of the stream against this orifice produces a certain pressure which is proportional to the square of the velocity. If  $h$  is this reading in feet of water and  $K$  and experimental constant, then

$$V = K\sqrt{2gh}.$$

Since it would be very difficult to determine accurately the height of the column of water in a tube above the level of the stream it is customary to use two tubes and read the difference between the two. For convenience in reading, the instrument is made so that valves may be closed and the device lifted out of the water without changing the levels of the columns, or sometimes both columns may be drawn up to a convenient place. The orifice for this second tube is usually in a plane parallel to the direction of flow and will thus give a lower reading than the other. It does not, however, give the value of the pressure at that point, as stated in Art. 97. For low velocities it is desirable to magnify this difference in the two readings and for that purpose the orifice of the second tube may be directed down stream. Its reading will then be less than for the one parallel to the direction of

<sup>1</sup> See "Weir Experiments, Coefficients, and Formulas," by R. E. Horton, U. S. G. S. Water Supply and Irrigation Paper No. 150, Revised, No. 200.

<sup>2</sup> See Hoyt and Grover, "River Discharge."

flow. Such an instrument is called a pitometer, and the value of  $K$  for it is always less than 1.0.

The current meter is an instrument having a little wheel which is rotated by the action of the current, the speed of rotation being proportional to the velocity of flow.

The Pitot tube may also be used in a pressure pipe. Since the reading of the impact tube alone will be the sum of the pressure head plus the velocity head it will be necessary to use two tubes in the same manner as in the case of the open channel. The value of  $h$  will be the difference between these two readings, and the value of  $K$  must be determined experimentally. If, however, only one orifice is used and the pressure is determined by a piezometer tube with its orifice lying flush with the walls of the pipe the difference between these two readings may be considered equal to the velocity head, that means the value of  $K = 1.0$ .

For the tangential water wheel the Pitot tube may also be used to determine the jet velocity. In such a case only the impact tube is required. While it is well to determine the value of  $K$  experimentally, yet if the tube is properly constructed it may be taken as 1.0. A check on this may be obtained as follows: It is probably true that the maximum velocity obtained at any point in the jet is the ideal velocity. The latter can be computed from the head back of the nozzle and the value of  $K$  should be such as to make the two agree. Either in the pipe or the jet it is desirable to take a velocity traverse across each of two diameters at right angles to each other. In computing the average velocity it is necessary to weight each of these readings in proportion to the area affected by them.<sup>1</sup>

Chemical methods are often of value. If the pipe line is sufficiently long a highly colored stain may be added to the water at intake and the time noted that it takes the color to appear in the tail race. From this and the pipe dimensions the rate of discharge can be computed. A second chemical method is to inject a salt solution into the water of known concentration and

<sup>1</sup> See "Application of Pitot Tube to Testing of Impulse Water Wheels," by Prof. W. R. Eckart, Jr., *Institution of Mechanical Engineers*, Jan. 7, 1910. Also printed in *Engineering* (London), Jan. 14, 21, 1910.

*Engineering News*, Vol. LIV, Dec. 21, 1905, p. 660. See also *Zeitschrift des ver. deut. Ing.*, Mar. 22, 29, and Apr. 5, 1913. For useful information regarding all the methods of measurement given here see Hughes and Safford, *Hydraulics*.

at a known constant rate. Samples of the water, after thorough mixing, are taken and analyzed. Knowing the amount of dilution it is then possible to compute the rate of discharge.<sup>1</sup>

**99. Measurement of Output.**—The determination of the power output of a turbine is also a matter of some difficulty. Perhaps the most satisfactory method is to use some form of a Prony brake or absorption dynamometer.<sup>2</sup>

The use of a simple brake is restricted to comparatively small powers. For large powers it becomes rather expensive and difficult. A good absorption dynamometer may be used satisfactorily for fairly large powers but the drawback is one of initial expense. In many cases also where turbines are direct connected to electric generators it may be impossible to attach a brake of any kind.

In such cases it is necessary to supply an electrical load for the generator and determine the generator efficiency. However, this method of testing involves a number of instrument readings which may be more or less in error and a rather complicated process of computation. Nevertheless it can be done with very satisfactory results. One drawback about it is that the speed cannot be varied through the same range of values as in the brake test. The output of the generator may be absorbed by a water rheostat which will furnish an absolutely constant load. If it is a direct-current machine this rheostat may simply consist of a number of feet of iron wire wound on a frame and immersed in water to keep it cool. This water should be running water or a large pond so that its temperature may not change. The current is shorted through this coil; the load is varied by changing the length of wire in use. For a three-phase alternator the rheostat may consist of three iron pipes at the vertices of an equilateral triangle with a terminal connected to each. The load is varied by changing the depth of immersion of the pipes in water.<sup>3</sup>

A good method recently employed in a hydro-electric plant where there are two or more similar units is to let one alternator drive the other as a synchronous motor. The second rotates the impulse wheel or reaction turbine in the reverse direction.

<sup>1</sup> B. F. Groat, "Chemi-hydrometry and precise Turbine Testing," *Trans. A. S. C. E.*, Vol. LXXX, p. 951 (1915).

<sup>2</sup> C. M. Allen, "Testing of Water Wheels after Installation," *Journal A. S. M. E.*, April 1910.

<sup>3</sup> *Power*, Vol. XXXVII, June 17, 1913, p. 857.

By running varying quantities of water through the latter it is possible to supply any constant load desired.

**100. Working Up Results.**—In figuring up the results of test data it should be borne in mind that any single reading may be in error but that all of them should follow a definite law. Thus a smooth curve should be drawn in all cases. Also if any readings should follow a law which is any approach to a straight line it is better to work from values given by that line rather than from the experimental values themselves. Thus if a turbine be tested at constant gate opening and at all speeds, the curve showing the relation between speed and efficiency may be drawn at once from the experimental data. However, a more accurate curve can be constructed by noting that the relation between speed and brake reading is a fairly straight line. See Fig. 86. This is not a straight line but the curvature is not very marked so that it may be drawn readily and accurately. Values given by this curve may then be used for constructing the efficiency curve. Again, when a turbine is tested at constant speed, it should be noted that the relation between input and output is not a straight line absolutely, but it is approximately so. If any point falls decidedly off from a straight line it is probably in error. From the line giving the relation between input and output the efficiency curve may be constructed.

In computing the true power in a jet it might also be noted that it is not that given by using the square of the average velocity but something 1 or 2 per cent. higher than that. The reason is that the velocity throughout the jet varies and the summation of the kinetic energy of all the particles is not that obtained by using the average velocity.<sup>1</sup>

**101. Determination of Mechanical Losses.**—With the tangential water wheel the mechanical losses will consist of bearing friction and windage. With the reaction turbine they will consist of the bearing friction and the disk friction due to the drag of the runner through the water in the clearance spaces. There are several ways of determining this but the retardation method is probably as satisfactory as any. The turbine is brought up to as high a speed as is possible or desirable and the power shut off. As the machine slows down readings of instan-

<sup>1</sup> L. M. Hoskins, "Hydraulics," p. 119.

L. F. Harza, *Engineering News*, Vol. LVII, Mar. 7, 1907, p. 272.

See also Prof. Eckart's paper previously mentioned.



taneous speed are taken every few seconds and a curve plotted between instantaneous speed and time as shown in Fig. 105. Instantaneous speed may be determined by a tachometer, by a voltmeter, or by an ordinary continuous revolution counter. With the latter the total revolutions are read every few seconds without stopping it; the difference between two consecutive readings will then enable us to find the average speed corresponding to the middle of this time interval.

The power lost at any speed is equal to a constant times the subnormal to the curve at that speed. If  $L$  equals the power lost then

$$L = K \times BD.$$

For the proof of this proposition see Appendix A.

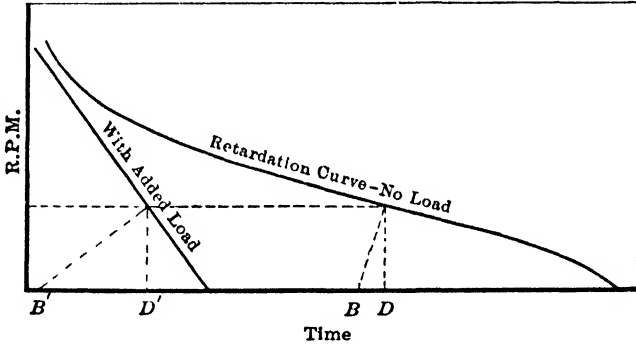

FIG. 105.—Retardation curves.

To determine the value of the constant  $K$  a second run is necessary with a definite added load. This load, which may be small, may be obtained by closing the armature circuit on a resistance if a generator is used in the test or by applying a known torque if a Prony brake is used. With the first method a watt-meter should be used and the load kept constant for a limited range of speed, with the second method the torque should be kept constant for a limited range of speed. If this known added load be denoted by  $M$  we then have

$$L + M = K \times B'D'.$$

Since  $L$  is the only unknown quantity except  $K$  it may be eliminated from these two equations and we have

$$K = \frac{M}{B'D' - BD}$$

In some work that the author has done this method has proven to be very reliable and has checked with values of friction and windage losses as determined by other methods.

### 102. QUESTIONS AND PROBLEMS

1. What is the value of testing a turbine upon installation? What is the value of testing one that has been in operation for some time? What is the value of a Holyoke test to the purchaser of another runner but of similar type? Is it cheaper to increase the power output of a plant by additional construction or by improving the efficiency?

2. What are the various purposes for which turbine tests may be conducted? What conditions would be varied for each of these and what kept constant?

3. What methods of measuring the rate of discharge are usually employed in turbine tests?

4. In what ways may the power output of a waterwheel be absorbed and measured?

5. A case is reported where tests conducted at an expense of \$5000 resulted in changes which improved the efficiency of the turbines 1 per cent. If the capacity of the plant is 100,000 h.p. and 1 h.p. is worth \$100, what would be the value of the gain in efficiency, assuming the changes cost \$20,000?

6. In the Cedars Rapids turbines the area of the water passages at entrance to the casing = 1080 sq. ft. per unit, elevation of section above tail water = 10 ft., and pressure head at this point = 20 ft. The area of the mouth of the draft tube = 1050 sq. ft. The test showed the power output to be 10,800 h.p. with a rate of discharge of 3450 cu. ft. per second. Calculate two values of the efficiency, using two values of the head.

7. In the test of a reaction turbine the water flowing over the weir in the tail race was found to be 39.8 cu. ft. per second. The leakage into the tail race was found to be 1 cu. ft. per second. The elevation of the center line of the shaft above the surface of the tail water was 12.67 ft. The diameter of the turbine intake was 30 in. and the pressure at this section was measured by a mercury U tube. The readings in the two sides of the mercury U tube were 10.556 ft. and 0.900 ft., the zero of the scale being at a level 3.82 ft. below that of the center line of the turbine shaft. The generator output was 391.8 kw., friction and windage 13.8 kw., iron loss 2.0 kw., and armature loss 4.4 kw. The specific gravity of the mercury used was 13.57. Find: Input to turbine, output of turbine (generator being excited from another unit), efficiency of turbine, efficiency of generator, efficiency of set.

*Ans.*  $h = 141.80$  ft., 625 w.h.p., 550 b.h.p., 0.880, 0.951, 0.837.

## CHAPTER XI

### GENERAL LAWS AND CONSTANTS

**103. Head.**—The theory that has been presented has made it clear that the speed and power of any turbine depends upon the head under which it is operated. The peripheral speed of any runner may be expressed as  $u_1 = \phi\sqrt{2gh}$ . It has also been shown that for the best efficiency  $\phi$  must have a certain value depending upon the design of the turbine. It is thus apparent that the best speed of a given turbine varies as the square root of the head.

The discharge through any orifice varies as the square root of the head, and a turbine is only a special form of discharge orifice. Since  $V_1 = c\sqrt{2gh}$ , and since a definite value of  $c$  goes with the best value of  $\phi$  as given above, it follows that the rate of discharge of a given turbine varies as the square root of the head.

Since the energy of each unit volume of water varies as the head, and since the amount of water discharged per unit time varies as the square root of the head it must then be true that the power input varies as the three halves power of the head.

In reality the rate of discharge through any orifice is not strictly proportional to the square root of the head, that is, the coefficient of discharge is not strictly a constant but varies slightly with the head. However, the variation in the coefficient is small and inappreciable except for very large differences in the head. Therefore the above statements are accurate enough for most practical purposes.

The theory has also shown that the losses of head in any turbine vary as the squares of the various velocities concerned. This rests upon the assumption that the coefficient of loss  $k$  is constant for all values of  $h$  as long as  $\phi$  remains constant. That is probably not true, but may be assumed as true for all practical purposes. Since these velocities vary as the square root of the head their squares will vary as the first power of the head. The amount of water varies as the square root of the head and, since the power lost is the product of these two items, it follows that

the various hydraulic losses vary as the three-halves power of the head. As the hydraulic losses vary in just the same proportion as the power input, the hydraulic efficiency will be independent of the value of the head. If the mechanical losses followed the same law then the gross efficiency would also remain unchanged. The mechanical losses really follow different laws at different speeds, as can be seen in Fig. 106. The factors which influence this are rather complicated and it does not seem possible to lay down any rule to express mechanical losses as a function of the speed. It is probably true, however, that these losses increase faster than the first power of the speed but not much faster than the square of the speed. Since the speed varies as

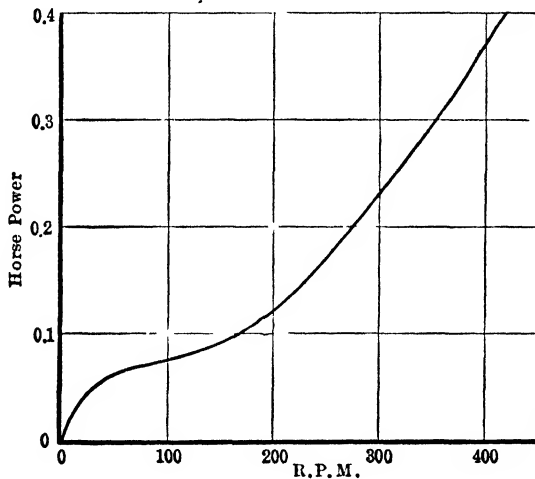

FIG. 106.—Friction and windage of a 24" tangential water wheel.

the square root of the head it is seen that if the friction losses vary at the same rate as the hydraulic losses they must increase as the cube of the speed. As they do not do so, it is apparent that the gross efficiency will be higher the higher the head under which the turbine operates. The change in the gross efficiency with a change in head is most apparent when the latter is very low. As the head increases the mechanical losses become of smaller percentage value and the gross efficiency tends to approach the hydraulic efficiency, which is constant, as a limit. Thus there is little variation in efficiency unless the head is very low.

The mechanical losses are really comparatively small being only from 2 to 5 per cent. usually and thus the change in gross efficiency cannot be very great. For moderate changes in head

we may then state that the efficiency of a turbine remains constant as long as the speed varies so as to keep  $\phi$  constant. Therefore the power output of a given turbine varies approximately as the three-halves power of the head.

This proposition is rather important because it is often necessary to test a turbine under a certain head which is different from the head under which it is to be run. The question may then arise as to how far the test results can be applied to the new head. As long as the two heads are not radically different we may state that they will apply directly. If there is a large difference in head we may expect that the efficiency under the higher head may be one or two or more per cent. higher. This is borne out by some tests made by G. F. Switzer and the author where the head was varied from 30 ft. to 175 ft. and later from 9 ft. to 305 ft.

It is customary to state the performance of a turbine under one foot head. Then by means of the above relations we may easily tell what it will do under any head. If the suffix (1) denotes a value for one foot head we may then write,

$$N = N_1\sqrt{h} \quad (44)$$

$$q = q_1\sqrt{h} \quad (45)$$

$$h.p. = h.p._1 h^{3/2} \quad (46)$$

It must be noted that these simple laws of proportion may be applied only when the speed varies with the head in such a way as to keep  $\phi$  constant. The value of  $\phi$  need not necessarily be that for the highest efficiency. But if the speed does not change or if it varies in some other way so that  $\phi$  is different, the results under the new head cannot be computed save by complex equations, such as those of Arts. 87 and 88, or by the use of test curves such as those of Figs. 95 and 96.

**104. Diameter of Runner.**—When a certain type of runner has been perfected a whole line of stock runners of that type may then be built with diameters ranging from 10 to 70 in. or more. All of these runners will be homologous in design, that is they will have the same angles and the same values of the ratios  $x$ ,  $y$ , and  $B/D$ . Each runner will simply be an enlargement or reduction of another. They will then have the same characteristics, that is, the same values of  $\phi_e$  and  $c_e$ , and will therefore follow certain laws of proportion.

\* The easiest way to find  $h^{3/2}$  is to note that  $h^{3/2} = h\sqrt{h}$ . This may be found in one setting of the slide rule.

Since for a given head  $u_1$  will have the same value for all of them, it follows that for a series of runners of homologous design the best r.p.m. will be inversely proportional to the diameter.

Since the discharge through any runner is equal to  $A_1 c \sqrt{2gh}$ , and since  $c$  will have essentially the same value for all the runners of such a series, the discharge will be proportional to the area  $A_1$ . But if the runners are strictly homologous the area  $A_1$  will be proportional to the square of the diameter. It will therefore be true that the discharge of any turbine of the series will be proportional to the square of the diameter.

Since the power is directly related to the discharge it also follows that the power of the turbine is proportional to the square of the diameter.

These relations are of practical value because if the speed, discharge, and power of any runner is known by accurate test, predictions may then be made regarding the performance of any other runner of the series. These laws may not hold absolutely in all cases because the series may not be strictly homologous, that is the larger runners may differ slightly from the smaller ones. Also it will no doubt be true that the efficiency of the larger runners will be somewhat higher than that of the smaller ones. It may also be found that careful tests of two runners made from the same patterns will not give exactly the same results due to difference in finish or other imperceptible matters. Despite these factors, however, the relations stated are true enough to be used for most purposes.

**105. Commercial Constants.**—For a given turbine the maximum efficiency will be obtained only for a certain value of  $\phi$ . All tables in catalogs of manufacturers as well as all values given in this chapter are based upon the assumption that the speed will be such as to secure this value of  $\phi$ . Substituting values of  $N$  and  $D$  for  $u_1$  in the expression  $u_1 = \phi \sqrt{2gh}$ , we obtain

$$N = \frac{1840\phi\sqrt{h}}{D} \quad (47)$$

where  $D$  is the diameter of the runner in inches. From this may also be written

$$\phi = 0.000543 \frac{DN}{\sqrt{h}} \quad (48)$$

Since  $\phi_c$  is constant for any series of runners of homologous design, it follows from (48) that the expression  $\frac{DN}{\sqrt{h}}$  must remain

a constant. If, then, the best r.p.m. of any diameter of runner under any head is determined, the proper r.p.m. of any other runner of the series under any head may be readily computed.

For the tangential water wheel:

$$\phi_e = 0.43 \text{ to } 0.47$$

$$\frac{DN}{\sqrt{h}} = 790 \text{ to } 870.$$

For the reaction turbine:

$$\phi_e = 0.55 \text{ to } 0.90.$$

$$\frac{DN}{\sqrt{h}} = 1050 \text{ to } 1600.$$

If values outside these limits are met with it is because the speed is not the best or because the nominal value of  $D$  is not the true value.

**106. Diameter and Discharge.** Since, for any fixed gate opening and a constant value of  $\phi$ , the rate of discharge of any runner is proportional to the square of its diameter and to the square root of the head, we may write

$$q = K_1 D^2 \sqrt{h} \quad (49)$$

The value of  $K_1$  depends upon the velocity  $V_1$  and the area  $A_1$ . The former depends upon the value of  $c$  (Art. 83), and the latter depends upon the diameter  $D$ , the height of the runner  $B$  (Fig. 34), the value of the angle  $\alpha_1$ , and also the number of buckets and guides.

Since there are so many factors involved, it will be seen that a given value of  $K_1$  can be obtained in several ways. For some purposes it might be convenient to express these items by separate constants but for the present purpose it will be sufficient to cover all of them by the one constant.

The lowest value of  $K_1$  will be obtained for the tangential water wheel with a single jet. For this type of wheel there is evidently no minimum value of  $K_1$  below which we could not go. The maximum value of  $K_1$  is, however, fixed by the maximum size of jet that may be used. (See Art. 30 and Art. 74.) Using this maximum size of jet we obtain a value of  $K_1 = 0.0005$ . However the more usual value is about  $K_1 = 0.0003$ . There is seldom any reason for using a large diameter of wheel with a small jet and so much lower values are rare.

With the reaction turbine the lowest values of  $K_1$  would be obtained with type *I* in Fig. 34 and the highest with type *IV*. The value of the area  $A_1$  is proportional to the sine of  $\alpha_1$  and normally small values of  $\alpha_1$  go with small values of the ratio  $B/D$ . Taking the usual values that go with either extreme we get a minimum value of  $K_1 = 0.0010$  and a maximum value  $K_1 = 0.050$ . These are not absolute limits but they cannot be exceeded very much and to do so at all would mean to extend our proportions of design beyond present practice. For the usual run of stock turbines values of  $K_1$  vary from 0.005 to 0.025. To summarize:

For the tangential water wheel  $K_1 = 0.0002$  to  $0.0005$

For the reaction turbine  $K_1 = 0.001$  to  $0.050$

**107. Diameter and Power.**—Since the power of any runner is proportional to the square of the diameter and to the three-halves power of the head, we may write

$$h.p. = K_2 D^2 h^{3/2} \quad (50)$$

As the power is directly dependent upon the discharge it is evident that the discussion in the preceding article will apply equally well here.  $K_2$  may be computed directly from  $K_1$  if the efficiency is known, or it may be determined independently by test.

For the tangential water wheel  $K_2 = 0.000018$  to  $0.000045$

For the reaction turbine  $K_2 = 0.00008$  to  $0.00450$

**108. Specific Speed.**—In Art. 105 we have the relation between diameter and r.p.m.; in Art. 107 we have the relation between diameter and power. It is now desirable to establish the relation between r.p.m. and power as follows:

From (47)

$$D = \frac{1840 \phi \sqrt{h}}{N}$$

From (50)

$$\sqrt{K_2} D = \frac{\sqrt{h.p.}}{h^{3/4}}$$

Substituting the above value of  $D$  in the second expression we have

$$\sqrt{K_2} \frac{1840 \phi \sqrt{h}}{N} = \frac{\sqrt{h.p.}}{h^{3/4}}$$



Letting  $N_s$  stand for the constant factors and rearranging we have

$$N_s = \frac{N\sqrt{h.p.}}{h^{5/4}} \quad (51)$$

This expression is a very useful factor and is called the specific speed. It is also called unit speed or type characteristic or characteristic speed by various writers. Its physical meaning can be seen as follows: If the head be reduced to 1 ft. then  $N_s = N\sqrt{h.p.}$ . By then varying the diameter of the runner the value of  $N$  will change in an inverse ratio, but the square root of the horsepower varies directly as  $D$ . Thus the product of the two or  $N_s$  remains constant for all values of  $D$  as long as the series is homologous. If a value of  $D$  be chosen which will make the  $h.p. = 1.0$  when  $h = 1$  ft., we then have  $N_s = N$ .

That is, the specific speed is the speed at which a turbine would run under one foot head if its diameter were such that it would develop 1 h.p. under that head. The specific speed is also an excellent index of the class to which a turbine belongs and hence the term type characteristic is very appropriate. There is no standard symbol used by all to denote this constant though  $N_s$  is quite common. Other notations are  $N_u$ ,  $K_T$ , and numerous others. In Europe the specific speed will be expressed in metric units; to convert from one to the other multiply  $N_s$  in English units by 4.45.

It should be noted that the power to be used in this formula is the power output of the machine. Thus the efficiency is involved in the value of  $N_s$ , though it does not appear directly. In the case of a Pelton wheel with two or more nozzles, the power to be used is that corresponding to only one jet. In the case of multi-runner units, the specific speed should be computed for the power of one runner.

For any turbine the value of  $N_s$  is a constant, so long as the speed of the turbine is varied as the square root of the head. For if  $N$  varies as  $\sqrt{h}$  and the power varies as  $h^{3/2}$ , it is seen that  $N\sqrt{h.p.}$  varies as  $h^{5/4}$ . Also for a series of homologous runners the square root of the power increases with  $D$  directly while the speed  $N$  varies inversely. Thus the factor is a constant for all turbines of the same type.

The value of the specific speed is ordinarily computed by equa-

$$*h^{5/4} = h \times h^{1/4} = h\sqrt{\sqrt{h}}$$

tion (51), since this involves the quantities with which the engineer is most concerned. But the great practical value of this factor in turbine work is such as to make it worth while to derive this expression in other ways and in terms of other quantities. Thus

$$u_1 = \pi DN/720 = \phi\sqrt{2gh}$$

From which  $D = 720\phi\sqrt{2gh}/\pi N$  (52)

Also, if  $B = mD,$

$$q = (0.95\pi BD/144)V_{r1} = 0.95\pi mD^2c_r\sqrt{2gh}/144$$
 (53)

where 0.95 is a factor to compensate for the area taken up by the runner vanes.

Since  $B.h.p. = wqhe/550$

$$B.h.p. = 0.95 w\pi\sqrt{2gm} D^2c_r h^{3/2} e/144 \times 550$$
 (54)

Eliminating  $D$  between the simultaneous equations (52) and (54) and reducing, we have (giving  $\phi$  the special value  $\phi_e$ )

$$N_s = \frac{N\sqrt{B.h.p.}}{h^{5/4}} = 252\phi_e\sqrt{c_r \times m \times e}$$
 (55)

This equation shows how the value of the specific speed may be varied in the design by means of the factors  $\phi_e, c_r,$  and  $m.$ <sup>1</sup>

An instructive form, however, is that of Lewis F. Moody, in which the diameter of the draft tube is represented as  $nD,$  and the discharge velocity head  $V_2^2/2g = Lh,$  where  $L$  is the fractional part of the head  $h$  that is lost at discharge from the runner. (Of course an efficient draft tube is relied upon to recover a part of this). With these we may write

$$q = \frac{\pi(nD)^2}{4 \times 144} V_2 = \frac{\pi(nD)^2}{4 \times 144} \sqrt{L} \times \sqrt{2gh}$$
 (56)

Substituting this expression for  $q$  in that for horsepower, we obtain

$$B.h.p. = w\pi\sqrt{2gn^2D^2}\sqrt{Lhe}/4 \times 144 \times 550$$
 (57)

Eliminating  $D$  between the simultaneous equations (52) and (57) and reducing, we have

$$N_s = \frac{N\sqrt{B.h.p.}}{h^{5/4}} = 129.5n\phi_e\sqrt{\sqrt{L}\sqrt{e}}$$
 (58)

<sup>1</sup>In a similar manner the specific speed for a Pelton wheel may be shown to be,  $N_s = 129\phi_e\sqrt{c_v e} \frac{d}{D}$  where  $d$  = jet diameter in inches. Since, for the impulse wheel  $\phi_e$  and  $c_v$  are practically constant this may be reduced to  $N_s = 53.7 \frac{d}{D}$

While the equation in this form shows how the specific speed may be varied in design by changing the factors  $n$ ,  $\phi_e$ , and  $L$ , its chief use is in showing the limit which the specific speed approaches. Thus to increase the value of  $N_s$ , the ratio  $n$  may be increased. But it will soon reach a definite limit. The factor  $\phi_e$  may also be increased, but it also will reach a definite limit, which is something under 1.0. The efficiency cannot readily be increased any more than for lower specific speed runners and as a matter of fact, is already decreasing. Thus after these factors have reached their maximum limits, so that they may be assumed to be constant, the only means of increasing  $N_s$  any further would appear to be by increasing  $L$ . Thus

$$N_s \propto \sqrt{\sqrt{L}} \text{ or } L \propto N_s^4 \quad (59)$$

But after this limit is passed so that equation (59) applies, the outflow loss increases much faster than the specific speed. Even with the best of draft tubes a certain percentage of  $L$  must be lost eventually and hence  $e$  is rapidly reduced. The outflow conditions thus impose a maximum limit upon  $N_s$ .

For the lower values of  $N_s$  the outflow loss becomes of small consequence, but other factors then enter. The chief of these are the leakage losses and the disk friction. For with small values of the specific speed the runner becomes relatively large in diameter and correspondingly narrow. The area of the spaces through which water can leak becomes of greater percentage as compared with the area through the runner. And the percentage of the power consumed in rotating the large diameter runner through the water in the clearance spaces becomes of increasing importance. If we assume that the power lost in disk friction varies as  $D^5 N_s^3$ , it may be readily shown by combining this with equations (51) and (52) that the power so lost varies as  $\phi_e^5 / N_s^2$ . After  $\phi_e$  has been reduced to its minimum, which approaches 0.50 as a limit, any further decrease in  $N_s$  increases the disk friction loss much more rapidly. Also as  $\phi_e$  is decreased  $c_e$  must increase (approaching unity as a limit), as shown by equation (39), and consequently  $p_1$  decreases (approaching zero as a limit). But this is undesirable, due to the danger of oxidation of parts of the runner.

In view of these facts, it may be shown that the minimum allowable value for the specific speed of a reaction turbine is about 10,

though there are a few extreme cases of design that have carried it as low as about 9. With present draft tube construction, the maximum limit for the specific speed of a reaction turbine is about 100, though values as high as 130 are attainable at some sacrifice of efficiency. The usual range in practice varies from about 20 to 80.

A very recent type of turbine runner proposed by Nagler is of an axial flow type and is similar to a screw propeller. The present specific speed of this type is 165 and it is possible that this may be extended in the future.<sup>1</sup>

The impulse turbine runs in air and thus the disk friction loss for it becomes windage loss, which is of less consequence. There can be no leakage loss with this type and also the reduction of the pressure to atmospheric gives rise to no trouble. Hence this type of turbine is suitable for specific speeds below those for the reaction turbine. For the tangential water wheel there is no definite lower limit to its specific speed, save that the windage loss affects it in a similar manner to the disk friction in the case of the low-speed reaction turbine. But as the specific speed of a Pelton wheel is increased the size of the jet must become larger in proportion to that of the wheel and for the reasons already given there is a limit to this. The further increase in ratio of jet diameter to wheel diameter causes the efficiency to rapidly decrease, due to loss of water past the buckets. There have been cases of tangential wheels with specific speeds of less than 1 and maximum values of 6, though the latter involves some sacrifice of efficiency. The usual range in practice is from 3 to 4.5.

It will be seen that there is a gap in the values of  $N_s$  between the tangential water wheel and the reaction turbine. Similar gaps are also found for the values of  $\phi_e$ ,  $K_1$ , and  $K_2$ . In Europe a few two-stage radial inward-flow reaction turbines have been built and these could have lower values of the specific speed than 10. And by the use of two or more nozzles on one impulse wheel runner, the value of  $N_s$  for the tangential wheel can be increased above the 5 or 6 set as the limit for the single nozzle. Thus the entire field can be covered.

To recapitulate:

For the tangential water wheel  $N_s = 3.5$  to  $4.5$  (6 max.)

For the reaction turbine  $N_s = 10$  to  $100$ .

<sup>1</sup>See *Jour. of the Amer. Soc. of Mech. Eng.*, Dec., 1919.

**109. Determination of Constants.**—The constants given in this chapter may be computed from theory, but for practical use should be secured from test data. The catalogs of turbine manufacturers usually contain tables giving the discharge, power, and speed of different diameters of runners under various heads. As these tables are supposed to be based upon tests they may be used for the determination of these factors. If all the runners of the series were strictly homologous it would be necessary to compute these constants for one case only. Actually variations will exist with different diameters of runners and thus there will be some variation in the values secured. Since each manufacturer usually makes several lines of runners so as to cover the field to better advantage, there will be as many distinct values of these constants as he makes types of runners. If the catalog tables are purely fictitious then the computations based upon them will not be very reliable.

**110. Illustrative Case.**—In order to illustrate the preceding article the following tables are given. For the sake of comparison only two firms out of many are chosen for this case. The values given are based upon catalog tables. Since  $K_2$  depends upon  $K_1$  it has been omitted to save space.

TABLE 3.—JAMES LEFFEL AND CO.

| Type                 | $\phi$      | $K_1$         | $N_s$     |
|----------------------|-------------|---------------|-----------|
| Standard.....        | 0.722-0.727 | 0.0061-0.0064 | 30.8-32.6 |
| Special.....         | 0.750-0.779 | 0.0094-0.0097 | 41.6-43.2 |
| Samson.....          | 0.838-0.844 | 0.0170-0.0171 | 61.5-61.9 |
| Improved Samson..... | 0.856-0.886 | 0.0220-0.0220 | 71.0-73.5 |

TABLE 4.—DAYTON GLOBE IRON WORKS CO.

| Type                      | $\phi$      | $K_1$         | $N_s$     |
|---------------------------|-------------|---------------|-----------|
| High head type.....       | 0.578-0.585 | 0.0051-0.0064 | 22.8-26.0 |
| American.....             | 0.662-0.704 | 0.0054-0.0080 | 25.0-32.3 |
| Special New American..... | 0.697-0.727 | 0.0175-0.0205 | 50.0-57.4 |
| Improved New American...  | 0.886-0.944 | 0.0233-0.0263 | 78.2-80.5 |

This table shows the variation in constants that might be expected, and shows also how each firm attempts to cover the ground. It will be noticed, however, that the two do not agree in all respects. Thus suppose a turbine was desired whose speci-

fic speed was 42. The "Special" turbine of the Leffel Co. would fulfill the conditions, but the Dayton Globe Iron Works Co. have no line of turbines that would exactly answer the requirement. The latter firm might furnish a turbine that would have the required specific speed but it would have to be a special design—it would not be a stock turbine, and would therefore be more expensive.

**111. Uses of Constants.**—After these factors are determined it will then be easy to find what results may be secured for any size turbine of the same design under any head. Another use for them is that when the limits are fixed they will enable one to tell what is possible and what is not. In the next chapter it will be shown how they are of direct use also in the selection of a turbine.

**112. NUMERICAL ILLUSTRATIONS**

1. The test of a 16-in. runner under a 25-ft. head gave the following as the best results:  $N = 400$ ,  $q = 17.5$  cu. ft. per second, h.p. = 39.8. Find the constants.

$$\text{From (48) } \phi = 0.000543 \frac{16 \times 400}{5} = 0.696$$

$$\text{From (49) } K_1 = \frac{17.5}{16^2 \times 5} = 0.01368$$

$$\text{From (50) } K_2 = \frac{39.8}{16^2 \times 125} = 0.00124$$

$$\text{From (51) } N_s = \frac{400 \times 6.32}{55.8} = 45.2$$

2. Suppose that a 40-in. runner of the same design as in problem (1) is used under a 150-ft. head. Compute the speed, discharge, and horse-power.

$$\text{From (47) } N = \frac{1840 \times 0.696 \times 12.25}{40} = 392 \text{ r.p.m.}$$

$$\text{From (49) } q = 0.01368 \times 1600 \times 12.25 = 268 \text{ cu. ft. per second}$$

$$\text{From (50) } 0.00124 \times 1600 \times 1838 = 3650 \text{ h.p.}$$

3. Suppose that turbines of the type in problem (1) were satisfactory for a certain plant but that the number of the units (and consequently the power of each) and the speed has not been decided upon. If the head is 150 ft., then by (51)

$$N \times \sqrt{h.p.} = 45.2 \times 525 = 23,730.$$

By the use of different diameters of runners of this one type the following results can be secured:

14,100 h.p. at 200 r.p.m.

6,250 h.p. at 300 r.p.m.

3,520 h.p. at 400 r.p.m.

2,250 h.p. at 500 r.p.m.

1,560 h.p. at 600 r.p.m.  
 1,150 h.p. at 700 r.p.m.  
 878 h.p. at 800 r.p.m.  
 695 h.p. at 900 r.p.m.

If the capacity of the plant were 25,000 h.p. it might then have 4 units at 300 r.p.m., 16 units at 600 r.p.m., or 36 units at 900 r.p.m. If none of the possible combinations were suitable it would be necessary to use another type of turbine—that is one with a different value of  $N_s$ .

By equation (50) the diameters are found to be 52.3 in., 26.2 in., and 17.5 in. for 300, 600, and 900 r.p.m. respectively.

4. Compute values of  $\phi$ ,  $K_1$ ,  $K_2$ , and  $N_s$  for each of the turbines whose tests are given in Appendix C: (a) for the point of highest efficiency, (b) for the point of maximum power.

### 113. QUESTIONS AND PROBLEMS

1. How do the speed, rate of discharge, power, and efficiency of a turbine vary with the head, the value of  $\phi$  remaining constant? Why?

2. Suppose the speed of a turbine remains constant while the head changes, how will the rate of discharge, power and efficiency vary? What is necessary in order to answer this question?

3. How do the speed, power, and efficiency vary with the diameter of a series of homologous runners? Why? How do these quantities change when both the head and diameter are different, the runners being of the same type, however?

4. What is the physical meaning of the term "specific speed?" Why are the terms "type characteristic" and "characteristic speed" also appropriate? How may the value of this factor be changed in the design of the runner?

5. What limits the maximum and minimum values of the specific speed for reaction turbines? For impulse wheels? Why do the latter have lower specific speeds than the former?

6. If a turbine gives an efficiency of 82 per cent. when tested under a head of 10 ft. what would you estimate its efficiency to be if installed under a head of 100 ft.? Under a head of 225 ft.? If the test of a 27-in. runner under a head of 150 ft. gives, as the best results,  $N = 600$ ,  $q = 40$ , h.p. = 550, what will be the speed, rate of discharge, and power of a 54-in. runner of the same type under a head of 50 ft.?

7. If a turbine is desired to run at 300 r.p.m. under a head of 60 ft., what are the minimum and maximum diameters of runners that might be used? If 30 cu. ft. of water per second is to be used under a head of 60 ft., what range of diameters might be employed?

8. Suppose that a type of turbine, whose specific speed is 80, is suitable for use in a certain plant where the head is 16 ft. What combinations of h.p. and r.p.m. are possible?

9. If a tangential water wheel was desired to deliver 1000 h.p. under 150 ft. head, what r.p.m. could be used? How high a speed could be obtained with a reaction turbine?

10. Would it be possible to obtain a 5000 h.p. turbine to run at 600 r.p.m. under a 50-ft. head? What could be done to secure that power? To secure 600 r.p.m.?

11. A reaction turbine is designed so that  $\phi_s = 0.72$ ,  $B/D = 0.29$ ,  $c_r = 0.20$ , and the efficiency may be assumed = 0.88. What is the value of the specific speed? Compute the probable values of the specific speeds for the four types of turbines shown in Fig. 34, making whatever assumptions are necessary.

12. The turbine, whose dimensions are given in problem (11) had a value of  $n = 1.04$ . Find the per cent. of the total head that is equal to the velocity head at discharge from the runner?



## CHAPTER XII

### TURBINE CHARACTERISTICS

114. Efficiency as a Function of Speed and Gate Opening. In Fig. 87, page 112, it has been shown how the power, and hence the efficiency, of an impulse turbine varies with the speed for

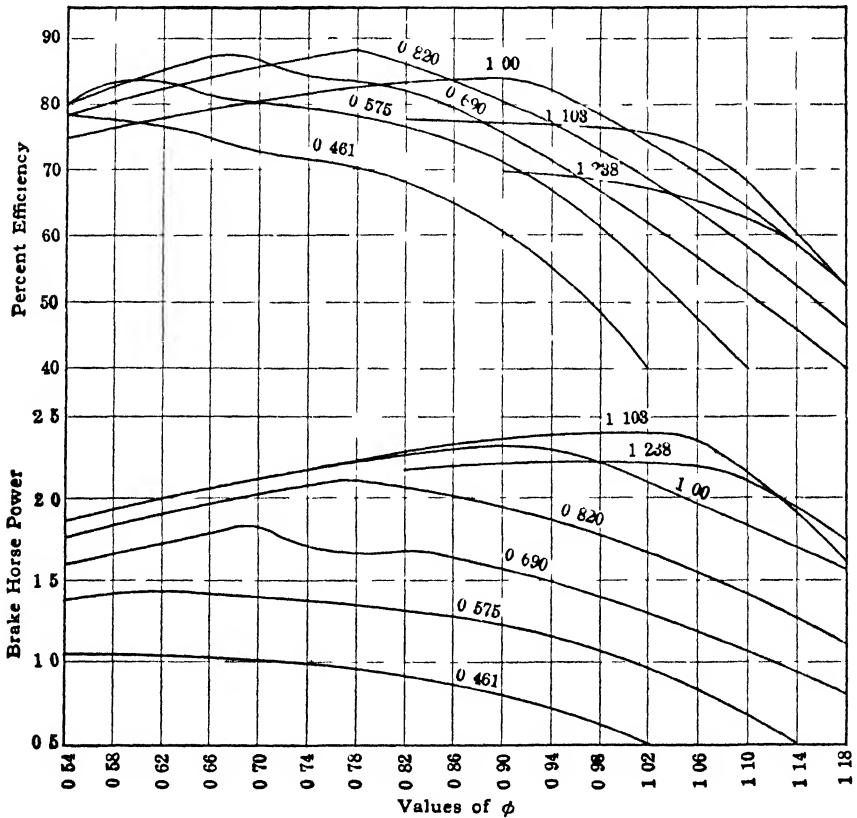

FIG 107 —Characteristics of high-speed runner  $N_s = 93$ .

any gate opening; and in Fig. 91, page 115, how the efficiency varies with the power at different gate openings at a uniform speed, the head being constant in both cases. Similar curves for a reaction turbine are shown in Figs. 96 and 98.

It should be noted that the value of  $\phi$  for the highest efficiency

at one gate opening is not the same as that for any other gate opening. This is best shown by Fig. 107, and reasons for it are given in Arts. 76 and 91. Hence the speed that is most efficient for one gate opening is not exactly the best for any other gate opening. Also the values of efficiency vary for the different gate openings and the maximum efficiency will be found at something less than "full" gate.<sup>1</sup> Therefore, in general, the maximum efficiency and the maximum power are found at different gate openings and different speeds.

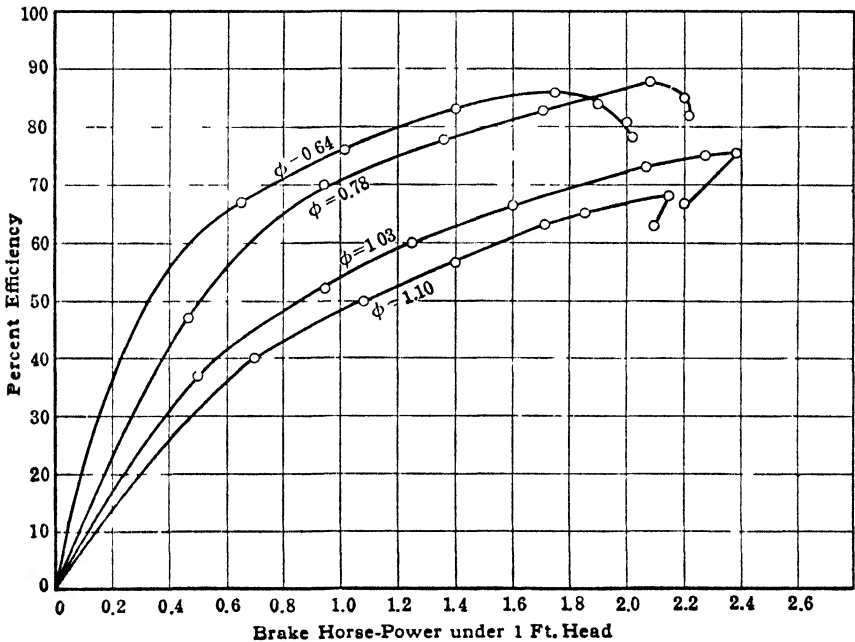

FIG. 108.—Efficiency-power curves for different speeds under same head.

Thus in Fig. 107 the maximum value of the efficiency is found at 0.820 gate and at such a speed that  $\phi_e = 0.780$ , but the maximum power is found at 1.103\* gate and at such a speed that  $\phi = 1.03$ . The efficiency in the former case is 0.88 and in the latter 0.77. In Fig. 108 are shown efficiency curves as a function of power for values of  $\phi = 0.64, 0.78, 1.03$  and 1.10.

<sup>1</sup> This statement does not hold in the case of the cylinder gate turbine, where maximum power and maximum efficiency coincide at full gate, but this type is of little importance at present.

\* The numbers indicating the extent of the gate opening are purely arbitrary and 1.0 does not necessarily indicate the maximum gate opening. This will be explained subsequently.

In selecting the proper speed for a given turbine a number of operating factors must be taken into consideration. If the head is constant and the load is constant, it may be possible to operate the turbine near the point of maximum efficiency most of the time. In this case it might be desirable to select the speed giving the maximum efficiency, or  $\phi = 0.78$  in the case above. But if the load is variable and especially if it is apt to be light for long periods of time a lower value of the speed might give a higher average efficiency, though the peak is not so high. On the other hand it may be deemed worth while to sacrifice efficiency for the sake of capacity and increased speed, which could be attained by using the higher values of the speed. It should be borne in mind that some of these results might be better attained with another type of turbine, but the latter is a subject for consideration in

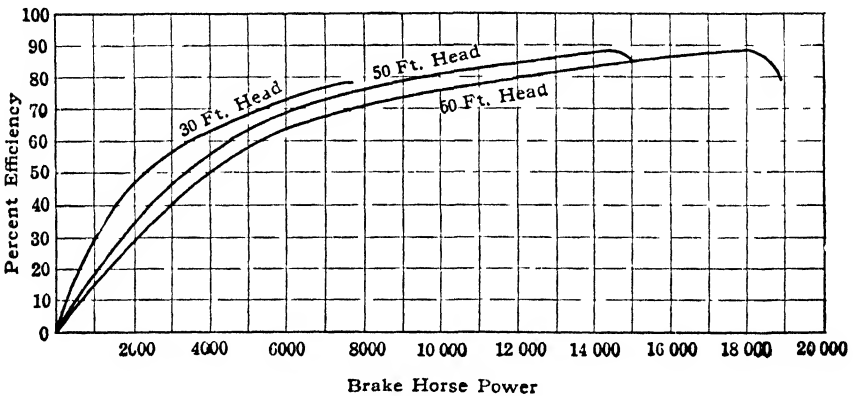

FIG. 109.—Power and efficiency of a turbine at constant speed under different heads.

the next chapter. We are here studying the possibilities of a single turbine or at least a single type of turbine.

It must be remembered, as explained in Art. 20, that the head is apt to vary for many water power plants, especially those under low head. If the head decreases in time of flood, the power output of the turbine may be seriously reduced. Under these circumstances the important consideration is the maximum power output. Since there is a superabundance of water for the time being, efficiency is a secondary consideration. While efficiency under the normal head is of importance, it might be sacrificed to some extent in favor of a speed which would be such as to give the maximum power under flood conditions. It is here assumed that, whatever speed be selected, the turbines

must run at that constant speed regardless of fluctuations in the water. If the speed is constant, it is seen that  $\phi\sqrt{h} = \text{constant}$ . Thus if the head decreases, the value of  $\phi$  must increase. In Fig. 109 may be seen the performance of a turbine at a constant speed under different heads. By making a different choice of the speed for the normal head, the results under all other conditions will be altered, and careful study must be made of all the variables to decide what is best.

**115. Specific Speed an Index of Type.**—Both the elements of speed and capacity are involved in the specific speed. It was stated in Art. 38 that both speed and capacity were merely relative terms; that is, a high-speed turbine is not necessarily one which runs at a high r.p.m., but one whose speed is high compared with other turbines of the same power under the same head. In like manner a high-capacity turbine is not necessarily one of great power but merely one whose power is high compared with others at the same speed under the same head. Since

$N_s = \frac{N\sqrt{h.p.}}{h^{5/4}}$  it is evident that a low-speed, low-capacity turbine

will be indicated by a low value of  $N_s$  and a high-speed high-capacity turbine by a high value of  $N_s$ . As stated in Art. 108, values of  $N_s$  for the tangential water wheel may run up as high as 5 or 6, for the reaction turbine they range from 10 to 130. Values in the neighborhood of 20 indicate a runner such as Type I in Fig. 34, while values in the neighborhood of 80 indicate Type IV. Thus when the speed and horsepower of any turbine under a given head are specified the type of turbine necessary is fixed.

Other things being equal, it is seen that a high head means a comparatively low value of  $N_s$  while a low head means a high value. Aside from any structural features it is apparent that a high head calls for a tangential water wheel or a low-speed reaction turbine, while a low head demands a high-speed reaction turbine. However, the head alone does not determine the value of  $N_s$ . So far as the r.p.m. is concerned there may be considerable variation, yet neither a very low nor a very high r.p.m. is desirable and for the present purpose we may suppose that it is restricted within narrow limits. The value of  $N_s$  will thus be affected by the power of the turbine as well as the head. If the head is high the value of  $N_s$  may still be high enough to require a reaction turbine. Or if the head is very low and the

power is likewise low a low value of specific speed may result. It is thus clear that the choice of the type of turbine is a function of the power and speed as well as the head.

Since a given turbine under a fixed head may be run at different speeds and gate openings, there are any number of values of  $N$  and  $h.p.$  that may be substituted in equation (51), with a resulting variety of values of  $N_s$  for the particular turbine. It is thus necessary to define the speed and power for which this factor is to be computed, if it is to have a definite value for a given runner. The current practice is to rate turbines at the maximum guaranteed capacity, the actual maximum capacity being usually slightly greater than this, since the builder allows a small margin to insure his meeting the guarantee. The *nominal* specific speed is that corresponding to this rated capacity at a stated speed. But under a given head the turbine speed might be selected from a limited range of values, as explained in Art. 114. It may be seen that, though the true maximum power of the turbine is a definite value, the actual maximum power it can deliver at full gate, under the operating conditions, depends upon the speed at which it is run. Hence the value of  $N_s$ , as thus computed, varies with the speed, and is not a perfectly definite value. Despite this, the value of specific speed is usually so computed because the rated capacity is often known when the power and speed for maximum efficiency are not.

For accurate comparisons of one turbine with another and for exact work, it is best to select the values of power and speed for which the true maximum efficiency is obtained. The value of  $N_s$ , so computed, may be called the *true* specific speed. Since this is based upon a single definite point, there can be but one value for the turbine.

**116. Illustrations of Specific Speed.**—For a turbine of 2000 h.p. at 1000 r.p.m. under 1600 ft. head the value of  $N_s$  is 4.42. Thus a very low-speed turbine, the tangential water wheel, is required. The actual r.p.m., however, is high.

For a 5000 h.p. turbine at 100 r.p.m. under 36 ft. head  $N_s$  equals 80.3. Thus a high-speed reaction turbine is indicated, though the actual r.p.m. may be relatively low.

Suppose that a 12-h.p. turbine is to be run at 100 r.p.m. under a 36-ft. head, the value of the specific speed is 3.95, which means a tangential water wheel. For the larger power under the same conditions in the preceding example a reaction turbine was re-

quired. If the speed were 600 r.p.m., however, a low-speed reaction turbine would be necessary for  $N_s$  would equal 23.6.

Suppose that a 20-h.p. turbine is to run at 300 r.p.m. under a 60-ft. head. The value of  $N_s$  is 8.04 and that would require a tangential water wheel with two nozzles.

If 10,000 h.p. is required at 300 r.p.m. under a 60-ft. head, the value of  $N_s$  would be 179.5. As this is an impossible value it would be necessary to reduce the speed or to divide the power up among at least 4 units of 2500 h.p. each.

**117. Selection of a Stock Turbine.**—The choice of the type of turbine will be taken up in the next chapter. For the present suppose that required values of speed and power under the given head are determined. The value of the specific speed can then be computed and will indicate the type necessary. If the turbine is to be built as a special turbine nothing more is to be done except to turn the specifications over to the builders.

If, however, the turbine is to be selected from the stock runners listed in the catalogs of the various makers, it will be necessary to find out what firms are prepared to furnish that particular type of runner. It would be a tedious matter to search through a number of tables in numerous catalogs to find the particular combination desired, but the labor is avoided by the use of the constants given in the preceding chapter. It will be necessary merely to compute values of specific speeds of turbines made by different manufacturers. This can be quite readily done and such a table will always be available for future use.

A make of turbine should then be selected having a value of  $N_s$  very near to the value desired. The value of  $N_s$  ought to be as large as that required, otherwise the turbine may prove deficient in power, and for the best efficiency under the usual loads it should not greatly exceed the desired value. Having selected several suitable runners in this way, bids may be called for. These bids should be accompanied by official signed reports of Holyoke tests of this size of wheel or the nearest sizes above and below, if none of that particular size are available. This is to enable us to check up the constants obtained from catalog data and to verify the efficiencies claimed. Holyoke test data is very essential if the conditions of the installation are such that an accurate test is not feasible. In making a final choice other factors would be considered such as efficiency on part load, and efficiency and power under varying head.

**118. Illustrative Case.**—Suppose a turbine is required to develop 480 h.p. at 120 r.p.m. under 20-ft. head. The value of  $N_s$  is then 62.2. There are four makes of turbines which approach this as follows:

TABLE 5

| Maker                    | Type                      | $N_s$ | $K_2$   |
|--------------------------|---------------------------|-------|---------|
| Camden Water Wheel Wks   | United States Turbine.... | 64.7  | 0.00190 |
| James Leffel and Co..... | Samson.....               | 61.8  | 0.00158 |
| Platt Iron Works.....    | Victor Standard.....      | 63.0  | 0.00205 |
| Trump Mfg. Co.....       | Standard Trump.....       | 61.5  | 0.00210 |

It is thus apparent that any one of these manufacturers could supply a turbine from their present designs which would nearly fill the requirements. A number of other firms in this country could not fit the case except with a special design or a modification of an existing design. Thus inspection of the table for the Dayton Globe Iron Works Co. in Art. 110 will show that the nearest approach they have to it is their Special New American with an average value of  $N_s$  of 53.7. They could supply a turbine to run at 120 r.p.m. under the head specified, but it would develop only 358 h.p. Or if they supplied a turbine capable of delivering 480 h.p. it should run at 103.5 r.p.m.

Turning to the four cases presented in the table, it is apparent that the Camden wheel is a little over the required capacity, but it may not be enough to be objectionable. The Platt Iron Works wheel is very little over the required capacity and the Leffel and Trump are a trifle under it. If there is a little margin allowable in the power, any of these might be used. The value of  $N_s$  according to which the wheel is rated should be the value for the speed and power at which it develops its best efficiency. In any plant the variation in the head produces a deviation from the best value of  $\phi$ , if the wheel be run at constant speed, and thus causes a drop in efficiency. The power of the wheel may increase or decrease according to the way the head changes. Thus in actual operation the conditions depart so much from those specified in the determination of  $N_s$  that small discrepancies in its value such as exist in the table are of little importance.

If desired, the diameters of the runners may be determined by means of  $K_2$ . For the four cases in the order given they will

be 53.2 in., 58.2 in., 51.2 in., 50.3 in. Actually standard sizes will not agree precisely with these figures and thus a further modification may be brought about. However, mathematical exactness must not be expected in work of this nature. What we attempt to do is merely to select a turbine the peak of whose efficiency falls as near as possible to the conditions of head, speed, and power chosen. Although our conditions may be such that we may rarely realize the very highest efficiency of which the turbine is capable, yet we should be very close to it.

**119. Variable Load and Head.**—In any plant the load is usually not constant but varies over a considerable range. In comparing turbines for certain situations the average operating efficiency may be more important than the efficiency on full load only. If the turbine is to run on full load most of the time or if the installation is such that the pondage is limited or lacking altogether, then the efficiency on part load is of little importance. But if the load is variable and if water can be stored up during the time the wheel may be running under a light load then the efficiency at all times becomes of interest. If the plant has a number of units it is possible to shut down some of them at times so as to keep the rest on full load.

In most low head plants the variation in head is a serious item also and the turbines submitted should be compared as to their efficiency and power under the range of head anticipated.

All turbines having the same specific speed are not necessarily

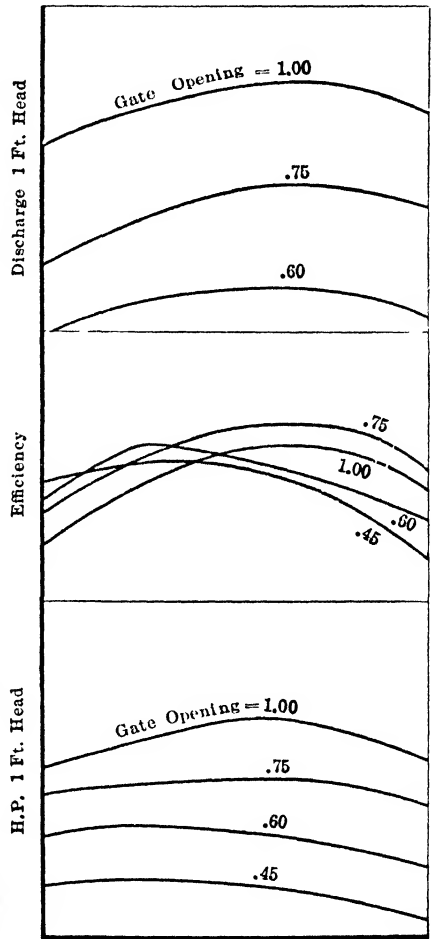

R.P.M. 1 Ft. Head

FIG. 110.



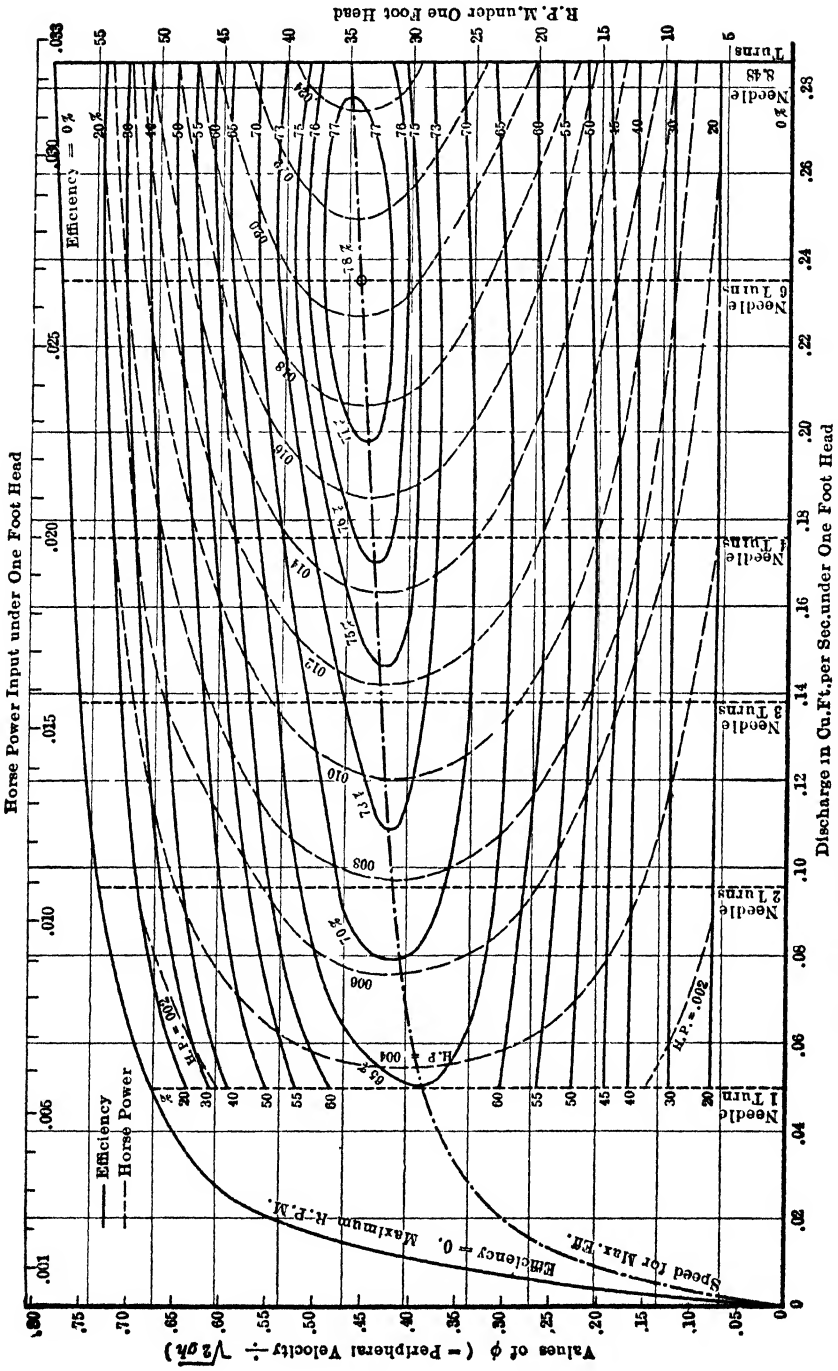

FIG. 111.—Characteristic curve for a 24" tangential water wheel.

equally well suited for the same conditions. A detailed study of the characteristics of each one is essential before the final choice can be made. In many cases the best efficiency will be the deciding factor. In others the average operating efficiency will be more important, and sometimes capacity under varying head will be the chief item.

These factors can be studied by means of curves such as are shown in Fig. 110. Efficiency, discharge, and power for various gate openings reduced to 1-ft. head are plotted against  $\phi$  or the r.p.m. under 1-ft. head. The normal speed and power should be that corresponding to the maximum efficiency. If the wheel is run at constant speed a variation in head causes a change in  $\phi$ .

**120. Characteristic Curve.**—For a thorough study of a turbine the characteristic curve is a most valuable graphic aid. The coordinates of such a curve are discharge under 1-ft. head and  $\phi$  or r.p.m. under 1-ft. head. Values of the horsepower input under 1-ft. head should also be laid off to correspond to the values of the discharge. Lines should then be drawn on the diagram to indicate the relation between speed and discharge for various gate openings. Alongside of each experimental point giving this relation, the value of the efficiency should be written. When a number of such points are located, lines of equal efficiency may be drawn by interpolation.

Another very good method is to draw curves of efficiency as a function of  $\phi$  for each gate opening. For any iso-efficiency curve desired on this diagram it is possible to read off corresponding values of  $\phi$ .

If desired, lines of equal power may also be constructed. To do so, assume the horsepower of the desired curve, then compute the horsepower input for any efficiency by the relation, horsepower input = horsepower output  $\div e$ . This value of  $e$  on one of the iso-efficiency curves together with the value of horsepower input locates one or two points of an iso-power curve.

The characteristic curve for a 24-in. tangential water wheel is shown in Fig. 111. This curve covers all the possible conditions under which the wheel might run. The only way to extend the field would be to put on a larger nozzle. Since the discharge of a tangential water wheel is independent of the speed the lines for the various gate openings will be straight. For the reaction turbine they will be curved as seen in Fig. 112. The latter is a portion of a characteristic curve for a high-speed turbine.

Any marked irregularities in the characteristic curve are indications of errors in the test. It is possible for there to be only one peak in the efficiency curves and an indication of two, as sometimes occurs, is due to incorrect data.

This method of plotting test data and also that shown in Fig. 110 were first given by Prof. D. W. Mead in his "Water Power Engineering." Other diagrams have also been proposed by various men, the object of all being to represent the fundamental variables in the best form for the ready comparison of one turbine with another.

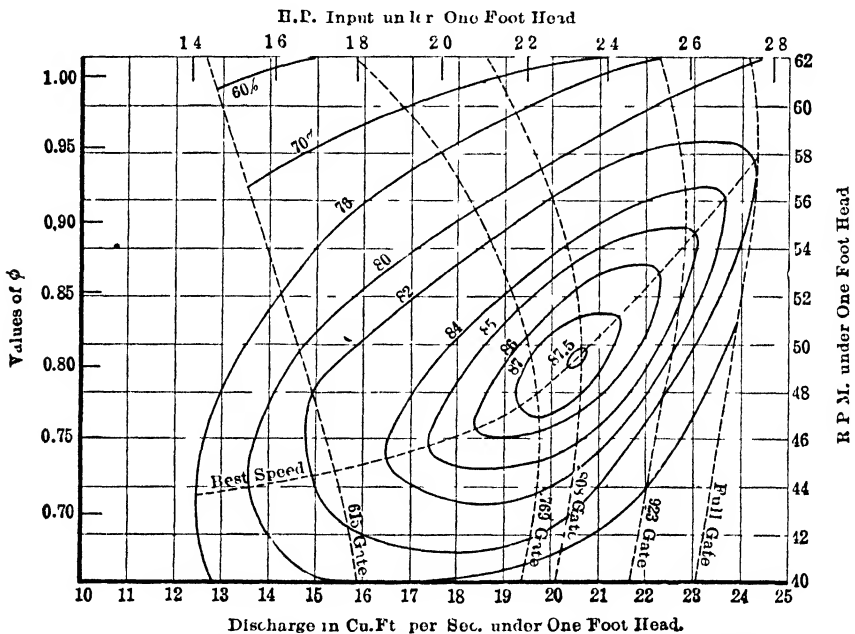

Fig. 112.—Characteristic curve for a high speed reaction turbine.

**121. Use of Characteristic Curve.**—From the characteristic curve it is apparent, at a glance, at what speed the turbine should run for the best efficiency at any gate opening. The best efficiency in Fig. 111 is obtained when  $\phi = 0.457$  or  $N_1 = 34$ , and with the needle open 6 turns. With full nozzle opening the best value of  $N_1$  is 35, with the needle open 3 turns the best speed is such that  $N_1 = 32$ . (With the reaction turbine these differences would be greater.)

From the characteristic curves any other curves may be constructed. For constant speed follow along a horizontal line, for a fixed gate opening follow along the curve for that relation.

If it is desired to investigate the effect of change of head when

the speed is kept constant, compute the new values of  $\phi$  or  $N_1$ . Thus the curve in Fig. 111 was determined by a test under a head of 65.5 ft. and the best speed was 275 r.p.m. That corresponded to  $\phi = 0.457$  or  $N_1 = 34$ . (The value of  $D$  used for computing  $\phi$  was slightly different from the nominal diameter.) If the speed is maintained at 275 r.p.m. when the head is 74 ft., then  $\phi = 0.429$  and  $N_1 = 32$ . If  $h = 55$  ft.,  $\phi = 0.497$  and  $N_1 = 37$ . In the last case the best efficiency would be 77 per cent., a drop of 1 per cent.

The iso-efficiency curves represent contour lines on a relief model and thus the point of maximum efficiency is represented by a peak. It is apparent that for varying loads or heads a turbine giving a diagram, that indicates a model with gentle slopes from this point, would probably be better than a turbine for which the peak might be higher and the slopes steeper. The relative increase in discharge capacity at full gate as  $\phi$  increases is also apparent and indicates which turbine is better for operation at reduced head but normal speed.

## 122. QUESTIONS AND PROBLEMS

1. For any turbine, how does the speed for highest efficiency vary with the gate opening used? How does the efficiency vary with the gate opening for any speed? At what speed and gate will maximum efficiency be found, as compared with maximum power?

2. Should a turbine necessarily be run at the speed for maximum efficiency? Why?

3. What happens to the power and efficiency of a turbine when the head changes, but the speed is kept constant? In time of flood, what is the important consideration?

4. What is the difference between the true and the nominal specific speed? What would be the general profile of a runner whose specific speed was 10? What of one whose specific speed was 100?

5. When is efficiency on full load important and when is efficiency on part load of more value? When is maximum power of principal interest? When is maximum speed the chief object?

6. If a plant contains a number of units, what should be done if all of them are carrying half load? Why? Would there be any object in shutting down some of them if the supply of water was abundant?

7. If there is a great shortage of water so that the supply is inadequate for all the wheels at full head, so that the water level falls considerably below normal before equilibrium is attained, is it better to operate the plant with all the wheels or shut down enough of them to keep the water level near the crest of the spillway? Would it be better to shut down some of the wheels to accomplish this or to operate all of them at part gate opening?

8. In Fig. 112, what is the maximum efficiency and what is the value of the efficiency for maximum power? What is the ratio of the speeds for each of these, and what is the ratio of the power outputs at full gate for each of these speeds?

9. If the turbine, whose performance is shown by Fig. 112, is run at the speed for best efficiency under a head of 50 ft., what will be its maximum output and what the power at the point of maximum efficiency? If the speed is kept at this same value while the head falls to 36.5 ft., what will be the value of the maximum power delivered?

*Ans.* 755 h.p., 720 h.p., 498 h.p.

10. In problem (9) the second value of the head is 73 per cent. of its initial value and the maximum power is 66 per cent. of its value in the first case. For the impulse turbine in Fig. 111, what would be the ratio of the maximum power outputs, if the head dropped the same proportional amount while the speed remained the same as for the maximum efficiency under the initial head?

*Ans.* 58.7 per cent.

11. Suppose that an impulse wheel, similar to that for which the curves of Fig. 111 were drawn, is made of such a size as to develop 5000 h.p. under a head of 1200 ft. Find the diameter of the wheel, its r.p.m., and plot a curve between efficiency and power for a constant speed.

## CHAPTER XIII

### SELECTION OF TYPE OF TURBINE

**123. Possible Choice.**—It has been shown that, if the speed and power under a given head are fixed, the type of turbine necessary is determined. If there is some leeway in these matters it may be possible to vary the specific speed through a considerable range of values. Suppose turbines of a given power may be run at 120 r.p.m., at 600 r.p.m., or at 900 r.p.m. Each one of these would give us a different specific speed and thus a different type of runner. Or, if the speed be fixed, the power, such as 20,000 h.p. may be developed in a single unit, in two units of 10,000 h.p. each, or in eight units of 2500 h.p. each. Again we have different types of runners demanded. Both the speed and power may be varied in some cases and the choice is wider still. As an example, it may be required to develop 500 h.p. under 140-ft. head. Suppose this power is to be divided up between two runners and the speed to be 120 r.p.m. The value of  $N_s$  is then 4.12, showing that a double overhung tangential water wheel is required. Or if the power be developed in a single runner at 600 r.p.m., the value of  $N_s$  would be 29.2, which would call for a reaction turbine.

It is customary to choose a speed between certain limits, as neither a very low nor a very high r.p.m. is desirable. Also the number of units into which a given power is divided is limited. Nevertheless considerable latitude is left. It remains to be seen what considerations would lead us to choose such values of speed and power as would permit the use of a certain type of runner.

**124. Maximum Efficiency.**—The best efficiency developed by a turbine will depend, to some extent, upon the class to which it belongs. The impulse and reaction turbines are so different in their construction and operation that the difference in efficiency between them can be determined solely by experiment. However, abstract reasoning alone will lead to certain conclusion as to the relative merits of different types within each of these two main divisions.

For the tangential water wheel it has been shown that, if the highest efficiency is to be obtained, certain proportions must not be exceeded. If we desire a specific speed higher than 4, it is necessary to pass beyond these limits and thus a wheel whose specific speed is as high as 5 or 6 will not have as high an efficiency as the normal type. On the other hand too low a specific speed is not conducive to efficiency, since the diameter of the wheel becomes relatively large in proportion to the power developed, so that the bearing friction and windage losses tend to become too large in percentage value. The value of  $N_s$  for the highest efficiency is about 4.

A low specific speed reaction turbine, such as Type I in Fig. 34 for example, will have a small value of the angle  $\alpha_1$ . A consideration of the theory, especially equation (33), shows that this is conducive to high efficiency. However this is more than offset by other factors, such as the large percentage value of the disk friction, as explained in Art. 108. In addition, the leakage area through the clearance spaces becomes a greater proportion of the area through the turbine passages, and also the hydraulic friction through the small bucket passages is larger. The result of all these factors is that the efficiency tends to be reduced as very small values of the specific speed are approached.

A medium specific speed turbine runner would have a somewhat larger value of the guide vane angle but this slight disadvantage would be more than offset by the reduction in the relative values of the disk friction, leakage loss, and hydraulic friction loss within the runner. Thus this type would have a higher efficiency than the former.

But when the high specific speed type is reached the inherently large value of the discharge loss is such as to materially reduce the efficiency. This reduction is aided also by the large value given to the guide vane angle and opposed by the decreased disk friction, leakage through the clearance spaces, and internal hydraulic friction. However the effect of these latter factors is not sufficient to offset the increased discharge loss. In other words, efficiency has been sacrificed in favor of increased speed and capacity, just as in the case of a high-speed impulse turbine.

This reasoning is borne out by the facts, as can be seen by Fig. 113, where efficiency is plotted as a function of specific speed.<sup>1</sup> A number of test points were located and the curve shown was

<sup>1</sup> L. F. Moody, *Trans. A. S. C. E.*, Vol. LXVI, p. 347.

drawn through the highest on the sheet. It shows what has actually been accomplished and it also shows how the maximum efficiency varies with the type of turbine. It is apparent that if one desires the highest efficiency possible a specific speed should be chosen between 25 and 50.

It must not be thought that this curve represents the results that one should expect in every case. It merely shows the relative merits of the different types. The actual efficiency obtained depends not only upon the specific speed but also upon the capacity of the turbine and the head and other factors. The larger the capacity of a turbine the higher the efficiency will be. In a given case the efficiency obtained for a specific speed of 30, say, might be only 83 instead of the 93 shown by the curve. But if the specific speed had been 95 instead of 30 the efficiency realized, might have been only 73.

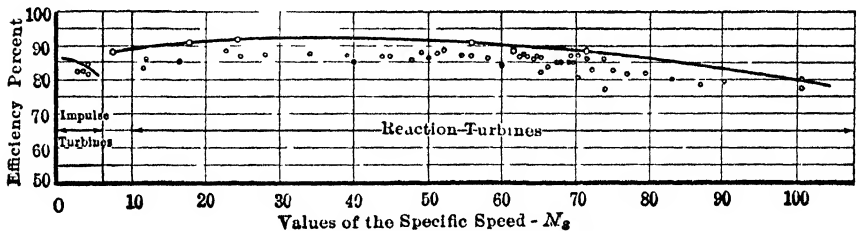

FIG. 113.

Higher efficiencies have been attained with reaction turbines than with Pelton wheels. The maximum recorded efficiency for the former is 93.7 per cent. and quite a few large units have shown efficiencies over 90 per cent. where conditions were favorable. The highest reported value for an impulse wheel is 89 per cent. but the usual maximum is about 82 per cent. However the efficiency of a reaction turbine is a function of its capacity, that is for small sizes the efficiency is relatively low. As the larger sizes are reached this difference disappears. The reason for this is that the clearance spaces and hence leakage losses are a greater percentage with the small sizes. The efficiency of the Pelton wheel is not dependent on its size. Hence for smaller powers the tangential wheel may have a higher maximum efficiency than the reaction turbine.

**125. Efficiency on Part-load.**—Full-load will be defined as the load under which a turbine develops its maximum efficiency.



Anything above that will be called an overload and anything less than that will be known as part-load.

It has already been explained (Art. 84) that to obtain the highest efficiency the water must enter without turbulent vortex motion (known as shock) and must leave with as little velocity as possible. In order to obtain the former the vane angle  $\beta'_1$  must agree with the angle of the relative velocity of the water as determined by the vector diagram, and the quantity of water should be such that its relative velocity  $v'_1$ , as determined by the equation of continuity, should agree with the velocity  $v_1$ , as determined by the vector diagram of velocities. In order to reduce the discharge loss to a minimum it has also been shown that  $\alpha_2$  should have a value of approximately  $90^\circ$ .

There is practically no additional loss at entrance to the buckets of a Pelton wheel due to the reduction in the size of the jet at part-load. If the jet and wheel velocities remained just the same, the velocity diagrams would be identical at all loads. Actually the jet velocity may vary slightly but the shape of the buckets is such that there is no well defined vane angle at entrance. And since, in the impulse turbine, the relative velocity through the runner is not determined by the equation of continuity, there can be no abrupt change in either the direction or magnitude of the relative velocity of the water at entrance. But this is not the case with the reaction turbine. The smaller gate opening changes the angle  $\alpha_1$ . This alters the entrance velocity diagram. Hence the angle  $\beta_1$  will no longer agree with the vane angle  $\beta'_1$ . Since the quantity of water discharged per unit time is less than before, it follows that the velocity  $v'_1$ , as determined by the area of the runner passages, is less than the value at full-load. Thus when a reaction turbine runs at part-gate there are eddy losses produced at entrance to the runner due to the abrupt change in the direction and magnitude of the velocity of the water through the wheel passages. No such losses occur with the impulse turbine.

At the point of discharge the velocity diagram for the tangential wheel is practically the same at all loads, provided the jet velocity and bucket velocity are the same. There may be slight increases in the losses in flow over the bucket surfaces which would affect this statement somewhat for very large or very small nozzle openings, but for a reasonable range the statement is true. Thus the discharge loss would be the same at all loads. But for the

reaction turbine, since the water completely fills the bucket passages, a reduced rate of discharge requires a proportionate reduction in the relative velocity  $v_2$ . Thus  $V_2$  and hence the discharge loss are inevitably increased. The higher the specific speed of the turbine the greater the discharge loss at the normal gate opening, and hence the greater the effect produced upon the efficiency when this loss is increased at part-gate.

It is thus apparent that at part-load there are inherent losses within the reaction turbine that are not found with the Pelton wheel.

In fact the hydraulic efficiency of the latter would appear to be the same at all nozzle openings. In reality the reduction in the velocity coefficient of the nozzle, as the needle closes the discharge area, together with some change in the bucket friction, changes the efficiency slightly. It is the gross efficiency with which we are really concerned, and of course the mechanical losses due to friction and windage, which are constant at constant speed, cause the efficiency to decrease as the gate opening decreases. But the efficiency-load curve of the tangential water wheel is inherently a flat curve.

The losses within the reaction turbine runner are such that the hydraulic efficiency must decrease as the gate is changed in either direction from the position at full-load. Hence the efficiency at part-load or overload tends to be less than that for the impulse wheel, as shown in Fig. 114 (assuming both to be the same at full-load), and the higher the specific speed the steeper will the efficiency curve be.

For the tangential water wheel in Fig. 111 it can be seen that the best speed is slightly different for different gate openings, and that it increases as the latter increases. This is also true with the reaction turbine, but in a more marked degree as can be seen in Fig. 112. If the speed is selected so as to give the best efficiency at a certain gate opening it will not be correct for any other gate opening and thus efficiency will be sacrificed at all gates except one.

This variation of the best speed with different gate openings is found in all turbines, but not in the same degree. With the low-speed reaction turbine it is small, approaching the tangential water wheel in that regard. With the high-speed reaction turbine it is very marked. There seems to be little difference be-

tween turbines, in this regard, for specific speeds less than 50; but for specific speeds above that, it increases rapidly.<sup>1</sup>

If, then, a constant speed be selected which is the best for full-load, there will be a sacrifice of efficiency on part-load, and this

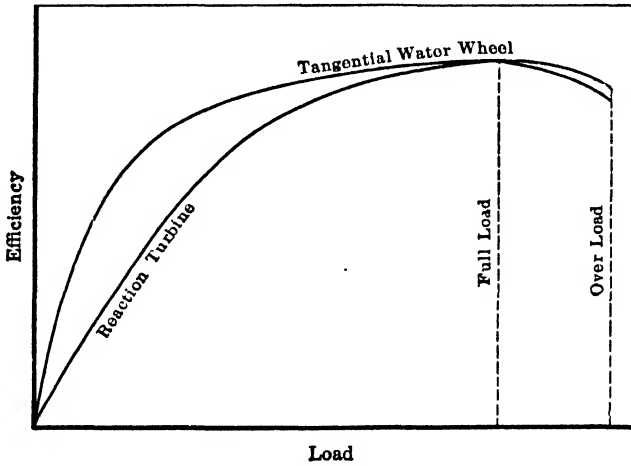

FIG. 114.—Relative efficiencies on part-load of impulse and reaction turbines.

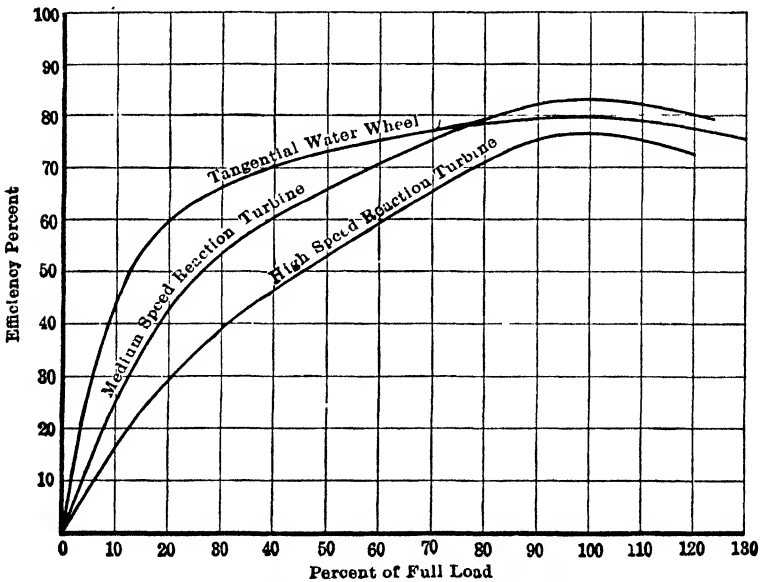

FIG. 115.—Typical efficiency curves.

sacrifice will be greater the higher the specific speed of the turbine. These considerations, together with the facts given in the preceding article, imply efficiency curves for the various types

<sup>1</sup> C. W. Larnier, *Trans. A. S. C. E.*, Vol. LXVI, p. 341 (1910).

such as are shown in Fig. 115. To prevent confusion the efficiency curve for a low-speed turbine is not shown, but its efficiency on full-load would be about the same as that for the tangential water wheel, while on part-load it would be a little less.

It may also be noticed that there is less overload capacity with the high-speed turbine than with the other types. This is because the point of maximum efficiency is nearer full-gate than with the other types. If the customary 25 per cent. overload must be allowed, then the normal load must be less than the power for maximum efficiency with a further decrease in operating efficiency.

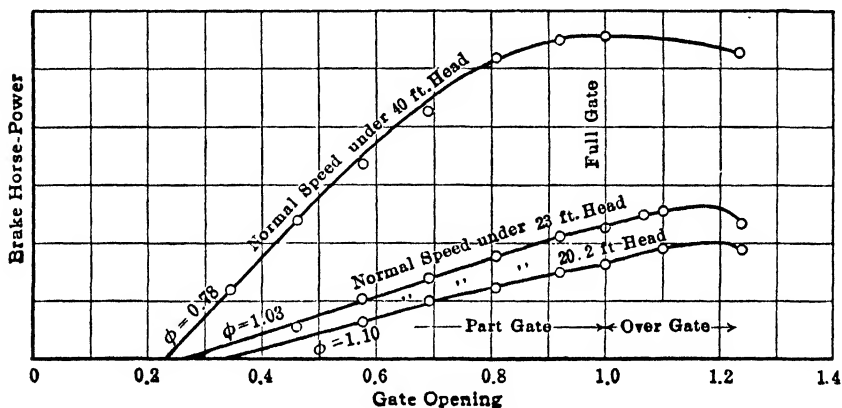

FIG. 116.—Relation between power and gate opening for same speed under different heads.

Thus from the tangential wheel on the one hand to the high-speed reaction turbine on the other the relative efficiency on part-load decreases as the specific speed increases.

**126. Overgate with High-speed Turbines.**—With the wicket or swing gates, as used today, there is no definite limit to their opening save that imposed by an arbitrary mechanical stop. As the gate opening increases the rate of discharge and hence the power of the turbine increases, as shown by curve for  $\phi = 0.78$  in Fig. 116. But with too great an angle of the vanes the efficiency decreases so much that the power output no longer continues to increase and may even decrease. Ordinarily there is no advantage gained by opening the gates any wider than that necessary to secure maximum power, and hence the mechanism is usually so constructed that it cannot move the gates any farther than

this position. This may be termed "full-gate opening."<sup>1</sup> If the construction is such that the gates can be opened wider than this amount, the range from full-gate up to the maximum opening may be termed "over-gate."

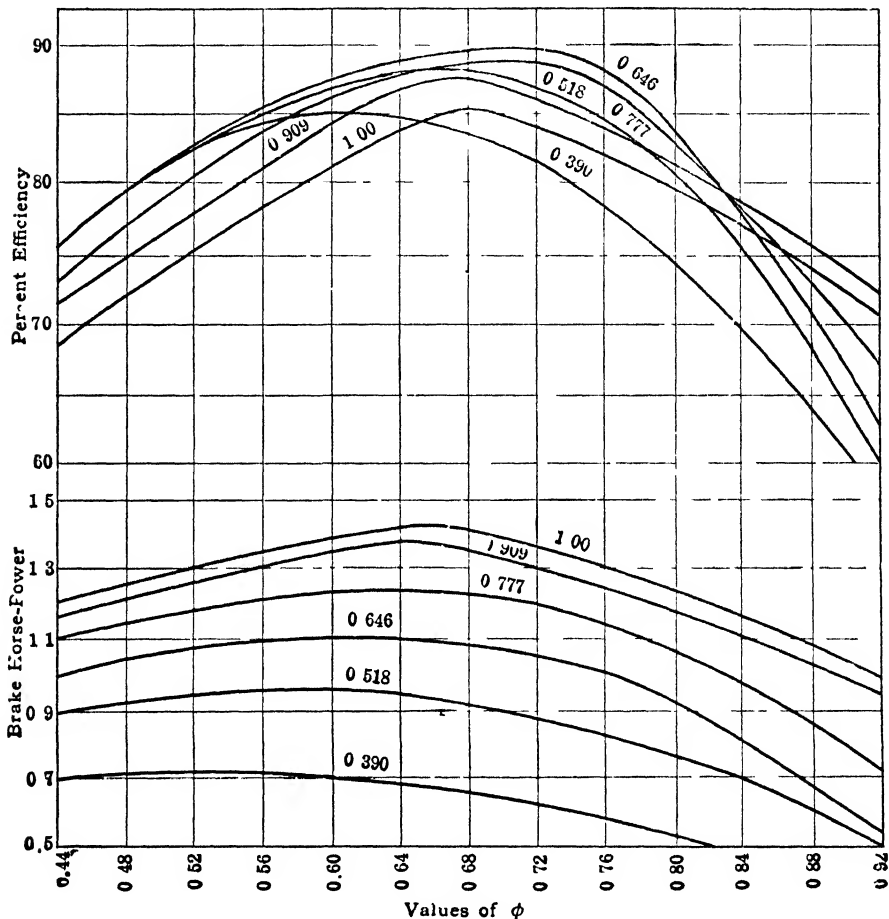

FIG. 117.—Characteristics of low-speed runner  $N_s = 27$ .

If the normal speed be taken as the speed at which the wheel develops its maximum efficiency, it may be seen in Fig. 112 that

<sup>1</sup> This is a purely arbitrary definition, but there is at present no agreement as to what the term "full-gate" really signifies, and so it will be here used as defined above. It may be noted that the gate movement might also be limited to something less than the position shown, and in such an event it would be logical to denote the maximum opening as the "full-gate." The effect of this construction would be to decrease the overload capacity or to move the power for maximum efficiency nearer to the maximum power. For the same maximum power this would require a slightly larger runner,

the power at full-gate increases as the speed increases above normal. This is a peculiarity of the high-speed turbine. With the medium and low-speed turbine there is no such increase. In fact, as shown in Fig. 117, there may be a reduction in power with the low specific speed turbine at full-gate, if the speed is increased above normal. The explanation of this difference in the two types is that with the inward flow turbine the centrifugal action opposes the flow of water, and hence the rate of discharge tends to decrease as the speed increases, while with the outward flow turbine the centrifugal action tends to increase the rate of discharge with the speed. This may be seen in Fig. 95, page 126. The low specific speed runner approaches the pure radial inward flow type, while the high specific speed runner of the present with inward, downward, and outward flow (the radius to the outer limit of the discharge edge being often as much as one-third greater than the radius to the entrance edge) approaches the outward flow turbine in this characteristic. Thus, despite the decrease in efficiency, as the speed departs from the normal, the increased rate of discharge tends to increase the power output for a certain range of speed above normal. This feature of the high-speed turbine is of great value, as it especially fits it for the class of service, to which it is otherwise adapted.

As has been explained, the maximum opening of the turbine gate would usually be that at which no further increase in power at normal speed could be obtained and this is termed "full-gate." But with the high specific speed turbine it is found that, when running at a speed above normal, the power continues to increase for an opening of the gate beyond its usual maximum value, as shown by curves for  $\phi = 1.03$  and  $1.10$  in Fig. 116. A turbine so constructed that the gate can be opened wider than the maximum value necessary under normal conditions is said to be "overgated." This additional gate opening would be of no value with a low-speed turbine under any circumstances, and it would be of no value with a high-speed turbine under normal conditions. But, not only does the power of the latter increase at full-gate for speeds higher than the normal, but by opening the gate wider than the usual value the power may be still further increased as may be seen in Figs. 107 and 118. The nominal full-gate opening is denoted by unity.

If the head on a water power plant decreases, as in time of flood, the capacity of each turbine is reduced, with a resulting

shortage of power. If the wheels must run at a constant speed, as is usually the case, the speed is no longer correct for the head, and this causes a decrease in efficiency with a further reduction of power.

Any feature which will improve the capacity of the turbine under these circumstances is of value. Now since speed is proportional to  $\phi\sqrt{h}$ , a constant speed under a reduced head means an increase in  $\phi$  above its normal value. As has been seen,

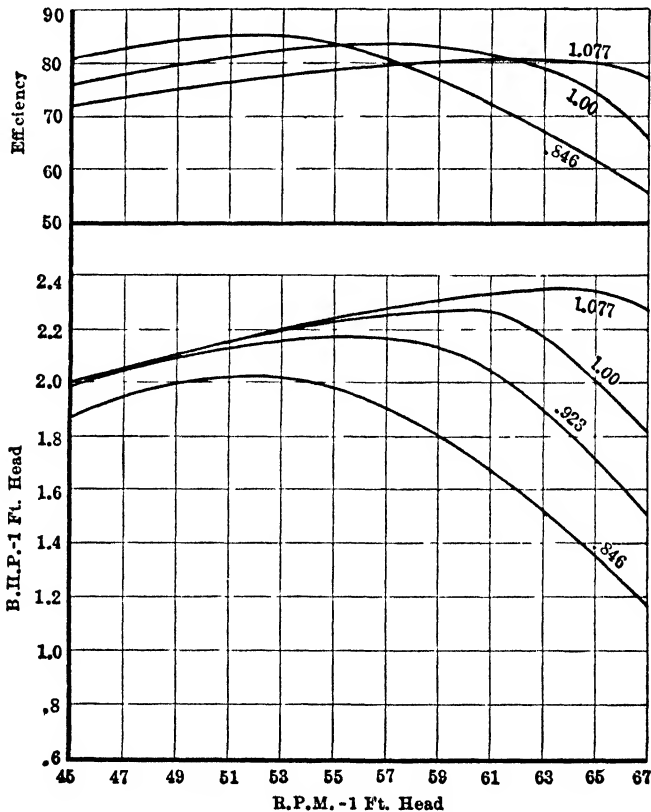

FIG. 118.—High-speed turbine.

an increase in  $\phi$  above its normal value causes no increase in the power of a low- or medium-speed runner, but with the high-speed runner not only does the power at full-gate increase but, by overgating, the power may be still further increased. The effect of an overgate is to materially increase the capacity of the turbine at a time when there is a shortage of power. This feature is not possessed by lower speed runners.

The high specific speed turbine has a lower maximum efficiency,

a lower part load efficiency, and less overload capacity than the medium speed turbine when both are operated under a constant head, but its higher speed is a decided advantage where the normal head is low. But it is with low head plants that flood conditions are most serious in their effects upon the capacity of the plant and, as has been seen, the characteristics of the high-speed runner are such that it is able to deliver more power under these circumstances.

The results obtained with "overgating" high-speed turbines may be seen in Figs. 107 and 118. In the latter case full-gate is denoted by 1.00 and the maximum gate opening by 1.077. The normal speed is 52 r.p.m. under 1 ft. head. At that speed any further gate opening would be of no advantage, and in fact would merely cause a drop in efficiency. But at a higher speed, such as 65 r.p.m., the overgate feature raises the power under 1 ft. head from 2.0 h.p. at full-gate to 2.35. Bearing in mind that a medium speed runner for the same situation would deliver less than 2 h.p. under these circumstances, it is seen how much superior the high specific speed turbine is for the particular conditions of service.

The differences between the low- and high-speed runners are brought out in the following table. The normal head is 15 ft. and the wheels develop 100 h.p. In time of high water the head will decrease to 10 ft., while the wheels are kept at their normal speed.

TABLE 6.—HEAD = 15 Ft.

| Type            | $N_s$ | R.p.m. | $\phi$ | Gate | H.p. | Efficiency |
|-----------------|-------|--------|--------|------|------|------------|
| Low speed.....  | 35.2  | 104    | 0.70   | 1.00 | 100  | 85         |
| High speed..... | 77.7  | 232    | 0.81   | 1.00 | 100  | 82         |

TABLE 7.—HEAD = 10 Ft.

| Type            | $N_s$ <sup>1</sup> | R.p.m. | $\phi$ | Gate  | H.p. | Efficiency |
|-----------------|--------------------|--------|--------|-------|------|------------|
| Low speed.....  | 35.2               | 104    | 0.86   | 1.00  | 47.3 | 78         |
| High speed..... | 77.7               | 232    | 0.99   | 1.00  | 49.3 | 76         |
| High speed..... |                    | 232    | 0.99   | 1.077 | 58.0 | 80         |

<sup>1</sup> These values of specific speed apply only when the turbine is developing its best efficiency. Under the reduced head with an incorrect value of  $\phi$ , the real specific speed is different. But as an index of the type the values given are always appropriate.



By means of the overgate feature the high-speed turbine is seen to be capable of developing  $22\frac{1}{2}$  per cent. more power under the lower head than the low-speed turbine. The efficiency is also seen to be greater.

**127. Type of Runner as a Function of Head.**—It has been stated that the choice of the type of turbine is a function of the power and the speed desired, as well as the head. While this is true, the value of the head does exert a predominating influence and hence there is some justification for the presentation of a relationship between the two, such as is given in Table 8. However, it should be noted that the figures given for specific speed are merely limits. Thus a head of 100 ft. does not require a turbine whose specific speed is 50 for example. The latter is merely the maximum value found in current practice for such a head, and a lower value of  $N_s$  might be used. Within this maximum limit the specific speed chosen would depend upon the power and speed and a consideration of the characteristics desired.

TABLE 8.—RELATION BETWEEN HEAD AND SPECIFIC SPEED

| Head ft. | Maximum value of $N_s$ | Type of setting   |
|----------|------------------------|---|
| 20       | 100                    | Vertical shaft single runner units with good draft tubes.   |
| 25       | 90                     |   |
| 35       | 80                     |   |
| 50       | 70                     |   |
| 65       | 60                     | Single runner, either horizontal or vertical, or two runners discharging into a common draft chest. |
| 100      | 50                     |   |
| 160      | 40                     |   |
| 350      | 30                     | Single or double discharge runner on horizontal shaft.  |
| 600      | 20                     |   |
| 800      | 10                     |   |
| 1000     | 6                      | Impulse wheels.   |
| 2000     | 3                      |   |
| 5000     | 1                      |   |

**128. Choice of Type for Low Head.**—No definite rules can be laid down for universal use because each case is a separate problem. Neither is it possible to draw any line between a high and a low head. All that can be done is to assume cases that are typical and establish broad general conclusions. In any particu-

lar case the engineer can then decide what considerations have weight and what have not.

The average low-head plant has very little, if any, storage capacity. In times of light load the water not used is generally being discharged over the spillway of the dam. Economy of water on part-load is thus of very little importance. The efficiency on full load is of value as it determines the amount of power that may be developed from the flow available.

Under a low head the r.p.m. is normally low and it is desirable to have a runner with a small diameter and a high value of  $\phi$ , in order to secure a reasonable speed. A high speed means a cheaper generator and, to some extent, a cheaper turbine. These were the factors that brought about the development of the high-speed turbine.

A low-head plant is also usually subjected to a relatively large variation in the head under which it operates. When the head falls below its normal value the overgate feature of the high-speed turbine, enabling it to hold up the power, to some extent, at a good efficiency, is a very valuable characteristic.

The only disadvantage of the high-speed turbine for the typical low-head plant is that its maximum efficiency under normal head is not as good as that of the lower speed turbines. However, the other advantages outweigh this so that it is undoubtedly the best for the purpose.

**129. Choice of Type for Medium Head.**—With a somewhat higher head a limited amount of storage capacity usually becomes available and thus the efficiency on part-load becomes of interest as well as the efficiency on full-load. The r.p.m. also approaches a more desirable value so that the necessity for a high-speed runner disappears. The variation in head will generally be less serious also, so that the overgate feature of the high-speed turbine becomes of less value. The high efficiency of the medium-speed turbine fits it for this case. The high-speed turbine should not be used unless the interest on the money saved is more than the value of the power lost through the lower efficiency.

**130. Choice of Type for High Head.**—For high heads the possibility of extensive storage increases and the average operating efficiency then becomes of more interest than the maximum efficiency, especially if the turbine is to run under a variable load. Since the normal speed under such a head is high, a runner with a large diameter and a low value of  $\phi$  may be desirable, as it keeps

the r.p.m. down to a reasonable limit. The choice lies between a medium-speed turbine, a low-speed turbine, or a tangential water wheel.

If the wheel is to run on full-load most of the time, the high full-load efficiency of the medium-speed turbine fits it for the place. If the load is apt to vary over a wide range and be very light a considerable portion of the time, the comparatively flat efficiency curve of the tangential water wheel renders it suitable. There is little difference between the characteristics of the low and medium-speed wheels. The choice between them is largely a matter of the r.p.m. desired, although there is some slight difference in efficiency.

**131. Choice of Type for Very High Head.**—Within certain limits there is a choice between the low-speed reaction turbine and the tangential water wheel. The former might be chosen in some cases because of its higher speed with a consequently cheaper generator and the smaller floor space occupied by the unit. The latter has the advantage of greater freedom from breakdowns and the greater ease with which repairs may be made. This consideration is of more value with the average high-head plant than with the average low-head plant, since the former is usually found in a mountainous region where it is comparatively inaccessible, and is away from shops where machine work can be readily done.

For extremely high heads there is no choice. The structural features necessary are such that the tangential water wheel is the only type possible. Also the relatively low speed of the tangential water wheel is of advantage where the speed is inherently high.

### 132. QUESTIONS AND PROBLEMS

1. For a given head and stream flow available at a certain power plant, what quantities may be changed so as to permit the use of various types of turbines? Which type of turbine will give the smallest number of units in the plant? Which type will run at the lowest r.p.m.?

2. How do impulse wheels and reaction turbines compare as to the maximum efficiency attained by each? How does the efficiency of an impulse wheel vary with its size? Why? How does that of a reaction turbine vary with its size? Why?

3. For the same power under the same head compare impulse wheels and reaction turbines with respect to efficiency, rotative speed, space occupied, freedom from breakdown, ease of repairs, and durability with silt laden water.

4. How does the maximum efficiency of a reaction turbine vary with the type of turbine? For what type is it the highest? Why? For what type is it the lowest? Why?

5. What are the disadvantages of a very low specific speed reaction turbine? What are its advantages?

6. How does the efficiency of the Pelton wheel vary with its specific speed? Why?

7. What is meant by full-load? What affects the efficiency of a tangential water wheel on part-load?

8. What affects the efficiency of a reaction turbine on part-load? Is the part-load efficiency a function of specific speed?

9. What is meant by full-gate? By overgate? What types of turbines are overgated?

10. What is the difference in the characteristics of low and high specific speed reaction turbines when run at the same speed under a head less than normal? Why?

11. What are the advantages and disadvantages of very high specific speed turbine runners?

12. What types of turbines could be used under a head of 20 ft.? Under 200 ft.? Under 1000 ft.?

13. What are the advantages of a high-speed runner under very low heads? What are the advantages of a medium speed runner under the same conditions?

14. What are the especial merits of tangential water wheels for very high heads? What are the disadvantages of a low-speed reaction turbine for the same conditions?

15. The turbine runner for which the curves in Fig. 107 were plotted was 23 in. in diameter and had a specific speed of 93. The specific speed of the runner for which the curves of Fig. 117 were drawn was 27 and the diameter was 57 in. Suppose a turbine was required to deliver 1200 h.p. at full-gate under a head of 25 ft., find the size and r.p.m. for a runner of each of these types.

*Ans.* 47.8 in., 150 in., 150 r.p.m., 43.5 r.p.m.

16. If the speeds remain as in problem (15) while the head decreases from 25 ft. to 16 ft., find the power of each turbine. *Ans.* 648 h.p., 465 h.p.

17. The average flow of a stream is 3000 cu. ft. per second and the pondage is very limited. The normal head is 30 ft. but is at times as low as 18 ft. What type of turbine should be employed, how many units should there be, and at what speed will they run?

*Ans.* 4 units at 124 r.p.m. probably best.

18. The average flow of a stream is 3000 cu. ft. per second. The normal head is 30 ft. which is decreased somewhat in times of flood. The stream flow is fluctuating with long low water periods, but there is considerable storage. The load on the plant also varies considerably. What type of turbine should be used, how many units should there be, and at what speed should they run?

19. A turbine is required to carry a constant load of 800 h.p. under a head of 120 ft. There is considerable storage capacity and the stream has periods of low run-off. The wheel is to drive a 60-cycle alternator. What type of turbine should be used and what will be its speed?

## CHAPTER XIV

### COST OF TURBINES AND WATER POWER

**133. General Considerations.**—Since there are so many factors involved, it is rather difficult to establish definite laws by which the cost of a turbine may be accurately predicted. No attempt to do so will be made here, but a discussion of the factors involved and their affects will be given and the general range of prices stated. A few actual cases are cited as illustrations.

A stock turbine will cost much less than one that is built to order to fulfil certain specifications. This fact is illustrated by the comparison of two wheels of about the same size and speed. The specifications of the stock turbine were as follows: 550 h.p. at 600 r.p.m. under a head of 134 ft., 26-in. double discharge bronze runner, cast steel wicket gates, cast-iron split globe casing 5 ft. in diameter, and riveted steel draft tube. Weight about 11,500 lb. Price \$1750. The special turbine was as follows: 500 h.p. at 514 r.p.m. under a head of 138 ft., bronze runner, spiral case, riveted steel draft tube, connections to header, relief valve, and vertical type 5000 ft.-lb. Lombard governor. Price \$4000. The latter includes a governor, relief valve, and some connections which the former did not, but the difference in cost is more than the price of these.

The cost of the turbine is also affected by the quality and quantity of material entering into it, the grade of workmanship, and the general excellence of the design. With the \$4000 turbine cited in the preceding paragraph another may be compared which is of superior design. The specifications for the latter were as follows: 550 h.p. at 600 r.p.m. under 142-ft. head, single discharge bronze runner, spiral case with 30-in. intake, cast steel wicket gates, bronze bushed guide vane bearings, riveted steel draft tube, lignum vitæ thrust bearing, oil pressure governor sensitive to 0.5 per cent. The guaranteed efficiencies were

83 per cent. at 410 h.p.

84 per cent. at 500 h.p.

83 per cent. at 550 h.p.

(Nothing was said about efficiency in the preceding case.)  
 Weight of turbine 30,000 lb., of governor 3000 lb. Price \$6000.

The turbine just quoted was similar to one previously built and the patterns required only slight modification. Where an entirely new design is called for the cost will be greater still, as is evidenced by the bid of another firm, as follows: 550 h.p. at 600 r.p.m. under 142-ft. head, single discharge cast iron runner, spiral case, cast steel guide vanes, cast steel flywheel, oil pressure governor, connections to header, 30-in. hand-operated gate valve, riveted steel draft tube, and relief valve. The guaranteed efficiencies were

|                        | Per cent. of max. h.p. |
|------------------------|------------------------|
| 81.5 per cent. at..... | 100                    |
| 84.5 per cent. at..... | 90                     |
| 84.5 per cent. at..... | 85                     |
| 82.5 per cent. at..... | 75                     |
| 79.5 per cent. at ..   | 60                     |

Weight of turbine complete 38,000 lb. Price \$8740. This last turbine includes a few items that the former does not, but the difference in cost cannot be accounted for by them. It will be noted that a flywheel was deemed necessary here, while it was not used on any of the others. Compare the weights and costs of these last two turbines with the weight and cost of the stock turbine first mentioned.

**134. Cost of Turbines.**—The cost of a turbine depends upon its size and not upon its power. Since the power varies with the head, it is apparent that the cost per h.p. is less as the head increases. Thus a certain 16-in. turbine (weight = 7000 lb.) without governor or any connections may be had for \$1000. Under various heads the cost per horsepower would be as follows:

| Head        | H.p. | Cost per h.p. |
|-------------|------|---------------|
| 30 ft.....  | 52   | \$19.20       |
| 60 ft.....  | 148  | 6.75          |
| 100 ft..... | 318  | 3.14          |

One would not be warranted in saying, however, that under 10-ft. head a turbine would cost \$100 per horsepower because the above would develop only 10 h.p. under that head. Neither would one be justified in saying that, since this turbine would develop 1650 h.p. under 300-ft. head, that the cost per horsepower might be only \$0.605. Under a 10-ft. head a much lighter and cheaper construction would be entirely reasonable, while under a 300-ft. head the turbine would have to be built stronger and better than this one was.

For a given head, the greater the power of the turbine the less the cost per horsepower will be. Also for a given head and power, the higher the speed, the smaller the wheel, and consequently the less the cost. Compare the 600-r.p.m. reaction turbines in Art. 133 with the following, which is a double overhung tangential water wheel at 120 r.p.m. The horsepower is 500 under 134-ft. head. Oil pressure governor is included, but no connections to penstock are furnished. Weight 80,000 lb. Price \$8900.

These last differences are very much magnified if we combine the cost of the generator with that of the turbine. The following are some generator quotations. The first is that of a generator at a special speed. The second is that of a generator of somewhat better construction than the first but of a standard speed. The others are all standard speeds.

|   |         |
|---|---------|
| 150 kv.-a., 2400 volts, 3-phase, 60-cycle, 124 r.p.m. | \$4850. |
| 150 kv.-a., 2400 volts, 3-phase, 60-cycle, 120 r.p.m. | \$3300. |
| (Weight 17,210 lb.)                                   |         |
| 300 kv.-a., 2400 volts, 3-phase, 60-cycle, 120 r.p.m. | \$4700. |
| (Weight 25,520 lb.)                                   |         |
| 350 kv.-a., 2400 volts, 3-phase, 60-cycle, 514 r.p.m. | \$2330. |
| 350 kv.-a., 2400 volts, 3-phase, 60-cycle, 600 r.p.m. | \$2100. |

Taking the highest priced 600-r.p.m. turbine and combining it with the 350-kv.-a. generator we get a total of \$10,850. Adding the cost of the 120-r.p.m. turbine to that of the 300-kv.-a. generator we get a total of \$13,600 for a smaller amount of power.

Prof. F. J. Seery has derived the following empirical formula based upon the list prices of 35 wheels made by 20 manufacturers.

Log  $X = A + D/B$ , in which  $X$  is the cost in dollars for a single stock runner with gates and crown plates suitable for

setting in a flume. The value of *A* ranges from 1.09 to 2.17, but the usual value is about 1.9. The value of *B* varies from 40 to 83 with a usual value of about 50. These prices are subject to discounts also. The cost of a draft chest for a twin runner will be given by

$X = 0.045 D^{2.25}$ , in which *X* is in dollars and *D* is the diameter of the runners in inches.

The cost of the casing increases these values very greatly, as some spiral cases may cost much more than the runner. A single case may be cited of a pair of 20-in. stock runners in a cylinder case with about 30 ft. of 5 ft. steel penstock. Each runner discharges into a separate draft tube about 3 ft. long. The power is 150 h.p. under 30-ft. head. The cost was \$2000.

A few quotations are here given. A reaction turbine to develop 4000 h.p. at 600 r.p.m. under 375 ft. head and weighing 90,000 lb. would cost \$14,000. Another reaction turbine of 10,000 h.p. under 565-ft. head cost \$37,000. In the latter case the governor, pressure regulator, and the generator were included. The building, crane, transformer room, etc., cost \$20,000 for this installation. A tangential water wheel of 2500 h.p. under 1200-ft. head cost \$12,000, while another of 4500 h.p. under 1700-ft. head cost \$8,000.

As has been stated, the cost of a turbine varies between fairly wide limits due to difference in design, workmanship, and commercial conditions. The cost per h.p. is also less the higher the head or the greater the power. In a general way it can be said to vary between \$2 and \$30 per horse-power and according to the following table:

| Head              | Cost per h.p. | Cost of building per h.p. |
|-------------------|---------------|---------------------------|
| — 60 ft. ....     | \$30-\$7      | \$30-\$4                  |
| 100-600 ft. ....  | \$12-\$2      | \$ 7-\$2                  |
| 500-2000 ft. .... | \$ 8-\$2      | \$ 7-\$2                  |

The cost of the turbine is usually only about 6 per cent. of the total cost of the power plant. It scarcely pays, therefore, to buy a cheap turbine when the money saved is such a small portion of the entire investment.

**135. Capital Cost of Water Power.**—The capital cost of water power includes the investment in land, water rights, storage



reservoirs, dams, head races or canals, pipe lines, tail race, power house, equipment, transmission lines, interest on money tied up before plant can be put into operation, and often the cost of an auxiliary power or heating plant.

The capital cost per horsepower is less as the capacity of the plant is greater. This is shown by the following table from the report of the Hydro-Electric Power Commission of the Province of Ontario. The proposed plant was to be located at Niagara Falls.

TABLE 9

| Items                                       | 50,000 h.p.            | 100,000 h.p.           |
|---|------------------------|------------------------|
| Tunnel tail race . . . . .                  | \$1,250,000            | \$1,250,000            |
| Headworks and canal . . . . .               | 450,000                | 450,000                |
| Wheel pit . . . . .                         | 500,000                | 700,000                |
| Power house . . . . .                       | 300,000                | 600,000                |
| Hydraulic equipment . . . . .               | 1,080,000              | 1,980,000              |
| Electric equipment . . . . .                | 760,000                | 1,400,000              |
| Transformer station and equipment . . . . . | 350,000                | 700,000                |
| Office building and machine shop . . . . .  | 100,000                | 100,000                |
| Miscellaneous . . . . .                     | 75,000                 | 75,000                 |
|   | <hr/>                  | <hr/>                  |
| Engineering, etc., 10 per cent. . . . .     | \$4,865,000<br>485,000 | \$7,255,000<br>725,000 |
|   | <hr/>                  | <hr/>                  |
| Interest, 2 years at 4 per cent. . . . .    | \$5,350,000<br>436,560 | \$7,980,000<br>651,168 |
|   | <hr/>                  | <hr/>                  |
| Total capital cost . . . . .                | \$5,786,560            | \$8,631,168            |
|   | <hr/>                  | <hr/>                  |
| Capital cost per horsepower . . . . .       | \$114                  | \$86                   |

The cost per unit capacity is usually less as the head increases. This is illustrated by the following table taken from Mead's "Water Power Engineering."

| Capacity horsepower | Head | Capital cost per h.p. |          |                                   |   |
|---------------------|------|-----------------------|----------|-----------------------------------|---|
|                     |      | Without dam           | With dam | With dam and electrical equipment | With dam, electric equipment, and transmission line |
| 8000                | 18   | \$63.50               | 86       | 115                               | 150   |
| 8000                | 80   | 21.00                 | 39       | 60                                | 90  |

The capital cost may range from \$40 to \$200 per horsepower, but the average value is about \$100.<sup>1</sup>

**136. Annual Cost of Water Power.**—The annual cost of water power will be the sum of the fixed charges and the operating expenses. The former will cover interest on the capital cost, taxes, insurance, depreciation, and any other items that are constant. The latter includes repairs, supplies, labor, and any other items that vary according to the load the plant carries. The annual cost per horsepower is the total annual cost divided by the horsepower capacity of the plant.

The total annual cost will vary with the number of hours the plant is in service and also with the load carried. The cost will be a maximum when the plant carries full load 24 hours per day and 365 days per year. It will be a minimum when the plant is shut down the entire year, being then only the fixed charges. (See

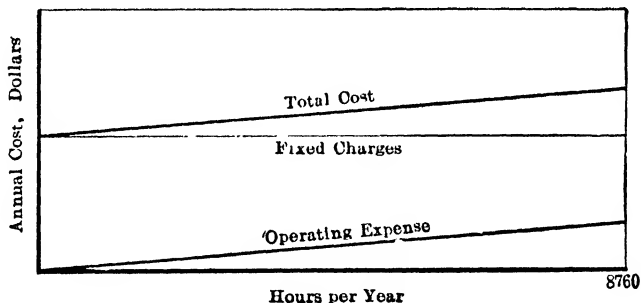

FIG. 119.

Fig. 119). It is evident that the annual cost per horsepower depends upon the conditions of operation.

However, under the usual conditions of operation, the annual cost may be said to vary from \$10 to \$30 per horsepower.

**137. Cost of Power per Horsepower-hour.**—In order to have a true value of the cost of power it is necessary to consider both the load carried and the duration of the load. While the annual cost per horsepower will be a maximum when the plant carries full load continuously throughout the year, the cost per horsepower-hour will be a minimum. Thus suppose the annual cost per horsepower of a plant in continuous operation on full-load is \$20. The cost per horsepower-hour is then 0.228 cents. Suppose that the plant is operated only 12 hours per day and that

<sup>1</sup> For specific cases see Mead's "Water Power Engineering," p. 650.

the annual cost per horsepower then becomes \$17, the cost of power will be 0.388 cents per horsepower-hour. So far the load has been treated as constant; we shall next assume that it varies continuously and that it has a load factor of 25 per cent. By that is meant that the average load is 25 per cent. of the maximum. If the plant be operated 12 hours per day as before, the annual cost per maximum horsepower may still be \$17, but the annual cost per average horsepower will be \$68. This latter divided by 4380 hours gives 155 cents per horsepower-hour. It is clear, then, that the cost of power per horsepower-hour depends very greatly upon the load curve. It may range anywhere from

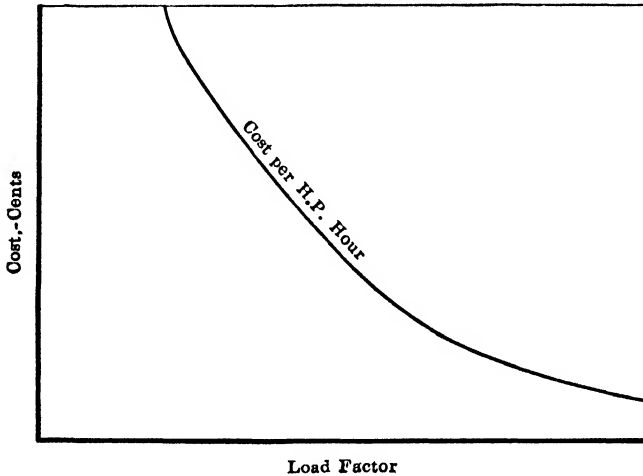

FIG. 120.

0.40 cents to 1.3 cents per horsepower-hour and more if the load factor is low. (See Fig. 120.)

**138. Sale of Power.**—If power is to be sold, one of the first requirements generally is that the output of the plant should be continuous and uninterrupted. Such a plant should possess at least one reserve unit so that at any time a turbine can be shut down for examination or repair. This adds somewhat to the cost of the plant. The larger the units the more the added cost of this extra unit will be. On the other hand small units are undesirable since a large number of them make the plant too complicated. Also the efficiency of the smaller wheels will be less than that of the larger sizes. Unless the water supply is fairly regular, storage reservoirs will be necessary and often auxil-

inary steam plants are essential in order that the service may not be suspended either in time of high or low water.

A market for the power created is essential. If the demand for the power does not exist at the time the plant is projected, there should be very definite assurance that the future growth of industry will be sufficient to absorb the output of the plant.

If the plant is to be a financial success, the price at which power is sold should exceed the cost of generation by a reasonable margin of profit. The price for which the power may be sold is usually fixed by the cost of its production in other ways. This point should be carefully investigated and, if the cost from other sources is less than the cost of the water power plus the profit, the proposition should be abandoned.

**139. Comparison with Steam Power.**—It is necessary to be able to estimate the cost of other sources of power in order to tell

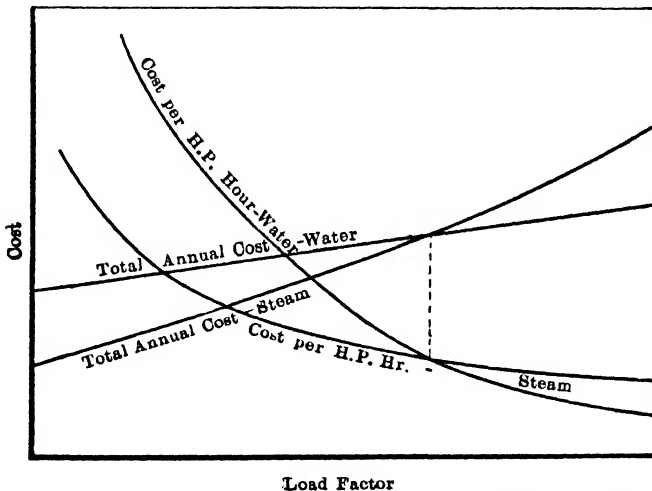

FIG. 121.—Comparison of costs of steam and water power.

whether a water-power plant will pay or not. Also it is often essential to figure on the cost of auxiliary power. As steam is the most common source of power and is typical of all others, our discussion will be confined to it.

In general the capital cost of a steam plant is less than that of a water-power plant. It varies from \$40 to \$100 per horsepower, with an average value of about \$60 per horsepower. Depreciation, repairs, and insurance are at a somewhat higher rate but, nevertheless, the fixed charges are less than for water power.

The amount of labor necessary is greater and this, together

with the cost of fuel and supplies, causes the operating expenses to be higher than with the water power. The total cost of power for the two cases is compared in Fig. 121. As to whether the cost of steam power in a given case is greater or less than that of water power at 100 per cent. load factor it is impossible to state without a careful investigation. But it is clear that, as a rule, the cost of steam power is less when the plant is operated but a portion of the year or when the load factor is low. Thus a water-power plant is of the most value when operated at high load factor throughout the year.

The annual cost of steam power per horsepower is very high for small plants but for capacities above 500 h.p. it does not vary so widely. Its value depends upon the capacity of the plant, the load factor, and the length of time the plant is operated. It may be anywhere from \$20 to \$70, though these are by no means absolute limits.

Since the operating expenses are of secondary importance in a water-power plant, the annual cost per horsepower will not be radically different for different conditions of operation. But with a steam plant the annual cost per horsepower varies widely for different conditions of operation on account of the greater effect of the variable expenses. It is much better to reduce all costs to cents per horsepower hour. The accompanying table gives the usual values of the separate items that make up the cost of steam power, reduced to cents per horsepower hour.

| Items                               | Min., cents | Max., cents |
|-------------------------------------|-------------|-------------|
| Fuel.....                           | 0.20        | 0.75        |
| Supplies.....                       | 0.03        | 0.06        |
| Labor.....                          | 0.07        | 0.14        |
| Administration.....                 | 0.02        | 0.15        |
| Repairs.....                        | 0.05        | 0.10        |
| Fixed charges.....                  | 0.30        | 0.45        |
| Total cost per horsepower hour..... | 0.67        | 1.65        |

The following comparison is made by C. T. Main in *Trans. A. S. M. E.*, Vol. XIII, p. 140. The location was at Lawrence, Mass. Fixed charges were estimated on the following basis:

|                   | Steam,<br>per cent. | Water,<br>per cent. |
|-------------------|---------------------|---------------------|
| Interest.....     | 5.0                 | 5                   |
| Depreciation..... | 3.5                 | 2                   |
| Repairs.....      | 2.0                 | 1                   |
| Insurance.....    | 2.0                 | 1                   |
| Total.....        | 12.5                | 9                   |

For a steam plant at that location the capital cost was taken as \$65 per horsepower. The annual cost per horsepower was as follows:

|                                       |         |
|---------------------------------------|---------|
| Fixed charges 12.5 per cent.....      | \$8.13  |
| Fuel.....                             | 8.71    |
| Labor.....                            | 4.16    |
| Supplies.....                         | 0.80    |
| Total annual cost per horsepower..... | \$21.80 |

For a water plant the cost of the power house and equipment was taken as \$65 while the cost of dams and canals at that place averaged \$65 also, making a total capital cost of \$130 per horsepower. The annual cost per horsepower was as follows:

|                                       |          |
|---------------------------------------|----------|
| Fixed charges 9 per cent.....         | \$11.70  |
| Labor and supplies.....               | 2.00     |
| Total annual cost per horsepower..... | \$ 13.70 |

However, for the case in question, a steam-heating plant was necessary and its cost was divided by the horsepower of the plant giving the capital cost of the auxiliary steam plant as \$7.50 per horsepower of the power plant. The cost of its operation based upon the power plant would be,

|                                     |        |
|-------------------------------------|--------|
| Fixed charges at 12.5 per cent..... | \$0.94 |
| Coal.....                           | 3.26   |
| Labor.....                          | 1.23   |

• Total cost of heating per horsepower of plant.... \$5.43

Adding this to the cost of the power we obtain the total cost of the water power to be \$19.13 per horsepower per year. Evi-

dently the difference in favor of the water power will be \$2.67 per horsepower.

The cost of any kind of power will evidently vary in different portions of the country and it is impossible to lay down absolute facts of universal application. In places near the coal fields the cost of steam power will be a minimum and it may be impossible for water power to compete with it. However where the cost of fuel is high water power may be a paying proposition even though its cost may be relatively high.

**140. Value of Water Power.**—The value of a water power is somewhat difficult to establish as it depends upon the point of view. However, the following statements seem reasonable:

An undeveloped water power is worth nothing if the power, when developed, is not more economical than steam or other power. If the power, when developed, can be produced cheaper than other power, then the value of the water rights would be a sum the interest on which would equal the total annual saving due to the use of the latter. Thus, referring to the case of Mr. Main cited in the preceding article, suppose the water supply is capable of developing 10,000 h.p. The annual saving then due to its use would be \$26,700 as compared with steam. Its value is then evidently a sum the interest on which would be \$26,700 per year.

A power that is already developed must be considered on a different basis. If the power cannot be produced cheaper than that from any other available source, the value of the plant is merely its first cost less depreciation, or from another point of view the sum which would erect another plant, such as a steam power plant, of equal capacity. If the water power can be produced cheaper than any other, the value of the plant will be its first cost less depreciation added to the value of the water right as given in the preceding paragraph.

#### 141. QUESTIONS AND PROBLEMS

1. What are the general factors that affect the cost of a turbine of a given speed and power?
2. What factors affect the cost of a turbine per h.p.?
3. What is meant by capital cost of water power? What items does it include? How is this cost per h.p. affected by the head and by the size of the plant?
4. What is meant by the annual cost of water power? How is it com-

puted? When will it be a maximum and when a minimum for a given plant?

5. How is cost per h.p. hour computed? Upon what factors does it depend? How does it vary as a function of load factor? When is it a maximum for a given plant and when is it a minimum? What can its maximum value be?

6. How do water and steam power compare in general as to capital cost per h.p. and hence as to fixed charges? How do they compare as to operating expenses. How do the total annual costs and the cost per h.p. hour vary for each as functions of load factor?

7. How is it to be determined beforehand whether a water power plant will pay or not?

8. How is the value of a water right to be determined?

9. How is the value of an existing water power plant to be computed? Can there be any doubt about the correctness of the method?

10. Suppose you were called upon to make a report upon a water-power development, the only information given being the head available and the location for the plant, together with an assurance of a market for all power produced. How would you determine: (a) Amount of power that can be developed; (b) How much storage capacity should be provided; (c) Whether the plant should be built at all; (d) Value of the water right; (e) Size of penstock to be used; (f) Type of turbine to be used; (g) Number, size and speeds of units to be used?

11. If steam power costs \$20 per h.p. per year and water power can be produced for \$19 per h.p. per year, what would be the value of an undeveloped water right of 5000 h.p.?

12. A water power plant cost \$100 per h.p. and is estimated to have depreciated 15 per cent. If it costs \$20 per h.p. per year to produce power from it in a place where steam power would cost \$23 per h.p. per year, what is the value of the development?



## CHAPTER XV

### DESIGN OF THE TANGENTIAL WATER WHEEL

**142. General Dimensions.**<sup>1</sup>—Assume that the head, speed, and power for a proposed water wheel are known, these values being so selected as to give the specific speed necessary for the type of impulse wheel desired. It is to be understood that the head is that at the base of the nozzle, and the power is the output corresponding to one jet. The velocity of the jet is given by the equation,  $V_1 = c_v \sqrt{2gh}$ , where the value of the velocity coefficient may be taken as 0.98. (See Fig. 89, page 114.) Since  $B.h.p. = qhe/8.8$ , we may write

$$q = \frac{8.8 \times B.h.p.}{he} = \frac{\pi d^2}{4 \times 144} c_v \sqrt{2gh} \quad (60)$$

where  $d$  is the diameter of the jet in inches. From this the value of  $d$  may be found to be

$$d = 14.33 \sqrt{\frac{B.h.p.}{e \times h^{3/2}}} \quad (61)$$

The diameter of the wheel may be found from equation (47), which gives

$$D = \frac{1840 \phi_e \sqrt{h}}{N}$$

where  $D$  is the diameter in inches of the "impulse circle," which is the circle tangent to the center line of the jet. The overall diameter of the runner depends upon the dimensions of the buckets. The value of  $\phi_e$  is from 0.43 to 0.47.

**143. Nozzle Design.**—The nozzle tip and needle should be so proportioned as to give a constantly decreasing stream area from a point within the nozzle to a point in the jet beyond the tip of the needle, so that the water may be continuously accelerated. This must be so for every position of the needle. The curve of

<sup>1</sup> In this book only the hydraulic features of design will be considered. No space will be devoted to the determination of dimensions which can be computed by the usual methods of machine design.

the needle must therefore change from convex to concave and the point of inflection must be at a diameter greater than that of the nozzle tip, otherwise the water will tend to leave the needle at the smaller openings with a resulting tendency to corrosion. It is also desirable, for the sake of the governor action, that the rate of discharge vary approximately in direct proportion to the linear movement of the needle. (See Fig. 89.)

The diameter of the orifice of the nozzle tip must be greater than the diameter of the jet, due to the contraction of the latter and also to the space taken up by the needle tip, which is never entirely withdrawn. At wide open setting the needle tip may

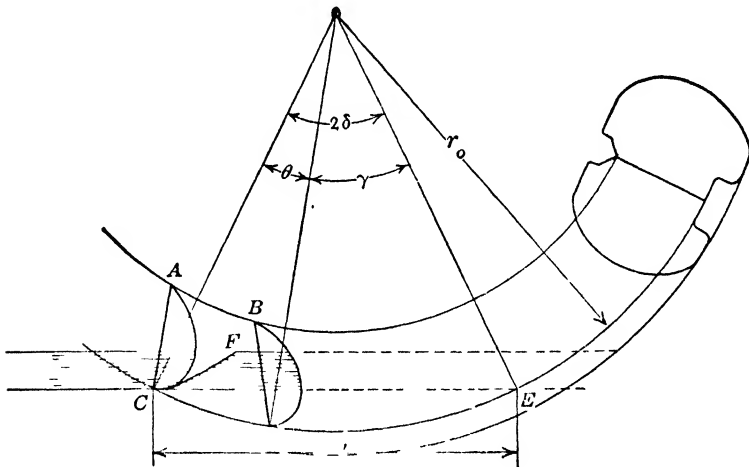

FIG. 122.

occupy 10 per cent. or more of the area of the orifice. The remaining area, through which the water passes, may be computed from the *area* of the jet by the use of a coefficient of contraction, typical values for which are given in Fig. 89, page 114. In reality the effective area of the nozzle is that perpendicular to the stream lines and is the surface of the frustum of a cone, whose elements are perpendiculars dropped from the edge of the orifice to the needle. This area is slightly greater than that in the plane of the orifice. The nozzle tip diameter should be computed for a size of jet sufficiently large to carry the maximum load on the wheel.

**144. Pitch of Buckets.**—In Fig. 122 the bucket A has just completely intercepted the jet. If the particle of water at C is to hit bucket B it must do so before the latter reaches point E.

The time for a particle of water to go from  $C$  to  $E$  is  $t = l/V_1$ . If in the same time bucket  $B$  reaches  $E$ , we have,  $t = \gamma/\omega$ . But  $\omega = u_0/r_0$ , and equating the two values of  $t$ , we obtain  $\gamma = (u_0/r_0) (l/V_1) = (u_0/V_1) (l/r_0)$ . Since  $l/r_0 = 2 \sin \delta$  and  $\theta = 2\delta - r$ , we have

$$\theta = 2\delta - 2 \frac{u_0}{V_1} \sin \delta \quad (62)$$

But this value of the pitch angle would be such as to permit the particle of water to merely touch the bucket before the latter swung up out of its line of action. In order to permit the water to flow over the bucket a closer spacing than this is required. The time necessary for flow over the bucket may be represented by  $t' = l'/v'$ , where  $l'$  is the length of path and  $v'$  the velocity relative to the bucket, a mean value being chosen between  $v_1$

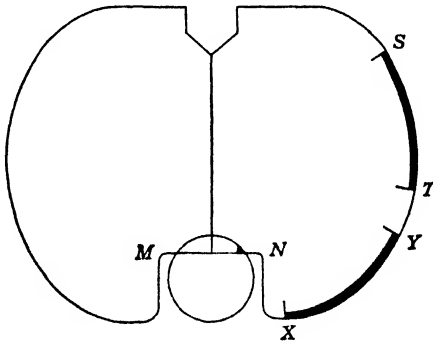

FIG. 123.

and  $v_2$ . It appears rather difficult to express this readily in a simple formula and the practical procedure appears to be to assume an approximate spacing for the buckets and then compute the probable time required for a particle of water to complete its flow. As a preliminary trial value we may assume the above value to be reduced by 20 per cent., in which case the number of buckets  $n$  may be found by

$$n = 2\pi/0.8 \times \theta \quad (63)$$

As noted above, this value should be checked by a numerical computation.

So far the bucket has been considered as if all points on its lower edge were at the same distance from the axis, whereas the buckets of the present day have some form of notch in this edge, as may be seen in Fig. 123. The water which strikes the bucket during

the early part of its course flows out along the arc  $ST$ , while that which strikes during the latter part, when the bucket is quite inclined to the axis of the jet, flows out across the portion  $XY$ . The effect of this prolongation of the bucket beyond the part  $MN$  is to permit the water which strikes it just before it reaches point  $E$  in Fig. 122 to fully act. In other words, referring to Fig. 122, the entrance edge of the bucket describes the arc  $CE$ , but the extreme discharge edge describes a larger arc. This permits the use of fewer buckets on a wheel without involving any loss. It is not desirable to extend the part  $MN$  to the same radius because that would make conditions less favorable when the bucket first enters the jet.

For a high specific speed wheel the runner diameter becomes relatively smaller for the same jet diameter and this shortens the length of the path  $CE$  (Fig. 122). In order that all the water may be fully utilized it is necessary to reduce the time required for the particle of water at  $C$  to catch up with bucket  $B$ . This can be done by reducing the pitch.

But there is evidently a limit to this for mechanical reasons, as a certain amount of metal is necessary in order that each bucket may be securely fastened to the rim. Furthermore, the closer the buckets are placed together the quicker must the water discharged be gotten out of the way of the following bucket. This means that it must leave with a higher residual velocity, which means in turn that the kinetic energy lost at discharge is greater. This is one reason why the efficiency of an impulse wheel is less, if the specific speed is too high. After the number of buckets on a given wheel has been made a maximum, the only other means of increasing the specific speed is to lengthen the buckets still more, but this evidently soon reaches its limit.

The curve representing the end of the portion of the jet intercepted by the bucket  $A$  may be drawn by plotting the path of the tip of the bucket relative to the jet. By computing the time necessary for bucket  $B$  to get to its extreme right hand position and then by moving  $CF$  the distance the water would travel in the same time interval, it is apparent whether any water is not utilized or not, and also the amount wasted can be approximately determined.<sup>1</sup>

<sup>1</sup>See, "Theory of the Tangential Waterwheel," by R. L. Daugherty in *Cornell Civil Engineer*, Vol. 22, p. 164 (1914).

**145. Design of Buckets.**—The general dimensions of the buckets must bear some relation to the size of the jet and experience shows that the width of the bucket should be at least three times that of jet and the length about the same or a little more.<sup>1</sup> The exact dimensions should be determined for individual cases and naturally vary somewhat with the specific speed of the wheel.

In order to get the proper bucket shape, curves may be plotted showing the path of the jet relative to the wheel, as in Fig. 124. In the figure only one such curve is shown, that for the top of the jet, and also we consider here only one section, that in the plane of the paper; but other stream lines and other parallel planes should also be used. It should be noted that this is the relative path for the free jet only. As soon as the water flows over the buckets its absolute velocity is altered, and consequently its

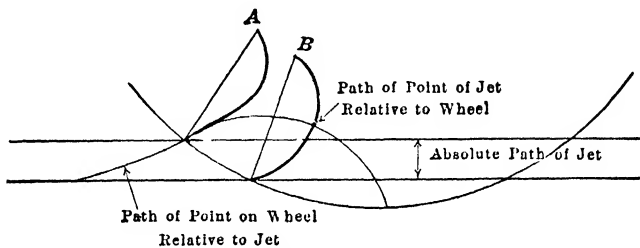

FIG. 124.

relative velocity and path are different. But as the function of these curves is merely to aid in determining the entrance conditions they are sufficient. As the bucket first enters the jet, the water flows in over the lip in the center of the notch, as *MN* in Fig. 123. It is only after the bucket has travelled somewhat farther that the water strikes it fully on the “splitter.” As seen in Fig. 124, the face of the bucket along the lip should be such that the surface is approximately tangent to the relative path of the water, in order not to have any loss of energy at this point. After the bucket has moved along to another position where the jet strikes it in another place, the shape of that portion will be determined in the same way, but of course another portion of the curve will be used. Also the “splitter” should be approximately perpendicular to the relative path. (See Fig. 23.) It should be borne in mind that where the relative and absolute

<sup>1</sup> See paper by Eckart to which reference is made in note on page 145, and for some proportions see Marks' Mech. Eng. Handbook, page 1089.

paths coincide, the bucket, as at *A* (Fig. 124), is shown in its true position in space. But a bucket as at *B*, if shown only in its position relative to the jet, has its true position in space to the right of this. This may be seen further in that the point where the relative path cuts the circle to the right corresponds to the actual position of the particle of water as it leaves the right hand side of the wheel in its absolute path. The use of these curves will enable one to determine the best shape for the bucket along the lip and along the splitter, as well as the best outline for the notch.

But of equal importance with the design of the face of the bucket is that of the shape of the back. As the bucket *A* enters the jet in Fig. 124, its back should not intersect the curve of the relative path of the water. If it does intersect it, it indicates that the back of the bucket will strike the water in the jet and it is obvious that this would result in a loss of efficiency. The back of the bucket could strike the water, despite the higher velocity of the latter, because they are not moving in the same direction. Hence the back of the bucket should be no more than tangent to the curve shown. It is obvious that this matter should be investigated for other stream lines and other planes, besides the one shown.

Ideally the water should be reversed by the bucket and discharged backwards, relatively, at an angle of  $180^\circ$ . But this is impractical because the water would then be unable to get out of the way of the next bucket. Hence such an angle should be used as will enable the water to be discharged with an absolute velocity whose lateral component is sufficient. As has been pointed out, the closer the buckets are placed, the greater must be the value of this velocity and hence the more this angle must be made to differ from  $180^\circ$ . The bucket angle used in practice is about  $170^\circ$ .

If the shape of the bucket can be determined for the entrance and discharge edges by the application of the preceding principles, the bucket may be completed by joining these two portions with any smooth surface of double curvature. There should be no sharp curvature used nor anything which would tend to cause any abrupt change in the path or velocity of the water.

**146. Dimensions of Case.**—The case should be made of sufficient size to allow a reasonable clearance between it and the buckets around the top portion. Usually the lower portion of

the wheel is below the floor level and so the case does not extend to that section. But in any event there should be ample room on either side of the buckets here so that the water discharged from the buckets may not rebound back to the wheel. It is apparent that the higher the head, the greater the discharge velocity, and hence the more room there should be at this place, otherwise water will be thrown back upon the wheel and thus increase the so-called windage loss. This action is most marked in many of the small laboratory wheels that have been made with very narrow cases.

#### 147. QUESTIONS AND PROBLEMS

1. How may the diameter of a Pelton wheel be found for a given head, speed, and power? How may the diameter of jet be found?
2. What are the principles in the design of a needle nozzle? How may the size of the nozzle tip be determined, if the jet diameter is given?
3. How may the necessary pitch for the buckets of an impulse wheel be computed?
4. Why is the tangential water wheel bucket made as it is with a notch in the edge? Would it be possible to have an efficient bucket without this?
5. How may the specific speed of a Pelton wheel be increased? What limits the maximum value of the specific speed?
6. How may the shape of the bucket at the entrance edge be determined? How is the shape of the entire bucket fixed?
7. Suppose an impulse wheel is required to deliver 5,000 h.p. at 300 r.p.m. under a head of 1200 ft. Find the diameter of jet and the diameter of wheel necessary.
8. What would be the approximate diameter of the orifice of the nozzle tip in problem (7)?
9. What would be the probable pitch of the buckets in problem (7) and how many of them would be used on the wheel?
10. The bucket for the wheel in problem (7) may be laid out on the drafting board.

## CHAPTER XVI

### DESIGN OF THE REACTION TURBINE

**148. Introductory.**—Assume that the head, speed, and power for a proposed turbine are known, the speed and power of the runner having been so chosen as to give the specific speed necessary for the type of turbine desired. The type of runner will have been selected in accordance with the principles and considerations of the preceding chapters, so that, as the problem comes to the designer, it is merely a matter of designing a turbine to fit the specified conditions.

It has been seen that practically all dimensions, factors, and even characteristics can be expressed as functions of the specific speed, hence the latter is the logical key to design. After the specific speed of the desired unit is known, the proper factors may be selected in the light of previous experience, and the necessary dimensions computed.

The data given in this chapter is to be understood as merely typical of present practice. It is perfectly possible to alter any of the quantities given, within certain limits, providing other related factors are changed also. Consequently runners of the same specific speed may be built without their being identical in all other respects. Also, of the numerous variables, certain ones are assumed and the rest computed to correspond. It is apparent that the practice of designers may vary according to what is assumed and what is computed, and hence the procedure given here is not the only one that may be followed.

**149. General Dimensions.**—As explained in Art. 37, the value of  $\phi_s$  increases in rational design as the specific speed increases. Customary values of this factor for different values of  $N_s$  are given by a curve in Fig. 126. As stated in the preceding article, this curve is not intended to be followed precisely, but the variation from it should not be too great.

Having selected a suitable value of  $\phi_s$  for the type of runner desired, the diameter may be computed from equation (52), which reduces to

$$D = \frac{1840 \phi_s \sqrt{h}}{N} \quad (64)$$



As has also been explained, the ratio  $B/D$  is a function of specific speed, and, choosing a value of this from Fig. 126, the height of the runner at entrance or the height of the guide vanes may at once be determined.

From equations (53) and (55) we may find the value of  $c_r$ , using whichever form happens to be more convenient.

$$c_r = \frac{6.01q}{BD\sqrt{h}} \tag{65}$$

$$c_r = \frac{0.0000157N_s^2}{\phi_e^2(B/D)e} \tag{66}$$

As an illustration of the possible variation in procedure, it may be noted that we compute  $c_r$  after assuming the value of  $B$ . It

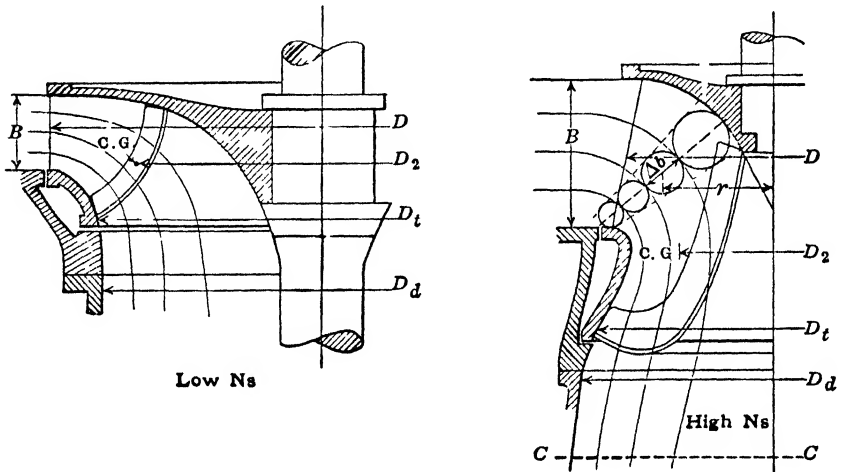

FIG. 125.

would be equally proper to assume a value of  $c_r$  and compute the corresponding value of  $B$ . It should also be noted that the above factors involve the assumption that 5 per cent. of the total area is taken up by the runner vanes. After the design has progressed to the point where the number and thickness of the vanes can be determined, the above may be corrected if that refinement is deemed necessary.

From equation (39), letting  $c_u = c_e \cos \alpha_1$ , we have

$$c_u = e_h/2\phi_e. \tag{67}$$

In the case of high specific speed runners this value needs to be increased about 5 per cent., but it is substantially correct for lower speed runners. See Art. 92.

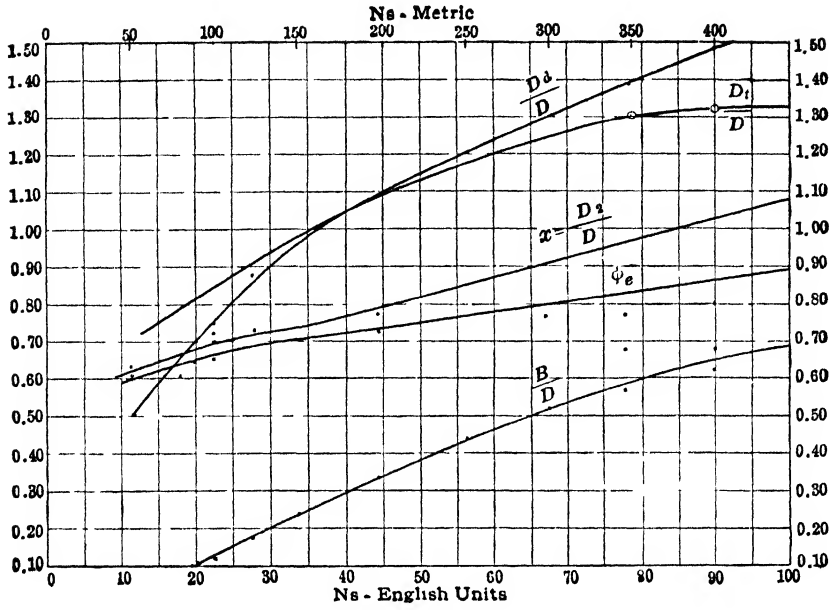

FIG. 126.

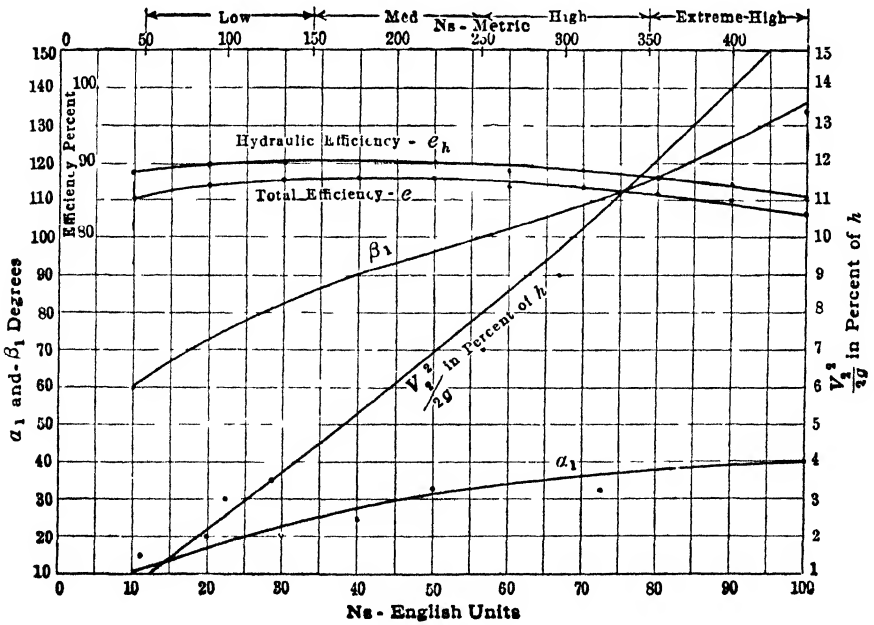

FIG. 127.

The direction of the absolute velocity of the water entering the runner may now be found since

$$\tan \alpha_1 = c_r/c_u \quad (68)$$

and the direction of the relative velocity, which should also be the direction of the runner vane, is given by

$$\tan \beta_1 = c_r/(c_u - \phi_e). \quad (69)$$

The number of guide and runner vanes to be used is decided somewhat arbitrarily, but one fundamental principle to be observed is that they should not be equal to each other nor any simple multiple, otherwise pulsations will be set up. For simplicity of design and shop reasons it is convenient to make the guide vanes a multiple of 4. Zowski's rule is that the number of guide vanes,  $n'$ , may be found by

$$n' = K'\sqrt{D} \quad (70)$$

where  $K' = 2.5$  for  $\alpha_1 = 10^\circ$  to  $20^\circ$ ,  $3.0$  for  $\alpha_1 = 20^\circ$  to  $30^\circ$ ,  $3.5$  for  $\alpha_1 = 30^\circ$  to  $40^\circ$ . Although  $K'$  increases with the specific speed, the diameter of the runner decreases for the same power so that actually the number of vanes is often less.

In order to avoid any pulsations the runner vanes are often made an odd number, though other designers prefer to use an even number which is 2 less than the number of guide vanes. Zowski's rule is that the number of runner vanes,  $n$ , may be found by

$$n = K\sqrt{D} \quad (71)$$

where  $K = 3.7$  for a low specific speed,  $3.0$  for a medium specific speed, and  $2.2$  for a high specific speed.

**150. Profile of Runner.**—The profile of a runner is shown in Fig. 125 and the notation applied to it is clearly indicated. By  $D_2$  is meant the diameter of the circle passing through the center of gravity of the outflow area. In Fig. 34 were shown a few typical profiles, and a more complete set is shown in Fig. 128.

The exact shape of profile desired is determined largely by experience, a shape being used that had been found satisfactory for the specific speed in question. But it is also a matter of the whim or taste of the designer, as theory has little bearing on it directly. But the theory (Art. 66) does indicate that a very sharp radius of curvature is undesirable and an excessive curvature near the band, as is often found with certain high specific

speed runners, simply results in the water failing to follow the path desired, which may result in eddy losses, thus not only reducing the efficiency but also facilitating corrosion at such places. It is also considered desirable to have the length of the path along the crown approximately equal to that along the band, though it is frequently a little more.

With the values given by the curves in Fig. 126 and the aid of the samples shown in Fig. 128 and elsewhere, it is possible to lay out a profile that should be satisfactory. But before drawing in the outflow edge, it is necessary to consider the stream lines. Let us assume that all particles of water flow with the

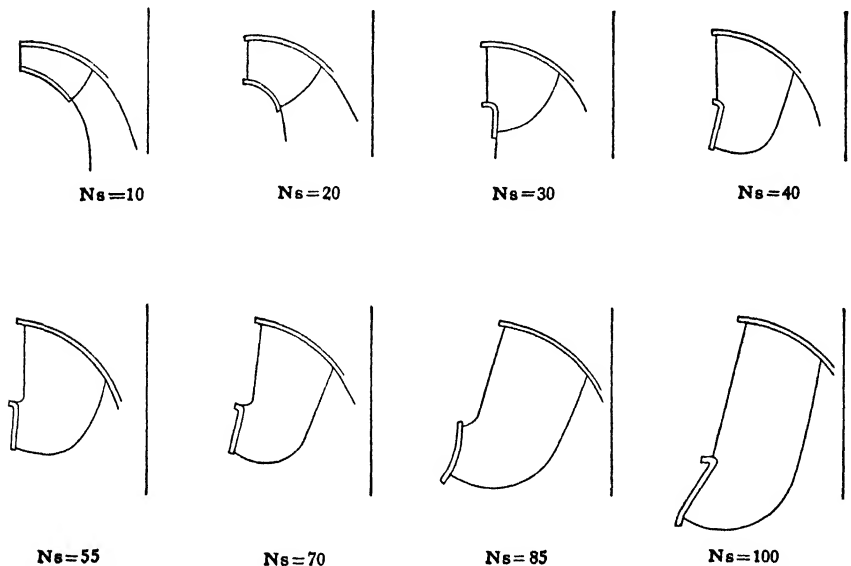

FIG. 128.—Typical profiles.

same velocities and that the total rate of discharge is divided into equal portions. If then the water passages are divided into portions of equal cross-section area, it follows that the boundary lines between them must be stream lines. Hence the height  $B$  at entrance may be divided into equal portions, and for our purpose here we shall assume four. Also the draft tube may be divided into concentric rings of equal area, as shown in Fig. 125, the section  $CC$  being removed far enough from the runner for the stream lines to have become parallel. Then the curves in between may be sketched in by eye. It may be noted that, if at an intermediate section a line be drawn normal to these stream lines, the product  $r \Delta b$  must be constant along this normal.

In reality the velocity is not the same for all stream lines, those nearer the band having a higher velocity than those near the crown, because of the smaller radius of curvature. The difference is very small in the case of the low speed runner, but for the high speed runner the velocity near the crown may be about 30 per cent. below the mean and that near the band about 50 per cent. above the mean velocity. This lowers the flow lines at entrance below the positions as determined above. Also the water in the draft tube, as in any other pipe, tends to flow with a higher velocity in the center than around the circumference. In accordance with these considerations the tentative flow lines, as first sketched in, may be modified, according to judgement. If further refinement is desired, this second set of flow lines may be checked and corrected by the method given in Appendix B.

The outflow edge may now be drawn by making it perpendicular to these various stream lines. But for the portion near the crown this procedure may tend to bring the discharge edge too close to the axis of rotation. The theory (Art. 91) indicates that a large variation in the radii to points along the outflow edge is undesirable, and that the discharge edge should really be parallel to the axis of rotation. The latter is not practicable, but for this portion of the outflow edge a compromise is effected by making it about a mean between a line parallel to the axis and one which would be normal to all the stream lines.

It should be noted that in these profiles we are dealing with circular projection, by which is meant that points are rotated about the axis of the runner until they lie in the plane of the paper. Thus the actual stream lines are not as shown in such a view, the lines drawn being merely circular projections of the actual paths.

**151. Outflow Conditions and Clear Opening.**—In case a stream line is not perpendicular to the outflow edge it indicates that the relative velocity of the water leaving the runner is not really normal to the outflow area, as the latter would ordinarily be measured. It is thus more convenient to deal with components of the velocity in a plane normal to the discharge edge at the point in question. Referring to Fig. 129, let us assume that the outflow edge is actually in the plane of the paper. If  $\alpha_2 = 90^\circ$  be assumed to be the conditions for which the runner is to be designed, the absolute velocities of the water at all points along the outflow edge also lie in the plane of the paper but have the

various directions indicated by the stream lines. The magnitude of the absolute velocity in the draft tube may be computed from the rate of discharge and the area of the tube, provided there is no whirl. The absolute velocity of the water discharging from the runner vanes is somewhat more than this because of the space taken up by the vanes, hence the  $V_2$  at discharge from the runner should be larger than that in the tube by a factor which may be assumed to be about 15 per cent. The absolute velocity of the water is ordinarily assumed to be uniform all along the outflow edge, but actually there may be some variation in it in certain types of runner because of the varying radii of curvature of the different stream lines.

Values of  $V_2$  may be laid off along their respective stream lines as indicated in Fig. 129, and, where they are not perpendicular to the stream line, components indicated by  $V_2'$  should be found. The latter will be used in the diagram below.

The linear velocity of a point on the runner may be laid off at any radius perpendicular to a line representing this radius and a third line then drawn so as to form a triangle. It is often convenient to lay off  $u_1$  at radius  $r_1$ , as shown in Fig. 129. At any other radius the peripheral velocity is given by the intercept. Since  $\alpha_2 = 90^\circ$  and  $V_2$  (or  $V_2'$ ) is known for each stream line, a velocity diagram may be drawn with  $u_2$  as a base, and as many of these constructed as there are stream lines. It should be noted that the crown and band of the runner form boundaries and hence furnish stream lines also. The series of diagrams so constructed, as in Fig. 129, give the values of the relative velocities and the direction of the runner vane at outflow for various points along its edge, if the absolute velocity of discharge is to be at  $90^\circ$ .

The clear opening is the shortest distance from a point on the discharge edge of one vane to the back of the next vane. This is shown in Fig. 129 and it may be seen that the clear opening is practically equal to  $\text{pitch} \times \sin \beta'_2 - \text{vane thickness}$ . The pitch at any radius is known, since the number of runner vanes are known. It may conveniently be found by laying off a value for the pitch at some radius, similar to the procedure for the velocities above, and then the pitch at any other radius may be found by using the proper intercept. This diagram should be drawn to the same scale as the runner. The angle  $\beta'_2$  is that found in the velocity diagrams constructed by using values of  $V'_2$ . In

case this is not necessary, the angle of course becomes merely  $\beta_2$ . Referring to Fig. 129 again, it may be seen that the clear opening may be found graphically at any point by laying off a line from the end of the pitch distance perpendicular to the vector  $v'_2$

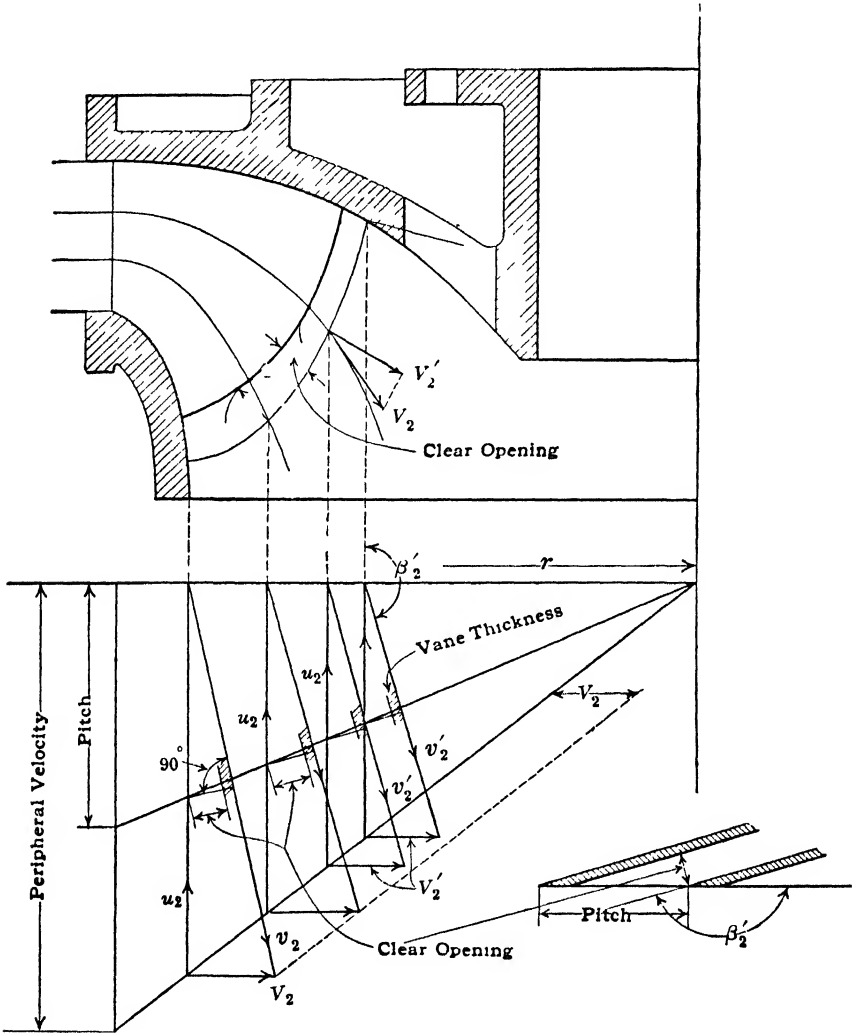

FIG. 129.—Determination of clear opening at outflow.

(or  $v_2$ ). The vane thickness may be subtracted from this line and the remainder is the clear opening.

The clear opening, determined for each one of the stream lines by the method just described, may be laid off from the outflow edge of the runner in the form of an arc. The curve enveloping

these arcs represents the clear opening. The clear opening is not actually in the plane of the paper but each element of it is assumed to be rotated about the line representing the outflow edge until it does lie in the plane of the paper. This may introduce some error where the curvature of the outflow edge is very marked. Since the angle through which it is rotated is usually not very great, the error is small and hence this area in the plane of the paper may be taken as the true outflow area between two runner vanes.

The rate of discharge through any section of the outflow area may now be determined by multiplying each sectional area by the average value of the component of the relative velocity through it. In reality the true outflow area is normal to the true relative velocity, but in case the latter is not in the plane perpendicular to outflow edge, we obtain the same product by the method used.

The rate of discharge for the turbine may now be computed as

$$q = c n \Sigma v'_2 \Delta a_2 \tag{72}$$

where  $n$  denotes the number of vanes,  $v'_2$  the average value of the relative velocity for the section considered and in the plane defined, and  $\Delta a_2$  the element of area between two stream lines. The coefficient of discharge may be taken as 0.95 for low specific speed runners, 0.90 for medium specific speed runners, and 0.85 for high specific speed runners. This is really a coefficient of contraction, since the actual stream areas are less than the areas at the end of the *converging* passages.

If the rate of discharge is not the exact quantity required, the outflow area may be altered somewhat by shifting the position of the crown or by changing the outflow edge until the desired result is obtained. It may be noted that the friction in flow through the runner passages will be less along the middle stream lines than for those near the crown and band. The relative velocity will thus be a little higher in the middle and to preserve a "radial" discharge all along the edge it will be necessary to decrease the angle  $\beta_2$ , which can be done by increasing the clear opening a trifle along the middle portion. By the same line of reasoning the opening may be reduced slightly at each end.

**152. Layout of Vane on Developed Cones.**—By the methods previously given, the conditions at entrance to and discharge from a turbine runner may be determined. Theory does not



prescribe the form of vane between these two portions, except that it must be a smooth surface of gradual curvature to avoid eddy losses. In order to determine the form of this surface, it is convenient to lay out the vanes on developed cones.

In Fig. 130 are shown several lines which are elements of cones whose axes coincide with the axis of rotation of the runner.

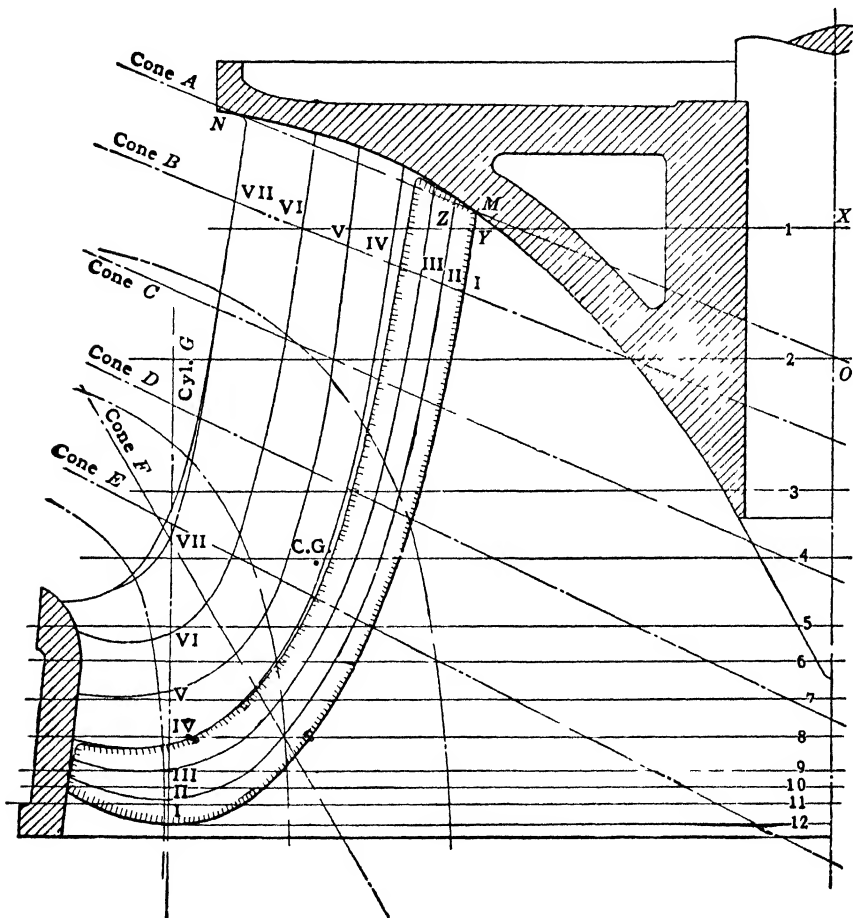

FIG. 130.

These elements should be so taken as to cut both the discharge and the entrance edges and it is desirable also to have them approximately perpendicular to the outflow edge. If this requirement in some instances causes the vertex of a cone to be removed to too great a distance, a cylinder may be used instead, the cylinder being a special case of the cone.

It is desirable to begin with the cone nearest the crown, as

cone A in Fig. 130. This is developed in Fig. 131, the distances  $OM$  and  $ON$  being equal respectively in both figures. Along the arc through  $M$  is laid off a pitch distance  $MP$ , corresponding to the actual pitch of the runner at  $M$ . (This is the pitch at the radius of  $M$  from the axis of rotation and not at the radius  $OM$ ).

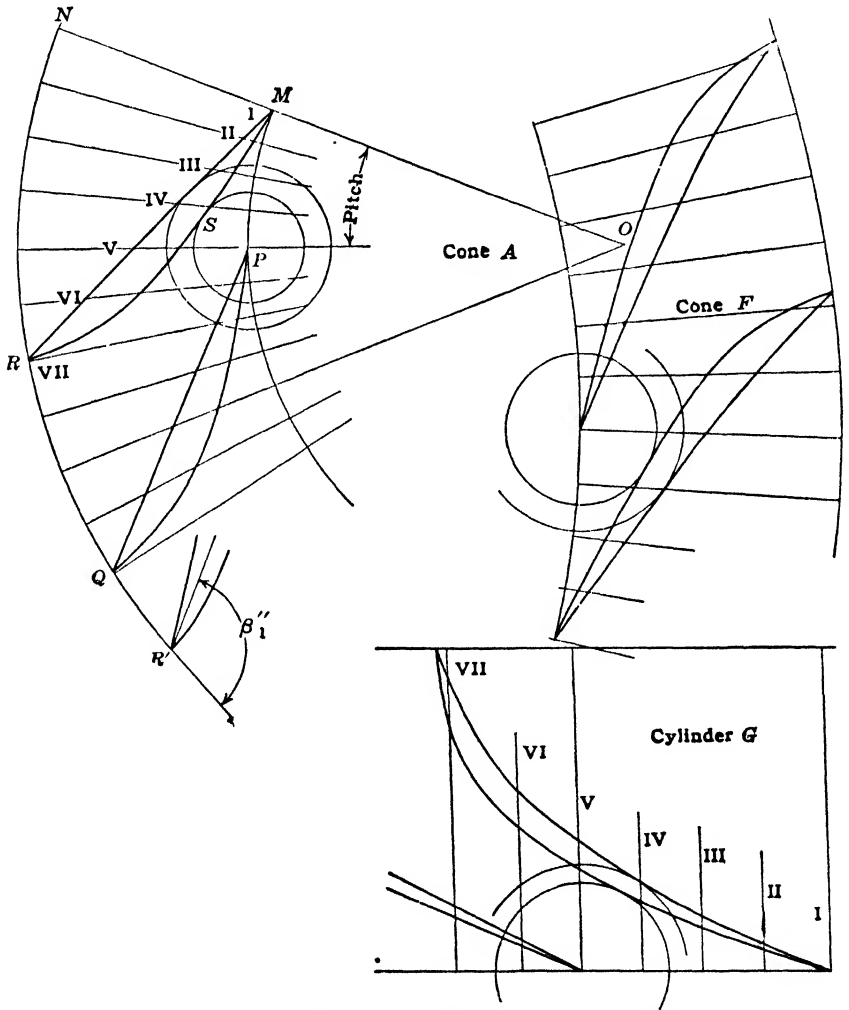

FIG. 131.—Layout of vanes on developed cones.

From  $P$  are described two arcs whose radii are equal to the clear opening at  $M$  and the clear opening plus the vane thickness. From  $M$  the two sides of a vane are then drawn tangent to these arcs, as shown. The actual vane is sharpened on the end, so as to minimize eddy losses. The front side of the vane from  $M$  tangent to the outer arc should be practically a straight line. In

theory the portion along the back of the vane as far as point *S* should be a spiral of the form  $r = \text{constant} + K\theta'$  ( $K$  being a constant and  $\theta'$  the angle subtended at  $O$ ), or an involute so as to keep the cross-section area of the stream constant from  $PS$  to the arc  $MP$ . Actually this is not usually convenient, but the actual shape is between such a curve and a straight line. Thus the shape of discharge ends of the vanes are completely fixed. It may be noted that the clear opening  $PS$  is a constant distance for any cone taken through point  $M$  in Fig. 130.

In the case of the entrance ends of the vanes we might proceed in the same way, but it is usually more convenient to lay off the vane angle instead. It may be noted however that the value of

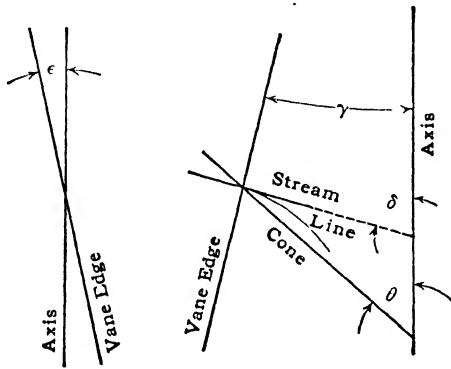

FIG. 132.

the angle on the developed cone is different for different cones through the same point. In the most general case the entrance edge of a runner may be inclined to the axis of rotation at an angle  $\gamma$  as shown in Fig. 132, and also it may not be in the same plane as the axis but in another plane at an angle  $\epsilon$ . Let the elements of the cone make an angle  $\theta$  with the axis, while the projected stream line at entrance makes an angle  $\delta$  with the axis. It may be noted that the actual velocity diagram should always be in the plane of the stream line, and is not necessarily in a plane perpendicular to the axis. If the angle of the relative velocity  $\beta_1$  becomes  $\beta''_1$  on the developed cone, it may be proven by geometry and trigonometry that

$$\tan \beta''_1 = \tan \beta_1 \frac{\sin (\delta + \gamma)}{\sin (\theta + \gamma)}$$

$$\left[ \frac{1}{1 - \frac{\sin (\theta - \delta)}{\sin (\theta + \gamma)} \tan \epsilon \cos \gamma \tan \beta_1} \right] \quad (73)$$

If the angle  $\epsilon$  is zero, as it is in many turbine runners, the expression in the brackets becomes equal to unity and the above formula is greatly simplified.

The angle  $\beta''_1$  may be laid off as at  $R'$  in Fig. 131 and the vane tip then moved along until it reaches such a position that a good smooth curve may join this end of the vane with the portion  $MS$ . The complete vane is now  $MR$ . The next vane  $PQ$  should be drawn in order to find out if the cross-section area continuously decreases from entrance to outflow.

A similar procedure may be gone through with for the other cones or cylinders, except for one restriction. The relative position of  $M$  and  $R$  is purely arbitrary in the first cone used, but for all the remainder this much is fixed. Usually runners are so constructed that all points along the outflow edge are in one plane and furthermore this plane contains the axis of rotation. Our discussion will therefore be confined to this case, though the method could readily be extended to the more general treatment, if desired. If all points along the entrance edge are in the same plane and this plane contains the axis (the angle  $\epsilon$  being zero), the arc  $NR$  subtends an equal number of pitches or fractions thereof in every cone or cylinder. This is most conveniently laid off on the drawing board by establishing an arc at a fixed radius from the axis of rotation and putting this in every cone. Its length is the same in every case. It is convenient to take this arc through the point where the diameter  $D$  is measured.

If the entrance edge is inclined, as indicated by the angle  $\epsilon$  in Fig. 132, the runner vane near the crown subtends a greater angle than that portion nearer the band, and a different length of arc is used in different cones.

If it is difficult or impossible to secure proper vane curves in some of the cones, it may be necessary to go back to cone  $A$  and to change the position of  $R$  so that the vane  $MR$  subtends a different angle. One advantage of inclining the entrance edge, so that it makes the angle as shown, is that it permits of securing better vane curves in all the cones, in some instances. This is particularly true in the case of high specific speed runners.

**153. Intermediate Profiles.**—The various cones and cylinders of Fig. 131 are next divided up into fractional pitches, preferably quarter pitches. These lines represent a series of planes passing through the axis and cutting the vane. The model, the photo-

graph of which is shown in Fig. 133, illustrates this very nicely and shows the intermediate profiles cut out. For cone *A* the distances from *O* to the intersections of planes *I, II, III, IV*, etc. with the vane are transferred from Fig. 131 to Fig. 130, being laid off from *O* along the line *OMN*. A similar procedure is followed for all the cones and cylinders.

Since planes *I, II, III, IV*, etc. are the same in every cone, it follows that profiles can be drawn through all the points with the same number in Fig. 130. If the vane surface is proper,

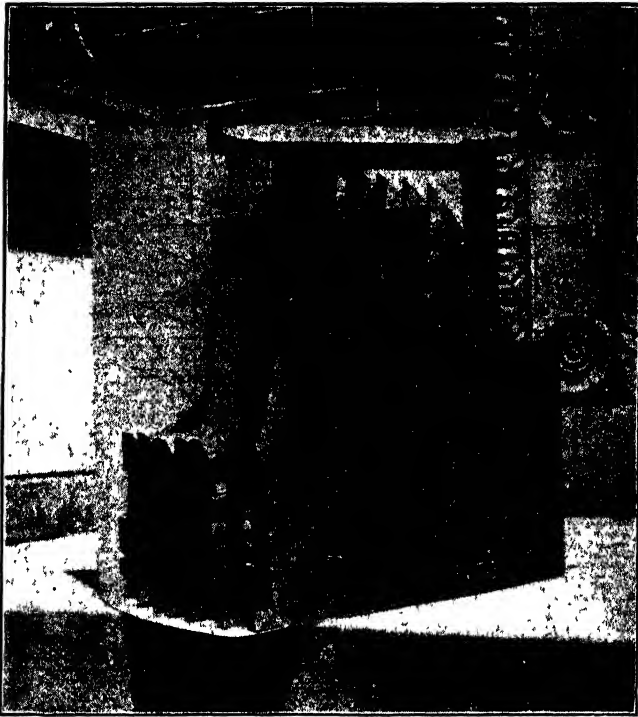

FIG. 133.—Model constructed by Lewis F. Moody illustrating development of vane surface.

these profiles will all be smooth curves, and will all be similar but changing gradually from the entrance edge to the discharge edge. If the curves are not smooth and of the proper shape, it will be necessary to change the vanes laid out on the developed cones until both the profiles and the curves on all the cones are satisfactory. Thus these profiles serve as a check on the work, and also are desirable in order to determine the pattern maker's sections.

**154. Pattern Maker's Sections.**—If a plane be passed through Fig. 130 normal to the axis of the runner, the vane will cut a curve in it which may be found as follows. In Fig. 134 a portion of this plane is drawn and it is subdivided into the same fractional pitches as the various developed cones. The distance *XY* may be transferred from Fig. 130 to Fig. 134 and laid off in plane *I*.

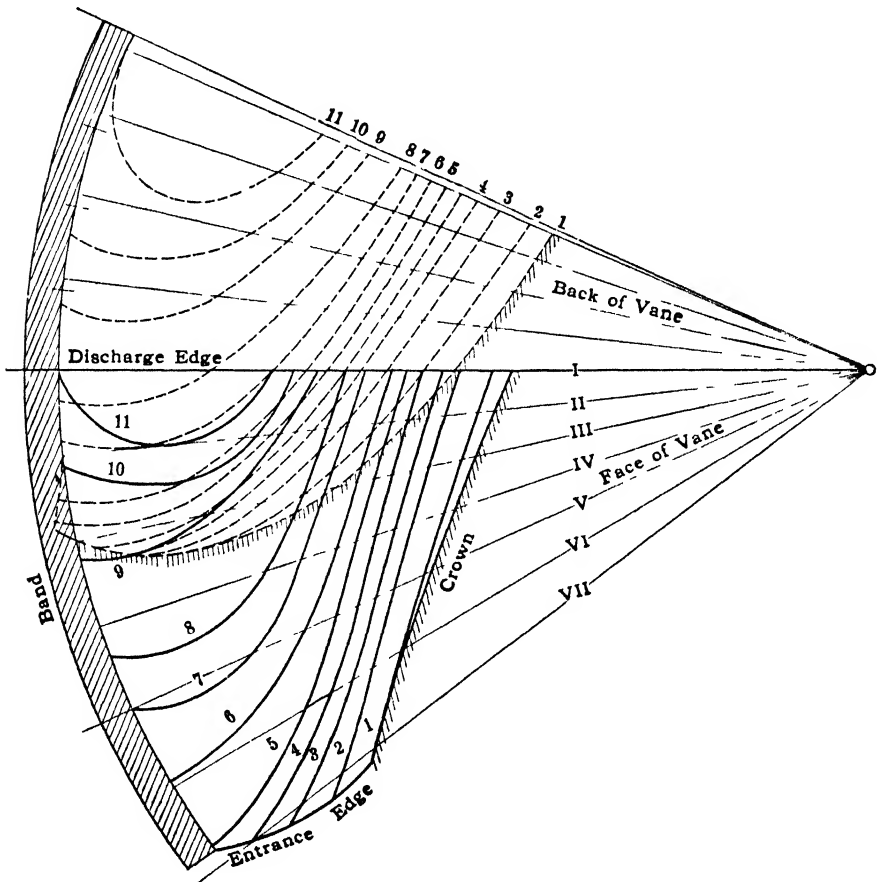

FIG. 134.—Patternmaker's sections.

The distance *XZ* may be transferred in similar manner and laid off along plane *II*. Proceeding in this way the entire curve may be established.

A series of parallel planes at fixed distances apart are used and curves constructed for all of them in the same manner, but on the same drawing, as in Fig. 134. Where the curvature of the vane is sharper the planes are spaced closer together, as shown

in Fig. 133. These planes really represent the surfaces of boards of different thicknesses and on each board the proper curve from Fig. 134 may be laid out. These boards, when placed together, as in Fig. 135, and the surface smoothed down, give the proper shape of the vane surface. In this way the core box for the vane may be formed.

Since the vane has both a front and a back surface which differ slightly from each other, this entire proceeding is carried through

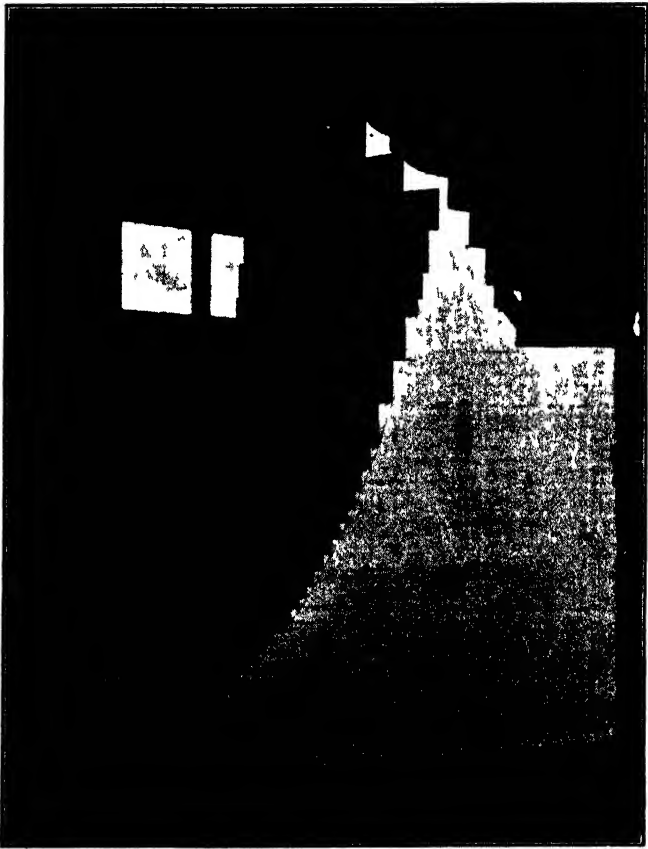

*(Courtesy of Wellman-Seaver-Morgan Co)*

**FIG. 135.**—Construction of pattern for rear face of core box for runner vane.

for both surfaces. It is desirable to draw the profiles and pattern maker's sections for the front of the vane in full lines and for the back of the vane as dotted lines. Also if the lines for the back of the vane in Fig. 134 are placed one pitch distance away from those for the front, one can more readily grasp the appearance of the passageway between the two vanes.

**155. The Case and Speed Ring.**—The velocity of the water in a spiral case may range from  $0.15 \sqrt{2gh}$  to  $0.20 \sqrt{2gh}$ , the higher factor being used for lower heads. For globe and cylinder cases even lower velocities should be employed, because of the hydraulic losses in such cases. A spiral case should be so proportioned that equal quantities of water flow to equal portions of the runner, as shown in Fig. 136. If the cross-section of the case is circular, it may be seen that the radius of a point on the outer boundary is given by  $r = \sqrt{c\theta} + K$  where  $c$  and  $K$  are constants and  $\theta$  the subtended angle, as this curve will give an area which is directly proportional to the angle. For any other change of cross section, it is easy to determine the form necessary by applying the principle that the area must vary as the subtended angle at the runner axis.

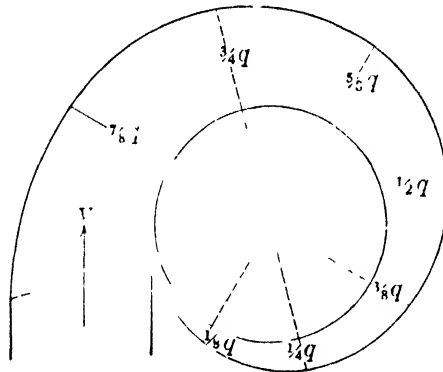

FIG. 136.

The path of a free stream line in the case may be plotted by the principles of Art. 66. If  $V_c$  be the velocity with which the water enters the case and at radius  $r_c$ , the tangential component of the velocity at any other radius is given by

$$V_u = r_c V_c / r$$

while the radial component is given by

$$V_r = q / 2\pi r b$$

where  $r$  is the radius in feet to any point and  $b$  the height of the water passage in feet. These two components give the direction of the water at any radius, and by sketching in a series of tangents it is easy to plot the path by a little trial.

If speed ring vanes are used, they should be so shaped as to





should be small, and also makes it necessary to exert a considerable torque to hold them wide open. The better practice is to so locate the pivot that  $x/y = 3/2$ . The gates are then hydraulically balanced when about half way open and the torque required for either extreme position is less.

**157. QUESTIONS AND PROBLEMS**

1. Given the head, speed and power for a reaction turbine, how may the size of the runner, the height of the guide vanes, and the diameter of the draft tube be determined?

2. For the case in problem (1), how would the guide vane angle and the runner vane angle be determined? What principles are involved in deciding upon the number of guide vanes and runner vanes?

3. How is the profile of a runner to be fully determined? How should the stream lines be drawn in?

4. How may the clear opening of a turbine runner be determined?

5. How may the capacity of a runner be checked? What changes can be made in order that its capacity may be exactly that desired?

6. How are runner vanes laid out on developed cones?

7. Having the vanes laid out on developed cones, how may the intermediate profiles be constructed? What use is made of these?

8. How are pattern maker's sections drawn?

9. What is the object of plotting the free stream lines in a spiral case?

10. How should guide vanes be shaped? What other factors should be considered in their design?

11. A turbine runner is to deliver 4000 h.p. at 600 r.p.m. under a head of 305 ft. Determine  $D$ ,  $B$ ,  $D_t$ ,  $D_d$ ,  $\alpha_1$ ,  $\beta'_1$ ,  $V_2$ , number of guide vanes, and number of runner vanes.

*Ans.*  $D = 37$  in.,  $B = 6.67$  in.,  $D_t = 34.4$  in.,  $D_d = 33.3$  in.,  $\alpha_1 = 16^\circ$ ,  $\beta'_1 = 102^\circ$ ,  $V_2 = 25.6$  ft. per second, 24 guide vanes, and 22 runner vanes.

12. A turbine runner is to be designed for 2000 h.p. at 300 r.p.m. under a head of 88 ft. Find same as in problem (11).

*Ans.*  $D = 43.2$  in.,  $B = 16.4$  in.,  $\alpha_1 = 20^\circ$ ,  $\beta'_1 = 125^\circ$ , 20 guide vanes, and 18 runner vanes.

13. A runner is to be designed to deliver 3000 h.p. at 200 r.p.m. under a head of 64 ft. Find the results called for in problem (11).

14. Find the allowable height above the tail water level for each of the runners in the preceding three problems.

15. Draw profile, sketch tentative flow lines, construct velocity diagram, lay out vanes on cones, and draw patternmaker's sections for one of the turbines given above.

## CHAPTER XVII

### CENTRIFUGAL PUMPS

**158. Definition.**—Centrifugal pumps are so called because of the fact that centrifugal force or the variation of pressure due to rotation is an important factor in their operation. However, as will be shown later, there are other items which enter.

The centrifugal pump is closely allied to the reaction turbine and may be said to be a reversed turbine in many respects. Therefore it will be found that most of the general principles given in Chapter VII will apply here also with suitable modifications. Energy is now given up by the vanes of the impeller

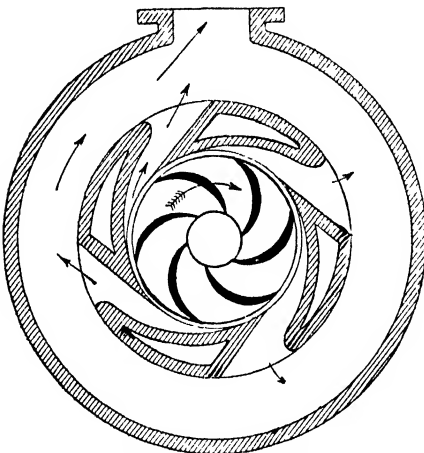

FIG. 138.—Turbine pump.

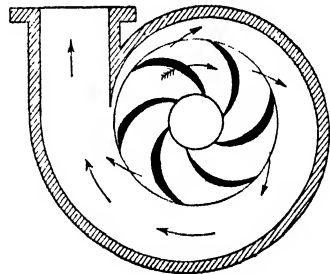

FIG. 139.—Volute pump.

to the water and we have to deal with a *lift* instead of a *fall*. The direction of flow through the impeller is radially outward. During this flow both the pressure and the velocity of the water are increased and when the water leaves the impeller a large part of its energy is kinetic. In any efficient pump it is necessary to conserve this kinetic energy and transform it into pressure.

**159. Classification.**—Centrifugal pumps are broadly divided into two classes:

1. Turbine Pumps.
2. Volute Pumps.

While there are other types besides these, the two given are the most important, and only these will be considered in this chapter.

The turbine pump is one in which the impeller is surrounded by a diffusion ring containing diffusion vanes. These provide gradually enlarging passages whose function is to reduce the velocity of the water leaving the impeller and efficiently transform velocity head into pressure head. The casing surrounding the diffuser may be either circular as shown in Fig. 138 or it may be of a spiral form. This latter arrangement would be similar to that of the spiral case turbine shown in Fig. 55.

The volute pump is one which has no diffusion vanes, but, instead, the casing is of a spiral type so made as to gradually reduce the velocity of the water as it flows from the impeller to the discharge pipe. (See Fig. 139.) Thus the energy transformation is accomplished in a different way. The spiral curve for such a case is usually called the volute, and from this the pump receives its name.

The discussion of the volute pump will apply equally well to all other types without diffusion vanes. The only difference will be that these

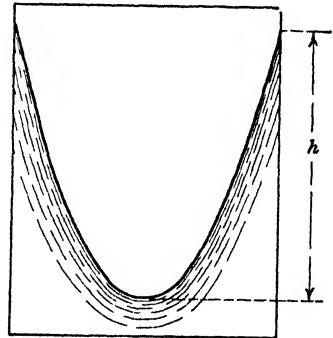

FIG. 140.

other types are less efficient and also it will probably be impossible to express the shock loss at exit in any satisfactory way. Some of these other types have circular cases with the impeller placed either concentric or eccentric within them. Their only merit is cheapness.

**160. Centrifugal Action.**—If a vessel containing water or any liquid is rotated at a uniform rate about its axis, the water will tend to rotate at the same speed and the surface will assume a curve as shown in Fig. 140. This curve can be shown to be a parabola such that  $h = u_2^2/2g$ , where  $u_2$  = linear velocity of vessel at radius  $r_2$ . If the water be confined so that its surface cannot change, the pressure will follow the same law, as shown in Art. 65.

If, as in Fig. 141, we have the water in a closed chamber set in motion by a paddle wheel, the pressure in an outer chamber communicating with it will be greater than that in the center

by the amount  $u_2^2/2g$ . If a piezometer tube be inserted in this chamber, water will rise in it to a height  $h = u_2^2/2g$ . If the height of the tube be somewhat less than this, water will flow out, and we would have a crude centrifugal pump.

**161. Notation.**—The notation used will be essentially the same as that for the turbine. To this, however, we shall add  $\alpha'_2$  as the angle the diffusion vanes make with  $u_2$ , and subscript (3) to denote a point in the casing.

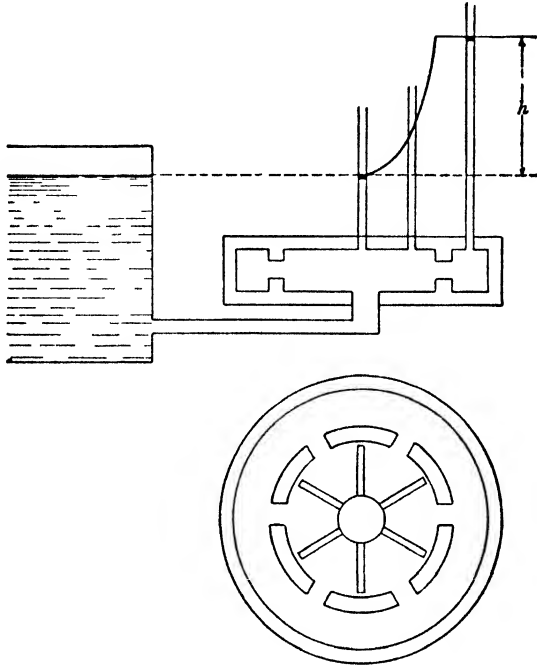

FIG. 141.

The actual lift of the pump will be denoted by  $h$ , while the head that is imparted to the water by the impeller will be denoted by  $h''$ . If  $h'$  represents all the hydraulic losses within the pump and  $e_h$  represents the hydraulic efficiency, we may write

$$h = e_h h'' = h'' - h' \quad (74)$$

It will also be found to be more convenient to express all velocities in terms of  $u_2$  and  $v_2$ .

Whereas turbines are rated according to the diameter of the runner, centrifugal pumps are rated according to the diameter of the discharge pipe in inches. The usual velocity of flow at the discharge is 10 ft. per second. From this the size of pump nec-

essary for a given capacity may be approximately estimated. In some cases, however, the velocity may be twice this value.

**162. Definition of Head and Efficiency.**—In all cases the head  $h$  under which the pump operates is the actual vertical height the water is lifted plus all losses in the suction and discharge pipes. It should be noted that the velocity head at the mouth of the discharge pipe is a discharge loss which should be added.

The head may also be obtained in a test by taking the difference between the total heads (Equation 3) on the suction and discharge sides of the pump. If the suffix ( $S$ ) signifies a point in the suction pipe and suffix ( $D$ ) a point in the discharge pipe we have

$$h = \frac{p_D}{w} - \frac{p_S}{w} + z_D - z_S + \frac{V_D^2}{2g} - \frac{V_S^2}{2g} \quad (75)$$

In this case  $p_D/w$  represents the pressure gage reading reduced to feet of water while  $p_S/w$  represents the suction gage reading reduced to feet of water. In general the latter pressure will be less than that of the atmosphere. In such a case  $p_S/w$  will be negative in value.

The word efficiency without any qualification will always denote gross efficiency, that is the ratio of the power delivered in the water to the power necessary to run the pump. The hydraulic efficiency is the ratio of the power delivered in the water to the power necessary to run the pump after bearing friction, disk friction, and other mechanical losses are deducted. The hydraulic efficiency is therefore equal to  $Wh/Wh''$  or  $h/h''$ . This latter expression is termed manometric efficiency by some and is treated as something essentially different from hydraulic efficiency. If the true value of  $h''$  could be computed, the value of the hydraulic efficiency so obtained would be the same as that obtained experimentally by deducting mechanical losses from the power necessary to drive the pump. Actually the ratio of  $h/h''$  will usually be less than this value but that is due to the fact that our theory is imperfect. (Art. 167.)

**163. Head Imparted to Water.**—By reversing equation (19) in Art. 60, since we are now dealing with a pump and not a turbine, we may write

$$h'' = \frac{h}{e_h} = \frac{1}{g} (u_2 V_{u_2} - u_1 V_{u_1}).$$

This would be very appropriate, if the pump were fitted with

stationary guide vanes in the center of the impeller to direct the water entering. Occasionally centrifugal pumps are so built, but for the usual type of pump, we may say that whatever angular momentum the water has, as it enters the impeller, it has received from the latter, through the medium of intervening particles of water. This is proven by the fact that the water in the eye of the impeller and even in the suction pipe may be set into rotation. The effect is as if the vanes of the impeller extended to this space. For this reason we shall drop the last term in the above equation and write

$$h'' = \frac{1}{g} u_2 V_{u_2} = \frac{u_2}{g} (u_2 + v_2 \cos \beta_2) \quad (76)$$

By another line of reasoning, or by a slight transformation of equation (76), we may obtain

$$h'' = \frac{u_2^2}{2g} - \frac{v_2^2}{2g} + \frac{V_2^2}{2g} \quad (77)$$

Sometimes one of these forms is more convenient than the other.

Inspection of equation (76) shows that if the pump is to do positive work,  $V_{u_2}$  must be positive. Thus the absolute velocity of the water must be directed so as to have a component in the direction of rotation. If the pump speed,  $u_2$ , be assumed constant, equation (76) will plot as a straight line for values of  $v_2$  (or  $q$ ). If  $\beta_2$  is less than  $90^\circ$ , the value of  $h''$  will increase as the rate of discharge increases above zero. If  $\beta_2$  is equal to  $90^\circ$ ,  $h''$  will be independent of the rate of discharge and will plot as a horizontal line for all values of  $v_2$ . If  $\beta_2$  is greater than  $90^\circ$ , the value of  $h''$  will decrease as the rate of discharge increases. (See Fig. 144.)

Since it is difficult to transform velocity head into pressure head without considerable loss, it is desirable to keep the absolute velocity of the water leaving the impeller as small as possible. For that reason the best pumps have vane angles as near  $180^\circ$  as possible in order that the relative velocity may be nearly opposite to the peripheral velocity of the impeller.

**164. Losses.**—In accordance with the usual methods in hydraulics, the friction loss in flow through the impeller may be represented by  $kv_2^2/2g$ , where  $k$  is an experimental constant. A study of Fig. 142 would indicate that there is no abrupt change of velocity at entrance to the impeller under any rate of flow; there is then no marked shock loss at entrance that would re-

quire the use of a separate expression as whatever loss there is may be covered by the value of  $k$ . Where the water leaves the impeller, however, there is an important shock loss that follows a different law from the friction loss.

For the turbine pump this shock loss is similar to that in the case of the reaction turbine in Art. 86. Referring to Fig. 143, it

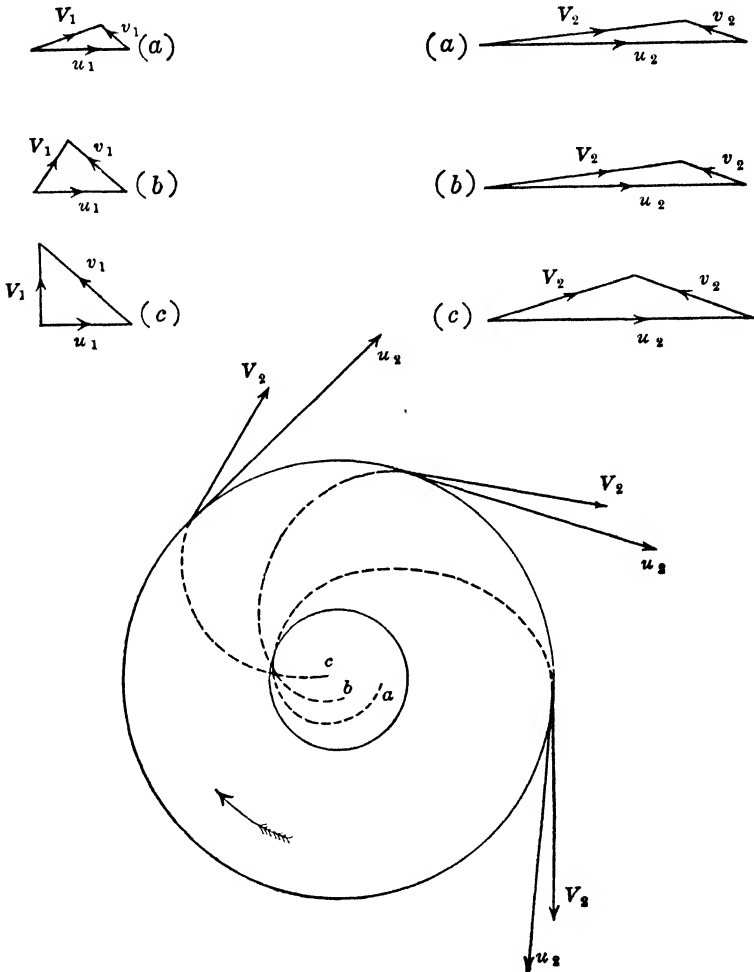

FIG. 142.—Velocity diagram for three rates of discharge.

may be seen that the velocity  $V_2$  and the angle  $\alpha_2$  will be determined by the vectors  $u_2$  and  $v_2$ . Since the vane angle  $\alpha'_2$  is fixed there can be only one value of the discharge that does not involve a shock loss. For any other value of the discharge the velocity  $V_2$  will be forced to become  $V'_2$  with a resultant loss



which may be represented by  $(CC')^2/2g$ . Since the area of the diffusion ring normal to the radius should equal the area of the impeller normal to the radius, the normal component (*i.e.*, perpendicular to  $u_2$ ) of  $V_2$  should equal that of  $V'_2$ . Therefore  $CC'$  is parallel to  $u_2$  and its value may be found to be

$$CC' = u_2 - \frac{\sin(\beta_2 - \alpha'_2)}{\sin \alpha'_2} v_2.$$

If  $k' = \frac{\sin(\beta_2 - \alpha'_2)}{\sin \alpha'_2}$ , then for the turbine pump the shock loss is approximately equal to

$$\frac{(u_2 - k'v_2)^2}{2g}$$

For the turbine pump the total hydraulic loss may be represented by

$$h' = k \frac{v_2^2}{2g} + \frac{(u_2 - k'v_2)^2}{2g} \quad (78)$$

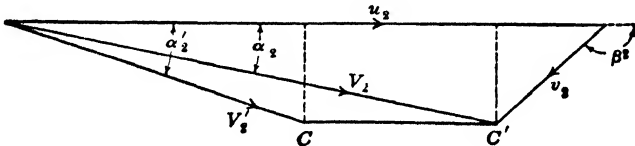

FIG. 143.

Since the volute pump has no diffusion vanes, there will be no abrupt change in the direction of the water at exit from the impeller, but there may be an abrupt change in the magnitude of the velocity. The water leaves the impeller with a velocity  $V_2$  and enters the body of water in the case which is moving with a velocity  $V_3$ . In accordance with the usual law in hydraulics this shock loss may be represented by

$$\frac{(V_2 - V_3)^2}{2g}$$

For the usual type of pump  $V_2$  will decrease as the discharge increases, and in any case  $V_3$  must increase as the quantity of water becomes greater. If the discharge becomes such that the two are equal then there will be no shock loss. The value of  $V_2$  may be expressed in terms of  $u_2$  and  $v_2$ , and if the ratio of  $(a_2/A_3)$  be denoted by  $n$ , we have  $V_3 = nv_2$ . Making these substitutions

\* L. M. Hoskins, "Hydraulics," p. 237.

the total hydraulic loss for the volute pump may be represented by

$$h' = k \frac{v_2^2}{2g} + \frac{(\sqrt{u_2^2 + 2u_2v_2 \cos a_2 + v_2^2} - nv_2)^2}{2g} \quad (79)$$

Though the values of  $k$  may be different for the two types and though the expressions for shock loss are unlike in appearance, yet it can be seen that the losses in each case follow the same general kind of a law. In the turbine pump we have a gradual reduction of velocity but, except for one value of discharge, a sudden change in direction as the water leaves the impeller. With the volute pump we have no abrupt change of direction but a sudden change of velocity. The transformation of kinetic energy into pressure energy is incomplete in either case, but it is generally believed that the loss is somewhat greater in the volute pump than in the turbine pump.

For an infinitesimal discharge the value of the velocity in the case,  $V_3$ , would be practically zero. Therefore a particle of water leaving the impeller with a velocity  $V_2$  and entering a body of water at rest would lose all its kinetic energy. For such a case, however, the value of  $v_2$  would be also practically zero so that  $V_2$  would equal  $u_2$ . Therefore for a very slight discharge the shock loss would be  $h' = u_2^2/2g$ . Such a value of  $h'$  may be obtained from either (78) or (79) by putting  $v_2 = 0$ .

**165. Head of Impending Delivery.**—The head developed by the pump when no flow occurs is called the shut-off head or the head of impending delivery. We are then concerned only with the centrifugal head or the height of a column of water sustained by centrifugal force. In Art. 160 this was shown to be equal to  $u_2^2/2g$ . The same result may be obtained from the principles of Art. 163 and Art. 164. If  $v_2$  becomes zero, then by equation (76),  $h'' = u_2^2/g = 2u_2^2/2g$ . But, as was shown in Art. 164, the loss of head,  $h' = u_2^2/2g$ . Therefore  $h = h'' - h' = u_2^2/2g$ .

Although ideally the head of impending delivery equals  $u_2^2/2g$ , we find that various pumps give values either above or below that. This may be accounted for in a number of ways. In any pump we never have a real case of zero discharge; for a small amount of water, about 5 per cent. of the total rated capacity perhaps, will be short circuited through the clearance spaces. A pump is said to have a rising characteristic if, when run at constant speed, the head increases as the discharge increases above zero until a certain value is reached and then begins to decrease,

If the head continually decreases as the discharge increases above zero, the pump is said to have a falling characteristic. Thus the leakage through the clearance spaces will tend to make the shut-off head greater or less than  $u_2^2/2g$  according to whether the pump has a rising or a falling characteristic. The more the vanes are directed backward, the more tendency there is for internal eddies to be set up and these tend to decrease the head. Also if the water in the eye of the impeller is not set in rotation at the same speed as the impeller the head may be further reduced. There is also a tendency for the water surrounding the impeller to be set in rotation but this, on the other hand, helps to increase the head since the real value of  $r_2$  is greater than the nominal value.

It will usually be found that actually the head of impending delivery may be from 0.9 to 1.1  $\frac{u_2^2}{2g}$ .

**166. Relation between Head, Speed and Discharge.**—When flow occurs the above relation no longer holds, for other factors besides centrifugal force enter in. Due to conversion of velocity head into pressure head when water flows, a lift may be obtained which is greater than  $u_2^2/2g$ . (See Fig. 144.)

This may be shown best by equation (77), when the losses are introduced. The hydraulic friction loss in flow through the impeller may be represented by  $kv_2^2/2g$ . Then at discharge from the impeller a portion of the kinetic energy is lost within the diffuser or within the volute case, and the remainder may be represented by  $mV_2^2/2g$ , where  $m$  is a factor less than unity. Deducting the losses from the expression for  $h''$  in equation (77) we have

$$h'' = \frac{u_2^2}{2g} - (1 + k) \frac{v_2^2}{2g} + m \frac{V_2^2}{2g} \quad (80)$$

If the factor involving  $V_2$  is greater than that with  $v_2$  the head will be greater than the shut-off head, while the reverse is true if it is less.

In order to produce a pump with a rising characteristic, it is not only necessary to conserve the kinetic energy of the water discharged from the impeller, or in other words to keep the factor  $m$  high, but it is also necessary to have  $V_2$  large and  $v_2$  small. But a pump with a falling characteristic is not necessarily any less efficient than the former type. The factor  $m$  may be high but yet  $V_2$  may be made low and  $v_2$  high. In order to accomplish these results, it may be seen that the vane angle  $\beta_2$  has some influence,

but it is not the sole determining factor that many have supposed. It must be noted that we are concerned with  $h$ , which is a very different quantity from  $h''$ , and hence the remarks in Art. 163 cannot be applied here. In fact it has been shown that pumps with vane angles greater than  $90^\circ$  and in fact as large as  $154^\circ$

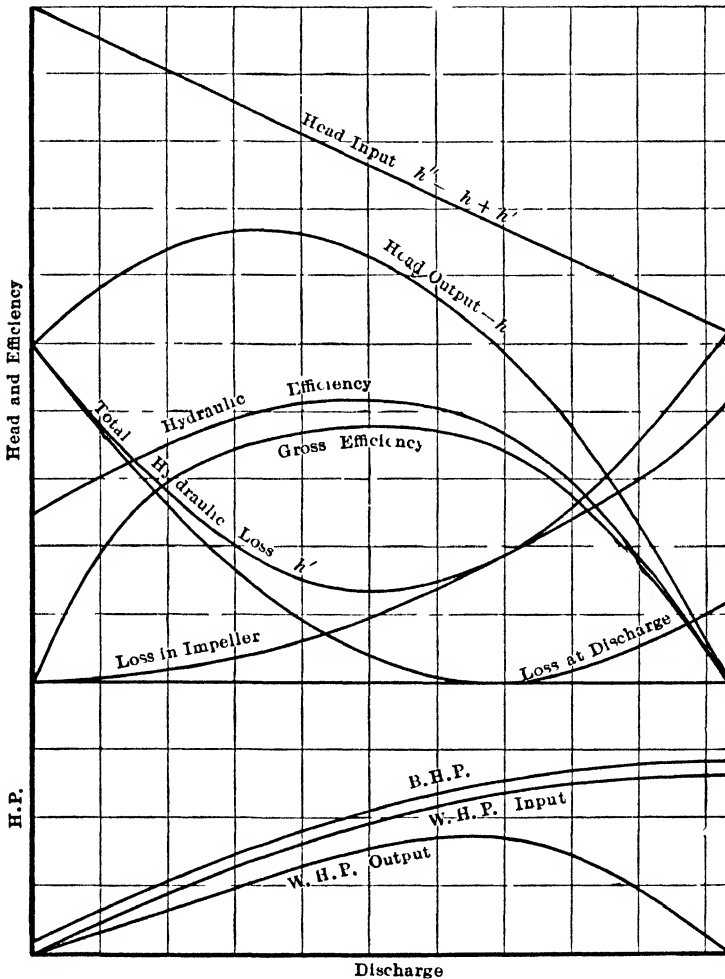

FIG. 144.—Ideal curves for a turbine pump.

may manifest decidedly rising characteristics, while certain impellers with radial vanes have given steep falling characteristics and not flat characteristics.<sup>1</sup>

While the above equation is very satisfactory in explaining how the value of  $h$  may either increase or decrease, and in comput-

<sup>1</sup> See the author's "Centrifugal Pumps."

ing its value for some specified condition, such as that for maximum efficiency, it is not the best form of equation for showing the complete characteristic. This is largely due to the fact that the factor  $m$  is a variable, ranging all the way from zero up to a maximum of about 0.75 at the condition for highest efficiency, and also the rate of discharge affects two different variables  $v_2$  and  $V_2$ , which are in reality related to each other. For some purposes, therefore, it is better to derive the following forms of equations.

The actual lift of the pump  $h$  may be obtained by subtracting the losses  $h'$  from the head  $h''$  imparted by the impeller. The value of  $h''$  will be taken as  $\frac{u_2 (u_2 + v_2 \cos \beta_2)}{g}$  and the values of  $h'$  are given in equations (78) and (79).

Making these substitutions for the turbine pump we obtain after reduction

$$u_2^2 + 2 (k' + \cos \beta_2) u_2 v_2 - (k + k'^2) v_2^2 = 2gh. \quad (81)$$

For the volute pump we obtain after rearranging

$$u_2^2 + 2nv_2\sqrt{u_2^2 + 2u_2v_2 \cos \beta_2 + v_2^2} - (1 + k + n^2) v_2^2 = 2gh \quad (82)$$

These equations involve the relation between the three variables  $u_2$ ,  $v_2$ , and  $h$ . Any one of these may be taken as constant and the curve for the other two plotted. If the pump is to run at various speeds under a constant head, the latter will then be fixed and we may determine the relation between speed and discharge. The more common case is for the pump to run at a constant speed. For that case values of  $h$  may be computed for different values of  $v_2$ . The curves for a turbine pump run at constant speed are shown in Fig. 144.

Although it will not be done here, it will be found convenient to introduce ratios or factors as was done in the case of the turbine. We may write  $u_2 = \phi\sqrt{2gh}$  and  $v_2 = c\sqrt{2gh}$  and using these in equations (81) and (82) we obtain relations between  $c$  and  $\phi$  similar to equation (40). As in the case of the turbine it will be found that the best efficiency will be obtained for a certain value of  $\phi$  and  $c$ . It will thus be clear that the speed of the pump should vary as the square root of the lift, and that the best value of the discharge will be proportional to the square root of the lift. Since  $h = \frac{1}{\phi^2} \left( \frac{u_2^2}{2g} \right)$ , it is apparent that the lift

varies as the square of the speed. If this value of  $h$  be substituted in  $v_2 = c\sqrt{2gh}$  we obtain  $v_2 = \left(\frac{c}{\phi}\right) u_2$ , and this shows that the best value of the discharge varies directly as the speed.

Curves between  $c$  and  $\phi$  will be of the same appearance as those drawn for a constant value of  $h$ . To construct curves of the same shape as those drawn for a constant speed it will be necessary to plot values of  $\left(\frac{1}{\phi^2}\right)$  and of  $\left(\frac{c}{\phi}\right)$ .

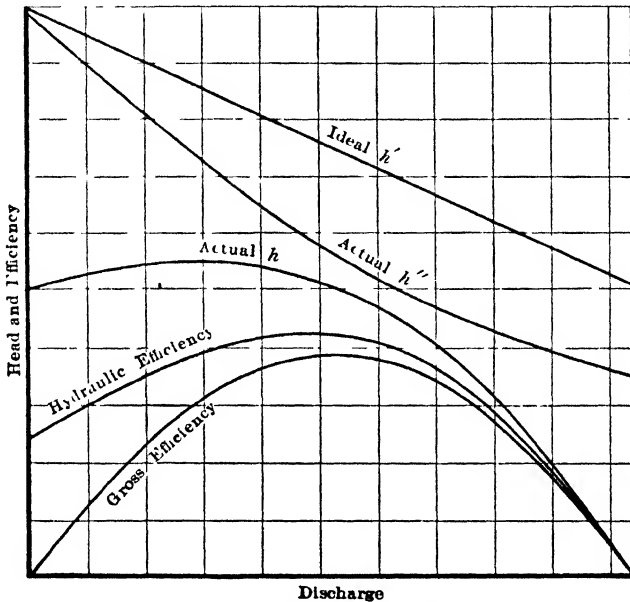

FIG. 145.—Actual curves for turbine pump.

The value of  $\phi$  for the maximum efficiency depends upon the design of the pump. By choosing different values of  $\beta_2$  and either  $\alpha'_2$  or  $n$ , and different numbers of impeller vanes and other factors, a pump may be given a rising or a flat or a steep falling characteristic. The values of  $\phi$  for the highest efficiency range from about 1.30 down to about 0.90. This means that the normal head is usually

$$h = 0.6 \text{ to } 1.1 \frac{u_2^2}{2g}.$$

The value of  $c_r$ , the coefficient of the radial velocity at the point of outflow from the impeller, is usually from 0.05 to 0.15. All formulas and values in this chapter are based upon the head developed per stages.

**167. Defects of Theory.**—The discussion of the defects of the theory of the reaction turbine in Art. 92 applies equally well to the centrifugal pump. Probably one of the greatest sources of error lies in the assumptions made regarding losses. In particular the expressions for shock loss for either the turbine or the volute pump must be regarded as only rough approximations.

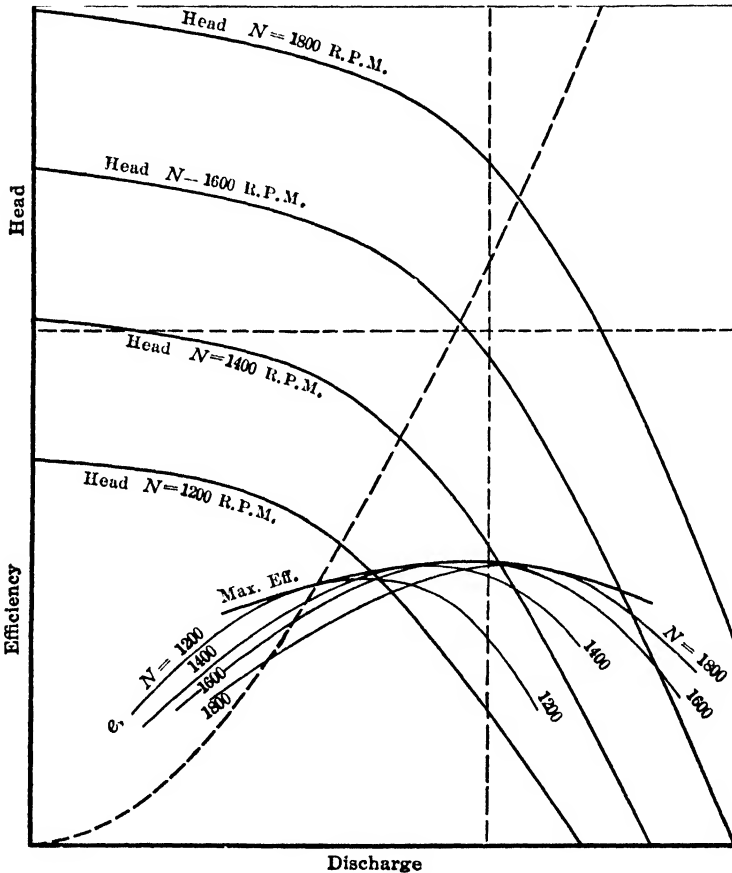

FIG. 146.—Curves for pump run at different speeds.

While actual tests have shown curves similar to the ideal curves given in Fig. 144, it is more common to find the relation between head and discharge to be like that in Fig. 145. In many cases also the pump has a falling characteristic so that the head for any delivery is less than the shut-off head. But at the same time the gross efficiency will be high and the hydraulic efficiency must be still higher. Since  $h'' = h/e$  it will be seen that the

actual  $h''$  must be of the form shown in Fig. 145. This accounts for the discrepancy between the so-called manometric efficiency and the true hydraulic efficiency.

The reasons for this are the same as those given for the reaction turbine. In addition there is strong reason for believing that there is a dead water space on the rear of each vane, thus the actual area  $a_2$  will be less than the nominal area used in the computations. This is probably a larger item than the contraction of the streams mentioned in connection with the turbine. The ordinary pump has no guide vanes at entrance to the impeller and the conditions of flow at that point are uncertain.

The more vanes the impeller has the more perfectly the water is guided and the more nearly the actual curves approach the ideal. It is necessary to have enough vanes to guide the water fairly well but too many of them cause an excessive amount of hydraulic friction. Within reasonable limits—say 6 to 24—the efficiency is but little affected. If the use of few vanes lowers the value of  $h$ , the value of  $h''$  is lowered at about the same rate so that the ratio of the two is but little altered.

**168. Efficiency of a Given Pump.**—If a given pump is run at different speeds the lift should vary as the square of the speed, the discharge as the speed, and the water h.p. as the cube of the speed. If the efficiency of the pump remained constant the horsepower necessary to run the pump would also vary as the cube of the speed. It is probable that the hydraulic efficiency is reasonably independent of the speed. The mechanical losses, however, do not vary as the cube of the speed. For low speeds the mechanical losses do not increase so fast and thus the gross efficiency of the pump will improve as it is used under higher heads at higher speeds. After a certain limit is reached, however, the mechanical losses follow another law and for very high speeds they will increase faster than the hydraulic losses and the efficiency will begin to decline. Thus for a given pump run at increasing speeds the maximum efficiency will increase and then decrease again. It is thus clear that the head which may be efficiently developed with a single stage is limited. For higher heads it is necessary to resort to multi-stages.

These conclusions regarding efficiency are borne out by the curves shown in Fig. 146 and Fig. 147. In the latter the highest speed attained was not sufficient for the efficiency to begin to decrease again, though it had evidently reached its limit.



In a set of curves such as are given in Fig. 146, the operation of the pump under a constant head can be determined by following a horizontal line. For a constant discharge follow a vertical line, and to determine the conditions for maximum efficiency follow the curved dotted line. The values of the maximum efficiency will be given by the curve tangent to the peaks of all the efficiency curves for the various speeds.

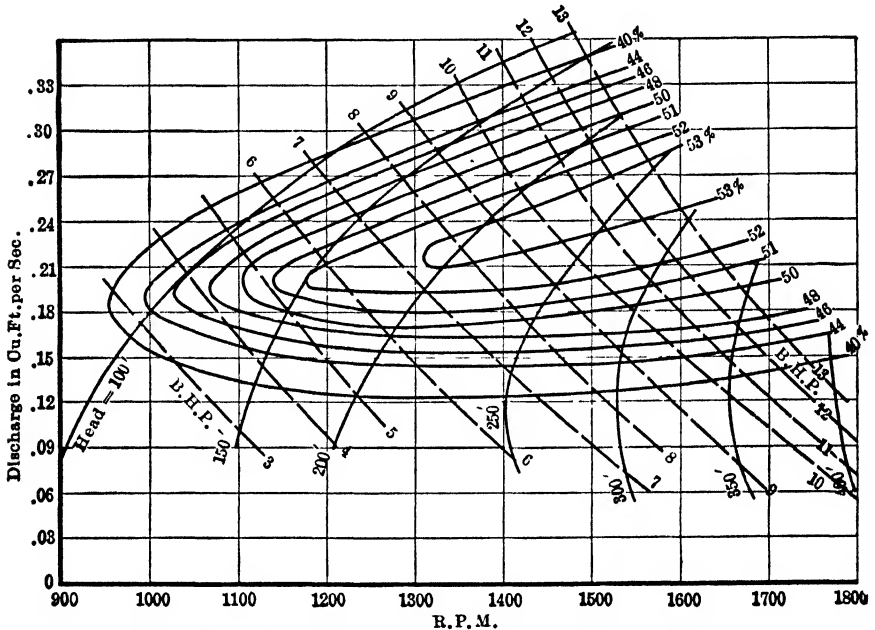

FIG. 147.—Characteristic curve of a 4-stage turbine pump.

**169 Efficiency of Series of Pumps.**—For a given pump the speed and head are seen to have some influence upon its efficiency. However, the capacity for which it is designed is the greatest factor. Suppose we have a series of impellers of the same diameter and same angles running at the same speed, the lift will be approximately the same for all of them. Suppose, however, that the impellers are of different widths. The discharge will then be proportional to the width and the water horsepower is proportional to the discharge. But the bearing friction and the disk friction are practically the same for all of them. In addition the hydraulic friction in the narrow impellers will be greater than that in the larger ones. It is therefore evident that the efficiency of the high-capacity impellers will be much greater than that of the low-capacity impellers. This is true to such

an extent that the efficiency of a centrifugal pump may be said to be a function of the capacity. (See Fig. 148.)

Very large pumps have given efficiencies around 90 per cent. Single suction pumps have slightly lower efficiencies than double suction pumps.

**170. Specific Speed of Centrifugal Pumps.**—The specific speed factor for centrifugal pumps is as useful as that for hydraulic turbines. By it, we can at once determine the conditions that are possible for a pump of existing design, and can also select the most suitable combination of factors for a proposed pump for any case. It also serves to classify pump impellers as to type in the same way that it indicates the type of turbine runner.

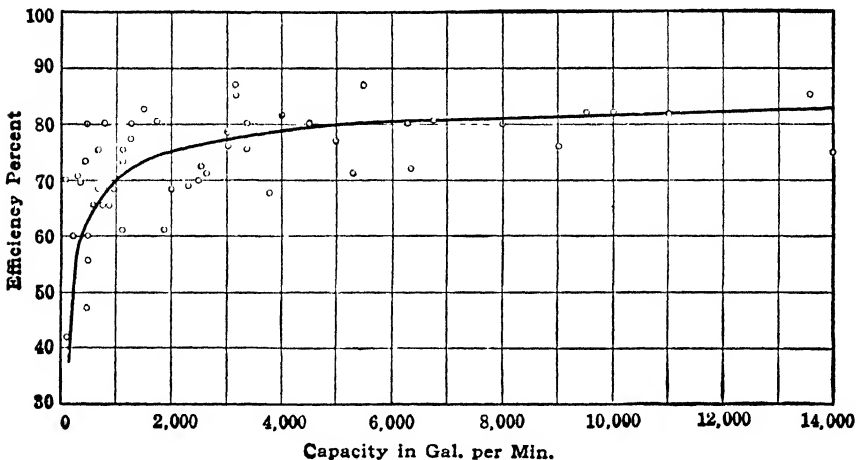

FIG. 148.—Efficiency as a function of capacity.

Thus a low value of the specific speed indicates a narrow impeller of large diameter, while the reverse is true for a high value.

For the centrifugal pump, however, it is more convenient to use a different form for this factor than for the turbine. We are not primarily concerned with the power required to drive a pump, but have our attention centered first upon its capacity. But since the capacity and power are directly related, it is seen that we are merely expressing the specific speed in different units. Since, as in the case of the turbine,  $q = K_1 D^2 \sqrt{h}$ , and  $N = 1840 \phi \sqrt{h}/D$ , we may eliminate  $D$  between the two equations and obtain

$$N'_s = 1840 \phi \sqrt{K_1} = \frac{N \sqrt{q}}{h^{3/4}} \quad (83)$$

But centrifugal pumps are usually rated in gallons per minute rather than in cubic feet per second and it may be more convenient to express the above as

$$N_s = \frac{N\sqrt{G.P.M.}}{h^{3/4}} \quad (84)$$

Since 448 G.P.M. = 1 cu. ft. per second, it may be seen that  $N_s = 21.2N'_s$ .

For a single impeller, values of  $N_s$  ordinarily range from 500 to 8000. This latter figure has been greatly exceeded in a few cases of special types. Just as in the case of the turbine, the efficiency may be expressed as a function of the specific speed, as is shown in Fig. 149.

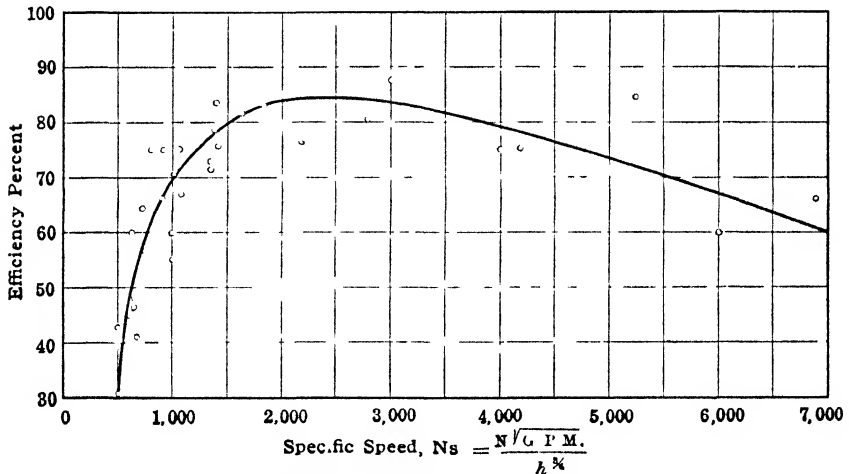

FIG. 149 —Efficiency as a function of specific speed.

**171. Conditions of Service.**—Centrifugal pumps are used for lifting water to all heights from a few feet to several thousand. Several pumps have been built to work against a head of 2000 ft., though these are all multi-stage pumps. The usual head per stage is not more than 100 to 200 ft., though this figure has been exceeded in numerous instances.

The capacities of centrifugal pumps ranges all the way from very small values up to 300 cu. ft. per second or 134,500 gal. per minute. Rotative speeds range ordinarily from 30 to 3000 r.p.m. according to circumstances. All the above figures are for ordinary practice, and are not meant to be the limiting values that can be used.

**172. Construction.**—The design and construction of centrifugal pumps is very similar in principle to that of reaction turbines. Impellers are made either single suction or double suction, according to whether water is admitted at only one or both sides of the impeller. The latter construction permits of a smaller diameter of impeller for the same capacity.

Water leakage from the discharge to the suction side is minimized by the use of clearance rings, as in the case of turbines, and sometimes labyrinth rings are used so as to provide a more tortuous passage for the leakage water. The leakage of air along the shaft on the suction side should be prevented by a water seal in addition to the usual packing.

The end thrust is taken care of by a thrust bearing, by symmetrical construction, as in the case of the double suction pump or a multi-stage pump with impellers set back to back, or by use of an automatic hydraulic balancing piston. The majority of multi-stage pumps are built with the impellers all arranged the same way in the case as this permits the most direct flow from one impeller to the next and also simplifies the mechanical construction.

### 173. QUESTIONS AND PROBLEMS

1. Why is the centrifugal pump so called? How does the pressure and velocity of the water vary as it flows through such a pump?

2. What classes of centrifugal pumps are there, and how do they differ?

3. What is the difference between the head imparted to the water and the head developed by the pump? How is the latter measured in a test?

4. What are the important hydraulic losses in the centrifugal pump? What is meant by the head of impending delivery? What is its approximate value?

5. How may the head vary with the rate of discharge, the speed being constant? Why is this?

6. If a given centrifugal pump is run at a different speed how will the head, rate of discharge, power, and efficiency vary, assuming that the conditions are such that  $\phi$  is constant?

7. Why is the efficiency of a centrifugal pump a function of its capacity?

8. What is meant by the specific speed of a centrifugal pump? What is the use of such a factor?

9. The diameter of the impeller of a single-stage centrifugal pump is 6 in. If it runs at 2000 r.p.m., what will be the approximate value of the shut-off head and the head for the rate of discharge corresponding to maximum efficiency?

*Ans.* 42.5 ft. and 30 ft.

10. What may be the maximum and minimum limits of the capacity of a series of pumps of the same diameter as the single pump in problem (9) and running at the same speed?

11. What will be the answers to problems (9) and (10) if the pump is a four-stage pump, all other data remaining the same?

12. If a single-stage centrifugal pump is to develop a shut-off head of 200 ft., what must be its r.p.m., if the impeller diameter is 18 in.?

*Ans.* 1446 r.p.m.

13. If the above pump were a two-stage unit, what would be the necessary speed?

*Ans.* 1045 r.p.m.

14. Compute the specific speed for the pumps in problems (12) and (13).

15. Compute the factors by which  $u_2^2/2g$  must be multiplied to give the shut-off head and the head for highest efficiency for the pumps whose tests are given in Appendix C, Tables 14 and 15.

## APPENDIX A

### THE RETARDATION CURVE

Let the relation between instantaneous speed and time be represented by the curve shown in the figure. Let

$N$  = r.p.m.

$t$  = seconds.

$s$  = length of subnormals in inches.

$x$  = distance in inches.

$y$  = distance in inches.

$m$  = seconds per inch.

$n$  = r.p.m. per inch.

$I$  = moment of inertia of the rotating mass in ft.-lb. sec.<sup>2</sup> units.

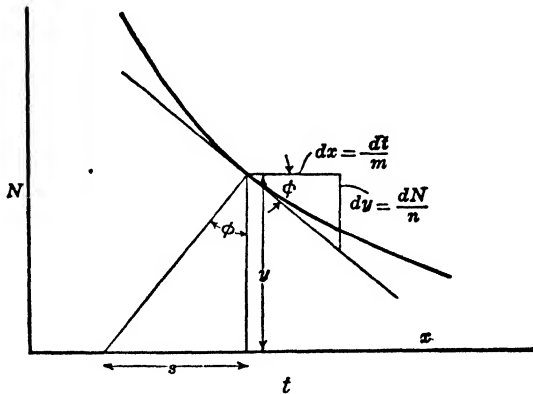

FIG. 150.

Thus  $y = N/n$  and  $x = t/m$

$\omega$  = radians per second  $= 2\pi N/60$ .  $d\omega/dt = (2\pi/60)dN/dt$ .

From mechanics, Torque =  $I d\omega/dt$ . Power =  $I\omega d\omega/dt$ .

$$\text{Power} = (2\pi/60)^2 I N dN/dt$$

$\tan \phi = dy/dx = (dN/n) \div (dt/m)$ .

But also  $\tan \phi = s/y$ . Equating these two,  $dN/dt = ns/my$ .

Thus

$$\begin{aligned} \text{Power} &= (2\pi/60)^2 (n^2/m) I s \\ &= K s \end{aligned}$$

This gives the value of power in ft.-lb. per second. To obtain horse-power or kilowatts it is necessary to introduce the proper constants in computing  $K$ . If the moment of inertia could be computed or determined experimentally the value of  $K$  could be obtained from the above. Usually it is necessary to obtain  $K$  by direct experiment.

## APPENDIX B

### STREAM LINES IN CURVED CHANNELS

The following theory is based upon certain assumptions which are only approximately realized in practice, but yet there are many cases which approach these conditions so closely that the methods here given may be successfully applied.<sup>1</sup> Assume that across any section, such as  $AB$  in Fig. 151, the total head is constant. This will be true if all particles of water, coming from some source, have lost equal amounts of energy en route and thus all reach the section  $AB$  with an equal store of energy. Actually some particles of water may have lost more than others. But

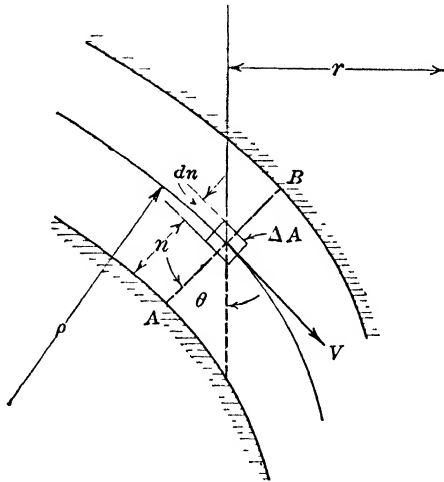

FIG. 151.

if it be assumed that the total head across the section is constant, it follows that, if the pressure is higher at any point, the velocity will be lower than at some other point and vice versa. Owing to centrifugal action, the pressure at  $B$  will be greater than that at  $A$  and hence the velocity will decrease along the line from  $A$  to  $B$ , the line  $AB$  being normal to the stream lines.

In Fig. 151, let us consider an elementary volume of water

<sup>1</sup> From notes by Lewis F. Moody.



whose length in the direction  $AB$  is  $dn$ , the area of the face perpendicular to  $AB$  being  $\Delta A$ . The mass is then  $w\Delta A dn/g$ . Let the stream line in question be at a distance  $n$  from the wall at  $A$  and have a radius of curvature of  $\rho$ . Considering forces along the normal line  $AB$ , we have  $dp \times \Delta A$  due to the difference in pressure on the two faces and  $w\Delta A dn \cos \alpha$  as the component of gravity. The normal acceleration is  $V^2/\rho$ . Hence we may apply the proposition that force equals mass times acceleration and obtain

$$dp\Delta A + w\Delta A dn \cos \alpha = (w\Delta A dn/g)(V^2/\rho)$$

Letting  $dz$  represent the change in elevation corresponding to  $dn$ , we have  $dz = dn \cos \alpha$ . Thus from the above we may write

$$\frac{gdp}{w dn} + \frac{gdz}{w dn} = \frac{V^2}{\rho} \quad (85)$$

Since  $H = \frac{p}{w} + z + \frac{V^2}{2g} = \text{constant}$  along line  $AB$ , we may differentiate with respect to  $n$  and obtain

$$\frac{dH}{dn} = \frac{dp}{w dn} + \frac{dz}{dn} + \frac{2VdV}{2g dn} = 0$$

And from this we may write

$$\frac{gdp}{w dn} + \frac{gdz}{dn} + \frac{VdV}{dn} = 0 \quad (86)$$

Combining equations (85) and (86) we obtain

$$\frac{V^2}{\rho} + \frac{VdV}{dn} = 0$$

This may be written as

$$\frac{dV}{V} = - \frac{dn}{\rho}$$

Integrating

$$\begin{aligned} \log_e \frac{V}{V_A} &= - \int^n \frac{dn}{\rho} \\ \frac{V}{V_A} &= e^{- \int_0^n \frac{dn}{\rho}} \\ V &= \frac{V_A}{e^{+ \int_0^n \frac{dn}{\rho}}} = \frac{V_A}{e^{Y_1}} \end{aligned} \quad (87)$$

In the above,  $V_A$  is the velocity next to the wall at  $A$ , where  $n = 0$ .

In general, sketch in tentative flow lines. Measure the curvature and plot values of  $1/\rho$  as a function of  $n$ . The area between the curve and the  $n$  axis is the value of the integral. Denote this area by  $Y_1$ . Let  $Y_2 = 1/e^{Y_1}$ . Then  $V = V_A Y_2$ . Hence if the velocity at  $A$  were known, the velocity along any other stream line crossing  $AB$  could be determined.

The solution of the problem from this point depends upon the variation in the cross-section perpendicular to the plane of the paper. The remainder of the discussion will be confined to the case where the boundary walls are planes passing through an axis of rotation, as shown. The thickness of the elementary

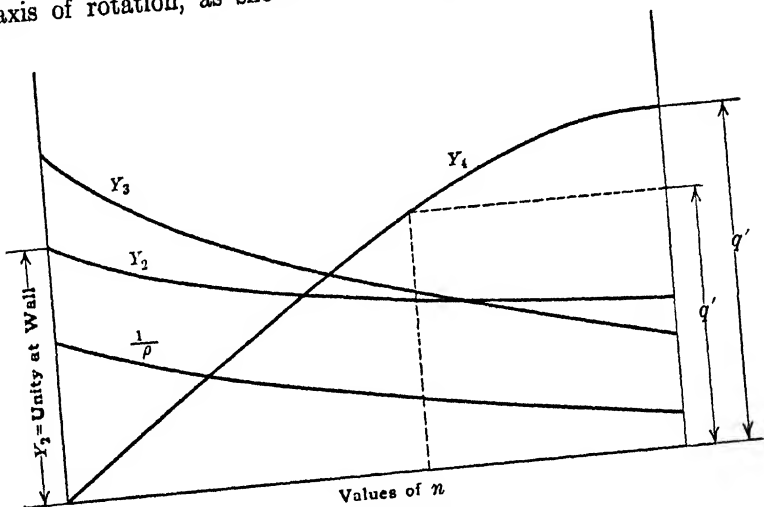

FIG. 152.

volume perpendicular to the plane of the paper will be  $r\Delta\theta$ . The rate of discharge through the channel between the wall at  $A$  and the stream line at distance  $n$  will be

$$\Delta q' = \int_0^n r \Delta \theta \cdot dn \cdot V.$$

For the entire circumference around the axis from which  $r$  is measured, we may substitute  $2\pi$  for  $\Delta\theta$ , and, inserting the value of  $V$  given by equation (87), we have

$$q' = 2\pi V_A \int_0^n \frac{r}{e^{Y_1}} dn = 2\pi V_A \int_0^n Y_3 dn \quad (88)$$

In order to evaluate this, plot a curve for values of  $r/e^{Y_1} = r Y_3 = Y_3$  as a function of  $n$ . Denote the area under this curve

by  $Y_4$ . The ordinates of the curve to  $Y_4$  in Fig. 152 indicate values of  $q'$  from the wall at  $A$  up to any stream line. When  $n = AB$ , the value of  $q' = q$ , which is the known rate of discharge through the entire channel. This final ordinate may then be divided up into any number of equal parts desired and corresponding values of  $n$  determined from the  $Y_4$  curve. This fixes the division points for the stream lines along the section  $AB$ . A similar procedure may be gone through with for any other sections. If a considerable change is effected in the tentative stream lines first assumed, this may be repeated for the corrected

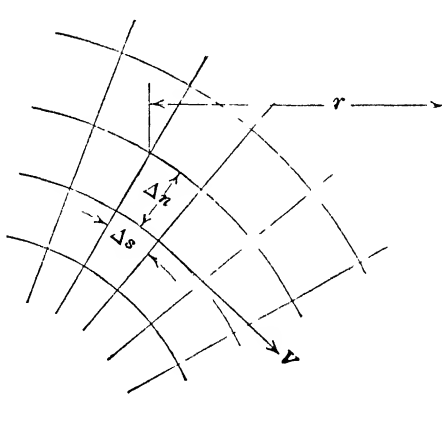

FIG. 153.

set and so on. However extreme accuracy is not warranted, so that a reasonable approximation is quite sufficient.

As a final check on the work it may be noted that if a series of normal lines be drawn, as in Fig. 153,

$$\frac{\Delta n \times r}{\Delta s} = \text{constant} \quad (89)$$

The proof of this is that if two flow lines are spaced  $dn$  apart, we may write  $\Delta s_1/\Delta s_2 = \rho/(\rho + dn)$ . From the preceding treatment, we have  $dV/V = -dn/\rho$ , from which may be obtained  $(V + dV)/V = V_1/V_2 = (\rho - dn)/\rho$ . Multiplying both numerator and denominator of the last term by  $(\rho + dn)$  and dropping differentials of the second order, we have

$$\frac{V_1}{V_2} = \frac{\Delta s_2}{\Delta s_1} \text{ or } V\Delta s = \text{constant} \quad (90)$$

This shows that the velocities along any normal line are inversely

proportional to the distances between the successive normal lines.

If the distance between two bounding surfaces, measured perpendicular to the plane of the paper is  $r\Delta\theta$ , we may write

$$q' = \Delta nr\Delta\theta V = \Delta nr\Delta\theta \times \frac{\text{constant}}{\Delta s}, \text{ since } V\Delta s = \text{constant}.$$

If all stream lines are so spaced as to subdivide the total flow into equal parts, we have for the entire channel  $\Delta n.r/\Delta s = \text{constant}$ .

In the profile views of the turbine runner are shown only the circular projections of the true stream lines. The application of the preceding theory to this case is open to some uncertainty, but the theory should apply rather closely to the stream lines from the draft tube up to the discharge edge of the runner, since these lines should be in the plane of the paper. The principal object of the procedure is to determine the division points along the outflow edge and the direction of the stream lines at these points, and any uncertainty as to the stream lines within the runner will have little effect upon this. Hence the method is acceptable.

## APPENDIX C

### TEST DATA

The following data will supply material from which a number of curves may be constructed. Most of it will be found suitable for plotting characteristic curves, if desired.

Tables 1 to 5 inclusive are Holyoke tests of five reaction turbines of different types, taken from "Characteristics of Modern Hydraulic Turbines" by C. W. Larner in *Trans. A. S. C. E.*, Vol. LXVI, p. 306. Table 6 contains the results of the test of an I. P. Morris turbine in the hydro-electric plant of Cornell University.

Tables 7 to 11 inclusive are tests of the same Pelton-Doble tangential water wheel under widely different heads. These were made under the direction of the author by F. W. Hoyt and H. H. Elmendorf, seniors in Sibley College. In general they confirm the conclusions in Art. 103. Within reasonable limits the characteristic curve is about the same regardless of the head under which the test was made. The results show that the efficiency increases rather rapidly as the head is increased from very low values, but, as the effect of mechanical losses becomes relatively less for the higher heads, the efficiency increases but slightly thereafter. It might be expected that the efficiency would approach a certain value as a limit as the head was indefinitely increased, provided the bearings were adapted to the higher speeds. Such might be the case if it were not for another factor. The absolute velocity of discharge,  $V_2$ , varies as the square root of the head. For low heads the water discharged from the buckets strikes the case and falls into the tail race without interfering with the wheel. For high heads it was observed that the water was deflected back from the case with sufficient velocity to strike the wheel and thus to greatly increase the values of friction and windage over the values given in Table 12, where no water was present. The head at which this interference began to take place was lower as the nozzle opening was increased and varied from 160 ft. with the nozzle open three turns to 50 ft. with the nozzle

wide open. This would account for the decrease in efficiency found under the high heads and would also account to some extent for the maximum efficiency being found at different nozzle openings under the various heads. These last facts would have no application for the reaction turbine.

Some test data taken for the Pelton Water Wheel Co. by the J. G. White Co. will be found in Table 13. The results of tests on two centrifugal pumps of widely different types are given in Tables 14 and 15.

In the construction of characteristic curves, the following method has been found to be very convenient. Construct curves between efficiency and speed under 1-ft. head for the various gate openings. For any given efficiency the speeds for the different gates can be obtained from these and the points thus determined location on the characteristic curve. The iso-efficiency curves may be drawn through these points, thus eliminating the necessity of interpolation. Smooth efficiency curves, however, should be drawn, since very slight errors in data appear magnified on the characteristic curve.

## HYDRAULIC TURBINES

TABLE 1.—TESTS OF A 32-INCH R. H. WELLMAN-SEEVER-MORGAN COMPANY TURBINE WHEEL, No. 1795

Date, February 18 and 19, 1909. Case No. 1794

Wheel supported by ball-bearing step. Swing-gate. Conical draft-tube

| Number of experiment | Proportional part of                     |                                       | Head acting on wheel, in feet | Duration of experiment, in minutes | Revolutions of wheel per minute | Quantity of water discharged by wheel, in cubic feet per second | Horse-power developed by wheel | Percentage of efficiency of wheel |
|----------------------|--|---------------------------------------|-------------------------------|------------------------------------|---------------------------------|---|--------------------------------|-----------------------------------|
|                      | Percentage of full opening of speed-gate | Percentage of full discharge of wheel |                               |                                    |                                 |   |                                |                                   |
| 69                   | 1.000                                    | 1.024                                 | 17.23                         | 4                                  | 112.50                          | 34.45   | 46.84                          | 69.59                             |
| 67                   | 1.000                                    | 1.009                                 | 17.50                         | 3                                  | 152.67                          | 34.22   | 55.80                          | 82.16                             |
| 68                   | 1.000                                    | 1.008                                 | 17.57                         | 2                                  | 163.00                          | 34.05   | 57.31                          | 83.98                             |
| 66                   | 1.000                                    | 1.005                                 | 17.46                         | 3                                  | 164.00                          | 34.05   | 56.90                          | 84.40                             |
| 65                   | 1.000                                    | 0.992                                 | 17.47                         | 3                                  | 172.67                          | 33.60   | 55.92                          | 84.00                             |
| 64                   | 1.000                                    | 0.979                                 | 17.48                         | 3                                  | 181.33                          | 33.17   | 54.53                          | 82.93                             |
| 63                   | 1.000                                    | 0.965                                 | 17.46                         | 4                                  | 189.25                          | 32.67   | 52.53                          | 81.21                             |
| 62                   | 1.000                                    | 0.946                                 | 17.47                         | 4                                  | 213.00                          | 32.06   | 49.27                          | 77.57                             |
| 61                   | 1.000                                    | 0.688                                 | 17.59                         | 4                                  | 251.50                          | 23.39   | 34.91                          | 74.81                             |
| 60                   | 1.000                                    | 0.631                                 | 17.86                         | 4                                  | 298.00                          | 21.62   | 0.00                           | 0.00                              |
| 59                   | 0.889                                    | 0.933                                 | 17.50                         | 3                                  | 113.67                          | 31.63   | 45.23                          | 72.04                             |
| 58                   | 0.889                                    | 0.934                                 | 17.52                         | 3                                  | 135.67                          | 31.70   | 50.84                          | 80.72                             |
| 57                   | 0.889                                    | 0.931                                 | 17.54                         | 3                                  | 146.33                          | 31.60   | 52.80                          | 84.01                             |
| 56                   | 0.889                                    | 0.925                                 | 17.53                         | 3                                  | 153.67                          | 31.40   | 53.32                          | 85.41                             |
| 55                   | 0.889                                    | 0.922                                 | 17.44                         | 4                                  | 156.50                          | 31.21   | 52.85                          | 85.62                             |
| 54                   | 0.889                                    | 0.916                                 | 17.45                         | 3                                  | 160.33                          | 31.00   | 52.66                          | 85.84                             |
| 53                   | 0.889                                    | 0.909                                 | 17.46                         | 3                                  | 164.00                          | 30.79   | 52.35                          | 85.87                             |
| 52                   | 0.889                                    | 0.903                                 | 17.47                         | 4                                  | 168.00                          | 30.59   | 52.07                          | 85.92                             |
| 51                   | 0.889                                    | 0.898                                 | 17.48                         | 4                                  | 172.75                          | 30.42   | 51.95                          | 86.14                             |
| 50                   | 0.889                                    | 0.893                                 | 17.48                         | 4                                  | 176.75                          | 30.25   | 51.52                          | 85.91                             |
| 49                   | 0.889                                    | 0.886                                 | 17.49                         | 4                                  | 184.00                          | 30.05   | 51.08                          | 85.69                             |
| 48                   | 0.889                                    | 0.864                                 | 17.53                         | 4                                  | 206.50                          | 29.31   | 47.77                          | 81.98                             |
| 47                   | 0.889                                    | 0.795                                 | 17.59                         | 4                                  | 244.75                          | 27.02   | 33.97                          | 63.02                             |
| 46                   | 0.889                                    | 0.572                                 | 17.91                         | 4                                  | 298.75                          | 19.61   | 0.00                           | 0.00                              |
| 45                   | 0.741                                    | 0.809                                 | 17.57                         | 4                                  | 106.00                          | 27.48   | 39.23                          | 71.65                             |
| 44                   | 0.741                                    | 0.801                                 | 17.57                         | 4                                  | 139.50                          | 27.20   | 45.18                          | 83.35                             |
| 43                   | 0.741                                    | 0.791                                 | 17.55                         | 3                                  | 152.00                          | 26.85   | 45.71                          | 85.53                             |
| 41                   | 0.741                                    | 0.784                                 | 17.57                         | 4                                  | 159.75                          | 26.63   | 45.82                          | 86.35                             |
| 40                   | 0.741                                    | 0.780                                 | 17.60                         | 4                                  | 166.25                          | 26.52   | 46.15                          | 87.18                             |
| 42                   | 0.741                                    | 0.777                                 | 17.56                         | 4                                  | 171.50                          | 26.40   | 46.02                          | 87.53                             |
| 39                   | 0.741                                    | 0.770                                 | 17.64                         | 4                                  | 180.75                          | 26.22   | 45.99                          | 87.68                             |
| 38                   | 0.741                                    | 0.758                                 | 17.67                         | 4                                  | 191.50                          | 25.82   | 44.30                          | 85.61                             |
| 37                   | 0.741                                    | 0.727                                 | 17.73                         | 3                                  | 210.67                          | 24.81   | 38.99                          | 78.15                             |
| 36                   | 0.741                                    | 0.693                                 | 17.79                         | 3                                  | 231.33                          | 23.68   | 32.11                          | 67.20                             |
| 35                   | 0.741                                    | 0.503                                 | 18.03                         | 2                                  | 298.00                          | 17.31   | 0.00                           | 0.00                              |
| 34                   | 0.593                                    | 0.669                                 | 17.84                         | 3                                  | 101.00                          | 22.89   | 32.71                          | 70.63                             |
| 33                   | 0.593                                    | 0.660                                 | 17.84                         | 3                                  | 122.67                          | 22.61   | 36.32                          | 79.40                             |
| 31                   | 0.593                                    | 0.644                                 | 17.86                         | 3                                  | 145.00                          | 22.07   | 37.57                          | 84.04                             |
| 30                   | 0.593                                    | 0.642                                 | 17.85                         | 3                                  | 151.33                          | 21.98   | 37.81                          | 84.97                             |
| 32                   | 0.593                                    | 0.637                                 | 17.88                         | 4                                  | 158.00                          | 21.83   | 38.081                         | 85.87                             |
| 29                   | 0.593                                    | 0.632                                 | 17.91                         | 4                                  | 163.75                          | 21.68   | 37.8                           | 86.02                             |

TABLE 1.—(Continued)

| Number of experiment | Proportional part of                     |                                       | Head acting on wheel, in feet | Duration of experiment, in minutes | Revolutions of wheel per minute | Quantity of water discharged by wheel, in cubic feet per second | Horse-power developed by wheel | Percentage of efficiency of wheel |
|----------------------|--|---------------------------------------|-------------------------------|------------------------------------|---------------------------------|---|--------------------------------|-----------------------------------|
|                      | Percentage of full opening of speed-gate | Percentage of full discharge of wheel |                               |                                    |                                 |   |                                |                                   |
| 28                   | 0.593                                    | 0.622                                 | 17.91                         | 3                                  | 173.00                          | 21.33   | 36.82                          | 84.98                             |
| 27                   | 0.593                                    | 0.606                                 | 17.99                         | 3                                  | 188.00                          | 20.82   | 34.79                          | 81.90                             |
| 26                   | 0.593                                    | 0.537                                 | 18.16                         | 4                                  | 239.00                          | 15.54   | 22.11                          | 57.92                             |
| 25                   | 0.593                                    | 0.406                                 | 18.05                         | 3                                  | 281.00                          | 13.98   | 0.00                           | 0.00                              |
| 24                   | 0.444                                    | 0.505                                 | 17.91                         | 3                                  | 94.00                           | 17.32   | 23.92                          | 67.99                             |
| 22                   | 0.444                                    | 0.489                                 | 17.92                         | 2                                  | 130.00                          | 16.78   | 27.06                          | 79.36                             |
| 21                   | 0.444                                    | 0.486                                 | 17.94                         | 3                                  | 136.00                          | 16.70   | 27.68                          | 81.48                             |
| 23                   | 0.444                                    | 0.486                                 | 17.92                         | 4                                  | 139.25                          | 16.66   | 27.70                          | 81.82                             |
| 20                   | 0.444                                    | 0.481                                 | 17.94                         | 3                                  | 145.33                          | 16.50   | 27.57                          | 82.12                             |
| 19                   | 0.444                                    | 0.472                                 | 17.94                         | 4                                  | 153.00                          | 16.21   | 26.90                          | 81.56                             |
| 18                   | 0.444                                    | 0.465                                 | 17.95                         | 5                                  | 161.40                          | 15.98   | 26.13                          | 80.34                             |
| 17                   | 0.444                                    | 0.450                                 | 17.99                         | 4                                  | 178.00                          | 15.46   | 24.71                          | 78.32                             |
| 16                   | 0.444                                    | 0.402                                 | 18.04                         | 4                                  | 231.50                          | 13.85   | 16.07                          | 56.70                             |
| 15                   | 0.444                                    | 0.325                                 | 18.17                         | 4                                  | 281.25                          | 11.22   | 0.00                           | 0.00                              |
| 14                   | 0.296                                    | 0.325                                 | 18.19                         | 3                                  | 89.67                           | 11.22   | 15.35                          | 66.32                             |
| 13                   | 0.296                                    | 0.320                                 | 18.21                         | 3                                  | 107.00                          | 11.06   | 16.58                          | 72.60                             |
| 11                   | 0.296                                    | 0.317                                 | 18.23                         | 3                                  | 114.67                          | 10.97   | 16.98                          | 74.85                             |
| 12                   | 0.296                                    | 0.316                                 | 18.22                         | 3                                  | 118.33                          | 10.94   | 16.97                          | 75.07                             |
| 10                   | 0.296                                    | 0.313                                 | 18.24                         | 3                                  | 122.67                          | 10.82   | 17.03                          | 76.07                             |
| 9                    | 0.296                                    | 0.308                                 | 18.25                         | 4                                  | 130.75                          | 10.68   | 16.94                          | 76.62                             |
| 8                    | 0.296                                    | 0.304                                 | 18.26                         | 4                                  | 137.75                          | 10.54   | 16.57                          | 75.91                             |
| 7                    | 0.296                                    | 0.300                                 | 18.30                         | 4                                  | 146.50                          | 10.41   | 16.27                          | 75.29                             |
| 6                    | 0.296                                    | 0.295                                 | 18.31                         | 4                                  | 154.75                          | 10.23   | 15.75                          | 74.15                             |
| 5                    | 0.296                                    | 0.291                                 | 18.32                         | 4                                  | 164.00                          | 10.10   | 15.17                          | 72.31                             |
| 4                    | 0.296                                    | 0.283                                 | 18.33                         | 5                                  | 181.20                          | 9.82  | 14.25                          | 69.81                             |
| 3                    | 0.296                                    | 0.276                                 | 18.36                         | 4                                  | 191.25                          | 9.58  | 13.27                          | 66.53                             |
| 2                    | 0.296                                    | 0.266                                 | 18.33                         | 4                                  | 208.00                          | 9.23  | 11.55                          | 60.18                             |
| 1                    | 0.296                                    | 0.225                                 | 18.37                         | 4                                  | 261.00                          | 7.83  | 0.00                           | 0.00                              |

NOTE.—For experiments Nos. 1, 15, 25, 35, 46 and 60, the jacket was loose.

During the above experiments, the weight of the dynamometer, and of that portion of the shaft which was above the lowest coupling was 1,300 lb.

With the flume empty, a strain of 1.0 lb., applied at a distance of 2 4 ft. from the center of the shaft, sufficed to start the wheel.



TABLE 2.—TESTS OF A 28-INCH R. H. WELLMAN-SEEVER-MORGAN COMPANY TURBINE WHEEL, No. 1796

Date, February 25, 1909

Wheel supported by ball-bearing step. Swing-gate. Conical draft-tube

| Number of experiment | Proportional part of                     |                                       | Head acting on wheel, in feet | Duration of experiment, in minutes | Revolutions of wheel per minute | Quantity of water discharged by wheel, in cubic feet per second | Horse-power developed by wheel | Percentage of efficiency of wheel |
|----------------------|--|---------------------------------------|-------------------------------|------------------------------------|---------------------------------|---|--------------------------------|-----------------------------------|
|                      | Percentage of full opening of speed-gate | Percentage of full discharge of wheel |                               |                                    |                                 |   |                                |                                   |
| 95                   | 1.077                                    | 0.971                                 | 17.11                         | 4                                  | 153.00                          | 97.00   | 125.20                         | 66.52                             |
| 94                   | 1.077                                    | 1.017                                 | 16.97                         | 3                                  | 199.67                          | 101.16  | 147.66                         | 75.84                             |
| 93                   | 1.077                                    | 1.036                                 | 16.94                         | 3                                  | 224.33                          | 102.98  | 156.38                         | 79.04                             |
| 92                   | 1.077                                    | 1.053                                 | 16.89                         | 3                                  | 239.33                          | 104.50  | 159.58                         | 79.72                             |
| 91                   | 1.077                                    | 1.061                                 | 16.87                         | 3                                  | 247.33                          | 105.22  | 161.17                         | 80.06                             |
| 89                   | 1.077                                    | 1.068                                 | 16.81                         | 3                                  | 253.67                          | 105.70  | 161.45                         | 80.12                             |
| 90                   | 1.077                                    | 1.072                                 | 16.80                         | 3                                  | 259.00                          | 106.08  | 161.71                         | 80.01                             |
| 88                   | 1.077                                    | 1.079                                 | 16.82                         | 4                                  | 267.50                          | 106.82  | 162.15                         | 79.58                             |
| 87                   | 1.077                                    | 1.026                                 | 17.05                         | 3                                  | 294.67                          | 102.27  | 125.03                         | 63.23                             |
| 86                   | 1.000                                    | 0.913                                 | 17.28                         | 3                                  | 147.00                          | 91.65   | 120.29                         | 66.98                             |
| 85                   | 1.000                                    | 0.957                                 | 17.16                         | 2                                  | 190.50                          | 95.70   | 144.34                         | 77.50                             |
| 84                   | 1.000                                    | 0.972                                 | 17.14                         | 3                                  | 211.67                          | 97.10   | 152.69                         | 80.89                             |
| 83                   | 1.000                                    | 0.981                                 | 17.13                         | 3                                  | 225.00                          | 98.03   | 156.85                         | 82.36                             |
| 82                   | 1.000                                    | 0.990                                 | 17.11                         | 3                                  | 232.67                          | 98.90   | 157.96                         | 82.31                             |
| 80                   | 1.000                                    | 0.996                                 | 17.09                         | 4                                  | 240.25                          | 99.43   | 160.19                         | 83.13                             |
| 81                   | 1.000                                    | 1.003                                 | 17.07                         | 3                                  | 247.33                          | 100.07  | 161.17                         | 83.19                             |
| 79                   | 1.000                                    | 1.004                                 | 17.07                         | 4                                  | 252.25                          | 100.14  | 160.55                         | 82.82                             |
| 78                   | 1.000                                    | 1.001                                 | 17.13                         | 4                                  | 259.00                          | 100.00  | 157.00                         | 80.82                             |
| 77                   | 1.000                                    | 0.983                                 | 17.22                         | 3                                  | 268.33                          | 98.43   | 146.39                         | 76.15                             |
| 76                   | 1.000                                    | 0.911                                 | 17.47                         | 4                                  | 293.50                          | 91.96   | 106.75                         | 58.59                             |
| 106                  | 0.923                                    | 0.868                                 | 17.32                         | 4                                  | 143.25                          | 87.24   | 115.49                         | 67.39                             |
| 105                  | 0.923                                    | 0.899                                 | 17.24                         | 5                                  | 176.00                          | 90.12   | 135.49                         | 76.90                             |
| 104                  | 0.923                                    | 0.920                                 | 17.15                         | 4                                  | 201.00                          | 91.96   | 146.21                         | 81.74                             |
| 101                  | 0.923                                    | 0.931                                 | 16.93                         | 5                                  | 213.20                          | 92.52   | 148.62                         | 83.66                             |
| 100                  | 0.923                                    | 0.936                                 | 16.93                         | 6                                  | 220.67                          | 92.96   | 150.48                         | 84.31                             |
| 99                   | 0.923                                    | 0.942                                 | 16.91                         | 4                                  | 227.25                          | 93.51   | 151.52                         | 84.50                             |
| 102                  | 0.923                                    | 0.945                                 | 16.93                         | 4                                  | 232.00                          | 93.82   | 151.88                         | 84.31                             |
| 103                  | 0.923                                    | 0.945                                 | 17.04                         | 4                                  | 235.50                          | 94.14   | 152.74                         | 83.96                             |
| 98                   | 0.923                                    | 0.945                                 | 16.93                         | 4                                  | 237.75                          | 93.82   | 151.32                         | 84.00                             |
| 97                   | 0.923                                    | 0.924                                 | 17.02                         | 4                                  | 254.50                          | 92.04   | 138.84                         | 78.15                             |
| 96                   | 0.923                                    | 0.823                                 | 17.25                         | 4                                  | 288.25                          | 82.47   | 87.36                          | 54.15                             |
| 42                   | 0.923                                    | 0.870                                 | 17.17                         | 3                                  | 146.33                          | 87.02   | 116.20                         | 68.57                             |
| 41                   | 0.923                                    | 0.895                                 | 17.10                         | 4                                  | 170.00                          | 89.37   | 130.87                         | 75.51                             |
| 40                   | 0.923                                    | 0.921                                 | 17.04                         | 4                                  | 202.75                          | 91.80   | 146.25                         | 82.44                             |
| 39                   | 0.923                                    | 0.928                                 | 16.99                         | 3                                  | 208.67                          | 92.35   | 147.99                         | 83.17                             |
| 35                   | 0.923                                    | 0.932                                 | 17.03                         | 4                                  | 216.25                          | 92.81   | 150.75                         | 84.10                             |
| 38                   | 0.923                                    | 0.937                                 | 16.97                         | 4                                  | 220.00                          | 93.20   | 151.36                         | 84.38                             |
| 36                   | 0.923                                    | 0.939                                 | 17.01                         | 4                                  | 223.75                          | 93.44   | 152.58                         | 84.65                             |
| 34                   | 0.923                                    | 0.940                                 | 17.02                         | 4                                  | 226.25                          | 93.66   | 150.86                         | 83.45                             |
| 37                   | 0.923                                    | 0.944                                 | 16.97                         | 3                                  | 238.33                          | 93.90   | 151.69                         | 83.94                             |
| 33                   | 0.923                                    | 0.921                                 | 17.13                         | 4                                  | 256.25                          | 92.05   | 139.80                         | 78.18                             |
| 32                   | 0.923                                    | 0.823                                 | 17.27                         | 3                                  | 288.00                          | 82.54   | 87.29                          | 53.99                             |

TABLE 2.—(Continued)

| Number of experiment | Proportional part of                     |                                       | Head acting on wheel, in feet | Duration of experiment, in minutes | Revolutions of wheel per minute | Quantity of water discharged by wheel, in cubic feet per second | Horse-power developed by wheel | Percentage of efficiency of wheel |
|----------------------|--|---------------------------------------|-------------------------------|------------------------------------|---------------------------------|---|--------------------------------|-----------------------------------|
|                      | Percentage of full opening of speed-gate | Percentage of full discharge of wheel |                               |                                    |                                 |   |                                |                                   |
| 31                   | 0.923                                    | 0.730                                 | 17.50                         | 4                                  | 334.75                          | 73.75   | 0.00                           | 0.00                              |
| 74                   | 0.846                                    | 0.824                                 | 17.46                         | 3                                  | 158.67                          | 83.15   | 120.23                         | 73.02                             |
| 75                   | 0.846                                    | 0.836                                 | 17.46                         | 3                                  | 175.67                          | 84.35   | 129.91                         | 77.78                             |
| 72                   | 0.846                                    | 0.861                                 | 17.34                         | 5                                  | 202.20                          | 86.50   | 143.40                         | 84.30                             |
| 70                   | 0.846                                    | 0.865                                 | 17.33                         | 4                                  | 209.00                          | 86.95   | 145.69                         | 85.25                             |
| 71                   | 0.846                                    | 0.868                                 | 17.33                         | 3                                  | 215.00                          | 87.24   | 147.27                         | 85.89                             |
| 73                   | 0.846                                    | 0.870                                 | 17.34                         | 4                                  | 219.25                          | 87.47   | 148.19                         | 86.15                             |
| 69                   | 0.846                                    | 0.869                                 | 17.32                         | 4                                  | 221.25                          | 87.32   | 147.53                         | 86.01                             |
| 68                   | 0.846                                    | 0.866                                 | 17.33                         | 4                                  | 227.75                          | 87.02   | 144.96                         | 84.76                             |
| 67                   | 0.846                                    | 0.858                                 | 17.36                         | 4                                  | 231.75                          | 86.25   | 140.48                         | 82.73                             |
| 66                   | 0.846                                    | 0.845                                 | 17.39                         | 4                                  | 243.75                          | 85.11   | 132.98                         | 79.22                             |
| 65                   | 0.846                                    | 0.828                                 | 17.44                         | 4                                  | 256.50                          | 83.44   | 124.39                         | 75.37                             |
| 64                   | 0.846                                    | 0.754                                 | 17.59                         | 3                                  | 282.00                          | 76.31   | 85.47                          | 56.15                             |
| 30                   | 0.769                                    | 0.750                                 | 17.38                         | 3                                  | 141.00                          | 75.52   | 102.56                         | 68.90                             |
| 26                   | 0.769                                    | 0.766                                 | 17.35                         | 3                                  | 166.00                          | 77.02   | 115.72                         | 76.36                             |
| 27                   | 0.769                                    | 0.779                                 | 17.32                         | 3                                  | 183.00                          | 78.24   | 124.24                         | 80.84                             |
| 25                   | 0.769                                    | 0.789                                 | 17.31                         | 3                                  | 194.00                          | 79.25   | 129.36                         | 83.15                             |
| 29                   | 0.769                                    | 0.793                                 | 17.25                         | 4                                  | 200.75                          | 79.48   | 131.42                         | 84.52                             |
| 28                   | 0.769                                    | 0.792                                 | 17.26                         | 4                                  | 206.00                          | 79.40   | 131.11                         | 84.36                             |
| 24                   | 0.769                                    | 0.773                                 | 17.38                         | 4                                  | 226.25                          | 77.82   | 123.43                         | 80.47                             |
| 23                   | 0.769                                    | 0.735                                 | 17.49                         | 3                                  | 251.33                          | 74.17   | 106.64                         | 72.49                             |
| 22                   | 0.769                                    | 0.690                                 | 17.56                         | 3                                  | 269.67                          | 69.82   | 81.73                          | 58.78                             |
| 21                   | 0.769                                    | 0.623                                 | 17.68                         | 4                                  | 323.75                          | 63.27   | 0.00                           | 0.00                              |
| 20                   | 0.615                                    | 0.617                                 | 17.91                         | 4                                  | 139.50                          | 63.07   | 88.79                          | 69.31                             |
| 16                   | 0.615                                    | 0.627                                 | 17.79                         | 3                                  | 158.33                          | 63.81   | 95.97                          | 74.55                             |
| 17                   | 0.615                                    | 0.634                                 | 17.80                         | 3                                  | 171.33                          | 64.55   | 101.26                         | 77.71                             |
| 15                   | 0.615                                    | 0.638                                 | 17.73                         | 4                                  | 179.50                          | 64.82   | 103.37                         | 79.31                             |
| 18                   | 0.615                                    | 0.636                                 | 17.77                         | 4                                  | 183.00                          | 64.74   | 103.16                         | 79.07                             |
| 19                   | 0.615                                    | 0.634                                 | 17.80                         | 2                                  | 188.00                          | 64.61   | 102.56                         | 78.64                             |
| 14                   | 0.615                                    | 0.627                                 | 17.72                         | 4                                  | 194.50                          | 63.74   | 100.21                         | 78.24                             |
| 13                   | 0.615                                    | 0.596                                 | 17.77                         | 3                                  | 218.67                          | 60.60   | 92.78                          | 75.97                             |
| 12                   | 0.615                                    | 0.563                                 | 17.79                         | 4                                  | 243.00                          | 57.29   | 73.65                          | 63.72                             |
| 11                   | 0.615                                    | 0.519                                 | 17.92                         | 4                                  | 312.00                          | 53.00   | 0.00                           | 0.00                              |
| 10                   | 0.462                                    | 0.452                                 | 17.34                         | 3                                  | 117.33                          | 45.40   | 56.90                          | 63.73                             |
| 5                    | 0.462                                    | 0.453                                 | 17.02                         | 3                                  | 136.00                          | 45.65   | 61.83                          | 70.17                             |
| 7                    | 0.462                                    | 0.461                                 | 17.08                         | 4                                  | 146.75                          | 46.04   | 64.94                          | 72.82                             |
| 6                    | 0.462                                    | 0.462                                 | 17.05                         | 4                                  | 152.00                          | 46.04   | 66.34                          | 74.52                             |
| 4                    | 0.462                                    | 0.462                                 | 16.92                         | 4                                  | 155.25                          | 45.90   | 65.88                          | 74.79                             |
| 9                    | 0.462                                    | 0.459                                 | 17.16                         | 3                                  | 162.00                          | 45.94   | 66.78                          | 74.69                             |
| 8                    | 0.462                                    | 0.457                                 | 17.15                         | 3                                  | 166.67                          | 45.69   | 65.67                          | 73.90                             |
| 3                    | 0.462                                    | 0.451                                 | 16.98                         | 4                                  | 172.25                          | 44.83   | 62.65                          | 72.57                             |
| 2                    | 0.462                                    | 0.432                                 | 17.05                         | 4                                  | 217.50                          | 43.04   | 52.74                          | 63.37                             |
| 1                    | 0.462                                    | 0.404                                 | 17.18                         | 5                                  | 282.40                          | 40.40   | 0.00                           | 0.00                              |

NOTE.—During the above experiments, the weight of the dynamometer, and of that portion of the shaft which was above the lowest coupling, was 2,900 lb.

With the flume empty, a strain of 0.5 lb., applied at a distance of 3.2 ft. from the center of the shaft, sufficed to start the wheel.

## HYDRAULIC TURBINES

TABLE 3.—TESTS OF A 30-INCH R. H. WELLMAN-SEEVER-MORGAN COMPANY TURBINE WHEEL, No. 1797

Date, February 26 and 27, 1909

Wheel supported by ball-bearing step. Swing-gate. Conical draft-tube

| Number of experiment | Proportional part of                     |                                       | Head acting on wheel, in feet | Duration of experiment, in minutes | Revolutions of wheel per minute | Quantity of water discharged by wheel, in cubic feet per second | Horse-power developed by wheel | Percentage of efficiency of wheel |
|----------------------|--|---------------------------------------|-------------------------------|------------------------------------|---------------------------------|---|--------------------------------|-----------------------------------|
|                      | Percentage of full opening of speed-gate | Percentage of full discharge of wheel |                               |                                    |                                 |   |                                |                                   |
| 82                   | 1.000                                    | 0.912                                 | 17.06                         | 3                                  | 149.00                          | 94.89   | 126.41                         | 68.85                             |
| 81                   | 1.000                                    | 0.950                                 | 16.99                         | 3                                  | 160.33                          | 95.52   | 131.16                         | 71.26                             |
| 80                   | 1.000                                    | 0.963                                 | 17.00                         | 4                                  | 190.50                          | 96.85   | 144.30                         | 77.28                             |
| 75                   | 1.000                                    | 0.977                                 | 17.02                         | 4                                  | 210.50                          | 98.34   | 150.52                         | 79.30                             |
| 74                   | 1.000                                    | 0.984                                 | 16.95                         | 4                                  | 220.00                          | 98.81   | 153.31                         | 80.72                             |
| 76                   | 1.000                                    | 0.992                                 | 17.01                         | 4                                  | 227.25                          | 99.75   | 155.61                         | 80.87                             |
| 78                   | 1.000                                    | 0.994                                 | 16.94                         | 4                                  | 229.50                          | 99.75   | 155.76                         | 81.28                             |
| 77                   | 1.000                                    | 0.997                                 | 16.98                         | 4                                  | 231.25                          | 100.14  | 155.55                         | 80.66                             |
| 79                   | 1.000                                    | 1.002                                 | 16.90                         | 3                                  | 239.67                          | 100.45  | 156.85                         | 81.47                             |
| 73                   | 1.000                                    | 1.003                                 | 16.94                         | 4                                  | 254.75                          | 100.70  | 154.37                         | 79.80                             |
| 72                   | 1.000                                    | 0.871                                 | 17.13                         | 3                                  | 287.00                          | 87.93   | 86.96                          | 50.91                             |
| 71                   | 1.000                                    | 0.728                                 | 17.44                         | 3                                  | 317.67                          | 74.17   | 0.00                           | 0.00                              |
| 52                   | 0.923                                    | 0.875                                 | 17.08                         | 3                                  | 131.33                          | 88.14   | 111.42                         | 65.26                             |
| 51                   | 0.923                                    | 0.896                                 | 16.95                         | 3                                  | 156.33                          | 89.97   | 127.89                         | 73.95                             |
| 50                   | 0.923                                    | 0.913                                 | 16.93                         | 4                                  | 188.25                          | 91.66   | 142.59                         | 81.02                             |
| 44                   | 0.923                                    | 0.920                                 | 16.89                         | 4                                  | 201.25                          | 92.20   | 146.34                         | 82.86                             |
| 45                   | 0.923                                    | 0.927                                 | 16.85                         | 4                                  | 211.50                          | 92.81   | 148.67                         | 83.83                             |
| 46                   | 0.923                                    | 0.931                                 | 16.86                         | 4                                  | 217.00                          | 93.20   | 149.91                         | 84.12                             |
| 49                   | 0.923                                    | 0.934                                 | 16.83                         | 4                                  | 220.50                          | 93.42   | 150.99                         | 84.68                             |
| 47                   | 0.923                                    | 0.936                                 | 16.83                         | 4                                  | 223.75                          | 93.60   | 151.86                         | 85.00                             |
| 48                   | 0.923                                    | 0.937                                 | 16.83                         | 3                                  | 226.33                          | 93.74   | 150.87                         | 84.32                             |
| 43                   | 0.923                                    | 0.929                                 | 16.88                         | 4                                  | 241.75                          | 93.13   | 146.49                         | 82.17                             |
| 42                   | 0.923                                    | 0.788                                 | 17.21                         | 4                                  | 276.25                          | 79.76   | 83.70                          | 53.77                             |
| 41                   | 0.923                                    | 0.670                                 | 17.44                         | 4                                  | 312.50                          | 68.26   | 0.00                           | 0.00                              |
| 70                   | 0.846                                    | 0.868                                 | 17.07                         | 4                                  | 192.75                          | 87.47   | 142.50                         | 84.15                             |
| 67                   | 0.846                                    | 0.875                                 | 17.10                         | 4                                  | 205.00                          | 88.22   | 147.83                         | 86.41                             |
| 68                   | 0.846                                    | 0.876                                 | 17.06                         | 4                                  | 209.50                          | 88.22   | 148.53                         | 87.02                             |
| 66                   | 0.846                                    | 0.876                                 | 17.11                         | 4                                  | 212.00                          | 88.37   | 149.02                         | 86.91                             |
| 69                   | 0.846                                    | 0.877                                 | 17.05                         | 3                                  | 213.00                          | 88.30   | 148.43                         | 86.94                             |
| 65                   | 0.846                                    | 0.876                                 | 17.13                         | 5                                  | 213.80                          | 88.37   | 147.70                         | 86.03                             |
| 64                   | 0.846                                    | 0.875                                 | 17.13                         | 5                                  | 215.80                          | 88.30   | 146.46                         | 85.38                             |
| 63                   | 0.808                                    | 0.810                                 | 17.33                         | 4                                  | 143.50                          | 82.24   | 114.78                         | 71.01                             |
| 62                   | 0.808                                    | 0.834                                 | 17.25                         | 3                                  | 177.00                          | 84.44   | 135.14                         | 81.81                             |
| 61                   | 0.808                                    | 0.843                                 | 17.24                         | 5                                  | 194.80                          | 85.35   | 142.83                         | 85.59                             |
| 60                   | 0.808                                    | 0.847                                 | 17.21                         | 3                                  | 201.00                          | 85.73   | 144.94                         | 86.62                             |
| 59                   | 0.808                                    | 0.848                                 | 17.19                         | 3                                  | 206.00                          | 85.73   | 146.05                         | 87.39                             |
| 58                   | 0.808                                    | 0.847                                 | 17.19                         | 4                                  | 208.25                          | 85.65   | 145.12                         | 86.91                             |
| 57                   | 0.808                                    | 0.845                                 | 17.19                         | 3                                  | 210.00                          | 85.41   | 143.80                         | 86.36                             |
| 56                   | 0.808                                    | 0.840                                 | 17.22                         | 3                                  | 216.67                          | 85.05   | 141.80                         | 85.37                             |
| 55                   | 0.808                                    | 0.825                                 | 17.25                         | 4                                  | 224.75                          | 83.53   | 136.19                         | 83.34                             |
| 54                   | 0.808                                    | 0.807                                 | 17.29                         | 4                                  | 236.50                          | 81.80   | 128.98                         | 80.41                             |

TABLE 3.—(Continued)

| Number of experiment | Proportional part of                     |                                       | Head acting on wheel, in feet | Duration of experiment, in minutes | Revolutions of wheel, per minute | Quantity of water discharged by wheel, in cubic feet per second | Horse-power developed by wheel | Percentage of efficiency of wheel |
|----------------------|--|---------------------------------------|-------------------------------|------------------------------------|----------------------------------|---|--------------------------------|-----------------------------------|
|                      | Percentage of full opening of speed-gate | Percentage of full discharge of wheel |                               |                                    |                                  |   |                                |                                   |
| 53                   | 0.808                                    | 0.695                                 | 17.51                         | 4                                  | 264.25                           | 70.97   | 80.06                          | 56.81                             |
| 40                   | 0.769                                    | 0.755                                 | 17.29                         | 4                                  | 118.50                           | 76.53   | 93.35                          | 62.21                             |
| 39                   | 0.769                                    | 0.776                                 | 17.21                         | 4                                  | 146.50                           | 78.47   | 110.97                         | 72.46                             |
| 35                   | 0.769                                    | 0.800                                 | 17.03                         | 4                                  | 174.75                           | 80.49   | 127.07                         | 81.74                             |
| 36                   | 0.769                                    | 0.806                                 | 17.03                         | 4                                  | 190.75                           | 81.13   | 135.24                         | 86.31                             |
| 37                   | 0.769                                    | 0.805                                 | 17.10                         | 4                                  | 197.25                           | 81.21   | 137.46                         | 87.28                             |
| 38                   | 0.769                                    | 0.805                                 | 17.15                         | 4                                  | 200.50                           | 81.28   | 137.29                         | 86.84                             |
| 34                   | 0.769                                    | 0.803                                 | 16.83                         | 4                                  | 199.50                           | 80.34   | 132.98                         | 86.72                             |
| 33                   | 0.769                                    | 0.788                                 | 16.93                         | 4                                  | 211.75                           | 79.04   | 128.32                         | 84.55                             |
| 32                   | 0.769                                    | 0.745                                 | 16.93                         | 4                                  | 232.50                           | 74.72   | 112.71                         | 78.56                             |
| 31                   | 0.769                                    | 0.660                                 | 17.36                         | 4                                  | 257.50                           | 67.02   | 78.02                          | 59.13                             |
| 30                   | 0.769                                    | 0.579                                 | 17.60                         | 3                                  | 306.00                           | 59.27   | 0.00                           | 0.00                              |
| 29                   | 0.615                                    | 0.610                                 | 17.69                         | 3                                  | 100.67                           | 62.60   | 69.54                          | 55.37                             |
| 28                   | 0.615                                    | 0.621                                 | 17.64                         | 3                                  | 127.67                           | 63.60   | 85.10                          | 66.89                             |
| 25                   | 0.615                                    | 0.613                                 | 17.60                         | 3                                  | 167.33                           | 65.76   | 104.44                         | 79.57                             |
| 27                   | 0.615                                    | 0.644                                 | 17.57                         | 4                                  | 175.50                           | 65.83   | 107.41                         | 81.89                             |
| 24                   | 0.615                                    | 0.643                                 | 17.61                         | 4                                  | 178.00                           | 65.76   | 107.86                         | 82.13                             |
| 26                   | 0.615                                    | 0.641                                 | 17.59                         | 3                                  | 179.67                           | 65.55   | 106.70                         | 81.60                             |
| 23                   | 0.615                                    | 0.482                                 | 17.96                         | 3                                  | 296.67                           | 49.84   | 0.00                           | 0.00                              |
| 20                   | 0.615                                    | 0.634                                 | 17.88                         | 4                                  | 155.00                           | 65.37   | 101.44                         | 76.53                             |
| 21                   | 0.615                                    | 0.634                                 | 17.80                         | 5                                  | 151.40                           | 65.22   | 98.17                          | 74.56                             |
| 22                   | 0.615                                    | 0.639                                 | 17.69                         | 3                                  | 160.33                           | 65.50   | 102.98                         | 78.37                             |
| 19                   | 0.615                                    | 0.644                                 | 18.08                         | 5                                  | 174.20                           | 66.80   | 111.89                         | 81.69                             |
| 18                   | 0.615                                    | 0.643                                 | 18.11                         | 3                                  | 180.00                           | 66.73   | 112.35                         | 81.97                             |
| 17                   | 0.615                                    | 0.638                                 | 18.07                         | 4                                  | 183.50                           | 66.19   | 111.20                         | 81.98                             |
| 16                   | 0.615                                    | 0.636                                 | 18.03                         | 4                                  | 185.00                           | 65.90   | 109.86                         | 81.53                             |
| 15                   | 0.615                                    | 0.630                                 | 17.96                         | 3                                  | 190.00                           | 65.15   | 109.38                         | 82.43                             |
| 14                   | 0.615                                    | 0.609                                 | 17.81                         | 4                                  | 201.00                           | 62.66   | 103.53                         | 81.80                             |
| 13                   | 0.615                                    | 0.574                                 | 17.79                         | 4                                  | 216.75                           | 59.07   | 91.94                          | 77.15                             |
| 12                   | 0.615                                    | 0.553                                 | 17.54                         | 5                                  | 245.20                           | 56.46   | 74.29                          | 66.15                             |
| 11                   | 0.615                                    | 0.483                                 | 17.71                         | 5                                  | 294.60                           | 49.58   | 0.00                           | 0.00                              |
| 8                    | 0.462                                    | 0.475                                 | 17.82                         | 3                                  | 104.33                           | 48.95   | 58.16                          | 58.80                             |
| 7                    | 0.462                                    | 0.483                                 | 17.75                         | 4                                  | 139.75                           | 49.58   | 71.98                          | 72.12                             |
| 6                    | 0.462                                    | 0.482                                 | 17.76                         | 3                                  | 147.00                           | 49.51   | 73.93                          | 74.14                             |
| 5                    | 0.462                                    | 0.481                                 | 17.80                         | 4                                  | 156.75                           | 49.45   | 75.99                          | 76.12                             |
| 9                    | 0.462                                    | 0.477                                 | 17.93                         | 2                                  | 162.00                           | 49.22   | 76.57                          | 76.51                             |
| 10                   | 0.462                                    | 0.472                                 | 17.97                         | 3                                  | 167.00                           | 48.78   | 75.90                          | 76.35                             |
| 4                    | 0.462                                    | 0.464                                 | 17.88                         | 5                                  | 173.60                           | 47.80   | 73.64                          | 75.97                             |
| 3                    | 0.462                                    | 0.436                                 | 18.05                         | 4                                  | 216.50                           | 45.13   | 65.60                          | 71.01                             |
| 2                    | 0.462                                    | 0.415                                 | 18.08                         | 4                                  | 246.25                           | 43.02   | 44.77                          | 50.75                             |
| 1                    | 0.462                                    | 0.381                                 | 18.27                         | 4                                  | 280.50                           | 39.75   | 0.00                           | 0.00                              |

NOTE.—The jacket was loose for Experiments Nos. 1, 11, 23, 30, 41, and 71.

During the above experiments, the weight of the dynamometer, and of that portion of the shaft which was above the lowest coupling was 2,600 lb.

With the flume empty, a strain of 0.5 lb., applied at a distance of 3.2 ft. from the center of the shaft, sufficed to start the wheel.

TABLE 4.—TESTS OF A 31-INCH R. H. WELLMAN-SEEVER-MORGAN  
COMPANY TURBINE WHEEL, No. 1799

Date, March 2 and 3, 1909

Wheel supported by ball-bearing steps. Swing-gate. Conical draft-tube

| Number of experiment | Proportional part of                     |                                       | Head acting on wheel, in feet | Duration of experiment, in minutes | Revolutions of wheel per minute | Quantity of water discharged by wheel, in cubic feet per second | Horse-power developed by wheel | Percentage of efficiency of wheel |
|----------------------|--|---------------------------------------|-------------------------------|------------------------------------|---------------------------------|---|--------------------------------|-----------------------------------|
|                      | Percentage of full opening of speed-gate | Percentage of full discharge of wheel |                               |                                    |                                 |   |                                |                                   |
| 49                   | 1.000                                    | 1.049                                 | 17.15                         | 3                                  | 134.67                          | 79.75   | 115.81                         | 74.66                             |
| 48                   | 1.000                                    | 1.038                                 | 17.15                         | 3                                  | 147.00                          | 78.95   | 119.29                         | 77.68                             |
| 47                   | 1.000                                    | 1.025                                 | 17.19                         | 3                                  | 165.67                          | 78.02   | 123.40                         | 81.13                             |
| 46                   | 1.000                                    | 1.024                                 | 17.18                         | 2                                  | 174.00                          | 77.91   | 124.34                         | 81.91                             |
| 45                   | 1.000                                    | 1.018                                 | 17.19                         | 3                                  | 178.33                          | 77.52   | 124.19                         | 82.18                             |
| 44                   | 1.000                                    | 1.013                                 | 17.19                         | 3                                  | 183.33                          | 77.16   | 124.35                         | 82.66                             |
| 43                   | 1.000                                    | 0.012                                 | 17.19                         | 4                                  | 186.25                          | 77.09   | 124.07                         | 82.56                             |
| 42                   | 1.000                                    | 1.009                                 | 17.18                         | 4                                  | 189.50                          | 76.82   | 123.94                         | 82.81                             |
| 41                   | 1.000                                    | 1.007                                 | 17.19                         | 3                                  | 193.00                          | 76.67   | 123.89                         | 82.89                             |
| 40                   | 1.000                                    | 1.006                                 | 17.12                         | 4                                  | 195.50                          | 76.44   | 123.13                         | 82.96                             |
| 39                   | 1.000                                    | 1.002                                 | 17.09                         | 4                                  | 200.25                          | 76.10   | 122.48                         | 83.04                             |
| 38                   | 1.000                                    | 0.999                                 | 17.10                         | 4                                  | 206.25                          | 75.87   | 122.41                         | 83.19                             |
| 37                   | 1.000                                    | 0.997                                 | 17.07                         | 3                                  | 210.33                          | 75.66   | 121.01                         | 82.62                             |
| 36                   | 1.000                                    | 0.993                                 | 17.09                         | 4                                  | 219.00                          | 75.38   | 119.36                         | 81.70                             |
| 35                   | 1.000                                    | 0.906                                 | 17.24                         | 4                                  | 258.75                          | 69.11   | 78.35                          | 57.98                             |
| 34                   | 1.000                                    | 0.744                                 | 17.45                         | 4                                  | 302.25                          | 57.07   | 0.00                           | 0.00                              |
| 32                   | 0.883                                    | 0.909                                 | 17.18                         | 3                                  | 129.33                          | 69.23   | 101.03                         | 74.90                             |
| 31                   | 0.883                                    | 0.904                                 | 17.20                         | 4                                  | 154.25                          | 68.82   | 111.16                         | 82.81                             |
| 33                   | 0.883                                    | 0.901                                 | 17.19                         | 4                                  | 165.00                          | 68.60   | 113.91                         | 85.18                             |
| 30                   | 0.883                                    | 0.896                                 | 17.20                         | 3                                  | 172.33                          | 68.25   | 114.80                         | 86.23                             |
| 29                   | 0.883                                    | 0.892                                 | 17.21                         | 4                                  | 181.50                          | 67.97   | 116.51                         | 87.82                             |
| 27                   | 0.883                                    | 0.888                                 | 17.25                         | 3                                  | 188.00                          | 67.77   | 117.27                         | 88.45                             |
| 26                   | 0.883                                    | 0.886                                 | 17.30                         | 4                                  | 194.00                          | 67.71   | 117.49                         | 88.44                             |
| 28                   | 0.883                                    | 0.885                                 | 17.23                         | 4                                  | 197.25                          | 67.43   | 117.06                         | 88.85                             |
| 25                   | 0.883                                    | 0.883                                 | 17.31                         | 4                                  | 201.75                          | 67.49   | 116.07                         | 87.61                             |
| 24                   | 0.883                                    | 0.857                                 | 17.28                         | 4                                  | 213.25                          | 65.42   | 109.77                         | 85.62                             |
| 23                   | 0.883                                    | 0.818                                 | 17.31                         | 4                                  | 227.00                          | 62.53   | 96.23                          | 78.39                             |
| 22                   | 0.883                                    | 0.761                                 | 17.42                         | 4                                  | 244.25                          | 58.32   | 73.96                          | 64.19                             |
| 21                   | 0.883                                    | 0.620                                 | 17.65                         | 4                                  | 291.75                          | 47.83   | 0.00                           | 0.00                              |
| 69                   | 0.750                                    | 0.835                                 | 17.28                         | 4                                  | 124.75                          | 63.73   | 91.41                          | 73.19                             |
| 68                   | 0.750                                    | 0.839                                 | 17.23                         | 4                                  | 148.75                          | 63.93   | 103.59                         | 82.93                             |
| 67                   | 0.750                                    | 0.834                                 | 17.23                         | 4                                  | 168.75                          | 63.60   | 109.35                         | 87.99                             |
| 64                   | 0.750                                    | 0.830                                 | 17.24                         | 4                                  | 179.25                          | 63.26   | 110.72                         | 89.52                             |
| 65                   | 0.750                                    | 0.829                                 | 17.23                         | 4                                  | 182.00                          | 63.20   | 110.77                         | 89.69                             |
| 63                   | 0.750                                    | 0.828                                 | 17.25                         | 4                                  | 186.25                          | 63.12   | 111.66                         | 90.43                             |
| 66                   | 0.750                                    | 0.824                                 | 17.23                         | 3                                  | 188.67                          | 62.85   | 110.83                         | 90.24                             |
| 62                   | 0.750                                    | 0.821                                 | 17.29                         | 4                                  | 191.75                          | 62.72   | 110.32                         | 89.70                             |
| 61                   | 0.750                                    | 0.809                                 | 17.30                         | 4                                  | 197.50                          | 61.81   | 107.64                         | 88.76                             |
| 60                   | 0.750                                    | 0.796                                 | 17.34                         | 4                                  | 203.25                          | 60.86   | 104.62                         | 87.42                             |
| 59                   | 0.750                                    | 0.768                                 | 17.38                         | 4                                  | 212.50                          | 58.80   | 96.52                          | 83.28                             |
| 58                   | 0.750                                    | 0.693                                 | 17.55                         | 4                                  | 237.00                          | 53.31   | 71.76                          | 67.64                             |
| 57                   | 0.750                                    | 0.573                                 | 17.75                         | 4                                  | 287.00                          | 44.32   | 0.00                           | 0.00                              |

TABLE 4.—(Continued)

| Number of experiment | Proportional part of                     |                                       | Head acting on wheel, in feet | Duration of experiment, in minutes | Revolutions of wheel per minute | Quantity of water discharged by wheel, in cubic feet per second | Horse-power developed by wheel | Percentage of efficiency of wheel |
|----------------------|--|---------------------------------------|-------------------------------|------------------------------------|---------------------------------|---|--------------------------------|-----------------------------------|
|                      | Percentage of full opening of speed-gate | Percentage of full discharge of wheel |                               |                                    |                                 |   |                                |                                   |
| 20                   | 0.667                                    | 0.726                                 | 17.27                         | 4                                  | 106.25                          | 55.43   | 70.78                          | 65.20                             |
| 19                   | 0.667                                    | 0.737                                 | 17.26                         | 3                                  | 148.67                          | 56.25   | 90.93                          | 82.59                             |
| 18                   | 0.667                                    | 0.739                                 | 17.25                         | 4                                  | 161.00                          | 56.39   | 95.55                          | 86.62                             |
| 17                   | 0.667                                    | 0.738                                 | 17.24                         | 4                                  | 168.50                          | 56.31   | 96.94                          | 88.05                             |
| 16                   | 0.667                                    | 0.733                                 | 17.27                         | 3                                  | 173.67                          | 55.92   | 96.76                          | 88.35                             |
| 15                   | 0.667                                    | 0.722                                 | 17.30                         | 4                                  | 179.25                          | 55.17   | 95.52                          | 88.25                             |
| 14                   | 0.667                                    | 0.699                                 | 17.34                         | 4                                  | 189.50                          | 53.48   | 91.81                          | 87.30                             |
| 13                   | 0.667                                    | 0.671                                 | 17.39                         | 4                                  | 201.75                          | 51.37   | 85.52                          | 84.42                             |
| 11                   | 0.667                                    | 0.508                                 | 17.63                         | 4                                  | 280.75                          | 39.17   | 0.00                           | 0.00                              |
| 8                    | 0.500                                    | 0.554                                 | 17.82                         | 3                                  | 117.00                          | 42.95   | 60.23                          | 69.39                             |
| 7                    | 0.500                                    | 0.546                                 | 17.91                         | 3                                  | 135.00                          | 42.46   | 65.40                          | 75.84                             |
| 10                   | 0.500                                    | 0.548                                 | 17.67                         | 3                                  | 151.00                          | 42.28   | 68.58                          | 80.95                             |
| 6                    | 0.500                                    | 0.548                                 | 18.05                         | 4                                  | 157.50                          | 42.72   | 71.54                          | 81.80                             |
| 9                    | 0.500                                    | 0.547                                 | 17.71                         | 4                                  | 157.00                          | 42.28   | 69.41                          | 81.73                             |
| 5                    | 0.500                                    | 0.539                                 | 18.12                         | 5                                  | 167.60                          | 42.11   | 71.05                          | 82.10                             |
| 4                    | 0.500                                    | 0.512                                 | 18.13                         | 4                                  | 187.00                          | 40.02   | 67.95                          | 82.58                             |
| 3                    | 0.500                                    | 0.488                                 | 18.18                         | 4                                  | 213.00                          | 38.21   | 58.05                          | 73.68                             |
| 2                    | 0.500                                    | 0.460                                 | 18.07                         | 4                                  | 232.00                          | 35.92   | 42.15                          | 57.26                             |
| 1                    | 0.500                                    | 0.402                                 | 18.20                         | 3                                  | 275.00                          | 31.50   | 0.00                           | 0.00                              |
| 52                   | 0.333                                    | 0.362                                 | 18.18                         | 3                                  | 96.00                           | 28.35   | 34.88                          | 59.68                             |
| 55                   | 0.333                                    | 0.361                                 | 18.01                         | 3                                  | 177.33                          | 28.10   | 39.08                          | 68.09                             |
| 51                   | 0.333                                    | 0.348                                 | 18.19                         | 4                                  | 133.00                          | 27.25   | 40.27                          | 71.64                             |
| 54                   | 0.333                                    | 0.347                                 | 18.21                         | 3                                  | 139.67                          | 27.20   | 40.60                          | 72.28                             |
| 53                   | 0.333                                    | 0.340                                 | 18.22                         | 3                                  | 143.67                          | 26.62   | 39.15                          | 71.18                             |
| 56                   | 0.333                                    | 0.333                                 | 18.06                         | 4                                  | 148.00                          | 26.00   | 37.64                          | 70.69                             |
| 50                   | 0.333                                    | 0.316                                 | 18.26                         | 3                                  | 201.67                          | 24.82   | 36.64                          | 71.28                             |

NOTE.—For Experiments Nos. 1, 11, 21, and 57, the jacket was loose.

During the above experiments, the weight of the dynamometer and of that portion of the shaft which was above the lowest coupling was 2,600 lb.

With the flume empty, a strain of 1.0 lb., applied at a distance of 3.2 ft. from the center of the shaft, sufficed to start the wheel.

## HYDRAULIC TURBINES

TABLE 5.—TESTS OF A 31-INCH R. H. WELLMAN-SHAVER-MORGAN COMPANY TURBINE WHEEL, No. 1800

Date, March 4 and 5, 1909

Wheel supported on ball-bearing step. Swing-gate. Conical draft-tube

| Number of experiment | Proportional part of                     |                                       | Head acting on wheel, in feet | Duration of experiment, in minutes | Revolutions of wheel per minute | Quantity of water discharged by wheel, in cubic feet per second | Horse-power developed by wheel | Percentage of efficiency of wheel |
|----------------------|--|---------------------------------------|-------------------------------|------------------------------------|---------------------------------|---|--------------------------------|-----------------------------------|
|                      | Percentage of full opening of speed-gate | Percentage of full discharge of wheel |                               |                                    |                                 |   |                                |                                   |
| 65                   | 1.000                                    | 1.052                                 | 17.38                         | 3                                  | 112.33                          | 64.87   | 82.99                          | 64.91                             |
| 64                   | 1.000                                    | 1.040                                 | 17.41                         | 3                                  | 133.33                          | 64.20   | 91.24                          | 71.98                             |
| 63                   | 1.000                                    | 1.025                                 | 17.43                         | 4                                  | 154.25                          | 63.33   | 96.21                          | 76.85                             |
| 62                   | 1.000                                    | 1.014                                 | 17.42                         | 3                                  | 168.67                          | 62.60   | 98.64                          | 79.76                             |
| 61                   | 1.000                                    | 1.009                                 | 17.40                         | 3                                  | 183.33                          | 62.25   | 99.92                          | 81.34                             |
| 60                   | 1.000                                    | 1.006                                 | 17.42                         | 4                                  | 193.25                          | 62.13   | 100.65                         | 82.00                             |
| 59                   | 1.000                                    | 1.004                                 | 17.43                         | 4                                  | 201.00                          | 62.01   | 101.03                         | 82.42                             |
| 58                   | 1.000                                    | 1.002                                 | 17.44                         | 4                                  | 207.00                          | 61.88   | 101.54                         | 82.96                             |
| 56                   | 1.000                                    | 1.000                                 | 17.35                         | 4                                  | 211.00                          | 61.65   | 100.95                         | 83.22                             |
| 57                   | 1.000                                    | 0.999                                 | 17.39                         | 4                                  | 216.75                          | 61.65   | 101.07                         | 83.13                             |
| 55                   | 1.000                                    | 0.998                                 | 17.36                         | 4                                  | 221.50                          | 61.53   | 100.60                         | 83.05                             |
| 54                   | 1.000                                    | 0.995                                 | 17.38                         | 4                                  | 247.50                          | 61.40   | 97.42                          | 80.50                             |
| 53                   | 1.000                                    | 0.951                                 | 17.45                         | 4                                  | 266.75                          | 58.80   | 80.77                          | 69.41                             |
| 52                   | 1.000                                    | 0.730                                 | 17.71                         | 4                                  | 321.25                          | 45.44   | 0.00                           | 0.00                              |
| 51                   | 0.883                                    | 0.889                                 | 17.48                         | 4                                  | 132.25                          | 55.02   | 79.29                          | 72.69                             |
| 50                   | 0.883                                    | 0.888                                 | 17.48                         | 4                                  | 147.00                          | 54.91   | 83.68                          | 76.88                             |
| 49                   | 0.883                                    | 0.885                                 | 17.47                         | 4                                  | 165.00                          | 54.71   | 88.93                          | 82.04                             |
| 48                   | 0.883                                    | 0.879                                 | 17.39                         | 4                                  | 179.25                          | 54.24   | 91.18                          | 85.24                             |
| 47                   | 0.883                                    | 0.876                                 | 17.42                         | 5                                  | 189.20                          | 54.11   | 91.66                          | 85.75                             |
| 44                   | 0.883                                    | 0.873                                 | 17.54                         | 4                                  | 197.50                          | 54.11   | 93.29                          | 86.67                             |
| 43                   | 0.883                                    | 0.873                                 | 17.40                         | 4                                  | 204.25                          | 53.85   | 92.77                          | 87.30                             |
| 45                   | 0.883                                    | 0.872                                 | 17.40                         | 3                                  | 209.00                          | 53.79   | 92.40                          | 87.05                             |
| 46                   | 0.883                                    | 0.871                                 | 17.42                         | 4                                  | 215.50                          | 53.79   | 92.66                          | 87.19                             |
| 42                   | 0.883                                    | 0.858                                 | 17.40                         | 3                                  | 225.00                          | 52.92   | 88.57                          | 84.81                             |
| 41                   | 0.883                                    | 0.810                                 | 17.45                         | 3                                  | 248.00                          | 50.06   | 75.09                          | 75.80                             |
| 40                   | 0.883                                    | 0.609                                 | 17.68                         | 3                                  | 314.00                          | 37.87   | 0.00                           | 0.00                              |
| 75                   | 0.733                                    | 0.801                                 | 17.76                         | 4                                  | 158.50                          | 49.93   | 81.59                          | 81.13                             |
| 73                   | 0.733                                    | 0.798                                 | 17.73                         | 3                                  | 183.33                          | 49.70   | 86.60                          | 86.66                             |
| 72                   | 0.733                                    | 0.797                                 | 17.71                         | 3                                  | 190.33                          | 49.63   | 87.60                          | 87.88                             |
| 71                   | 0.733                                    | 0.796                                 | 17.72                         | 3                                  | 197.00                          | 49.57   | 88.28                          | 88.62                             |
| 74                   | 0.733                                    | 0.795                                 | 17.73                         | 3                                  | 199.00                          | 49.50   | 87.97                          | 88.39                             |
| 70                   | 0.733                                    | 0.793                                 | 17.72                         | 3                                  | 201.67                          | 49.37   | 87.93                          | 88.63                             |
| 69                   | 0.733                                    | 0.788                                 | 17.70                         | 4                                  | 204.50                          | 49.02   | 86.69                          | 88.10                             |
| 68                   | 0.733                                    | 0.775                                 | 17.71                         | 4                                  | 213.50                          | 48.27   | 84.04                          | 86.69                             |
| 67                   | 0.733                                    | 0.722                                 | 17.79                         | 3                                  | 234.00                          | 45.04   | 70.85                          | 77.97                             |
| 66                   | 0.733                                    | 0.544                                 | 18.03                         | 3                                  | 308.67                          | 34.15   | 0.00                           | 0.00                              |
| 38                   | 0.667                                    | 0.751                                 | 17.58                         | 3                                  | 171.00                          | 46.58   | 78.70                          | 84.75                             |
| 37                   | 0.667                                    | 0.750                                 | 17.57                         | 4                                  | 184.00                          | 46.52   | 81.34                          | 87.75                             |
| 39                   | 0.667                                    | 0.749                                 | 17.56                         | 4                                  | 187.00                          | 46.45   | 81.54                          | 88.14                             |
| 35                   | 0.667                                    | 0.749                                 | 17.59                         | 4                                  | 185.50                          | 46.45   | 80.88                          | 87.29                             |
| 36                   | 0.667                                    | 0.747                                 | 17.59                         | 4                                  | 188.75                          | 46.38   | 81.73                          | 88.33                             |

TABLE 5.—(Continued)

| Number of experiment | Proportional part of                     |                                       | Head acting on wheel, in feet | Duration of experiment, in minutes | Revolutions of wheel per minute | Quantity of water discharged by wheel, in cubic feet per second | Horse-power developed by wheel | Percentage of efficiency of wheel |
|----------------------|--|---------------------------------------|-------------------------------|------------------------------------|---------------------------------|---|--------------------------------|-----------------------------------|
|                      | Percentage of full opening of speed-gate | Percentage of full discharge of wheel |                               |                                    |                                 |   |                                |                                   |
| 34                   | 0.667                                    | 0.742                                 | 17.58                         | 4                                  | 192.50                          | 46.02   | 80.44                          | 87.67                             |
| 33                   | 0.667                                    | 0.731                                 | 17.59                         | 4                                  | 198.25                          | 45.37   | 78.04                          | 86.22                             |
| 32                   | 0.667                                    | 0.753                                 | 17.70                         | 3                                  | 127.67                          | 46.87   | 68.04                          | 72.32                             |
| 31                   | 0.667                                    | 0.752                                 | 17.68                         | 3                                  | 144.67                          | 46.76   | 72.72                          | 77.56                             |
| 29                   | 0.667                                    | 0.752                                 | 17.66                         | 4                                  | 164.25                          | 46.76   | 77.59                          | 82.85                             |
| 30                   | 0.667                                    | 0.753                                 | 17.68                         | 3                                  | 178.67                          | 46.82   | 81.15                          | 86.44                             |
| 28                   | 0.667                                    | 0.750                                 | 17.62                         | 3                                  | 189.00                          | 46.57   | 82.41                          | 88.56                             |
| 27                   | 0.667                                    | 0.741                                 | 17.62                         | 3                                  | 193.67                          | 46.02   | 80.93                          | 88.00                             |
| 26                   | 0.667                                    | 0.731                                 | 17.64                         | 3                                  | 201.00                          | 45.44   | 79.12                          | 87.04                             |
| 25                   | 0.667                                    | 0.725                                 | 17.63                         | 3                                  | 204.00                          | 45.05   | 77.83                          | 86.41                             |
| 24                   | 0.667                                    | 0.709                                 | 17.64                         | 3                                  | 213.33                          | 44.05   | 74.93                          | 85.03                             |
| 23                   | 0.667                                    | 0.678                                 | 17.70                         | 4                                  | 224.50                          | 42.23   | 67.98                          | 80.19                             |
| 22                   | 0.667                                    | 0.506                                 | 17.85                         | 3                                  | 303.33                          | 31.61   | 0.00                           | 0.00                              |
| 21                   | 0.500                                    | 0.566                                 | 17.72                         | 2                                  | 124.00                          | 35.27   | 50.31                          | 70.98                             |
| 20                   | 0.500                                    | 0.560                                 | 17.74                         | 3                                  | 136.33                          | 34.87   | 52.84                          | 75.32                             |
| 19                   | 0.500                                    | 0.554                                 | 17.71                         | 4                                  | 146.50                          | 34.50   | 53.23                          | 76.82                             |
| 18                   | 0.500                                    | 0.543                                 | 17.72                         | 4                                  | 155.75                          | 33.82   | 52.82                          | 77.72                             |
| 17                   | 0.500                                    | 0.535                                 | 17.74                         | 3                                  | 166.00                          | 33.31   | 52.27                          | 78.00                             |
| 16                   | 0.500                                    | 0.521                                 | 17.77                         | 3                                  | 176.67                          | 32.47   | 51.36                          | 78.48                             |
| 15                   | 0.500                                    | 0.507                                 | 17.79                         | 3                                  | 189.00                          | 31.61   | 50.36                          | 78.97                             |
| 14                   | 0.500                                    | 0.494                                 | 17.83                         | 4                                  | 200.25                          | 30.87   | 48.51                          | 77.71                             |
| 13                   | 0.500                                    | 0.481                                 | 17.86                         | 3                                  | 214.00                          | 30.08   | 45.36                          | 74.45                             |
| 12                   | 0.500                                    | 0.464                                 | 17.89                         | 4                                  | 228.75                          | 29.02   | 41.56                          | 70.58                             |
| 11                   | 0.500                                    | 0.380                                 | 18.00                         | 4                                  | 299.50                          | 23.87   | 0.00                           | 0.00                              |
| 8                    | 0.333                                    | 0.360                                 | 18.09                         | 4                                  | 112.00                          | 22.65   | 30.52                          | 65.68                             |
| 7                    | 0.333                                    | 0.351                                 | 18.12                         | 3                                  | 127.00                          | 22.10   | 31.53                          | 69.43                             |
| 6                    | 0.333                                    | 0.350                                 | 18.13                         | 3                                  | 136.00                          | 22.02   | 32.12                          | 70.95                             |
| 5                    | 0.333                                    | 0.346                                 | 18.22                         | 4                                  | 141.50                          | 21.84   | 31.71                          | 70.26                             |
| 4                    | 0.333                                    | 0.340                                 | 18.24                         | 4                                  | 148.00                          | 21.47   | 31.37                          | 70.63                             |
| 3                    | 0.333                                    | 0.332                                 | 18.31                         | 4                                  | 154.75                          | 21.03   | 30.93                          | 70.82                             |
| 2                    | 0.333                                    | 0.323                                 | 18.25                         | 4                                  | 165.25                          | 20.42   | 30.02                          | 71.04                             |
| 10                   | 0.333                                    | 0.307                                 | 18.17                         | 4                                  | 212.50                          | 19.33   | 28.31                          | 71.08                             |
| 9                    | 0.333                                    | 0.300                                 | 18.15                         | 3                                  | 231.33                          | 18.93   | 25.22                          | 64.72                             |
| 1                    | 0.333                                    | 0.248                                 | 18.35                         | 4                                  | 287.25                          | 15.74   | 0.00                           | 0.00                              |

NOTE.—The jacket was loose for Experiments Nos. 1, 11, 22, 40, 52, and 66.

During the above experiments, the weight of the dynamometer and of that portion of the shaft which was above the lowest coupling was 2,600 lb.

With the flume empty, a strain of 0.5 lb., applied at a distance of 3.2 ft. from the center of the shaft, sufficed to start the wheel.



## HYDRAULIC TURBINES

TABLE 6.—TEST OF A 27-INCH I. P. MORRIS CO. REACTION TURBINE  
AT CORNELL UNIVERSITY<sup>1</sup>

By R. L. Daugherty, Feb., 1914

| Proportional part of gate opening | Head, ft. | Discharge, cu. ft. per sec. | R.p.m. | Torque, ft. lb. | B.h.p. | Efficiency, per cent. |
|-----------------------------------|-----------|-----------------------------|--------|-----------------|--------|-----------------------|
| 0.067                             | 146.1     | 7.4                         | 600    | 143             | 16.4   | 13.3                  |
| 0.067                             | 146.2     | 6.9                         | 647    | 0               | 0      | 00.0                  |
| 0.248                             | 144.9     | 18.7                        | 0      | 2760            | 0      | 00.0                  |
| 0.248                             | 145.4     | 16.4                        | 600    | 1365            | 156    | 57.6                  |
| 0.248                             | 145.7     | 12.5                        | 845    | 0               | 0      | 00.0                  |
| 0.476                             | 143.9     | 27.5                        | 0      | 5390            | 0      | 00.0                  |
| 0.476                             | 144.3     | 25.4                        | 600    | 2760            | 318    | 76.3                  |
| 0.476                             | 145.2     | 18.8                        | 975    | 0               | 0      | 00.0                  |
| 0.600                             | 142.8     | 34.8                        | 0      | 6550            | 0      | 00.0                  |
| 0.600                             | 143.1     | 31.8                        | 600    | 3820            | 437    | 84.5                  |
| 0.600                             | 144.7     | 23.0                        | 1022   | 0               | 0      | 00.0                  |
| 0.772                             | 141.8     | 40.2                        | 0      | 7520            | 0      | 00.0                  |
| 0.772                             | 141.8     | 38.8                        | 600    | 4820            | 550    | 88.0                  |
| 0.772                             | 144.0     | 26.8                        | 1038   | 0               | 0      | 00.0                  |
| 1.000                             | 140.6     | 46.3                        | 0      | 8130            | 0      | 00.0                  |
| 1.000                             | 140.5     | 44.5                        | 600    | 5400            | 617    | 87.0                  |
| 1.000                             | 143.4     | 32.4                        | 1060   | 0               | 0      | 00.0                  |

<sup>1</sup>For an account of this test see "Investigation of the Performance of a Reaction Turbine," Trans. A. S. C. E., Vol. LXXVIII, p. 1270 (1915).

TABLE 7.—TEST OF A 12-INCH PELTON-DOBLE TANGENTIAL WATER WHEEL UNDER A CONSTANT PRESSURE HEAD OF 8.93 FT. LENGTH OF BRAKE-ARM = 14-IN.

| Turns of needle | Head, ft. | Discharge, cu. ft. per sec. | R.p.m. | Brake load, lb. | B.h.p.  | Efficiency, per cent. |
|-----------------|-----------|-----------------------------|--------|-----------------|---------|-----------------------|
| 1               | 8.932     | 0.0175                      | 0      | 0.48            | 0.00000 | 00.0                  |
|                 |           |                             | 100    | 0.32            | 0.00712 | 40.0                  |
|                 |           |                             | 150    | 0.24            | 0.00802 | 45.0                  |
|                 |           |                             | 200    | 0.16            | 0.00712 | 40.0                  |
|                 |           |                             | 250    | 0.06            | 0.00334 | 18.8                  |
|                 |           |                             | 280    | 0.00            | 0.00000 | 00.0                  |
| 2               | 8.936     | 0.0300                      | 0      | 0.95            | 0.0000  | 00.0                  |
|                 |           |                             | 100    | 0.71            | 0.0158  | 51.8                  |
|                 |           |                             | 150    | 0.58            | 0.0194  | 63.7                  |
|                 |           |                             | 200    | 0.43            | 0.0191  | 62.8                  |
|                 |           |                             | 250    | 0.27            | 0.0150  | 49.2                  |
|                 |           |                             | 320    | 0.00            | 0.0000  | 00.0                  |
| 3               | 8.943     | 0.0448                      | 0      | 1.50            | 0.0000  | 00.0                  |
|                 |           |                             | 100    | 1.11            | 0.0247  | 54.2                  |
|                 |           |                             | 150    | 0.90            | 0.0301  | 66.0                  |
|                 |           |                             | 200    | 0.67            | 0.0298  | 65.3                  |
|                 |           |                             | 250    | 0.42            | 0.0234  | 51.3                  |
|                 |           |                             | 330    | 0.00            | 0.0000  | 00.0                  |
| 4               | 8.951     | 0.0575                      | 0      | 1.80            | 0.0000  | 00.0                  |
|                 |           |                             | 100    | 1.38            | 0.0347  | 59.3                  |
|                 |           |                             | 150    | 1.16            | 0.0388  | 66.3                  |
|                 |           |                             | 200    | 0.90            | 0.0400  | 68.3                  |
|                 |           |                             | 250    | 0.60            | 0.0334  | 57.0                  |
|                 |           |                             | 340    | 0.00            | 0.0000  | 00.0                  |
| 5               | 8.959     | 0.0670                      | 0      | 2.00            | 0.0000  | 00.0                  |
|                 |           |                             | 100    | 1.56            | 0.0347  | 50.8                  |
|                 |           |                             | 150    | 1.32            | 0.0441  | 64.6                  |
|                 |           |                             | 200    | 1.06            | 0.0472  | 69.2                  |
|                 |           |                             | 250    | 0.82            | 0.0457  | 67.0                  |
|                 |           |                             | 360    | 0.00            | 0.0000  | 00.0                  |
| 6               | 8.966     | 0.0750                      | 0      | 2.14            | 0.0000  | 00.0                  |
|                 |           |                             | 100    | 1.69            | 0.0376  | 49.2                  |
|                 |           |                             | 150    | 1.46            | 0.0488  | 63.8                  |
|                 |           |                             | 200    | 1.19            | 0.0526  | 68.8                  |
|                 |           |                             | 250    | 0.90            | 0.0502  | 65.7                  |
|                 |           |                             | 360    | 0.00            | 0.0000  | 00.0                  |
| 7.85            | 8.978     | 0.0860                      | 0      | 2.60            | 0.0000  | 00.0                  |
|                 |           |                             | 100    | 1.89            | 0.0422  | 48.0                  |
|                 |           |                             | 150    | 1.66            | 0.0555  | 63.2                  |
|                 |           |                             | 200    | 1.34            | 0.0596  | 67.8                  |
|                 |           |                             | 250    | 1.03            | 0.0574  | 65.0                  |
|                 |           |                             | 360    | 0.00            | 0.0000  | 00.0                  |

## HYDRAULIC TURBINES

TABLE 8.—TEST OF A 12-INCH PELTON-DOBLE TANGENTIAL WATER WHEEL UNDER A CONSTANT PRESSURE HEAD OF 62.5 FT.

| Turns of needle | Head, ft. | Discharge, cu. ft. per sec. | R.p.m. | Brake load, lb. | B.h.p. | Efficiency, per cent. |
|-----------------|-----------|-----------------------------|--------|-----------------|--------|-----------------------|
| 1               | 62.52     | 0.041                       | 100    | 3.10            | 0.069  | 22.8                  |
|                 |           |                             | 200    | 2.85            | 0.127  | 42.0                  |
|                 |           |                             | 300    | 2.50            | 0.167  | 55.2                  |
|                 |           |                             | 400    | 2.10            | 0.187  | 61.8                  |
|                 |           |                             | 450    | 1.90            | 0.191  | 63.0                  |
|                 |           |                             | 500    | 1.70            | 0.189  | 62.5                  |
|                 |           |                             | 600    | 1.15            | 0.153  | 50.7                  |
|                 |           |                             | 700    | 0.55            | 0.086  | 28.4                  |
|                 |           |                             | 775    | 0.00            | 0.000  | 00.0                  |
| 2               | 62.55     | 0.081                       | 100    | 6.70            | 0.149  | 25.9                  |
|                 |           |                             | 200    | 6.10            | 0.276  | 48.0                  |
|                 |           |                             | 300    | 5.40            | 0.361  | 62.7                  |
|                 |           |                             | 400    | 4.70            | 0.419  | 72.8                  |
|                 |           |                             | 500    | 3.85            | 0.429  | 74.5                  |
|                 |           |                             | 600    | 3.00            | 0.400  | 69.5                  |
|                 |           |                             | 700    | 1.80            | 0.284  | 49.2                  |
|                 |           |                             | 800    | 0.70            | 0.125  | 21.6                  |
|                 |           |                             | 880    | 0.00            | 0.000  | 00.0                  |
| 3               | 62.58     | 0.117                       | 100    | 9.60            | 0.214  | 25.6                  |
|                 |           |                             | 200    | 8.70            | 0.388  | 46.5                  |
|                 |           |                             | 300    | 7.80            | 0.522  | 62.5                  |
|                 |           |                             | 400    | 6.80            | 0.606  | 72.6                  |
|                 |           |                             | 500    | 5.85            | 0.652  | 78.0                  |
|                 |           |                             | 600    | 4.75            | 0.635  | 76.0                  |
|                 |           |                             | 700    | 3.30            | 0.515  | 61.7                  |
|                 |           |                             | 800    | 1.65            | 0.294  | 35.2                  |
|                 |           |                             | 930    | 0.00            | 0.000  | 00.0                  |
| 4               | 62.63     | 0.150                       | 100    | 12.30           | 0.274  | 25.6                  |
|                 |           |                             | 200    | 11.25           | 0.510  | 47.6                  |
|                 |           |                             | 300    | 10.05           | 0.672  | 62.8                  |
|                 |           |                             | 400    | 8.85            | 0.790  | 73.8                  |
|                 |           |                             | 500    | 7.80            | 0.870  | 81.3                  |
|                 |           |                             | 600    | 6.45            | 0.862  | 80.6                  |
|                 |           |                             | 700    | 4.75            | 0.740  | 69.1                  |
|                 |           |                             | 800    | 2.60            | 0.463  | 42.3                  |
|                 |           |                             | 900    | 0.85            | 0.160  | 15.0                  |
| 950             | 0.00      | 0.000                       | 00.0   |                 |        |                       |

TABLE 8.—(Continued)

| Turns of needle | Head, ft. | Discharge, cu. ft. per sec. | R.p.m. | Brake load, lb. | B.h.p. | Efficiency, per cent. |
|-----------------|-----------|-----------------------------|--------|-----------------|--------|-----------------------|
| 5               | 62.68     | 0.174                       | 100    | 14.10           | 0.314  | 25.3                  |
|                 |           |                             | 200    | 12.90           | 0.575  | 46.4                  |
|                 |           |                             | 300    | 11.50           | 0.768  | 62.0                  |
|                 |           |                             | 400    | 10.20           | 0.908  | 73.3                  |
|                 |           |                             | 500    | 9.05            | 1.010  | 81.5                  |
|                 |           |                             | 600    | 7.30            | 0.975  | 78.                   |
|                 |           |                             | 700    | 5.45            | 0.850  | 68.6                  |
|                 |           |                             | 800    | 3.30            | 0.515  | 41.6                  |
|                 |           |                             | 900    | 1.20            | 0.241  | 19.4                  |
|                 |           |                             | 970    | 0.00            | 0.000  | 00.0                  |
| 6               | 62.74     | 0.200                       | 100    | 15.25           | 0.340  | 23.8                  |
|                 |           |                             | 200    | 14.00           | 0.624  | 43.7                  |
|                 |           |                             | 300    | 12.65           | 0.846  | 59.5                  |
|                 |           |                             | 400    | 11.25           | 1.011  | 71.0                  |
|                 |           |                             | 500    | 9.95            | 1.110  | 78.0                  |
|                 |           |                             | 600    | 8.20            | 1.098  | 77.0                  |
|                 |           |                             | 700    | 6.00            | 0.935  | 65.6                  |
|                 |           |                             | 800    | 3.60            | 0.561  | 39.4                  |
|                 |           |                             | 900    | 1.20            | 0.302  | 21.2                  |
|                 |           |                             | 985    | 0.00            | 0.000  | 00.0                  |
| 7.85            | 62.81     | 0.230                       | 100    | 17.40           | 0.388  | 23.7                  |
|                 |           |                             | 200    | 16.10           | 0.717  | 43.8                  |
|                 |           |                             | 300    | 14.70           | 0.982  | 60.0                  |
|                 |           |                             | 400    | 12.80           | 1.140  | 69.5                  |
|                 |           |                             | 500    | 11.10           | 1.235  | 75.5                  |
|                 |           |                             | 600    | 9.30            | 1.242  | 76.0                  |
|                 |           |                             | 700    | 6.90            | 1.080  | 66.0                  |
|                 |           |                             | 800    | 4.20            | 0.655  | 40.0                  |
|                 |           |                             | 900    | 1.85            | 0.370  | 22.6                  |
|                 |           |                             | 985    | 0.00            | 0.000  | 00.0                  |

TABLE 9.—TEST OF A 12-INCH PELTON-DOBLE TANGENTIAL WATER WHEEL UNDER A CONSTANT PRESSURE HEAD OF 130.5 FT.

| Turns of needle | Head, ft. | Discharge, cu. ft. per sec. | R.p.m. | Brake load, lb. | B.h.p. | Efficiency, per cent. |
|-----------------|-----------|-----------------------------|--------|-----------------|--------|-----------------------|
| 1               | 130.68    | 0.062                       | 100    | 6.8             | 0.152  | 16.4                  |
|                 |           |                             | 300    | 6.2             | 0.414  | 44.8                  |
|                 |           |                             | 500    | 5.2             | 0.579  | 62.8                  |
|                 |           |                             | 700    | 4.0             | 0.624  | 67.6                  |
|                 |           |                             | 900    | 2.2             | 0.440  | 47.7                  |
|                 |           |                             | 1100   | 0.6             | 0.147  | 15.9                  |
|                 |           |                             | 1190   | 0.0             | 0.000  | 00.0                  |
| 2               | 130.74    | 0.118                       | 100    | 14.2            | 0.316  | 18.0                  |
|                 |           |                             | 300    | 12.8            | 0.855  | 48.6                  |
|                 |           |                             | 500    | 10.8            | 1.201  | 68.3                  |
|                 |           |                             | 700    | 8.8             | 1.372  | 78.0                  |
|                 |           |                             | 900    | 6.2             | 1.242  | 70.6                  |
|                 |           |                             | 1100   | 3.2             | 0.784  | 44.5                  |
|                 |           |                             | 1340   | 0.0             | 0.000  | 00.0                  |
| 3               | 130.83    | 0.173                       | 100    | 21.2            | 0.472  | 18.4                  |
|                 |           |                             | 300    | 18.6            | 1.242  | 48.3                  |
|                 |           |                             | 500    | 15.8            | 1.760  | 68.5                  |
|                 |           |                             | 700    | 12.9            | 2.010  | 78.2                  |
|                 |           |                             | 800    | 11.7            | 2.080  | 81.0                  |
|                 |           |                             | 900    | 10.0            | 2.002  | 78.0                  |
|                 |           |                             | 1100   | 5.4             | 1.320  | 51.4                  |
|                 |           |                             | 1300   | 1.6             | 0.398  | 15.5                  |
| 1395            | 0.0       | 0.000                       | 00.0   |                 |        |                       |
| 4               | 130.95    | 0.222                       | 100    | 26.6            | 0.592  | 17.9                  |
|                 |           |                             | 300    | 24.0            | 1.602  | 48.6                  |
|                 |           |                             | 500    | 20.6            | 2.295  | 69.5                  |
|                 |           |                             | 700    | 16.8            | 2.620  | 79.5                  |
|                 |           |                             | 800    | 15.0            | 2.670  | 81.0                  |
|                 |           |                             | 900    | 12.8            | 2.660  | 80.6                  |
|                 |           |                             | 1100   | 7.6             | 1.860  | 56.5                  |
|                 |           |                             | 1300   | 2.6             | 0.752  | 22.8                  |
| 1420            | 0.0       | 0.000                       | 00.0   |                 |        |                       |
| 5               | 131.06    | 0.262                       | 100    | 31.4            | 0.700  | 17.9                  |
|                 |           |                             | 300    | 28.2            | 1.884  | 48.2                  |
|                 |           |                             | 500    | 24.2            | 2.695  | 69.0                  |
|                 |           |                             | 700    | 19.5            | 3.040  | 78.0                  |

TABLE 9.—(Continued)

| Turns of needle | Head, ft. | Discharge, cu. ft. per sec. | R.p.m. | Brake load, lb. | B h.p. | Efficiency, per cent. |
|-----------------|-----------|-----------------------------|--------|-----------------|--------|-----------------------|
| 6               | 131.19    | 0.300                       | 800    | 17.6            | 3.135  | 80.3                  |
|                 |           |                             | 900    | 15.2            | 3.040  | 78.0                  |
|                 |           |                             | 1100   | 8.8             | 2.155  | 55.2                  |
|                 |           |                             | 1300   | 3.4             | 0.984  | 25.2                  |
|                 |           |                             | 1450   | 0.0             | 0.000  | 00.0                  |
|                 |           |                             | 100    | 34.2            | 0.762  | 17.3                  |
|                 |           |                             | 300    | 31.0            | 2.070  | 47.0                  |
|                 |           |                             | 500    | 26.6            | 2.960  | 67.4                  |
|                 |           |                             | 700    | 21.4            | 3.335  | 75.8                  |
|                 |           |                             | 800    | 19.1            | 3.400  | 77.3                  |
| 7.85            | 131.40    | 0.356                       | 900    | 16.5            | 3.300  | 75.0                  |
|                 |           |                             | 1100   | 10.2            | 2.497  | 56.7                  |
|                 |           |                             | 1300   | 4.2             | 1.215  | 27.6                  |
|                 |           |                             | 1460   | 0.0             | 0.000  | 00.0                  |
|                 |           |                             | 100    | 39.2            | 0.874  | 16.4                  |
|                 |           |                             | 300    | 35.0            | 2.340  | 44.0                  |
|                 |           |                             | 500    | 29.8            | 3.315  | 62.2                  |
|                 |           |                             | 700    | 24.6            | 3.830  | 72.0                  |
|                 |           |                             | 800    | 21.8            | 3.880  | 73.0                  |
|                 |           |                             | 900    | 18.7            | 3.740  | 70.3                  |
|                 |           |                             | 1100   | 11.6            | 2.838  | 53.3                  |
|                 |           |                             | 1300   | 4.8             | 1.390  | 26.2                  |
|                 |           |                             | 1460   | 0.0             | 0.000  | 00.0                  |

## HYDRAULIC TURBINES

TABLE 10.—TEST OF A 12-INCH PELTON-DOBLE TANGENTIAL WATER WHEEL UNDER A CONSTANT PRESSURE HEAD OF 230 FT.

| Turns of nozzle | Head, ft. | Discharge, cu. ft. per sec. | R.p.m. | Brake load, lb. | B.h.p. | Efficiency, per cent. |
|-----------------|-----------|-----------------------------|--------|-----------------|--------|-----------------------|
| 1               | 230.2     | 0.081                       | 100    | 11.4            | 0.254  | 12.0                  |
|                 |           |                             | 300    | 10.3            | 0.687  | 32.4                  |
|                 |           |                             | 500    | 9.2             | 1.025  | 48.4                  |
|                 |           |                             | 700    | 7.8             | 1.217  | 57.5                  |
|                 |           |                             | 800    | 7.0             | 1.248  | 59.0                  |
|                 |           |                             | 900    | 6.2             | 1.242  | 58.7                  |
|                 |           |                             | 1100   | 4.3             | 1.054  | 49.7                  |
|                 |           |                             | 1300   | 2.0             | 0.578  | 27.3                  |
|                 |           |                             | 1440   | 0.0             | 0.000  | 00.0                  |
| 2               | 230.3     | 0.163                       | 100    | 24.6            | 0.548  | 12.8                  |
|                 |           |                             | 300    | 22.3            | 1.490  | 34.9                  |
|                 |           |                             | 500    | 19.7            | 2.190  | 51.2                  |
|                 |           |                             | 700    | 17.1            | 2.665  | 62.4                  |
|                 |           |                             | 900    | 14.4            | 2.880  | 67.5                  |
|                 |           |                             | 1100   | 11.4            | 2.795  | 65.4                  |
|                 |           |                             | 1300   | 8.0             | 2.320  | 54.3                  |
|                 |           |                             | 1500   | 4.5             | 1.505  | 35.2                  |
|                 |           |                             | 1700   | 1.0             | 0.378  | 12.5                  |
|                 |           |                             | 0.0    | 0.000           | 00.0   |                       |
| 3               | 230.5     | 0.231                       | 100    | 31.3            | 0.698  | 11.5                  |
|                 |           |                             | 300    | 32.7            | 2.185  | 36.2                  |
|                 |           |                             | 500    | 28.3            | 3.150  | 52.1                  |
|                 |           |                             | 700    | 25.6            | 3.990  | 66.0                  |
|                 |           |                             | 900    | 21.6            | 4.330  | 71.6                  |
|                 |           |                             | 1100   | 17.4            | 4.268  | 70.6                  |
|                 |           |                             | 1300   | 12.4            | 3.588  | 59.4                  |
|                 |           |                             | 1500   | 7.0             | 2.340  | 38.7                  |
|                 |           |                             | 1700   | 2.0             | 0.756  | 12.5                  |
|                 |           |                             | 0.0    | 0.000           | 00.0   |                       |
| 4               | 230.6     | 0.291                       | 100    | 45.2            | 1.005  | 13.2                  |
|                 |           |                             | 300    | 41.6            | 2.780  | 36.4                  |
|                 |           |                             | 500    | 37.4            | 4.160  | 54.5                  |
|                 |           |                             | 700    | 33.0            | 5.145  | 67.4                  |
|                 |           |                             | 900    | 28.2            | 5.650  | 74.0                  |
|                 |           |                             | 1100   | 23.1            | 5.665  | 74.3                  |
|                 |           |                             | 1300   | 17.6            | 5.096  | 66.7                  |
|                 |           |                             | 1500   | 9.5             | 3.180  | 41.7                  |
|                 |           |                             | 1700   | 3.9             | 1.477  | 19.3                  |
|                 |           |                             | 0.0    | 0.000           | 00.0   |                       |

TABLE 10.—(Continued)

| Turns of nozzle | Head, ft. | Discharge, cu. ft. per sec. | R.p.m. | Brake load, lb. | B.h.p. | Efficiency, per cent. |
|-----------------|-----------|-----------------------------|--------|-----------------|--------|-----------------------|
| 5               | 230.8     | 0.343                       | 100    | 54.2            | 1.211  | 13.5                  |
|                 |           |                             | 300    | 49.6            | 3.315  | 36.8                  |
|                 |           |                             | 500    | 44.4            | 4.940  | 54.9                  |
|                 |           |                             | 700    | 38.8            | 6.050  | 67.2                  |
|                 |           |                             | 900    | 32.6            | 6.530  | 72.6                  |
|                 |           |                             | 1100   | 26.6            | 6.512  | 72.4                  |
|                 |           |                             | 1300   | 20.2            | 5.850  | 65.0                  |
|                 |           |                             | 1500   | 12.8            | 4.280  | 47.6                  |
|                 |           |                             | 1700   | 5.4             | 2.040  | 22.7                  |
|                 |           |                             | 1880   | 0.0             | 0.000  | 00.0                  |
| 6               | 231.1     | 0.379                       | 100    | 61.0            | 1.360  | 13.6                  |
|                 |           |                             | 300    | 55.5            | 3.710  | 37.2                  |
|                 |           |                             | 500    | 49.5            | 5.510  | 55.4                  |
|                 |           |                             | 700    | 43.0            | 6.700  | 67.3                  |
|                 |           |                             | 900    | 36.4            | 7.300  | 73.4                  |
|                 |           |                             | 1000   | 33.2            | 7.390  | 74.2                  |
|                 |           |                             | 1100   | 29.7            | 7.270  | 73.0                  |
|                 |           |                             | 1300   | 32.4            | 6.480  | 65.0                  |
|                 |           |                             | 1500   | 14.4            | 4.800  | 48.2                  |
|                 |           |                             | 1700   | 6.4             | 2.420  | 24.3                  |
| 1890            | 0.0       | 0.000                       | 00.0   |                 |        |                       |
| 7.85            | 231.2     | 0.434                       | 100    | 67.2            | 1.499  | 13.3                  |
|                 |           |                             | 300    | 61.8            | 4.130  | 36.8                  |
|                 |           |                             | 500    | 55.4            | 6.160  | 54.9                  |
|                 |           |                             | 700    | 47.8            | 7.450  | 66.3                  |
|                 |           |                             | 900    | 40.0            | 8.015  | 71.4                  |
|                 |           |                             | 1000   | 36.5            | 8.125  | 72.3                  |
|                 |           |                             | 1100   | 32.9            | 8.063  | 71.8                  |
|                 |           |                             | 1300   | 24.8            | 7.180  | 64.0                  |
|                 |           |                             | 1500   | 16.3            | 5.450  | 48.5                  |
|                 |           |                             | 1700   | 7.0             | 2.550  | 22.7                  |
| 1890            | 0.0       | 0.000                       | 00.0   |                 |        |                       |



## HYDRAULIC TURBINES

TABLE 11.—TEST OF A 12-INCH PELTON-DOBLE TANGENTIAL WATER WHEEL UNDER A CONSTANT PRESSURE HEAD OF 305 FT.

| Turns of needle | Head, ft. | Discharge, cu. ft. per sec. | R.p.m. | Brake load, lb. | B.h.p. | Efficiency, per cent. |
|-----------------|-----------|-----------------------------|--------|-----------------|--------|-----------------------|
| 1               | 305.1     | 0.1025                      | 0      | 18.0            | 0.00   | 00.0                  |
|                 |           |                             | 400    | 15.8            | 1.41   | 39.6                  |
|                 |           |                             | 800    | 12.6            | 2.24   | 63.2                  |
|                 |           |                             | 1000   | 10.8            | 2.41   | 67.7                  |
|                 |           |                             | 1200   | 8.4             | 2.24   | 63.2                  |
|                 |           |                             | 1400   | 6.0             | 1.87   | 52.7                  |
|                 |           |                             | 1600   | 3.2             | 1.14   | 32.2                  |
|                 |           |                             | 1800   | 0.4             | 0.16   | 4.5                   |
|                 |           |                             | 1920   | 0.0             | 0.00   | 0.0                   |
|                 |           |                             | 2      | 305.2           | 0.185  | 0                     |
| 400             | 30.8      | 2.74                        |        |                 |        | 42.7                  |
| 800             | 24.6      | 4.38                        |        |                 |        | 68.4                  |
| 1000            | 21.0      | 4.67                        |        |                 |        | 72.7                  |
| 1200            | 17.5      | 4.67                        |        |                 |        | 72.7                  |
| 1400            | 13.4      | 4.18                        |        |                 |        | 65.1                  |
| 1600            | 9.1       | 3.24                        |        |                 |        | 50.5                  |
| 1800            | 4.4       | 1.76                        |        |                 |        | 27.4                  |
| 2020            | 0.0       | 0.00                        |        |                 |        | 00.0                  |
| 3               | 305.5     | 0.278                       |        |                 |        | 0                     |
|                 |           |                             | 400    | 45.2            | 4.02   | 41.5                  |
|                 |           |                             | 800    | 36.6            | 6.52   | 67.4                  |
|                 |           |                             | 1000   | 32.0            | 7.12   | 73.7                  |
|                 |           |                             | 1200   | 26.8            | 7.15   | 74.0                  |
|                 |           |                             | 1400   | 20.7            | 6.45   | 66.8                  |
|                 |           |                             | 1600   | 14.4            | 5.13   | 53.0                  |
|                 |           |                             | 1800   | 7.8             | 3.12   | 32.2                  |
|                 |           |                             | 2080   | 0.0             | 0.00   | 00.0                  |
|                 |           |                             | 4      | 305.7           | 0.341  | 0                     |
| 400             | 53.6      | 4.77                        |        |                 |        | 40.3                  |
| 800             | 43.0      | 7.65                        |        |                 |        | 64.7                  |
| 1000            | 38.4      | 8.55                        |        |                 |        | 72.2                  |
| 1200            | 33.0      | 8.82                        |        |                 |        | 74.5                  |
| 1400            | 26.0      | 8.10                        |        |                 |        | 68.4                  |
| 1600            | 18.6      | 6.62                        |        |                 |        | 55.9                  |
| 1800            | 10.0      | 4.00                        |        |                 |        | 33.9                  |
| 2110            | 00.0      | 0.00                        |        |                 |        | 00.0                  |

TABLE 11.—(Continued)

| Turns of needle | Head, ft. | Discharge, cu. ft. per sec. | R.p.m. | Brake load, lb. | B.h.p. | Efficiency, per cent. |
|-----------------|-----------|-----------------------------|--------|-----------------|--------|-----------------------|
| 5               | 306.0     | 0.390                       | 0      | 72.0            | 0.00   | 00.0                  |
|                 |           |                             | 400    | 62.6            | 5.57   | 40.9                  |
|                 |           |                             | 800    | 52.0            | 9.27   | 68.1                  |
|                 |           |                             | 1000   | 45.8            | 10.20  | 75.0                  |
|                 |           |                             | 1200   | 38.4            | 10.25  | 75.3                  |
|                 |           |                             | 1400   | 30.2            | 9.40   | 69.0                  |
|                 |           |                             | 1600   | 21.0            | 7.48   | 55.0                  |
|                 |           |                             | 1800   | 11.0            | 4.40   | 32.4                  |
|                 |           |                             | 2150   | 00.0            | 0.00   | 00.0                  |

TABLE 12.—FRICTION AND WINDAGE OF 12-INCH PELTON-DOBLE TANGENTIAL WATER WHEEL

| R.p.m. | H.p.   | R.p.m. | H.p.   |
|--------|--------|--------|--------|
| 100    | 0.0025 | 800    | 0.1545 |
| 200    | 0.0089 | 900    | 0.2190 |
| 300    | 0.0146 | 1000   | 0.2660 |
| 400    | 0.0305 | 1100   | 0.3270 |
| 500    | 0.0515 | 1200   | 0.3910 |
| 600    | 0.0746 | 1300   | 0.4980 |
| 700    | 0.1135 | 1400   | 0.5970 |
|        |        | 1500   | 0.7020 |

TABLE 13.—TEST OF A PELTON-DOBLE TANGENTIAL WATER WHEEL NEAR FRESNO, CAL.

Static Head = 1403.45 ft.

| Head, ft. | Discharge, cu. ft. per sec. | H.p. input | B.h.p. | Efficiency, per cent. |
|-----------|-----------------------------|------------|--------|-----------------------|
| 1400.77   | 17.50                       | 2750       | 2075   | 74.4                  |
| 1398.25   | 22.10                       | 3510       | 2767   | 78.7                  |
| 1396.56   | 27.00                       | 4280       | 3450   | 80.7                  |
| 1394.15   | 31.90                       | 5050       | 4120   | 81.7                  |
| 1391.80   | 36.70                       | 5800       | 4765   | 82.2                  |
| 1389.65   | 42.00                       | 6630       | 5480   | 82.7                  |
| 1383.90   | 54.00                       | 8475       | 6825   | 80.6                  |

## HYDRAULIC TURBINES

TABLE 14.—TEST OF A 2½-INCH TWO-STAGE WORTHINGTON TURBINE PUMP  
AT CORNELL UNIVERSITY

By R. L. Daugherty

Diameter of Impellers = 12 inches. Test made at a constant speed of  
1700 r.p.m.

| Discharge, cu. ft.<br>per sec. | Head,<br>ft. | B.h.p. | Efficiency,<br>per cent. |
|--------------------------------|--------------|--------|--------------------------|
| 0.000                          | 248.5        | 9.13   | 00.0                     |
| 0.049                          | 248.6        | 10.12  | 13.7                     |
| 0.112                          | 254.6        | 11.78  | 27.6                     |
| 0.155                          | 257.5        | 12.70  | 35.8                     |
| 0.236                          | 264.1        | 15.08  | 47.1                     |
| 0.348                          | 248.8        | 18.15  | 54.3                     |
| 0.429                          | 225.0        | 20.06  | 55.0                     |
| 0.494                          | 192.2        | 21.60  | 50.0                     |
| 0.531                          | 157.3        | 22.00  | 43.2                     |
| 0.573                          | 73.1         | 21.25  | 22.4                     |
| 0.578                          | 47.1         | 20.60  | 15.0                     |
| 0.580                          | 26.3         | 20.15  | 8.6                      |

TABLE 15.—TEST OF A 6-INCH SINGLE-STAGE DELAVAL CENTRIFUGAL  
PUMP AT CORNELL UNIVERSITY

By R. L. Daugherty

Volute Type. Diameter of Impeller = 9.11 inches. Speed 1700 r.p.m.

| Discharge, cu. ft.<br>per sec. | Head,<br>ft. | B.h.p. | Efficiency,<br>per cent. |
|--------------------------------|--------------|--------|--------------------------|
| 0.000                          | 68.5         | 4.3    | 00.0                     |
| 0.068                          | 68.4         | 4.5    | 11.7                     |
| 0.188                          | 69.6         | 5.2    | 28.6                     |
| 0.320                          | 69.3         | 6.0    | 42.0                     |
| 0.606                          | 69.2         | 7.8    | 61.0                     |
| 0.873                          | 65.8         | 9.3    | 70.2                     |
| 1.063                          | 62.7         | 10.3   | 73.5                     |
| 1.315                          | 55.7         | 11.3   | 73.7                     |
| 1.632                          | 47.3         | 12.0   | 73.2                     |
| 1.968                          | 35.7         | 11.8   | 67.7                     |
| 2.090                          | 28.1         | 11.5   | 58.0                     |
| 2.240                          | 22.3         | 11.2   | 50.7                     |

# INDEX

## A

Absolute velocity, 80  
Action of water, 7  
American turbine, 9  
Annual cost of power, 197  
Arrangement of runners, 11  
Axial flow, 9

## B

Barker's mill, 41  
Bearings, 56  
Brake, 146  
Breast wheel, 1  
Buckets, 31  
    design of, 208  
    pitch of, 205

## C

Capital cost, 195  
Case, 58, 209  
Centrifugal force, 97, 231  
    pump, 230  
Chain type construction, 32  
Characteristic curve, 173  
Classification of turbines, 7  
Clear opening, 216  
Coefficient of nozzle, 114  
Conduit, 6  
Constants, 153  
    determination of, 160  
    uses of, 161  
Cost, steam power, 200  
    turbines, 192  
    water power, 197  
Current meter, 145  
    wheel, 1  
Cylinder gate, 52

## D

Defects of theory, 134, 242  
Deflecting nozzle, 36  
Diameter of runner, 52  
    and discharge, 154  
    and power, 155  
    and speed, 152  
Diffusion vanes, 231  
Direction of flow, 8  
Discharge curve, 15  
    measurements of, 143  
Doble bucket, 30  
Draft tube, 13, 63, 100  
Dynamometer, 146

## E

Eddy loss, 70, 125  
Efficiency, 83  
    as function of speed and gate,  
        164  
    of impulse wheel, 39, 115  
    maximum, 177  
    on part load, 179  
    of reaction turbine, 72  
    relative, 182  
Energy, 80

## F

Falling stream, effect on flow, 15  
Fitz water wheel, 2  
Flow and head, 18  
Flow, direction of, 8  
Flume, 14  
Force exerted, 84, 108  
Forebay, 6  
Fourneyron turbine, 8, 41, 93  
Francis turbine, 3, 41

- Friction, 147  
 variation with speed, 151  
 Full gate, 183  
 Full load, 179
- G
- Gage heights, fluctuations in, 16  
 relation of, to flow, 15  
 Gates, cylinder, 52  
 design of, 228  
 register, 53  
 wicket, 53  
 Girard turbine, 30, 92  
 Governing—see speed regulation.  
 Governors, 74  
 Gradient, 15  
 Guides—see gates.
- H
- Hand of turbine, 9  
 Head, 80  
 delivered to runner, 91  
 and discharge, 152  
 and efficiency, 152  
 measurement of, 143  
 net for pump, 233  
 net for turbine, 81  
 and power, 152  
 and speed, 152  
 variation of, 17  
 -water, 6  
 Holyoke testing flume, 140  
 Howd turbine, 41  
 Hydraucone, 68  
 Hydraulic gradient, 21  
 Hydrograph, 16
- I
- Impending delivery, 237  
 Impulse circle, 204  
 Impulse turbine, 7  
 advantages of, 180, 190  
 problem of, 92  
 Inward flow, 3, 8  
 advantages of, 46
- J
- Jet, use of two or more, 34  
 size of, to size of wheel, 33
- L
- Link, 55  
 Load curve, 19  
 factor, 19  
 factor and cost, 198  
 Losses, centrifugal pump, 234  
 impulse turbine, 93, 113  
 reaction turbine, 94, 125
- M
- Manometric efficiency, 233  
 McCormick runner, 42  
 Mixed flow, 9
- N
- Needle nozzle, 35  
 Nozzle coefficients, 114  
 design, 204
- O
- Operating expenses, 197  
 Outward flow turbine, 8  
 Overgate, 183  
 Overhung wheel, 12  
 Overload, 180  
 Overshot wheel, 2
- P
- Part load, 180  
 Pelton wheel, 30  
 Penstock, 6  
 Pitot tube, 144  
 Pivoted guides, 53  
 Pondage, 19  
 Power, 83  
 delivered to runner, 91  
 effect of head on, 18  
 effect of pondage on, 19  
 effect of storage on, 20  
 measurement of, 146  
 through pipe line, 21  
 of stream, 19

## R

- Race, 6
- Radial flow, 8
- Rainfall and run-off, 16
  - use of records of, 17
- Rating curve, 15
- Reaction turbine, 7
  - advantages of, 179, 185, 189
  - development of, 41
  - problem of, 93
- Register gate, 53
- Regulation, 52
- Relative velocity, 80
- Relief valve, 24, 37, 56
- Retardation runs, 148, 249
- Rheostats, 146
- Runners, types of, 43
  - construction of, 51
  - design of, 211
  - diameter of, 52

## S

- Sale of power, 198
- Scotch turbine, 41
- Selection of turbine, 169, 177
- Shaft, choice of, 10
  - position of, 9
- Shifting rim, 55
- Shock loss, 125, 236
- Shut-off head, 237
- Specific speed, 155, 167, 245
- Speed, effect of, 94
  - ring, 61, 227
- Speed regulation, 35, 52
  - effect of pipe on, 23
- Splitter, 32
- Stand pipe, 24
- Steam power cost, 200
- Step bearing, 56
- Storage, 20

- Stream flow, 16
  - gaging, 15
- Suction tube—see draft tube.
- Surge chamber, 24
- Suspension bearing, 57
- Swain turbine, 42

## T

- Tail race, 6
- Tangential water wheel, 105
- Testing, 140
- Thrust of runnet, 58
- Torque, 89
- Turbines, advantages of, 4
  - classification of, 7
  - definition of, 2
  - types of, 7
- Turbine pump, 230

## U

- Undershot water wheel, 1

## V

- Value of water power, 202
- Vanes, number of, 214
  - layout of, 219
- Velocity in case, 227
  - of pump discharge, 232
- Volute pump, 230
- Vortex, 97

## W

- Water hammer, 24
- Water, measurement of, 15
- Water power, 15
- Water power plant, 5
- Water wheels, 1, 3, 4
- Wear of turbines, 70, 102
- Wicket gate, 53

DATE OF ISSUE

This book must be returned within ~~3/7/14~~ <sup>7/1/14</sup> days of its issue. A fine of ~~ONE PENNA~~ per day will be charged if the book is overdue.

---

|  |  |  |  |  |  |
|--|--|--|--|--|--|
|  |  |  |  |  |  |
|--|--|--|--|--|--|

~~For Reference Use~~

Not to be removed from the Library pre