

Sarla Central Library

PILANI (Jaipur State)

Class No :- 666.1

Book No :- S807C

Accession No :- 32225

Acc. No.....

ISSUE LABEL

Not later than the latest date stamped below.

--	--	--

INTERNATIONAL CHEMICAL SERIES

LOUIS P. HAMMETT, Ph.D., *Consulting Editor*

★ ★
★

CRYSTAL CHEMISTRY

*The quality of the materials used in the manufacture
of this book is governed by continued postwar shortages.*

A SELECTION OF TITLES FROM THE
INTERNATIONAL CHEMICAL SERIES

LOUIS P. HAMMETT, PH.D., *Consulting Editor*

- Amsden*—
Physical Chemistry for Premedical Students
- Arthur*—
Lecture Demonstrations in General Chemistry
- Arthur and Smith*—
Semimicro Qualitative Analysis
- Booth and Damerell*—
Quantitative Analysis
- Briscoe*—
Structure and Properties of Matter
- Coghill and Sturtevant*—
An Introduction to the Preparation and Identification of Organic Compounds
- Crist*—
A Laboratory Course in General Chemistry
- Daniels*—
Mathematical Preparation for Physical Chemistry
- Daniels, Mathews, and Williams*—
Experimental Physical Chemistry
- Desho*—
Organic Chemistry
- Dole*—
Experimental and Theoretical Electrochemistry
- Gibb*—
Optical Methods of Chemical Analysis
- Glasstone, Laidler, and Eyring*—
The Theory of Rate Processes
- Griffin*—
Technical Methods of Analysis
- Hamilton and Simpson*—
Calculations of Quantitative Chemical Analysis
- Hammett*—
Physical Organic Chemistry
Solutions of Electrolytes
- Henderson and Fernelius*—
Inorganic Preparations
- Huntress*—
Problems in Organic Chemistry
- Leighou*—
Chemistry of Engineering Materials
- Long and Anderson*—
Chemical Calculations
- Millard*—
Physical Chemistry for Colleges
- Moore*—
History of Chemistry
- Morton*—
Laboratory Technique in Organic Chemistry
The Chemistry of Heterocyclic Compounds
- Norris*—
Experimental Organic Chemistry
The Principles of Organic Chemistry
- Parr*—
Analysis of Fuel, Gas, Water, and Lubricants
- Reedy*—
Elementary Qualitative Analysis
Theoretical Qualitative Analysis
- Rieman, Neuss, and Naiman*—
Quantitative Analysis
- Robinson and Gilliland*—
The Elements of Fractional Distillation
- Schoch, Felsing, and Watt*—
General Chemistry
- Snell and Biffen*—
Commercial Methods of Analysis
- Steiner*—
Introduction to Chemical Thermodynamics
- Stillwell*—
Crystal Chemistry
- Stone, Dunn, and McCullough*—
Experiments in General Chemistry
- Thomas*—
Colloid Chemistry
- Timm*—
General Chemistry
An Introduction to Chemistry
- Watt*—
Laboratory Experiments in General Chemistry and Qualitative Analysis
- Williams and Homerberg*—
Principles of Metallography
- Woodman*—
Food Analysis

CRYSTAL CHEMISTRY

by CHARLES W. STILLWELL, PH.D.
Research Chemist, Dennison Manufacturing Company

First Edition

FOURTH IMPRESSION

McGRAW-HILL BOOK COMPANY, INC.
NEW YORK AND LONDON

1938

COPYRIGHT, 1938, BY THE
MCGRAW-HILL BOOK COMPANY, INC.

PRINTED IN THE UNITED STATES OF AMERICA

*All rights reserved. This book, or
parts thereof, may not be reproduced
in any form without permission of
the publishers.*

CR/85

IPM

322251

C/8

C/68

COMPOSITION BY THE MAPLE PRESS COMPANY, YORK, PA.
PRINTED AND BOUND BY COMAC PRESS, INC., BROOKLYN, N. Y.

PREFACE

The remark has been made that we have known little about solids because their properties depend upon the arrangement of the molecules and that to make headway we must learn the laws of arrangement. The determination, since 1912, of the crystal structures of literally hundreds of compounds has finally led, within the last ten years, to the discovery of the important principles governing the arrangement of atoms in crystals. Systematic crystal chemistry is being evolved.

Crystal chemistry is the study of (1) the laws governing the arrangement of atoms in solids and (2) the influence of the arrangement and electronic structure of the atoms upon the physical and chemical properties of the solid.

Because the principles of crystal chemistry involve significant revisions of some of the basic concepts of chemistry, they must, eventually, take their places in the equipment of every chemist and in the elements of chemical instruction.

It seems unnecessary to observe that the generalizations of crystal chemistry should be furnished the student at the beginning of his chemical training, provided that they can be presented in a simple but accurate form. With this conviction, the author started, some six years ago at the University of Illinois, to devote two weeks of the introductory course in general chemistry to the presentation of these fundamental ideas. It appeared that the students not only were able to understand and apply the principles and appreciate their usefulness, but that student interest in chemistry in general was heightened. The very incompleteness of the subject seems to stimulate the imagination of those students who are really interested. The broad, general concepts of crystal chemistry are now well founded, but a more detailed treatment reveals ideas still in the making, subject to constant revision.

Although there have been many reviews published on the various phases of the structure and properties of solids, no

publication has been available which presents a general picture of the subject in simple form, useful as a text or as a point of departure for a more thorough study of the field. This book is intended to fill that need with the hope that, incidentally, the incorporation of the ideas of crystal chemistry into the usual courses in inorganic chemistry may serve to revitalize the teaching of the latter subject.

Opinions will naturally differ concerning the point in the chemistry curriculum at which the subject can most profitably be introduced, and an attempt has been made to arrange the book to meet this situation. The first chapter presents briefly the broad, basic concepts of crystal chemistry and is intended, together with judicious selections from the chapter on the structure of the elements, for use in the introductory course in chemistry. The fundamentals outlined in the Introduction are developed in greater detail in later chapters and the book as a whole is suitable for use in advanced courses. The last two chapters concerning the structure of fibers may be read by the beginner or the advanced student quite apart from the rest of the book. The fibrous structure is of particular technical interest because it is found in such a large variety of natural and synthetic products and exerts a significant influence on their properties.

This book is intended to be complete insofar as the general conceptions are concerned, but much detail has necessarily been omitted. To the relatively few people specializing in this field it may offer little that is new, save perhaps a useful assembling of a great deal of interesting material heretofore scattered far and wide. The bibliography is not exhaustive, but reference has been made to many papers which offer good points of departure for those who wish to explore the subject in greater detail.

The author's main purpose, however, is to present the broader aspects of this relatively new branch of chemistry in as simple a fashion as is consistent with accuracy, trusting that chemists in general will find this point of view useful in the rationalization of a great many chemical and physical facts concerning solids.

Many people have given generously of their time to criticize various parts of the manuscript. Among these are Mr. J. B. Calkin; Drs. R. B. Corey, S. B. Hendricks, M. L. Huggins,

E. R. Jette, Linus Pauling, L. W. Pickett, Otto Reinmuth, H. A. Smith, and W. H. Zachariasen. The author is particularly grateful to Dr. Ralph Hultgren and Dr. B. E. Warren, with whom much of the subject matter has been discussed at some length. The continued interest shown by Dr. G. L. Clark in the progress of the book is keenly appreciated. It is understood, of course, that, while many of their suggestions have been very helpful, these men are in no sense responsible for the contents of this book. That responsibility lies entirely with the author.

Parts of Chapters I, V, VI, and XII have appeared in the *Journal of Chemical Education* and permission for their reproduction is gratefully acknowledged.

CHARLES W. STILLWELL.

FRAMINGHAM, MASS.,
March, 1938.

CONTENTS

	PAGE
PREFACE	v
CHAPTER I	
INTRODUCTION	1
CHAPTER II	
THE SIZES OF ATOMS AND IONS	33
CHAPTER III	
THE STRUCTURES AND PROPERTIES OF THE ELEMENTS: THE METALLIC STATE	60
CHAPTER IV	
THE NATURE OF ALLOYS.	98
CHAPTER V	
THE STRUCTURES OF BINARY COMPOUNDS	158
CHAPTER VI	
THE PROPERTIES OF BINARY COMPOUNDS.	213
CHAPTER VII	
THE STRUCTURES OF TERNARY COMPOUNDS.	259
CHAPTER VIII	
THE STRUCTURES OF THE SILICATES	286
CHAPTER IX	
THE STRUCTURES OF WERNER COMPOUNDS.	307
CHAPTER X	
ISOMORPHISM, MIXED CRYSTALS, POLYMORPHISM	323
CHAPTER XI	
THE STRUCTURES OF ORGANIC CRYSTALS.	334

	Page
CHAPTER XII	
NATURAL FIBERS	348
CHAPTER XIII	
SYNTHETIC FIBERS.	397
APPENDIX	417
INDEX.	425

CRYSTAL CHEMISTRY

CHAPTER I

INTRODUCTION

The essential difference between the liquid and solid states, according to our present conception, is a difference in the relative mobilities of the molecules. In liquids the molecules are more active and are free to move around considerably. In solids the molecules possess less energy, and their attraction for each other holds them in apparently rigid positions in which the motion of each is relatively restricted.

The study of the formation of crystals and the conditions controlling their growth has shown that their outward form or habit may be modified by these conditions. For the present, however, we must pass over this very interesting part of the story and limit ourselves to the study of the properties of crystals already formed.

A well-formed crystal is relatively rare in nature, and unless special precautions are taken, it is difficult to prepare one of any great size in the laboratory. As a result, crystals were formerly considered as rather mysterious exceptions to the more common forms of solids. Albert Dürer, the sixteenth century artist, in an etching called "Melancholia," displays prominently a large crystal to depict one of the unfathomable mysteries of nature. In the latter sixteenth century the microscope was invented, and then came the realization that crystals were much more common than had been supposed; in fact, it was observed that most of the minerals found in nature and the precipitates formed in the laboratory are actually crystalline, but too minute for the regularity of form to be observed with the naked eye.

About 150 years ago the science of crystallography—the study of the outward form of crystals—was founded with the publica-

tion of Haüy's "Essai d'une theorie sur la structure des cristaux." The crystallographer learned to classify the many crystalline substances according to their outward form, particularly by the angles formed between faces of the crystals. This was first done for calcite by Huygens and reported in his "Treatise on Optics" in 1690.

Considering its limitations, crystallography made remarkable progress. As a result of the observation of outward form, the careful measurement of interfacial angles and the study of the cleavage properties of crystals, all crystals were found to belong to one of six great groups or systems, described briefly as follows:¹

1. *The Cubic System.*—Three axes at right angles to each other and equal in length. $a = b = c$; $\alpha = \beta = \gamma = 90$ deg. Examples: NaCl, CaO, $\text{Ni}(\text{NH}_3)_6\text{Cl}_2$, Cu, diamond.

2. *The Tetragonal System.*—Three axes at right angles to each other, two of these equal in length. $a = b \neq c$;

$$\alpha = \beta = \gamma = 90 \text{ deg.}$$

Examples: SnO_2 , K_2PtCl_4 , $\text{BeSO}_4 \cdot 4\text{H}_2\text{O}$, Sn.

3. *The Orthorhombic System.*—Three axes at right angles to each other, all different in length. $a \neq b \neq c$;

$$\alpha = \beta = \gamma = 90 \text{ deg.}$$

Examples: HgCl_2 , K_2SO_4 , I.

4. *The Monoclinic System.*—Three axes, one perpendicular to the plane of the other two, which may make any angle with each other. The axes are unequal in length. $a \neq b \neq c$; $b \perp a$ and c . Examples: KClO_3 , $\text{K}_3\text{Fe}(\text{CN})_6$, $\text{CaSO}_4 \cdot 2\text{H}_2\text{O}$, S.

5. *The Triclinic System.*—Three axes making any angles with each other and of unequal lengths. $a \neq b \neq c$;

$$\alpha \neq \beta \neq \gamma \neq 90 \text{ deg.}$$

Examples: $\text{CuSO}_4 \cdot 5\text{H}_2\text{O}$, Al_2SiO_5 , $\text{K}_2\text{S}_2\text{O}_8$.

6. *The Hexagonal System.*—Two axes in one plane, making angles of 120 deg. with each other and equal in length. The

¹ For a more detailed discussion of crystallography, see any good book on mineralogy; or R. W. G. Wyckoff's "The Structure of Crystals," 2d ed., Chap. II, Reinhold Publishing Corporation, New York, 1930.

third axis is perpendicular to this plane and of different length. $a = b \neq c$; $\alpha = \beta = 90$ deg., $\gamma = 120$ deg. Examples: SiO_2 (quartz), AgI , $\text{NaIO}_4 \cdot 3\text{H}_2\text{O}$, Zn .

The Hexagonal System, Rhombohedral Division.—Three axes of equal length and making equal angles with each other, but not right angles. $a = b = c$; $\alpha = \beta = \gamma \neq 90$ deg. Examples: Al_2O_3 , CaCO_3 (calcite), As , Sb , Bi .

A casual glance at the examples listed for the several systems indicates the utter futility of an attempt to relate the crystal system, in which a substance occurs, to its chemical properties. In the cubic system are found representatives of elements, oxides, salts, and complex compounds. Elements are to be found in five of the six systems. As was to be expected, no significant progress was made in correlating crystalline form and the chemical nature of solids.

As the science developed, attention was turned from the outward form to a consideration of the inner structure of crystals, and people speculated upon the various symmetrical arrangements of points in space. We now know that there are 32 classes of symmetry geometrically possible. This was first discovered in 1830, but its importance was not realized until many years later. There was no way of obtaining experimental evidence of the internal structure of crystals because molecules are too small to be seen even with the most powerful microscope. To be visible, an object must be large enough to cast a shadow which may be seen or to scatter light which falls upon it.

The purely imaginary picture of the interior of a crystal, built up of discrete building blocks of atoms or molecules, became so realistic that Barlow,¹ in 1897, assuming the atoms to be spheres, postulated a number of hypothetical arrangements of such spheres in space as determined by their relative sizes. Sollas, in 1898, proposed a method to determine the sizes of atoms in crystals and attempted to show a definite relation between the relative sizes of these building stones and the type of crystal which was formed.² Sollas's discussions were faulty in detail, and his method of determining the volumes of atoms was inadequate, although the best available at the time, but some of his general conceptions

¹ BARLOW, W., *Sci. Proc. Roy. Dublin Soc.*, **8**, 527 (1893–1898).

² SOLLAS, W. J., *Proc. Roy. Soc. (London)*, **63**, 270, 286 (1898).

show remarkable insight and have recently been substantiated.¹ The feeling that the volumes of atoms have an important bearing on the formation of crystals persisted in the writings of Barlow and Pope² and Barker,³ but again, although their deductions were ingenious, they were hampered by the lack of a reliable method of determining the sizes of the atoms in crystals.

It was in 1912 that von Laue and associates demonstrated that X rays, discovered by Roentgen in 1896, might be useful to investigate the inner structure of crystals⁴ and opened the way for the real development of the study of solids. For the first time, investigators had at hand a method for peering beneath the surface of a crystal and studying more than its outward form. There was the possibility of fixing the position of each atom or molecule, each building stone in the crystal, and of measuring the size of these building stones with a fair degree of accuracy.

The details of the X-ray analysis of crystals are rather involved, but the fundamental principles are comparatively simple and easy to understand.⁵ If a beam of X rays is passed through a crystal, the successive planes of atoms act like reflectors for the rays. In order to detect the "reflected" ray, it is necessary that all the rays "reflected" from the several planes in a given set reinforce each other. This can occur only when $n\lambda = 2d \sin \theta$ (see Fig. 1), where θ is the angle of incidence, λ is the wave length of the X rays, d is the distance between successive planes of atoms, and n is a whole number.⁶ If a photographic plate is

¹ His proposals, for example, that atoms and ions differ in size and that ionic radii are not constant but vary according to their environment (see Chap. II).

² BARLOW, W., and W. J. POPE, *J. Chem. Soc.*, **89**, 1727 (1906); **93**, 1528 (1908).

³ BARKER, T. V., *J. Chem. Soc.*, **101**, 2490 (1912).

⁴ FRIEDRICH, W., P. KNIPPING, and M. VON LAUE, *Ann. Physik*, **41**, 971 (1912).

⁵ For the most elementary and entirely adequate treatment, see W. L. Bragg, "Introduction to Crystal Analysis," G. Bell & Sons, Ltd., London, 1928. See also, G. L. Clark, "Applied X-rays," 2d ed., McGraw-Hill Book Company, Inc., New York, 1932; Wyckoff, R. W. G., "The Structure of Crystals," 2d ed., Reinhold Publishing Corporation, New York, 1930.

⁶ This is known as the Bragg equation. Von Laue interpreted the spots on his diffraction pattern by treating each point in the crystal as a diffraction

fixed at P (Fig. 1), there will be a darkening at A by the part of the incident beam which passes unscattered through the crystal and a darkening at B by the scattered or reflected beam. Obviously, if the distance from the crystal to the photographic plate is known, the distance AB is measured, and monochromatic X rays of known wave length λ are used, then the angle θ may be calculated, and the distance d between the planes of atoms in the crystal may be determined.

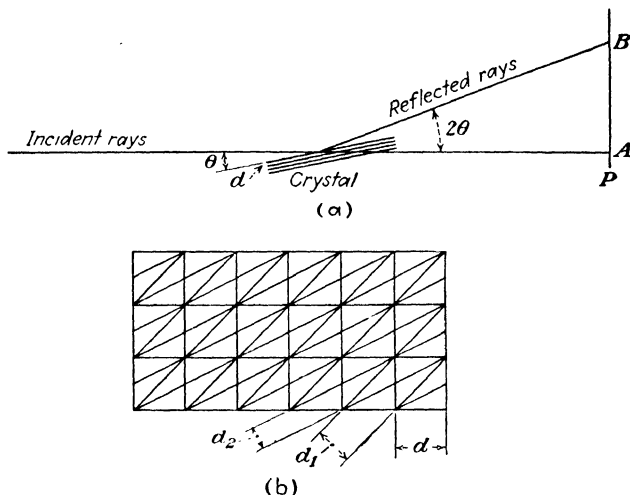

FIG. 1.—(a) General procedure in the use of the Bragg equation, $n\lambda = 2d \sin \theta$, in the determination of interplanar spacings in crystals. (b) A few of the possible sets of planes in a two-dimensional lattice.

When points are arranged regularly in space, it is possible to imagine planes through these points in many different directions. Everyone who has had occasion to pass a field of corn, regularly planted, has observed that, from a single vantage point, rows seem to radiate in many directions as illustrated in Fig. 2. In a three-dimensional lattice, like a crystal, the same sort of thing occurs, but here we are interested in sets of parallel planes instead of parallel lines. When the distances between many sets of

center. W. L. Bragg suggested [*Proc. Cambridge Phil. Soc.*, **17**, 43 (1913)] that the process is geometrically equivalent to a reflection of rays in a series of atomic planes parallel to a crystal face. This suggestion has simplified the interpretation of diffraction patterns considerably and has been invaluable for that reason.

intersecting planes have been calculated, the position of each atom in the crystal becomes known. Their positions may be defined in terms of a three-dimensional system, known as the "crystal lattice," the framework which defines the pattern upon which the crystal is built. The smallest unit of this lattice which illustrates all of its characteristic geometrical properties is known as the "unit cell." This unit, repeated successively throughout space, builds the crystal. Crystals of a given substance may

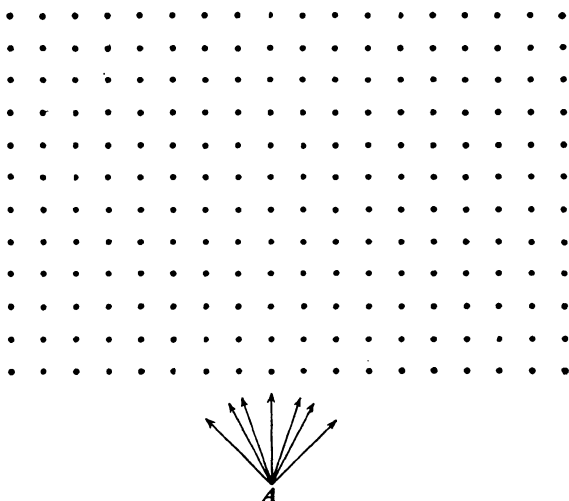

FIG. 2.—Sets of parallel lines in a point pattern extending in the directions indicated by the arrows.

grow to enormous dimensions by the regular addition of these identical building units, and so the effect of all crystals of the same substance on X rays is the same, be they the size of a shoe box or invisible to the naked eye.¹ The term "length of axis" which was used in defining the six crystal systems now takes on a more definite meaning. It refers to the relative distances between the building stones along the three axes of the crystal. If, for example, the building stones are placed the same distance apart along all three axes, as they are in the cubic crystals, then the axes are said to be equal in length. The crystal structure and the size of the unit cell of a substance are characteristic prop-

¹ Crystals of cross section less than 10^{-6} cm. are too small to produce sharp diffraction patterns.

erties by means of which that substance may be distinguished from others.

Since 1912 our knowledge of the structure of crystals has grown at a tremendous rate, until today literally thousands of different crystalline substances have been studied more or less completely. Contrary to the earliest conception of a crystal as an exceptional form of solid matter, we now know that there are very few solids indeed which are not crystalline. Before 1912 it was customary to call "amorphous" all those precipitates which did not appear to be crystalline when examined with the microscope. The more sensitive X rays detected a regular arrangement of particles in most of these precipitates. We now list among the crystalline or partly crystalline substances most inorganic and organic substances, including many things not commonly thought of as crystals, such as wood, cotton, wool, silk, rubber, shells, bone, wax, and others. These will be described in detail in later chapters. The important noncrystalline or vitreous solids are the glasses, a group of oxides and certain salts of these oxides, and many of the resinous solids. These substances are more properly classified as supercooled liquids. Without a doubt, the most interesting aspect of all that has been learned about solids these twenty years is the remarkable orderliness of nature, the precision and regularity with which nature builds most solid matter. Lately it has been proposed that even in the vitreous or glassy "solids" there is a certain consistency of structure, an orderliness which causes them to solidify in their apparently disorderly way.¹ Thus, as our understanding of solids develops, the consistency of nature, even in the face of apparent inconsistencies, is a source of never failing fascination.

As was to be expected, the rapid accumulation of crystal structure data stimulated attempts to find some relation between the structure of crystals and their chemical composition and other chemical and physical properties. The true scientist is never satisfied merely to amass data. Facts are a means to an end, and he seeks to classify these data and, from his classification, to evolve a useful generalization on the basis of which additional facts may be predicted. In this case the very nature of solid

¹ ZACHARIASEN, W. H., *Phys. Rev.*, **39**, 185 (1931); WARREN, B. E., *Z. Krist.*, **86**, 349 (1933) (in English); and see Chap. VIII.

matter was at stake. Inquisitive people were asking: What relation is there between the structure of crystals and their chemical nature? If NaCl and KCl are isomorphous, why should CsCl have a different structure? What determines the crystal structure of a given element or compound? What kind of forces hold the building units together in a crystal? Does the fact that AlCl₃ melts at 190°C. (at 2½ atm.), while NaCl melts at 805°C., have anything to do with their crystal structures? How are the properties of crystals related to their structures?

With the structures of hundreds of crystalline solids at hand, the complexity of the data was baffling. The idea still persisted, however, that the atomic or ionic sizes have an important bearing on the question, and many investigators gave their attention to this matter. Foremost among these was Grimm who, in a series of papers starting in 1921,¹ pointed out many remarkable relations between the sizes and properties of ions, some of which will be considered in detail later. It was not until 1926–1927, 14 years after the first X-ray crystal-structure analysis, that generalizations were finally found which suggest why solids crystallize in so many different forms, what factors determine the particular form in which a solid will crystallize, and how the properties of solids are related to their structures. These "laws of arrangement" were proposed independently by Goldschmidt in Oslo² and by Pauling in this country.³ The appearance of these proposals marks the beginning of what may be termed "crystal chemistry." This youngest branch of chemistry, only ten years old and in many respects still in its infancy, is the subject of the succeeding chapters.

The newness of crystal chemistry, its very incompleteness, adds greatly to its interest. We shall see that there are differences of opinion in regard to some of the features, differences which cannot be definitely settled with the facts now at hand, and must be kept in mind in the light of facts still to be dis-

¹ Summarized by H. G. Grimm, "Handbuch der Physik," vol. XXIV, p. 463, Julius Springer, Berlin, 1927.

² GOLDSCHMIDT, V. M., *Skrifter Norske Videnskaps-Akad. Oslo*, no. 2 (1926); no. 8 (1926); *Ber.*, **60**, 1263 (1927); *Trans. Faraday Soc.*, **25**, 253 (1929).

³ PAULING, LINUS, *J. Am. Chem. Soc.*, **49**, 765 (1927).

covered. In developing the generalizations of crystal chemistry, we shall expect them to serve two useful purposes: They should spare us the necessity of remembering a large number of isolated facts, and with their aid we should be able to predict facts not yet known.

IONIC CRYSTALS

It is wise to approach crystal chemistry by the simplest route. Consider compounds of the type AX . It is known that such

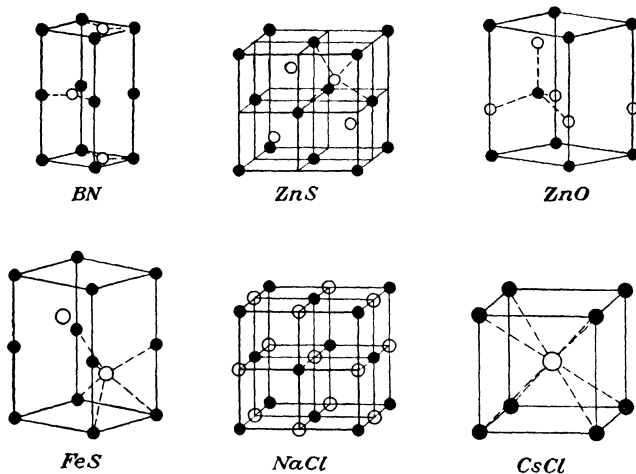

FIG. 3.—Typical crystalline structures of compounds of the general type AX . [From V. M. Goldschmidt, *Trans. Faraday Soc.*, **25**, 254(1929).]

compounds may crystallize in many different forms, six typical examples of which are shown in the unit cells pictured in Fig. 3.¹ Some of these are rather complicated, but those of sodium chloride and cesium chloride are easy to visualize and may be studied with profit. It will be seen that in the sodium chloride crystal there are six chlorine atoms nearest to the sodium at the center of the cube, and these lie in the centers of the faces of the

¹ The arrangement of atoms or ions in crystals may be shown in a number of ways. Three methods in common use have been utilized in this book so that they may become familiar. In Fig. 3 the positions of the centers of the ions are indicated, without regard for relative sizes. In Fig. 5 the ions are drawn to scale to show how they are packed into the available space. Figure 11 illustrates the use of projections of the unit cell in a single plane.

cube. In the cesium chloride structure, there are eight chlorine atoms at the corners of the cube which are nearest to the cesium at the center. Actual crystals, of course, are built up of many unit cells added to this one in three dimensions. The one cell serves to illustrate the plan of the entire crystal.

It is evident that no particular chlorine atom belongs to the sodium (or cesium) at the center of the cube, and, therefore, NaCl (or CsCl) molecules, as such, do not exist in the crystal. In fact, these crystals are typical of a large group of so-called ionic crystals, in which the particles of which the crystals are built are ions rather than atoms or molecules. The ions are held together by the attraction of opposite electrical charges. Later we shall consider crystals in which forces holding the particles together differ from these ionic forces, and we shall find that the properties of such crystals also differ from those of ionic crystals.

It is still possible to think of the crystal as a whole as a giant molecule. It should be noted that in spite of appearances to the contrary, the number of sodium ions in a unit cell is the same as the number of chloride ions, thereby satisfying the relation NaCl. This may be calculated by imagining other unit cells attached to the pictured one. Then ions at the corners are shared by seven other unit cells and are only one-eighth in the pictured one; ions at edges are shared by three other unit cells and are one-fourth in the pictured one; ions in faces are one-half in the pictured cell. Only the sodium ion at the center belongs wholly to the single unit cell.

One of the best ways to learn why AX compounds crystallize in different forms is to study a series of similar compounds in which a change in structure occurs and to find the factors upon which the structural change seems to depend. Suppose we consider the series LiBr, NaBr, KBr, RbBr, CsBr. The first four of these have the NaCl structure, the last, the CsCl structure. These bromides are chemically similar, and their differences must therefore be physical. The most obvious point of difference among them in each case is the variation in the size of the respective cations:¹

¹ Until recently, the building blocks in a crystal were pictured as more or less rigid spheres and the term "ionic radius" had a very real meaning.

Li ⁺	Na ⁺	K ⁺	Rb ⁺	Cs ⁺
0.68	0.98	1.33	1.48	1.67 A

Now let us recall that a NaBr crystal is formed from fused NaBr, or a solution of NaBr, when the ions come comparatively close together and form an orderly array in space. Assuming that the ions are spherical, what single condition will most strongly influence the number of bromide ions which may surround and touch a single sodium ion? Obviously, it is the relative sizes of the two ions. If we let the bromide X and the sodium A ions be represented by balls 4 and 2 in., respectively, in diameter, we shall see that six bromide balls can approach and touch the sodium but that more than six cannot touch. In order to get more than six touching, we must either increase the size of A or decrease the size of X , *i.e.*, we must increase the ratio $R_A:R_X$. It may be calculated geometrically that when the value of $R_A:R_X$ is greater than 0.73, eight balls may surround and touch the inner one, while if $R_A:R_X$ is less than 0.73, only six balls can surround the inner ball. This same procedure may be carried further and it will be found that as the central ball A becomes still smaller with respect to X , the number of balls X which can surround and touch A is reduced from six to four. This occurs when the ratio $R_A:R_X$ goes below 0.41. If $R_A:R_X$ is less than 0.22, only 3 X can surround and touch A . These geometric relations are summarized in Table 1. It should be emphasized that these numerical limits have been derived

But wave mechanics has changed our conception of an atom or ion. Certainly it is no longer a sphere with a definite size and constant radius in the usual sense. Its size now depends upon the method used to investigate it and upon the environment in which it finds itself. We may still use the term "ionic (or atomic) radius" provided the circumstances of its determination are defined. In a given crystal, the distance between the centers of neighboring atoms or ions is an unambiguous value, and the atomic or ionic crystal radii about which we shall speak are those which, when added together, should equal the interatomic or interionic distances in crystals.

A table of ionic and atomic radii is given in the Appendix. To avoid confusion, it may be well to emphasize that in diagrams like those of Figs. 3 and 4, no account is taken of relative ionic sizes; only the positions of the centers of the ions are indicated. In Figs. 5 and 6, however, the relative ionic sizes are shown.

geometrically, entirely divorced from any chemical consideration, and apply to the packing of perfect spheres.

TABLE 1.—THE ARRANGEMENT OF SPHERES X ABOUT A SPHERE A

No. of X	Arrangement of spheres X	$R_A:R_X$
2	Opposite each other	Up to 0.15
3	Corners of equilateral triangle	0.15–0.22
4	Tetrahedral corners	0.22–0.41
6	Octahedral corners	0.41–0.73
4	Square corners	0.41–0.73
8	Cube corners	0.73 and above

Let us calculate the $R_A:R_X$ ratio for the series of alkali bromides. The values are given in Table 2.

TABLE 2.— $R_A:R_X$ VALUES FOR THE ALKALI BROMIDES

Compound.....	NaCl structure				CsCl structure
	LiBr	NaBr	KBr	RbBr	CsBr
Radius of A.....	0.68	0.98	1.33	1.48	1.67
$R_A:R_X$	0.40	0.50	0.68	0.75	0.84

It is evident that we may have found the explanation of the difference in structure of these chemically similar substances. As A increases in size, the change in structure from one in which the cation A is surrounded by six bromide ions to one in which it is surrounded by eight bromide ions occurs at just about the point required for the packing of spheres. This suggests very strongly that the relative sizes of the two different ions which must be packed together will determine the type of arrangement of these ions in the crystal lattice.

The number of nearest neighbors surrounding any atom or ion in a crystal is known as the coordination number (C.N.) of that atom or ion. It is helpful to classify the AX crystal types on the basis of their coordination numbers, as shown in Table 3.

TABLE 3.—COORDINATION TYPES FOR AX CRYSTALS

C.N.	Type*
1	Single molecules, molecular lattices
2	Double molecules, molecular chains
3	Boron nitride
4	ZnS, ZnO
6	NaCl, FeS (NiAs type)
8	CsCl

* See Fig. 3.

Having proposed the idea that the arrangement of atoms A and X in crystals is affected by their relative sizes, let us check

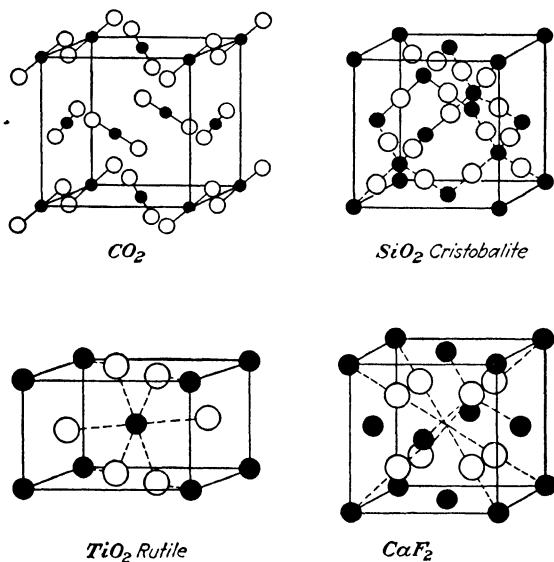

FIG. 4.—Typical crystalline structures of compounds of the general type AX_2 . [From V. M. Goldschmidt, *Trans. Faraday Soc.*, **25**, 255(1929).]

our theory for some typical compounds of the type AX_2 . Four common types of crystal lattice for AX_2 compounds are shown in Fig. 4. Again, the most important single characteristic of these lattices is the coordination number. For AX_2 compounds there will be two coordination numbers, for there are twice as many ions (or atoms) X as there are ions (or atoms) A . The classification of AX_2 lattices on the basis of coordination numbers is given in Table 4.

TABLE 4.—COORDINATION TYPES OF AX_2 CRYSTALS

C.N.	Type*
2 and 1	Single molecules. Molecular lattices. CO_2
4 and 2	Cristobalite, SiO_2
6 and 3	Rutile (TiO_2). CdI_2 , layer lattice†
8 and 4	Fluorite, CaF_2

* See Fig. 4.

† See Fig. 5.

In Table 5 are the $R_A : R_X$ values for a series of AX_2 compounds, the difluorides. The experimental determination of the crystal structures of all these has shown that they may be divided as indicated. Thus it is evident that the same relationship holds as that for AX compounds, *viz.*, that the structure changes from one of C.N. 8 to one of C.N. 6 when $R_A : R_X$ falls below 0.73.

TABLE 5.—STRUCTURE OF DIFLUORIDES AS A FUNCTION OF $R_A : R_X$

	Rutile structure, C.N. 6-3					Fluorite structure, C.N. 8-4				
	MgF_2	NiF_2	CoF_2	ZnF_2	MnF_2	CdF_2	CaF_2	SrF_2	PbF_2	BaF_2
R_A	0.78	0.78	0.82	0.83	0.90	0.97	0.98	1.27	1.32	1.43
$R_A : R_X$	0.59	0.59	0.62	0.63	0.68	0.73	0.73	0.95	1.00	1.08

We shall state tentatively, then, what may be called for convenience the radius ratio rule: The structure of an ionic crystal depends upon the relative sizes of its building stones.

This idea was originally suggested by Barlow and by Solla before 1900, and it is extremely interesting to read their papers in the light of our present knowledge. But there was no good way to determine ionic sizes in those days, and it remained for Goldschmidt and Pauling, utilizing recent values for the ionic radii, to put the rule on a sound, experimentally verified basis.

THE INFLUENCE OF THE ELECTRON-PAIR BOND AND OF POLARIZATION

Were we to proceed with the belief that the structures of all compounds are consistent with the radius ratio rule we should be quickly disillusioned, and this is not surprising. It must be remembered that the radius ratio rule is based on the assumption that we are dealing with ions which are spherical and bound

together by ionic or electrostatic forces. For most ions this is not strictly true, and for a great many it is far from the truth. If a relatively small positive ion is brought near a large negative ion, there is a tendency for the more concentrated positive charge of the small ion to attract the diffuse negative charge of the larger ion, and the latter becomes distorted. The distorted ion is said to be polarized, the small positive ion is said to be strongly polarizing or to show a polarizing effect, and the whole phenomenon is known as "polarization." Until very recently it has been convenient to "explain" certain facts of crystal chemistry on the basis of polarization. There is a growing conviction, however, that in most cases polarization or actual distortion of the ions, while it may always occur to some extent, is a minor factor and that the influence of a different kind of binding force—the electron-pair or covalent bond—must be reckoned with.

The electron-pair bond was conceived by G. N. Lewis¹ as early as 1916 as the binding force between electronegative atoms, such as F₂, arising when two such atoms complete their octets by sharing a pair of electrons. Not until the advent of the quantum mechanics was the electron-pair bond given a reasonable physical meaning. Then it was suggested that when two atoms come very close together, an additional attracting force becomes operative. Each may contribute one electron to a shared pair, and both tend to jump back and forth between the two atomic nuclei giving rise to a "resonance" energy of considerable magnitude which constitutes a large part of the energy of the bond. To form an electron-pair bond, the electrons must satisfy certain requirements. They must be spinning in opposite directions, and they must be unpaired in their own atoms. An unpaired electron is one for which there is no other that is identical in the first three quantum numbers and different only in direction of spin.² The nature of the resonance energy is not unique but depends upon the electrostatic forces between the electrons.

A clear conception of this so-called "resonance phenomenon" is of great value in understanding various manifestations of the

¹ LEWIS, G. N., *J. Am. Chem. Soc.*, **38**, 762 (1916); NOYES, W. A., *Chem. Rev.*, **17**, 1 (1935), has written a very interesting review of the electronic theories of valence.

² For a further discussion of the nature of the covalent bond, see Chap. V.

electron-pair bond in solids. When the two electrons of a pair bonding electronegative atoms, like Cl : Cl or Cl : $\overset{\cdot\cdot}{\underset{\cdot\cdot}{\text{C}}} : \text{Cl}$

exchange places simultaneously, a bond results which is as nearly covalent as can ever be realized. But, if the two electrons do not jump simultaneously—as, perhaps, in Ag : Cl—then for that part of the time when both electrons are on one atom, ions (either Ag⁺, Cl⁻ or Ag⁻, Cl⁺) and an ionic bond exist. The bond over a period of time, then, is neither covalent nor ionic, but a mixture of these two, and the properties of the compound will show characteristics of both. Indeed, this conception of the coexistence of an ionic and a covalent binding between ions or atoms is one of the most interesting contributions of the quantum mechanics. It is convenient to represent this ionic-covalent bond thus, Ag : Cl, as compared with the pure covalent bond, Ag : Cl, and the ionic bond, Ag : Cl.

It is not surprising that those peculiarities of crystals not strictly ionic, peculiarities explained by picturing distorted or polarized ions, may be accounted for as satisfactorily and with greater justification by recognizing the influence of the covalent bond. Factors influencing the formation of the covalent bond will be considered in greater detail later; suffice it to say that those atoms with high ionization potentials (those which ionize with greatest difficulty) tend to form covalent rather than ionic bonds; while those electronegative atoms with the lower electron affinities (those showing least attraction for electrons) tend to form covalent bonds rather than ionic. Comparing the factors influencing polarization with those influencing bond type, one may observe

1. For a series of ions with the same charge, the smaller the ionic radius, the greater the polarizing effect of the ion and the higher the ionization potential. Thus, of the alkali metals, Li⁺ has the greatest polarizing effect and the greatest tendency to form a covalent bond.

2. For two ions of the same size, one with 18 electrons in the outer shell exhibits a greater polarizing effect and has a higher ionization potential than an 8-shell ion. For example, Ca⁺⁺

(0.98 Å) and Cd^{++} (0.99 Å) have the same ionic radii, but Ca^{++} is an 8-shell ion while Cd^{++} is an 18-shell ion. The Cd^{++} is more strongly polarizing; it is also more apt to form a covalent bond.

3. The larger the negative ion, the more easily may it be polarized and the lower is its electron affinity. Thus, of the halogens, the iodide ion is most easily polarized and most likely to form a covalent bond.

From these generalizations it follows that, as a rule, the alkalis and alkaline earth ions do not polarize strongly and favor ionic bonds; and of the common anions, F^- and O^- are not strongly polarized and generally form ionic bonds. We shall find, therefore, that compounds containing these ions are least apt to violate the radius ratio rule. For the other "ions," the increasing influence of the covalent bond becomes very important because it accounts in the main for many of the exceptions to that rule. Polarization, too, doubtless exists in varying degrees between most atoms and ions, but in general its effect is secondary and will be so considered throughout our discussion. The radius ratio rule, then, applies strictly only to ionic crystals.

Effect of the Covalent Bond and Polarization in AX Structures.—The distance between the nuclei of two atoms *A* and *X*, joined by a covalent bond, is generally less than the distance between the nuclei of the ions of the same elements. Thus when ions *X* of a definite size are packed around ions *A*, if the bond is partly covalent, it will tend to draw ions *X* abnormally close to it, and for that reason, there will not be room for so many ions *X* around *A* as there would be if they all stayed at their normal distances. There is, then, a decreasing distance between the ions which may, if the influence of the covalent bond is marked, actually

TABLE 6.—EFFECT OF THE COVALENT BOND ON INTERIONIC DISTANCES

Crystal	R_A , Å	R_X , Å	Interionic distance, Å
CaO	0.98	1.40	2.40
CdO	0.99	1.40	2.35
CaS	0.98	1.84	2.84
CdS	0.99	1.84	2.51

produce a decrease in coordination number. These effects are illustrated in Tables 6 and 7.

The normal radii of Ca^{++} and Cd^{++} are about the same. In the two oxides the interionic distances are about the same, although there is a slight but real decrease in CdO ; the bonds are essentially ionic in both. The sulfide ion, being much larger, favors, with Cd^{++} , the covalent bond, and there is a marked decrease in the interionic distance. In this case a change in structure is also produced as shown in Table 7. In this table are compared the structure types for the oxides, sulfides, selenides, and tellurides of calcium and cadmium. It is evident that the $R_A:R_X$ ratio alone does not explain the facts, since the values are identical but the structures differ. Furthermore, since the values are all above 0.41, the compounds should all be expected to have the NaCl structure. But, unlike the ionic bond, the covalent bond has definite directional properties and, in the case of cadmium and most other 18-shell cations, the four bonds are directed to the corners of a tetrahedron, thus favoring the ZnS structure (see Fig. 3).

TABLE 7.—THE EFFECT OF THE COVALENT BOND ON THE STRUCTURE OF AX COMPOUNDS

	O ⁻	S ⁻	Se ⁻	Te ⁻	
Ca ⁺⁺	NaCl 0.70	NaCl 0.53	NaCl 0.50	NaCl 0.45	Lattice type $R_A:R_X$
Cd ⁺⁺	NaCl 0.70	ZnS 0.53	ZnS 0.50	ZnS 0.45	Lattice type $R_A:R_X$

Because most atoms are not apt to tolerate more than eight electrons in the outer shell, and hence only four electron-pair bonds, the covalent bond appears to be conducive to crystallization in arrangements (like ZnS) characterized by a coordination number of four or less. It follows, then, that when the coordination number in a crystal increases to six (as in the NaCl structure) or more, the bonds are usually ionic. This relation of bond type to coordination number holds in a large majority of cases but is not without exception. There are a few crystals with the NaCl structure in which the bonds are probably largely covalent,

and there are some crystals with C.N. 4 in which the bonds are essentially ionic.¹

Since in a crystal with covalent bonds there is no transfer of electrons, the building units must be pictured as atoms rather than ions. Interesting data which tend to support the conclusion that we are dealing with atoms held by covalent bonds rather than with ions held by ionic bonds are shown in Table 8.

TABLE 8.—A COMPARISON OF IONIC AND HOMOPOLAR CRYSTALS OF AX COMPOUNDS

Compound	Atomic numbers	A-X distance experimental	Ionic radii		A-X distance sum of radii
			A	X	
ZnS Type					
AgI	47-53	2.811	0.93	2.09	3.02
CdTe	48-52	2.799	0.92	2.00	2.92
InSb	49-51	2.793	0.87	2.32	3.19
SnSn	50-50	2.790	0.67	2.77	3.44
CuBr	29-35	2.460	0.91	1.85	2.76
ZnSe	30-34	2.452	0.78	1.80	2.58
GaAs	31-33	2.435			
GeGe	32-32	2.430	0.50	2.56	3.06
NaCl Type					
NaCl	11-17	2.814	0.98	1.81	2.79
MgS	12-16	2.595	0.78	1.84	2.62
NaBr	11-35	2.981	0.98	1.95	2.93
MgSe	12-34	2.726	0.78	1.91	2.69

The ZnS structure is very common for compounds of AX in which element A stands as many units of atomic number ahead of a fourth group element as element X stands behind the same fourth group element. Such a series is shown in this table. The sum of the ionic radii are compared with the A-X distances determined experimentally. The ionic radii given are 5 per cent less than the values in the Appendix, since the latter are for C.N. 6 (see Table 18, page 49).

¹ For further details, see Chap. V.

The data of Table 8 are suggestive for two reasons. First, it is evident that if one assumes the building stones to be ions, the sums of the ionic radii which should give the distances between A and X do not agree satisfactorily with these distances determined experimentally in the crystals of the ZnS type. This in itself suggests that these crystals are not ionic, particularly as there is good agreement between calculated and observed values in the $NaCl$ type crystals which are known to be ionic. The most interesting feature of the structures of the ZnS type is that the interatomic distances for each entire series remain practically constant, while in the similar series with the $NaCl$ structure, the distance between ions decreases with increasing valence; which is to be expected since the forces drawing the ions together are greater.

It seems that for the ZnS structure, however, the dimensions are determined by the total number of electrons present, and it does not matter how these electrons are distributed between the atoms; the two atoms share the electrons in common. These crystals represent an intermediate type between the ionic and the covalent bond but with the covalent bond usually predominating. Further interesting properties of atomic crystals are to be considered later.

Values for atomic radii to be used in crystals of this sort are given in the Appendix.

In the discussion of the last few paragraphs a conception of fundamental importance has been implied and must be clearly stated at this point. The radius ratio is not always the most important factor in determining crystal structure. The type of bond is probably of greater importance. Certain atoms favor the formation of covalent bonds, and the crystal structure is influenced particularly by this bond type. When the ionic bond is favored, however, then relative ionic sizes become of great importance in determining which of several possible ionic crystal structures will be formed. Inasmuch as we are chiefly interested in ionic crystals in this elementary discussion, the matter of ionic sizes has been emphasized.

Effect of the Covalent Bond and Polarization on AX_2 Structures.

A partial departure from the ionic bond has a somewhat different effect on AX_2 lattices although it is a result of the same influences.

A single illustration must suffice. Cadmium fluoride has the structure of fluorite (see Fig. 4). We should expect cadmium hydroxide to have the same structure, since the hydroxyl ion of radius 1.35 Å has been substituted for the fluoride ion of radius 1.33 Å. It happens that hydroxyl, being an unsymmetrical group, may be very easily polarized, and the structure of $\text{Cd}(\text{OH})_2$ is not that of fluorite but is a very different type, the CdI_2 structure, shown in Fig. 5. Examination of this structure shows that while any ion of cadmium is surrounded symmetrically

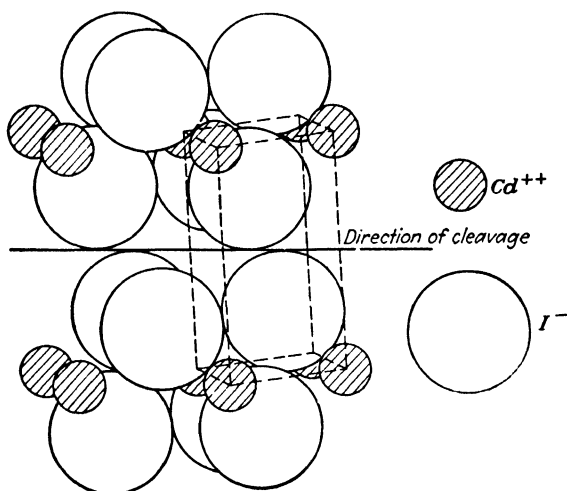

FIG. 5.—The cadmium iodide structure, showing the packing of ions. A layer lattice. (Reproduced, by permission, from the *Encyclopaedia Britannica*.)

by six iodide ions, any iodide ion has contact with three ions of cadmium on one side. Thus the substitution of the easily polarized hydroxyl ion for F^- affects not only the ionic distances and the symmetry, but also produces a structure with lower coordination numbers, just as it may do with AX compounds. Sometimes the coordination number is not affected. For example, the radius ratio for CdI_2 is 0.44. One would predict a structure characterized by C.N.6 and 3; and this is confirmed by the experimental results. In this case the influences of polarization and covalent bonding have reduced the distances between ions and changed their arrangement.

Well-defined layers are produced in the cadmium iodide crystals, and it is known as a "layer lattice," a typical lattice for AX_2 compounds which contain easily polarized anions, and in which the tendency to form a covalent bond is strong. We may look upon each layer as a giant molecule, the atoms of which are held together by an intermediate type of bond which may be predominantly homopolar. Crystals of this sort cleave very easily between layers, evidence that the layers are held together by forces weaker than those within a layer. Many hydroxides, such as $Ni(OH)_2$, $Mn(OH)_2$, $Fe(OH)_2$, and $Co(OH)_2$ which form flaky gelatinous precipitates have this structure.

The Covalent Bond in Radicals.—It is interesting to consider the nature of radicals (*e.g.*, SO_4^- , NO_3^- , PO_4^{-3} , etc.) in the light of the foregoing discussion. Three conditions are to be noted: (1) The central atom in these radicals has a very high ionization potential and is relatively small. It is therefore difficult to ionize. (2) Combining elements in the center or on the right of the periodic table tend to form electron-pair bonds, and the closer they are, the greater is this tendency. (3) The resonance energies of the electron-pair bond for the small elements to the right of the center of the first row are high. Thus, it is reasonable to picture the intraradical bond as an essentially covalent bond which may, however, have an ionic term, generally of secondary importance.

Because of the relatively strong bonds holding its elements together, a radical is a stable group, able to act as a unit in chemical reactions.

THE STRUCTURES OF TERNARY IONIC COMPOUNDS AS TYPES ABX_3 , A_2BX_4 , ETC.

Strong radicals preserve their identity in crystals. Thus, in the calcite form of calcium carbonate, shown in Fig. 6, we do not find ions of calcium, carbon, and oxygen placed more or less equivalently through the lattice. The lattice positions are occupied by Ca^{++} and CO_3^- . The $CaCO_3$ lattice is not very different from that of $NaCl$ or CaO . If we were to stand the CaO lattice on one corner and then push down on it, it would flatten out somewhat (become rhombohedral) to make room for the disk-shaped CO_3^- which are to be substituted for the spherical

O^- , and we should then have the calcite lattice. It is a typical ionic lattice, differing only from the NaCl type in that one of the ions is a radical.

One would like to apply the radius ratio rule to the prediction of coordination numbers in radicals, but it is difficult to know the best numerical values to use for the radii. In the CO_3^- group, for example, the C-O distance is much less than the sum of ionic radii, and it is known that carbon and oxygen are not present as ions. The use of atomic radii is of no help, for on this basis $R_C:R_O = 0.77/0.60 > 1.0$, and it would be geometrically possible for eight or more oxygens to surround each carbon. The number of electron-pair bonds which any atom

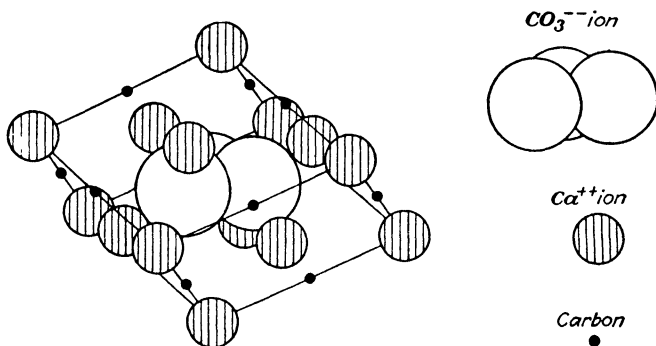

FIG. 6.—The calcite structure, showing the relative sizes of ions. (Reproduced by permission, from the *Encyclopaedia Britannica*.)

may form is limited by the maximum allowable number of electrons in the outer shell. For the radical-forming elements of the first short period (B, C, N, O), this is eight, and the coordination number of these atoms, therefore, cannot exceed four. But in considering the packing of oxygens about a small central atom like carbon, it must not be forgotten that the "effective radius," the extension in space of each oxygen in the direction in which it is not bonded to the central carbon, is considerably greater than half the internuclear C-O distance. There is a mutual repulsion of the oxygen atoms which must not be overlooked and which may reduce the stability of the radical. This mutual repulsion, then, may limit the number of oxygens which can be linked to the central atom and perhaps accounts for the existence of the CO_3^- radical rather than a CO_4 group.

A bothersome subject in elementary chemistry, so confusing that it is usually passed over hastily, is the question of the ortho and meta salts of the same acid-forming element. Thus, we speak of sodium orthophosphate, Na_3PO_4 , and sodium metaphosphate, NaPO_3 , both well known. Why then do we have only one nitrate, NaNO_3 , and no sodium orthonitrate Na_3NO_4 ? One reasonable answer has been suggested. In packing oxygens around a small nitrogen central atom, their mutual repulsion is so large that more than three are unstable. But phosphorus is larger and four surrounding oxygens need not approach each other so closely. Therefore, a stable PO_4^{-3} group is likely.

To carry the picture one step farther, thioarsenates, Na_3AsS_4 , are well known, although not particularly stable, but thio-phosphates are unknown. Now, the sulfur atom is larger than oxygen, and this probably explains why phosphorus cannot coordinate four sulfurs; but when the size of the central atom increases to that of arsenic, four sulfurs can be held, to form a stable group.

COMPLEX COMPOUNDS

Water, ammonia, and other molecules with permanent dipoles may be attracted and distorted by the strong electric field of an ion forming hydrates and ammoniates, complexes of the Werner type. Such a bond has been termed the "ion-dipole bond." Because of their stronger field, the 18-shell ions are more apt to form stable complexes, the bonds being partly covalent. The complex ion acts as a unit in a crystal just as do the radicals we have been discussing. For example, $\text{NiCl}_2 \cdot 6\text{NH}_3$ or $\text{Ni}(\text{NH}_3)_6\text{Cl}_2$, is isomorphous with CaF_2 . The $\text{Ni}(\text{NH}_3)_6^{++}$ groups occupy positions in the lattice corresponding with those occupied by the Ca^{++} in CaF_2 . Prussian Blue, $\text{FeFe}(\text{CN})_6$, probably the first complex compound with which the student of chemistry becomes familiar, has the NaCl structure. The lattice positions are filled by Fe cations and $\text{Fe}(\text{CN})_6$ anions.¹ In a later chapter we shall consider the structure and properties of these complex crystals.

¹ KEGGIN, J. F., and F. D. MILES, *Nature*, **137**, 577 (1936).

THE FIRST LAW OF CRYSTAL CHEMISTRY

Having considered the typical effects of polarization on crystal structure, let us modify the radius ratio rule, which was adopted only tentatively, and state what may be called the "first law of crystal chemistry": The structure of a crystal is determined by the relative numbers, the relative sizes and the polarization properties of its building stones, and by the type of bonds holding them together. The building stones may be atoms, ions, or radicals.

The following effects of polarization and the covalent bond on structure have been observed: For AX compounds, the interionic distances are reduced and the crystal structure may be changed to one of lower coordination number. For AX_2 compounds, the interionic distances are reduced, the structure may be changed to one of lower coordination number, and a layer lattice is usually formed. The covalent bond is involved in the formation of radicals, both the familiar acid radicals and the radicals of the complex Werner compounds.

THE PROPERTIES OF IONIC AND ATOMIC (HOMOPOLAR) CRYSTALS

We have seen how the arrangement of the building stones in crystals and the kinds of forces holding them together may be influenced. To the practical minded, crystal chemistry would appear much more useful if it revealed some relationship between the structure of crystals and their physical and chemical properties. Crystal chemistry does have a valuable contribution to make in this direction, and it is possible to formulate generalizations which minimize the necessity for memorizing the properties of solids and which permit the prediction of these properties.

Physical Properties. Isomorphism.—It is to be expected that chemically similar substances such as $BaCO_3$, $SrCO_3$, and $CaCO_3$ should have the same crystal structure; but for 150 years crystallographers have wondered about the numerous substances, very different chemically (*e.g.*, KNO_3 and $CaCO_3$, or $BaSO_4$ and $KMnO_4$) which also show similar crystal form. Substances which crystallize in similar forms are said to be isomorphous. From the first law it may be seen that if two compounds are to form similar crystals, they must have (1) the same type formulas;

(2) building stones, not necessarily of the same size, but at least of the same relative sizes; and (3) atoms or ions with somewhat the same polarization properties and joined by the same kinds of bonds. It therefore becomes evident why two substances as different as BaSO_4 and KMnO_4 should be isomorphous. There are the same relative numbers of atoms in each formula (note that the valences need not be the same). The radii of the "ions" are as follows:

Ba^{++}	1.43,	S^{+6}	0.34,	O^-	1.40
K^{++}	1.33,	Mn^{+7}	0.3,	O^-	1.40

The natures of corresponding bonds are the same in both; thus Ba-O and K-O bonds are essentially ionic, while S-O and Mn-O are covalent.

There are also many chemically similar compounds which are not isomorphous, and these have been difficult to explain. For example, many calcium and magnesium salts are not isomorphous, although very similar in chemical behavior. When it is noted, however, that the radius of Ca^{++} is 0.98, while that of Mg^{++} is 0.78, it seems quite natural that the substitution of one for the other without producing a change in structure is improbable.

In the case of the binary compounds, rather definite radius ratio limits have been established which, considered together with the influences of polarization and bond type, permit the prediction of crystal structure with reasonable accuracy. When we come to consider the problem of isomorphism among more complex compounds, however, the question arises as to just how much variation in ionic sizes can be tolerated before a change in structure is to be expected. To this query no definite answer can be given. Usually, if the ionic sizes differ by less than 10 to 15 per cent, it may be predicted with reasonable certainty that the compounds in question are isomorphous, providing the other known requirements are satisfied. For variations greater than this, predictions can be made only on a comparative basis. Considering the series MgCO_3 , SrCO_3 , and BaCO_3 , for example, it can be said that SrCO_3 (Sr^{++} , 1.27 A) is more likely to be isomorphous with MgCO_3 (Mg^{++} , 0.78 A) than is BaCO_3 (Ba^{++} , 1.43 A), but it could not be predicted with certainty that either one is necessarily isomorphous with MgCO_3 .

Polymorphism.---When the same compound may form two or more different type crystals, it is said to be polymorphic. We have seen that crystals may be changed from one form to another by changing the size of the building stones which make up the crystal. There are certain critical values of the ratios of these sizes at which the crystal form tends to change. In general, the polymorphic substances are those in which the $R_A : R_X$ values are near one of these critical values. It is then possible for conditions other than ionic sizes (*e.g.*, temperature or pressure) to affect the crystallization. Thus RbCl ($R_A : R_X = 0.82$) crystallizes like NaCl at ordinary pressures but like CsCl at high pressures. Consider also the two series of salts in Table 9. Only KNO_3 and CaCO_3 are polymorphic. The sizes of the ions in all the others give $R_A : R_X$ ratios too far from the critical value to permit any alteration to be brought about by secondary influences.

TABLE 9.—POLYMORPHISM

LiNO_3		
NaNO_3	MgCO_3	
KNO_3	CaCO_3	Calcite type
<hr/>		
KNO_3	CaCO_3	Aragonite type
	SrCO_3	
	BaCO_3	

The Strength of Ionic Crystals.---The size of the building stones and the nature of the bonds determine the structure of a crystal. The amount of electrical force holding the ions together determines its strength, as measured by hardness, melting point, solubility, heat of hydration, and many other properties.

The magnitude of the electrostatic force between ions is determined by the valence of the ions and the distance between them in the crystal lattice; the farther apart the particles lie, the weaker is the force attracting them toward each other. Table 10 illustrates the effect of interionic distance upon the strength of ionic crystals. The hardness is compared with this distance for the oxides, sulfides, selenides, and tellurides of magnesium and the alkaline earths, and the melting points of the oxides are also shown. It is evident that as the distance between the building stones increases, the crystals become weaker.

TABLE 10.—THE INFLUENCE OF INTERIONIC DISTANCES ON THE STRENGTH OF IONIC CRYSTALS*

	Mg ⁺⁺	Ca ⁺⁺	Sr ⁺⁺	Ba ⁺⁺	
O ⁻	2.10	2.40	2.57	2.77	Distance, A
	6.5	4.5	3.5	3.3	Hardness, Moh's
	2800	2570	2430	1933	Melting point, °C.
S ⁻	2.59	2.84	3.00	3.18	Distance, A
	4.5-5.0	4.0	3.3	3.0	Hardness, Moh's
Se ⁻	2.74	2.96	3.12	3.31	Distance, A
	3.5	3.2	2.9	2.7	Hardness, Moh's
Te ⁻		3.17	3.32	3.49	Distance, A
		2.9	2.8	2.6	Hardness, Moh's

* Distances and hardness from V. M. Goldschmidt, *Trans. Faraday Soc.*, **25**, 253 (1929).

When the interionic distances remain constant but the valences increase, thereby increasing the forces holding the building stones together, the strength of the crystals increases, as may be seen from the comparison of hardness, melting point, solubility, and compressibility of the series of compounds shown in Table 11.

TABLE 11.—THE INFLUENCE OF THE SIZE OF THE ELECTROSTATIC CHARGE ON THE STRENGTH OF AN IONIC CRYSTAL

	NaF	MgO	ScN*	TiC*
Distance, A.....	2.31	2.10	2.23	2.23
Hardness, Moh's.....	3.2	6.5	7-8	8-9
Melting point, °C.....	992	2800		3180
Solubility, g./100 cc. cold.....	4.0	0.00062	Insol.	Insol.
Compressibility.....	High			Low

* These two are probably not ionic crystals, although they have the NaCl structure.

The Strength of Atomic Crystals.—Diamond is an atomic crystal, one in which the carbon atoms are held together by shared electron pairs. It is one of the strongest substances known, as measured by hardness (10 on Moh's scale), refractivity, melting point, and other properties. Silica is another typical atomic crystal, and its strength is well known.

Those crystals, however, in which the bond is part ionic and part covalent seem to be characteristically weak. Consider the group of compounds compared in Table 12. Both the magnitude of the electrostatic charges and the distance between ions remain the same but the coordination number changes.

TABLE 12.—THE INFLUENCE OF AN INTERMEDIATE BOND TYPE ON THE STRENGTH OF AX CRYSTALS

	AgI	NaCl	CuI	LiCl	ZnS	CaO
C.N.	4	6	4	6	4	6
A-X distance.....	2.81	2.81	2.62	2.57	2.35	2.40
Hardness, Moh's.....	1.5	2.5	2.4	3.0	4.0	4.5
Melting point, °C.....	526	805	1049	2570

The weakness of the ZnS structure may be associated with a loosening of the bond. Other interesting properties characteristic of this loosened bond are discussed in Chap. VI.

Acids and Bases.—Recalling the nature of radicals already described, we may make an interesting and useful generalization in regard to one criterion for acid-forming and base-forming elements. Those elements whose ions are large, say with radii greater than about 0.70 Å, and whose ionization potentials are therefore low tend to play the role of cations; they are basic in character. The small ions, with radius less than 0.55 Å will, as we have seen, tend to form covalent bonds with the negative ions, building acid radicals. It is evident, then, why an element gets less metallic and more acidic as its valence increases. The decrease in size and increase in charge as the valence of a potential ion of a given element increases are accompanied by an increase in ionization potential, favoring the formation of a covalent bond with the electronegative element present. Thus, while the Cr^{+3} is formed rather easily and may therefore act as cation in $\text{Cr}_2(\text{SO}_4)_3$, the potential required to form the Cr^{+6} is almost prohibitive. In the higher valence therefore, chromium forms electron-pair bonds and the stable CrO_4^- group. Of course, it is now obvious that those ions which are intermediate in size are the amphoteric ions, their behavior as acid or basic ions being determined largely by the size and charge of the ions with which

they must compete. For example, when Al^{+3} (0.57 Å) and S^{+6} compete for oxide ions, the S^{+6} having the higher ionization potential will form an acid radical. But if Al^{+3} competes with Na^+ , the former may attract the oxygens, and sodium aluminate is formed. The Al-O bond in the aluminate is doubtless more ionic than the S-O bond in sulfate, and the aluminate radical is not particularly stable.

MOLECULAR CRYSTALS

A few inorganic substances form crystals in which the molecule retains its identity as a building unit. Carbon dioxide (Fig. 4) is

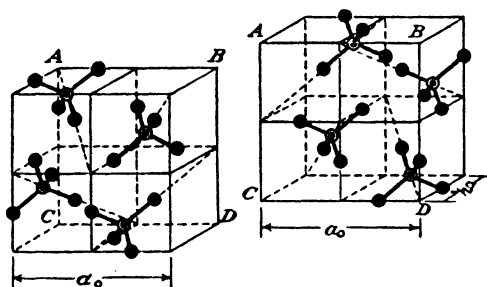

FIG. 7.—The SnI_4 unit cube, shown in two parts. The iodine atoms (black dots) are arranged tetrahedrally around tin atoms (ringed dots). This is a molecular structure. (Reproduced from Wyckoff, "The Structure of Crystals," by permission of the Reinhold Publishing Corporation, New York.)

an example of a molecular crystal. SnI_4 (Fig. 7) is another very common one.

Most organic substances form molecular crystals. Sugar, for example, forms as beautiful, transparent crystals as does sodium chloride, but the building stones are molecules of sucrose. This means that large organic molecules form crystals with very large unit cells. The molecules are, of course, neutral, and the carbon atoms being effectively screened by negative atoms, only weak molecular or van der Waals' forces are available to hold the building stones together in the crystal.

SUMMARY

The important features of this introduction to crystal chemistry are:

1. The structure of a crystal is determined by the relative numbers, the relative sizes and the polarization properties of its building stones, and by the nature of the bonds between them. The building stones may be atoms, ions, radicals, or molecules.

2. Ionic crystals are built of ions, either elements or radicals, held together by forces essentially ionic; while the forces within ion radicals are more nearly covalent. Homopolar or covalent crystals are built of atoms, held by electron-pair or covalent bonds. Binary crystals with C.N. 8 and 6 are generally ionic; those with C.N. 4 are apt to be homopolar or intermediate in type, the bond being predominantly covalent.

In complex compounds neutral molecules may be coordinated to a positive or negative group by ion-dipole or by covalent bonds.

Molecular crystals are built of neutral molecules and the bonds are weak van der Waals' forces.

3. The strength of crystals, as evidenced by melting points, hardness, solubility, and other properties depends upon the magnitude of the forces within them. Molecular crystals are weak as compared with ionic and homopolar crystals.

The attempt has been made, not to present a complete picture of crystal chemistry, but rather to offer a few suggestive sketches of what may be expected as we move forward. The discussion has been limited to the broad concepts which govern the structure and properties of those types of compounds with which we are most familiar. In subsequent chapters these same concepts will be applied to a discussion of the structure and properties of metals and alloys and the metallic state, without which even an elementary treatment of the subject is incomplete, and to the less familiar and more complex compounds.

Admittedly, we have, until now, presented the generalizations of crystal chemistry in ideal surroundings and have used hand-picked data to illustrate them. One who hopes to find them applicable in every case will be somewhat disappointed. We shall find data which appear to be inconsistent with the general concepts. We shall discover, however, that when additional influences are taken into account, influences which limit or modify these general ideas, many of these data are entirely logical. On the whole, we shall find that apparent inconsistencies which

cannot, as yet, be reconciled with our principles, are submerged by an overwhelming majority of data which are in accord with these principles.

In brief, the aim in the construction of this first outline has been to lay a foundation which shows signs of permanence. As we proceed from this point we shall not hesitate to add detail concerning which there may be considerable disagreement at the present time and which may have to be altered as new facts come to light. Regardless of the detailed character of the superstructure, we may build with every reasonable assurance that the broad foundation upon which it is built will not give way beneath it.

CHAPTER II

THE SIZES OF ATOMS AND IONS

Since it is already evident that the approach to the arrangement of atoms or ions in solids depends in large measure upon their relative sizes, it is only proper that before proceeding farther the various methods for determining atomic and ionic radii be considered. It is well to know the degree of accuracy of the data upon which so much depends.

Until recently the building blocks in crystals were pictured as more or less rigid spheres or billiard balls, and the terms "ionic radius" and "atomic radius" had very real meanings. But wave mechanics has changed the general conception of an atom or ion. Certainly it is no longer a sphere with a definite and constant radius in the usual sense. *Its size now depends upon the method used to investigate it and upon the environment in which it finds itself.* The factors which influence the size of an ion or atom will be discussed in the following pages. It is still permissible to use the term "ionic or atomic radius," provided the circumstances of its determination are defined. In a given crystal, the distance between the centers of neighboring atoms or ions is an unambiguous value from which the radii of the atoms or ions may be derived. That is, the radii are those values which, when added together, should equal the interatomic or interionic distances in crystals. Thus, the distance Na-Cl (2.814) in the sodium chloride crystal should be the sum of the radii of Na^+ (0.98) and Cl^- (1 + 81).

Sollas was one of the first to realize the importance of the size of the units in crystal building. "In the study of molecular volumes we hold the key which is destined to unlock the secret of crystal structure so long concealed."¹ His picture of a crystal was essentially the same as the view held today. He conceived of a sodium chloride crystal as being made from spheres packed

¹ SOLLAS, W. J., *Proc. Roy. Soc. (London)*, **26**, 286 (1899).

in a cubic structure and touching each other. To him, however, the building units were sodium chloride molecules. He pointed out that if the molecules were to be close packed in a cubic arrangement, they must lie alternately end to end, as in Fig. 8. That is, he realized that the sodium and chloride ions must be of different sizes. The radii of the atoms were determined by applying Kopp's ideas concerning molecular volumes. Furthermore, Sollas observed that "it is quite certain that . . . the volume of sodium and other alkali metals is very different in the free state and in combination."¹

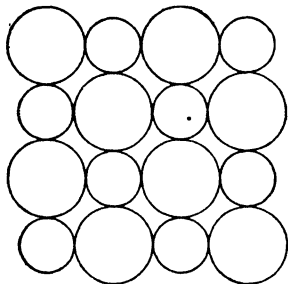

FIG. 8.—The packing of NaCl molecules in a NaCl crystal, as visualized by Sollas in 1898.

Some of the radii Sollas determined are shown in Table 14. In view of the fact that his work preceded by fifteen years the first experimental confirmation of his picture of a crystal as built of touching spheres, the relationships between atomic volumes and structure which he worked out are truly remarkable. He suggested, for example, that there "does not seem to be any sound reason why the volume of an element should remain absolutely constant and independent of an element with which it is associated." Twenty-five years later, after a host of investigators had been publishing ionic radii, it was still necessary for Wyckoff to amass a convincing array of crystallographic data to drive home this very point.²

In 1920 came a veritable avalanche of reports on the sizes of atoms and ions. W. L. Bragg,³ regarding a crystal as an assemblage of tightly packed spheres, calculated the radii of these spheres by an empirical treatment of X-ray diffraction data. His method has been generally adopted since then and may be profitably considered in some detail.

For example, if the interionic distances for the alkali halides are tabulated as in Table 13, it is seen that the replacement of fluoride by chloride always increases the interatomic distance by

¹ *Ibid.*, p. 274.

² WYCKOFF, R. W. G., *Proc. Natl. Acad. Sci.*, **9**, 33 (1923).

³ BRAGG, W. L., *Phil. Mag.*, **40**, 169 (1920).

approximately 0.50 Å, indicating, of course, that the radius of the chloride ion is about 0.50 Å greater than the radius of the fluoride ion. Likewise bromide is about 0.15 Å greater than chloride and

TABLE 13.—INTERIONIC DISTANCES IN THE CRYSTALLINE ALKALI HALIDES*

Halides	Li Δ	Na Δ	K Δ	Rb Δ	Cs
F	2.01 0.30	2.31 0.35	2.66 0.16	2.82 0.19	3.01
Δ	0.56	0.50	0.48	0.45	0.56
Cl	2.57 0.24	2.81 0.33	3.14 0.13	3.27 0.30	3.57
Δ	0.18	0.16	0.15	0.15	0.14
Br	2.75 0.22	2.97 0.32	3.29 0.13	3.42 0.29	3.71
Δ	0.27	0.26	0.24	0.24	0.24
I	3.02 0.21	3.23 0.31	3.53 0.13	3.66 0.29	3.95

* The table is from V. M. Goldschmidt, *Skrifter Norske Videnskaps-Akad. Oslo*, no. 2, p. 16, 1926. Bragg used the same sort of table, but the interatomic distances in the lithium and cesium halides had not all been determined at that time.

iodide about 0.25 Å greater than bromide. In a similar manner the relative radii of all the alkali ions may be estimated. To get the absolute values for the radii of all the halogen and alkali ions, therefore, it is only necessary to know the absolute value of any one of them and the others may be determined from the relative values as deduced from the comparison.

Obviously, this substitutional method used in a series of crystals of known structure permits the calculation of the entire list of atomic radii, but the correctness of the values depends entirely upon, (1) the accuracy of the original absolute value which is chosen as a starting point, and (2) the constancy of the ionic radius of each element throughout the series of substitutions. Unfortunately the absolute value chosen by Bragg as the starting point was later shown to be in error, and the possibility of appreciable variations in ionic radii was not recognized. Although this first attempt did not lead to correct values for the ionic radii, the method of comparison was a very important contribution. The actual values obtained were easily corrected when a suitable starting point was found, as will be shown later.

Meanwhile, in 1920, several methods were employed in the attempt to determine the absolute radii of the alkalis and halogens. Lorenz¹ has summarized these and discussed them criti-

¹ LORENZ, RICHARD, *Z. Physik*, 6, 271 (1921).

cally. At about this time, Lande¹ obtained the absolute radius of an ion for a starting point by a rather ingenious method. He reasoned that there must be so large a difference in diameter between the Li⁺ and I⁻ that when the two are packed in the NaCl structure, as they are in LiI, the I⁻ will touch each other and the comparatively small Li⁺ will rattle around in the interstices. The face diagonal of the unit cell, then, will equal twice the diameter of an iodide ion, and the radius of the iodide ion was found by Lande to be 2.05 Å. From this, by the comparative method of Table 13, he was able to determine the radii of all the alkali and halogen ions, except lithium. Comparisons given in Table 14 make it plain that Lande's radii came closer to the values accepted today than most of the others determined at that time.

In this country the question of ionic radii was attacked by Davey² and by Wyckoff.³ The latter, using Bragg's empirical method of comparing radii showed conclusively that atoms do not have constant radii in all types of crystals, although, within a given crystal type, the radii do remain essentially constant.

As a matter of historical interest a few of the radii calculated by these earlier investigators are compared in Table 14 with the most recent values available.

TABLE 14.—SOME IONIC RADII OF HISTORICAL INTEREST

Li ⁺	Na ⁺	K ⁺	Rb ⁺	Cs ⁺	F ⁻	Cl ⁻	Br ⁻	I ⁻	Observer
0.94	1.14	1.42	1.25	1.40	1.60	Sollas 1898
0.87	0.97	1.20	1.31	1.48	Heydweiller*
	0.57	0.79	0.91	Fajans and Herzfeld†
	1.10	1.45	1.65	1.60	1.20	1.65	1.80	2.05	Lande‡
	1.77	2.07	0.67	1.05	Bragg
	1.25	1.56	1.73	1.98	1.13	1.56	1.73	1.98	Davey
0.68	0.98	1.33	1.48	1.67	0.62	1.08	1.24	1.50	Wyckoff
					1.33	1.81	1.96	2.19	Zachariasen 1931

* HEYDWEILLER, A., *Z. Physik*, **1**, 393 (1920).† FAJANS, K., and K. F. HERZFELD, *Z. Physik*, **2**, 322 (1920).‡ LANDE, A., *Z. Physik*, **1**, 194 (1920).¹ LANDE, A., *Z. Physik*, **1**, 191 (1920).² DAVEY, W. P., *Phys. Rev.*, **17**, 402 (1921); **18**, 102 (1921).³ WYCKOFF, R. W. G., *Proc. Natl. Acad. Sci.*, **9**, 33 (1923).

It is no wonder that systematic crystal chemistry could make so little real progress when the factor upon which it depends so strongly—the size of the building stones—remained in such uncertainty.

Recent Methods for the Estimation of the Most Reliable Ionic and Atomic Radii.—In 1922 Wasastjerna¹ calculated a number of ionic radii from their molecular refraction on the basis of the Lorenz-Lorentz relation and obtained values which have since been shown independently to be correct.

Then Goldschmidt² using the absolute values determined by Wasastjerna for fluoride and oxide ions ($F^- = 1.33$, $O^- = 1.32$) worked out a most complete set of ionic and atomic radii by the substitutional method first employed by Bragg. Goldschmidt and his students had been working for many years in an effort to discover the laws governing the structure of crystals and had amassed a wealth of data which, added to the data so completely summarized by Wyckoff,³ afforded them an ideal opportunity to work out the ionic radii by this empirical method. Starting with the univalent ions, they set up a table of the alkali halides (reproduced in Table 13) and, having the true radius for fluoride, were able to determine accurate radii for all the other ions represented. From this point on it was necessary to proceed with caution, *comparing only those crystals which were known to be ionic*. They recognized, for example, that ionic radii could not be calculated from crystals of the zinc sulfide type, since there was reason to believe that these crystals are built of atoms rather than ions. To this very careful selection of known *ionic* crystals for the calculation of *ionic* radii is due the remarkable accuracy and usefulness of the results obtained. Crystals whose building stones are particles in the same condition, *e.g.*, ions, are known as commensurable crystals; but ionic crystals are said to be incommensurable with atomic crystals. Crystals of most of the elements are spoken of as being commensurable with crystals of the

¹ WASASTJERNA, J. A., *Soc. Sci. Fennica, Commentationes Phys.-Math.*, **1**, art. 38 (1923); *Z. physik. Chem.*, **101**, 193 (1922).

² GOLDSCHMIDT, V. M., *Skrifter Norske Videnskaps-Akad. Oslo*, no. 2, (1926), no. 8, (1927); *Ber.*, **60**, 1263 (1927); *Trans. Faraday Soc.*, **25**, 253 (1929).

³ WYCKOFF, R. W. G., "The Structure of Crystals," 2d ed., Reinhold Publishing Corporation, New York, 1930.

zinc sulfide type, meaning that both are built from particles which are more nearly atomic than ionic. It follows, then, that when the radius of an element is determined experimentally from any given crystal type, this value may be used (to a first approximation) in all other crystal types commensurable with the crystal used as the source of the value, but it cannot be used in crystals incommensurable with the original type. For example, the radius of Cd, determined from the *ionic* CdO crystal, is inapplicable to Cd in the *atomic* CdS crystal. Goldschmidt was the first to recognize the significance of this principle, and he applied it consistently. Of the silver halides only AgF is truly commensurable with the alkali halides. The true ionic radius of silver, therefore, can be obtained empirically only from this halide. The radius of Cu^+ could not be determined definitely because no ionic crystals of this ion had been analyzed.

From the univalent ions Goldschmidt proceeded to the divalent. Table 15, similar to that for the alkali halides, was set up to compare the interionic distances in the divalent oxides, sulfides, selenides, and tellurides and, starting with the absolute value for oxygen (1.33 A), the radii of these ions listed in Table 15 were determined.¹

TABLE 15.—INTERIONIC DISTANCES IN CERTAIN ALKALINE EARTH COMPOUNDS

	Mg	Δ	Ca	Δ	Sr	Δ	Ba
O	2.10	0.28	2.38	0.21	2.59	0.16	2.75
Δ	0.44		0.42		0.34		0.42
S	2.54	0.26	2.80	0.13	2.93	0.24	3.17
Δ	0.18		0.16		0.19		0.14
Se	2.72	0.24	2.96	0.16	3.12	0.19	3.31
Δ					0.12		
Te		Approx.	3.05		3.24		

Again, only those substances with ionic structures could be safely included. For this reason, Goldschmidt was unable to determine radii for Cu^{++} , Sn^{++} , and Ge^{++} since no ionic crystals of compounds of these ions had been investigated.

¹ GOLDSCHMIDT, V. M., *Skrifter Norske Videnskaps-Akad. Oslo*, no. 2, p. 20, 1926.

With the trivalent elements the task became increasingly difficult because in almost every instance there is grave doubt as to the ionic character of crystals of these elements. In some cases the radii of the ions could be estimated by interpolation, as in the case of Sc^{+3} and Y^{+3} . By interpolating in the series

K^+	Ca^{++}	Sc^{+3}	Ti^{+4}	and	Rb^+	Sr^{++}	Y^{+3}	Zr^{+4}
1.33	1.06	0.64		1.49	1.27	... 0.87	

the values $\text{Sc}^{+3} = 0.83 \text{ \AA}$ and $\text{Y}^{+3} = 1.06 \text{ \AA}$ were predicted. Soon after, the structures for Sc_2O_3 and Y_2O_3 were determined, and the radii of these ions in the crystals were found to be $\text{Sc}^{+3} = 0.84\text{-}8$ and $\text{Y}^{+3} = 1.02\text{-}6 \text{ \AA}$, very reassuring confirmations of the predicted radii. The radii for the rare earths were found by interpolating between known limits by a method suggested by Grimm.¹

The ionic radii determined by Goldschmidt are recorded in Table 122 in the Appendix.

At about the time of the publication of these values of Goldschmidt, appeared a table of ionic radii calculated independently by Pauling on the basis of wave mechanics.² The numerical values obtained are in remarkable agreement with the empirical data of Goldschmidt, and have placed the crystal chemistry of ionic crystals on a firm foundation, that of reliable and reasonably accurate ionic radii. While the details of Pauling's calculations are beyond the scope of this book, there are many useful conceptions brought out which should be reviewed briefly.

In the first place, the wave mechanics changes our mental picture of an atom. We can no longer think of rigid spheres, nor indeed of units of any shape having finite dimensions. As Pauling says,

The hydrogen atom consists of a nucleus embedded in a ball of negative electricity—the electron distributed through space. This may be considered as an actual stationary distribution of the individual electron throughout space, following Schrödinger; or as a time average of all the positions assumed by a point electron. The atom is spherically symmetrical. The electron density is greatest at the nucleus and decreases exponentially as r , the distance from the nucleus, increases. It remains finite, however, for all finite values of r , so that the atom extends to

¹ GRIMM, H. G., and H. WOLFF, *Z. physik. Chem.*, **119**, 254 (1926).

² PAULING, LINUS, *J. Am. Chem. Soc.*, **49**, 765 (1927).

infinity; the greater part of the atom, however, is near the nucleus—within 1 or 2 Å.

This same general description applies to atoms other than hydrogen in which there are a number of electrons outside of the nucleus. Naturally, when the number of electrons around the nucleus increases, as it does for elements of higher atomic number, this sphere of influence extends farther from the nucleus and the effective size of the atom is greater. It is helpful, then, to be reminded of the electronic structure of the elements, as listed in Table 124, in the Appendix.

Following the general line of reasoning employed for the hydrogen atom a model for a many-electron atom can be developed. It is really the electrons in the outermost shell which have the greatest influence upon the size of the atom or ion. The distance from the nucleus of these outer electrons will depend upon the strength with which they are attracted toward the nucleus. The stronger the attraction of the nucleus for the outer electrons, the nearer will they approach this nucleus and the smaller will be the sphere of influence of the atom or ion. There are two factors which determine the strength of the attraction of the nucleus for the outer electrons. One, of course, is the nuclear charge. But before the attractive force of this charge reaches the outermost electrons, it must penetrate a region of negative charge, the inner electrons. These will absorb much of the positive charge, and the effective nuclear charge which finally emerges to attract the outer electrons will be less, the greater the density of the electrons it must penetrate. This influence of the inner electrons upon the positive charge Ze , where Z is the atomic number and e is the charge of an electron, is known as the screening effect S_s and the effective nuclear charge is given by the expression $(Z - S_s)e$.

In Fig. 9, is shown the electron distribution for the sodium and chloride ions as a function of the radius (r). Although the old picture of electrons moving in regular orbits has been entirely abandoned, we may see in the maxima of these curves the semblance of the electron shells, familiar in the old conception. The chloride ion, for example, becomes a nucleus embedded in a small ball of electricity consisting of the K electrons and a trace of L and M electrons, surrounding which are two concentric

shells containing essentially the eight *L* and the eight *M* electrons. The shells are more or less sharply demarcated. The shape of the curves in Fig. 9 illustrates very clearly how the inner electrons, *K* and *L* are drawn in toward the nucleus by the increasing charge ($\text{Na} = 11$, $\text{Cl} = 17$). Also, it may be observed that the screening effect of the *K* and *L* electrons cuts down the effective nuclear charge considerably so that the *M* electrons in the Cl^- are relatively diffuse. Pauling has derived a set of

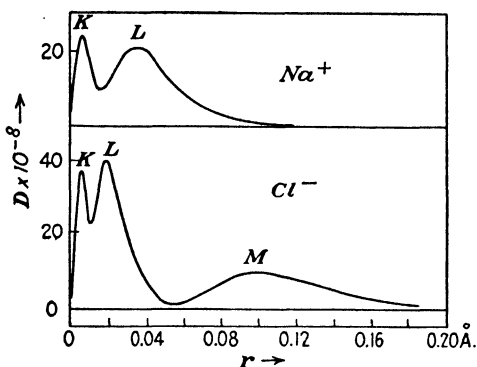

FIG. 9.—The electron distribution, $D = 4\pi r^2 \rho$, as a function of r , for the Na^+ and Cl^- . [Pauling, *J. Am. Chem. Soc.*, **49**, 768 (1927).]

screening constants to be used in calculating the effective size of ions.¹

For similar many-electron ions the electron distribution is similar, but the equivalent radii are inversely proportional to the corresponding nuclear charges. To illustrate, the electron distribution and radii of Cl^- , A , and K^+ are as follows:

Ion (atom)	Nuclear charge	Electron distribution			Radius, A
		K	L	M	
Cl^-	17	2	2-6	2-6	1.81
A	18	2	2-6	2-6	1.54
K^+	19	2	2-6	2-6	1.33

¹ PAULING, LINUS, *Proc. Roy. Soc. (London)*, **A 114**, 181 (1927).

Potassium, for example, having the strongest nuclear charge, tends to pull the M electrons (see Table 124 in the Appendix) closest to its nucleus, while in chloride, the outer electrons are subjected to a much weaker pull toward the nucleus. The influence of these electrons, therefore, extends farther from the nucleus. Applying this principle, and with the aid of suitable screening constants, ionic radii may be obtained.

Even with this theoretical method of determining ionic radii a starting point must be selected, based on experimental data. Pauling selected the interionic distances for normal¹ crystals of the sodium chloride structure, *viz.*, $\text{Na}^+ - \text{F}^- = 2.31$, $\text{K}^+ - \text{Cl}^- = 3.14$, $\text{Rb}^+ - \text{Br}^- = 3.43$, $\text{Cs}^+ - \text{I}^- = 3.85$ Å (obtained by subtracting 3.0 per cent from the experimental distance in the crystal with the CsCl structure. See page 49). The value for Li^+ , 0.60 Å, obtained from the experimental data for Li_2O , was also assumed.

Starting with the interionic distances as listed above, and with the use of the proper screening constants, dividing these distances between the two ions concerned, the radii for all the alkali and halogen ions may be obtained. The radii for other ions with similar structures are calculated in the same manner—by assuming them inversely proportional to the effective nuclear charge. This gives the so-called “univalent radii” of the ions. They are not to be used in actual interionic distances in crystals but are a measure of the relative extension in space of ions of a given electronic structure. Pauling’s univalent radii are listed in Table 123, in the Appendix.

In estimating the size of an ion in a crystal, its relation to its neighbors must also be considered. It had been assumed by earlier investigators that the repulsive force between ions, the force which prevents two ions of opposite charge from coming closer together than they do, is the result of deformation. On the basis of the wave mechanics, however, repulsion is assumed to result simply from the interpenetration of the two ions. When the attractive force of the oppositely charged ions and the repul-

¹ A normal crystal is one in which contact (strong repulsion) occurs only between adjacent anions and cations and in which there is only so much deformation as that shown by the alkali halides. These are the characteristic ionic crystals selected by Goldschmidt.

sive force of the two positive nuclei reach equilibrium, the distance between the ions is defined. These so-called "repulsion exponents" n for each of the rare gases, which may also be used for ions of corresponding configuration, may be derived from experimental measurements of the compressibility of crystals and have been worked out by Born¹ and by Herzfeld² as listed in Table 16.

TABLE 16.—REPULSION EXPONENTS

Crystal	n (Born)	n (Herzfeld)	n	Rare gas ion	n
NaCl	7.84	9.1	8	He	5
NaBr	8.61	9.5	8.5	Ne	7
NaI	8.45	9.5	Ar, Cu ⁺	9
KF	7.9	8.0	Kr, Ag ⁺	10
KCl	8.86	9.7	9.0	Xe, Au ⁺	11
KBr	9.78	10.0	9.5		
KI	9.31	10.5	10.5		
RbBr	10.0	10.0		
RbI	11.0	11.0		

For the rare gases and ions of like configuration, Pauling uses values of n as listed in the last column, which are approximate averages of the proper values taken from the other data. If these last column values are averaged, the values in column four result, and their agreement with the experimental values justifies the values used for the rare gases. There are no data available to check the values adopted for the 18-shell ions. Pauling notes that, although there are ten $M_{32}M_{33}$ electrons in the outer shell of Cu⁺ and only six $M_{21}M_{22}$ in ions with the argon configuration, the density per electron is smaller in the outer portion of the $M_{32}M_{33}$ group than near the center and so the comparative sizes which have been adopted are probably justified.

The actual ionic radii in a crystal may be obtained from the expression $R_s = R_1(z_1z_2)^{\frac{2}{n-1}}$, where R_s = actual ionic radius, R_1 = univalent radius (for use in normal NaCl type crystals

¹ BORN, MAX, *Eng. math. Wiss.* (V) 25, p. 735.

² HERZFELD, K. F., "Handbuch der Physik," vol. XXII, p. 454, Julius Springer, Berlin, 1926.

only), n = repulsion exponent and z_1 and z_2 are the valences of cation and anion, respectively.

Pauling recognizes the fact that "since every atom extends to an unlimited distance it is evident that no single characteristic size can be assigned to it. Instead the apparent atomic radius will depend upon the physical properties concerned and will differ for different properties." Pauling's crystal radii are shown in Table 122 in the Appendix, and, since they have been calculated for normal crystals of the NaCl type, they are comparable to Goldschmidt's values.

Recently Zachariasen¹ has proposed a set of empirical ionic radii for ions with the noble gas configuration which are claimed to be more accurate than those of Goldschmidt. Univalent radii are used as a basis for the estimation of the actual radii in any particular crystal. In this way corrections are made for the influence of the environment or coordination effect of an ion upon its radius in a specific case, and there is no claim that a standard radius can be assigned to a given ion for use in all cases. The most important factors included in the coordination effect are: coordination number, valence or coulomb force, radius ratio. These are discussed in a little more detail in the next section.

Zachariasen's univalent radii, derived empirically from suitably corrected interionic distances are compared in Table 123 in the Appendix, with the univalent radii of Pauling derived theoretically. It is interesting to observe that the two show the best agreement for the small valences. The lack of agreement for the larger valences may result from the fact that the bond is not entirely ionic in these cases, as has been assumed in the derivations. The same difficulty encountered by Goldschmidt occurs in a slightly different form. Goldschmidt found a scarcity of trivalent ionic compounds from which to determine his empirical ionic radii; Zachariasen, having calculated true ionic radii for trivalent ions, questions the advisability of applying them to actual trivalent crystals. From the univalent radii in Table 123 the radius for each ion having a C.N. 6 in binary compounds AX may be calculated with the aid of formulas on page 50. These values will be most nearly comparable to the general values

¹ ZACHARIASEN, W. H., *Z. Krist.* **80**, 137 (1931).

of Goldschmidt and Pauling and are given in Table 122 in the Appendix.

Table 122 thus includes three sets of ionic radii, all three intended for use in ionic crystals characterized by the C.N. 6. Goldschmidt's are determined empirically from the experimental interionic distances; Pauling's derived theoretically from wave mechanics, using certain well-known experimental values as a starting point; Zachariasen's derived from experimental interionic distances which have first been corrected for known coordination effects. A comparison of these three sets affords some idea of the degree of accuracy with which ionic radii are known. It is quite evident that, as has been implied throughout our discussion, radii of the univalent ions are most accurately known, and the values become more uncertain as the valence of the ions increases. This trend suggests that, as the valence increases, the tendency to form the ionic bond between the building stones in a crystal decreases.

To clarify further our mental picture of the radius of an ion, certain relationships may be observed between the electronic structure of an atom or ion, as listed in Table 124 in the Appendix, and its radius. Since, the outermost electrons of an atom or ion finally establish its radius or the distance from the nucleus to which its sphere of influence extends, it follows that:

1. The positive ion of an element is always smaller than the neutral atom of the same element, since the positive ion has lost the outermost electrons of the atom. To illustrate:

Potassium Atom, K	Potassium Ion, K ⁺
Electronic structure.....	2-8-8-1
Radius, A.....	2.31
	2-8-8
	1.33

2. The negative ion of an element is always larger than the neutral atom of the same element, since electrons have been added to the valence shell. To illustrate

Chlorine Atom, Cl	Chloride Ion, Cl ⁻
Electronic structure.....	2-8-7
Radius, A.....	0.97
	2-8-8
	1.81

3. For an element which may exist in several valence states, the higher the positive valence, or the lower the negative valence, the smaller will be the radius of the ion. Thus:

Element.....	Pb	Pb ⁺⁺	Pb ⁺⁴
Electronic structure.....	2-8-18-32-18-4	2-8-18-32-18-2	2-8-18-32-18
Radius, A.....	1.74	1.32	0.84
Element.....	Te ⁺⁴	Te	Te ⁻
Electronic structure.....	2-8-18-18-2	2-8-18-18-6	2-8-18-18-8
Radius, A.....	0.89	1.33	2.03

4. When the number of electrons in the outer shell remains the same in a series of ions, but the atomic number (and therefore the nuclear charge) changes, then, as we have seen from Pauling's theoretical treatment, the radius or sphere of influence of the ions decreases with increasing atomic number. For example:

Element.....	K ⁺	Ca ⁺⁺	Sc ⁺³	Ti ⁺⁴	V ⁺⁵	Cr ⁺⁶
Nuclear charge.....	19	20	21	22	23	24
Electronic structure.....	2-8-8	2-8-8	2-8-8	2-8-8	2-8-8	2-8-8
Ionic radius, A.....	1.33	0.98	0.78	0.62	0.59	0.52

However, the relation is not quite so obvious when it is carried a little further. Consider the following:

Element.....	S ⁻	Cl ⁻	A	K ⁺	Ca ⁺⁺
Atomic number.....	16	17	18	19	20
Electronic structure.....	2-8-8	2-8-8	2-8-8	2-8-8	2-8-8
Radius (Goldschmidt).....	1.74	1.81	1.91	1.33	0.98
(Pauling).....	(1.85)				

As in the series K⁺, Ca⁺⁺, Sc⁺³, Ti⁺⁴, V⁺⁵, S⁺⁶, all have the same electronic structure, and the nuclear charge decreases from Ca⁺⁺ to S⁻. The ionic radius might be expected to increase from Ca⁺⁺ to S⁻, but it increases only to argon and then decreases. It would appear that S⁻, with a smaller nuclear charge, should be larger than Cl⁻. As a matter of fact, the calculated value for the radius of S⁻ is, according to both Pauling and Zachariasen, larger than that for the Cl⁻. Why is Cl⁻ found to be larger than S⁻ in

actual crystals? When the S^{2-} occurs in a crystal lattice of the NaCl type, surrounded by divalent positive ions, the attraction of positive for negative is greater than the attraction of positive for negative when the ions are only univalent, and the divalent ions are drawn closer together by this stronger electrostatic pull. In the crystals KCl and CaS, for example, the building stones have the same electronic structures but in CaS these ions are drawn together by a stronger force than are the ions in KCl. The effect upon the interionic distances is shown in Table 17.

TABLE 17.—EFFECT OF ELECTROSTATIC CHARGE UPON INTERIONIC DISTANCES

Ion	Atomic number	Electronic structure	Electrostatic attraction	Crystal	Interionic distance, A
K^+	19	2-8-8	1	KCl	3.14
Cl^-	17	2-8-8	1		
Ca^{++}	20	2-8-8	2	CaS	2.84
S^{2-}	16	2-8-8	2		

The influence of valence on ionic radii is developed further in the next section. It follows now that even though the atomic number of argon is higher than that of Cl^- , the experimental radius of argon should be greater. In crystalline argon the building stones are neutral atoms; there is no electrostatic attractive force operating between them; rather, the outer electrons of neighboring atoms actually tend to repel each other and keep the atoms abnormally far apart in the lattice.

The Lanthanide Contraction.—In the series of rare earths, the outer electronic structure of the ions remains the same, while their atomic numbers (nuclear charges) increase progressively from La (at. no. 57) to Lu (at. no. 71). A progressive decrease in the ionic radii may be anticipated and does occur, but the situation is not quite the same as that described above for the series $K^+ \dots Cr^{+6}$. The rare earth series differs in that all of these elements have the same valence, and for each increase in nuclear charge, there must be added one electron outside the nucleus. As may be seen in Table 124 in the Appendix, it is the fourth quantum shell which gains the electron. This additional inner electron exerts a screening effect upon the added nuclear charge

and prevents the full force of the larger nuclear charge from contracting so strongly the outermost electrons which determine the effective radius of the ion. The radii of the rare earth ions, therefore, although they decrease systematically, with increasing atomic number, do not differ greatly. This accounts in a large part for the very similar chemical behavior of this group.

Furthermore, the radii of the elements just following the rare earths are affected by the lanthanide contraction. Under normal conditions, in going down in any given group of the periodic table, the radius of the ions increases and we find

$$\begin{array}{lll} \text{Rb}^+ = 1.48\text{A} & \text{Sr}^{++} = 1.15\text{A} & \text{Y}^{+3} = 0.93\text{A} \\ \text{Cs}^+ = 1.67\text{A} & \text{Ba}^{++} = 1.31\text{A} & \text{La}^{+3} = 1.06\text{A} \end{array}$$

But this is not so for elements which follow the rare earth elements, such as

$$\begin{array}{ll} \text{Mo}^{+6} = 0.68\text{A} & \text{and} \quad \text{Ru}^{+4} = 0.65\text{A} \\ \text{W}^{+6} = 0.68\text{A} & \quad \quad \text{Os}^{+4} = 0.67\text{A} \end{array}$$

One may safely predict that the radii of Cb^{+5} and Ta^{+5} , were they known, should be approximately the same, as should those of Zr^{+4} and Hf^{+4} . As is well known, the pairs Mo-W, Cb-Ta, and Zr-Hf are very closely related chemically.

Variations in Ionic Radii.—In the course of his extensive comparisons of crystal structure data and the derivation therefrom of a set of ionic and atomic radii, Goldschmidt soon found¹ that ionic radii which he derived from the interionic distances in crystals with the NaCl structure (C.N. 6) did not fit when applied to crystals with the ZnS structure (C.N. 4). These two types he called “incommensurable.” Thus the ionic or atomic size of an element depends upon whether it occurs in an atomic ZnS structure or an ionic NaCl structure.

Aside from the influence of the type of bond, the most important factors affecting the size of an ion (or atom) are (1) the coordination number, (2) the valency of the coordinated ions and (3) the radius ratio of the central ion and its coordinated ions.²

¹ GOLDSCHMIDT, V. M., *Skrifter Norske Videnskaps-Akad. Oslo*, no. 2 (1926).

² ZACHARIASEN, W. H., *Z. Krist.*, **80**, 137 (1931).

Coordination Number and Ionic or Atomic Size.—There is ample empirical evidence indicating that as the coordination number of an atom or ion decreases its radius also decreases.

Having already established the fact that a change from an ionic to an atomic crystal causes a decrease in the interionic (atomic) distance, Goldschmidt attempted to compare only crystals which he had reason to believe were ionic, in order to find the effect of coordination number alone on the interionic distance. As a result of many detailed comparisons of interionic distances, listed in his original papers, he was able to summarize the relation between coordination number and interionic or interatomic distances as shown in Table 18.

TABLE 18.—INFLUENCE OF COORDINATION NUMBER ON IONIC AND ATOMIC RADII

Transition from		Transition to		Contraction, per cent
Type	C.N.	Type	C.N.	
CsCl	8	NaCl	6	3
NaCl	6	ZnS	4	5
CaF ₂	8-4	TiO ₂	6-3	3
NaCl	6	CaF ₂	8-4	3
NaCl	6	TiO ₂	6-3	5
Metal	12	Metal	8	3
C-O*	4	C-O(in CO ₃ ⁻)	3	9
C-O(in CO ₃ ⁻)	3	C-O(in CO ₂)	2	16

* Sum of tetrahedral radii = 0.77 + 0.60.

Zachariasen has recently demonstrated¹ mathematically the contraction of the interionic (atomic) distance with decreasing coordination number. Using the proper equations, he finds that the interionic distances vary with the coordination number as illustrated in Table 19. The values given are relative; C.N. 6 is taken as unity. It is evident that there is a marked change in interionic distance with coordination number, which must be taken into account to deduce accurate interionic distances for application in a given case. For those crystals in which contact

¹ *Ibid.*

between anions occurs, the table will not be accurate. Such cases, however, are taken care of by the radius ratio correction.

Correction for Valency.—The ionic radii of Goldschmidt and Pauling in Table 122, in the Appendix, while adjusted for use in crystals characterized by a C.N. 6, are not corrected for the influence upon an ion of the valencies of neighboring ions. The radius of an alkali or other univalent cation is larger when its neighbors are univalent than when they are divalent. The correction for valency may be made with the equation

$$R_{11} = R_{z_1 z_2} n^{-1} \sqrt{z_1 z_2} \quad (1)$$

TABLE 19.—VARIATION OF INTERIONIC DISTANCE WITH COORDINATION NUMBER

<i>n</i>	5	6	7	8	9	10	11	12
C.N.12	1.160	1.126	1.104	1.088	1.077	1.068	1.061	1.056
9	1.087	1.069	1.057	1.048	1.043	1.038	1.034	1.031
8	1.067	1.053	1.044	1.038	1.033	1.029	1.026	1.024
6	1.000	1.000	1.000	1.000	1.000	1.000	1.000	1.000
4	0.920	0.936	0.946	0.954	0.959	0.963	0.967	0.970
3	0.862	0.889	0.906	0.919	0.928	0.936	0.942	0.947
2	0.793	0.834	0.857	0.877	0.890	0.902	0.911	0.919

TABLE 20.— $n^{-1} \sqrt{z_1 z_2}$ AS FUNCTION OF $z_1 z_2$ AND n^*

<i>n</i>	5	6	7	8	9	10	11	12
$z_1 z_2 =$								
2	1.189	1.149	1.122	1.104	1.091	1.080	1.073	1.065
3	1.316	1.246	1.201	1.170	1.147	1.130	1.116	1.105
4	1.414	1.320	1.259	1.219	1.190	1.166	1.151	1.134
5	1.496	1.380	1.308	1.259	1.223	1.196	1.175	1.158
6	1.565	1.431	1.348	1.292	1.251	1.220	1.196	1.177
7	1.627	1.476	1.383	1.320	1.275	1.241	1.215	1.194
8	1.682	1.516	1.414	1.346	1.297	1.260	1.231	1.208
9	1.732	1.552	1.443	1.369	1.317	1.276	1.246	1.221
10	1.778	1.585	1.468	1.390	1.333	1.292	1.259	1.234
12	1.861	1.644	1.513	1.426	1.364	1.318	1.282	1.253
14	1.934	1.695	1.552	1.458	1.391	1.341	1.302	1.271
15	1.968	1.719	1.570	1.472	1.403	1.351	1.311	1.279
16	2.000	1.742	1.585	1.486	1.416	1.360	1.320	1.286

* ZACHARIASEN, W. H., *Z. Krist.*, **80**, 137 (1931).

derived from the expression for the crystal energy of a binary ionic compound. R_{11} is the interionic distance between two univalent ions; values for $n^{-1}\sqrt{z_1z_2}$ as functions of n and z_1z_2 are given in Table 20. Then, to determine the Ca-S distance, for example, we substitute for R_{11} , $2.20 + 1.17$ (the univalent radii of Ca^{++} and S^- , respectively). Since Ca^{++} and S^- are both of the argon configuration, $n = 9$; $z_1z_2 = 2 \times 2 = 4$; and from Table 20 $n^{-1}\sqrt{z_1z_2} = 1.19$. *Substituting these values in equation (1), we get $R_{z_1z_2} = 3.37/1.19 = 2.8$, as compared with the observed value 2.84 Å for CaS.

Correction for Radius Ratio.—This effect has been treated in detail by Pauling¹ in connection with the alkali halides. Figure 10 shows the effect of the radius ratio upon the interionic distances for sodium chloride type crystals. We may recall that, assuming perfect spheres, the coordination number should change from six to eight when the radius ratio $R_A:R_X$ increases above 0.73. Now, it is the abnormal repulsion of the ions which makes necessary the radius ratio correction. If with the radius ratio greater than 0.73 the sodium chloride type persists, there will be less

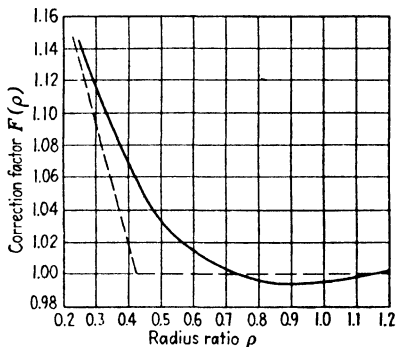

FIG. 10.—Correction factor $F(\rho)$, giving the dependency of interionic distances in NaCl-type crystals on the radius ratio ρ (solid line). The broken line shows the form of this function for solid spheres. [Pauling, *J. Am. Chem. Soc.*, **50**, 1038 (1928).]

than the normal repulsion since ions X are in abnormally loose packing around A —there being only $6X$ when there could be $8X$. Therefore, the correction factor is negative, and the interionic distance is less than it would be if there were no radius ratio effect. As the radius ratio decreases, the anions become more crowded around the cation and mutual repulsion of the anions, added to the normal anion-cation repulsion, enters in. This mutual repulsion of the anions, of course, prevents the anions from coming as close to the cation as they otherwise would, and the anion-cation distance becomes greater than if there were no radius ratio effect.

¹ PAULING, LINUS. *J. Am. Chem. Soc.*, **50**, 1036 (1928).

The correction factor therefore increases positively as the radius ratio decreases. It is evident from the curve that the correction becomes significant only when there is strong anion-anion repulsion, particularly when the NaCl type persists below the radius ratio (0.41), at which it should change to the ZnS structure. In LiI, for example, ($R_A:R_X = 0.68/2.20 = 0.31$) which has the NaCl structure, the Li-I distance determined experimentally is 3.03 Å, while the calculated sum of the radii is only 2.85 Å. This abnormally large distance in the crystal is due to the mutual contact and the resulting repulsion of the iodide ions.

In connection with the radius ratio effect, a word should be said regarding the effect of deformation upon interionic distances. The lack of additivity of these distances in the alkali halides was originally attributed to deformation.¹ As was pointed out in Chap. I, however, the alkalis are not to be thought of as strongly polarizing ions. The variations in the interionic distances in this series of salts may, as has just been shown, be adequately accounted for from the standpoint of the radius ratio, and there is no need to assume that the ions are deformed. On the other hand, when the cation is a small, highly charged, 18-electron shell ion (Cu^+ , Ag^+ , etc.) we find a much greater change in the interionic distances which may be attributed to polarization of the anion or to covalent binding.

Atomic Radii.—In the consideration of crystals of the elements or of compounds in which the bond is covalent or homopolar, we must deal with atomic radii rather than ionic radii.

Two sources of data have been employed for the determination of atomic radii: (1) the lattice dimensions of elements and (2) the lattice dimensions of covalent crystals, of which the ZnS type is most familiar. The first method is relatively simple. Most of the elements have simple structures and definite atomic radii may easily be derived from them. In many cases, however, as will be seen in the next chapter, metallic structures are such that the atoms occupy positions in the lattice at different distances from each other. In such instances, unless all the interatomic distances are recorded, the shortest distance of approach of neighboring atoms is usually given as the diameter of the metallic atom.

¹ FAJANS, K., and H. G. GRIMM, *Z. Physik*, **2**, 299 (1920).

The first sets of atomic radii for use in crystals containing homopolar or electron-pair bonds were published in 1923.¹

The radii were obtained by the familiar substitutional method used first by Bragg, assuming 1.05 Å as the absolute radius for sulfur. As in the determination of ionic radii by this method, its success depends upon the careful selection of commensurable crystals. Huggins chose only crystals of the ZnS type for comparison, and the radii he obtained are remarkably close to the corresponding radii of the elements now accepted.

It is interesting to note the close agreement between radii derived from the lattice dimensions of elements and of covalent compounds. A few values are shown in Table 21.²

TABLE 21.—ATOMIC RADII DERIVED FROM LATTICE DIMENSIONS OF THE ELEMENTS AND OF HOMOPOLAR COMPOUNDS

Element	Atomic radius from the element	Atomic radius from compound	Compound
Se	1.16	1.14	BeSe
Te	1.44	1.32	BeTe
Be	1.11	1.07	BeO
Cd	1.49	1.48	CdS
Zn	1.33	1.31	ZnS

The latest revised list of atomic radii is given in Table 122 in the Appendix.

In contrast to the ionic bond, the length of which is influenced by several factors, the covalent or homopolar bond seems to be characteristically constant. This may be very impressively illustrated for the wide variety of compounds of carbon (see Table 108, Chap. XI).

Recently the whole matter of covalent radii and interatomic distances in covalent crystals has been treated by Pauling and Huggins.³ For the many interesting details, reference may be made to their paper. Only the more important points can be outlined here.

¹ HUGGINS, M. L., *Phys. Rev.*, **21**, 379 (1923); **28**, 1086 (1926).

² Taken from Tables 122 and 125 in the Appendix.

³ PAULING, LINUS, and M. L. HUGGINS, *Z. Krist.*, **87**, 205 (1934).

A discussion based on quantum mechanics has suggested that the formation of various types of covalent bonds is possible.¹ These differ in number and distribution in space. They may be tetrahedral, octahedral, square, or trigonal prismatic bonds; or normal valence bonds in nonmetallic atoms. Sets of covalent radii, to be used in compounds containing the several types of covalent bond, have been obtained from the observed interatomic distances in crystals. Just as ionic radii may be applied to all crystals in which the bond is predominantly ionic, so these covalent radii are to be used not only in crystals containing pure covalent bonds, but also in crystals in which the bonds are more nearly covalent than ionic or metallic.

A set of standard tetrahedral radii is given in Table 125, in the Appendix. These have been determined by the substitutional method of Bragg, starting with the known radii of C, Si, Ge, Sn, and Pb and using for the radius of sulfur half the S-S distance in pyrite, and they are substantially the same as Huggins' list published in 1926. The observed interatomic distances in tetrahedral crystals of the ZnS and ZnO types agree with the distances calculated from this set, with the exception of the distances in BeO, AlN, and SiC. In the case of BeO, at least, the bonds are proba-

TABLE 22.—COMPARISON OF TETRAHEDRAL RADII SUMS WITH OBSERVED DISTANCES IN CRYSTALS OTHER THAN THOSE OF THE ZNS AND ZNO TYPES

Crystal	Bond	<i>d</i> calc., Å	<i>d</i> obsd., Å
FeS ₂	S-S	2.08	2.09
MnS ₂	S-S	2.08	2.12
CoS ₂	S-S	2.08	2.05
NiS ₂	S-S	2.08	2.09
FeAs ₂	As-As	2.36	2.46
FeSb ₂	Sb-Sb	2.72	2.44
CoAs ₂	As-As	2.36	2.46
N(CH ₃) ₄ Cl	C-N	1.47	1.38-1.48
N(CH ₃) ₄ Br	C-N	1.47	1.49
N(CH ₃) ₄ I	C-N	1.47	1.51
B ₂ H ₆	B-B	1.78	1.82
C ₂ H ₆	C-C	1.54	1.55
K ₂ S ₂ O ₆	S-S	2.08	2.06

¹ PAULING, LINUS, *J. Am. Chem. Soc.*, **53**, 1367 (1931).

bly more ionic than covalent. In addition to their existence in the well-known ZnS and ZnO crystals, these tetrahedral radii are applicable to the crystals shown in Table 22.¹

Normal Valence Radii for Nonmetallic Atoms.—In normal valence compounds, each atom forms covalent bonds to the number given by its negative valence. Two halogen atoms, each with a negative valence of one are joined by a single electron-pair bond, the octets of the two atoms being completed in this way. An oxygen atom, of negative valence two, may form two electron-pair bonds. Elements of the fifth group may form three such bonds, while carbon and the other fourth group elements form four. Radii for atoms in this type of compound are listed in Table 126 in the Appendix. In assigning these values the radii for the halogens were assumed to be one-half the spectral values for the separation of the atoms in the diatomic molecules. For carbon, silicon, germanium, tin, and lead the tetrahedral values were assigned. Since the radii of fluorine and chlorine correspond

TABLE 23.—COMPARISON OF RADIUS SUMS FOR NONMETALLIC ATOMS WITH OBSERVED DISTANCES*

From bad spectra				In crystals			
Molecule	Bond	<i>d</i> calc., A	<i>d</i> obsd., A	Crystal	Bond	<i>d</i> calc., A	<i>d</i> obsd., A
ICl	I-Cl	2.32	2.31	I ₂	I-I	2.66	2.70
HF	H-F	0.93	0.92	Se	Se-Se	2.34	2.32
HI	H-I	1.62	1.62	Te	Te-Te	2.74	2.88
H ₂ O	H-O	0.95	0.97	As	As-As	2.42	2.51
NH ₃	N-H	0.99	0.98	Sb	Sb-Sb	2.82	2.87-2.62
CH ₃ F	C-F	1.41	1.43	Bi	Bi-Bi	3.02	3.11
H ₂ CO	C=O	1.28	1.25	SiI ₄	Si-I	2.50	2.46
N ₂	N≡N	1.10	1.10	GeI ₄	Ge-I	2.55	2.57
CN	C≡N	1.16	1.17	SnI ₄	Sn-I	2.73	2.63
HCN	C≡N	1.16	1.16	CHI ₃	C-I	2.10	2.06
C ₂ H ₂	C≡C	1.22	1.21	As ₄ O ₆	As-O	1.87	2.01
				Sb ₄ O ₆	Sb-O	2.07	2.22
				C ₆ H ₁₂ N ₄	C-N	1.47	1.44

* Pauling and Huggins, *Z. Krist.*, **87**, 207 (1934).

¹ PAULING and HUGGINS, *Z. Krist.*, **87**, 222 (1934).

to the tetrahedral radii for these atoms, the tetrahedral radii for nitrogen, oxygen, phosphorus and sulfur have also been adopted. But the normal radii for bromine and iodine were found to differ from their tetrahedral radii, and the normal radii of arsenic, selenium, antimony, tellurium, and bismuth have been assumed to differ from their tetrahedral radii by corresponding amounts.

That these normal valence radii agree with observed interatomic distances in molecules and crystals of this type may be seen from the selected data in Table 23.

Octahedral radii from pyrite type crystals, listed in Table 127, in the Appendix, were calculated empirically from the observed values in these crystals. The standard octahedral radii are applicable in many crystals other than the pyrite type, a few of which are listed in Table 24. In these crystals the metal atom

TABLE 24.—COMPARISON OF OBSERVED INTERATOMIC DISTANCES WITH TETRAHEDRAL AND OCTAHEDRAL RADIUS SUMS*

Crystal	Bond	<i>d</i> calc., Å	<i>d</i> obsd., Å
FeS ₂	Fe ^{II} -S	2.27	2.27
CoS ₂	Co ^{II} -S	2.36	2.37
CoAsS	Co ^{III} -As	2.40	2.40
	Co ^{III} -S	2.26	2.28
RuTe ₂	Ru ^{II} -Te	2.65	2.64
PdSb ₂	Pd ^{IV} -Sb	2.67	2.67
AuSb ₂	Au ^{IV} -Sb	2.77	2.76
Pb ₂ PdBr ₆	Pd ^{IV} -Br	2.45	2.52
(NH ₄) ₆ SnCl ₆	Sn ^{IV} -Cl	2.48	2.46
K ₂ SeBr ₆	Se ^{IV} -Br	2.54	2.54
PtSe ₂	Pt ^{IV} -Se	2.48	2.49
CoI ₂	Co ^{II} -I	2.65	2.83
Cu ₂ HgI ₄	Hg-I	2.81	2.77
	Cu-I	2.68	2.56
HgI ₂	Hg-I	2.81	2.77
Cu ₂ SbS ₂	Sb-S	2.45	2.45

* A partial list from Pauling and Huggins, *Z. Krist.*, **87**, 207 (1934).

is attached to six nonmetal atoms, each of which may form one to four bonds with other atoms. The calculated interatomic distance is the sum of the octahedral radius of the metal plus the normal valence radius of the nonmetal.

Square Radii.—In K_2PdCl_4 , $(NH_4)_2PdCl_4$, K_2PtCl_4 , PdO , PtS , and probably CuO and $(Ni, Fe)S$, the metal atom is surrounded by four nonmetallic atoms at the corners of a square. These square radii are summarized in Table 127 in the Appendix.

Trigonal Prism Radii.—In MoS_2 and WS_2 , the metal atom is surrounded by six sulfur atoms at the corners of a trigonal prism. The metal radii for this configuration are listed in Table 127.

That the covalent radius of an atom varies greatly with the number of bonds, *viz.*, with its coordination number, is clearly shown in the case of silver. The tetrahedral radius (C.N. = 4) is 1.53 Å. In Ag_2O (C.N. = 2) the radius of the silver atom is 1.39 Å; while the distance obtained from band spectra of the molecule Ag (C.N. = 1) is 1.12 Å.

The Radius of Hydrogen.—Hydrogen, being so light, does not diffract X rays, and its position in crystals cannot be directly determined. It is an interesting problem, therefore, to establish its size or sphere of influence under different conditions. No doubt this sphere depends upon its environment and its state of ionization.

Knowledge of the size of hydrogen is particularly important in the study of organic crystals. A recent attempt has been made to define the "atomic domain" of hydrogen in such crystals through a stereochemical approach.¹

In crystalline hydrogen (hexagonal close-packed and assuming rotating molecules), the radius of the hydrogen atom is about 1.5 Å,² this large figure being due, no doubt, to electron repulsion. The H^+ , on the other hand, is little more than a point, and, when it combines with a negative ion, it virtually buries itself in the electron cloud of the latter. Thus the OH^- is about the same size (1.50 Å) as the O^- (1.35 Å), although the addition of H^+ to O^- produces an unsymmetrical and easily distorted ion. The effective crystal radius of H^- may be obtained from the interionic distances in the alkali halides. It has been found to vary from 1.26 Å in LiH to 1.54 Å in CsH when the Goldschmidt radii for the alkali metals are assumed.³ In NH_4^+ (approximately 1.50 Å),

¹ MACK, EDWARD, JR., *J. Am. Chem. Soc.*, **54**, 2141 (1932).

² *Ibid.*

³ ZINTL, E., and A. HARDER, *Z. physik. Chem.*, **B28**, 478 (1935).

of course, the effective radius of H^- must be much less. Vegard¹ has estimated from crystal structure data that in crystalline H_2S and H_2Se the radius of the hydrogen atom must be about 0.70 Å. The effective radius of hydrogen in the molecule H_2 is 0.375 Å. From the hydrogen halides, the value 0.29 Å may be obtained.

The Hydrogen Bond.—There is rather convincing evidence that hydrogen may hold two other atoms together. Hydrogen functioning in this manner is termed a “coordinated hydrogen” or a “hydrogen bond” and was first proposed by Huggins² and Latimer and Rodebush.³ Its occurrence has recently been reviewed by Rodebush.⁴ The length of the bond was first determined by West as it occurs in KH_2PO_4 ⁵ and has since been studied in NH_4HF_2 ,⁶ formic acid,⁷ and $NaHCO_3$.⁸ The H-F bond in F-H-F is about 1.184 Å in length, while the H-O bond in O-H-O averages about 1.275 Å.

Although the hydrogen bond was postulated several years ago to account for abnormal physical properties,⁹ it is doubtful whether such abnormalities should be taken as positive evidence of the bond. The absence of the hydroxyl absorption band in the infrared has also been proposed as a method of identification,¹⁰ but Sherman¹¹ questions the infallibility of this criterion. He defines the hydrogen bond as one, the energy of which is derived from the resonance energy of quantum mechanics, the electron of a hydrogen atom being part of the resonating system. Thus the molecule containing hydrogen bonds will be more stable than indicated by the conventional formula, and the increase in

¹ VEGARD, L., *Z. Krist.*, **77**, 23 (1931).

² HUGGINS, M. L., Undergraduate Thesis, University of California, 1919.

³ LATIMER, W. M., and W. H. RODEBUSH, *J. Am. Chem. Soc.*, **42**, 1419 (1920).

⁴ RODEBUSH, W. H., *Chem. Rev.*, **19**, 59 (1936).

⁵ WEST, J., *Z. Krist.*, **74**, 306 (1930).

⁶ PAULING, LINUS, *Z. Krist.*, **85**, 380 (1933).

⁷ PAULING, LINUS, and L. O. BROCKWAY, *Proc. Natl. Acad. Sci.*, **20**, 336 (1934) (electron diffraction).

⁸ ZACHARIASEN, W. H., *J. Chem. Physics*, **1**, 634 (1933).

⁹ SIDGWICK, N. V., “The Electronic Theory of Valence,” Oxford University Press, New York, 1929.

¹⁰ HILBERT, G. E., O. R. WULF, S. B. HENDRICKS, and U. LIDDEL, *J. Am. Chem. Soc.*, **58**, 548 (1936).

¹¹ SHERMAN, ALBERT, *J. Phys. Chem.*, **41**, 117 (1937).

stability is the energy of the hydrogen bond. The bond can therefore be detected through thermochemical data.

The hydrogen bond has been said to be largely ionic in nature,¹ although from a recent study of the heat of association of formic acid, it has been concluded² that the wave function for the bond should include a nonpolar as well as a polar term, the three states being $X-H^+X^-$, $X-HX$, $XH-X$.

Hydrogen bonds may play a significant role in the association of water and other solvent molecules in the liquid state. It is probable that they are operative in crystalline ice³ and in many crystals containing combined water. So-called "bound water" may be attached to gelatin and similar substances through hydrogen bonds. They are also thought to occur rather frequently in organic compounds.⁴

The Hydroxyl Bond.—In basic and amphoteric hydroxides it has been observed that the distance between oxygens attached to different cations decreases with increasing cation charge, *viz.*, with decreasing alkalinity. This shorter distance between oxygens is assumed to indicate attraction between the hydroxyl groups.⁵ This attraction was first termed a double hydrogen bond⁶ because each of the groups joined contained hydrogen, but it is now designated as the hydroxyl bond. Its occurrence is suspected in many organic compounds, as well as in the hydroxides and other compounds containing water. It is said to occur in ice.⁷

¹ PAULING, LINUS, *J. Am. Chem. Soc.*, **53**, 1367 (1931).

² GILLETTE, R. H., and ALBERT, SHERMAN, *J. Am. Chem. Soc.*, **58**, 1135 (1936).

³ PAULING, LINUS, *J. Am. Chem. Soc.*, **57**, 2680 (1935).

⁴ HILBERT, G. E., O. R. WULF, S. B. HENDRICKS, and U. LIDDEL, *J. Am. Chem. Soc.*, **58**, 548 (1936).

⁵ BERNAL, J. D., *Proc. Roy. Soc. (London)*, **A 151**, 384 (1935).

⁶ BERNAL, J. D., *Annual Repts. (London)*, **30**, 401 (1933).

⁷ BERNAL, J. D., and R. H. FOWLER, *J. Chem. Physics*, **1**, 515 (1933).

CHAPTER III

THE STRUCTURES AND PROPERTIES OF THE ELEMENTS: THE METALLIC STATE

We are in the habit of thinking of three states of matter—gaseous, liquid, and solid. The solid state may be conveniently subdivided into the crystalline, glassy, and amorphous states. It seems almost necessary to break down the crystalline state into the nonmetallic and the metallic states. To even the casual observer the properties of metals differ so markedly from those of other crystalline solids that there must evidently be some fundamental difference in the way in which the atoms are put together. The nature of metals has evaded description until very recently, but we now have a rather clear picture of their structure and its significance, even though it is by no means complete in detail.

The characteristics of metallic elements may be most clearly understood by approaching their structures from those of the nonmetallic elements. In Table 25 the elements are grouped into four classes, according to their crystal structures.

The elements in Class IV may be recognized at once as the typical nonmetallic elements. The crystal structures of the solidified rare gases have been found to be face-centered cubic,¹ each point on the crystal lattice being occupied by a single, neutral atom of the element, the outermost electron shell of which already possesses its full quota of eight electrons. There is, therefore, very little attraction between the atoms, and the crystal is characteristically weak. The addition of a small amount of

¹ Unless otherwise stated all references to crystal structures of elements or compounds are from R. W. G. Wyckoff "The Structure of Crystals," 2d ed., Reinhold Publishing Corporation, New York, 1931, and the supplement, 1934. This is a most complete, simple classification of crystal structure data up to 1935 and is an invaluable asset as a reference in connection with the study of crystal chemistry.

energy causes it to break down; the rare gases, therefore, have very low melting points.

The other elements in Class IV probably form molecular crystals in which the lattice positions are occupied by molecules, as in solid nitrogen and oxygen.¹ It is interesting that the molecule of nitrogen which we have always written as N_2 is a reality in the solid form. Since the forces attracting neutral molecules are relatively weak, we find all of the crystals of Class IV with significantly low melting points.

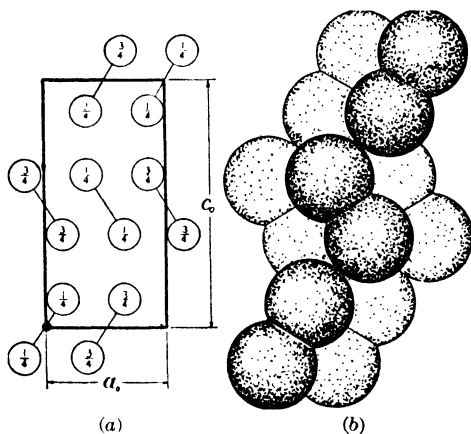

FIG. 11.—(a) The atomic arrangement for iodine. A projection drawing upon its b face. Fractions indicate the distance of each atom below the plane of the paper. (b) The probable packing of iodine atoms in solid iodine. (From R. W. G. Wyckoff, "The Structure of Crystals," by permission of the Reinhold Publishing Corporation, New York.)

Class III is perhaps the most interesting group in that it begins a remarkably systematic transition from the molecular lattices of Class IV to the metallic crystals of Class I. Let us consider four typical examples: iodine, selenium (or tellurium), arsenic (antimony and bismuth are isomorphous with arsenic), and diamond (carbon, silicon, germanium, and gray tin are isomorphous). These four transitional structures are shown in Figs. 11 to 14.

It is evident that iodine is a molecular crystal; each lattice point is occupied by an I_2 molecule, the forces holding the molecules together are weak, and the crystals, as we know them, are

¹ VEGARD, L., *Z. Physik*, **98**, 1 (1935).

LATTICE TYPES OF THE ELEMENTS
Key to Table 25

Symbol	Lattice type	Elements
Structures Completely Determined		
A1	Cubic, face-centered	Ag, Al, Au, Ar, α -Ca, β -Ce, β -Co, Cu, γ -Fe, Ir, Kr, β -La, Ne, β -Ni, Pb, Pd, Pt, β -Rh, Sr, Th, β -Tl, X
A2	Cubic, body-centered	Ba, α -Cr, Cs, Cb, α -Fe, K, Li, Mo, Na, Rb, Ta, β -U, V, β -W, β -Zr
A3	Hexagon, close-packed	Be, γ -Ca, Cd, α -Ce, α -Co, β -Cr, α -Er, Hf, α -La, Mg, α -Nd, α -Ni, Os, α -Pr, Re, α -Ru, Ti, α -Tl, Y, Zn, α -Zr
A4	Diamond, cubic	C (diamond), Ge, Si, gray Sn
A5	Tetragonal, body-centered	Sn (white)
A6	Tetragonal, face-centered	In, γ -Mn
A7	Rhombohedral, body-centered	As (metallic), Sb, Bi
A8	Hexagonal	Se (hex.), Te, Po
A9	Hexagonal	C (graphite)
A10	Rhombohedral	Hg
A11	Rhombic	Ga
A12	Cubic, body-centered	α -Mn, γ -Cr
A13	Cubic	β -Mn
A14	Rhombic	I ₂ , Br ₂
A15	Cubic	α -W
A16	Rhombic, face-centered	P (black, metallic)
A17	Rhombic	α -S
Structures Incompletely Known or Uncertain		
C	Cubic	α -N ₂ , γ -O ₂
H	Hexagonal?	B
H	Hexagonal	H ₂ (Para), β -N ₂
R	Rhombic	α -O ₂
C ₁	Cubic	P (white)
C ₂	Cubic	α -Rh
Rh	Rhombohedral	β -O ₂
M	Monoclinic	S (fibers), α -Se, β -Se
M ₁	Monoclinic	α -U
H ₁	Hexagonal	β -Be

very weak. They are flaky, are very brittle, and can easily be vaporized at a relatively low temperature. What of the forces holding the two atoms together in the molecule—the intramolecular forces? Apparently they are stronger, because when the crystal is broken down, it breaks up into molecules, not into single atoms. Consider the electronic structure of the iodine atom; it is 2-8-18-18-7 (see Table 124, the Appendix); there are

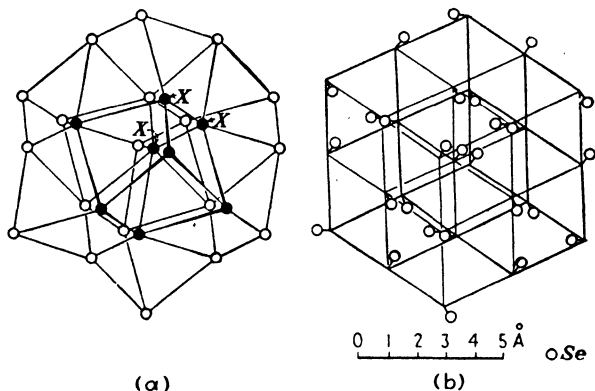
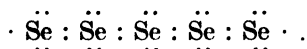

FIG. 12.—(a) The atomic arrangement in selenium. The first three atoms in a spiral chain are marked X. The chain spirals down into the paper. (b) The relation of the selenium arrangement to that in a simple cubic lattice. (From Ewald, P. P., and C. Hermann, "Strukturbericht," by permission of Akademische Verlagsgesellschaft, Leipzig.)

seven valence electrons. This means that two atoms can complete their octets by each sharing one electron with the other, according to the following scheme: $\cdot \ddot{\text{I}} : \ddot{\text{I}} \cdot$. The bond holding the atoms is thus a homopolar bond and is much stronger than the molecular attraction throughout the rest of the crystal.

In the case of selenium, the atom has only six valence electrons in the outer shell. The only way a selenium atom can complete its octet by sharing with other selenium atoms is to share one electron with each of two neighbors. This will lead to an endless chain of selenium atoms, arranged as follows:



The links in the chain are homopolar bonds, and an entire chain may be looked upon as a single giant molecule. The forces

between chains may be molecular under certain conditions, or they may be metallic. The crystals are relatively weak, but they have some properties of the metallic bond, soon to be described. For example, under the influence of light, selenium becomes a very good conductor of electricity. The element also has a metallic appearance. It is impossible to state arbitrarily, therefore, the nature of the forces between chains in the selenium crystal. That these chains are no myth may be seen in Fig. 12a. The atoms marked X show one chain which, from the point of observation, seems to spiral almost directly into the paper.

In rhombic sulfur¹ the S₈ molecules exist as separate entities. Like selenium, the atoms form chains, but they are eight-

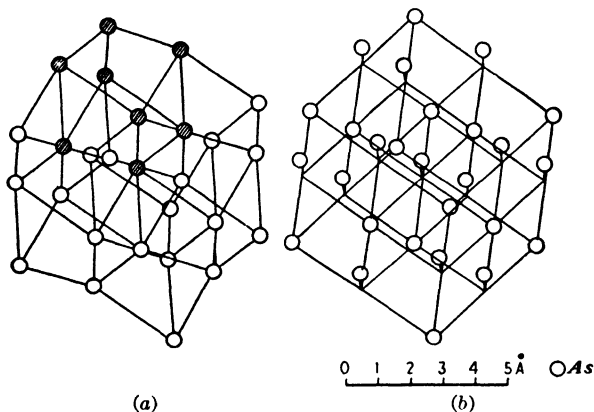

FIG. 13.—(a) The atomic arrangement in arsenic. (b) The relation of the arsenic arrangement to that in a simple cubic lattice. (From Ewald, P. P., and C. Hermann, "Strukturbericht," by permission of Akademische Verlagsgesellschaft, Leipzig.)

membered chains, the ends of which have been brought together to form an enclosed ring. Each S atom thus has two near neighbors.

The arsenic atom has only five valence electrons and each atom must therefore share one electron with each of three neighbors to complete its octet. The angles between bonds tend to be between 90 and 109.5 deg., nearer 90 deg., and this may be realized by the formation of a layer structure. Each arsenic atom holds three neighbors by covalent bonds, and these form an endless

¹ WARREN, B. E., and J. T. BURWELL, *J. Chem. Physics*, **3**, 6-8 (1933).

layer, a giant molecule. Between the layers are weaker forces which may be molecular or metallic—or a combination of both—because arsenic crystals show characteristics of both. They are weak, as evidenced by the ease with which arsenic sublimes; they also exhibit the familiar metallic luster. The coordination number is six; there are three near neighbors, held by covalent bonds, and three more distant neighbors held by the weaker forces. As with selenium, the arsenic crystal is a distorted NaCl structure, and the nature of the distortion may be observed in Fig. 13.¹ Imagine a sodium chloride crystal that stands on one corner with the cube diagonal vertical, then squash it downward. This changes it from a cube to a rhombohedron. Now imagine every other horizontal layer of atoms drawn toward the layer above it, under the urge of the atoms to acquire three neighbors to complete their octets. The atoms are not drawn all the way to the layer above, but remain slightly below, forming a puckered layer as may be seen in the figure. In crystalline bismuth, although it is rhombohedral like arsenic and antimony, the bismuth atoms are not so far from the normal positions they would occupy in the sodium chloride lattice.

Black phosphorus is crystalline, the atomic arrangement being a double layer structure, somewhat similar to arsenic but orthorhombic. It is a more closely packed structure than is arsenic² and is stable at high pressures because of this close packing.

It should be noted that all of the elements so far discussed exist in allotropic forms. An amorphous form is particularly characteristic of all these, whereas we never find the truly metallic elements in the amorphous condition. The amorphous form is usually unstable at room temperature. The familiar amorphous sulfur is prepared by every freshman when he pours molten sulfur into cold water. Incidentally, this form of sulfur has been reported to have a pseudocrystalline structure when stretched—a structure very much like stretched rubber³ and this is suggestive

¹ The NaCl structure has no physical reality; there is no tendency to form this structure.

² HULTGREN, R., N. S. GINRICH, and B. E. WARREN, *J. Chem. Physics*, **3**, 351 (1935).

³ TRILLAT, J. J., and J. FORESTEER, *Compt. rend.*, **192**, 559 (1931). Also see Chap. XII, of this book.

of chain molecules. In many cases the amorphous modification of these elements may be electrodeposited. Strangely enough, arsenic may be deposited in the amorphous form under ordinary conditions and antimony under more limited conditions, but bismuth deposits are crystalline under these same conditions.¹ A second form of bismuth, stable at 25,000 kg. per sq. cm., has recently been observed.²

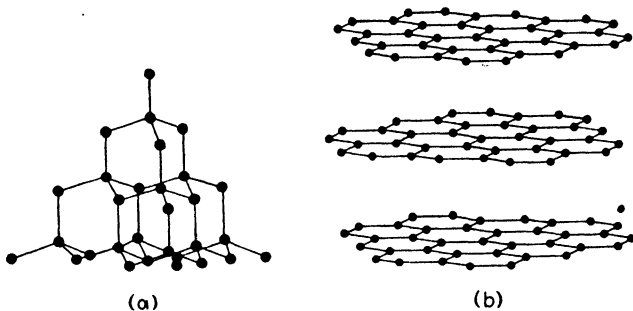

FIG. 14.—(a) The atomic arrangement in diamond. (b) The layer structure of graphite.

We come finally to the diamond crystal. Carbon has only four electrons in the valence shell and each atom must, therefore, share with four neighbors to complete its octet. These four neighbors, to be grouped symmetrically around the central atom, must lie either in a plane at the corners of a square or they must lie at the corners of a tetrahedron of which the atom surrounded by the four is the center. The directional characteristics of the covalent bond favor the tetrahedral arrangement and this is the one found in the diamond (see Fig. 14). Since four homopolar bonds are now available for each atom, they can extend in three dimensions. All the atoms in the crystal are bound by homopolar forces, there are no weak binding forces, and the entire crystal, regardless of its size, may be thought of as one huge molecule. The well-known properties of diamond are in keeping with such a picture. It is the hardest known substance; its melting point is one of the highest (above 3000°C.); it is a non-conductor of electricity.

¹ STILLWELL, C. W., and L. F. AUDRIETH, *J. Am. Chem. Soc.*, **54**, 472 (1932).

² BRIDGMAN, P. W., *Phys. Rev.*, **45**, 844 (1934).

In the preceding pages we have followed the transition of the crystalline elements from the weak molecular lattice to the molecular chain lattice, strong within the chain but weak between chains; thence to the molecular layer lattice, strong forces within the layer but weak forces between layers; and finally to the diamond, held by homopolar or electron-pair forces throughout, and one of the strongest substances known. We have described what may be summarized as the "8- N rule"¹ which has been stated as follows: When an atom has N valence electrons, it can hold $8-N$ neighbors by sharing electrons. It would seem that

we are no nearer the metallic state than when we started, indeed diamond bears less resemblance to the metals than many of the other elements that have been mentioned.

Let us skip over Class II for the moment and examine the characteristics of the Class I elements. We recognize these elements at once as the true metals, from the standpoint of both their chemical and engineering properties. With the exception of manganese all of the elements in this group are found to have one of three

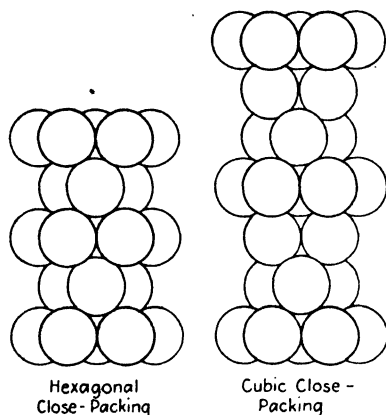

Fig. 15.—Spheres in closest packing, C.N. 12. The atomic arrangement in many metals.

very simple crystalline structures. They are close-packed hexagonal (C.N. 12), face-centered (close-packed) cubic (C.N. 12) or body-centered cubic (C.N. 8). The close-packed structures are illustrated in Fig. 15. The truly metallic structures, then, are characterized by high coordination numbers, 8 or 12. It is obviously impossible for the atoms to be held together by sharing one electron with each of $8-N$ neighbors, for there are not enough electrons available. Here we have the underlying condition which characterizes the metallic bond. There are not enough electrons available for sharing; an ionic bond is impossible

¹ HUME-ROTHERY, WILLIAM, *Phil. Mag.*, (7), 9, 65 (1930).

because all the atoms are positive and so the metallic linkage occurs. This is a new type of bond in which an electron can serve for more than one atom. We may use the following analogy to illustrate the situation that has arisen: Consider a machinery manufacturer who has four servicemen in his employ and finds himself, in the midst of a depression, with only four customers who use his machine. It is a simple matter to keep in touch with these four customers. One man may act as a continuous go-between from the plant to each customer. But suppose, with a revival of business, the number of customers is increased to twelve. If the number of servicemen is not to be increased, it becomes necessary for each one to circulate, visiting at least three customers. He can no longer devote his time entirely to one. This is exactly what the valence electrons must do when the number of neighbors in the crystal grows too large. In order to retain some sort of hold on all these neighbors they must divide their time between them. These "roving" electrons, then, constitute what is known as the "metallic bond." It is supposed that the metal atoms lose their valence electrons and become positively charged ions, while the detached¹ electrons are free to move around to some extent. The metallic state, then, we visualize as a state in which positive ions are held together by a sort of gas of negative electricity—an electron gas. The properties of the metals are better understood from this picture, as will be shown later.

Before we forget the case of the machinery servicemen it is interesting to observe another factor in the situation. When the number of customers increases, the manufacturer can keep in touch with all of them by having his representatives circulate, but he cannot keep so efficient contact with any one of the twelve as he could with each of the original four. Likewise, with the increasing number of neighbors when we pass from the crystal of diamond (C.N. 4) to one of the metals (C.N. 8 or 12), the resulting metallic bond is not apt to be so strong as the homopolar bond where each electron devotes itself to one neighbor exclusively.

¹ According to present theory, they are not completely independent of the ion and therefore not unqualifiedly detached, but considerably more mobile than if they bore their normal relation to the atom.

We should expect the melting points of carbon, silicon, and germanium to be higher than those of the metals, and to a certain degree this is true.

The metallic bond is probably, in essence, a modified or weakened homopolar bond. Fundamentally it involves a sharing of electrons. In the true homopolar bond a pair of electrons is shared by two atoms; in the metallic bond more or less mobile electrons are shared by more than two atoms.

One may wonder to what extent a true homopolar bond may be detected in the presence of a metallic bond. We have postulated, for example, that in the selenium crystal both types are present. Two means of detection have been used. First, assuming there are homopolar bonds in a given crystal, the conductivity should increase with an increase in temperature, since the electrons are loosened somewhat. For the metallic bond, however, an increase in temperature increases the resistance due to the increased amplitude of vibration of the electrons, already comparatively mobile. The presence of homopolar bonds, therefore, is accompanied by the occurrence of a minimum resistance as the temperature is raised. The fourth and sixth group elements exhibit a minimum resistance, while the results for the fifth group are not at all conclusive. The magnetic properties of a substance also serve to betray the presence of homopolar bonds. Some metals are diamagnetic because they contain diamagnetic atoms. Homopolar substances, however, are apt to be strongly diamagnetic and their diamagnetism decreases as the temperature increases and vanishes at the melting point, showing that it is a property of the forces in the crystal and not of the element itself. This is particularly true of bismuth and antimony.

The free electron or electron gas theory of the metallic state is not particularly new. In 1900, Drude¹ assumed that metals contain a number of free electrons, the motion of which is that of an ideal gas, as described in the kinetic theory: When an electric force is applied these electrons are assumed to move in one direction and carry the current. Lorentz² developed the theory further, and it was subsequently modified by Richardson, Thomp-

¹ DRUDE, P., *Ann. Physik*, **1**, 566 (1900); **3**, 369 (1900).

² LORENTZ, H. A., "Theory of Electrons," G. E. Stechert and Co., New York, 1923.

son, Jeans, Wilson, Bohr, and others. The electron gas theory of metals is applicable to the specific heat phenomena only if it be assumed arbitrarily that most of the electrons are bound to atoms and only a small percentage are free to carry the electric current.¹

The more recent theories, exemplified by that of Pauli and Sommerfeld, are based on the quantum mechanics. The energy values for the electrons in a crystal are not continuous as in the classical Lorentz theory, but occur at discrete levels. Applica-

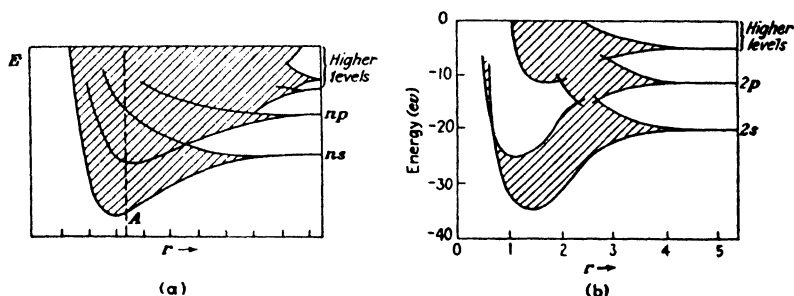

FIG. 16.—(a) Schematic representation of the behavior of the atomic energy levels as an alkali metal lattice is contracted. At the equilibrium distance A the spectrum is continuous. (b) Semiquantitative representation of the zone scheme of diamond, varying with lattice spacing. [From Seitz, F., and R. P. Johnson, *J. Applied Phys.*, 8, 84 (1937).]

tion of the Pauli exclusion principle limits the number of electrons which can exist in each such energy band. Paramagnetism was first successfully explained by this theory, which was later extended to include other metallic properties. Although it offers a satisfactory interpretation of most of the properties of metals, it did not give an adequate explanation of the fundamental difference between a conductor and a nonconductor.

The newer zone theory of solids does offer a wave mechanical description of the electron distribution in metals and nonconductors which accounts for their characteristic differences. It differs essentially from the Pauli-Sommerfeld theory in that it considers (1) the wave nature of the electron and (2) periodic potential distribution in the solid lattice. Briefly, certain energy ranges in a crystal are forbidden to the valence electrons, leaving

¹ SLATER, J. C., Recent wave mechanical calculations confirm this assumption, *Phys. Rev.*, 36, 57 (1936).

gaps in the energy spectrum in which no electrons can be found. If the zones in which electrons are allowed overlap affording a continuum of electrons, the latter behave much like free electrons and the substance is metallic; if electron zones are discontinuous, leaving regions in which no electrons can occur, then the substance is a nonconductor. The schematic application of this theory is shown in Fig. 16. Figure 16a is the energy spectrum of a typical alkali metal with overlapping zones; and Fig. 16b shows the energy zones for diamond.

For a more detailed discussion of the development of the theory of metals, the reader is referred to Hume-Rothery,¹ Mott and Jones,² Seitz and Johnson,³ and Slater.⁴

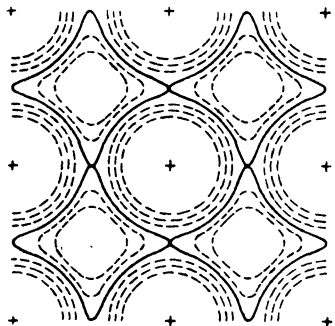

FIG. 17.—Schematic picture of the distribution of positive and negative charges in a metallic lattice. [From J. E. Lennard-Jones, *Proc. Roy. Soc. (London)*, **A120**, 734 (1928) by permission of the Royal Society.]

It is to be noted that, according to the zone theory, the electrons are free to move—sometimes in restricted zones—in nonconductors as well as in metals and that, in contrast to the older viewpoints, particular valence electrons are not bound to particular atoms. Rather, in nonconductors any particular electron is apt to be found in a rather definite orbit but about *any one* of the atomic nuclei.

While it is not strictly permissible to adopt a definite physical picture in connection with the newer physical theories, a diagram which comes very near to expressing the most recent conception of the metallic state is shown in Fig. 17. The atomic nuclei are shown by crosses. The dotted lines represent lines of equal potential. As the distance from the nucleus increases, a critical point is reached which is shown by a continu-

¹ HUME-ROTHERY, WILLIAM, "The Metallic State," Oxford, Clarendon Press, New York, pp. 164–200, 1931.

² MOTT, N. F., and H. JONES, "Theory of the Properties of Metals and Alloys," Oxford University Press, New York, 1936.

³ SEITZ, FREDERICK, and R. P. JOHNSON, *J. Applied Phys.*, **8**, 84 (1937).

⁴ SLATER, J. C., *Rev. Mod. Phys.*, **6**, 208 (1934).

The last reference is a brief, fairly elementary summary of the zone theory.

ous line. These are closed curves representing equal electron densities in the regions which contain no nuclei, but it is evident that the electron density in these regions is less than that in the regions containing nuclei. The electrons in these regions between the atomic nuclei are the ones shared by all the atoms. One observes here a suggestion of the electron lattice proposed by Lindemann, but it differs from his conception in that the electron lattice is not necessarily static, even at the absolute zero. This picture differs from the older electron gas theories in that the shared electrons, while free to move to some extent, are definitely restricted in their movements.

Class II is an interesting group from the standpoint of the structure types of its members. They are actually more metallic than nonmetallic and might be classed as abnormal metallic structures. For the fourth group elements, the influence of the covalent bond determines the crystal structure. In passing toward the first group, the covalent bond can no longer be formed; and for building units essentially spherical, with no directional bonds, the stable configuration is a close-packed arrangement. One may fairly visualize the struggle going on among the atoms as they attempt, upon leaving Class III, to "shake themselves down" into the geometrically stable close packing of Class I. Above all, this requires a crowding up, so that each atom may acquire more neighbors. Consider gallium, a very abnormal crystal which has defied exact analysis for many years. The crystal has now been definitely determined as orthorhombic.¹ Each atom has seven neighbors, one distant 2.45 Å and two each at 2.70, 2.75, and 2.79 Å. There is first, the persistence of molecules of Ga₂ (the atoms 2.45 Å apart) in the solid crystal, in which respect the substance is nonmetallic and more like the Class III elements. The forces between these Ga₂ molecules must be relatively weak, as evidenced by the low melting point of gallium (37°C.). The actual orthorhombic cell results when an ideal tetragonal arrangement of the atoms is compressed only slightly; and in the tetragonal form, each atom has *five* nearest neighbors. There is apparent, then, a tendency to follow the 8-*N* rule. Finally, the gallium structure has a distorted close pack-

¹ LAVES, F., *Naturwissenschaften*, **20**, 472 (1932). But see also A. J. Bradley, *Z. Krist.*, **91**, 302 (1935).

ing, a metallic tendency, and evidence of the transitional nature of the element.

Zinc has a distorted close-packed hexagonal structure. For hexagonal close packing of spheres the axial ratio (c/a) = 1.63, while in zinc the axial ratio is 1.87. It has been suggested that, owing to their two valence electrons, zinc atoms are spheroidal¹ and would therefore close pack with the c axis longer than for close-packed spheres. At any rate, because of this elongated c axis, zinc is not so characteristically metallic as the Class I elements. Furthermore, instead of 12 equidistant neighbors, each zinc has 6 close neighbors and 6 carried slightly farther away by the elongated c axis.

Indium is face-centered tetragonal, but the axial ratio is only 1.06. It is therefore very nearly face-centered cubic.

Mercury is rhombohedral, a distorted face-centered cube.

Lead and aluminum are face-centered cubic, but there is some indication that the atoms are farther apart than they should be if close packed. This abnormality is discussed later.

Several of the elements on the border line of the metallic state are polymorphous, crystallizing in nonmetallic and metallic forms. Gray tin, stable below 19°C., is isomorphous with diamond, and the atoms are bound by homopolar forces. It shows no resemblance to the metals whatsoever. The more commonly known white tin, on the other hand, stable above 19°C., properly belongs in Class II. It is tetragonal, C.N. = 6, and possesses familiar metallic properties. Evidently a particular element cannot be classed arbitrarily as metallic or nonmetallic.

Carbon crystallizes as diamond and as graphite. Their structures are shown in Fig. 14. While in diamond all the atoms are held by strong, homopolar forces to form a nonmetallic crystal; in graphite, each carbon atom has lost one of its near neighbors and has but three neighbors in its own layer. Each atom, therefore, has one electron in excess of those needed for the homopolar bonds, and this is involved in some way in holding the adjacent layers together. Recently Pauling has suggested that all four electrons exert most of their influence within the layers rather than between them.² The flaky nature of graphite, and the

¹ WESTGREN, ARNE, and A. ALMIN, *Z. physik. Chem.*, B 5, 14 (1929).

² PAULING, LINUS, *J. Am. Chem. Soc.*, 57, 2706 (1935); see also Chap. XI of this book.

large distance between layers, indicate that the force between layers is relatively weak—weaker than would be expected, were one electron from each carbon atom available for the bond. In contrast to diamond, which is an extremely poor conductor, graphite is a good conductor of electricity. According to the zone theory this may be interpreted as follows: Referring to Fig. 16*b*, it appears that the zones have come together and then, at the minimum interatomic distance in diamond have separated again. However, at a larger interatomic distance the zones are more nearly continuous, and the average interatomic distance in graphite is larger (1.42 Å in layers, 3.40 Å between layers).

Resembling in this respect the other Class III elements, carbon has long been known in an "amorphous" form.¹ Recent studies have proved beyond doubt, however, that amorphous carbon is actually crystalline. Carbon black is composed of a continuous series of particles varying from single layers of graphite to graphite crystals several layers thick.²

Many so-called "intermetallic compounds" are distinctly non-metallic in some respects even though they are composed of two metallic elements. On the other hand, so-called "synthetic metals" have been prepared from nonmetallic constituents.³

Authorities are fairly well agreed upon the structural classification of the elements which has been given. When we delve further into the details of the metallic state, however, and attempt to systematize the various differences which occur within Class I itself, difficulties arise which, as yet, have not been surmounted. In Table 25 are given the crystal structures of the elements as they occur in the periodic table. Questions at once present themselves: What determines the structure of an element? All of the alkalis, for example, are body-centered cubic. May this be characteristic of their unique atomic structure in which there is only one valence electron? Hardly so, for the same body-centered cubic structure is common in the fifth and sixth groups. The alkaline earths are face-centered cubic, and so are the eighth group transition metals. The

¹ HOFMANN, U., E. GROLL, and W. LEMCKE, *Z. angew. Chem.*, **44**, 841 (1931); HOFMANN, U., and W. LEMCKE, *Z. anorg. allgem. Chem.*, **208**, 194 (1932); MIWA, MITSUWO, *Science Repts. Tôhoku Imp. Univ.*, **23**, 242 (1934).

² WARREN, B. E., *J. Chem. Physics*, **2**, 551 (1934).

³ See, for example, KRAUS, C. A., *J. Am. Chem. Soc.*, **29**, 1557 (1907); **35**, 1732 (1913).

third and fourth group metals are predominantly hexagonal, and this structure recurs to some extent in the seventh and eighth groups. There is, as shown in Table 25, a suggestion of a rotation of structure types, from C.N. 8 to 12 to 8 to 12 in going across a long period.

A recent quantum mechanical treatment of the metallic state appears to throw some light on the questions which have just been raised:¹ In the true metals, the energy of the valence electrons is practically independent of the lattice structure. The electron charge is strongly isotropic, resulting in essentially spherical units which tend to assemble in simple, close-packed structures. It is suggested that for the alkalis, the wave functions of the inner shells overlap very little, hence the binding energy is that of valence electrons in a field of ions, plus a small van der Waals' attraction. The urge for the closest packing is absent and a structure with C.N. = 8 is formed.

Although, for the divalent and trivalent metals the force may still be largely that of valence electrons in a field of ions, it is a much stronger force; closer packed structures are to be expected and are found.

In the progression from left to right in long periods there is a change of structure type at about the point where, according to Hume-Rothery, the transition from an 8- to an 18-electron shell begins.² In passing from titanium to vanadium, zirconium to columbium, or hafnium to tantalum, the structure type reverts from that of C.N. 12 to one of C.N. 8. At this point, the nuclear charge has been increased without producing quite the proportional decrease in atomic diameter and without increasing the number of valence electrons which determine, in large measure, the binding force. The added electron is identified with the inner shell and is not lost when the metal ionizes. The structural change appears to be related to the addition of the first of the electrons to the *d* shell. Recently Dehlinger³ has suggested independently that structural changes may be correlated with the building up of the *d* shell.

¹ MOTT, N. F., and H. JONES, "Theory of the Properties of Metals and Alloys," Oxford University Press, New York, 1936.

² See p. 80.

³ DEHLINGER, U., *Z. Physik*, **96**, 620 (1935).

Mott and Jones point out that as more *d* electrons are added, the cores (closed *d* shells) finally overlap, repulsive forces come into play and close packing of what may be pictured as hard spheres results. The repulsive forces become sufficiently influential to cause a change to close-packed structures before the *d* shells are completely filled, as is illustrated in the following series:

Element	At. no.	Structure	Element	At. no.	Structure	Element	At. no.	Structure
V	23	<i>b.c.c.</i>	Cb	42	<i>b.c.c.</i>	Ta	73	<i>b.c.c.</i>
Cr	24	<i>b.c.c.</i>	Mo	43	<i>b.c.c.</i>	W	74	<i>b.c.c.</i>
Mn	25	cubic	Ru	44	<i>h.c.p.</i>	Re	75	<i>h.c.p.</i>
Fe	26	<i>b.c.c.-f.c.c.</i>	Rh	45	<i>f.c.c.</i>	Os	76	<i>h.c.p.</i>
Co	27	<i>h.c.p.</i>	Pd	46	<i>f.c.c.</i>	Ir	77	<i>f.c.c.</i>
Ni	28	<i>f.c.c.</i>	Ag	47	<i>f.c.c.</i>	Pt	78	<i>f.c.c.</i>
Cu	29	<i>f.c.c.</i>				Au	79	<i>f.c.c.</i>

Dehlinger¹ has proposed that the properties of the metals depend not only upon the interaction between the free electrons in the lattice, but also upon the interaction between the remaining ionic cores, which influence, in the transition elements, may become very strong.

The ideal structure for the metals is, as we have seen, a close-packed one (C.N. 12). It is interesting to note that the elements vanadium, columbium, chromium, tantalum, molybdenum, and tungsten, which crystallize as body-centered cubes (C.N. 8), can be made to crystallize with a C.N. 12 by the addition of carbon or nitrogen.² The metal atoms in the interstitial compounds are close packed, the carbon and nitrogen atoms being located in the interstices.

We are apparently on the threshold of the development of a theoretical metal chemistry which should prove remarkably interesting.

ATOMIC RADII IN THE METALLIC STATE

The atomic radii of the metals are listed in Table 122, in the Appendix. The radius of an element is perhaps its most dis-

¹ DEHLINGER, U., *Z. Elektrochem.*, **38**, 148 (1932).

² See p. 141.

tinguishing property, and Hume-Rothery¹ has found a very interesting relationship among these radii, which adds to our picture of the metallic state.

A metal has been defined as positive ions surrounded by electrons which are relatively free to move. Apparently only a few electrons are free to move at any instant, so that, on the average, the metal atom is more like a neutral atom than like an ion, as evidenced also by its effective radius.

Further information of the state of ionization in a metallic crystal is to be gained if we compare the interatomic distances determined experimentally, with the atomic structures shown in Table 124, in the Appendix. If Z is the atomic number and n is the quantum number of the outermost group of electrons in the ion, *i.e.*, the outermost complete electron shell, then, for a given value of n , the size of the atom should decrease continuously as Z increases, if all valence electrons are detached. Thus, in the series, Na, Mg, Al, Si, the electronic structure of the ion is 2-8 in all ($n = 2$, see Table 124), but, owing to the increasing nuclear charge, the electrons are drawn closer to the nucleus and the radii decrease in the order Na, Mg, Al, Si. When n increases, *i.e.*, when another complete shell of electrons is added, the atomic radius will increase in spite of the contracting influence of an increase in atomic number. Hume-Rothery found that the following expression defines this qualitative relationship between

Z , n , and the atomic radius d :
$$\frac{d}{n} = \left(\frac{1}{aZ}\right)x.$$
 This relationship he calls the law of subgroups. If it be true, and we then plot $\log d/n$ against $\log Z$, a straight line should be formed by the elements in any one subgroup. Some of the experimental results are shown in Fig. 18. It is evident that the atomic radii within a given group fulfill this relationship; it is also true that the elements in a given period (*e.g.*, Li, Be, C; or K, Ca, Ti, V, Cr) are related in the same way and the relations are connected with the screening effects of the different shells. The slopes of the lines are indicated and increase regularly as 1:1, 1:2, 1:3. The skip to 1:5 occurs when an 18 group of electrons is being built up in the third period.

¹ HUME-ROTHERY, WILLIAM, *Phil. Mag.*, (7) 10, 217 (1930); "The Metallic State," Oxford, Clarendon Press, New York, p. 311, 1931.

This simple relationship between atomic size and atomic structure in metals makes two important contributions to our picture of the metallic state. (1) The straight-line relation for lithium, beryllium, carbon or for sodium, magnesium, silicon suggests that there is no fundamental difference between the truly metallic bond of lithium or sodium and the covalent or homopolar bond of carbon or silicon. We have had other indications of this fact. So also in the series carbon, silicon, titanium, zirconium, and

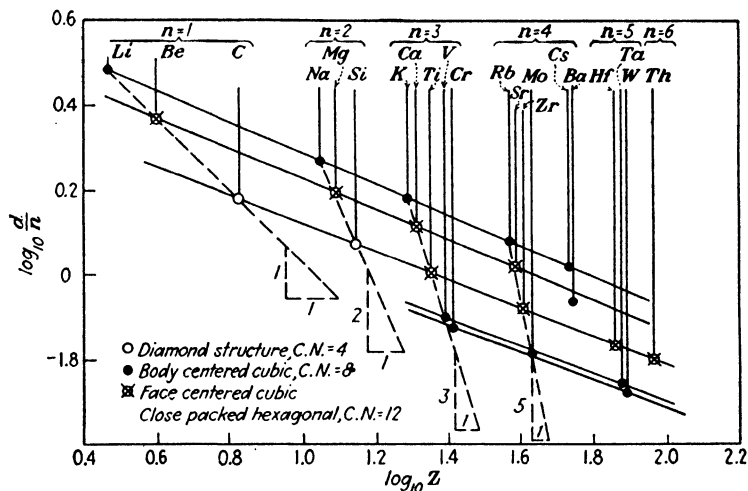

FIG. 18.—The relation of atomic number to atomic radius in the metallic state. $\log d/n$ vs. $\log Z$. [From W. Hume-Rothery, *Phil. Mag.*, **10**, 217 (1930), by permission of the *Philosophical Magazine*.]

hafnium, the atomic radii all lie on the same straight line and there is no suggestion from this source, at any rate, that a transition from a nonmetallic to a metallic element has occurred. (2) From the relation of atomic radius to atomic structure, we are able to learn something of the state of ionization of the atoms as they occur in the metallic state. Because carbon and silicon are admittedly tetravalent, and because titanium, zirconium, and hafnium lie on the same straight line, it may be inferred that these last three are also tetravalent.

It is, of course, a familiar fact that the completion of the long periods in the periodic table is accompanied by a transition in which, to the temporarily stable 8-electron shells, are added more electrons, to the number of 18. In the first long period, for

example, we know that this process starts with scandium and is not completed until the 18-electron shell is filled in nickel. Abnormal variations in atomic radii indicate that this transition period occurs with the ions in the metallic state as it does with the metallic ions when they are studied in combination with negative ions. The interesting question is whether it occurs in the same manner in metallic ions as it does in ionic compounds.

Some light has been thrown on this point. When the $\log Z$ (atomic number) is plotted against $\log d$, where d = the diameter of the atom in the metal, determined experimentally, the curves

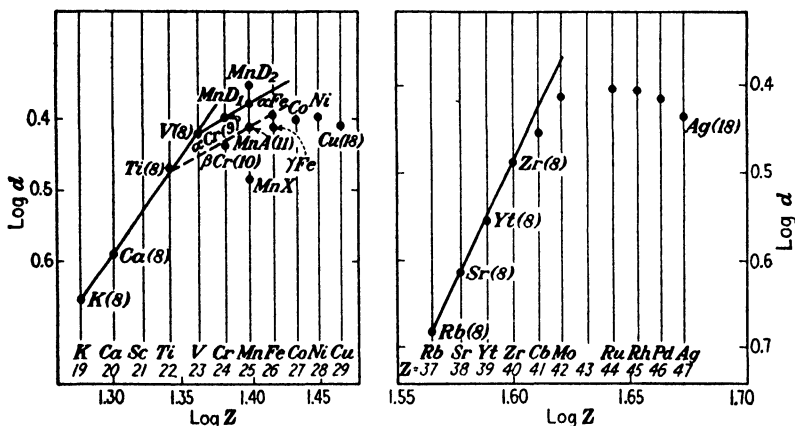

FIG. 19.—The relation of atomic number to atomic radius in the metallic state. [Adapted from W. Hume-Rothery, *Phil. Mag.*, (7) 11, 649 (1931).]

shown in Fig. 19 are obtained. Perhaps the most interesting feature of this figure is the relationship of d and Z for potassium, calcium, (scandium), titanium, and vanadium. Hume-Rothery proposes that, inasmuch as the step from potassium to calcium involves the addition of an electron to the outer shell, the subsequent steps, calcium to titanium to vanadium may involve a similar addition, rather than the addition of an electron to the M_3 subgroup as in the free atoms. With chromium the slope of the curve changes and it is suggested that this may evidence the addition of an electron to the M_3 subgroup, the electronic structure of chromium as it exists in the solid state being 2-8-9-5. Now, there are two crystalline modifications of chromium known and the experimental values for the atomic radii in both forms

have been plotted in Fig. 19. The electronic structure, 2-8-9-5, is that of α chromium. Since the position of β chromium on the diagram appears to be two steps away from titanium, and since each step on a curve with this slope has been taken to signify the addition of one electron to the M_3 subgroup, the electronic structure for β chromium may be designated as 2-8-10-4.

Following this line of reasoning, the electronic structures for the four different-sized manganese atoms were postulated,¹ thus reconciling interatomic distances with degrees of ionization for this group of metals. The same interpretation may be applied to the fourth period metals.²

While this interpretation is simple and straightforward, it is not the only possible one to fit the fact of changing slope.³ From the point of view of the newer electronic theories, the break might correspond, not with the beginning of the transition process, but with the point at which the 4s electron bands and the 3d bands overlap, as regards energy. Furthermore, the assignment of the degree of ionization to these metals must be taken with considerable caution, for the quantum mechanical treatment suggests that in the solid crystal there is no reason why there must be a whole number of 4s electrons per atom of a transition element.⁴

It would seem that allotropy might be expected among the transition metals, since atoms of these may exist in several sizes; and, of course, experience demonstrates that this expectation is realized. Although it has no direct bearing on our subject, it is of interest to know that of those metals which are allotropic a

¹ α -Mn is a body-centered cubic structure containing four kinds of manganese atoms designated X, A, D₁, D₂, characterized by different atomic diameters (BRADLEY, A. J., and J. THEWLIS; *Proc. Roy. Soc. (London)*, **A 115**, 456 (1927).

β -Mn is a complex cubic structure with 20 atoms in the unit cell and the closest distance of approach is 2.365 Å. It is an alloy isomorphous with Ag₃Al and may be considered an alloy of two kinds of manganese atoms. (PRESTON, G. D., *Phil. Mag.*, (7) **5**, 1207 (1928); FAGERBERG, S. and A. WESTGREN, *Metallwirtschaft*, **14**, 265 (1935).

γ -Mn is tetragonal face centered; closest distance of approach, 2.57 Å.

² HUME-ROTHERY, W., *Phil. Mag.*, (7) **11**, 649 (1931).

³ A possibility suggested by Hume-Rothery, private communication.

⁴ See MOTT, N. F., and H. JONES, "The Theory of the Properties of Metals and Alloys," pp. 189-194, 222, Oxford University Press, New York, 1936.

metastable phase can usually be prepared by electrodeposition. This is true of γ manganese,¹ γ chromium,² cobalt,³ and antimony⁴ among others. It should follow that if allotropic forms of elements other than the transition elements are known, they should involve merely a different arrangement of atoms, not a difference in the size of the atoms. This is consistent with a recent X-ray analysis of a high temperature form of calcium. In the usual face-centered cubic form the radius of calcium is 1.97 Å. In the high temperature, body-centered cubic form,⁵ the calcium radius is 1.92 Å, a contraction accounted for by the decrease in coordination number from 12 to 8.

We may follow the comparison of interatomic distances farther into the Class II metals with considerable interest. In copper, silver, and gold the transition process is complete, and there are 18 electrons in the outermost complete shell of the atom. We should therefore expect the interatomic distances to decrease in passing from copper to gallium, for example, inasmuch as the nuclear charge will be increasing, and (assuming normal ionization and the removal of all the valence electrons) the electronic structures of the ions will remain the same. The same should be true of the series silver to tin, and gold to lead. Consider the actual interatomic distances listed in Table 26. Why, for exam-

TABLE 26.—INTERATOMIC DISTANCES IN CERTAIN B-SUBGROUP ELEMENTS

Element	Inter-atomic distance	Element	Inter-atomic distance	Element	Inter-atomic distance
Copper.....	2.55	Silver.....	2.88	Gold.....	2.87
Zinc.....	2.67, 2.92	Cadmium.....	2.96, 3.28	Mercury....	2.99
Gallium.....	2.56	Indium.....	3.24, 3.33	Thallium....	3.40
Germanium..	2.44	Tin: white....	3.07, 3.16	Lead.....	3.48
		grey.....	2.80		

¹ PERSSON, E., and E. OHMAN, *Nature*, **124**, 333 (1929).

² SASAKI, K., and G. SEKITO, *Trans. Electrochem. Soc.*, **59**, 437 (1931).

³ KERSTEN, H., *Physics*, **2**, 204 (1932).

⁴ STILLWELL, C. W., and L. F. AUDRIETH: *J. Am. Chem. Soc.*, **54**, 472 (1932); COHEN, ERNST, and C. C. COFFIN, *Z. physik. Chem.*, **A 149**, 417 (1930).

⁵ GRAF, L., *Metallwirtschaft*, **12**, 649 (1933); *Physik. Z.*, **35**, 551 (1934).

ple, are the interatomic distances in cadmium, indium, and white tin greater than in silver, rather than less?

It is quite evident that, if size is any indication of the state of ionization of an atom in the solid metal, then we must look for some sort of abnormal ionization of these atoms. Referring to Table 124, in the Appendix, it may be observed that when a group of 8 electrons is built up, all 8 are not equivalent, but are grouped, 2 and 6. The chemical properties of the ions of these elements indicate that as we go down in a given group, the 2 electrons first added to the new shell are more stable, tending to remain with the inner 18 shell when the outer electrons split off. Thus, we know that in the case of lead (2-8-18-32-18-2-2) the divalent ion (2-8-18-32-18-2) is more stable than the tetravalent ion (2-8-18-32-18), while for germanium (2-8-18-2-2) the tetravalent ion (2-8-18) is more common. It is within reason to assume, then, that instead of the normal ionization of these metals in the solid state, in the case of indium, thallium, white tin, and lead, 2 electrons of the outermost shell may remain with the atomic core, thus increasing its apparent size. The decreases in atomic distance from copper to germanium and from silver to grey tin are, of course, normal, because germanium and grey tin, having the diamond structure, are sharing their full quota of valence electrons with neighboring atoms, leaving atomic cores with eighteen electrons in the outer shell, as in copper and silver.

Any explanation of the abnormally large atomic diameters of zinc, cadmium, and mercury is a little more uncertain. If it be assumed that the first 2 electrons of the outer shell are stable and remain associated with the next inner shell of 18 electrons, then no electrons would be free to give these elements metallic properties. Hume-Rothery has suggested that these metals are singly ionized. Although this seems, at first consideration, a rather far-fetched assumption, it does account for the larger atomic diameters and, as we shall see presently, for certain other properties of these metals.

Let us summarize briefly the foregoing discussion of the relation between atomic sizes and the corresponding atomic structures of the elements. Several important contributions have been made to our understanding of metals and the metallic state, *viz.*:

1. There appears to be no fundamental difference between the metallic bond and the covalent or homopolar bond.

2. The state of ionization of the atoms in crystalline metals is suggested. In the first long period, potassium to copper, the number of electrons in the *M* shell may begin to increase from 8 to 18 with the element chromium; whereas in the free atoms this transition period begins with scandium. This inference is questionable, as has already been pointed out.

3. The interatomic distances for the crystalline metals of the *B* subgroups [and perhaps for aluminum (Class II metals)], suggest that most of them are incompletely ionized in the metallic state.

4. A possible connection between allotropy and variable atomic diameters is offered, consistent with the known prevalence of allotropy among the transition elements.

THE PROPERTIES OF METALS

Metals are good conductors of heat and electricity. They are opaque and show a characteristic metallic luster. They are ductile and malleable, rather than brittle. These are the properties of the Class I elements of Table 25. A pure metal crystal, when stressed, yields not by cleavage but by the formation of glide planes in which layers of atoms can slip over one another with very little loss of energy. As we pass from left to right in this periodic chart the metallic properties of the elements decrease. For example, in the series copper, zinc, gallium, germanium, the conductivity decreases and the brittleness increases. White tin has many metallic properties, although it is not one of the better conductors of electricity and it is quite brittle. Decided differences in properties are to be expected between the elements in different classes, since the types of bonds involved are different. There are also significant variations in properties to be found among the true metals of Class I.

Electrical and Thermal Conductivity.—It is generally believed that metals conduct the electric current by means of the movement of electrons. Slater has recently demonstrated by wave mechanical calculations¹ that without free electrons no conduction is possible. His calculations, however, suggest that the

¹ SLATER, J. C., *Phys. Rev.*, **36**, 57 (1930).

number of free electrons may be quite small compared with the number of atoms.

The wave mechanics imply that in a perfectly periodic lattice, a beam of electrons moving in a given direction will continue

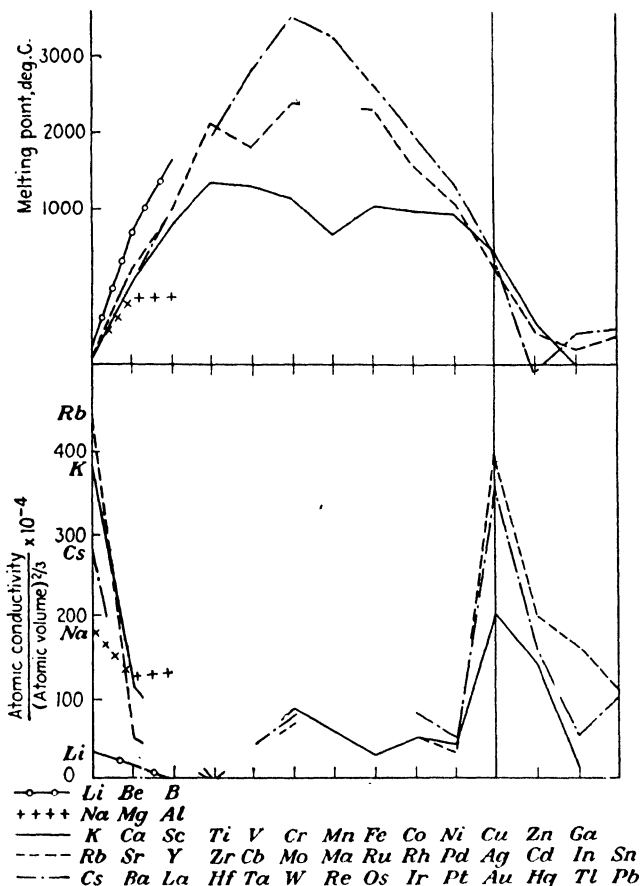

FIG. 20.—(a) Atomic conductivities of the metals. (b) Melting points of the metals. (By permission of the Journal of Chemical Education.)

indefinitely, without resistance. Lack of this perfection results in scattering of electrons and the building up of resistance. Loss of periodicity may result from (1) displacement due to thermal agitation, (2) presence of impurities, (3) change to liquid or amorphous state.

In Fig. 20¹ are plotted the atomic conductivities of the Class I and Class II metals. The Class I metals end at the vertical line drawn toward the right of the chart. The picture is entirely consistent with our conception of the metallic state. The best conductors are those metals whose valence electrons have the greatest mobility, the greatest freedom to carry the current. This is true of those which have only one valence electron, and the data show unmistakably that the univalent metals are the best conductors. The conductivities of divalent metals, whose two electrons are more closely associated with the atomic core, decrease sharply. This has been attributed to the smaller effective number of free electrons in the bivalent metals.² Conductivities probably decrease further for the trivalent metals, although, with the exception of the abnormal aluminum, they have not been determined.

It is interesting to note that the fourth group metals, titanium, zirconium, and hafnium are rather poor conductors. Though they have close-packed hexagonal structures and are classed with the true metals, they retain a strong resemblance to the homopolar members of Group IV (carbon, silicon, and germanium) and it is impossible to avoid the suspicion that here, there are homo-

TABLE 27.—SPECIFIC RESISTANCES (OHMS PER CENTIMETER AT 20°C.) OF THE FOURTH GROUP ELEMENTS*

Silicon.....	85×10^{-3}
Germanium.....	89×10^{-3}
Titanium.....	355×10^{-6}
Zirconium.....	170×10^{-6}
Hafnium.....	35.7×10^{-6}
Copper.....	1.69×10^{-6}

* From HUME-ROTHERY, WILLIAM, "The Metallic State," p. 2, Oxford, Clarendon Press, New York, 1931.

polar forces holding sway.

¹ STILLWELL, C. W., *J. Chem. Education*, **10**, 670 (1933). The specific conductivities of the metals are not very useful for comparison since they involve equal volumes rather than equal numbers of atoms. For derivation of the term plotted in Fig. 20, viz., atomic conductivity—see WILLIAM HUME-ROTHERY, "The Metallic State," p. 4, Oxford, Clarendon Press, New York, 1931.

² MOTT, N. F., *Proc. Phys. Soc. (London)*, **46**, 680 (1934).

Of greater significance is the fact that germanium and titanium show negative temperature coefficients at low temperatures, and with an increase in temperature their resistances pass through a minimum. This phenomenon of minimum resistance is usually assumed to indicate the presence of homopolar bonds (see page 70). On the basis of structure we have made a sharp distinction between the homopolar diamond structure of silicon and germanium and the metallic close-packed hexagonal structure of titanium, zirconium, and hafnium; but although there is a distinct break between germanium and titanium, as shown by the data in Table 27, the last three are more resistant than most of the metals. These data suggest, again, that there is no fundamental difference between the metallic and homopolar bond. The wave mechanical zone theory says simply that in going down a group in the periodic table the atomic states become more closely spaced and the overlapping of energy bands becomes more pronounced.

The "ups and downs" in conductivity from vanadium (columbium and tantalum) through nickel (palladium and platinum) are probably due to the variable number of electrons in the outer shell of these transition elements and, being familiar with their electronic structures, we should expect the conductivities to be more or less the same. Conductivities are low, possibly because the incomplete *d* shells give rise to greater scattering. At copper, silver, and gold the transition period comes to an end and these three have only one electron in the outer shell. They are therefore more or less comparable to the alkali metals in conductivity.

In passing across the line to the Class II metals, the conductivity data are not readily interpreted. These are abnormal structures and the atoms may be only partially ionized.

Aluminum stands out on the chart as an exception to the general trend. Its conductivity is actually greater than that of magnesium. This is entirely in accord with the assumption, made on the basis of an abnormally large interatomic distance, that aluminum may be only singly ionized in the metallic state. Other properties of aluminum will bear this out.

Although the details are undeveloped and beyond the scope of this book, it is a matter of great interest that, with the develop-

ment of a technique for growing large single crystals of metals, it has been found that the resistance of a given metal differs along different crystallographic axes.¹

Conductivity and other properties of metals are affected, not only by temperature, but also by small amounts of impurities,² by internal strains, tension and compression, and by deformation. These factors may have an unexpectedly strong influence. It is therefore very difficult to obtain truly comparable conductivity data for the metals and any attempt to systematize such data is made just so much more difficult and unsatisfactory.

Superconductivity.—Ordinarily, as has been pointed out, the resistance of a metal decreases as its temperature decreases. In some metals, when the temperature reaches a very low value, say 4°K., the resistance practically vanishes. Such metals are said to be superconducting. The real significance of this phenomenon is not understood. Some think it occurs at the point where traces of impurities are frozen out of the metals since it is known that minute quantities of impurities often cause a marked increase in resistance. It is true that the elements which exhibit superconductivity are those whose dissolving powers are relatively low (lead, mercury, tin, indium, thallium, gallium, thorium, etc.). Kapitza³ has proposed that the resistance of all metals is the sum of two additive terms: One decreases with temperature and vanishes near absolute zero; the other is independent of temperature, constant for any single specimen, but a function of lattice distortion as caused by strain or impurities. He suggests that all metals might be superconductors if they could be obtained absolutely pure and free of strain and this is consistent with the known conditions for maximum conductivity. It has been

¹ For greater detail on this point and on all other thermal and electrical properties of metals discussed in these pages, see *ibid.*, and MOTT, N. F., and H. JONES, "Theory of the Properties of Metals and Alloys," Oxford University Press, New York, 1936.

² Two-tenth per cent of antimony in tellurium, for example, increases the conductivity of the latter a hundred-fold. CARTWRIGHT and HABERFIELD, *Nature*, **134**, 287 (1934). The addition of antimony or any similar element to a true metal, on the other hand, usually reduces the conductivity of the latter markedly.

³ KAPITZA, P., *Proc. Roy. Soc. (London)*, **123**, 292 (1929).

observed that superconducting metals are badly cracked but very pure. Slater suggests¹ that by the application of perturbation theory to Bloch's theory it may be possible to account for lack of superconductivity in the alkalis and copper, silver, and gold; while superconductivity at extremely low temperatures might be predicted for the transition elements.

It has also been shown that superconductivity may be a property of the crystal rather than of the atom. A bismuth-gold eutectic is superconducting, whereas gold and bismuth are not.²

Ferromagnetism.—The elementary magnetic particle is the spinning electron. The outer electrons of an atom are largely responsible for cohesion and conduction in the metallic state, but they probably cannot produce magnetism. Electrons with smaller orbits must be responsible. Slater has made some interesting calculations which suggest, at least, that certain inner electrons of iron, cobalt, and nickel are in the best position to cause ferromagnetism, and these are the only elements which are ferromagnetic.³ They conform to a certain limiting ratio between the diameter of the atom and the diameter of the incomplete electron shell. In a magnetic field, electrons may be parallel to or opposite to the field but not at any other angles. The band for $3d$ electrons is subdivided into two identical bands, one for each orientation, and each can hold five electrons. Thus iron, having 7.3, $3d$ electrons will have five in one band and 2.3 in the other, with a magnetic moment of 2.7 (5-2.3). Cobalt, having 8.3, $3d$ electrons, will have a magnetic moment of 1.7 (5-3.3). The magnetic moment of nickel (9.4, $3d$ electrons) is only 0.6; while that of copper with 10, $3d$ electrons is zero.⁴

A very interesting elementary discussion of ferromagnetic theory has been given by Bozorth⁵ in which is described the dependence of magnetism upon temperature, crystallographic direction, the orientation of crystal grains in rolled metals, strains, heat treatments, and the like.

¹ SLATER, J. C., *Phys. Rev.*, **51**, 195 (1937).

² DE HAAS, W. J., *Nature*, **213**, 130 (1929).

³ SLATER, J. C., *Phys. Rev.*, **36**, 57 (1930).

⁴ SLATER, J. C., *J. Applied Phys.*, **8**, 385 (1937).

⁵ BOZORTH, R. M., *Elec. Eng.*, **54**, 1251 (1935).

Thermal Conductivity.—It is a familiar fact, and a very important one from the industrial standpoint, that metals are notably good conductors of heat. Were it not for this fact, modern power development by steam and the internal combustion engine would be impossible.

The mechanism of thermal conductivity is not so well understood as that of electrical conductivity, and it is impossible to make any satisfactory generalizations concerning this property. The Wiedemann-Franz law states that at ordinary temperatures the ratio of the thermal and electrical conductivities is constant for all metals. This law is approximately true. The noble metals, copper, silver, and gold, have the highest thermal conductivities and, of the three, silver is highest, a further indication, perhaps, that it is the most consistently univalent of the three. The aluminum kitchenware salesman will point out that aluminum has a high thermal conductivity. It is exceptionally high, greater than all the univalent alkali metals and exceeded only by copper, silver, and gold. This suggests again that it may be a univalent element in the metallic state.

Melting Points—Strength.—If weak electrons, weakly held, make for maximum conductivity, both electrical and thermal, in metals, they would also be expected to produce the weakest crystals. It is interesting, therefore, to consider the melting points of the metals plotted in Fig. 20b. Although there are intermediate variations which are not explained by our simple picture of a metal, in general, the poorest conductors of electricity are the stronger crystals. The one electron of the alkali metal is comparatively free to transfer heat or electricity and its mobility weakens the crystalline structure; the four electrons of titanium are not able to break away from the parent atom so completely and a much stronger crystal results. Tungsten has the highest melting point of any of the metals. Seitz and Johnson¹ point out that according to the zone theory as the number of valence electrons increases, cohesion should increase until the depressed zones, the *s* and *d* states, are filled. Then, as additional valence electrons are added, cohesion may be expected to decrease again. Thus, in the second series, iron with eight

¹ SEITZ, FREDERICK, and R. P. JOHNSON, *J. Applied Phys.*, **8**, 84 (1937).

electrons has the highest melting point and in the fourth series, tungsten with six.

The melting points of zinc, cadmium, mercury, gallium, indium, thallium, white tin, and lead are abnormally low. Thus in the *A* subgroups of the periodic table the melting points rise in passing from Group I to Group IV, while in the *B* subgroups the reverse is true. This contributes further to the accumulating evidence in favor of an abnormal ionization of these metals. If they are actually univalent or divalent in the metallic state, their melting points are more in line with expectations. Again, aluminum is to be particularly observed. We have seen that the conductivity of aluminum is greater than expected, and it follows that the metal should be abnormally weak and have a low melting point, as it has.

Additional circumstantial evidence has been amassed by Hume-Rothery which indicates abnormal ionization of these *B* subgroup elements and of aluminum. The electrode potentials of some of the Group I and Group II metals are shown in Table 28.¹

TABLE 28.—ELECTRODE POTENTIALS OF GROUP I AND GROUP II METALS, IN VOLTS

	I	II	III	IV
<i>A</i>	Sodium..... 2.71 Potassium... 2.92	Magnesium. 1.49 Calcium.... 2.5	Aluminum... 1.4	
<i>B</i>	Copper..... -0.36 Silver..... -0.80	Zinc..... 0.76 Cadmium... 0.40		Tin.. 0.14

Those of Group IIA are lower than those of Group IA, but those of Group IIB are higher than the metals of Group IB. If the ionization were normal throughout, the direction of change should be the same in both cases.

The minimum frequency required to produce a photoelectric effect is decidedly larger for the alkaline earths than for the alkalis, *i.e.*, it takes more energy to excite the electrons in a divalent metal than in a univalent metal. This is in keeping

¹ HUME-ROTHERY, WILLIAM, "The Metallic State," p. 158, Oxford, Clarendon Press, New York, 1931.

with the comparisons of other metallic properties which have been made. But there is no significant difference in the frequencies for the metals copper, silver, zinc, and cadmium, suggesting that they may all exist in the crystalline state as univalent ions. It is of particular interest to find that aluminum is definitely grouped with the alkali metals as regards its minimum emission frequency, which may be accepted as further evidence of a univalent aluminum ion in the metallic state.

The relatively low melting points of the Class III elements, except the homopolar carbon, silicon, and germanium, are due, of course to the failure of the weak bonds between layers (in arsenic, antimony, and bismuth), between chains (in selenium and tellurium), or between molecules (iodine).

Tensile Strength, Hardness, Ductility. The Mosaic Structure of Crystals.—The theory of the mosaic structure¹ of crystals has recently been proposed by Zwicky² and by Smekal³ to account for a great many characteristic properties of real crystals in general. It has long been supposed, for example, that the actual strength of a rock salt crystal (0.2 kg. per square millimeter) is only a small fraction of the calculated strength (200 kg. per square millimeter). Zwicky has suggested that cracks form in a growing crystal, spaced about 100 Å apart in all three crystallographic directions, to form a permanent secondary structure in the real crystal—blocks about 100 Å on a side, which may be pulled apart with comparative ease. As an alternative Zwicky proposed that there is a secondary structure superimposed on the ideal, not through discontinuous blocks, but because every *n*th plane of the lattice has a higher electron density than the other planes. Smekal's mosaic structure is a block formation.

The proponents of the mosaic structure explain abnormal electrical conductivities of crystals, plastic flow, and the hardening of metals and alloys by cold working. Slippage is assumed

¹ See GIBBS, R. E., *Science Progress*, **29**, 661 (1935) for a very readable account. For a detailed discussion of real crystals see: Report of the International Conference on Physics on "The Solid State of Matter"; The Physical Society, London, 1935; also, *Z. Krist.*, **89**, 193–415 (1934).

² ZWICKY, F., *Proc. Nat. Acad. Sci.*, **15**, 253, 816 (1929); **17**, 574 (1931); *Phys. Rev.*, **38**, 1772 (1931); **40**, 63 (1932); **43**, 370 (1933); *Mech. Eng.*, **55**, 427 (1933); *Rev. Modern Phys.*, **6**, 193 (1934).

³ SMEKAL, ADOLF, *Phys. Rev.*, **44**, 308 (1933); *Z. Krist.*, **89**, 386 (1934).

to occur along the weak planes in which the atoms are most concentrated and in the amorphous state (Zwicky), or in crevices which separate the blocks.

It must be emphasized that there is no direct evidence of the existence of this secondary, or mosaic structure. It is entirely a theoretical picture which is said to account for many supposed peculiarities of real crystals. There are many who feel that this theory is not necessary to explain these properties and that the significance of this indirect evidence has been exaggerated.

Recently Buckley¹ has refuted the theory in detail. He points to the work of Joffe,² suggesting that the asterism of a Laue pattern produced by a strained single crystal and abnormal electrical conductivities³ are not necessarily due to a mosaic structure. Joffe⁴ has also found that the actual tensile strength of rock salt crystals from which the obvious surface imperfections have been removed is of the same order of magnitude (70 to 160 kg. per square millimeter) as the calculated strength. It appears, then, that no surface striations or crevices, or figures of any kind, can logically be accepted as evidence of a secondary structure throughout the crystal. In short, much of the experimental data upon which the mosaic structure is postulated is, at best, ambiguous and subject to misinterpretation. Buckley also offers additional data which suggest that the large majority of actual crystals are without a secondary structure.

For example, crystals may be grown as thin plates or hairs with linear dimensions less than those of the proposed mosaic blocks.⁵

Buerger⁶ carries the matter even farther. He believes that the data assumed to support the theory of a mosaic structure, particularly the observations of single crystals of bismuth "are really misinterpreted, well-understood phenomena; the theory itself is not in harmony with crystal phenomena, is internally inconsistent, and its theoretical prediction is based on a fallacy."

¹ BUCKLEY, H. E., *Z. Krist.*, **89**, 211 (1934).

² JOFFE, A., and M. V. KIRPETCHEVA, *Phil. Mag.*, **43**, 204 (1922).

³ JOFFE, A., *Trans. Faraday Soc.*, **24**, 65 (1928).

⁴ JOFFE, A., and M. LEVITSKII, *Z. Physik*, **35**, 442 (1926).

⁵ BERNAL, J. D., *Ann. Repts. (London)*, **32**, 190 (1935).

⁶ BUERGER, M. J., *Z. Krist.*, **89**, 242 (1934).

At present, this whole subject is highly controversial. It seems fairly evident that crystals do grow with imperfections, but the nature of these imperfections is speculative. Buerger has proposed a so-called "lineage structure"—an imperfect but *continuous* growth from dendrites which appears very promising.

Tensile Strength, Hardness.—It is customary to consider the hardness or tensile strength of a crystal as a measure of its strength, and one would therefore expect these properties of metals to vary in the same regular manner as do the melting points. There is a general agreement in that the low melting metals are soft and exhibit low tensile strength, as the data of Table 29 will show. It is unwise to carry the analogy too far,

TABLE 29.—TENSILE STRENGTH, HARDNESS, AND MELTING POINTS OF COMMON METALS*

Metals	Tensile strength, lb. per square inch	Hardness, Moh	Melting point, °C.
Iron, hard drawn.....	80,000–100,000	4–5	1530
Aluminum, wire.....	30,000– 40,000	2	658
Magnesium, drawn.....	33,000		651
Gold, wire.....	20,000	2.5–3	1063
Silver, wire.....	42,000	2.5–3	960
Copper, wire.....	60,000– 70,000	2.5–3	1080
Lead, drawn.....	2,600– 3,300	1.5	327
Tin, drawn.....	4,000– 5,000	1.5	232
Tungsten, drawn.....	590,000		3400
Nickel, drawn.....	155,000		1452

* "Handbook of Physics and Chemistry," *Chemical Rubber Publishing Company*, New York, 1931.

however, because tensile strength and hardness may be greatly influenced by the manner of working of the metal,¹ and it is difficult to obtain comparative data even for metals which have all been treated the same way.

Ductility.—The ductility of metals is apparently closely related to their crystal structures as well as to their electronic structures. A truly metallic crystal yields by the formation of glide planes in which layers of atoms apparently slip over each other with little

¹ The above figures are all for wire, cold drawn. These are much higher than the figures for castings of the same metals.

loss of energy. In this respect they differ from ionic or homopolar crystals which yield by cleavage or fracture. Bernal¹ has suggested that an absolutely pure metal might lose no energy at all when gliding, its behavior being identical with that of a liquid except that its atoms are regularly ordered. The electronic energy of true metals appears to be a function of the volume of the unit cell rather than its shape. Hence a deformation can occur with a very small change in energy. It has long been known that metals, like liquids, exhibit surface tension. Gold leaflets, heated to 850°C. (melting point 1063°C.) on a silver plate become spherical. Metallic crystals form dendrites, but the edges are rounded, a manifestation of surface tension. (The edges of crystals of true metallic compounds are sharp.) The surface tension of molten metals has been measured and some are listed in Table 30. Possibly the same order of surface tension values is retained in the solids, because it has been observed that the higher the surface tension of the liquid metal, the more rounded are the corners of the solid dendrites.² It may be seen

TABLE 30.—SURFACE TENSIONS OF MOLTEN METALS

Metal	Temperature, °C.	Dynes per centimeter
Copper.....	1120	1128
Gold.....	1131	1103
Silver.....	998	923
Zinc.....	419	758
Cadmium.....	320	630
Tin.....	232	526
Mercury.....	20	465
Lead.....	327	452
Bismuth.....	269	378
Antimony.....	640	350

that the most metallic elements have the highest surface tensions. This circumstantial evidence further justifies the analogy we have assumed between the behavior of metals and liquids under stress.

¹ BERNAL, J. D., *Trans. Faraday Soc.*, **25**, 367 (1929).

² DESCH, C. H., "The Chemistry of Solids," Cayuga Press, Ithaca, N. Y., 1934.

Now, in keeping with the assumption that metals yield along glide planes in which layers of atoms slip over each other, we find that those metals whose crystal structures afford the greatest number of closely packed planes of flow are the most ductile and harden more readily by cold working. All the true metals are close-packed structures, but of these, the face-centered cubic has the greatest possible number of planes, and metals with the face-centered cubic structure are, as a rule, more ductile.

When a metal does give along close-packed planes of atoms, these planes are gradually disrupted. Continued cold working of a metal, then, produces distortion and a resistance to stress is gradually built up in the crystal, making it harder and less ductile.¹ It has been proposed that excessive cold working may actually convert a metal from the crystalline to the amorphous state.² Although this theory explains many metallurgical facts, there have not been, until recently, experimental data to support it. It should be possible, by reducing a metal to a very fine wire, to convert it entirely into this amorphous state, but this has never been accomplished. The results of electron diffraction experiments now appear to support the theory. It has been reported that a highly polished metal surface gives no evidence of the known crystalline structure of the metal.³ Although Kirchner⁴ and Germer⁵ have attributed this to a mere flattening of the surface, the majority opinion is in favor of the amorphous layer.

Color.—The color of a crystal is due to the effect of the electrons vibrating within it. Thus, a blue crystal appears blue because the frequency of vibration of the electrons is such that all the wave lengths of light complementary to blue are absorbed passing through the crystal. In a black substance such as charcoal the electrons are held with varying degrees of firmness, sup-

¹ See a recent theoretical discussion by G. I. Taylor, *Proc. Roy. Soc. (London)*, **A 145**, 362, 388 (1934).

² BELBY, G. T., *Proc. Roy. Soc. (London)*, **72**, 218 (1903).

³ THOMPSON, G. P., "Wave Mechanics of Free Electrons," p. 158, Cornell University Press, Ithaca, N. Y.; FRENCH, R. C., *Nature*, **129**, 169 (1932); DARBYSHIRE, J. A., and K. R. DIXIT, *Phil. Mag.*, **12**, 961 (1933); RALTHER, Z. *Physik*, **86**, 82 (1933).

⁴ KIRCHNER, F., *Nature*, **129**, 545 (1932).

⁵ GERMER, L. H., *Phys. Rev.*, **43**, 724 (1933).

posedly, so that all light is absorbed. In most metals the electrons absorb all frequencies, but they immediately radiate them all again, owing to the behavior of the relatively mobile electrons of the metallic bond. This gives rise to the familiar metallic luster. The metallic luster of arsenic, antimony, bismuth, selenium, and tellurium gives reason for believing that some of the bonds in these elements must be metallic. It is a strange coincidence that the only colored metals, gold and copper, are also unique in that they frequently occur in valences higher than their location in Group I of the periodic table would seem to permit. The color of these metals has been attributed to the instability of their atomic cores, the possibility not only of mobile electrons, a characteristic of all metals, but of a varying number of these electrons.¹

Carbon is an unusual case. In diamond all the electrons are firmly held in homopolar bonds and no color is absorbed. In the graphite layer lattice, there are some "metallic" electrons forming part of the interlayer load which are unshared and are probably responsible for the metallic luster of graphite as well as for its other metallic properties.

¹ DEHLINGER, U., *Z. Elektrochem.*, **38**, 148 (1932).

CHAPTER IV

THE NATURE OF ALLOYS

Civilization has passed through a Stone Age, a Bronze Age, and an Iron Age and is, at present, entering the Age of Alloys. Although bronze, one of the most useful of alloys, was known to the ancients, they did not understand it as alloys are understood today. With our increasing knowledge of the fundamental nature of alloys, it is to be expected that eventually they will be modified or developed to meet practically all of the demands of modern industry.

Any discussion of the crystal chemistry of alloys, even though it be limited to the binary systems, must be undertaken with extreme caution, for the metallic state is still not thoroughly understood. Furthermore, of the three thousand odd possible binary alloy systems, only one or two hundred have been studied by X rays and many of these incompletely. Most of the systematic work has been done on the low melting binary alloys, copper, silver, or gold, with aluminum or one of the abnormal metals of the *B* subgroups. Alloy systems of the transition metals, except steels, have hardly been touched, and the properties of the alkali and alkaline earth alloys are not well known.

While it is our purpose to correlate crystal structure data and attempt to develop therefrom a systematized crystal chemistry of alloys, it must be emphasized that many of the generalizations proposed are based on fragmentary data and on alloys limited to a special area in the periodic table. These are the first words of an infant science of metals, and not the authoritative generalizations based on thorough knowledge of the subject. Further development of the crystal chemistry of alloys awaits the accumulation of accurate experimental data; and conclusions drawn now will no doubt be altered profoundly as additional data reveal a more complete picture of alloys.

THE FORMATION OF ALLOYS

Alloy systems of two or more metals may be prepared in a number of ways. They are usually made by melting the metal which is to be present in largest proportion, adding to it the other metals and allowing the resulting melt to solidify. When this takes place, one (or two) of three things may happen:

1. The two metals may crystallize independently. The alloy will consist of an intimate mixture of the two crystal forms. Its electrical and thermal properties are apt to be the average of those of the two constituents.

2. The metals may form solid solutions.

3. The metals may form intermediate phases.¹ These may be formed either by two metals which are immiscible, or which are mutually soluble in the solid state.

Alloys may also be formed by the diffusion of one solid metal into another; or of a molten metal into a solid metal; or by pressing the powdered constituents of an alloy together and sintering at suitable temperatures.

The simultaneous electrodeposition of two or more metals forms an alloy. The same solid solutions and intermediate phases are to be found as occur in thermal alloys of the same compositions.² It is true that the conditions under which electroplating is carried out do have minor effects on the nature of the deposit. For example, an alloy deposited at low current density is, as might be expected, more structurally homogeneous than one deposited at high current density.³ The electrodeposition of an alloy of a given type can be very useful from a commercial standpoint, for advantage can be taken of the marked difference in properties of solid solutions and intermediate phases, which will be discussed later.

¹ At present there is no general agreement as to the criteria for an intermetallic compound; and the use of the general term "intermediate phase" to include all alloy phases other than primary solid solutions is convenient.

² NAKAMURA, HAZINE, *Sci. Papers Inst. Phys. Chem. Res. (Tokyo)*, **2**, 287 (1925). STILLWELL, C. W., and L. E. STOUT, *J. Am. Chem. Soc.*, **54**, 2583 (1932).

³ STILLWELL, C. W., and H. I. FEINBERG, *J. Am. Chem. Soc.*, **55**, 1864 (1933).

Alloys are also modified by corrosion. When an alloy is corroded, the more active of the two metals may dissolve, leaving a new alloy richer in the less active metal. This new alloy will have the same structural characteristics as a thermal alloy of the same composition. Thus, copper may be dissolved from a solid solution of copper in gold, leaving, not pure gold, but a solid solution, richer in gold than was the original;¹ or zinc may be dissolved from an intermediate phase of copper and zinc, leaving, not pure copper, but another phase with a different crystal structure, containing more copper than the original.² A more complete understanding of the effect of corrosion on the structure of alloys should be of considerable practical value in a fundamental attack on this important problem.

An alloy may also be modified by vaporization, for the removal of zinc from a copper-zinc alloy in this manner produces the same structural changes as does its removal by corrosion.

SOLID SOLUTIONS

A solid solution is homogeneous and its composition may vary within certain limits. In this respect it is like any other solution. Let us consider it from the standpoint of crystal structure.

Primary Substitutional Solid Solutions.—Nickel may be dissolved in copper, forming a solid solution. During this process the nickel atoms replace copper atoms in the face-centered cubic copper lattice. Inasmuch as nickel atoms also tend to form a face-centered cubic lattice, the replacement may proceed continuously, with no change in the crystal structure, until all of the copper atoms have been replaced by nickel. There will, of course, be a change in the size of the unit cell of the crystal commensurate with the sizes of the atoms. Nickel and copper are said to form a continuous series of solid solutions.

Chromium may be dissolved in nickel, forming a solid solution. During this process the chromium atoms replace nickel atoms in the face-centered cubic nickel lattice. When approximately 35 per cent of the lattice points have been filled by chromium

¹ GRAF, L., *Metallwirtschaft*, **11**, 77 (1932).

² STILLWELL, C. W., and E. S. TURNIPSEED, *Ind. Eng. Chem.*, **26**, 740 (1934).

atoms, the nickel lattice cannot accept any more chromium. It is convenient to say that, at this point, nickel (the solvent) is saturated with chromium (the solute). If any more chromium is added, a second crystal structure appears, the body-centered cubic form of chromium, in which about 2 per cent of the lattice points are occupied by nickel atoms. At intermediate concentrations, then, two immiscible phases coexist at room temperature; a saturated solid solution of nickel in chromium, and a saturated solid solution of chromium in nickel.

In a solid solution, the solute atoms usually are distributed at random in the solvent lattice. In the nickel-chromium solid solution, 35 per cent of the nickel lattice positions are occupied by chromium atoms, but there is no regularity of arrangement of these atoms. In many solid solutions, *e.g.*, Cu-Au and Fe-Al, the arrangement is completely random above a definite critical temperature and as the temperature is lowered the atoms become rearranged in a definite order at the critical temperature.¹

What are the rules, if any, governing solid solution formation? When will metals be miscible in the solid state, and to what extent? Can the degree of solid solubility be predicted for a given pair? The formulation of rules giving the answers to these questions is a difficult one which has been only partially successful.

Pertinent facts relating to alloy formation are summarized in Chart A, following page 424. By arranging all of the elements in the same order away from the origin, both horizontally and vertically, a space is provided on the chart for each possible binary system. First from the origin are those elements with the typical metallic structure, the Class I (see Table 25) metals. Following these are the Class II (abnormal) metals, still predominantly metallic in structure and properties. Further to the right (and nearest the top), are the nonmetallic, electro-negative elements. With this arrangement of coordinates, the binary systems group themselves naturally in three classes. The alloys, the majority of which are systems of two electropositive elements, are to be found on the chart in Zones I, II, III, IV, V, (VI, VII).

¹ See discussion on p. 151.

The alloy region has been designed to show, as far as possible, the conditions under which two metals in the solid state will be completely miscible, mutually soluble, partly soluble, immiscible;¹ or when they may be expected to form intermediate phases or superstructures. When these characteristics of each individual alloy have been recorded on the chart, four rather well-defined zones—areas in which all the systems possess similar properties—are apparent.

1. In Zone I, including pairs of the alkali and alkaline earth metals, the metals are generally immiscible but may form intermediate phases.

2. At the other extreme are the alloys of Zone IV, the eighth group transition elements and the noble metals. Complete miscibility predominates in Zone IV; there is almost no tendency toward intermediate phase formation other than superstructures² most of which are to be found in this zone. When the metals are not completely miscible, they are at least mutually soluble, with the exception of silver, and, to some extent, copper.

3. Zones II and III are intermediate in regard to the types of alloys they include. The little evidence available suggests that the tendency for solid solubility decreases in going from Zone IV to Zone I, while the chances for intermediate phase formation seem to be greatest in the two intermediate zones.

4. All but a small corner of Zone V includes alloys of a true metal (Class I) with an abnormal (Class II) metal. It is apparent that under these conditions there is a marked decrease in solid solubility. A minority of metal pairs are mutually soluble to a limited extent. They are apt to be immiscible, or nearly so, or there is a range of solid solubility of the abnormal metal in the true metal lattice. In Zone V intermediate phases predominate. The chance for their formation seems to be about 10 to 1.

The chart affords a fairly complete bird's-eye view of the facts with which one must reckon in any attempted generalization regarding alloy formation. Before reaching any generalization it is necessary to determine the factors which influence solid

¹ Absolute immiscibility of two metals in the solid state is rather unlikely. It is most likely that there are always a few atoms of metal *A* which dissolve in metal *B* and vice versa. The term "immiscible," as used here, is relative.

² See p. 151.

solubility and the nature of the intermediate phases in an alloy. For the present we are concerned chiefly with the possibility of solid solution.

Hume-Rothery and coworkers have considered systematically the relation between atomic sizes and the solid solution limits for a number of alloys of copper and silver with the other elements.¹

The influence of the size factor upon solid solution formation is illustrated in Fig. 21. The atomic diameters are plotted ver-

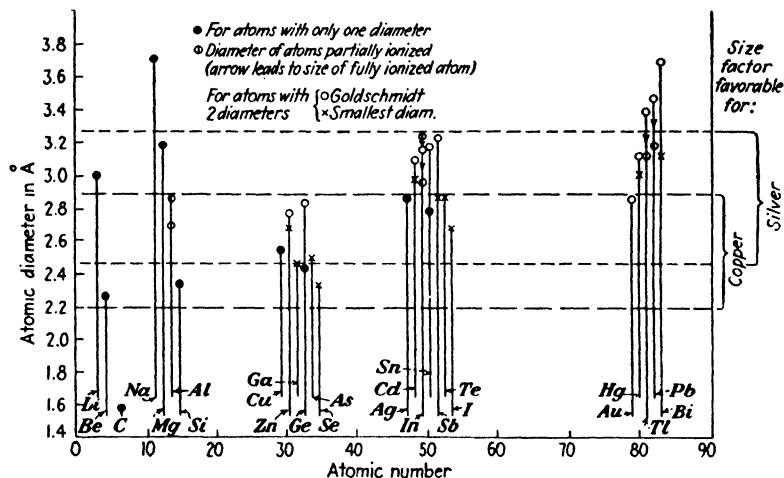

FIG. 21.—Metallic radii. [From W. Hume-Rothery, G. W. Mabbott and K. M. Channel-Evans; *Trans. Roy. Soc. (London)*, **A233**, 1 (1934), by permission of the Royal Society.]

tically. Of course, in many metallic lattices, atoms may have two or more sets of neighbors at different distances in the crystal. In the figure the atomic diameter is considered as the closest distance of approach. For those atoms which are thought to be incompletely ionized in the metallic state, two values are given in the figure. The diameter of the completely ionized atom is probably more important in connection with solid solutions in silver and copper, and this has been estimated as 0.3 Å less than the diameter of the partially ionized metal.

¹ HUME-ROTHERY, WILLIAM, G. W. MABBOTT, and K. M. CHANNEL-EVANS, *Trans. Roy. Soc. (London)*, **A 233**, 1 (1934); HUME-ROTHERY, WILLIAM, "The Structure of Metals and Alloys," p. 52, The Institute of Metals, London, 1936.

A zone has been marked off with a width of 0.35 Å from the atomic diameter of copper, representing a range of diameter 13.8 per cent that of copper; a similar zone of favorable sizes is outlined for silver. It is proposed that metals whose diameters place them outside of these zones, dissolve only to a very limited extent in the solvent. Metals lying within the favorable zone dissolve rather readily, and the extent of their solubility is a function of the valence effects to be described.

The overlapping of the two zones explains at once some apparent anomalies among solid solutions. It is obvious, for example, why there should be such wide solid-solution ranges in the systems Cu-Zn, Ag-Zn, Ag-Cd, Ag-Hg, but not in the systems Cu-Cd and Cu-Hg. The diameter of zinc places it in the favorable zones for both copper and silver, while cadmium and mercury lie within the silver zone but outside of the copper zone. It might be predicted that Ag-Mg would form solid solutions while Cu-Mg would not, and this is actually the case.

The influence of the size factor appears to apply also to solid solutions in which a divalent metal, typified by magnesium or iron, is the solvent.¹ In some cases, however, it is unwise to lay too much stress on the importance of relative atomic sizes. The systems silver-gold and silver-aluminum, for example, are very different structurally, although the atomic radii of gold and aluminum are identical.

Metals do not always form extensive solid solutions even when the size factor is favorable. Evidence has been gradually accumulating which suggests that the electronic structures of the atoms involved play important roles in solid solution formation. Two metals with the same valence, are apt to be miscible in all proportions. On the other hand when a strong electropositive and a strong electronegative element alloy, they tend to form a stable compound at the expense of the solid solution. With copper and silver, the sixth group elements, sulfur, selenium, and tellurium form very limited solid solutions but very stable compounds. The increasing solid solubility with decreasing electronegativity of the solute is illustrated in Table 31.²

¹ *Ibid.*, p. 35.

² *Ibid.*, p. 56.

Because they are more electropositive, the alkali metals and magnesium form more restricted solid solutions with fourth, fifth, and sixth group elements than do copper and silver.

TABLE 31.—INFLUENCE OF ELECTRONEGATIVITY OF THE SOLUTE UPON THE EXTENT OF SOLID SOLUTION*

System	Size factor	Max. solid solubility of electronegative element, atomic per cent
Cu-P	Unfavorable	2.3 +
Cu-As	Favorable	6.2 +
Cu-Sb	Favorable	5.5 +
Cu-Si	Favorable	14.0
Cu-Ge	Favorable	12.0
Cu-Sn	Border line	9.26
Ag-Sb	Favorable	7.0
Ag-Bi	Favorable	2.9 in slowly cooled alloys
Ag-Ge	Favorable	6-7
Ag-Sn	Favorable	12.2

* MERTZ, J. C., and C. H. MATHEWSON, *Metal Technology*, **3**, 747 (1936), have recently reported approximately 6.5 atomic per cent As at 300-680°C.; 1 atomic per cent Sb at 211°C. and 6 atomic per cent at 630°C.; 1.3 atomic per cent P at 300°C. and 3.6 atomic per cent at 700°C.

That extensive solid solutions should be formed only when both metals are relatively electropositive is to be expected and is applicable to alloy systems in general. Only under such conditions does the metallic bond prevail; as one element becomes electronegative with respect to the other, the bonds become more strongly ionic or covalent and compound formation is favored.

In binary systems with a favorable size factor the metal of lower valency is usually the better solvent. Thus, in their binary systems, copper and silver can generally dissolve more of the second metal than the latter can dissolve of silver or copper. Bernal¹ pointed out some years ago that the dissolving power of zinc is only about one-tenth that of copper, while that of aluminum is only one-twentieth that of copper.

Solid Solubility.—Electronic factors which may define the extent of solid solubility in the copper and silver alloys studied by Hume-Rothery are of considerable interest.

¹ BERNAL, J. D., *Trans. Faraday Soc.*, **25**, 371 (1929).

An inspection of the data in Table 32, for metal pairs in which the atomic size factors are favorable, shows rather strikingly that the maximum solid solubility in the primary solid solution corresponds approximately to a constant electron concentration of about 1.4. Stated differently, the maximum solid solubility is inversely proportional to the valence, *i.e.*, for solid solutions of cadmium, indium, or tin in silver, as the valence of the solute

TABLE 32.—ELECTRON CONCENTRATION IN SATURATED SOLID SOLUTIONS*

Alloy system	Valence of solute	Maximum solubility, atomic per cent	Electron concentration †
Cu-Be	2	16.6	1.166
Cu-Zn	2	38.4	1.384
Cu-Al	3	20.38	1.408
Cu-Ga	3	20.3	1.406
Cu-Si	4	14.0	1.42
Cu-Ge	4	12.0	1.36
Cu-Sn	4	9.26	1.27
Ag-Cd	2	42.5	1.425
Ag-Zn	2	37.8	1.378
Ag-Hg	2	35.0	1.35
Ag-In	3	20.0	1.40
Ag-Al	3	20.4	1.408
Ag-Ga	3	19.0	1.38
Ag-Sn	4	12.2	1.366

* From HUME-ROTHERY, WILLIAM, G. W. MABBOTT, and K. M. CHANNEL-EVANS, *Trans. Roy. Soc. (London)*, A **233**, 37 (1934).

† The electron concentration is calculated as follows: For an alloy containing 20 atomic per cent of Al and 80 atomic per cent of Cu, $(20 \times 3) + (80 \times 1) = 140$ electrons. $140 \text{ electrons}/100 \text{ atoms} = 1.4 \text{ electron/atom}$.

increases, the concentration of the solute in the saturated solution decreases. But it has recently been shown¹ that for dilute solutions of cadmium, indium, tin, or antimony in silver, alloys of the same equi-valent composition have the same size unit cells; or, the initial expansion of the silver lattice produced by one atom of solute is proportional to the valence of the latter. These data appear to offer quantitative evidence of a relationship often assumed, as a result of qualitative observations, *viz.*, the solu-

¹ HUME-ROTHERY, WILLIAM, *Nature*, **135**, 1038 (1935).

bility of a metal is inversely proportional to the extent of its alteration of the size of the solvent lattice.

Again, warning must be given against unreserved acceptance of the implied importance of relative atomic sizes. Copper (1.275 Å) and gold (1.439 Å) are miscible in all proportions, while copper and silver (1.441 Å) have only a very narrow solid solubility range. Doubtless the limit of solid solubility depends on the nature of both the phases in equilibrium at this boundary. Solubility has recently been treated from the standpoint of the free energies of the phases involved, and it has been proposed that if the free energy curve has an inflection (as it does in the copper-silver system) then, solid solubility is incomplete; while, if there is no inflection in the curve (as in the copper-gold system), complete miscibility may be anticipated.¹

In general, as the difference in atomic sizes increases, the value for the critical electron concentration falls. The atomic diameter of tin, on the edge of the copper zone, is only just favorable to solid solution, and the electron concentration falls to 1.27. In this discussion of intermediate phases, we shall find that in most of the copper and silver alloys a new phase appears at an electron concentration of 1.5, and that the stability of the intermediate phases formed with other elements by either copper or silver seems to depend upon the valence electron-atom ratio.

Fundamentally, of course, the limit of solid solubility is such that, below that concentration of solute metal, the free energy of the solid solution is lower than that of any two phases of that total composition which might exist, while above it the reverse is true.

This critical electron concentration has been utilized to calculate the solid solubility limits in the ternary alloys shown in Table 33. These data imply that the equilibrium is essentially a question of electron concentration and that it is possible to dissolve the two solute metals in copper in any proportion so long as their combined effect does not increase the electron concentration of the whole system beyond the critical value. A similar relationship has been observed in certain ternary intermediate phases and is discussed on page 130. The conception of a limit-

¹ MOTT, N. F., and H. JONES, "Theory of the Properties of Metals and Alloys," Oxford University Press, New York, p. 27, 1936.

ing concentration in connection with solid solubility has an interesting bearing on this point. It is evident that it is possible to increase the concentration of electrons without breaking down the solvent copper or silver lattice. Consider silicon as solvent, however. Here the bonds are homopolar, electron-pair bonds and the substitution of univalent copper for silicon leaves insufficient electrons to form these bonds. A very limited solubility of copper in silicon is to be expected, and is found. This same

TABLE 33.—ELECTRON CONCENTRATION IN SATURATED TERNARY SOLID SOLUTIONS*

Composition of solid solution			Atomic concentration of solute		Electron concentration
Cu	Zn	Al	Zn	Al	
			33.8		1.338
71.0	26.5	2.0	25.3	4.63	1.346
77.7	18.3	4.0	16.96	9.0	1.350
83.3	10.7	6.0	9.6	13.2	1.359
				18.0	1.360

* Figures are for the 800°C. isothermal, from HUME-ROTHERY, WILLIAM, G. W. MABBOTT, and K. M. CHANNEL-EVANS, *Trans. Roy. Soc. (London)*, **A 233**, 40 (1934).

relationship is found for certain intermediate phases in which the bonds are thought to be essentially homopolar (see page 137). It is not safe to assume from this picture that limited solubility of copper or silver in another element is evidence of homopolar bonds in the latter. Certainly the solubility of copper in arsenic or selenium is very limited, in spite of the favorable atomic-size ratio, and the bonds in these crystals possess homopolar characteristics. Of course, in alloys of copper or silver with other normal metallic elements, the question of homopolar bond formation is not significant, yet the solubility of copper in silver or in iron, for example, is very limited.

In general, these solid solutions of copper and silver may be grouped into three types:

1. Those in which both elements have favorable size factors and the same valence, such as Ag-Au; solid solubility is most favored.

2. Those having favorable size factors but different valences, such as Cu-Zn, Cu-Ga, Cu-Be, etc.; moderate solid solubility.

3. Those in which both the size factor is unfavorable and the valences differ, such as Cu-Mg or Cu-Bi; limited solid solubility.

Briefly, Hume-Rothery's work on copper and silver alloys may be summarized as follows: In predicting solid solubility, the relative atomic sizes are of primary importance. If the atomic size factor is favorable, then solid solubility depends upon an electronic factor, *i.e.*, upon the relative valences of solvent and solute.

While Hume-Rothery has made a very interesting and valuable contribution to the systematization of solid solutions, his results are apt to be limited in their application. They are based entirely on alloys of copper or silver with other 18-shell atoms. Uncertainties concerning the interactions of atoms in the metallic state make it decidedly hazardous to apply these "generalizations" to alloys containing 8-shell or transition elements.

Because the metallic state is so baffling in many of its implications, there is need for a greater accumulation of accurate, quantitative structural data before an inclusive systematization of alloys can be expected. Of the greatest importance, therefore, is the very accurate measurement, notably by Jette and some others, of the lattice constants in alloy solid solutions; particularly for solid solutions in which one of the members is a transition element.

The development of a technique for determining these distances with an accuracy of 0.0001 Å, has provided a superior method for the establishment of phase boundaries. It has also made it possible to detect and study small deviations from Vegard's additivity law.¹

Based on such studies, Jette² has suggested a more general approach to the question of solid solubility. He has drawn an interesting analogy between Raoult's law of solutions and Vegard's law for solid solutions. There is no reason why Raoult's law should not apply to solid as well as liquid solutions; and the

¹ VEGARD, L., *Z. Physik*, **5**, 17 (1921). For two elements of the same crystal structure and forming a continuous series of solid solutions, the lattice constants of the alloys are a linear function of the composition.

² JETTE, E. R., *Trans. Am. Inst. Mining Met. Eng.*, **111**, 75 (1934).

physical and chemical factors which may be expected to cause deviations from Vegard's law for solid solutions are the same factors responsible for deviations from Raoult's law.

Thus, Raoult's law holds only when the molecular species present are very similar chemically and physically. Vegard's additivity law holds when the atoms of the elements involved are very nearly the same size and of similar electronic structure.

Negative deviations from Raoult's law result from the operation of specific attractive forces which, when extreme, lead to compound formation. Jette points out that negative deviation from Vegard's law occurs in those alloy systems in which intermetallic compounds are formed.

Positive deviations from Raoult's law are thought to be due to repulsive forces between unlike molecules or to a tendency for like molecules to associate. Positive deviations from Vegard's law are not understood clearly. Here also the deviation is probably due to repulsive electrostatic forces on unlike atoms. Jette has called attention to the fact that all the metal pairs whose solid solutions are known to show a positive deviation are made up of *B* subgroup or transition elements; and that at least one member of each pair can occur in two different valence states.

It is to be expected that the accumulation of more of these accurate measurements of lattice constants in alloy systems will lead to a much clearer understanding of the metallic state and the theory of alloys.

At this point we may summarize our fragmentary knowledge of the factors influencing the solid solubility of metals:

1. Two metals are apt to be mutually soluble if the size factor is favorable and unless one is extremely electronegative with respect to the other. They may be miscible in all proportions if they are small, highly charged atoms, of similar electronic structure, not differing by more than 10 to 12 per cent in size. Face-centered cubic structures seem to favor complete miscibility but are not essential to it.

2. Of two mutually soluble metals *A* and *B*, not completely miscible, the solubility of *A* in *B* will usually differ from that of *B* in *A* if *A* and *B* are not equi-valent.

3. Two metals are usually immiscible if they differ in size by more than 15 per cent; or if they tend to repel each other

strongly. Thus, repulsion results in immiscibility; and moderate attraction produces typical solid solutions. When there is strong mutual attraction between the metals, they are immiscible in the sense that no solid solutions are formed. Strictly speaking, however, their tendency to mix is highest and they are miscible in an ordered state, *i.e.*, they form a compound.

As the strengths of the mutual attractive forces influence the miscibility of two metals, so may their geometrical relationships also be significant. Metals of widely differing sizes are immiscible; metals of similar sizes are mutually soluble; metals which differ moderately in size (about 15 per cent) tend to form solid solutions in which geometric influences have induced an ordered state of the atoms, producing what might be called geometric compounds (but see page 151).

While the point has been made that no rules have yet been formulated which are applicable to alloys in general, it is of interest to observe the extent to which the data of Chart A appear to be consistent with the criteria listed above. These observations are, of course, merely suggestive.

The elements of the eighth group of the periodic table are generally completely miscible. They do not differ greatly in size; they are generally face-centered cubic;¹ they are small and may be expected to have the strongest mutual attractive forces. Their valences in the metallic state are not known with certainty but are probably variable.

There are a few miscible pairs in addition to the eighth group elements. Of the noble metals, gold shows the greatest miscibility with other Zone III and IV elements and silver the least.

Dehlinger² has attributed this difference to a difference in attractive forces. He observes that the known tendencies of the noble metals are to form the ions Ag^+ , Cu^{++} , and Au^{+++} . Of the three, only silver has a completed, alkali-like outer shell and should therefore have the smallest attractive force.

In addition to the noble metals, manganese and chromium are completely miscible with some metals. It seems more than a coincidence that these metals exist in several allotropic forms,

¹ Ru and Os are close-packed hexagonal, as is Co at room temperature. Fe is body-centered cubic at room temperature.

² DEHLINGER, U., *Z. Elektrochem.*, **38**, 149 (1932).

which may give them considerable versatility in solid-solution formation, inasmuch as crystal structure, atomic radii, and possibly even valence are subject to change. In the iron-manganese system, for example, there are actually five different structures, three for manganese and two for iron, and all are involved in the various solid solutions.¹ At high temperatures the solid solution is one between γ iron and γ manganese. Manganese and chromium are miscible with metals which appear to have valences different from their own. It is suggested, therefore, that their crystal structures and their small, compatible atomic radii are influential in determining miscibility.

Other miscible pairs are Mo-W, As-Sb, Sb-Bi and K-Rb, all characterized by equi-valence, similar electronic structures, and favorable size factors.

The nature of the binary systems of magnesium, zinc and cadmium is an interesting consideration. These are all close-packed hexagonal; zinc and cadmium have abnormal, but equal, axial ratios. Their atomic radii are 1.60, 1.33, and 1.49, respectively; they are all divalent. Magnesium and zinc are immiscible, probably because of an unfavorable size factor; while magnesium and cadmium compare more favorably in size and are mutually soluble, except for a very narrow gap. Zinc and cadmium are partially soluble but to a lesser extent. The relationship of these three elements suggests that the size factor is the important influence determining their mutual solid solubility.

Another fairly definite group which might be mentioned is Zone I, in which the metals are predominantly immiscible. These are true metals; largely body-centered cubic in structure, and many immiscible pairs are equi-valent. Their atomic radii, however, differ greatly and their mutual attractive forces should be weak since all have the rare gas configuration and are comparatively large. Potassium and rubidium, differing in size by only 7 per cent, are completely miscible. It follows that atomic size and perhaps crystal structure and mutual attractive forces are the significant criteria for this group.

Mutual solubility is the exception, rather than the rule, in Zone V where one or both of the metals must be an abnormal Class II metal. In cases of partial solubility, it is usually true that the

¹ GAYLER, M. L. V., *J. Iron Steel Inst. (London)*, **128**, 293 (1933).

Class II metal is soluble in the Class I metal, but the reverse does not follow. This lack of mutual solubility may possibly be explained on the basis of the ratio of valence electrons to atoms in these alloys (see page 137). Dissolving power decreases rapidly when the line dividing Class I from Class II is crossed.

A Class I metal is never completely miscible with a Class II metal. Either the members of the pair have different valences or one of them is an abnormal structure.

Primary Interstitial Solid Solutions.—Zone VI on Chart A includes a unique group of alloys, binary alloys of certain metals with carbon, boron, nitrogen, and hydrogen. When these elements dissolve in certain of the transition elements, iron, for example, they do not form the usual type of solid solution by replacing iron atoms in the iron lattice; but they penetrate the lattice, taking up positions in the interstices and forming what are known as interstitial solid solutions. The reason for this peculiar behavior is to be found in the small radii of these atoms. All have radii less than 1.0 Å, while the radius of beryllium, the smallest of the metals which do not form interstitial solid solutions, is 1.14 Å. When the size of these atoms is small compared to the size of the holes in the solvent lattice, solid solution takes place with little distortion; but, if the relationship is not so favorable, considerable distortion of the solvent lattice may result from the interstitial penetration of the solute atoms.

Because of its great practical importance, the iron-carbon system has been studied extensively and is the most familiar of the interstitial solid solutions. The properties of steel depend in large degree upon the influence of carbon on the stability of the various allotropic forms of iron. The very valuable alloy steels are made by adding other elements to the iron-carbon system. Structurally, these are interesting combinations of the two types of solid solution—substitutional and interstitial. In a manganese steel, for example, the manganese and iron form a typical substitutional solid solution, while the carbon is interstitial with respect to both metals. The interstitial alloys will be discussed further in connection with intermediate phases.

Secondary Solid Solutions.—In many alloy systems intermediate phases of varying composition are to be found. The structure of the intermediate phase is different from that of either

pure metal, but the phase retains its metallic properties and forms solid solutions readily with one or both parent metals. Such phases have sometimes been called secondary solid solutions.

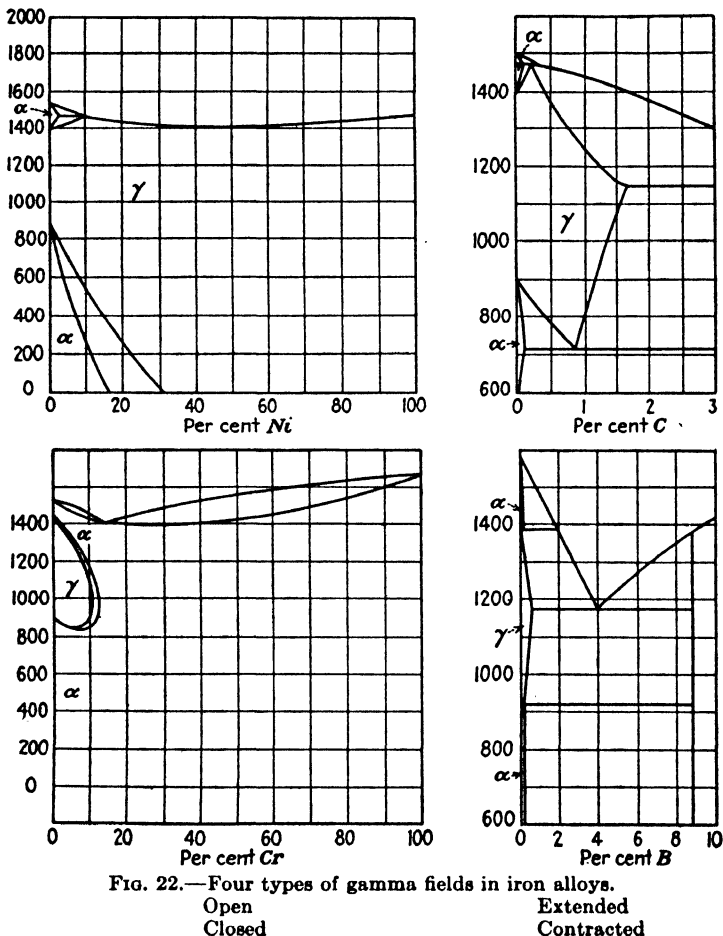

The Binary Alloys of Iron.—The alloys of most of the common metals with iron have been studied and remarkable relationships have been discovered within them which constitute one of the most interesting chapters of systematic crystal chemistry. Westgren and his collaborators were among the pioneers in the study

of the structures of the iron alloys.¹ It has recently been pointed out by Wever² that the elements may be placed in one of four groups according to their influence upon the extent of the γ iron in the equilibrium diagram. The four types of γ field which may result are illustrated in Fig. 22.³ They are termed (1) the open γ field, of which the iron-nickel system is a typical example; (2) the closed γ field (iron-chromium); (3) the expanded γ field (iron-carbon); (4) the narrowed γ field (iron-boron). Wever has found, further, that when the elements are grouped according to their effect on the γ field, a striking relation to their positions in the periodic table is revealed. This is illustrated in Table 34. It may be observed that the Group VIII elements produce an open γ field when alloyed with iron; the alkali and alkaline earth metals and the heaviest metals are insoluble in iron; and most of the other elements produce a closed γ field. Following this systematic arrangement still further, it may be seen that the influence of the added element is apparently a function of its size. The largest elements are insoluble in iron. This, of course, is consistent with the generalization which has been proposed governing the formation of solid solutions. In general, the smallest elements produce an open γ field. The crystal structure of the metal also appears to be important. As might be anticipated the face-centered cubic metals, isomorphous with γ iron, appear to favor the open γ field.

The Properties of Solid Solution.—While it is beyond the scope of this book to enter into a detailed description of the properties of alloys, a very general summary of characteristic properties as they are related to the structure of solid solutions, is of interest. Here again, it is dangerous to attempt to apply apparent "rules" or generalizations too rigidly.

¹ See, for example, WESTGREN, ARNE, *J. Iron Steel Inst. (London)*, **103**, 303 (1921); WESTGREN, ARNE, and A. E. LINDH, *Z. physik. Chem.*, **98**, 181 (1921).

² WEVER, FRANZ, *Proc. of the World Eng. Congr. Tokyo*, **1929**; **34**, 239 (1931).

³ For equilibrium diagrams illustrating these four types of γ field see M. Hansen, "Der Aufbau der Zweistofflegierungen," Julius Springer, Berlin, 1936. This is one of the most up-to-date reliable sources of information on binary systems.

TABLE 34.—PERIODIC ARRANGEMENT OF THE ELEMENTS SHOWING THE CRYSTAL STRUCTURE AND THE TYPE OF ALLOY FORMED WITH IRON

0	I	II	III	IV	V	VI	VII	VIII
1 H								
2 He	4 Be C-3	5 B C-	6 C E-4	7 N E-	8 O E-	9 F		
10 Ne	12 Mg I-3	13 Al C-1	14 Si C-4	15 P C-	16 S C-	17 Cl		
18 A	19 K I-2	20 Ca I-1	21 Sc	22 Ti C-3	23 V C-2	24 Cr C-2	25 Mn O-6	26 Fe 27 Co 28 Ni O-1 O-1 O-1
	29 Cu E-1	30 Zn E-3	31 Ga	32 Ge C-4	33 As C-7	34 Se	35 Br	
36 Kr	37 Rb I-2	38 Sr I-1	39 Yt	40 Zr C-3	41 Nb C-2	42 Mo C-2	43 Ma	44 Ru 45 Rh 46 Pd O-3 O-1 O-1
	47 Ag I-1	48 Cd I-3	49 In	50 Sn C-4	51 Sb C-7	52 Te	53 I	
54 X	55 Cs I-2	56 Ba I-2	57 R.E. C-(3)	72 Hf	73 Ta C-2	74 W C-2	75 Re	76 Os 77 Ir 78 Pt O-3 O-1 O-1
86 Em	79 Au E-1	80 Hg I	81 Tl I-1	82 Pb I-1	83 Bi I-7	84 Po	85	
	88 Ra	89 Ac	90 Th	91	92 U			

CRYSTAL STRUCTURE OF ELEMENT

1. Face-centered cubic.
2. Body-centered cubic.
3. Close-packed hexagonal.
4. Diamond cubic.
5. Face-centered tetragonal— γ Mn.
6. Face-centered tetragonal— γ Mn.
7. Rhombohedral (As structure).

DESCRIPTION OF IRON ALLOY

- I. Insoluble.
- E. Expanded γ field.
- O. Open γ field.
- C. Closed γ field.
- C'. Contracted γ field.

The interactions of different atomic species in an alloy are apt to be specific and not, as yet, predictable; and properties, such as hardness and thermal and electrical resistance, are dependent upon such interactions, upon the distribution of the electrons around metallic nuclei, and the nature of the forces operative.¹

A good many of the properties of solid solutions may be anticipated in a general way from the discussion of the properties of pure metals. It has been observed that the characteristic metallic properties are peculiar to the metallic state. The electrical and thermal properties are related to the metallic bond; the mechanical properties appear to be related to the close-packed structures which afford numerous glide planes along which the metal can flow.² In general, solid solutions are apt to be less metallic in their properties than are the pure metals from which they are formed. Of course, if one of the constituents of the solid solution is distinctly nonmetallic the properties of the solid solution may be more metallic than the properties of this component. The interstitial solid solutions are a case in point. They exhibit definite metallic characteristics in spite of the nonmetallic nature of the solute atoms.

A solid solution is always harder than the pure solvent metal and is apt to be less ductile. This principle of hardening a metal by dissolving another in it has probably had its widest application in brass, the solid solution of zinc in copper.³ Pure copper is too soft to machine well, while α brass is hard enough to be machined, and to resist undue wear and deformation when in use, yet soft enough to be formed in various ways.

It must be emphasized again that the properties of alloys may be considerably modified by heat treatment and aging. This is particularly true of the mechanical properties hardness, ductility, and tensile strength; and it is impossible to generalize, except in

¹ Again, see MOTT, N. F., and H. JONES, "Theory of the Properties of Metals and Alloys," Oxford University Press, New York, 1936.

² They may also be considered in the light of the recently proposed theory of the secondary structure of real crystals, as it has been discussed in detail by Zwicky and Smekal in particular. A brief statement of this theory is given in Chap. III.

³ For general reference, see H. O'Neill, "Hardness of Metals and its Measurement," Sherwood Press, Cleveland, 1934.

very broad terms, regarding the factors which determine these properties.

Heat treatment is apt to have a very marked effect upon the properties of those alloys, any constituent of which exists in two or more allotropic forms.¹ The complicated equilibrium diagram of the iron-carbon alloys, and the greater complications brought about by the addition of one or more additional elements make possible the production, by careful heat treatment, of alloys with almost any required mechanical properties. The accomplishments in this direction are responsible for the very extensive use of alloys of iron. On the other hand, the microscopic or macroscopic structure of even the simplest alloy may be affected by heat treatment. Prolonged annealing at appropriate temperatures, for example, encourages grain growth, especially when preceded by cold working or by passing through a structural transformation. As the size of the crystalline particles increases, the hardness of the metal decreases.

In the copper-beryllium system, hardness, tensile strength, and endurance limit may be increased 100 per cent by the proper heat treatment, as shown by the following figures:²

	Tensile Strength, Lb. per Square Inch
1. 2.75 per cent Be in Cu, quenched from 1450°F.	88,800
2. Age (1) at 575°F.	161,000
3. Cold roll (1)	156,000
4. Heat treat (3) at 575°F.	225,000

The phenomenon of age hardening—a marked increase in hardness and brittleness following certain heat treatments—is rather common in alloys. This problem is of great concern to the practical metallurgist and has been studied extensively. From the standpoint of the crystal chemist, the underlying principle appears to be a relatively simple one. It has been shown that age hardening depends upon the precipitation of a second phase from solid solution. In mild steel, for example, age hardening has been attributed, by various investigators, to compounds of iron with nitrogen, carbon, or oxygen, presumably

¹ See SMITH, H. A., *Trans. Am. Inst. Mining Met. Engrs.*, **116**, 342 (1935), for a general discussion of this subject.

² SMITH, J. K., *Trans. Am. Inst. Mining Met. Engrs.*, **99**, 65 (1932).

Fe_4N , Fe_3C , or FeO , respectively. Fe_4N is known to have the greatest effect. It is thought that the age hardening which occurs in automobile sheets is due to an oxidation product, presumably FeO .¹ In the nitriding of steel containing a trace of aluminum, the hardening is said to be due to the formation of AlN .² The age hardening of duralumin is due to the precipitation of CuAl_2 .³

That age hardening is not always the result of the precipitation of a compound but may be due to the precipitation of a pure metal phase has been shown recently in a study of the copper-silver system.⁴

It would appear that any alloy may be subject to age hardening at any given temperature if it contains a constituent which is less soluble at some other temperature and tends to precipitate over a period of time. In most practical instances the precipitation occurs as a result of the cooling of the alloy to room temperature.

Apparently it would be possible to take advantage of the size factor in formulating an alloy to be subject to age hardening. To precipitate a single solute, the size of the solute should differ considerably, but not too much, from that of the solvent. To affect the precipitation of a compound of two solute metals, these should be selected for their unfavorable, but not too unfavorable, sizes. One should be electronegative, but not too electronegative, to the other. Then there will be a fair chance of their remaining in solution at high temperatures and precipitating at a lower temperature. The addition of magnesium and silicon to aluminum appears to meet the electronegativity and size requirements for the precipitation of Mg_2Si .

Some alloys are made quite brittle by a mere trace of impurity. Beryllium may be very brittle due to a trace of beryllium oxide distributed between the grains and thus reducing the cohesion

¹ EILENDER, W., H. CORNELIUS, and H. KNUPPEL, *Arch. Eisenhüttenw.*, **11**, 507 (1935). A study of the influence of O and N on mechanical aging of steel.

² NORTON, J. T., *Trans. Am. Inst. Mining Met. Engrs.*, **113**, 262 (1934).

³ But see GAYLER, M. L. V., and G. D. PRESTON, *J. Inst. Metals*, **48**, 197, (1932), who find that at room temperature and at 200°C. it may be due to some process occurring before the precipitation of CuAl_2 .

⁴ BARRETT, C. S., and R. F. MEHL, *Trans. Am. Inst. Mining Met. Engrs.*, **117**, 39 (1935).

between them. One-tenth per cent of intergranular bismuth in gold makes the latter brittle.¹

Color.—The influence of solid solution upon color is impossible to predict, but it is very interesting and of considerable practical importance. Copper turns gray with the addition of: 23 per cent nickel, 22 per cent manganese, 20 per cent palladium, 40 per cent platinum, 19 per cent aluminum, or 50 per cent zinc. Cer-

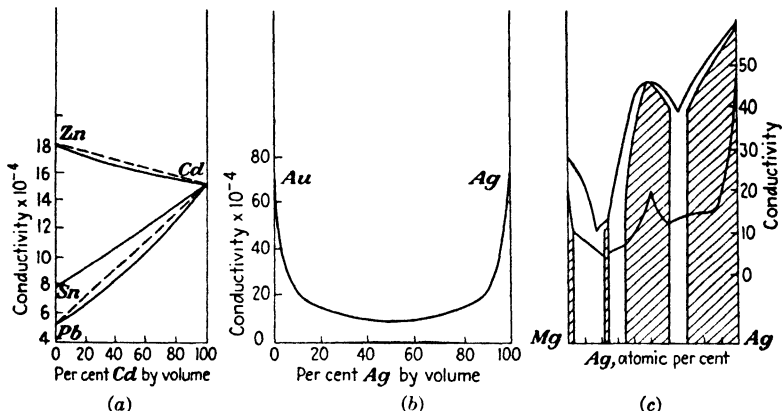

FIG. 23.—Electrical conductivity-composition diagrams. (a) Two immiscible metals. Cd-Zn, Cd-Sn, Cd-Pb. (b) Metals forming a solid solution. Au-Ag. (c) An alloy containing intermediate phases. Mg-Ag. [From W. Guertler, *Z. anorg. allgem. Chem.*, **51**, 401 (1906) and W. J. Smirnow and N. S. Kurnakow, *Z. anorg. allgem. Chem.*, **72**, 31 (1911) by permission of J. A. Barth, Leipzig.]

tain gold-iron solid solutions are blue; gold-silver-cadmium produce a green alloy. 51.5 per cent copper and 48.5 per cent antimony is purple.

Electrical Conductivity.—In an alloy of two immiscible metals, the electrical conductivity is an average of the conductivities of the two components, as shown in Fig. 23a for the systems zinc-cadmium, tin-cadmium, and lead-cadmium. As one metal is dissolved in another, however, the conductivity of the solvent metal is usually lowered, very sharply at first, as indicated in Fig. 23b. The minimum conductivity is lower than that of either pure constituent. The formation of intermediate phases introduces further variations in conductivity, as illustrated in Fig. 23c.

¹ ARNOLD and JEFFERSON, *Engineering*, **61**, 176 (1896).

The relative increases in resistance produced by dissolving 1 per cent of various elements in copper, silver, or gold have been determined by Norbury¹ and are listed in Table 35. It was remarked by Norbury that the increase in resistance produced by a given solute is greater, the greater the distance in the periodic table between solvent and solute. It might have been said that the increase in resistance is greater, the greater the valence

TABLE 35.—THE EFFECT OF VARIOUS ELEMENTS ON THE ELECTRICAL RESISTANCE OF SOLID SOLUTIONS IN COPPER, SILVER, AND GOLD*

Solute element	Increase in resistance (in microhms per cubic centimeter) due to the presence of 1 per cent solute element in solid solution in		
	Cu	Ag	Au
Copper.....	0	0.1-0.5	0.35-0.74
Silver.....	0.13-0.22	0	0.2-0.36
Gold.....	0.5-0.65	0.3-0.6	0
Magnesium.....	0.8	0.8-1.3	
Zinc.....	0.26-0.31	0.5	0.85-0.95
Cadmium.....		0.4	0.35-0.64
Mercury.....			0.4
Aluminum.....	0.8-1.1	1.6-2.0	
Silicon.....	3.0-3.3		
Tin.....	2.6	4.0-5.0	7.5-8.5
Arsenic.....	5.3-5.6		
Antimony.....	5.5-7.5		
Nickel.....	1.1-1.2		
Cobalt.....	2.5-3.5		
Iron.....			4.0-0.6
Manganese.....	2.9-3.0		
Chromium.....	4.0		
Palladium.....		0.4	0.3
Platinum.....		0.7-1.5	0.8

* Alternate figures are given where the results of different workers do not agree.

of the solute; and a relation between solid solubility and electrical conductivity thus established. Linde² has, in fact, shown that

¹ NORBURY, A. L., *Trans. Faraday Soc.*, **16**, 579 (1921).

² LINDE, J. O., *Ann. Physik*, (5) **10**, 52 (1931); **14**, 353 (1932).

with the addition of 1 per cent of cadmium, indium, tin, or antimony to silver as solvent, the change in electrical resistance of the solid solution varies as $(V - 1)^2$, where V is the valence of the solute. This relationship has a theoretical explanation.¹ The core of the dissolved atom carries a positive charge greater than that of the solvent metal. The field of this extra charge may cause scattering and increase resistance.

The electrical conductivity of a solid solution is less dependent upon temperature than is that of a pure metal. The conductivity

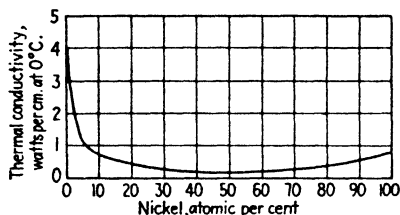

FIG. 24.—Thermal conductivity of a typical solid solution Cu-Ni. (From W. Hume-Rothery, "The Metallic State," by permission of The Clarendon Press, Oxford.)

of the solid solution increases as the temperature decreases but not to so great a degree as does that of a pure metal. Upon this principle depends the value of the alloy constant, useful for electrical resistance instruments in order to avoid errors due to a fluctuation in temperature. It is essentially a copper-nickel alloy containing small amounts of iron and manganese, and its temperature coefficient is negligible at room temperature.

The cold working of solid solutions causes an increase in their electrical resistance as it does in pure metals.

Thermal Conductivity.—The thermal conductivity of a solid solution is less than that of the solvent metal, whether it be a continuous solid solution or one of limited extent. The type of variation commonly observed is shown for the copper-nickel alloys in Fig. 24.

Melting Points.—The melting point of a metal is generally lowered when another metal is dissolved in it. The exceptions are those metal pairs which are completely miscible. In such cases the melting points of the solid solutions lie between those of the pure metals. The practical value of a great many alloys depends upon their low melting or freezing points. Among these may be mentioned fuse metal, type metal, solder and the alloy used for sprinkler heads. In most of these the low melting point is that of a eutectic mixture of two solid solutions.

¹ MOTT, N. F., *Proc. Cambridge Phil. Soc.*, **32**, 281 (1936).

Magnetic Properties.—Alloys of iron, cobalt, and nickel with each other are ferromagnetic. Alloys of iron, cobalt, and nickel with other elements are somewhat magnetic over part of the composition range. In the gold-iron alloys, for example, pure gold is diamagnetic, while 0.1 per cent (weight) of iron makes the alloy paramagnetic. This paramagnetism persists through 0.5 per cent of iron, but the quenched alloy with 10 per cent (weight) of iron is ferromagnetic. That the ferromagnetism is not due to a second phase is evidenced by the ferromagnetism of the 15 per cent iron alloy at 724°C., at which temperature there exists only the solid solution of iron in gold.¹

The Heusler alloys (essentially manganese, copper, and aluminum or traces of other elements) are magnetic and their magnetism appears to be due to the existence of a particular superstructure.²

INTERMEDIATE PHASES

The first suggestion that two metals might actually unite to form a compound was made in 1839 when a discontinuity was observed in the action of acid on zinc-copper alloys.³ Before that date intermetallic compounds were considered to be anomalies. The "freezing-point curve" method of studying alloys, now so familiar, was not inaugurated until 1897.⁴ Since then the "hump" or maximum in the temperature-composition diagram of an alloy has always been accepted as evidence of the existence of a so-called intermetallic compound. In 1923 the first crystal structure determination of an intermetallic compound was made.⁵ After 1923 crystal-structure data for these compounds accumulated rapidly and the attempt to classify their structures has been carried on relentlessly. The problem has been, and still is, a difficult one. Twenty years ago the intermetallic compound could be defined with confidence; but today, with the structures of these compounds much more intimately known, the experts

¹ JETTE, E. R., W. L. BRUNNER, and F. FOOTE, *Trans. Am. Inst. Mining Met. Engrs.*, **111**, 354 (1934).

² See p. 152.

See also SLATER, J. C., *Phys. Rev.*, **36**, 57 (1930).

³ KARSTEN, C. J. B., *Pogg. Ann.*, (11) **16**, 150 (1839).

⁴ HEYCOCK and NEVILLE, *Trans. Roy. Soc. (London)*, **A 189**, 25 (1897).

⁵ PAULING, LINUS, *J. Am. Chem. Soc.*, **45**, 2777 (1923).

are not agreed as to just what constitutes a true compound. Because of this confusing situation, the term "intermediate phase" is now generally used to include all phases in an alloy system with the exception of the primary solid solutions. In the following pages intermediate phases of fixed or variable composition, secondary solid solutions, and superstructures will be discussed. All differ from the primary solid solutions which have been described, but whether or not any should be classed as compounds is still disputed and depends largely upon the definition of that term.¹

When the large number of metal phases usually known as "intermetallic compounds" is considered and their great practical importance in influencing the properties of alloys is realized, it seems surprising that little or no notice is taken of them in elementary chemistry. This omission is partially justified. Until very recently their fundamental nature has not been understood, and what has been known of them could not be reconciled with the combining laws governing the more familiar types of chemical compounds. Many of them have strange formulas: BiTe, AuSn, AuMg₃, Cu₅Zn₈, Cd₆Na, Cd₁₁K. They obviously violate the laws of valence. Just as many seem to follow the rules of valence after a fashion: CuZn, Na₄Pb, Mg₂Sn, Mg₂Pb, PtSn. All the earlier attempts to systematize such compounds started with the assumption that those which appeared to conform to the valence rules were the true compounds while those which did not were exceptions. With our growing understanding of the metallic state, however, has come the realization that the atoms in any phases in which the metallic bond exists are not held together by the transfer of electrons or by shared pairs of electrons. There is no reason, therefore, why such phases should show any relation whatsoever to valence compounds; the rules of valence apply only to those combinations in which a definite sharing or transfer of electrons takes place. Any phases which exhibit the electrical conductivity characteristic of the metallic state cannot be valency compounds.

The Occurrence of Intermediate Phases.—It will be helpful to return to Chart A, in the Appendix, and attempt, from the

¹ A review of the several attempts to define an intermetallic compound is given on p. 154.

data summarized there, to formulate a tentative generalization from which the circumstances under which intermediate phases are to be expected in alloy systems may be predicted. Briefly, these data indicate that:

1. In Zones I and IV intermediate phases are the exception, not the rule.
2. The so-called "superstructures" are confined almost entirely to Zone IV.
3. There are intermediate phases in Zones II and III, but the data are too limited to permit any attempt at classification.
4. Intermediate phases predominate in Zone V, largely systems of Class I with Class II metals; and in Zone VI, the region of interstitial phases.
5. Zone VII contains a number of compounds which have metallic properties and might be classed as alloys. They are crystals of the NiAs and FeS₂ types and will be discussed in the next chapter.

The crystal structure relationships and atomic properties within these zones have already been considered. A set of conditions favorable to intermediate phase formation may be proposed which is almost the reverse of that used for the prediction of solid solution among binary alloys. The formation of intermediate phases is to be expected when the metal pair is composed of:

1. Metals of very different atomic radii, but not with extreme differences. Usually they must be such that the ratios of their sizes will permit a coordination number of eight or higher.
2. Metals of different valences. The greater the electronegativity of metal *A* with respect to *B*, the greater the tendency for compound formation.
3. Metals which possess moderate mutual attractive forces.
4. Metals of different crystal structures.

It will be recalled further than in alloys, of copper or silver with many of the 18-shell metals, primary solid solutions give way to an intermediate phase where the electron concentration exceeds about 1.4.

The Structures of Intermediate Phases.—Three groups of intermediate phases have been studied sufficiently to warrant an attempt to classify them on the basis of structure. These are:

1. The intermediate phases of some of the eighth group transition elements and of copper and silver with other (Class II)¹ metals of the *B* subgroups.

¹ See Table 25.

2. The interstitial phases of the transition elements with boron, carbon, nitrogen, and hydrogen.

3. Intermediate phases of the alkali and alkaline earth metals. They will be discussed in this order.

Alloys of Copper, Silver, and Some Eighth Group Elements with Elements of the B Subgroups.—The alloys of the noble metals (and some of the transition elements) with the metals of the *B* subgroups have been investigated extensively, and, because the data are so complete, an attempt has been made to systematize the known facts for these alloys.

Consider the typical alloy system, copper-zinc. When zinc is added to copper, the zinc atoms replace copper atoms in the face-centered cubic copper lattice. When 32 atomic per cent of zinc has been added, the copper lattice is saturated and the addition of more zinc produces a new lattice which is not the hexagonal, close-packed lattice of zinc. In the past it has been customary to accept the appearance of a new structure, differing from each parent structure, as evidence of the formation of an intermetallic compound, although as will be pointed out later, these intermediate phases are generally not compounds in the usual sense. In the case of brass this first new structure is that of the phase CuZn , the so-called β brass, the equilibrium range of which has been well established by thermal methods. Many alloys form only one intermediate phase, but in brass there are three. As the proportion of zinc in the brass is increased, a new structure appears, first mixed with the β brass and then, at 60 atomic per cent of zinc, by itself. This is γ brass and has been assigned the formula Cu_5Zn_8 . At a higher zinc content another phase, ϵ brass, CuZn_3 , makes its appearance. Finally, with more than 87 per cent of zinc in the alloy, a solid solution of copper in the zinc lattice is formed.

For some time metallurgists had remarked the similarity of the equilibrium diagrams of a number of alloys of copper, silver, and gold with metals of the *B* subgroups. In 1926 Hume-Rothery¹ pointed out that the β phases of all of these alloys and many others have the same type of crystal structure, a body-centered cubic lattice. This was confirmed by Westgren and Phragmen²

¹ HUME-ROTHERY, WILLIAM, *J. Inst. Metals*, **35**, 295 (1926).

² WESTGREN, ARNE, and G. PHRAGMEN, *Phil. Mag.*, (6) **50**, 331 (1925).

and others. This seemed more than a coincidence and led to a search for similarities of like nature among the γ and ϵ phases. Some interesting analogies were discovered.

The β and γ Phases.—A partial list of the β phases is given in Table 36. They are arranged with the alloys upon which Hume-

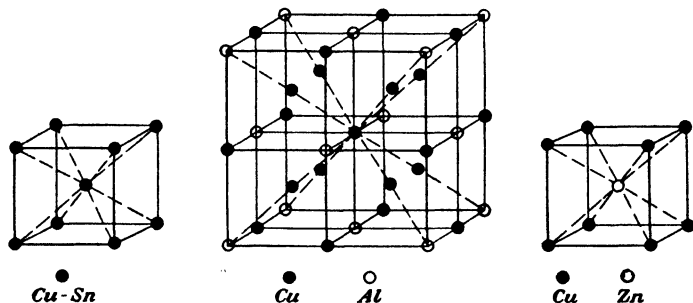

FIG. 25.—Comparison of the atomic arrangements in CuZn , Cu_3Sn and Cu_3Al . [From A. Westgren, *Trans. Faraday Soc.*, **25**, 380 (1929), by permission of the Faraday Society.]

Rothery based his original generalizations in the first two columns to the left.

TABLE 36.—THE ELECTRON CONCENTRATION IN SOME OF THE β PHASES

CuZn	3:2 (a)	AgCd	3:2 (a)	NiAl	3:2 (h)	Ag_3Al	6:4 (a)
CuBe	3:2 (a)	AgZn	3:2 (a)	FeAl	3:2 (b)	Au_2Al	6:4 (b)
Cu_2Al	6:4 (a)	AuZn	3:2 (a)	MnAl	3:2 (g)	Cu_5Si	9:6 (f) (b)
Cu_5Sn	9:6 (a)	AuCd	3:2 (c)	CoAl	3:2 (d)	CoZn_3	6:4 (d)
AgMg	3:2 (a)	CuPd	3:2 (a)	NdAl	3:2 (c)		
Cu_3Ga	6:4 (i)						

- a. WESTGREN, ARNE, and G. PHRAGMEN, *Trans. Faraday Soc.*, **25**, 380 (1929).
- b. WESTGREN, ARNE, *Z. angew. Chem.*, **45**, 33 (1932).
- c. STILLWELL, C. W., and E. E. JUUKOLA, *J. Am. Chem. Soc.*, **56**, 56 (1934).
- d. EKMAN, WALTER, *Z. physik. Chem.*, **B 12**, 57 (1931).
- e. OLANDER, A., *Z. Krist.*, **83**, 145 (1932). The AuCd phase is tetragonal below 267°C . but has the true CsCl structure above this point.
- f. ARRHENIUS, S., and ARNE WESTGREN, *Z. physik. Chem.*, **B 14**, 66 (1931).
- g. PERSSON, ELIS, *Z. Physik*, **57**, 115 (1929).
- h. WESTGREN, ARNE, and A. ALMIN, *Z. physik. Chem.*, **B 5**, 14 (1929).
- i. WEIBKE, FRIEDRICH, *Z. anorg. allgem. Chem.*, **23**, 293 (1934).

Those alloys in the first three columns have body-centered cubic structures, all but two having the structure of cesium chloride. A comparison of the structures of CuZn , Cu_5Sn , and Cu_3Al is shown in Fig. 25.¹ The CuZn structure is analogous

¹ WESTGREN, ARNE, and G. PHRAGMEN, *Trans. Faraday Soc.*, **25**, 380 (1929).

to that of cesium chloride. The copper atoms and the zinc atoms are on separate, interpenetrating cubic lattices. In Cu_3Al it is also true that the aluminum and copper atoms occupy regular and definite positions in the lattice. Cu_5Sn is quite different. There is no regularity of arrangement here and the copper and tin atoms are distributed quite at random on the body-centered cubic lattice.

Besides calling attention to their similar structures, Hume-Rothery observed that in all the alloys in the first two columns the ratio of the number of valence electrons to the number of atoms is as 3:2.

To the original list were soon added the β phases in the fourth column of Table 36. These conform to the 3:2 ratio, but in structure they are isomorphous with the peculiar β manganese, a complex cubic crystal having 20 atoms per unit cell.¹ In figuring the ratios, the valence electrons are always taken to be those in excess of the completed electron shell. Thus aluminum is three, even though there is some evidence to indicate that in the metallic state aluminum is univalent (see Chap. III). Column 3, Table 36, including the β structures of transition elements with aluminum, follows the 3:2 ratio only if the valence of the transition element is assumed to be zero. An attempt has been made to justify this purely arbitrary assumption, as will be shown later.

TABLE 37.—THE ELECTRON CONCENTRATION IN SOME OF THE γ PHASES

Cu_5Zn_8	21:13 (a)	$\text{Fe}_8\text{Zn}_{21}$	42:26 (b)
Cu_5Cd_8	21:13 (a)	$\text{Co}_8\text{Zn}_{21}$	42:26 (b)
Cu_9Al_4	21:13 (a)	$\text{Ni}_8\text{Zn}_{21}$	42:26 (b)
$\text{Cu}_{21}\text{Sn}_8$	63:39 (a)	$\text{Rh}_8\text{Zn}_{21}$	42:26 (b)
Ag_5Cd_8	21:13 (a)	$\text{Pd}_8\text{Zn}_{21}$	42:26 (b)
Ag_5Zn_8	21:13 (a)	$\text{Pt}_8\text{Zn}_{21}$	42:26 (b)
Au_5Cd_8	21:13 (a)	$\text{Ni}_8\text{Cd}_{21}$	42:26 (b)
Ag_5Hg_8	21:13 (c)		
$\text{Cu}_7\text{Zn}_4\text{Al}_2$	21:13 (d)	$\text{Na}_{21}\text{Pb}_8$	63:39 (e)
		Ag_3I_{10}	(f)

a. WESTGREN, ARNE, and G. PHRAGMEN, *Trans. Faraday Soc.*, **25**, 380 (1929).

b. EKMAN, WALTER, *Z. physik. Chem.*, **B 12**, 57 (1931).

c. STENBECK, STEN, *Z. anorg. Chem.*, **214**, 16 (1933).

d. BEADLEY, A. J., and C. H. GREGORY, *Mem. Proc. Manchester Lit. Phil. Soc.*, **72**, 91 (1928).

e. STILLWELL, C. W., and W. K. ROBINSON, *J. Am. Chem. Soc.*, **55**, 127 (1933).

f. PERLITZ, HARALD, *Z. Krist.*, **86**, 155 (1933).

¹ PRESTON, G. D., *Phil. Mag.*, (7) **5**, 1207 (1928).

While these β phases, alike in structure, form an interesting group, any attempt to extend them to alloys in general meets with a substantial list of exceptions. Beta phases in which one of the metals is an alkali or alkaline earth (see Table 43) are too frequently characterized by a different ratio. Apparently the rule is not infallible even within the group of alloys from which it was originally formulated, for the formula for the β phase in the copper-indium system has been reported as Cu_4In ,¹ a valence electron-atom ratio which does not conform to the 3:2 ratio.

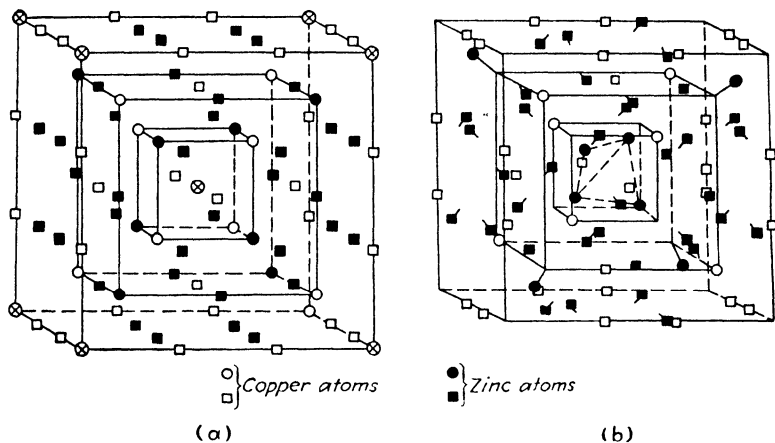

FIG. 26.—Atomic arrangement in gamma brass. [From A. J. Bradley and J. Thewlis, *Proc. Roy. Soc. (London)*, A **112**, 678 (1926), by permission of the Royal Society.]

A partial list of the γ phases, alloys which have similar structures, is given in Table 37.

The first γ phase to be studied in detail was γ brass, Cu_5Zn_8 , the crystal structure of which is shown in Fig. 26.² Figure 26b is the actual structure of γ brass. A comparison of it with Fig. 26a shows the relation of γ brass (52 atoms in the unit cell) to a unit cube containing 27 of the unit cubes of β brass (54 atoms). When the atoms are removed from the latter to form γ brass, the remaining 52 atoms shift their positions somewhat to form a stable lattice. Finding that Cu_9Al_4 had a structure

¹ WEIBKE, FRIEDRICH, and H. EGGERS, *Z. anorg. allgem. Chem.*, **22**, 273 (1934).

² BRADLEY, A. J., and J. THEWLIS, *Proc. Roy. Soc.*, A **112**, 678 (1926).

similar to that of γ brass, Bradley pointed out that in both of these the ratio of valence electrons to atoms is as 21:13. Other alloy phases were soon added to the list. These γ structures are not identical but they bear striking similarities. Thus Cu_5Zn_8 is body-centered cubic, containing 52 atoms in the unit cell; Cu_9Al_4 is simple cubic and contains 49-52 atoms per unit cell; $\text{Cu}_{31}\text{Sn}_8$ is face-centered cubic with 416 atoms per unit cell.¹ The formula has also been given² as $\text{Cu}_{41}\text{Sn}_{11}$, which makes an even number of molecules in the unit cell and at the same time preserves the 21:13 ratio. Doubtless the most impressive illustration of this 21:13 ratio for the γ structure is that of the ternary copper-zinc-aluminum alloys studied by Bradley and Gregory.³ They found that the atoms of copper, zinc, and aluminum may be interchanged in the lattice, but as long as the ratio of valence electrons to atoms remains at 21:13, the γ structure prevails. This will bring to mind a similar relationship controlling the limit of solid solution in the system copper-zinc-aluminum, the copper acting as the solvent (see page 107).

The γ structures of the transition elements were prepared by Ekman⁴ in order to confirm in part the zero valence assigned to these elements so that their β alloys might conform to the required 3:2 ratio. Ekman reasoned that if the transition elements do have zero valence in these alloys, then the γ phase should have the formulas $T_5(\text{Zn}, \text{Cd})_{21}$ (where T = a transition element) in order to meet the 21:13 requirement. He prepared alloys of these compositions, and found that they do have typical γ structures with large unit cells. Their existence at the predicted compositions is rather good evidence for the zero valence of the transition elements. Westgren has found that in the formation of the β phases of FeAl, CoAl, and NiAl the contraction in atomic volume may be as high as 15 per cent and suggests that such a diminution in volume would be expected to occur if the valence electrons of the transition elements remained closely associated

¹ WESTGREN, ARNE, and G. PHRAGMEN, *Z. anorg. allgem. Chem.*, **175**, 80 (1928).

² BERNAL, J. D., *Nature*, **122**, 54 (1928).

³ BRADLEY, A. J., and C. H. GREGORY, *Mem. Proc. Manchester Lit. Phil. Soc.*, **72**, 91 (1928).

⁴ EKMAN, WALTER, *Z. physik. Chem.*, **B 12**, 57 (1931).

with the nucleus, *i.e.*, if the atom does not ionize.¹ But there is no appreciable contraction of atomic volumes when the β phase CuPd is formed. Thus, Westgren's criterion does not indicate a zero valence for palladium; yet Pd₆Zn₂₁ has the γ structure and conforms to the γ electron-atom ratio when Pd is assigned zero valence. It has been stated further² that magnetic measurements indicate a zero valence for iron in the iron-zinc alloys. Ni, Pd, and Pt are said to contribute no valence electrons in alloys with Cu, Ag, and Au if the electron-atom ratio is below 0.6.³

Zintl and Brauer have proposed another possible explanation, based upon the data, reproduced in Table 38, of the con-

TABLE 38.—INTERATOMIC DISTANCES IN β PHASES CONTAINING ALUMINUM

Phase	Structure	Interatomic distances		Linear contraction per cent	Atomic radii		
		Found A	Calc. A		Table 122	Aluminum	
						Found	Table 122
NiAl	CsCl	2.44	2.60	-6	Ni = 1.21	1.23	1.43
CoAl	CsCl	2.47	2.61	-5	Co = 1.22	1.25	
Cu ₂ Al	See Fig. 25	2.53	2.63	-4	Cu = 1.24	1.29	
NdAl*	CsCl	3.21	3.18	+1	Nd = 1.79	1.42	
CuPd	CsCl	2.59	2.57	+1			

* The data for NdAl are from Stillwell and Jukkola, *J. Am. Chem. Soc.*, **56**, 56 (1934), and are included for comparison.

traction of atomic volume in β phases containing aluminum.⁴ A complete list of the β phases from which these data are taken is to be found in Table 43 on page 147. Zintl points out, first, that all the β phases containing aluminum undergo about the same contraction. Were the contraction only associated with FeAl, CoAl and NiAl, it would be impossible to say whether it is

¹ WESTGREN, ARNE, *Z. angew. Chem.*, **45**, 33 (1932).

WESTGREN, ARNE, and A. ALMIN, *Z. physik. Chem.*, **B 5**, 14 (1929).

² BERNAL, J. D., and D. CROWFOOT, *Ann. Repts. (London)*, **30**, 388 (1933).

³ MOTT, N. F., and H. JONES, "Theory of the Properties of Metals and Alloys," Oxford University Press, New York, 1936.

⁴ ZINTL, E., and G. BRAUER, *Z. physik. Chem.*, **B 20**, 245 (1933).

due to a change in the diameter of the transition element or of aluminum. But the same contraction occurs in Cu_3Al , and we know that copper undergoes no contraction in other β phases. It seems a fair guess, then, that in Cu_3Al the contraction is due to a contraction of the aluminum atom. It may be seen, further, that the actual radius of the aluminum found in these crystals (assuming that aluminum is the atom which contracts) is smaller, the smaller the radius of the atom with which it is associated and in the case of the large neodymium atom, no contraction of interatomic distances occurs. Furthermore, if contraction in atomic volume of the transition element be taken as evidence of its zero valency, then neodymium does not have zero valence in this alloy.

As a result of his systematic studies of the β phases of the alkali and alkaline earth metals, Zintl has proposed that when the formation of the β phase is accompanied by a marked contraction in interatomic distances, the Hume-Rothery rule, at least in its present form, does not necessarily apply. If this proposal be accepted, then, of those β phases listed in Table 36, the following should not be expected to conform to the 3:2 rule: NiAl , CoAl , FeAl , Cu_3Al , MnAl , AgMg , CoZn_3 . Of these, all but AgMg and Cu_3Al are those in which zero valence must be assumed—and apparently with questionable justification—for the transition elements in order to satisfy the 3:2 ratio.

In this connection the data in Table 39 are of interest, indicating the volume contraction in some of the recognized γ phases, most of which follow, or are assumed to follow, the Hume-Rothery rule.

It is evident that those γ phases in which the contraction begins to be marked are the alloys of the transition elements. The only γ phase containing aluminum also undergoes considerable contraction. A much more pronounced contraction occurs in γ alloys of the alkali metals. Bernal¹ has pointed out that the contraction increases as the structure departs more and more from a truly metallic one. The case of $\text{Ag}_3\text{Li}_{10}$ is particularly interesting. It has been cited² as the first γ phase to be found which does not follow the Hume-Rothery rule, for by no means

¹ BERNAL, J. D., *Trans. Faraday Soc.*, **25**, 369 (1929).

² BERNAL, J. D., and D. CROWFOOT, *Ann. Repts. (London)*, **30**, 388 (1933).

can the valence electron-atom ratio be made 21:13. But, if the viewpoint of Zintl be accepted, then the large contraction in atomic volume which accompanies its formation may exclude it from the γ phases which are expected to conform to the rule.

TABLE 39.—ATOMIC VOLUMES IN THE γ PHASES*

Compound	Mean atomic volume		Difference, per cent
	Calc.	Obs.	
Cu_3Zn_3	13.5	13.3	- 1.5
Cu_3Al_4	13.2	12.6	- 5.0
$\text{Cu}_{31}\text{Sn}_8$	15.0	13.8	- 1.0
Ag_3Zn_3	16.0	16.2	+ 1.2
Ag_3Cd_3	19.0	19.0	0
$\text{Fe}_3\text{Zn}_{21}$	14.4	13.93	- 3.0
$\text{Co}_3\text{Zn}_{21}$	14.4	13.80	- 4.5
$\text{Ni}_3\text{Zn}_{21}$	14.37	13.58	- 5.5
$\text{Ni}_3\text{Cd}_{21}$	19.60	17.89	- 8.7
$\text{Pt}_3\text{Zn}_{21}$	14.98	14.21	- 5.1
$\text{Pd}_3\text{Zn}_{21}$	15.06	14.44	- 4.1
$\text{Ag}_3\text{Ii}_{10}$	20.5	18.1	-12.0
$\text{Na}_{31}\text{Pb}_8$	37.7	30.3	-20.0

* The values of atomic volumes used to obtain the mean calculated values are from M. C. Neuberger, *Z. Krist.*, **86**, 395 (1933).

The ϵ Phases.—These alloys are also characterized by a constant ratio of valence electrons to atoms. In this case, as shown in Table 40, it is 7:4.

TABLE 40.—CONCENTRATION OF VALENCE ELECTRONS IN SOME ϵ PHASE ALLOYS

CuZn_3 7:4	Ag_3Al_3 14:8	AuCd_3 7:4	FeZn_7 14:8
Cu_3Sn 7:4	AgZn_3 7:4	AuZn_3 7:4	
Cu_3Ge 7:4	AgCd_3 7:4	Au_3Sn 7:4	
	Ag_3In 7:4	Au_3Hg 7:4	
	Ag_3Sn 7:4	Au_3Al_3 7:4	

The structures are all hexagonal, close packed, with an axial ratio usually slightly below the 1.63 characteristic of close-packed spheres. In all cases, with decreasing content of copper, silver, or gold, the axial ratio decreases slightly. This ϵ phase

is found in some systems in which the β and γ phases do not occur, and in these systems it is in equilibrium with the α solid solution. Of considerable interest is the discovery that, even in some of the systems containing β and γ phases (notably Ag-Cd and Ag-Zn), there is an intermediate temperature range in which the β phase is transformed into a close-packed hexagonal phase isomorphous with the ϵ structure and in equilibrium with the α phase.¹

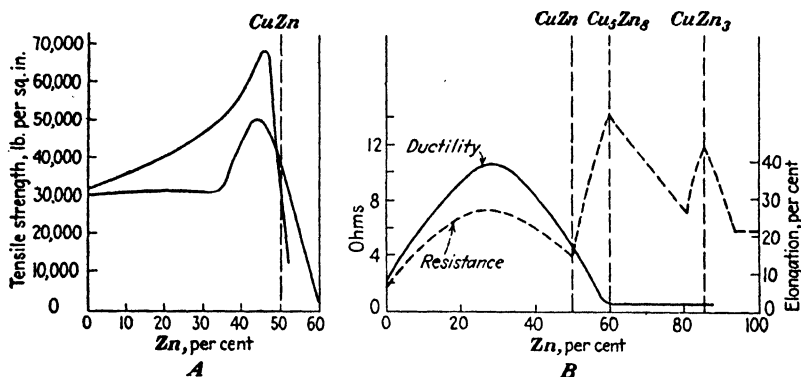

FIG. 27.—A, tensile strength of brass. (*Tensile strength and ductility from Leighou, "Chemistry of Engineering Materials," McGraw-Hill Book Co., New York.*) B, ductility and electrical resistance of brass. [*Electrical resistance from data in N. Puschin and W. Rjaschsky: Z. anorg. allgem. Chem., 82, 50 (1913).*]

The Properties of the β , γ , and ϵ Phases.—The electrical and mechanical properties of intermediate phases as compared with pure metals and solid solutions may be illustrated by a consideration of brass. In Fig. 27 composition is plotted against electrical resistance, ductility, and tensile strength. These curves, observed in the light of the picture which we now have acquired concerning the relation between the metallic state and the properties of metals and alloys, give a general outline of the whole story of the relation between these properties and the structure of intermediate phases.

As zinc is added to pure copper, the resistance rises, a reaction characteristic of all solid solutions. At the appearance of the β brass, CuZn, it begins to decrease and the pure CuZn has almost

¹ FRAENKEL, W., and A. WOLF, *Z. anorg. allgem. Chem.*, **189**, 145 (1930); WESTGREN, ARNE, *Z. angew. Chem.*, **45**, 33 (1932).

as high a conductivity as does pure copper.¹ Now, in the region 50 to 60 per cent zinc, we have a mixture of β and γ brass, and as the proportion of the good conductor (β brass) decreases, the resistance increases to a maximum for pure Cu_5Zn_3 . With the solution of excess zinc in the γ brass lattice, there is a moderate decrease in resistance until a point is reached where ϵ brass predominates. With pure ϵ brass another maximum in resistance occurs.

The ductility of brass reaches a maximum at the point where the α solid solution of zinc in copper is approximately saturated. Beta brass shows an appreciable degree of ductility, but in γ and ϵ brass the ductility is negligible, these phases being very brittle and hard. Tensile strength varies in much the same fashion, a maximum occurring in the β brass field and the strength then diminishing to a very low figure for γ and ϵ brass. It is evident, then, why the commercial use of brass is confined almost entirely to the α and β phases. These are ductile and soft enough to be formed and machined. They are relatively strong and hard enough to retain their shape and resist ordinary wear when in use. Gamma brass, on the other hand, is so brittle that a piece the size of a pencil is apt to shatter if dropped to the floor. "White brass," the γ and ϵ phases, is used only occasionally for casting small ornaments. In making band instruments those parts which must be shaped are of α brass. The keys, however, must be very rigid and hard in order that their action be efficient, and they are sometimes cast of γ brass.

The properties which have been described for γ and ϵ brass are typical of a number of intermediate phases, and many other examples might be cited of the advantage taken of this knowledge in industry. To mention only one more: A bearing metal must be soft in order that it may "work in" to fit the shaft after casting. Once having been fitted, however, it should resist abrasion. The ideal bearing metal, therefore, is a mixture of a hard, resistant intermediate phase and a solid solution. Babbitt metal (90 per cent tin, 8 per cent antimony, 2 per cent copper) consists of the compounds SbSn and Cu_3Sn embedded in tin.

¹This may be expected in a completely ordered alloy like CuZn . See N. F. Mott and H. Jones, "Theory of the Properties of Metals and Alloys," Oxford University Press, New York, 1936.

The crystals of the compounds may be clearly seen in the photomicrograph shown in Fig. 28.

The general characteristics of the γ and ϵ phases are compared in Table 41 with those of solid solutions. This should be applied

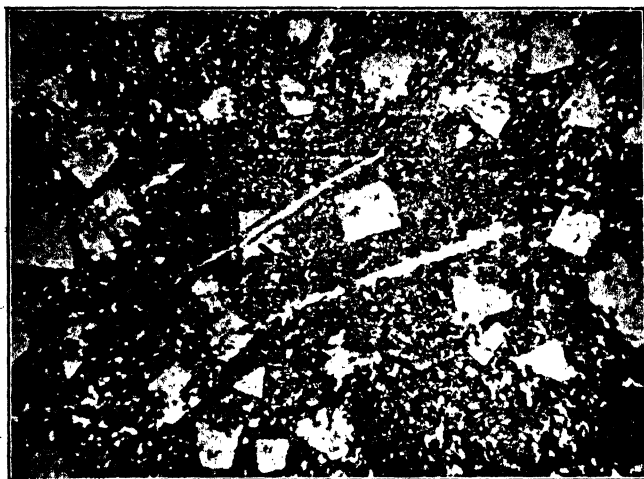

FIG. 28.—Tin-copper-antimony bearing metal. (Law.)

to other intermediate phases only in the broadest sense, since it is, unfortunately, subject to many exceptions.

TABLE 41.—CHARACTERISTIC PROPERTIES OF SOLID SOLUTIONS AND γ AND ϵ PHASES

Solid Solutions	γ and ϵ Phases
Electrical conductivity: high, but less than either pure constituent	Low; many very resistant
Thermal conductivity: high, but less than either pure constituent	Lower
Hardness: relatively soft, but harder than either pure metal	Hard
Relatively ductile	Brittle
Apt to be stronger than either pure metal	
Melting point: generally lower than average of constituents. Sometimes lower than either pure metal	High: apt to be higher than either pure constituent

Because of their high resistance, it is fair to assume that in the γ and ϵ phases the bonds between atoms are not true metallic bonds but must be, to some extent, homopolar or covalent. Some of the electrons, at least, are more firmly attached to definite atoms than they are in the metallic state. There is considerable additional evidence to support such an assumption. Strong diamagnetism may be evidence of homopolar bonds in a metal or compound. Many metals are diamagnetic because they are composed of diamagnetic atoms, but if the diamagnetism is a result of homopolar bonds in the crystal, it will decrease rapidly as the temperature increases and will vanish at the melting point when the crystal breaks down. This is the case with many of the γ structures. It has been shown¹ that Cu_5Zn_8 and $\text{Cu}_{31}\text{Sn}_8$ are both strongly diamagnetic, although copper, zinc, and tin show little diamagnetism. Bernal² has found the same to be true of Cu_9Al_4 , although aluminum itself is definitely paramagnetic.

The apparent dependence of these phases upon a constant ratio of valence electrons to atoms is surely suggestive of homopolar binding. The simplest familiar case of this nature is the long series of homopolar crystals of which the group GeGe , GaAs , ZnSe , CuBr is representative, in which the ratio of valence electrons to atoms is as 8:2.

That this valence electron-atom ratio is fundamental in the γ alloys is confirmed by their solubility relations. If these structures are really homopolar, their very existence depends upon maintaining a ratio of 21 valence electrons for each 13 atoms, and it should be impossible to dissolve copper, for example, in Cu_5Zn_8 ; for the substitution of a copper atom with one valence electron for a zinc atom with two valence electrons would bring the ratio below 21:13. Experiment shows that Cu_5Zn_8 will not dissolve an excess of copper, nor will Cu_9Al_4 or $\text{Cu}_{31}\text{Sn}_8$ dissolve copper. On the other hand, the substitution of zinc for copper will not reduce the number of electrons below the minimum required to hold 13 atoms but will actually increase it, and there is no reason to believe that such a substitution is prohibitive. Actually, a substitution of zinc for copper might be expected to

¹ HONDA, K., and H. ENDO, *J. Inst. Metals*, **37**, 29 (1927).

² BERNAL, J. D., *Trans. Faraday Soc.*, **25**, 37 (1929).

increase the conductivity of the compound, because there is one electron in addition to those needed (21) to satisfy the homopolar bonds. Reference to Fig. 27 shows that the conductivity of Cu_5Zn_8 does increase as it dissolves an excess of zinc. To go a step farther, inasmuch as the substitution of one zinc for one copper adds one electron, while the substitution of one aluminum for one copper adds two, and of one tin for one copper, three, it may be predicted that it is possible to dissolve more zinc than aluminum or tin in the γ alloy before it becomes unstable. This has been confirmed by experiment, the ranges of solid solubility of the metals in the γ alloy being: 8 atomic per cent of zinc in Cu_5Zn_8 , 4 atomic per cent of aluminum in Cu_9Al_4 , and 0.5 atomic per cent of tin in $\text{Cu}_{31}\text{Sn}_8$.¹

Accurate knowledge of these alloys is still quite fragmentary. No doubt they are characterized by homopolar bonds. Whether all the bonds are homopolar and how these bonds are directed, cannot be said with any certainty. If they are typically homopolar, they should show the phenomenon of minimum resistance at low temperature and studies of this sort will no doubt be made in an attempt to classify this interesting group more accurately.

The properties of the β phases are very different from those of the γ and ϵ phases. The conductivity is a maximum at the exact composition CuZn , for example, while in the γ phase the conductivity reaches a minimum at the exact composition Cu_5Zn_8 . That is, the solution of an excess of one of the constituent metals in a β phase lowers its conductivity, while the same procedure raises the conductivity of a γ or ϵ phase. At relatively high temperature the range of solid solubility of the β phase is extended, and it is capable of dissolving a considerable excess of *either* constituent metal. There is the implication that an electron-atom ratio of less than 3:2 does not reduce its stability and thus that homopolar bonding is not an important factor. The β phase is relatively ductile and strong. It has, in short, the properties characteristic of the metallic state. Its exact nature is not known; it is often called a secondary solid solution—a phase having the properties of a solid solution, but a structure different from that of either parent structure.

¹ *Ibid.*

It will help to summarize briefly the outstanding features of the alloys just described. To many of them the three intermediate phases, β , γ , and ϵ , are common.

Phase	Crystal structure	Electron-atom ratio	Valence electron concentration
β	Cubic: majority CsCl structure; some β -Mn structure; see also Fig. 25	3:2	1.5
γ	Cubic: large unit cells containing 52 to 416 atoms; see Fig. 26	21:13	1.61
ϵ	Hexagonal: close packed; axial ratio less than that for close-packed spheres	7:4	1.75

In the large Zone VII in Chart A occur many compounds which possess metallic properties to a varying degree, but are also related to the ionic and covalent compounds. Those which are particularly metallic are the compounds of the transition elements and the noble metals with arsenic, antimony, bismuth, sulfur, selenium, and tellurium. These will be considered in detail in the next chapter. It may be noted here, however, that in this group the ratio of valence electrons to atoms may be 6:2 or 5:2 in those compounds having the nickel arsenide structure (*e.g.*, NiAs, FeS, CoS). In fact, all compounds for which the ratio of valence electrons to atoms is less than 8:2 show some metallic properties, and as the ratio decreases, the compounds become increasingly metallic in nature.

These empirical relationships between crystal structure and electron density, first proposed ten years ago, have finally been given a quantum mechanical explanation¹ which points to a more fundamental understanding of the metallic state. Jones's treatment suggests that in each crystal structure there may occur a maximum number of valence electrons per unit cell; and that different structures will be based on definite valence electron to atom ratios. Jones' calculated limiting electron-atom ratios compare with the empirical values of Hume-Rothery as follows:

¹ JONES, H., *Proc. Roy. Soc. (London)*, A 144, 255 (1934); A 147, 396 (1934); MOTT, N. F., and H. JONES, "Theory of the Properties of Metals and Alloys," pp. 168-174, Oxford University Press, New York, 1936.

Phase	α	β	γ
Jones.....	1.362	1.480	1.538
Hume-Rothery.....	1.4 approx.	1.5	1.61

The actual structures must be assumed for the calculations; it is not yet possible to predict them.

While the Hume-Rothery rule arose from a correlation of structural data for a small group of binary alloys of silver or copper with certain 18-shell atoms, it is quite apparent that there has been a concerted attempt to apply it more generally. The attempt is justified, but the number of apparent exceptions which have been found, make it advisable to consider its possible limitations.

Certain β and γ structures do not appear to fit the proper electron-atom ratios and numerous explanations have been offered and assumptions made. Generally neglected, but certainly of equal significance, are many binary systems in which the electron-atom ratio appears to be met and yet no γ phase has been found.

No doubt, the wise course, pending a more thorough understanding of the matter, is to recognize the Hume-Rothery rule as an interesting generalization, significant and of great value when applied to certain alloys of copper and silver, but unproven, as yet, for any wider application.

Intermediate Phases of the Transition Elements with Boron, Carbon, Nitrogen and Hydrogen.—These elements, it will be remembered, are unique in that, because of their small size, they form interstitial solid solutions with many of the transition elements. Intermediate phases are also formed in many of these systems and are distinctive in some respects.

In the first place, it is interesting to note that a metal combined with any of these elements forms a compound with metallic properties only if it is a transition metal. The alkali carbides are ionic compounds;¹ calcium carbide is a substance familiar to all students of chemistry as the source of acetylene, and is not in the least metallic. It is a very different story when the transition elements form hydrides, carbides, nitrides, or borides.

¹ ZINTL, E., and A. HARDER, *Z. physik. Chem.*, **B 14**, 265 (1931).

Owing primarily to the efforts of Hägg, this group of alloys has been studied sufficiently to permit a rather definite picture of their fundamental nature. His early work has been summarized briefly and clearly by Westgren.¹

Hägg² has shown that when the $R_A:R_X$ ratio is less than 0.59, *i.e.*, when the metalloid atom is small compared with the metal, then the phases crystallize in very simple lattices. Because of their low atomic numbers, it is very difficult to find the positions of hydrogen, carbon, or nitrogen in the lattice by X-ray analysis. The lattice of the metal atoms is either face-centered cubic, body-centered cubic, close-packed hexagonal or simple hexagonal—sometimes slightly distorted. The metalloid atoms occupy the voids in these simple structures. Thus when carbon, for example, fills the interstices in one of the cubic lattices, the compound as a whole will have the sodium chloride structure. When the $R_A:R_X$ value is greater than 0.59, the interstices in the metal lattice are no longer large enough to accommodate the metalloid atoms, and more complicated structures are formed. The influence of atomic radii upon structure is illustrated in Table 42, showing all the known phases of interstitial alloys which fulfill the conditions for the formation of simple structures. It appears that these simple phases correspond to or approach M_4X , M_2X , MX , and MX_2 , where M is the transition metal and X is the metalloid. In most of the M_2X phases, the atoms of the metal are in a close-packed hexagonal lattice; in most of the MX alloys they form a face-centered cubic lattice, and, when the metalloid atoms are added interstitially, they generally form the sodium chloride structure. MoN, having the nickel arsenide structure, is an exception.

The geometrical relations in the series Ti-H, Zr-H, and Ta-H are interesting.³ Apparently TiH and ZrH are analogous to TiC and CrN and possesses the NaCl structure. But, if this were true and hydrogen and the metal were in contact, then the radius of hydrogen would be 0.7–0.8 Å, which is too high, judging from its position in other interstitial structures. The radius of hydrogen in most of these structures is about 0.4 Å. This dis-

¹ WESTGREN, ARNE, *J. Franklin Inst.*, **212**, 577 (1931).

² HÄGG, G., *Z. physik. Chem.*, **B 12**, 33 (1931).

³ *Ibid.*, **B 11**, 433 (1930).

TABLE 42.—SURVEY OF THE INTERSTITIAL INTERMEDIATE PHASES OF THE TRANSITION ELEMENTS IN COMBINATION WITH HYDROGEN, CARBON, AND NITROGEN*

System	$R_X:R_M$	M_4X	M_2X	MX	MX_2
Zr-H	0.29	12a, 4	12b, 4	12a, 4	ThC ₂
Ta-H	0.32	12b, 4	8a, 4	?
Ti-H	0.32	12b, 4	12a, 4	12a, 4
Pd-H	0.34	12a, 4	?	?
La					
Ce					
Pr C	0.42	?	?	?	LaC ₂
Nd					
Th-C	0.43	?	?	?	ThC ₂
Zr-N	0.45	?	?	12a, 6	?
Sc-N	0.47	?	?	12a, 6	?
U-C	0.48	?	?	?	LaC ₂
Zr-C	0.48	?	?	12a, 6	?
Cb-N	0.49	?	?	12a, 6	?
Ti-N	0.49	?	?	12a, 6	?
W-N	0.51	12a, 6	?	?
Mo-N	0.52	12a, 6	8b, 6	?
V-N	0.53	?	?	12a, 6	?
Cb-C	0.53	?	?	12a, 6	?
Ti-C	0.53	?	?	12a, 6	?
Ta-C	0.53	?	12b, 6	12a, 6	?
Mn-N	0.55	12a, 6	12b, 6	?	? also Mn ₃ N ₂
W-C	0.55	12b, 6	8b, 6	?
Cr-N	0.56	12b, 6	12a, 6	?
Mo-C	0.56	12b, 6	?	?
Fe-N	0.56	12a, 6	12b, 6	?	? also Fe ₃ N
V-C	0.58	12b, 6	12a, 6	?
Cr-C	0.60	12a, 6			
Mn-C	0.60	12a, 6			
Cr-C	0.60	Complex structures			Cr ₃ C ₂ , Cr ₇ C ₃ , Cr ₄ C
Mn-C	0.60	Complex structures			Mn ₇ C ₃ , Mn ₄ C, Mn ₃ C
Fe-C	0.60	Complex structure			Fe ₃ C
Co-C	0.61	Complex structure			Co ₂ C
Ni-C	0.61	Complex structure			Ni ₃ C

a = cubic or pseudocubic.

b = hexagonal or pseudo-hexagonal.

First figure is the coordination of the metal atoms.

Last figure is the coordination between metal and metalloid atoms.

* Ηλιο, G., *Z. physik. Chem.*, B 12, 33 (1931).

crepancy is avoided if it be assumed that hydrogen atoms fill the next to the largest spaces, rather than the largest. This type of penetration is shown in Fig. 29. If the hydrogen atoms filled the largest interstices in the face-centered cubic lattice of titanium, they would take the positions shown in Fig. 29a, forming a NaCl lattice. Actually, however, they probably fill the smaller spaces, and the zinc-blende structure of Fig. 29b results. It is obvious that this is only a halfway point, as it were, for only four of the eight identical spaces have been filled. The gradual filling of the other four accounts for the ease with which hydrogen

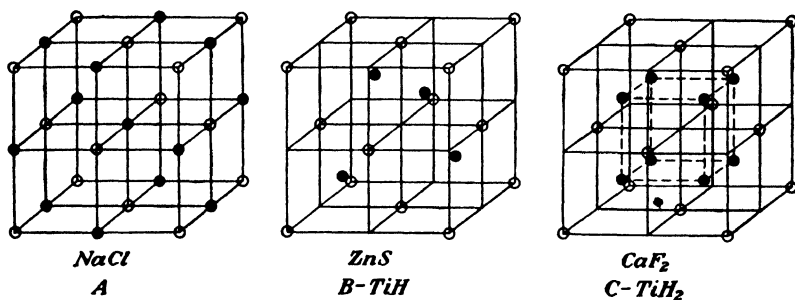

FIG. 29.—Possible positions of hydrogen atoms in interstitial hydrides. Black circles are hydrogens. [From A. Westgren, *J. Franklin Inst.*, **212**, 577 (1931), by permission of the Franklin Institute.]

may be dissolved in TiH, resulting in a homogeneous range for this phase extending from 50 per cent hydrogen, TiH, to 67 per cent hydrogen, TiH₂. When the interstices are entirely filled, the structure shown in Fig. 29c, that of CaF₂, results, and corresponds to the compound TiH₂. Similarly, in the close-packed hexagonal phases of these systems, hydrogen atoms probably go into the next to the largest interstices to form an incomplete wurtzite structure, corresponding to the formulas Ti₂H, Zr₂H, and Ta₂H. In TaH alone the hydrogen atoms are probably in the largest interstices.

A few of the dicarbides have been studied,¹ and again, the dependence of crystal structure upon the size of the building stones is nicely illustrated. The two carbon atoms of the molecule act as a C₂ group in the crystal lattice (see Fig. 30). This C₂

¹ STACKELBURG, M. VON, *Z. physik. Chem.*, **B 9**, 437 (1930).

group is relatively large and elongated, as compared with the single carbon atom in the monocarbides. As a result the dicarbides are tetragonal, rather than cubic, and they are only possible for the larger transition elements which will form larger interstices in the simple metal lattice. The series CaC_2 , SrC_2 , BaC_2 , LaC_2 , CeC_2 , PrC_2 , NdC_2 is structurally isomorphous. There is no mistaking those of the transition elements, however. They are distinctly metallic in properties and show a considerable solid solubility range, while the alkaline earth dicarbides do not dissolve an excess of either component and they are transparent.

Properties of Interstitial Intermediate Phases.—The mechanical properties of the carbides, in particular, are of very great importance in connection with the heat treatment of alloy steels. Fe_3C , cementite, is an important constituent of all cast irons and is an extremely hard and brittle substance. From the standpoint of industrial application, the hardness of the carbides and nitrides is being applied to advantage with increasing frequency. The formation of Fe_3C in steel is a part of case hardening. Case hardening may also be accomplished by inducing the formation of Fe_3N . An alloy of which tungsten carbide is the main constituent has found wide use as a cutting tool, as has chromium carbide. A recent forward step has been the production of tantalum carbide in a form suitable for use as a high speed tool. This is probably the most resistant material which has ever been made available for general use. A comparison of some of its properties with those of tungsten carbide, until recently the most resistant tool material in use, brings out its superiority in striking fashion.¹ All of the hard transition metal carbides are very brittle and not used as machine tools in the pure form. They are ground to a fine powder and mixed with a suitable binder. Iron and manganese have been used as binders; at present, cobalt is in favor. The nature and amount of binder used have an appreciable effect upon the hardness and strength of the product. The hardness of TaC and of CbC is 9+, on the Moh's scale (diamond = 10, corundum = 9). The comparative wearing qualities of the two carbides, TaC and WC , are demonstrated by the following data:

¹ KELLEY, F. C., *Trans. Am. Soc. Steel Treating*, **19**, 233 (1932).

Test piece.....	3½ per cent nickel steel, Brinell hardness 219
Conditions.....	⅛ in. cut, 0.025-in. feed, 180 ft. per minute
Results.....	WC, 13 per cent cobalt binder, life of tool = 15.4 min.
	WC, 6 per cent cobalt binder, life of tool = 26.2 min.
	TaC, 13 per cent cobalt binder, no wear after 40 min.

The following are typical tests which indicate the value of tantalum carbide tools:¹

1. Turned the entire length of a 12 to 15 per cent manganese steel, 43 in. long. Feed, 0.01 in.; speed, 100 ft.; cutting time, 1 hr.

2. Used for roughing cut on a cast-iron roll, 8 in. diameter, 4 ft. long. ⅛ to ¼-in. cut, 0.017-in. feed. Speed, 200 ft. per minute. (This roll had four 1-in. keyways for its entire length.)

The second test described is remarkable evidence of the resistance to shock which a tantalum carbide tool exhibits. In both the above tests the tool showed little wear at the end of the run.

Inasmuch as considerable expense is involved in the sharpening and readjustment of tools in many machine operations, the time and money which might be saved by the use of these "long life" carbides should more than compensate for their high original cost.

Strange from the older chemical viewpoint, but quite consistent with the views of crystal chemistry, is the similarity of carbon and nitrogen in their influence upon iron. Their behavior has nothing to do with their chemical properties, but appears to be a matter of size. A detailed discussion of the many ramifications of the heat treatment of steel is beyond the scope of this book. However the importance of atomic size in connection with this problem and the parallelism of carbon and nitrogen may be illustrated briefly. In austenite the iron is in the face-centered cubic γ form and the carbon atoms are in solid solution in the metal interstices. Upon slow cooling, the iron changes to the body-centered cubic α form, whereupon there is no longer room enough to accommodate all the carbon atoms and they are ejected from solution and form cementite, Fe_3C . If, on the other hand, the γ iron is suddenly chilled, the carbon does not have a chance to escape, but remains dissolved in the iron lattice, distorting it to the body-centered tetragonal structure known as martensite. A similar effect occurs in the iron-nitrogen system. It is possible to dissolve 3 per cent of nitrogen in γ iron, whereas α iron

¹ BALKE, C. W., Discussion accompanying Kelley's paper, *op. cit.*

will retain, under normal conditions, only 0.2 per cent of nitrogen. By quenching a γ iron containing, say 1.5 per cent nitrogen the distorted, tetragonal martensite structure can be produced, even though no carbon is present.

Intermediate Phases of the Alkalies and Alkaline Earths.—Recently Zintl and his collaborators¹ have systematically surveyed a large number of the alloys of the alkali and alkaline earth metals, so that for the first time sufficient data are at hand to consider the behavior of these metals as a group. The immediate purpose of these investigators was to follow the formation of the β phase in alloys of the alkali and alkaline earth metals with copper, silver, and gold and the Class II metals; and to compare the β phases of these systems with the β phase typified by that of β brass. Their investigation was prompted by the observation that the compounds NaTl and NaPb₃ possess properties characteristic of the β phases but do not follow the 3:2 valence electron-atom rule. The systems studied and the data obtained are listed in Table 43.

Only mixtures of 50 atomic per cent of each metal were investigated. Because the CsCl structure is stable only when the $R_A:R_X$ ratio is 0.73–1.00, Zintl selected only those metal pairs which fulfill these requirements. The β phases of copper, silver, and gold have been included in the table for comparison. Most of the β structures are of the CsCl type. The NaTl structure is also body-centered cubic, but about twice as large.² It may occur only when the ratio $R_A:R_X$ is unity. It will be observed that the β structures may be divided into two groups; those in which the atomic radii are the same as their radii in the pure metallic state (Cu, Ag, and Au with Zn, Cd, Be, and Pd), and those in which the formation of the intermediate phase has caused a marked contraction. To this latter group belong also the phases with the NaTl structure and AlCu₃.

To discover the significance of this contraction we must know which metal atom of the pair undergoes a decrease in size. The NaTl structure offers the opportunity to learn this, since in this structure it is geometrically necessary that both metals be the

¹ A fairly complete summary of the important results may be found in ZINTL, E. and G. BRAUER, *Z. physik. Chem.*, **B 20**, 245 (1933).

² ZINTL, E., and W. DULLENKOPF, *Z. physik. Chem.*, **B 16**, 195 (1932).

TABLE 43.—BETA PHASES IN ALLOYS OF ALKALI AND ALKALINE EARTH METALS*

Systems studied	Phase	Interatomic distance	Sum of radii†	Linear contraction per cent	Electron : atom ratio
Li-Ag	CsCl structure				
Li-Au	CsCl structure				
Li-Zn	ZnCu	2.56	2.58	0 approx.	3:2
Li-Cd	BeCu	2.33	2.34	0 approx.	3:2
Li-Hg	PdCu	2.59	2.57	0	3:2(a)
Li-Ga	ZnAg	2.74	2.74	0	3:2
Li-In	CdAg	2.88	2.87	0	3:2
Li-Tl	ZnAu	2.73	2.74	0	3:2
Li-Sn	CdAu	2.89	2.87	0	3:2
Li-Bi	CsCl structure				
Mg-Tl	LiAg	2.74	2.92	6	2:2
Ca-Tl	LiHg	2.85	3.02	6	3:2
Sr-Tl	LiTl	2.97	3.18	7	4:2
Ba-Tl	MgAg	2.84	2.95	4	3:2
K-Tl	MgTl	3.14	3.21	2	5:2
Ca-Pb	CaTl	3.33	3.57	7	5:2
Sr-Pb	SrTl	3.49	3.76	7	5:2
Ce-Pb	NiAl	2.44	2.60	6	3:2
Na-Ag	CoAl	2.47	2.61	5	3:2
Ca-Ag	CsCl structure				
Li-Al	CsCl structure				
NaTl Structure					
	Li-Al	2.76	2.93‡		
	LiGa	2.68	2.86	6	4:2
	LiZn	2.69	2.86	6	3:2
	LiCd	2.90	2.99	3	3:2
	LiIn	2.94	3.04	3	4:2
	NaTl	3.24	3.52	8	4:2
	AlCu ₃ (b)	2.53	2.63	4	6:4
	SnCu ₆	2.57	2.57(c)	0	9:6

a. PdCu is believed to conform to the 3:2 ratio.

b. Extrapolated from the constant for (Cu, Mn)₂Al: PERSSON, E., *Z. Physik*, **57**, 115 (1929).

c. The phase SnCu₆ extends from 14 to 20 per cent tin, the average composition being 17 per cent tin, and the distribution of tin atoms statistical. Radius calculated from formula:

$$\text{Sum of radii} = 2(0.17R_{\text{Sn}} + 0.83R_{\text{Cu}}) = 2.57 \text{ \AA}$$

* ZINTL, E., and G. BRAUER, *Z. physik. Chem.*, **B 20**, 245 (1933).

† See Table 122, Appendix. Values corrected for coordination number.

‡ ZINTL, E., and WOLTERSBOFF, *Z. Elektrochem.*, **41**, 876 (1935).

TABLE 44.—ATOMIC RADII IN CRYSTALS WITH THE NaTl STRUCTURE

Atomic radius of	In the phase	Found	Atomic radius*	Difference, per cent
Lithium.....	LiZn	1.34	1.52	12
	LiGa	1.34	12
	LiCd	1.45	5
	LiIn	1.47	3
	NaTl	1.62	1.86	13
Sodium.....	LiZn	1.34	1.34	0
Zinc.....	LiGa	1.34	1.34	0
Gallium.....	LiCd	1.45	1.47	1
Cadmium.....	LiIn	1.47	1.52	3
Indium.....	NaTl	1.62	1.66	2
Thallium.....				

* See Table 122, Appendix.

same size. The radii of the atoms can then be determined as illustrated in Table 44.¹

These data point out two facts of interest. First, it is evident that it is the alkali atom which has contracted. Second, the smaller the atom with which it is paired, the greater the contraction of the alkali. This effect is quite consistent with the usual conception of polarization. The alkali atoms are relatively large. The other atoms are small, and polarization of the alkali atoms is to be expected. Without doubt, this abnormal contraction produces a structure in which the interatomic bonds are no longer strictly metallic, in contrast to the β phases, in which little or no contraction occurs, which have the properties of true metals. Beyond the realm of mere coincidence is the fact that it is these phases, in which the large contraction occurs, which do not follow the Hume-Rothery valence electron-atom rule. As has been remarked above, it is quite possible that the rule should not be applied to such alloys.

The question may be raised as to whether the alkali metals can form true γ phases. Several large unit cells, characteristic of the γ phase have been reported, among which may be mentioned Na_4Pb ,² Li_4Sn ,³ and $\text{Ag}_3\text{Li}_{10}$.⁴ The first of these is face-centered

¹ ZINTL, E. and G. BRAUER, *Z. physik. Chem.*, **B 20**, 245 (1933).

² STILLWELL, C. W., and W. K. ROBINSON, *J. Am. Chem. Soc.*, **55**, 127 (1933).

³ BARONI, A., *Atti accad. Lincei*, (6) **16**, 153 (1932).

⁴ PERLITZ, HAROLD, *Z. Krist.*, **86**, 155 (1933).

cubic with 78 atoms in the unit cell. The first two may be written as $\text{Na}_{31}\text{Pb}_8$ and $\text{Li}_{31}\text{Sn}_8$, respectively, to conform to the 21:13 ratio requirement. The abnormal contraction of the first and third have already been discussed. Whether or not the alkali metals form true γ phases cannot be stated until the criteria for a true γ phase are more clearly established.

Another group of alloys which has been found to be structurally similar includes NaPb_3 ,¹ CaPb_3 , SrPb_3 , CePb_3 , CaTl_3 , CaSn_3 , CeSn_3 ,² LaSn_3 and LaPb_3 ,³ PrSn_3 and PrPb_3 .⁴ These are interesting from the geometric standpoint, and because of their similarity to some of the important superstructures to be discussed later. Goldschmidt has shown that for a cubic lattice of the type AX_3 , the ratio $R_A:R_X$ must be 1.0–2.4. It may be shown that all of the phases listed above fall within these limits, and, as one might predict, no phase LiPb_3 exists, since the radius of lithium is too small and the ratio $R_A:R_X$ is less than unity. With this type structure, it should be geometrically impossible to have AX_3 and A_3X phases in the same system. As a matter of fact, the alloys AuCu_3 , PdCu_3 , and PtCu_3 , superstructures isomorphous with NaPb_3 , are well known, but Au_3Cu , Pd_3Cu , and Pt_3Cu apparently do not exist.

As with the β structures containing alkali metals and with the NaTl structure, there is an appreciable contraction of the interatomic distances in the NaPb_3 structure. A small contraction has also been measured for AuCu_3 , PdCu_3 , and PtCu_3 , so that it may be a function of the atomic arrangement as well as of the atoms.

Intermediate Phases of Fixed Composition.—There are a great many intermediate phases which have a very narrow composition range, within 1 or 2 per cent, and may be considered as compounds of fixed composition. Typical examples are Mg_2Pb , Cu_3Sn , MgCu_2 , MgZn_2 , etc.⁵ Most of the compounds formed in Zone VII on the chart of binary systems, if they be classed as intermetallic compounds, fall in this class.

¹ ZINTL, E., *Z. physik. Chem.*, **A 154**, 63 (1931). Face-centered cubic: Na at the corners of the cube; Pb at face centers.

² ZINTL, E., and S. NEUMAYR, *Z. Elektrochem.*, **39**, 86 (1933).

³ ROSSI, A., *Atti accad. Lincei*, (6) **17**, 839 (1933).

⁴ ROSSI, A., and E. CHINI, *Gazz. chim. ital.*, **64**, 832 (1934).

⁵ See also JURRIANSE, T., *Z. Krist.*, **90**, 322 (1935).

The compounds are apt to occur either as a result of the electronegative valency effect or when the difference in the metallic radii is large. In $MgCu_2$ and $MgZn_2$, for example, the ratio of the volume of copper to magnesium is 1:2, and the structures are essentially the close-packed cubic and hexagonal structures of copper and zinc, respectively, in which one magnesium replaces two copper or zinc atoms.

These compounds exhibit some of the same properties which characterize the phases of variable composition. They are hard and brittle; poor conductors of heat and electricity. The specific resistance of a series of such compounds, as compared with the specific resistance of their constituents, is given in Table 45¹ and may be taken as indicative of the nature of the bonds within the compound.

TABLE 45.—SPECIFIC RESISTANCES OF TYPICAL INTERMETALLIC COMPOUNDS

Compound	Specific resist. $\times 10^6$	Specific resist. of elements $\times 10^6$	
Mg_2Pb	148.0	Mg 4.4	Pb 21.1
Mg_2Sn	1096.0		Sn 11.6
$MgCu_2$	5.5		Cu 1.7
Mg_2Cu	11.9		
$MgZn_2$	15.9		Zn 6.4
Mg_2Bi	130.0		Bi 114.
Mg_3Ag	16.0		Ag 1.6
Cu_3Sn	11.1	Cu 1.7	Sn 11.6
Cu_3Sb	8.3		Sb 39.0
Cu_3As	59.0		As 35.0

In general, the resistance is, to a rough approximation, what might be expected. That is, when two typical metals form a compound, the resistance is relatively low, indicating that metallic bonds predominate in the so-called compound. When one element of the compound is strongly electronegative with respect to the other component, the resistance is apt to be high, suggesting the existence of nonmetallic forces in the crystal. There are notable inconsistencies within this second group,

¹ HUME-ROTHERY, WILLIAM, "The Metallic State," p. 59. Oxford, Clarendon Press, New York, 1931.

however. Thus, although copper and magnesium are both true metals, and tin and lead are similar, the specific resistance of Mg_2Pb is over ten times that of Cu_3Sn , while Mg_2Sn is one hundred times that of Cu_3Sn . Undoubtedly the crystal structure of the compounds plays a part, particularly as it determines the coordination of the atoms. Both Mg_2Sn and Mg_2Pb have the fluorite structure, a typical ionic lattice with C.N. 8 and 4. Such low coordination is not characteristic of the metallic state and is conducive to an ionic rather than metallic bond in the crystals.

Bismuth and arsenic being Class III elements, their compounds might be expected to show high electrical resistance; but Cu_2Sb has an extremely low resistance. Such inconsistencies make it dangerous to attempt to generalize in any but the broadest terms.

The conditions under which compounds, usually recognized as metallic, crystallize in ionic or covalent lattices have been discussed by Zintl.¹ Typical compounds of this type are: $SnSb$ (NaCl lattice); $CuSn$ (NiAs structure); $InSb$ (ZnS structure); Mg_2Si (CaF_2 structure). Nonmetallic lattices may be formed when the anion building component has a valence of four or higher. Dehlinger goes so far as to visualize a gradual transition from the metallic to the ionic bond, depending upon A 's positivity with respect to X .² Thus, while the metallic bond will predominate in the systems magnesium-zinc and zinc-aluminum, in the system magnesium-aluminum the bond will be more ionic due to the greater positivity of magnesium toward aluminum.

Superlattices.—It will be recalled that when one metal dissolves in another, the solute atoms replace the solvent atoms at random positions in the solvent lattice. If copper, for example, is added to face-centered cubic gold, there are no specific lattice points to which the solute atoms go in a definite order. When 50 per cent of the atoms have been replaced, however, there is the chance for an orderly arrangement, at the composition $AuCu$, and this orderly arrangement is termed a superlattice. In most alloys which form superlattices, this rearrangement cannot take

¹ ZINTL, E., and H. KAISER, *Z. anorg. allgem. Chem.*, **211**, 113 (1933).

ZINTL, E., and E. HUSEMAN, *Z. physik. Chem.*, **B 21**, 138 (1933).

² DEHLINGER, U., *Z. Elektrochem.*, **41**, 344 (1935).

place instantaneously, since it may require considerable juggling of the atoms. Given sufficient time, it will take place, because in the orderly arrangement the atoms take up the least space; and this arrangement is more stable, since each atom has an interatomic distance nearest to that in the pure metal. It often requires careful annealing to furnish the time needed for the rearrangement, although in some alloys (*e.g.*, β brass) the ordered state cannot be prevented at room temperature.

Again, as copper in excess of 50 atomic per cent is added to the alloy, it enters the lattice statistically until the composition AuCu_3 is reached. Here, given time by long annealing, the atoms can again arrange themselves in an orderly manner, a cubic structure with gold at the corners and copper atoms face centered. A gold-copper alloy in which the superlattice exists has physical properties more characteristic of intermetallic phases than does the disordered solid solution. It is more brittle, harder, and has better wearing qualities. This is applied to advantage in the treatment of gold-copper fountain-pen points.

A superstructure in the Heusler alloys apparently accounts for their magnetism.¹ $(\text{Cu, Mn})_9\text{Al}_4$, on annealing and cooling, has the Cu_9Al_4 type of lattice. Quenching from 800°C . produces the magnetic alloy—body-centered cubic with a face-centered superstructure.²

A great deal of interest has recently been shown in the transition from the disordered to the ordered distribution. Perhaps the most easily understood treatment of this ordered-disordered transformation is that of Bragg and Williams.³

Treating it as a dynamic equilibrium, they have shown that there is a critical temperature below which the ordered arrangement is stable, and the rate of cooling past this critical value must be slow if the atoms are to assume their ordered positions.⁴

¹ HEUSLER, OTTO, *Z. Metallkunde*, **25**, 274 (1933).

² BRADLEY, A. J., and J. W. ROGERS, *Proc. Roy. Soc. (London)*, **A 144**, 340 (1934).

³ BRAGG, W. L., and E. J. WILLIAMS, *Proc. Roy. Soc. (London)*, **A 145**, 699 (1934).

BETHE, H. A., *Proc. Roy. Soc. (London)*, **A 150**, 552 (1935), has treated the problem of the ordered-disordered transition in a more rigorous manner, but his treatment is correspondingly difficult to apply.

⁴ No such critical temperature has been found in the Fe-Si system.

The very excellent study of the superlattices of iron and aluminum, made by Bradley and Jay,¹ has demonstrated precisely the manner in which the atoms enter the positions in the lattice as the composition varies. From their results it has been possible to gain a rather clear insight into the factors which govern the formation of superlattices.

The superlattices of iron and aluminum are body-centered cubic.² Bragg observed that, at equilibrium conditions, aluminum atoms tend to avoid being nearest neighbors; they assume positions at the cube centers in FeAl. Furthermore, in Fe₃Al they even avoid positions in cubes which are adjacent.

This conception of the distribution has been enlarged upon and generalized by Hume-Rothery and Powell.³ In any structure, the neighbors of any given atom are distributed in zones. Thus, in the body-centered cubic, an atom at the cube center has 8 nearest neighbors in the first zone, 6 in the second zone, 12 in the third equidistant zone and so on. An analysis of several superlattices indicates that the solute atoms are in the most distant possible zones, relative to each other. In Fe₃Al the required number of aluminum atoms can be added without aluminum atoms having aluminum neighbors nearer than the third zone, and this is what actually occurs. As the number of aluminum atoms increases from 25 to 50 per cent, however, it is impossible to keep them out of the second zone, but the arrangement is such that no aluminum atoms are direct first zone neighbors.

It is natural that the solute atoms should keep as far apart as they can, for they distort the solvent lattice, and the more uniformly this distortion is distributed, the more stable will be the alloy structure.

It follows, also, that other things being equal, the stability of a superlattice is greater, the greater the difference in atom diameters of solvent and solute metals; for with a large lattice distortion there is a greater tendency to relieve this strain by atomic arrangement. It is more than a coincidence, then, that superlattices are found in the Cu-Au system, but not in the

¹ BRADLEY, A. J., and A. H. JAY, *J. Iron Steel Inst.*, **125**, 339 (1932); *Proc. Roy. Soc. (London)*, **A 136**, 219 (1932).

² BRAGG, W. L., *Nature*, **131**, 749 (1933).

³ HUME-ROTHERY, WILLIAM, and H. M. POWELL, *Z. Krist.*, **91**, 23 (1935).

Ag-Au alloys. In Au-Pd, Sb-Bi, and Mo-W also the elements are too nearly the same size to favor superlattice formation.

Because of the size factor, superlattices are not over abundant. If the solvent and solute atoms are too nearly of a size, they affect so little distortion that an atomic rearrangement would have little effect on stability; if the size factor is too unfavorable not enough solute atoms can be taken in to form a superlattice of a low zone number.

To summarize, then, superlattices are apt to occur when the diameters of solvent and solute are neither too nearly equal nor too unequal; and at the compositions marking the geometric completion of definite solute zones, *viz.*, A_3B and AB .

Factors Influencing the Formation of Intermediate Phases.—The foregoing discussion of the formation of intermediate phases leads to the tentative conclusion, which can be safely applied only to those types of alloys which have actually been cited, that an intermediate phase may exist by virtue of one or more of the following conditions:

1. The Size Factor.—This is probably the controlling influence in the formation of interstitial phases and the NaTl and NaPb₃ structures described by Zintl. It also influences superlattice formation although these are not thought to be separate phases.

2. The electron density appears to determine the structure of the so-called electron compounds. These are the β and γ phases of Hume-Rothery and are generally made up of atoms of very nearly equal sizes. When the sizes of the atoms differ appreciably (as in Cu₅Cd₈) the atomic distribution (but not the structure) is affected.

3. Loosely held electrons in one atom and electron affinity in the other, or strong attraction between nuclei. These compounds exhibit both metallic and ionic properties; Mg₂Sn is a typical example.

The Definition of an Intermetallic Compound.—A consistent definition of an intermetallic compound is an elusive thing; for this reason, the term "intermediate phase" has been substituted throughout the discussion. Clark¹ says that when the forces of combination are strong enough to overcome the forces of diffusion, a compound will be formed. No doubt this is true, but it is

¹ CLARK, G. L., *Metals & Alloys*, **1**, 21 (1930).

a general statement, and would hardly do as a definition. Westgren and Phragmen,¹ some years ago, proposed that in an ideal intermetallic compound, structurally equivalent atoms are chemically identical. For some time this appeared to be a very helpful criterion. It is obviously valid in well-known ionic and homopolar compounds. In sodium chloride, for example, the chemically equivalent chloride ions are on a face-centered cubic lattice and therefore structurally equivalent, while the sodium ions are on another face-centered cubic lattice. The intermetallic compounds known at that time followed the rule equally well; even complicated structures, like γ brass, seemed to conform. In this crystal (see Fig. 28) the atoms are in four structurally equivalent groups containing 8, 8, 12, and 24 atoms, respectively, and it has been shown that the copper and zinc atoms are not arranged at random in this lattice, but the copper atoms, 20 in number, are in structurally equivalent groups 8 and 12, while the 32 zinc atoms are in the groups 8 and 24. The same structural and chemical equivalence has been found in Ag_5Zn_8 and Ag_5Cd_8 . To be sure, Cu_5Cd_8 apparently digresses somewhat² in that the grouping is copper, 8-8, and cadmium 4-8-24, but it is worth noting that of these four compounds, Cu_5Cd_8 is the only one in which the divalent atom is appreciably larger than the univalent.

With the structure analysis of β manganese and the subsequent discovery that the alloy Ag_3Al is isomorphous with it, the situation became more complicated. The β manganese structure contains 20 atoms in the unit cell, two structurally equivalent groups of 8 and 12 atoms each. There are, therefore, 5 molecules of Ag_3Al in a unit cell, but by no stretch of arithmetic can 15 silver atoms and 5 aluminum atoms be divided into these two groups so that one group is composed entirely of chemically equivalent silver atoms and the other of aluminum atoms. The matter becomes even worse for Cu_5Si , also isomorphous with β manganese. Here it is impossible to have a whole number of molecules in the unit cell. As a matter of fact, X-ray diffraction data show clearly that in both these alloys the different metals are distributed statistically in the lattice and there is no suggestion of an orderly arrangement. The first reaction to this situation

¹ WESTGREN, ARNE, and G. PHRAGMEN, *Phil. Mag.*, (6) 50, 31 (1925).

² BRADLEY A. J., and C. H. GREGORY, *Phil. Mag.*, (7) 12, 143 (1931).

was to assume that these are not true intermetallic compounds, since they violate the definition which had been established. It was soon realized, however, that this was not a useful assumption to make, because their properties are so typical of intermetallic compounds. Westgren¹ has recently abandoned the definition of intermetallic compound as given above.

In the last analysis an intermetallic compound can only be defined with the help of purely arbitrary assumptions. If it be assumed that the metallic bond is a chemical bond, intermediate between the homopolar and ionic bonds—and a good case can be made out for this assumption—then all so-called intermetallic compounds and all solid solutions should be classed as compounds for the nature of the bonding forces is similar in all intermediate phases.

If one wishes to subdivide intermediate phases into intermetallic compounds of fixed or variable composition and solid solutions, this is best done on the basis of their properties. Those alloys which show evidence of binding forces other than truly metallic may be classed as intermetallic compounds.

It is particularly necessary to fall back on this criterion in the classification of the superstructures. Are they, or are they not, to be classed as compounds? Their constituent metals are miscible in all proportions and there is no appreciable change in the nature of their binding forces when the arrangement of the atoms becomes orderly at certain compositions and under special conditions. In some cases their properties are characteristic of intermetallic compounds. But it is doubtful that they should be considered as separate phases. All degrees of ordered arrangement are possible in a solid solution and it is impossible to say arbitrarily at what stage solid solution ends and compound begins. It is interesting to be reminded in passing, however, that in compounds (*e.g.*, sodium chloride) a superlattice or orderly arrangement is the normal thing, while in solid solutions the superlattice is abnormal.

Of course, use of the term "compound of variable composition" flaunts the law of definite proportions, which students in elementary chemistry have long been taught to accept as one of the fundamental tenets of the science. A γ phase compound has

¹ WESTGREN, ARNE, *Z. angew. Chem.*, **45**, 33 (1932).

recently been reported¹ as $Mn_{1-2.9}Zn_{11.9-10.1}$ a strange looking formula from the orthodox standpoint, but a true representation of the facts.

The intermetallic compound of relatively fixed composition, $FeSi_2$, is only stable with a slight excess of silicon.² The compound $CuAl_2$ is not stable in exact stoichiometric proportions³ but must always contain a slight excess of aluminum. High-temperature electromotive force measurements on brass and similar alloys have shown that the range of the β phase (in brass, $CuZn$) does not always include the 50-50 composition.⁴

Most interesting, perhaps, are the compounds FeS ,⁵ $FeSe$,⁶ and FeO .⁷ In each case there is a range of solid solubility on the iron-poor side of these compounds and, in spite of the law of definite proportions and the principles taught in elementary chemistry, a homogeneous compound, FeO , does not exist at room temperature. The stable lattice is apparently an ideal lattice for FeO , but with some of the iron atoms removed.

Further examples of "compounds" of variable composition and their reconciliation with the law of definite proportions are discussed in succeeding chapters. Hägg has recently presented this general subject in a very interesting manner.⁸ Suffice it to say here that our present knowledge of the forces which produce chemical combination makes it apparent that constant composition in compounds depends either upon electron transfer as in ionic compounds, or upon definite electron sharing, as in organic and other homopolar compounds. When chemical combination no longer depends upon these forces, there is no reason to expect compounds of constant composition. It is quite clear that the law of definite proportions does not, and would not be expected to, apply to "compounds" with metallic properties.

¹ PARRAVANO, N., and V. CAGLIOTO, *Atti accad. Lincei* (6) **14**, 166 (1931).

² PHRAGMEN, GOSTA, *J. Iron & Steel Inst.*, **116**, 397 (1926).

³ STOCKDALE, D., *J. Inst. Metals*, **52**, 111 (1933).

BRADLEY, A. J., *J. Inst. Metals*, **52**, 117 (1933).

⁴ ÖLANDER, A., *Z. physik. Chem.*, **A 163**, 107 (1933); **A 164**, 428 (1933).

⁵ HÄGG, G., *Nature*, **131**, 167 (1933).

⁶ HÄGG, G., and A. I. KINDSTROM, *Z. physik. Chem.*, **B 22**, 453 (1933).

⁷ JETTE, E. R., and F. FOOTE, *J. Chem. Phys.*, **1**, 29 (1933).

⁸ HÄGG, G., *Z. Krist.* **91**, 114 (1935).

CHAPTER V

THE STRUCTURES OF BINARY COMPOUNDS

It has been shown that the structure of a crystal depends upon the relative numbers, the relative sizes, and the polarization properties of its building stones and upon the type of bonding forces between them. These criteria may be applied to the structures of binary compounds. Chart A, in the Appendix, is a classification of a number of the binary systems in such a way as to show the dependence of crystal structure and bond type upon the size and electronic structures of the components. It is a convenient outline and summary of the principles involved in the structure of binary compounds.

The Ionic and Covalent Bonds. Polarization.—The nature of the chemical bond in crystals plays an important part in any discussion of crystal structure. Polarization also exerts a real, but probably less important, influence on structure.

It will be well, first, to review and summarize briefly certain important facts concerning ions.

1. In comparison with the number of positive ions known, the number of negative ions is very limited; probably only the following simple ones ever exist: H^- , F^- , Cl^- , Br^- , I^- , O^- , S^- , Se^- , Te^- .

2. These negative ions all have the rare gas configuration—2 or 8 electrons in the outer shell.

3. With anions of similar structure (*e.g.*, Cl^- and S^-), the radius increases with the nuclear charge; with cations of similar structure (*e.g.*, K^+ and Ca^{++}), the reverse is the case.

4. The number of anions is limited further by the nature of the cation with which they are associated; a cation with a high ionization potential may lead to a predominantly covalent bond, thus eliminating the ion as such.

5. Reference will be made in the following discussion to five types of ions, classified according to structure:

- a. Those with 2 electrons in the outer shell: H^- and the cations of the first period.

- b. Those with 8 electrons in the outer shell: the negative ions and those of the *A* subgroups, not including the transition elements. The 8-electron ions will be referred to as *A* cations.
- c. Ions of the transition elements, containing 8 to 18 electrons in the outer shell.
- d. The ions of the *B* subgroups, containing 18 electrons in the outer shell and referred to hereafter as the *B* cations.
- e. A few ions of the *B* subgroups, which are stable with $18 + 2$ electrons in the outer shell, will be referred to as the $18 + 2$ cations.

*The Ionic Bond.*¹—The formation of an ionic compound is influenced principally by two factors: (1) the ability of the metal atom to deliver one or more electrons and (2) the affinity of the nonmetallic atom toward electrons. The ions in a solid crystal are held in equilibrium by the attractive force of the oppositely charged ions—the coulomb force, and a small attractive force of the van der Waals' type—and by the repulsive force of the interpenetrating electron clouds of adjacent ions. A measure of the first factor is the so-called “ionization potential” of the atom, the energy required to remove one or more electrons from the atom. These ionization potentials may be determined very accurately from spectroscopic data and have been so determined by a number of investigators. A partial list from a recent collection² is given in Table 46. The values in column one, expressed in volt electrons, are the energies required to remove the first electron; as would be expected, more energy is required to remove two or more electrons, and these energies are given in the other columns. For the complete table the original paper should be consulted.

The data lend support to many ideas which the elementary student gains from the periodic table. Cesium gives up one electron more easily than any other element; it is the most positive of the elements and has the greatest tendency to form an ionic bond. The elements of the *B* subgroup (copper, silver, and gold) do not lose an electron so easily as do the alkali metals; they

¹ SHERMAN, JACK, *Chem. Rev.*, **11**, 93 (1932). An excellent summary of the nature of the ionic bond. See also BORN, M., and M. G. MAYER: “Handbuch der Physik,” vol. XXIV, No. 2, p. 623, Julius Springer, Berlin, 1933.

² SHERMAN, *ibid.*

are less positive. But they can lose a second electron more easily than can the alkali atoms—hence the prevalence of divalent copper ion, but never divalent sodium or potassium ions. The percentage difference in ionization potentials between the *A* and *B* subgroups is less in Group II than in Group I and, as is to be expected, has almost vanished in Group IV. It is quite evident

TABLE 46.—IONIZATION POTENTIALS OF SOME COMMON ATOMS

Atom	At. No.	No. of electrons removed					
		1	2	3	4	5	6
Li	3	5.368	75.282	121.86			
Be	4	9.281	18.14	153.10	216.8		
B	5	8.33	23.98	37.75	258.1		
C	6	11.217	24.28	47.7	64.2	389.9	487.
N	7	14.48	29.47	47.17	(73.5)	97.42	(546)
O	8	13.55	34.93	54.88	77.0	109.2	137.48
F	9	18.6	34.6				

Atom	Electrons removed		Atom	Electrons removed	Atom	Electrons removed	
	1	2				3	4
Li	5.368		Be	18.14	C		64.19
Na	5.116	47.0	Mg	14.97	Si	33.30	44.95
K	4.321	31.7	Ca	11.82	Ge	31.97	45.50
Rb	4.159	(16)	Sr	10.98	Zn	30.49	40.57
Cs	3.877		Ba	9.95	Pb	31.91	43.95
Cu	7.69	20.2	Zn	17.89	Ti	27.6	44.66
Ag	7.53	17.0	Cd	16.84	Zr	24.0	33.83
Au	9.19		Hg	18.67			

that the quadrivalent ions of Group IV are difficult to form, but that the trivalent ions of the *A* subgroup, titanium and zirconium, are apparently formed much more readily. This is consistent with the chemical behavior of these elements. *Evidently the third and fourth group elements do not have a strong tendency to form the ionic bond.*

Ionization potentials have been calculated theoretically upon the basis of the quantum mechanics¹ and are found to agree with these experimental values.

Sherman has also calculated the electron affinities of the common negative ion forming elements, and his average values are given in Table 47.

TABLE 47.—ELECTRON AFFINITIES OF THE ATOMS WHICH FORM NEGATIVE IONS

Energy to attach 1 electron			Energy to attach 2 electrons		
F	98.5	92.2*	O	-168	
Cl	92.5	83.0*	S	-79.4	
Br	87.1	77.2*	Se	-97	
I	79.2	69.9*			

* More recent values, calculated by Mayer's method by E. J. Verwey and J. H. de Boer, *Rec. trav. chim.*, **55**, 443 (1936).

The negative values for O, S, Se signify that the process is endothermic. The first electron attaches itself to the neutral atom with comparative ease, but to attach the second one, considerable work must be done to overcome the repulsion of this electron by the negative ion. These values are calculated by the use of the Born-Haber cycle.²

The Covalent Bond.—The normal covalent or electron-pair bond is not common among the solid, inorganic binary compounds with which our discussion deals particularly, and it is therefore easy to acquire an exaggerated idea of the importance of the ionic bond at the expense of the covalent bond. The stronghold of the covalent bond is among the compounds of electronegative elements, and it is the intramolecular force in most organic molecules. But in many of the inorganic binary compounds, the covalent bond contributes part of the bonding energy.

The existence of the electron-pair bond proposed earlier by Lewis³ was rationalized when it was treated formally from a quantum mechanical viewpoint, first by Heitler and London,⁴ who

¹ HYLLEAAS, E. A., *Naturwissenschaften*, **17**, 982 (1929).

² See Chap. VI.

³ LEWIS, G. N., *J. Am. Chem. Soc.*, **38**, 7 (1916).

⁴ HEITLER, W., and F. LONDON, *Z. Physik*, **44**, 455 (1927).

showed that the bond is stable because of the resonance energy of the two electrons jumping between the two nuclei.

Their analysis of the binding energy for the H_2 molecule revealed that, if there were no interchange of electrons between the two atoms, the total binding energy, equal to the interaction energy of each electron about its nucleus, would be only about 8 per cent of the total experimental binding energy. Thus the resonance energy does indeed account for the major part of the bond strength. But, as pointed out recently by Dushman and Seitz, in a very clear and interesting discussion of the quantum theory of valence, even the inclusion of this resonance energy in Heitler and London's treatment leads to a total binding energy of only 3.2 volt electrons as compared with an experimental value of 4.72 volt electrons.¹ The nature of the covalent bond, as revealed by wave mechanics has been developed by Pauling,² Slater,³ Huggins,⁴ and others from which the following properties of the bond may be inferred.⁵

1. The electron-pair bond is formed through the interaction of an unpaired electron on each of two atoms.

2. The spins of the electrons are opposed when the bond is formed, so that they cannot contribute to the paramagnetic susceptibility of the substance.

3. Two electrons which form a shared pair cannot take part in forming additional pairs.

In addition, three rules, justified by a qualitative consideration of the factors influencing bond energies, have been proposed:

4. The main resonance terms for a single electron-pair bond are those involving the two orbitals, one from each atom, associated with the bond.

5. Of two orbitals with the same dependence upon r ,⁶ the one with the larger value in the bond direction will give rise to the

¹ DUSHMAN, S., and F. SEITZ, *J. Phys. Chem.*, **41**, 239 (1937).

² PAULING, LINUS, *J. Am. Chem. Soc.*, **53**, 1367, 3225 (1931); **54**, 988, 3570 (1932).

³ SLATER, J. C., *Phys. Rev.*, **37**, 481 (1931); **38**, 325 (1931); and others.

⁴ PAULING, LINUS, and M. L. HUGGINS, *Z. Krist.*, **87**, 205 (1934).

⁵ PAULING, LINUS, *J. Am. Chem. Soc.*, **64**, 1367 (1931); *Proc. Natl. Acad. Sci.*, **14**, 359 (1928).

⁶ r , θ , and φ are polar coordinates of the electron, the nucleus being at the center.

stronger bond, and for a given orbital, the bond will tend to be formed in the direction with the largest value of the orbital.

6. Of two orbitals with the same dependence upon θ and φ , the one with the smaller mean value of r , *i.e.*, the one corresponding to the lower energy level for the atom, will give rise to the stronger bond.

The strengths and directional properties of the covalent bond are of particular significance and these have recently been summarized by Pauling and Huggins.¹

s Orbitals have spherical symmetry and thus form weak bonds (except in the *K* shell) without directional properties.

p Orbitals are somewhat stronger and tend to form angles of 90 deg. with each other.

A hybrid orbital formed by a merging of the *s* and *p* orbitals is most likely to form a strong covalent bond. In any of the elements of the first horizontal row of the periodic table, there are four possible combinations of the *2s* and *2p* orbitals of the *L* shell, and these give rise to four directed orbitals, and the four tetrahedral bonds of carbon, and many of the other elements. Electron-pair bonds in crystals of the diamond and ZnS structure were postulated as early as 1922.²

The *s* and *p* orbitals usually are responsible for bond formation even when *d* electrons are available in the *M* shell and outer shells, for the *d* electrons generally have higher energy values. In special cases where the *d* level of a shell lies close to the *s* and *p* levels of the next outer shell, particularly in heavy atoms, the *d* level takes part in bond formation. When one *d* orbital is available for bond formation, as in bivalent nickel, palladium, or platinum, four strong bonds are formed directed toward the corners of a square.

Where *2d* orbitals can participate with *s* and *p* orbitals in bond formation, six equivalent bonds are formed directed toward the corners of a regular octahedron.

More *d* bonds give rise to six equivalent bonds directed to the corners of a trigonal prism.³

¹ PAULING, LINUS, and M. L. HUGGINS, *Z. Krist.*, **87**, 208 (1934).

² HUGGINS, M. L., *J. Am. Chem. Soc.*, **44**, 1841 (1922); *Phys. Rev.*, **28**, 1086 (1926).

³ HULTGREN, RALPH, *Phys. Rev.*, **40**, 891 (1932).

The comparative strengths of these various bonds, given qualitatively in terms of the magnitude of the orbital in the direction of greatest magnitude, are shown in Table 48.

TABLE 48.—STRENGTH AND DIRECTION OF COVALENT BONDS

Orbital	Strength	Direction
<i>s</i>	1.0	Undirected
<i>p</i>	1.732	90 deg. to each other
<i>d</i>	2.237	
<i>sp</i> ³	2.000	Tetrahedral angles to each other
<i>dsp</i> ²	2.694	Planar toward corners of square
<i>d²sp</i> ³	2.923	Toward corners of octahedron
<i>dⁿsp</i> ³	2.985	Toward corners of trigonal prism

These are the characteristics of the normal covalent bond, the actual existence of which is rare. It is most nearly approached in the bonding of two electronegative atoms as close together as possible and farthest to the right in the periodic table.

Polarization.—Until quite recently, most of the abnormal characteristics of ionic crystals were “explained” by assuming distortion or polarization of the ions.

The importance of this concept is now questioned because of the following: (1) the wave mechanical development of the covalent bond, and (2) the demonstration that even in ionic crystals, abnormal properties may be related entirely to a radius ratio effect and do not necessarily result from a polarization of the ions.¹ This does not imply that polarization does not occur, but it does relegate it to what is thought to be a position of minor importance as a factor in crystal structure.

There are a number of means for measuring the polarization of ions or atoms, free in the gaseous form or grouped in crystals. It was shown some time ago² that according to the electromagnetic theory of light atoms and ions will be polarized by the electric field of light waves passing by them and will refract this light. The Lorentz-Lorenz equation shows the relation between the polarizability of ions or atoms and their molecular refractivity. Polarizabilities of ions have been measured by this method by

¹ PAULING, LINUS, *J. Am. Chem. Soc.*, **50**, 1036 (1928).

² LORENTZ, H. A., *Ann. Physik*, **9**, 641 (1880).

many investigators.¹ It should be pointed out that the molecular refractivities do not define the nature of the bond between atoms or ions; they do not, for example, indicate the existence of polarized *ions*. They merely reveal how tightly the outer electrons are held to the nucleus.

Polarizabilities of noble gas ions have been calculated from series spectra;² and the polarizing powers of cations with the rare gas configuration have been estimated.³ Numerical results obtained by these several methods confirm the statements made in the Introduction. That is:

1. The polarizing power of cations increases with valence and decreases as the size increases, the charge remaining constant.
2. The polarizability of anions increases with size and decreases as the valence increases.

There is also some indication that polarization may be estimated from a measurement of the position and breadth of the ultraviolet absorption band⁴ and from the wave length of the *K*-absorption edge of the atom.⁵ On the other hand, it is maintained that the shift in the *K*-absorption edge may be due to the electrostatic action of neighboring ions in a crystal and not necessarily to polarization.⁶

The Transition from the Ionic Bond to the Covalent Bond.—

It is probable that the normal ionic bond and the normal covalent bond rarely, if ever, occur. However, a great deal of discussion has centered around the possibility of a continuous transition

¹ WASASTJERNA, J. A., *Z. physik. Chem.*, **101**, 193 (1922); FAJANS, KASIMIR, and G. JOOS, *Z. Physik*, **23**, 1 (1924); FAJANS, KASIMIR, "Radioelements and Isotopes. Chemical Forces," p. 72, Cornell University Press, Ithaca, N. Y., 1931. *Z. physik. Chem.*, **130**, 729 (1927); VAN ARKEL, A. E., and V. H. DE BOER, "Chemische Bindung," p. 87, S. Hirzel, Leipzig, 1931.

² BORN, M., and W. HEISENBERG, *Z. Physik*, **25**, 388 (1924); PAULING, LINUS, *Proc. Roy. Soc. (London)*, **A 114**, 181 (1927); MAYER J. E., and M. G. MAYER, *Phys. Rev.*, **43**, 610 (1933).

³ GOLDSCHMIDT, V. M., *Skrifter Norske Videnskaps-Akad. Oslo*, No. 2, p. 60, 1926.

⁴ POHL, R. W., and R. HILSCH, *Z. Physik*, **64**, 606 (1930).

⁵ RICHTMYER, F. K., *J. Franklin Inst.*, **208**, 325 (1929); a good description of the phenomenon; STELLING, OTTO, *Z. Physik*, **50**, 506 (1928); *Z. Elektrochem.*, **34**, 520 (1928).

⁶ AOYAMA, S., K. KIMURA, and Y. NISHINA, *Z. Physik*, **44**, 810 (1927); PAULING, LINUS, *Phys. Rev.*, **34**, 954 (1929).

from one bond type to the other, involving the existence of a continuous series of bonds of intermediate type. While recent wave mechanical studies offer the latest interpretation of this question, certain of the earlier discussions may be followed with considerable interest.

Arguments in support of a continuous transition have been set forth by Fajans;¹ while Sidgwick's² approach is typical of those who believe that the change is discontinuous. It is interesting to read the detailed discussion, part of which is summarized briefly here. Both men choose much of the same data to support the opposite sides of the question:

1. The change in properties of a series of uni- to tetravalent halides.
2. The properties of the hydrogen halides.
3. The properties of the silver halides.

In Table 49, are listed properties which give a measure of the stability of a series of halides. It may be observed that the halides of a given element are either relatively high boiling, the boiling points falling slowly as the atomic weight of the

TABLE 49.—BOILING POINTS OF HALIDES OF SODIUM, SILICON, ALUMINUM, AND TIN AT 760 MM. * IN °C.

NaF 1695	NaCl 1441	NaBr 1393	NaI 1300
SiF ₄ -90	SiCl ₄ 57	SiBr ₄ 153	SiI ₄ 290 approx.
AlF ₃ 800	AlCl ₃ 183	AlBr ₃ 260	AlI ₃ 350

* From SIDGWICK, N. V., "The Covalent Link in Chemistry," p. 52, Cornell University Press, Ithaca, N. Y., 1932.

halogen increases, or they are low boiling, the boiling points rising more rapidly as the atomic weight of the halogen increases.

¹ FAJANS, KASIMIR, "Radioactive Elements and Isotopes," Cornell University Press, Ithaca, N. Y., 1931; *Naturwissenschaften*, **11**, 165 (1923); *Z. Elektrochem.*, **34**, 541 (1928); "Handbuch der Physik," vol. XXIV, no. 2, p. 541, Julius Springer, Berlin, 1933.

² SIDGWICK, N. V., "The Covalent Link in Chemistry," Cornell University Press, Ithaca, N. Y., 1932.

The decreases in boiling point with increasing atomic weight (and atomic size) is to be expected in ionic compounds, since the distance between the ions increases. In a series of organic compounds, on the other hand, the boiling point increases with the molecular weight. This type of variation has become associated with the existence of the covalent bond. The sodium halides are typical ionic salts; while the silicon halides are taken as characteristic covalent compounds. Regarding the aluminum halides there arises a difference of opinion. They are said by one to demonstrate a discontinuous change from ionic to covalent binding; and are cited by the other as indicative of a continuous transition. It has been shown, however, that those properties related to the stability of a crystal are determined primarily by the environment of the building stones in the crystal, not by the existence of ionic or covalent forces between them.¹ Insofar as this is true, the data of Table 49 have no direct bearing upon the problem.

Pauling has calculated that the bonds in SiF_4 are neither ionic nor covalent but lie somewhere between the two extremes.²

The properties of the hydrogen halides have also been called to witness for both the continuous and discontinuous transitions. HCl is difficult to solidify and forms a molecular lattice. These properties may probably be attributed to the covalent bond indirectly, although the low freezing point follows directly from the weak molecular lattice. In water, HCl is a strong electrolyte. If HCl were ionic, the distance 1.26 Å between its nuclei would be identical with the dipole distance, determined from the dipole moment; but if HCl is covalent, the dipole distance should be zero. So reasons Fajans, and concludes that, because the actual dipole distance is 0.216 Å, the bond must be of an intermediate type—a polarized ionic bond.³ Sidgwick, however, calls HCl covalent and then concludes that the covalent link has a dipole moment and that the electron pair is rarely shared equally by the two atoms.

¹ VAN ARKEL, A. E., and V. H. DE BOER, "Chemische Bindung," S. Hirzel, Leipzig, 1931; PAULING, LINUS, *J. Am. Chem. Soc.*, **54**, 988 (1932).

² PAULING, LINUS, *J. Am. Chem. Soc.*, **54**, 988 (1932).

³ FAJANS, KASIMIR, "Radioelements and Isotopes," p. 85, Cornell University Press, Ithaca, N. Y., 1931.

Potential-energy curves of the hydrogen halides suggest¹ that HF is of an intermediate bond type, predominantly ionic, as evidenced also by the tendency of fluorine to form hydrogen bonds; while in HCl, HBr, and HI the bonds are essentially but not entirely covalent.

Certain properties of the series AgF, AgCl, AgBr, and AgI have been taken to suggest the continuity of the bond transition, or its discontinuity, as one chooses. The first three crystallize in the NaCl structure, the last in the ZnS and ZnO structures. This series is cited as evidence of the discontinuity of the transition from ionic to covalent bond when it is *assumed* that a change in structure from the NaCl to the ZnS (ZnO) lattice is proof of a change in bond type. This assumption is not justified, as is demonstrated later. On the contrary, this series of salts proves to be one of the most convincing exhibits for the continuous transition in bond type. AgI cannot be called a covalent compound, although it may be considered to be intermediate in regard to bond type and more nearly covalent than ionic.

Recent wave mechanical calculations suggest that² the transition from the ionic to the covalent bond may in certain cases be continuous while in other cases it must be discontinuous. At present it seems most satisfactory to adopt this viewpoint. In the AX compounds, for example, in the sphalerite and wurzite structures, it is possible to have *any intermediate* stage between the ionic or the covalent extremes.

Theoretical treatments of this question make it increasingly evident that it is usually misleading to visualize a normal ionic or a normal covalent bond. It has recently been proposed that even in the typical ionic crystal of the sodium chloride type an appreciable part of the binding energy results from electronic distributions like those which give rise to covalent bonds. On the other hand, the discrepancy between the experimental bond energy (4.72 volt electrons) for H₂ and the theoretical energy (3.2 volt electrons) calculated by the method of Heitler and London has been attributed to the neglect of an electron-repulsion term which is, in a sense, an ionic term.³ In short, it may be

¹ PAULING, LINUS, *J. Am. Chem. Soc.*, **54**, 988 (1932).

² PAULING, LINUS, *J. Am. Chem. Soc.*, **54**, 988 (1932); PAULING, LINUS, and M. L. HUGGINS, *Z. Krist.*, **87**, 205 (1934).

³ DUSHMAN, S., and F. SEITZ, *J. Phys. Chem.*, **41**, 241 (1937).

that the bond in ionic NaCl has a small covalent component and that the binding energy in even the H_2 molecule is slightly ionic.

Inasmuch as we shall have more to say about valence bonds as they are interpreted by the quantum mechanics, it is perhaps well to quote at some length a recent opinion of Van Vleck and Sherman concerning the present status of this method of treatment.¹

The subject of valence is really concerned with energy relations. If we knew the energies of all the possible different kinds of electron orbits in molecules, and also in the atoms out of which the molecule is formed, the rules of valence would automatically follow.

Now the principles of quantum mechanics enable one to write down an equation for any system of nuclei and electrons, the solution of which would provide us with complete information concerning the stability of the system, spatial arrangements of the nuclei, etc. . . .

The complexities of the n -body problem are, alas, so great that only for the very simplest molecule, namely H_2 , has it proved possible to integrate the Schrödinger wave equation with any real quantitative accuracy. Hence to date, anyone is doomed to disappointment who is looking in Diogenes-like fashion for honest, straightforward calculations of heats of dissociation from the basic postulates of quantum mechanics. How, then, can it be said that we have a quantum theory of valence? The answer is that to be satisfied one must adopt the mental attitude and procedure of an optimist rather than a pessimist. The latter demands a rigorous postulational theory, and calculations devoid of any questionable approximations or of empirical appeals to known facts. The optimist, on the other hand, is satisfied with approximate solutions of the wave equation. If they favor, say, tetrahedral and plane hexagonal models of methane and benzene, respectively, or a certain order of sequence among activation energies, or a paramagnetic oxygen molecule, he is content that these same properties will be possessed by more accurate solutions. He appears freely to experiment to determine constants, the direct calculation of which would be too difficult. The pessimist, on the other hand, is eternally worried because the omitted terms in the approximations are usually rather large, so that any pretense of rigor should be lacking. The optimist replies that the approximate calculations do nevertheless give one an excellent "steer" and a very good idea of "how things go," permitting the systematization and understanding of what would otherwise be a maze of experimental data codified by purely empirical valence rules. In particular, he finds that a mechanism is really provided by quantum mechanics for the Lewis

¹ VAN VLECK, J. H., and A. SHERMAN, *Rev. Modern Phys.*, **7**, 167 (1935).

electron pair bond, and for the stereochemistry of complicated organic compounds. It is, of course, futile to argue whether the optimist or pessimist is right. . . . One thing is clear. In the absence of rigorous computations, it is obviously advantageous to use as many methods of approximation as possible. If they agree in predicting some property (for instance, the tetrahedral structure of methane) we can feel some confidence that the same property would be exhibited by a more rigorous solution—otherwise none . . .

For practical purposes, most compounds may be classed as essentially ionic or covalent after a consideration of certain characteristic properties. This leads to the problem of the determination of the predominant bond type in any given crystal.

The Identification of the Ionic Bond and the Covalent Bond.—

A number of methods commonly used as criteria of bond type have already been mentioned. These, and others, may be summarized as follows:

Direct Methods:

1. Prediction from quantum mechanics.
 - a. Directional bonds.
 - b. Paramagnetic susceptibilities.
2. Photodissociation of molecules.

Indirect Methods:

3. Estimation from position in periodic table; ionization potentials; electron affinities.
4. Agreement or nonagreement with the rules governing the structure of ionic compounds.
5. Comparison of lattice energies.
6. Additivity of covalent bond energies.
7. Comparison of interatomic (ionic) distances.
8. Crystal structure.
9. Comparison of properties with properties of crystals of known bond type.

1. Because covalent bonds may possess unique directional properties, it is evident that crystal-structure determinations which establish the direction of chemical bonds will throw considerable light on the nature of these bonds. While it is true that the tetrahedral and octahedral bonds may be either ionic or covalent,¹ the square dsp^2 and trigonal prism bonds are not stable

¹ Note that the tetrahedral or diamond structure is not conclusive evidence of covalent bonds, although it is frequently assumed to be so.

configurations for ions and their existence is therefore pretty good evidence of the covalent bond. The Pd-Cl and Pt-Cl bonds in K_2PdCl_4 and K_2PtCl_4 , respectively, may be considered covalent because structure analysis shows the four chlorine atoms to be at the corners of a square in each case.

Pauling has shown that when the ionic and covalent structures of a compound have different multiplicities,¹ the type of bond may be determined from the paramagnetic susceptibilities. The expected magnetic moments for the ionic and covalent bonds are 5.91 and 1.73 Bohr magnetons, respectively. When the experimental values calculated from the measured paramagnetic susceptibilities are: $(NH_4)_3FeF_6 = 5.88$, $FeCl_3 = 5.84$, $FeSO_4 \cdot 7H_2O = 4.99$, $FeI_3 = 5.4$, $K_3Fe(CN)_6 = 2.0$, it is suggested that the bonds are essentially ionic in the first four compounds and covalent in the last. Note that, from general knowledge of the influence of polarization upon bond type, one would predict an ionic bond in $(NH_4)_3FeF_6$ and a covalent bond in $K_3Fe(CN)_6$, since the fluoride ion is not easily polarized and the cyanide ion is subject to strong polarization.

2. The molecules for which photodissociation has been studied may be divided into two distinct groups: When a molecule dissociates into two neutral atoms, one excited, the covalent bond is indicated. Among these may be listed Cl_2 , Br_2 , I_2 , H_2 , S_2 . When two neutral atoms, both excited, are formed, the ionic bond is indicated, as in $NaCl$, NaI , KBr , $RbBr$, and others.²

When the multiplicity of a complex is the same for both ionic bonds and covalent bonds, then indirect evidence must be relied upon to suggest which of the two types is more nearly approached. The remaining criteria listed are of this indirect type.

3. When two elements are combined to form a compound, one may sense from their relative positions in the periodic table whether the bond holding them together is apt to be ionic, covalent, or an average of the two. Elements lying near together in the table, in or to the right of the fourth group, usually form a bond predominantly covalent, and the nearer the right of the table, the more will the covalent bond predominate. The resonance energy of the covalent bond is also suggestive. It is highest for the elements in the right of the first short period and

¹ Different numbers of unpaired electrons.

² SPONER, H., *Z. Elektrochem.*, **34**, 483 (1928).

decreases from the top middle to the lower middle. When it is recalled that the metallic bond is, in a special sense, a covalent bond, it is interesting to observe that between two or more atoms of elements lying near together in the groups to the left of the fourth group the metallic bond generally predominates.

The ionic bond is apt to occur when one of the combining elements is decidedly electropositive with respect to the other, *i.e.*, when the ionization potential of the electropositive element is low and the electron affinity of the electronegative element is high. The ionic bond is probably most normal in the alkali halides. The alkaline earths, aluminum and other third group eight-shell ions, also copper, silver, gold, zinc, cadmium, tin, and lead form bonds with a large ionic component; the first-named are predominantly ionic; the last may be largely covalent, although here the nature of the electronegative element involved exerts a strong influence.

4. When the arrangement in a crystal is tetrahedral, if the bonds are covalent, angles of 90 or 109.5 deg. are to be expected; while ionic bonds would permit larger angles. Hence the angle of 180 deg. in β tridymite indicates bonds largely ionic.¹ When the shared octahedral edges are shortened as in hematite and corundum, an ionic bond is suggested; while the longer, shared octahedral edges in marcasite indicate a covalent bond. In MoS_2 , the sulfur atoms are at the corners of a trigonal prism around the molybdenum, not at the corners of an octahedron, and covalent bonds are therefore indicated.

5. A comparison of experimental lattice energies with those calculated, assuming ionic bonds, often suggests the prevalence of an intermediate or a covalent bond. Fair agreement between U_{exp} and U_{theor} suggests bonds essentially ionic. Increasing positive values for $U_{\text{exp}} - U_{\text{theor}}$, however, indicate the influence of electron-pair bonds.² Of more than passing interest is the observation that when the Born-Mayer³ equation for lattice energies is used, in which a term for van der Waals' attraction is included, the values for U_{theor} for the silver halides are higher and ΔU is very much less. There is the implication that the

¹ PAULING, LINUS, and M. L. HUGGINS, *Z. Krist.*, **87**, 216 (1934).

² See Table 68, Chap. VI. and J. Sherman, *Chem. Rev.*, **11**, 93 (1932).

³ MAYER, J. E., *J. Chem. Physics*, **1**, 327 (1933).

influence of the electron-pair bond in these crystals is not so great as is implied by Sherman's data.

6. Certain empirical data indicate that covalent bond energies are additive. For compounds, then, in which the actual bond energy is greater than that predicted by the addition of the covalent bond energies of the atoms involved, the difference may be taken as a fair measure of the ionic component of the bond. Series of familiar compounds are given in Table 50.¹

Thus, the H-F bond has a large ionic component, and HI approaches the normal covalent bond. The unique nature of fluorine, as compared with the other halogens and as evidenced by many of its properties, is revealed by these data. It is doubtless much more electronegative than the other three halogens and stands quite apart from them in this respect.

TABLE 50.—COVALENT BOND ENERGIES IN VOLT ELECTRONS

Bond energy.....	H:H	F:F	Cl:Cl	Br:Br	I:I	K:K	
	4.44	2.80	2.468	1.962	1.535	0.51 ± 0.02	
	HF	HCl	HBr	HI	ClF	BrCl	
Actual.....	6.39	4.38	3.74	3.07	3.82	2.231	
Predicted from additivity.....	3.62	3.45	3.20	2.99	2.63	2.215	
	2.77	0.93	0.54	0.08	1.19	0.016	
			I:Br	I:Cl	K:Cl	K:Br	K:I
Actual.....			1.801	2.143	4.5	3.9	3.25
Predicted from additivity.....			1.748	2.001	1.53	1.24	1.03
			0.053	0.142	3.0	2.7	2.22

7. When the experimental interionic distances are less than those calculated from the ionic radii, it may be attributed to the influence of the covalent bond; but frequently a sudden decrease in interionic distance has been attributed, erroneously, to the sudden complete displacement of the ionic bond by a

¹ PAULING, LINUS, and D. M. YOST, *Proc. Natl. Acad. Sci.*, **18**, 414 (1932); PAULING, LINUS, *J. Am. Chem. Soc.*, **54**, 3573 (1932).

covalent bond. An examination of the data for the silver halides shown in Table 51, will reveal the fallacy of this interpretation.

TABLE 51.—INTERATOMIC DISTANCES IN THE SILVER HALIDES

	AgF	AgCl	AgBr	AgI
Sum of ionic radii (C.N. = 6), A.....	2.46	2.94	3.09	3.33*
Experimental distances.....	2.46	2.77	2.87	3.05
Difference.....	0.17	0.22	0.28*
Percentage decrease.....	5.8	7.1	8.4
Sum of ionic radii (corrected to C.N. = 4).....	3.14
Experimental distance.....	2.811
Difference.....	0.33
Percentage decrease.....	10.5

* For Ag-I in AgI of NaCl structure, calculated from mixed crystals of AgI-AgBr.

As evidence of a predominant covalent bond in silver iodide, it has been pointed out¹ that there is a contraction of 9 per cent in the interatomic distance in AgI (2.81 A) as compared with the interionic distance in an "ionic" (NaCl) AgI structure (3.05 A). But in citing this evidence the effect of a change in coordination number, entirely independent of the influence of the type of bond, has been overlooked.

If we assume, then, that merely the decrease in C.N. from 6 to 4 will cause a contraction of about 5.5 per cent in interatomic distance (see Chap. II), the theoretical Ag-I distance (C.N. = 4) will be $3.33 \times 0.945 = 3.14$ A, as compared with the experimental distance 2.81 A. The percentage contraction of the observed distance is therefore 10.5 per cent, which is not out of line with 8.4 per cent contraction for AgI and 7.0 per cent for AgBr in the "ionic" (NaCl) structure.

Thus, there is no proof of discontinuity in interionic distances in the silver halides to suggest that a covalent bond comes into existence suddenly in AgI. But the interionic distances do suggest a trend from the ionic toward the covalent bond in the direction $\text{AgF} \rightarrow \text{AgI}$.

There is another group of compounds in which interatomic distances seem to be an indication of the presence of the covalent bond. It has been found that, in a series of compounds with the

¹ SIDGWICK, N. V., "The Covalent Link in Chemistry," p. 52, Cornell University Press, Ithaca, N. Y., 1932.

wurtzite or zinc-blende structure in which the element *A* stands as many places before the fourth group as the element *X* stands after the fourth group, the interatomic distances are essentially constant. Several such series are shown in Table 52A. Now, it is well known that in ionic crystals of the same sort (see Table 52B) the interionic distance decreases as the valence of the ions increases. The fact that there is no such decrease in the wurtzite or zinc-blende structures with increasing valence suggests very strongly that these crystals are not built of ions but of neutral atoms. In short, the interatomic distance seems to depend upon the total number of electrons, not on their distribution between the atoms.¹

8. It must now be apparent that the type of bond in a given compound cannot be predicted with certainty from its crystal structure. It is equally true, however, that the crystal structure may be very suggestive of the bond type. Thus, the NaCl structure does not permit the formation of a covalent bond, since there are too many neighbors around a sodium atom to permit each one to be held by a pair of electrons. It may be possible, however, for electron pairs to jump from one atom to another, forming more bonds than there are electron pairs. Probably ScN, ScC, and the like are covalent in spite of their NaCl structure. This is suggested on three counts:

- a. Their interatomic distances are constant, in spite of the changes in valence (see criterion 7).
- b. Their valences and ionization potentials are high (see criterion 3).
- c. Their properties are similar to diamond, a typical covalent crystal.

On the other hand, the zinc-blende or wurtzite structure does not guarantee the existence of a covalent bond. It has been shown that in AgI the bond is, at best, of an intermediate nature and retains some ionic characteristics. BeO is essentially ionic,² as is NH₄F; and the sulfide, telluride, and selenide of beryllium may also be largely ionic.³

¹ On the contrary, see data on hardness and comment thereon (Chap. VI).

² ZACHARIASEN, W. H., *Z. Physik*, **40**, 637 (1926); FAJANS, KASIMIR, *Z. Elektrochem.*, **34**, 511 (1928).

³ PAULING, LINUS, *J. Am. Chem. Soc.*, **49**, 788 (1927).

TABLE 52.—A-X DISTANCES IN COVALENT AND IONIC CRYSTALS*

A		B	
Zinc-blende-wurtzite structures		NaCl structure (ionic lattice)	
AgI	2.811	NaF	2.310
CdTe	2.799	MgO	2.104
InSb	2.793	KF	2.669
SnSn	2.79	CaO	2.401
CuBr	2.460	RbF	2.815
ZnSe	2.452	SrO	2.573
GaAs	2.435	NaCl	2.614
GeGe	2.43	MgS	2.595
CuI	2.618	KCl	3.139
ZnTe	2.637	CaS	2.843
GaSb	2.638	RbCl	3.286
$\frac{\text{Ge} + \text{Sn}}{2}$	2.62	SrS	3.004
SeCd	2.62	NaBr	2.981
CuCl	2.341	MgSe	2.726
ZnS	2.346	KBr	3.293
GaP	2.354	CaSe	2.956
$\frac{\text{Ge} + \text{Si}}{2}$	2.39	RbBr	3.434
AsAl	2.437	SrSe	3.113
MgTe	2.76	KI	3.525
AlSb	2.638	CaTe	3.172
$\frac{\text{Si} + \text{Sn}}{2}$	2.57	RbI	3.663
SCd	2.521	SrTe	3.324
AlP	2.360		
SiSi	2.347		
AlN	1.87		
SiC	1.89		
BeO	1.645		
CC	1.541		

* GOLDSCHMIDT, V. M., *Trans. Faraday Soc.*, 25, 277 (1929).

9. It cannot be too often repeated that the stability of a crystal as indicated by melting point, solubility, and so on is no indication of the type of bond present. Ionic and covalent bonds may be of the same relative strengths. A similarity of physical properties, however, often suggests a similarity of bond. Thus, PbS, PbSe, and PbTe, although they are said to have the NaCl structure, are obviously more like FeS and FeS₂ than like CaS, and they are not ionic compounds.

The AX Compounds.—The common structures of the AX compounds are shown in Fig. 3, Chap. I. Of these, the NaCl structure occurs most frequently; perhaps because it tolerates a wider variation in the nature of its building stones than do the other types. To establish the conditions which favor this structure, we shall study the transition from this type to other typical AX lattices.

In the introductory chapter, it was decided that the NaCl structure is a typical ionic structure associated with the ionic bond, that its ions are relatively free from polarization effects and that it is favored when the $R_A:R_X$ ratio is above 0.41. It will become evident, presently, that this structure is not unequivocally dependent upon either a definite $R_A:R_X$ ratio nor upon the existence of an ionic bond. To be sure, the NaCl structure prevails among compounds of positive and negative ions having the rare gas configuration, those which one should expect to form the least distorted, typical ionic bonds; but it does not follow that all NaCl structures are ionic. We need only examine the data in Table 53 to see that the occurrence of the NaCl structure does not depend entirely upon the $R_A:R_X$ ratio. Obviously, if one proceeds on the assumptions (1) that the NaCl structure is favored when the $R_A:R_X$ ratio lies between 0.41 and 0.73, (2) that above 0.73 the CsCl structure is favored, and, (3) that below 0.41 the ZnS (ZnO) structure usually occurs, there are many exceptions to be found in this table. Evidently this rule does not hold for the most common of the ionic compounds. Our discussion of the data of Table 53 leads, therefore, to a rather detailed study of the transitions: NaCl structure to CsCl structure; NaCl structure to ZnS (ZnO) structure.

The Transition, NaCl Structure → CsCl Structure.—The occurrence of the CsCl structure seems, at first sight, to bear little

TABLE 53.—THE STRUCTURES AND $R_A:R_X$ RATIOS OF SOME AX COMPOUNDS

Anion radius, A		Cation radius, A						
		Li 0.68	Na 0.98	K 1.33	Rb 1.48	NH ₄ 1.50	Cs 1.67	Tl ⁺ 1.50
F	1.33	NaCl 0.51	NaCl 0.73	NaCl 1.00	NaCl 1.11	ZnO 1.13	NaCl* 1.25	
Cl	1.81	NaCl 0.37	NaCl 0.54	NaCl 0.74	NaCl† 0.82	CsCl‡ 0.83	CsCl 0.92	CsCl 0.83
Br	1.96	NaCl 0.35	NaCl 0.50	NaCl 0.68	NaCl† 0.75	CsCl‡ 0.76	CsCl 0.85	CsCl 0.76
I	2.19	NaCl 0.31	NaCl 0.45	NaCl 0.61	NaCl† 0.68	CsCl‡ 0.69	CsCl 0.77	CsCl 0.69

Anion radius, A		Cation radius, A			
		Mg 0.78	Ca 0.98	Sr 1.15	Ba 1.31
O	1.33	NaCl 0.58	NaCl 0.74	NaCl 0.86	NaCl 1.00
S	1.74	NaCl 0.41	NaCl 0.56	NaCl 0.66	NaCl 0.75
Se	1.96	NaCl 0.37	NaCl 0.50	NaCl 0.59	NaCl 0.67
Te	2.18	ZnO 0.33	NaCl 0.45	NaCl 0.53	NaCl 0.60

* The symbols (e.g., NaCl) indicate the crystal structure, and the figures are $R_A:R_X$ ratios.

† At high pressure these have the CsCl structure.

‡ At high temperature these have the NaCl structure.

relation to the radius ratio 0.73. Of the compounds listed in Table 53, there are 16 for which the radius ratio is above 0.73, and only 7 crystallize with the CsCl structure. This structure is favored for two compounds in which the ratio is too low. It

appears that the CsCl structure is not a particularly stable arrangement of ions. The coulomb energy of the CsCl arrangement is greater than the energy for either the NaCl or ZnS structure: *i.e.*, the first is a less stable structure.¹

The conditions necessary to establish the CsCl structure have been discussed by Pauling in connection with the polymorphism of the rubidium halides.² He concluded that this structure is stable for alkali halides with high anion deformability and large radius ratio. The rubidium, ammonium, and thallos halides, all with cations of comparable size, offer an opportunity to study the effect of polarization, independent of variations in radius ratio. Pauling's conclusions account satisfactorily for the structure of the rubidium and cesium salts; the radius ratio is the predominant factor here. The rubidium salts are obviously on the border line in regard to radius ratio and polarization properties, and their polymorphism is quite natural. It is also evident that, in spite of their high radius ratios, no fluorides could be expected with the CsCl structure because the fluoride ion cannot be polarized appreciably. Furthermore, of KBr and RbI, both with the same radius ratio, only the latter has the CsCl structure because of the greater polarizability of the iodide ions.

A slightly different emphasis was placed upon the question by Goldschmidt³ who proposed that the CsCl structure is favored when the radius ratio is above 0.73 and the polarizabilities of anion and cation are not very different.

More recently it has been indicated that a sharp change in the van der Waals' energy term in the transition NaCl to CsCl stabilizes the CsCl structure even though the coulomb energy of CsCl is higher.⁴ This treatment does not differ fundamentally from the older conception, for in London's equation for the calculation of the van der Waals' energy in an ionic crystal, there is a term for polarization.⁵ Born and Mayer calculated the crystal energies for the potassium, rubidium, and cesium halides

¹ PAULING, LINUS, *J. Am. Chem. Soc.*, **49**, 765 (1927).

² PAULING, LINUS, *Z. Krist.*, **69**, 35 (1928).

³ GOLDSCHMIDT, V. M., *Skrifter Norske Videnskaps-Akad. Oslo*, no. 8, p. 86 (1927).

⁴ BORN, M., and J. E. MAYER, *Z. Physik*, **75**, 1 (1932).

⁵ LONDON, F., *Z. physik. Chem.*, **B 11**, 222 (1930).

as the sum of the coulomb attraction, the van der Waals' attraction, and a repulsion term. They showed that the transition, NaCl structure to CsCl structure, involves a sharp change in the van der Waals' energy and that, when this value, calculated by London's method, is arbitrarily doubled,¹ the transition NaCl to CsCl involves a negative energy change only for the cesium halides (except fluoride).

In short, the CsCl structure is not particularly stable. It may be formed by univalent ions when the radius ratio is above 0.73 and in such cases probably owes its stability to van der Waals' forces.

The Transition, NaCl Structure → ZnS (ZnO) Structure.—The ZnS structure may occur as the result of:

1. A decrease in $R_A:R_X$ ratio below 0.41.
2. The introduction of a strongly polarizing cation and an easily polarized anion, and
3. The influence of tetrahedral covalent bonds.

Generally, the properties of compounds with the ZnS (ZnO) structure suggest that the bond is of an intermediate nature, partly covalent. The $R_A:R_X$ ratio need not be within the limits prescribed for the ZnS structure, since it is a secondary influence. Occasionally the ZnS structure is found for compounds in which a fairly normal ionic bond is to be expected. In such cases, the stability of the structure conforms closely to the $R_A:R_X$ limits (0.41 to 0.22), and this is the determining factor in its formation. As a general thing, however, the ionic bond does not predominate in the ZnS lattice.

Consider, with the above generalizations in mind, Table 54 and Chart A (the Appendix). It may be said that the beryllium salts and MgTe, in Table 54, are largely ionic in spite of their structure; and that NH_4F crystallizes in the ZnO structure, in spite of the $R_A:R_X$ ratio because of the unsymmetrical ammonium ion. Indeed, it has been shown² that in crystalline NH_4F one of the hydrogen atoms is drawn toward the fluoride ion. It is probable that a hydrogen bond ties the fluoride to the rest of the molecule.³

¹ MAYER, J. E., *J. Chem. Physics*, **1**, 327 (1933), has since recalculated the van der Waals' energy and obtained a value a little more than twice that calculated by Born and Mayer.

² ZACHARIASEN, W. H., *Z. physik. Chem.*, **127**, 218 (1927).

³ SHERMAN, JACK, *Chem. Rev.*, **11**, 93 (1932).

It is evident that the stronghold of the ZnS (ZnO) structure is among the AX compounds of the B cations, Cu^+ , Ag^+ , Zn^{++} , Cd^{++} , Hg^{++} , Ga^{+3} , In^{+3} . That the covalent bond prevails in most of these is indicated by the constancy of the interatomic distances in each series as shown in Table 52. This same criterion may be used to select from Table 52 those compounds which are not strictly covalent. These are AgI , $MgTe$, BeO , and probably $AlAs$ and $AlSb$.

The relation between ionic sizes and the $NaCl$ and ZnS structures may be viewed from another angle. The X atoms or ions of both of these AX structures are on a face-centered cubic lattice. When the metal is relatively large, it occupies the largest interstices in this lattice, those in the centers of octahedra, and has six neighbors; the simple cubic $NaCl$ structure is formed. When the metal ions are much smaller, they occupy the alternate second largest interstices in the face-centered cubic lattice, those in the centers of tetrahedra; and the ZnS lattice is formed.

Instead of correlating changes in structure with $R_A:R_X$ ratios, Niggli¹ uses limiting ratios for interionic distances from a central ion or atom to the first and second "coordination spheres." Thus, an atom A in a $NaCl$ lattice has 6 neighbors X in the first coordination sphere and 12 neighbors A in the second sphere. This lattice is stable when the ratio of the distance $A-X$ to $A-A$ is $1:1.414 = 1:\sqrt{\frac{2}{3}}$. In the ZnS structure each atom A has 4 neighbors in the first sphere and 12 in the second, and the structure is stable when $A-X/A-A = 1:1.636 = 1:\sqrt{\frac{3}{2}}$. For the $CsCl$ structure the ratio is $1:1.153 = 1:\sqrt{\frac{3}{4}}$.

The Transition, NaCl Structure \rightarrow ZnO Structure \rightarrow ZnS Structure.—The ZnS and the ZnO structures are both characterized by the C.N.4; in both, the arrangement is tetrahedral. The X atoms or ions are on a face-centered cubic lattice in ZnS , and on a hexagonal, close-packed lattice in ZnO . All that has been said of polarization and bond type applies to the ZnO structure as well as to the ZnS structure.

From crystal structure data, however, it is quite evident that the ZnO structure represents an intermediate step in the transition, $NaCl$ structure to ZnS structure. The data in Table 54 show this very clearly.

¹ NIGGLI, P., *Ber.*, **63**, 1823 (1930); and numerous papers in *Z. Krist.*

Evidently, as polarization and the influence of the covalent bond increase the trend is $\text{NaCl} \rightarrow \text{ZnO} \rightarrow \text{ZnS}$, but the conditions for the formation of these last two structures are so nearly alike

TABLE 54.—THE TRANSITION, NaCl TO ZnO TO ZnS

Cation \ Anion	O	S	Se	Te
	Cd	NaCl	ZnO ZnS	ZnO ZnS
Zn	ZnO	ZnO ZnS	ZnS	ZnS

Compound	Structure	Compound	Structure
NaF	NaCl	NaI	NaCl
MgO	NaCl	MgTe	ZnO
AlN	ZnO	AlSb	ZnS
SiC	ZnS		

that many compounds are found to crystallize in either form, depending upon the temperature or other conditions.

The Transition, NaCl Structure \rightarrow NiAs Structure.—The NiAs structure, found in Zone VII in Chart A in the Appendix, is peculiar to compounds of the transition-elements (Cr, Mn, Fe, Co, Ni, Pd, Pt) with S, Se, Te, As, Sb, Bi. The properties of crystals of this group are distinctive. As in the wurtzite structure, the anions—"lattice supporters"—are on an hexagonal close-packed lattice. The metal atoms occupy positions at the centers of slightly distorted octahedra, on a simple hexagonal lattice, giving the crystal a C.N. 6. Each anion X is at the center of a trigonal prism and has six nearest neighbors. The arrangement of the metal atoms is suggestive of chains running in the direction of the *c* axis.

The attempt has been made¹ to correlate the transition $\text{NaCl} \rightarrow \text{NiAs}$ with a limiting value of the radius ratios. As might be expected, since there is no change in coordination

¹ GOLDSCHMIDT, V. M., *Trans. Faraday Soc.*, **25**, 253 (1929).

WESTGREN, A., *J. Franklin Inst.*, **212**, 577 (1931).

number involved in this transition, the radius ratio values for the two structures are very much alike. In fact, these are not ionic crystals, but are built of atoms, and there is little point in analyzing them in terms of ionic radii. Crystal-structure data which illustrate the transition from the NaCl to the NiAs structure are tabulated in Table 55.

TABLE 55.—THE OCCURRENCE OF THE NiAs STRUCTURE

	Atomic radii	O	S	Se	Te	As	Sb
Mg	1.59	NaCl	NaCl	NaCl	ZnS*		
Ca	1.97	NaCl	NaCl	NaCl	NaCl		
Cr	1.25		NiAs 1.65	NiAs 1.62	NiAs 1.56		NiAs 1.33
Mn	1.24	NaCl	NaCl	NaCl	NiAs 1.62	NiAs 1.54	NiAs 1.40
Fe	1.24	NaCl	NiAs 1.69	NiAs 1.63	NiAs 1.49		NiAs 1.26
Co	1.25	NaCl	NiAs 1.53	NiAs 1.47	NiAs 1.38		NiAs 1.34
Ni	1.24	NaCl	NiAs 1.55	NiAs 1.46	NiAs 1.36	NiAs 1.39	NiAs 1.30
Cd	1.49	NaCl	ZnO	ZnS	ZnS		
Zn	1.32	ZnO	ZnS	ZnS	ZnS		

* The symbols indicate the crystal structure, and the figures are axial ratios. Both are from R. W. G. Wyckoff, "The Structure of Crystals," Reinhold Publishing Corporation, New York, 1931.

Inasmuch as the transition elements are known to lie between the *A* and *B* cations in polarizing power and their tendency to form the covalent bond, it might be supposed that the NiAs structure is the result of an intermediate type of bonding. Were this the case, however, one would expect to find the NiAs structure between the NaCl and ZnO structures in the series of cadmium or zinc compounds, attached to Table 55 for comparison. Without question, the influence of the electronic structure

of the transition elements—the incomplete 18-electron shell—is primarily responsible for the NiAs structure.

Within the group there are some interesting systematic structural changes caused by variations in atomic radii and bonding.¹ In the NaCl lattice of the oxides, the oxygens are on a face-centered cubic (close-packed) lattice. It is therefore not surprising to find that, in the first compound of a transition series (*e.g.*, FeO, FeS, FeSe, FeTe) to crystallize in the NiAs structure, the axial ratio is somewhere near 1.63, the ratio for the ideal hexagonal close packing of spheres. That is, there is a minimum of distortion of the lattice when the change from the cubic NaCl to the hexagonal NiAs occurs. The metal atoms, which occupied the centers of octahedra in the NaCl structure, still are found at the centers of distorted octahedra in the NiAs structure. With a given cation, as the anion is replaced by a more easily polarized anion and one more apt to form a covalent bond, the axial ratio decreases, *i.e.*, the crystal is stretched more along the *a* axis than along the *c* axis. This means, in effect, that the metal atoms, which were distributed symmetrically throughout the lattice in the least distorted NiAs lattice, are moving farther apart in the direction of the *a* axis and are becoming more closely associated in the direction of the *c* axis, *i.e.*, the chain structure of the metal atoms is accentuated with increasing size and polarizability of the anion. Gradually, then, the metal atoms supplant the anions as the “lattice supporters.” The question arises as to whether the bond is covalent and/or metallic in all NiAs structures, or whether it, too, changes gradually; being more nearly ionic, for example, in the undistorted CrS (axial ratio 1.65) and most covalent in the highly distorted CrSb (axial ratio 1.33). This cannot be answered with certainty, but the gradual transition is quite likely.

The NiAs group is of particular interest because, with respect to properties, its members resemble both the intermediate phases of alloys and the covalent and ionic compounds. The most distinctive metallic properties of the group are opacity, electrical conductivity, and the ability of the lattice to dissolve an excess of one of the constituents—a process which is, of course, unusual in an ionic lattice.

¹ LAVES, F., *Z. Krist.*, **73**, 202 (1930).

The actual mechanism of solid solution for this structure has been studied particularly for FeS and FeSe, which may dissolve appreciable amounts of sulfur and selenium, respectively. The most significant feature of the solid solution is that, as the excess sulfur or selenium increases, the size of the unit cell, and particularly of the axial ratio, decreases. Thus:

	<i>a</i> , in Å	<i>c</i> , in Å	<i>c/a</i>
FeS (1:1)	3.43	5.79	1.69
FeS (excess S)	3.43	5.68	1.66
FeSe (1:1)	3.61	5.87	1.62
FeSe (excess Se)	3.51	5.55	1.58

These data lead to two conclusions. (1) The metal chains are separated still farther by the excess metalloid; witness the decreased axial ratio. (2) The greater proportion of sulfur or selenium does not result, structurally, from the addition of an excess of the metalloid, but from the loss of some of the iron atoms. Some lattice points in the iron chains are missing. Such a structure is reminiscent of the subtraction compounds described in Chap. IV.

Boron Nitride, BN.—Boron nitride is isomorphous with graphite. It is a layer lattice and the only example of an AX compound crystallizing with a coordination number of three. Graphite and boron nitride offer another illustration of the rule found for so many ZnS structures; that there is a similarity of structure in a series of compounds in which A stands as many places before a fourth group element as X stands after the same element. In BN and graphite, as might be anticipated, not only the structures but also the interatomic distances are the same.

Summary.—In this section, the first law of crystal chemistry has been applied to the study of the structure of AX compounds: The structure of a crystal is determined by the relative number, and the relative sizes of its building stones, and by the nature of the bonds between them. The outstanding characteristics of the ionic and covalent bonds have been discussed. It has been found that, although the ionic and covalent bonds each favor the

formation of certain crystal lattices, they are not peculiar to these lattices.

The relation between relative sizes of ions and the structures of AX compounds, as they have been developed, are summarized briefly in the following table:

Lattice type	$R_A:R_X$ ratio	C.N.	Prevalent bond type	Remarks
CsCl	0.73 +	8	Ionic	Univalent ions
NaCl	0.41-0.73	6	Ionic (except ScN, TiC, PbS, PbSe, PbTe)	Uni- and divalent cations of rare gas structure and oxides and fluorides of other cations*
NiAs		6	Covalent-metallic	A = transition element X = easily polarized
ZnS-ZnO	0.22-0.41	4	Covalent Covalent-ionic (BeO, MgTe, BeS, BeTe, AgI)	A = B cation usually; if not, ionic bond predominates X = same as in NiAs
BN (layer)	0.15-0.22	3	Covalent, metallic	
Molecular			Covalent, molecular	Intermol. force, van der Waals; intramol. force, HF, HCL, HBR, HI; ionic → covalent

* The following are all, in a sense, distorted NaCl structures: PbO, SnO, PdO, HgO, GeS, SnS, HgS.

The Structures of AX_2 Compounds.—Like compounds of the general formula AX , the AX_2 compounds may be formed with ionic, covalent, or molecular forces, and the structures of these compounds are determined by the relative sizes and the polarization properties of their building stones and the nature of the binding forces. It is helpful to mark the AX_2 regions on Chart A, in the Appendix. There are three main groups: One, at the left, running diagonally downward from left to right, includes the AX_2 compounds of ions with the rare gas configuration. A second, past the center and also running downward from left to right,

contains compounds in which the cation has a completed 18-electron shell. A third, Zone VII, includes the transition elements, those with incomplete 18-electron shells.

There is every reason to believe that these three types of cations will exert, in general, the same influences in AX_2 compounds as they do in AX compounds. That is, it may be predicted that the A cations will form ionic crystals whose structures will be determined largely by relative ionic sizes; in compounds of the B cations the covalent bond will assume increasing importance, and the transition elements will form crystals resembling in properties those with the NiAs structure. They will not, of course, crystallize in the NiAs lattice, since the relative numbers of atoms are different in the two.

Three general structural types of AX_2 compounds are conceivable:

1. A and X are individual building stones, giving rise to ionic or atomic lattices, such as the CaF_2 , TiO_2 , CdI_2 , MoS_2 , and $CdCl_2$ structures.
2. The building stones are A and X_2 , or A and AY , as in the CaC_2 , FeS_2 , and KCN structures.
3. The building stones are molecules of AX_2 , as in CO_2 and N_2O . The unit cells of these several structural types are shown in Figs. 30, 31, 32 and in Fig. 4, Chap. I.

The Transition $CaF_2 \rightarrow TiO_2$.—This transition involves a change in coordination number from eight (four) for fluorite to six (three) for rutile, and it has already been shown that, for the difluorides of all three types of ions, the change in structure is closely related to the ionic sizes. The same relation holds generally for the dioxides of a number of tetravalent elements, as may be seen from the data in Table 56. The fluorite and rutile structures are limited almost entirely to the fluorides and oxides. In these structures the building stones are practically undistorted spheres,¹ and, since the interionic distances agree very well with the values for ionic radii, the bonds are undoubtedly essentially ionic. It has been shown² that the coulomb energy

¹ For packing of spheres, it is required that the axial ratio of the rutile structure be 0.72. Actually the axial ratios of most of the compounds known to crystallize in this lattice lie between 0.60–0.70. In the few exceptions it may be assumed that the ions are distorted.

² PAULING, LINUS, *J. Am. Chem. Soc.*, **49**, 784 (1927).

TABLE 56.—THE STRUCTURE OF DIFLUORIDES AND DIOXIDES AS RELATED TO $R_A:R_X$ RATIOS

$R_A:R_X$	$R_A:R_X$	Rutile Structure C.N. = 6-3	Fluorite Structure C.N. = 8-4
MnO_2	VO_2	TiO_2	IrO_2
0.39	0.43	0.45	0.49
OsO_2	CbO_2	SnO_2	WO_2
0.49	0.50	0.51	0.53
MgF_2	NiF_2	CoF_2	FeF_2
0.56	0.59	0.60	0.62
MnF_2	ZnF_2	$SrCl_2$	CdF_2
0.66	0.65	0.75	0.76
PbF_2	BaF_2	RaF_2	
0.79	0.83		
SrF_2	CaF_2	PbF_2	BaF_2
0.89	0.89	1.04	1.09

of the fluorite structure is lower than that of the rutile structure, suggesting that all ionic AX_2 compounds should crystallize like fluorite. This structure has the highest degree of symmetry of all the AX_2 types. However, the geometric influence is strong enough to cause the fluorite \rightarrow rutile transition when the $R_A:R_X$ ratio decreases below approximately 0.67, which is significantly close to the value 0.73 at which, for the packing of perfect spheres, the coordination number will change from eight to six.

In addition to the difluorides and dioxides (also $SrCl_2$ and US_2), the following compounds crystallize in these ionic lattices: Cu_2S , Cu_2Se , Li_2O , Li_2S , Na_2S ; Mg_2Pb , Mg_2Si , Mg_2Sn . It is very probable that the bonds in the first five of these A_2X compounds are also largely ionic.

The Transition TiO_2 - SiO_2 .—This transition, involving a decrease in coordination number from six (three) to four (two), results when the $R_A:R_X$ ratio falls below the critical value 0.41. There are several different forms of SiO_2 . In quartz, stable at ordinary temperatures, the large oxygen atoms are relatively close packed; the high temperature forms, tridymite and cristobalite, are more open structures, maintained by thermal agitation. These open structures may also be stabilized by the inclusion of impurities.¹ In each, the silicon ions or atoms lie at the centers of oxygen tetrahedra. As is now well known, however, this tetrahedral coordination will permit either ionic or covalent bonds, and the type of bond actually present must be determined from other considerations. An ionic structure would allow the oxygen bonds to assume any angles, while covalent bonds should approximate angles of 90 or 109.5 deg. In β -tridymite the observed angle of 180

¹ BUERGER, M. J., *Z. Krist.*, **90**, 186 (1935).

deg. suggests an ionic bond, and in α -quartz the bonds may be somewhat covalent. GeO_2 has the structure of α -quartz.

The number of truly ionic crystals is more limited among the AX_2 compounds than within the AX group. This is not strange, since a divalent cation has a higher ionization potential than does a univalent cation of the same size.

The Transition, Ionic Lattice \rightarrow Layer Lattice:

	CaF_2	TiO_2	\rightarrow	CdCl_2	CdI_2	MoS_2
C.N.	8-4	6-3	\rightarrow	6-3	6-3	6-3

In the introduction it was shown that the stability of the CdI_2 structure may be attributed either to covalent bond formation or to strong polarization. Thus, when the F^- (radius = 1.33 A) in CaF_2 is replaced by OH^- , having the same ionic radius but being unsymmetrical and easily polarized, the resulting $\text{Ca}(\text{OH})_2$ crystallizes in the CdI_2 structure. This is a so-called "layer lattice"; the building stones are arranged so that the cadmium ions are coordinated symmetrically to six iodide ions, but each iodide ion has three cadmium neighbors *on only one side*. This means that there are positive and negative ions in the sequence:

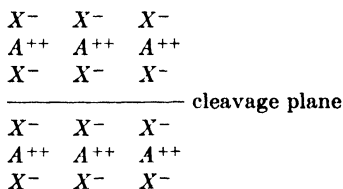

an arrangement which gives rise to a discontinuity in strength along the vertical direction, since the bonds between adjacent layers of negative ions must be very weak in comparison with those between ions of opposite charges. A packing drawing of the CdI_2 structure is shown in Fig. 5 (Chap. I).

It is convenient to consider the three structures CdCl_2 , CdI_2 , and MoS_2 as a group, since all are of the layer lattice type. The experimental values of the $R_A:R_X$ ratios of the first two of these are compared, in Table 57, with the values found for crystals with the TiO_2 structure.

Obviously the transition TiO_2 to CdCl_2 (CdI_2) cannot be attributed to the relative ionic radii, nor can one predict on the

TABLE 57.—RANGE OF EXPERIMENTAL $R_A:R_X$ VALUES OF TiO_2 , $CdCl_2$, AND CdI_2 CRYSTALS

TiO_2	0.39–0.63
$CdCl_2$	0.28–0.55
CdI_2	0.24–0.54

basis of radius ratio which of the structures TiO_2 , $CdCl_2$, or CdI_2 will occur. On the contrary a survey of the compounds which crystallize like $CdCl_2$ and CdI_2 makes it plain that these structures are always the result of the covalent bond influence or of polarization. Among these compounds there are three distinct groups:

1. The bromides and the iodides of divalent transition ions and B cations, and of the smallest of the A cations, Mg^{++} . These are all strongly polarizing and are combined with the two halides most easily polarized. Covalent bonding may also be expected to be influential.

2. The sulfides, selenides, and tellurides of some tetravalent ions, including palladium, platinum, tin, titanium, and zirconium, all strongly polarizing cations with easily polarized anions; and all involving an appreciable degree of covalent binding.

3. Hydroxides of many divalent ions, those with the rare gas configuration (Ca , Mg) as well as the B cations (Cd) and transition cations (Co , Fe , Ni , Mn). The OH^- has a permanent dipole and so induces the formation of the CdI_2 structure even when combined with a cation, such as calcium, which is not strongly polarizing.

The relationship of the CaF_2 , TiO_2 , $CdCl_2$, and CdI_2 structures may be seen more clearly in Table 58. It is evident that the TiO_2 structure is not an intermediate type in the transition from $CaF_2 \rightarrow \begin{matrix} CdCl_2 \\ CdI_2 \end{matrix}$. The occurrence of the CaF_2 or TiO_2 structure is a matter of ionic radii. The substitution in either of these lattices of an easily polarized ion for one which does not polarize easily leads to the $CdCl_2$ or CdI_2 structure.

The $CdCl_2$ structure, on the other hand, is obviously a half-way point in the transition

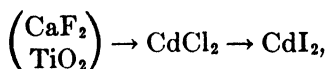

and is therefore produced when the degree of polarization is greater than in the CaF_2 or TiO_2 lattice but less than in the CdI_2 lattice. This $CdCl_2$ lattice is found only among chlorides of certain divalent cations of all three types: the rare gas cations,

Mg⁺⁺, ions of the transition elements, Mn⁺⁺, Fe⁺⁺, Co⁺⁺, Ni⁺⁺, Ru⁺⁺, Rh⁺⁺, Pd⁺⁺, Ir⁺⁺, Pt⁺⁺, and divalent B cations, Zn⁺⁺, Cd⁺⁺.

TABLE 58.—OCCURRENCE OF THE CdCl₂ AND CdI₂ STRUCTURES

Cation	Radii	Anion			
		F	Cl	Br	I
Ni	0.74	TiO ₂	CdCl ₂		
Co	0.78	TiO ₂	CdCl ₂	CdI ₂	CdI ₂
Fe	0.80	TiO ₂	CdCl ₂	CdI ₂	CdI ₂
Mn	0.83	TiO ₂	CdCl ₂	CdI ₂	CdI ₂
Zn	0.83	TiO ₂	CdCl ₂		
Mg	0.83	TiO ₂	CdCl ₂	CdI ₂	
Cd	0.99	TiO ₂	CdCl ₂	CdCl ₂	CdI ₂
Ca	1.05	CaF ₂			
Sr	1.18	CaF ₂	CaF ₂		
Ba	1.31	CaF ₂			

The CdCl₂ and CdI₂ structures are very similar. They have been described in detail by Pauling and Hoard.¹ In both, each cadmium ion is surrounded octahedrally by six halogen ions, and the edges of these octahedra are shared with others to form a complete octahedral layer. In the CdI₂ structure the layers are superimposed so that each cation is directly above a cation in the layer below, while in the CdCl₂ structure each cation is directly above an anion in the layer below. This arrangement within the layers is schematically shown as follows:

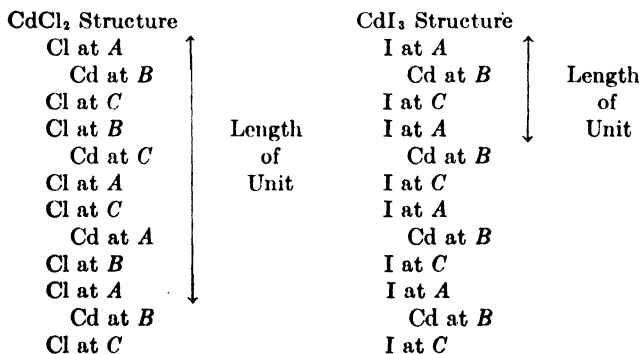

¹ PAULING, LINUS, *Proc. Natl. Acad. Sci.*, **15**, 709 (1929); PAULING, LINUS, and J. L. HOARD, *Z. Krist.*, **74**, 548 (1930).

Evidently there is no essential physical difference in these two arrangements; merely a difference in the sequence of layers and therefore in the unit of structure. In fact, although sublimed CdBr_2 has the CdCl_2 structure, it has recently been claimed¹ that the diffraction pattern of precipitated CdBr_2 shows only the lines common to both the CdCl_2 and CdI_2 structures, and a structure is suggested in which there is a random arrangement of the layers of both types.

The nature of the bonds in crystals of the CdCl_2 and CdI_2 types may be surmised from a consideration of interionic distances. In both, the anion-anion distances are compatible with ionic radii. The Cd-Cl distance in CdCl_2 , however, is only 2.66 Å as compared with 2.78, the sum of the ionic radii. This decrease in interionic distance shows evidence of the covalent bond and polarization. From the standpoint of bond type, both these structures are transitional in nature. The bonds within a given layer are ionic-covalent; each layer may represent a single giant molecule. The bonds between layers are weaker, essentially molecular or van der Waals' forces. In the comparable AX compounds, those with the ZnS (ZnO) structure, a layer lattice is not possible and strong covalent or partly ionic bonds extend throughout the crystal, so that the whole may be thought of as a giant molecule.

Whereas in the CdCl_2 and CdI_2 layer lattices the halogen ions are at the corners of an octahedron, only slightly distorted, in the MoS_2 lattice, the negative atoms are at the corners of a trigonal prism. Furthermore, the S-S distance indicates that the sulfurs are in the atomic rather than the ionic state. The MoS_2 structure, therefore, is a layer lattice in which the forces are largely covalent within layers. It is known only for WS_2 , WTe_2 , MoS_2 , MoSe_2 , and MoTe_2 . Why these two metals should form the MoS_2 structure while the sulfides, selenides, and tellurides of Ti, Zr, Sn, Pt, and Pd crystallize like CdI_2 has not been established with certainty, but wave mechanical calculations suggest that quadrivalent tungsten and molybdenum can form the trigonal prism covalent bonds which characterize the MoS_2 structure.²

¹ BLIJVOET, J. M., and W. NIEUWENKAMP, *Z. Krist.*, **86**, 466 (1933).

² HULTGREN, R., *Phys. Rev.*, **40**, 891 (1932).

The Transition CdI_2 , CdCl_2 , $\text{MoS}_2 \rightarrow \text{FeS}_2$.—The pyrite structure is found among compounds of the transition elements with S, Se, Te, P, As, and Sb; the same combinations of elements which, in AX compounds, form the NiAs lattice. The properties of compounds crystallizing in the pyrite lattice are distinctive and similar to those of compounds with the NiAs structure.

The difference between the layer lattices and that of pyrite seems to depend primarily upon the condition of the atoms X in the compound AX_2 . In the CdCl_2 and CdI_2 lattices, X is an ion, or nearly so; in the MoS_2 lattice are found X atoms, and in pyrite there exists in the lattice a definite X_2 molecular group. The distance Fe-S in the pyrite crystal indicates that the iron is in the atomic rather than the ionic state. The S-S distance is 2.08 Å, which is about twice the radius (1.06 Å) of atomic sulfur.

TABLE 59.—ATOMIC RADII AND THE OCCURRENCE OF THE FeS_2 STRUCTURE

Element	Radius (C.N.12)	Structure of sulfides, selenides, tellurides		
		Compounds		Structure type
Zr	1.60	ZrS ₂	ZrSe ₂	CdI ₂
Sn	1.58	SnS ₂		CdI ₂
Ti	1.45	TiS ₂	TiSe ₂ TiTe ₂	CdI ₂
W	1.41	WS ₂	WSe ₂ WTe ₂	MoS ₂
Mo	1.40	MoS ₂	MoSe ₂ MoTe ₂	MoS ₂
Pt	1.38	PtS ₂	PtSe ₂ PtTe ₂	CdI ₂
Pd	1.37		PdTe ₂	CdI ₂
Mn	1.38	MnS ₂	MnTe ₂	FeS ₂
Os	1.34	OsS ₂	OsSe ₂ OsTe ₂	FeS ₂
Ru	1.32	RuS ₂	RuSe ₂ RuTe ₂	FeS ₂
Fe	1.27	FeS ₂		FeS ₂
Co	1.26	CoS ₂	CoSe ₂	FeS ₂
Ni	1.24	NiS ₂	NiSe ₂	FeS ₂

It is interesting to consider the cause of these differences in the condition of the X atoms. Goldschmidt has suggested that when the atomic radii of the metals are large, layer lattices are formed; whereas, metals with small atomic radii and low valences cannot split the X_2 molecule, and the pyrite lattice results. This suggestion is based on his classification,¹ shown in Table 59.

¹ GOLDSCHMIDT, V. M., *Trans. Faraday Soc.*, **25**, 279 (1929).

The influence of the valence of the metal, however, appears to be of greater significance than the size. Those metals which form the CdI_2 or MoS_2 structure are all quadrivalent, and each may therefore combine with two X atoms through either ionic bonds (in CdI_2) or covalent bonds (in MoS_2). Those metals which favor the pyrite structure, on the other hand, are apt to form divalent ions. They are therefore unable to combine with two separate divalent X atoms through either ionic or covalent bonds. But when two divalent X atoms combine with themselves to form an X_2 group, the electronic arrangement may be presumed to be $:\ddot{X}:\ddot{X}$, leaving two electrons lacking to complete the octets. The X_2 group, then, may be considered as having a negative valence of two and is equivalent in combining power to one divalent X atom. The divalent metals are therefore able to combine with this X_2 group just as they can combine with a single divalent negative atom. Hence the type of combination may be essentially the same in FeS and in FeS_2 , both satisfying the same valence requirements. That the type of bond is similar in crystals of the NiAs and FeS_2 types is unmistakably supported by the striking similarity of properties of these two groups. The situation may be summarized in slightly different terms. A tetravalent metal atom can and does hold each divalent X atom separately; a divalent metal atom cannot do this and, as an alternative, holds one divalent X_2 group.

As further evidence in support of this picture, the comparisons in Table 60 may be cited.

TABLE 60.—STRUCTURES OF CERTAIN PLATINUM SALTS

CdI_2 Structure	FeS_2 Structure
PtS ₂	PtP ₂
PtSe ₂	PtAs ₂
PtTe ₂	PtSb ₂

Let it be assumed that the platinum tends to be quadrivalent. Then it is able to hold two divalent X atoms separately and the sulfide, selenide, and telluride of platinum crystallize in the CdI_2 structure. But two trivalent atoms (*e.g.*, P, As, Sb) cannot be held separately by a tetravalent atom. When two trivalent atoms X form an X_2 group, however, the electronic arrangement is $\ddot{X}:\ddot{X}$, and the group lacks four electrons to complete the

octets. That is, the X_2 group, as such, has a negative valence of four and can combine with tetravalent platinum in the usual way. Stated in another way, platinum has a high enough valence to split the S_2 group but not the P_2 group. One may predict that in an AX_2 compound with X trivalent, if A were hexavalent, and other conditions suitable the compound would have the CdI_2 or MoS_2 structure.

Of course, it must be repeated that all the bonds in the FeS_2 structure are not strictly covalent. The pronounced metallic properties of compounds with this structure indicate that the bonds are, to some degree, metallic. It is probably significant that in both the $NiAs$ and FeS_2 structures the metal is always a transition element. In CoS_2 and NiS_2 , for example, there are electrons which cannot be placed in the regular $3d$, $4s$, and $4p$ orbitals but must go into excited orbitals. These are probably metallic electrons.¹

The CaC_2 Structure.—This structure, shown in Fig. 30, bears a certain resemblance to pyrite, in that the carbon atoms exist as C_2 groups. The similarity ends here, however, for the properties of the carbides do

not resemble those of the pyrite group in the least. (Carbides of the transition elements, interstitial structures, do have metallic properties.) The CaC_2 structure has been observed for the carbides of Ca, Sr, Ba, Ce, La, Nd, and Pr. It has been reported that BaO_2 and SrO_2 also have the CaC_2 structure, thus confirming the actual existence of the O_2^- radical in these compounds.²

The Transition $FeS_2 \rightarrow CO_2$.—In both these structures the space group and the atomic positions are the same as shown

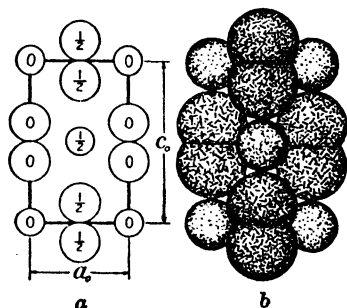

FIG. 30—*a*, the unit prism of the CaC_2 arrangement, projected upon an *a*-face. Atoms of Ca are small, atoms of C are larger circles. *b*, a packing drawing. The atoms of C have been made large enough to contact with adjacent Ca ions. (From Wyckoff, "The Structure of Crystals," by permission of the Reinhold Publishing Corporation, New York.)

¹ PAULING, LINUS, and M. L. HUGGINS, *Z. Krist.*, **87**, 228 (1934).

² BERNAL, J. D., E. D'YATLOVA, I. KASARNOVSKII, S. I. RAHKSTEIN, A. G. WARD, *Z. Krist.*, **92**, 344 (1935).

in Figs. 31 and 32, but the parameters differ. The X atoms which existed as S_2 groups in FeS_2 are attracted strongly to the carbon

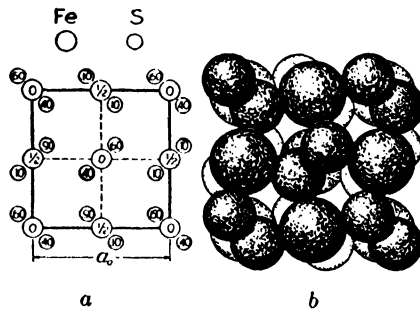

FIG. 31.—*a*, a projection of the unit cell of pyrite upon a cube face. Distances below the projection plane are indicated by a minus sign. In comparing *a* and *b* it must be remembered that 0.10 is equivalent to 0.90. *b*, a packing drawing of the unit cube, assuming atomic radii. (From Wyckoff, "The Structure of Crystals," by permission of the Reinhold Publishing Corporation, New York.)

in CO_2 and have become definitely associated with it to form a molecular structure.

Both structures may be pictured as special cases of the NaCl structure. In all three the atoms *A* are on a face-centered cubic

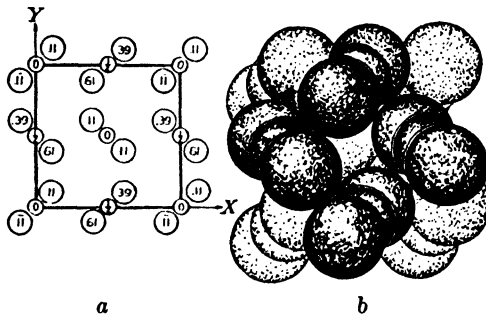
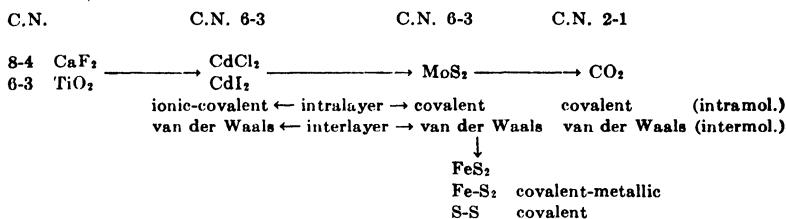

FIG. 32.—*a*, a projection of the unit cell of solid CO_2 upon a cube face. Atoms of C are small, atoms of oxygen are larger circles. *b*, a packing drawing of solid CO_2 . (From Wyckoff, "The Structure of Crystals," by permission of the Reinhold Publishing Corporation, New York.)

lattice. In NaCl the atoms *X* are on an interpenetrating face-centered cubic lattice; in pyrite, X_2 groups are on an interpenetrating face-centered cubic lattice; in CO_2 , the *X* atoms are part of the CO_2 molecule. The KCN structure may also be

considered as an elaboration of the NaCl structure.¹ In this case, the CN⁻ acts as a unit, so that the compound KCN belongs more properly with AX compounds rather than with the AX₂ group.

In AX₂ compounds the complete transition from an ionic to a molecular lattice might be represented by the series:



Niggli² has pointed out certain simple but helpful relationships between the arrangement of atoms in metallic, AX and AX₂ lattices. It is useful to observe that, in general, three principal types of packing may be followed through the most common metallic, AX and AX₂ structures. These are face-centered cubic, body-centered cubic, and close-packed hexagonal. In the structures listed in Table 61, it is usually the negative ions or

TABLE 61.—PACKING OF "LATTICE SUPPORTERS" IN METALS, AX AND AX₂ LATTICES

	Body-centered cubic	Face-centered cubic	Close-packed hexagonal	Layer
Metal	Tungsten	Copper	Magnesium	Graphite
AX	CsCl	NaCl ZnS	NiAs ZnO	BN
AX ₂		CaF ₂ CdCl ₂ FeS ₂ Co ₂ Cu ₂ O	CdI ₂ HgI ₂	

¹ WYCKOFF, R. W. G., "The Structure of Crystals," pp. 234-235, Reinhold Publishing Corporation, New York, 1930.

² NIGGLI, P., and E. BRANDENBERGER, *Z. Krist.*, **79**, 379 (1931).

atoms X , which are packed in one of these three ways (for CaF_2 , FeS_2 , Cu_2O , and CO_2 , it is the positive ions or atoms A which are on a face-centered cubic lattice).

The Structures of A_2X_3 Compounds.—Nearly all of the A_2X_3 compounds whose structures have been studied are oxides. They are essentially ionic and their structures depend upon the relative sizes of the ions as is evident from the data in Table 62.

TABLE 62.—INFLUENCE OF $R_A:R_X$ ON THE STRUCTURE OF A_2X_3 OXIDES*

$R_A:R_X$	Structure	C.N.	Examples
0.43–0.52	Corundum	6-4	$\alpha\text{-Al}_2\text{O}_3$, $\alpha\text{-Ga}_2\text{O}_3$, $\alpha\text{-Fe}_2\text{O}_3$, Ti_2O_3 , Cr_2O_3 , V_2O_3 , Rh_2O_3
0.53–0.86	<i>C</i> structure of rare earth oxides	6-4	$(\text{Fe},\text{Mn})_2\text{O}_3$, Sc_2O_3 , In_2O_3 , Lu_2O_3 , Yb_2O_3 , Tl_2O_3 , Er_2O_3 , Tl_2O_3 , Ho_2O_3 , Y_2O_3 , Dy_2O_3 , Tb_2O_3 , Gd_2O_3 , Eu_2O_3 , Sm_2O_3
	<i>B</i> rare earths		Dy_2O_3 , Tb_2O_3
0.86–0.92	<i>A</i> rare earth	3-2	La_2O_3 , Ce_2O_3 , Pr_2O_3 , Nd_2O_3 , Sm_2O_3

* The $R_A:R_X$ values are calculated from the crystal ionic radii, not from the univalent radii.

The Corundum Structure.¹—The structure is rhombohedral. As might be expected from the $R_A:R_X$ ratio, each metal ion is surrounded by six oxide ions at the corners of a somewhat distorted octahedron in which the edges are shortened, a shortening which is quite characteristic of ionic crystals.² The interionic distances also suggest that the bonds are essentially ionic.

The *C* Modification of the Rare Earths. Tl_2O_3 .—This structure bears an interesting geometrical relation to zinc blende and fluorite. It is cubic, and the metal atoms may be pictured on a face-centered cubic lattice as they are in ZnS and CaF_2 . In CaF_2 , there are eight X ions at the corners of a cube within the face-centered cube of metal ions (see Fig. 4, Chap. I); in ZnS ,

¹ PAULING, LINUS, and S. B. HENDRICKS, *J. Am. Chem. Soc.*, **47**, 781 (1925).

² PAULING, LINUS, and M. L. HUGGINS, *Z. Krist.*, **87**, 216 (1934).

four of these eight X ions have been removed; in the idealized Tl_2O_3 lattice, only two of the eight X ions need be removed to satisfy the stoichiometric relation A_2X_3 . In the actual Tl_2O_3 structure, there is considerable distortion and the coordinated octahedra are such that the anions lie nearly at six corners of a cube. It is thus possible to maintain the C.N. 6 even though the $R_A:R_X$ value may be as high as 0.86.

The A Modification of the Rare Earths. La_2O_3 .—This is a layer lattice. Pauling has suggested that the deformation of the lattice is due to the mutual repulsion of La^{+3} ions in a close-packed layer. Because of this mutual repulsion and the resulting deformation, each cation is closer to one anion of another layer than it is to three of the anions in its own octahedra. Actually, each cation is coordinated to seven anions and the crystal is built of electrically neutral double layers of octahedra. Interionic distances indicate that the forces within the layers are essentially ionic.

As_4O_6 and Sb_4O_6 form molecular crystals, the As_4O_6 molecules being distributed in a cubic lattice with their centers at the positions occupied by carbon atoms in the diamond lattice. In the high temperature, orthorhombic form of Sb_2O_3 , there exist double molecular chains, rather than discrete molecules.¹

A transition from ionic, to layer, to molecular lattice is illustrated by the series

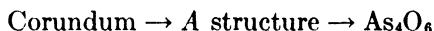

The Structures of AX_3 Compounds.—Three main types of AX_3 crystals, reminiscent of the three types of AX_2 crystals, are to be expected.²

1. $X \begin{array}{c} \diagdown \\ \diagup \end{array} A \begin{array}{c} \diagup \\ \diagdown \end{array} X$, in which atoms or ions of A and X act as in-



dependent building units in the crystal. Examples: AlF_3 and AsI_3 structures.

¹ BUERGER, M. J., and S. B. HENDRICKS, *J. Chem. Phys.*, **5**, 600 (1937).

² The structures of AX_3 type have recently been summarized by Nowacki: *Z. Krist.*, **89**, 85 (1934).

2. $A(X)_3$ or $A(XY_2)$, in which the X_3 or XY_2 group is a single unit in the structure. Examples: NaN_3 , KN_3 , and the isomorphous CsCl_2I , NaHF_2 , and KHF_2 .

3. Molecular crystals, in which the AX_3 molecule acts as a structural unit. Example: NH_3 .

Neuburger¹ has pointed out, that those fluorides of trivalent metals, the oxides of which have the corundum structure, crystallize like AlF_3 ; when the oxides have the C structure, the fluorides crystallize like tysonite, LaF_3 . The $R_A:R_X$ values separating these structural types correspond to those for the A_2X_3 groups, since the radii of O^- and F^- are about the same.

Because the fluoride ion is so small, is not easily polarized, and tends to form an ionic bond the trifluorides do not crystallize in lattices in which the layers are well developed. Layer lattices are to be expected for trichlorides, tribromides, and triiodides, however, in which the anion is larger and easily polarized.² A typical transition from an ionic lattice to a layer lattice is represented by $\text{BiF}_3 \rightarrow \text{BiI}_3$.

The NaN_3 and KN_3 Structures.—These structures resemble geometrically those of pyrite and CaC_2 in that the N_3 group exists in the crystal as such. It is, perhaps, easiest to visualize these structures as they are related to the CsCl and NaCl lattices, respectively.³

The substitution of cylindrical N_3 ions for spherical Cl ions causes the NaCl structure to expand along the 111 (body diagonal) direction. The substitution of N_3 for Cl ions in the CsCl structure requires an expansion along both the h and k axes, and a tetragonal crystal results.

It is not surprising to find KCNO essentially, though not exactly, isomorphous with KN_3 , for the total number of electrons of the two groups CNO and N_3 are the same, each containing three nuclei, 6 inner and 16 outer electrons. Furthermore, the acid fluoride NaHF_2 and KHF_2 also crystallize like KN_3 , and the HF_2 group has three nuclei and 22 electrons. Other groups

¹ NEUBURGER, M. C., "Ahrens' Sammlung," no. 17, F. Enke, Stuttgart, 1933.

² MEGAW, H. D., *Z. Krist.*, **87**, 185 (1934).

³ HENDRICKS, S. B., and LINUS PAULING, *J. Am. Chem. Soc.*, **47**, 2904 (1925).

which have three nuclei and 22 electrons are CO_2 and N_2O , and these have structures analogous to the N_3 ion—the three atoms are colinear. It is to be expected that the BO_2^- and BeO_2^- and NO_2^+ ions, all with 22 electrons, will also have this colinear structure.

The Structures of AX_4 Compounds.—There is little chance for compounds of this type to crystallize in any but a molecular lattice. This is evident, since each A may be completely surrounded and screened by four X atoms, preventing any direct bond between this A atom and an X atom of a neighboring molecule. The SnI_4 structure (Fig. 7) is the best known of this group, the building unit being the SnI_4 molecule, of which there are eight in a unit cell. The distance between iodide atoms in neighboring tetrahedra is 4.21 Å, agreeing with their separation in the CdI_2 structure and in molecular iodine. Of the few AX_4 compounds whose structures have been studied, nearly all crystallize like SnI_4 .

The Structures of AX_6 Compounds.—The structure of CaB_6 and a number of isomorphous substances is of particular interest because each boron is approximately equidistant from five other boron atoms¹ forming a three dimensional network with the calcium ions lying in the interstices. To find boron, an atom² in the first short period, forming five bonds is very unusual; but there seems to be no doubt that the structure is the correct one.

Binary Compounds of Variable Composition. Subtraction and Addition Compounds.²—The solution of excess sulfur, selenium, and oxygen in the FeS , FeSe , and FeO lattices, respectively, has already been described. Many additional cases of this type of variable composition are coming to light and contribute to the lengthening list of compounds which do not, in the strict sense, conform to the law of definite proportions.

Magnetic ferric oxide, $\gamma\text{-Fe}_2\text{O}_3$, formed by the low temperature oxidation of Fe_3O_4 , retains the spinel structure of the latter. The oxygen lattice remains intact throughout the change, but, as

¹ VON STACKELBERG, M., and F. NEUMANN, *Z. physik. Chem.*, **B 19**, 314 (1932); LAVES, F., *Z. physik. Chem.*, **B 22**, 114 (1933); PAULING, LINUS, and S. WEINBAUM, *Z. Krist.*, **87**, 181 (1934).

² See also pp. 156-157, Chap. IV; and p. 330, Chap. X.

the valence of iron increases, vacant positions appear in the iron lattice.¹ γ -Fe₂O₃ may be grouped with the subtraction compounds.

The influence of solid solution in binary compounds upon the electronic conductivity of such compounds has been discussed by Wagner.² According to his interpretation, the increase in electronic conductivity of CdO and ZnO with decreasing oxygen pressure³ shows that these oxides can dissolve excess metal; while the increase in electronic conductivity with increasing pressure of iodine and oxygen in CuI⁴ and Cu₂O,⁵ respectively, indicates the formation of solid solutions with an excess of iodine or oxygen.

Several unusual cases of solid solution, difficult to understand on the basis of the first law of crystal chemistry, are reasonable when viewed in the light of the subtraction compound, the crystal with vacant lattice points. MgCl₂ and LiCl, although differing in crystal structures and in relative numbers of positive and negative ions, form solid solutions over a wide range of composition.⁶ In both, the chloride ions lie on a close-packed cubic lattice, but in LiCl there are twice as many cations as in MgCl₂. Solid solutions of MgCl₂ in LiCl, therefore, may be considered as crystals of the LiCl type, but with some of the cation positions vacant. On the contrary, the well-known solid solutions of YF₃ in CaF₂ and of BiF₃ in PbF₂,⁷ are thought to be possible⁸ because of the interstitial addition of fluoride ions to the CaF₂ lattice, an addition which, because of the relatively small size of F⁻, is geometrically permissible.

Possibly the isomorphism of Co(NH₃)₆I₂ and Co(NH₃)₆I₃ is like that of CaF₂ and YF₃.⁹ In the former case, even the large iodide ions may enter the CaF₂ lattice of Co(NH₃)₆I₂ inter-

¹ HÄGG, G., *Z. physik. Chem.*, **B 29**, 95 (1935).

² WAGNER, C., *Z. physik. Chem.*, **B 22**, 181 (1933).

³ BAUMBACH, H. H. V., and C. WAGNER, *Z. physik. Chem.*, **B 22**, 191 (1933).

⁴ NAGEL, K., and C. WAGNER, *Z. physik. Chem.*, **B 25**, 71 (1934).

⁵ DUNWALD, H., and C. WAGNER, *Z. physik. Chem.*, **B 22**, 212 (1933).

⁶ BRUNI, G., and A. FERRARI, *Z. Krist.*, **89**, 499 (1934).

⁷ HASSEL, O., and S. NILLEN, *Z. anorg. allgem. Chem.*, **181**, 172 (1929).

⁸ HÄGG, G., *Z. Krist.*, **91**, 144 (1935).

⁹ HASSEL, O., and H. KRINGSTAD, *Z. anorg. allgem. Chem.*, **209**, 281 (1932).

stitially, because of the stable lattice of much larger $\text{Co}(\text{NH}_3)_6^{++}$ groups.

It is helpful to consider these compounds of variable composition as interstitial phenomena, made possible, usually, by the existence of very stable anion lattices. The wide range of homogeneity of the Ag_2HgI_4 lattice¹ has been attributed to the stability of the lattice of large, close-packed iodide ions, in the interstices of which small silver and mercuric ions may be substituted more or less indiscriminately.

In many of the silicates, to be discussed later, interstitial substitution is possible because of the strong SiO_2 skeleton which dominates these crystals.

The Structure of Binary Compounds. Summary.—The structure of a crystal is determined primarily by the relative numbers, the relative sizes of its building stones, and the nature of the bonds between them. The structural details of greatest significance are: the arrangement of, and the distance between, the building stones, and the nature of the bond.² The polarization properties of atoms or ions probably exert a minor influence on crystal structure. They are determined principally by size and electronic structure. Valence, and the number of electrons in the outer shell of the ion are the important features of electronic structure.

The methods of determining the nature of the bonds in a crystalline solid have been outlined, and the characteristics of the ionic and covalent bonds have been reviewed.

The Effect of Electronic Structure on Type of Bond and Polarization Properties.—The effect of electronic structure upon polarization and bond type may be summarized as shown in the table at the top of page 204.

This classification is borne out by Chart A, in the Appendix, almost without exception. The regions of two- and eight-electron-shell cations, and the fluorides and oxides, contain ionic crystals. The metallic bond region is limited strictly to the sixth,

¹ KETELAAR, J. A. A., *Z. Krist.*, **87**, 436 (1934).

² It should be recalled that both these criteria have been used in the classification of crystals. Thus, one speaks of the NaCl structure, referring to the arrangement of the building stones; and of an ionic crystal, emphasizing the bond type.

Electronic structure		Bond type	
Electrons in outer shell of ion	Valence		
2 } 8 } 18 + 2	{ Univalent Divalent Univalent	Largely ionic	Not strongly polarizing
2 } 8 } 8 → 18 18 18 + 2	{ Trivalent Tetravalent Transition Any valence	Ionic to covalent More ionic with oxide or fluoride	Strongly polarizing
8 → 18	Transition ions with S, Se, Te, P, As, Sb, Bi	Covalent, partially metallic bond	

seventh, and eighth group transition elements.* Most of the rest are covalent or predominantly covalent compounds with either atoms or molecules for building stones.

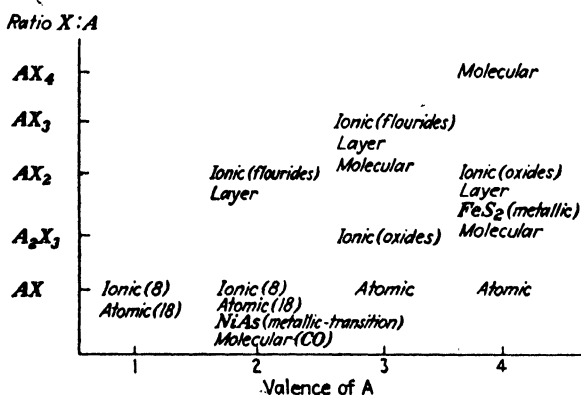

FIG. 33.—The influence of stoichiometric formula, valence, and electronic structure upon the crystal structure of binary crystals. Figures in parentheses designate ions characterized by 8 or 18 electrons in the outer shell.

While the limited number of compounds of the groups A_2X_3 , AX_3 , AX_4 , and A_mX_n which have been studied does not permit so complete a systematization of types as is possible with the

AX and AX_2 groups, certain general tendencies of the entire series of binary compounds may be observed. The influence of the number of building stones (as indicated by stoichiometric formulas) and their valences upon the crystal structure of binary compounds, classified according to the character of these building stones, is shown graphically in Fig. 33. This chart brings out the following points:

1. As the valence of either cation or anion, or both, increases, the tendency to form ionic crystals decreases and the tendency to form molecular crystals increases. In binary compounds, other than the univalent and divalent AX compounds, ionic forces prevail only when the anion is either fluoride or oxide, both with high electron affinities. Thus, in the AX and AX_2 compounds, the bonds may be ionic, metallic, covalent, or molecular; and for these compounds the influence of other factors must be taken into consideration.

2. The layer lattice, in which a layer may be thought of as a giant molecule, a structural unit in the crystal, is limited to the AX_3 crystals and the AX_2 compounds in which A is a strongly polarizing cation (also BN). Again, its intermediate position in the transition from ionic to molecular type is evident.

3. Only the molecular lattice is found among AX_4 crystals.

The influence of the relative numbers of building stones, their valences, and electronic structures upon crystal structure is summarized in greater detail in Table 63. Here, both the arrangement of the building units and the nature of the forces holding them together are described.

Chart A,¹ described in the Appendix, summarizes in detail the influence of size, stoichiometric formula, electronic structure, type of binding and polarization properties upon the structure of binary compounds.²

¹ The data have been taken, for the most part, from: EWALD, P. P., and C. HERMANN, "Strukturbericht 1913-1928," Leipzig, 1931; WYCKOFF, R. W. G., "The Structure of Crystals," 2d ed., Reinhold Publishing Corporation, New York, 1930. Supplement, 1934; BERNAL, J. D., *Ann. Repts. London Chem. Soc.*, 1931, 1933; *Trans. Faraday Soc.*, **25**, 367-379 (1929); WESTGREN, A., and coworkers: Numerous papers; "International Critical Tables," vol. II, Alloys, McGraw-Hill Book Company, Inc., New York; A relatively small number have been taken from recent periodical literature.

² This classification is similar to a recent one by Grimm, *Z. angew. Chem.*, **47**, 53, 594 (1934). Grimm, however, arranged the elements away from

Perhaps the most interesting generalization to be found in Chart A is the relation between the so-called electron concentration and the character of a binary system. The electron concentration in a binary phase is the number of valence electrons per atom. In the alloy Cu_5Zn_8 , for example, there are 21 valence electrons and 13 atoms, and the electron concentration is 1.6; in SnI_4 there are 32 valence electrons and 5 atoms, and the electron concentration is 6.4. That the nature of a binary phase is greatly influenced by this electron concentration is very evident. The metallic properties are associated with low electron concentrations; as the electron concentration increases, the binary phases become less metallic in nature until, with an electron concentration of 4.0, the familiar ionic and covalent AX compounds appear. The molecular crystals, particularly those of compounds of two or more electronegative elements, are characterized by high electron concentrations. The influence of electron concentration upon the nature of binary phases is shown in detail in Table 64.

The transition from metallic, to atomic, to molecular crystals of the elements, as it may be observed along the diagonal away from the origin in Chart A, is entirely consistent with the relation between electron density and bond type brought out in Table 64. Thus the electron density of diamond (also gray Sn, Si, Ge) is four; that of arsenic (also Sb, Bi) is five; of selenium (also Te) six; and of iodine, the last stage in the transition from an atomic to a molecular structure, seven.

In the study of the structures of elements, alloys, and binary compounds, four different kinds of bonds have been discussed at considerable length; and it has been observed, in a general way, how they affect the properties of compounds in which they exist. These bonds are: ionic, covalent, metallic and molecular (van der Waals' forces). It has been implied that rarely does a compound occur in which only one normal bond type exists. Some of the alkali halides approach the pure ionic bond; diamond is an example of a crystal in which the building stones are held together by bonds predominantly covalent; and copper and some of the

the origin in the order of increasing atomic numbers, and the result is somewhat confusing because the chart does not break up into compact areas enclosing a number of systems of similar properties.

TABLE 63.—RELATION OF CRYSTAL STRUCTURE AND PREVALENT BOND TYPE OF BINARY CRYSTALS TO THE RELATIVE NUMBERS, THE VALENCES, AND THE ELECTRONIC STRUCTURES OF ATOMS

Formula	Valences		Electronic structure of A	Crystal types	Bond types
	A	X			
AX	1	1	2, 8, 18 + 2 18	CsCl, NaCl	Ionic
	2	2	2, 8, 18 + 2 18	ZnS, ZnO, NaCl NaCl, ZnS, ZnO	Ionic-covalent Ionic; covalent-ionic
	3	3	18 Transition	NaCl, ZnS, ZnO NiAs	Covalent-ionic; covalent Covalent-metallic
	4	4	2 8, 18	BN NaCl, ZnS, ZnO NaCl, ZnS, ZnO CO	Covalent-metallic Essentially covalent Essentially covalent Covalent (intramol.) Van der Waals (intermol.)
AX ₂	2	1	8, 18(X = F ⁻) transition (X = F ⁻)	CaF ₂ , SnO ₂	Ionic
			8, 18, transition (layers)	CdCl ₂ , CdI ₂	Covalent-ionic; covalent Van der Waals (between layers)
	4	2	8, 18, (oxides) transition (oxides)	CaF ₂ , SnO ₂	Ionic
			8, 18 Transition	CdI ₂ MoS ₂	Covalent-ionic; covalent Van der Waals (between layers) Covalent (in layers) Van der Waals (between layers)
			2	CO ₂	Covalent (intramol.) Van der Waals (intermol.)
			Transition	FeS ₂ , FeAs ₂ (S ₂ , molecular groups)	Covalent-metallic
A ₂ X ₃	3	2	8, 18, transition	Al ₂ O ₃ , C structure, As ₄ O ₆ , A structure	Ionic; covalent-ionic (oxides) Covalent (intramol.) Van der Waals (intermol.)

TABLE 63.—RELATION OF CRYSTAL STRUCTURE AND PREVALENT BOND TYPE OF BINARY CRYSTALS TO THE RELATIVE NUMBERS, THE VALENCES, AND THE ELECTRONIC STRUCTURES OF ATOMS.—(Continued)

Formula	Valences		Electronic structure of A	Crystal types	Bond types
	A	X			
AX_3	3	1		CeF ₃ BiI ₃ (layer) NaN ₃ , KN ₃ NH ₃	Ionic Covalent-ionic; molecular N ₃ ion Covalent (intramol.) Van der Waals (intermol.)
AX_4	4	1		SnI ₄	Covalent (intramol.) Van der Waals (intermol.)

TABLE 64.—ELECTRON CONCENTRATION AND THE CHARACTERISTICS OF BINARY PHASES

Electron Concentration	Description of Binary Phase
Less than 1.5	Alloy. Typical metallic properties
1.5	Alloy. β phases. Secondary solid solutions. Metallic properties
1.6	Alloy. γ phases. Some properties suggestive of covalent bond
1.75	Alloy. ϵ phases. Metallic and covalent properties
2.5*	{ NiAs, FeS ₂ structures. Some metallic characteristics.
3.0*	
4.0	AX compounds. Ionic or covalent or intermediate
4.8	A_2X_3 compounds. Ionic oxides
5.3	AX_2 compounds. Ionic or covalent. Layer lattices, with molecular bonds between layers
6.0	AX_3 compounds. Ionic or covalent forces. Usually layer lattices, with molecular forces between layers
6.4	AX_4 compounds. Molecular lattices and weak intermolecular forces
Up to 7.0	Compounds of two electronegative elements. Molecular lattices. Covalent intramolecular bonds; van der Waals intermolecular bonds

* If the valence of the transition element is assumed to be zero, an assumption now generally made but which may not be justified.

other metals may be assumed to be characterized by the metallic bond in its purest form. But there are innumerable compounds

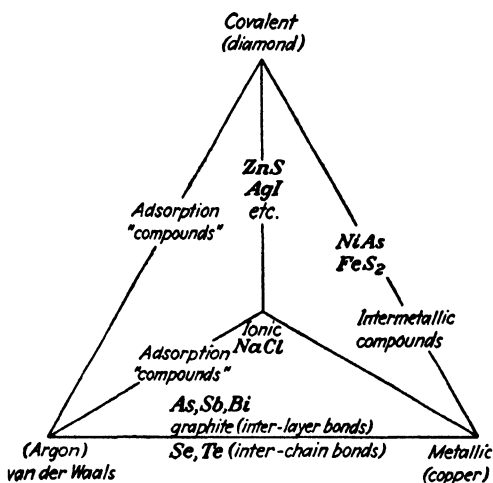

FIG. 34.—Classification of crystal structures according to type of binding force. Intermediate bond types.

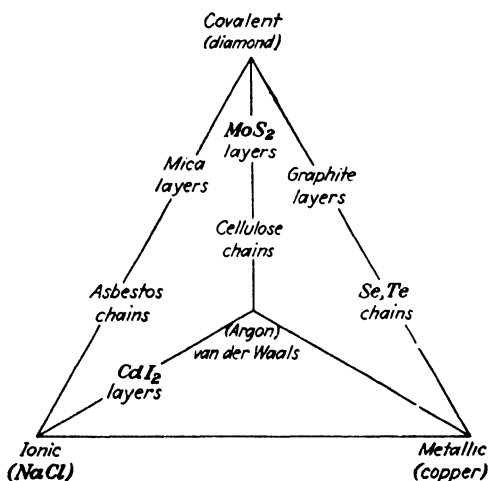

FIG. 35.—Classification of crystal structures according to type of binding force. Chain and layer structures.

in which the bond types are mixed. These may be intermediate bond types in the sense in which they usually occur in crystals with the ZnS structure; the bonds are equivalent in all directions,

but a bond is intermediate in the sense that it is the average of an ionic component and a covalent component. In the layer lattices and in molecular crystals like SnI_4 , the bond types may be said to be mixed, but they are not superimposed; the intramolecular Sn-I bonds are essentially covalent, while the bonds between molecules are weak van der Waals' forces. Such compounds cannot be classified by one of the pure bond types; their properties are not characteristic of the ionic, covalent, or metallic bond, but of combinations of these.

Some of the more important crystal structures which have been described may be graphically classified, according to the type of bonds holding their building units together, as in Figs. 34 and 35. The four principal bond types are typified by NaCl (ionic), diamond (covalent), copper (metallic), and argon (molecular forces). On the framework in Fig. 34 may be placed the structures with average bond types (as in ZnS, etc.). Figure 35 shows the relationship of structures with two or more coexistent bond types (as in SnI_4 , etc.); the intermediate types are not representative of a gradual transition of bond type within the crystal but are those in which one type of bond, predominating in two crystallographic directions, coexists with a second bond type predominating in the third direction. They are the layer and chain lattices. One may observe at a glance the nature of the bonds in any compound which appears on the chart. Thus, the position of AgI indicates that the bonds are covalent-ionic; while that of intermetallic compounds is indicative of the metallic-homopolar properties characteristic of these phases. The NiAs structure has metallic properties; and the residue of the attractive forces within this crystal type probably tends toward the covalent.

Structures of elements and of certain complex compounds have been included in these charts as a matter of interest.

There appears to be no logical place on either of these charts for the simple molecular lattice, like CO_2 or SnI_4 , in which covalent and van der Waals' forces extend between different structural units, but both types are common to all three directions.

The transition van der Waals \rightarrow covalent, in Fig. 34, has recently been discussed in a most interesting manner by Glockler

and others. The question has arisen as to whether the association of Kr and HCl should be considered as chemical combination, and the substance Kr-HCl accepted as a true molecule. Commenting upon this, and in answer to a criticism of Hildebrand and Wood,¹ Glockler² points out that a molecule is "any configuration of two or more atoms, simple molecules or radicals which show a potential minimum." This includes coordination compounds³ and simple compounds of polar and nonpolar types. Glockler suggests that the classification of forces between atoms as covalent, van der Waals, and others is arbitrary and artificial. He visualizes a continuous series of compounds; at one end He-He (van der Waals' forces only), at the other extreme H₂ (pure covalent forces) (but see page 168). In the middle, one cannot tell whether covalent or van der Waals' forces predominate. It is not justifiable to rule, therefore, that at a certain position in the series molecules cease to exist; rather, the weakly bound complexes should be included as molecules. Although the magnitudes of van der Waals' energy and bond energy are usually of different orders, the quantum mechanical treatment does not necessarily recognize any sharp difference in the nature of these two types of attractive force. Both the physical type of cohesion and the chemical type are essentially electrostatic in origin. Indeed, it may be entirely possible for the van der Waals' attraction to be of the same order of magnitude as bond energies in the case of very large molecules.⁴ This view, of course, bears directly upon the long disputed question as to where, from the standpoint of combining forces, adsorption ceases and compound formation begins. Glockler rules that such associations as Kr-HCl, Ar-KCl, and oxygen adsorbed on tungsten should be considered as molecules. Along the line "covalent-molecular," then, in Fig. 34 may be placed many adsorption complexes. Others, such as those resulting from

¹ HILDEBRAND, J. H., and S. E. WOOD, *J. Chem. Physics*, **2**, 822 (1934).

² GLOCKLER, G., *J. Chem. Physics*, **2**, 823 (1934).

³ HUNTER, R. F., and R. SAMUEL, *J. Soc. Chem. Ind., Chemistry & Industry*, pp. 31, 467 (1935), have discussed the case of covalent and van der Waals' forces in coordination compounds, claiming that in many, such as AlCl₃·xNH₃, KF·HF, and others, van der Waals' forces prevail.

⁴ DUSHMAN, S., and F. SEITZ, *J. Phys. Chem.*, **41**, 246 (1937).

preferential adsorption on the faces of ionic crystals,¹ probably belong along the "ionic-molecular" line.

The crystalline structure of a solid—the arrangement of, and the distance between, its building stones, and the kinds of forces holding them together—affects profoundly its properties. In the next chapter the properties of binary compounds will be considered in the light of the structures which have been described.

¹ See, for example, KOLTHOFF, I. M., *J. Phys. Chem.*, **40**, 1027 (1936); SAYLOR, C. H., *J. Phys. Chem.*, **32**, 1441 (1928).

CHAPTER VI

THE PROPERTIES OF BINARY COMPOUNDS

As we study the influence of the structure of a solid upon its properties, it is well to have a clear understanding of the general picture of a crystalline solid. We shall approach the subject from the standpoint of crystals in which the bond is predominantly ionic, since the more familiar inorganic binary compounds fall in this group.

In an ionic crystal, the forces which determine its strength or stability are largely electrostatic; the interionic distances and the crystal radii of the ions are determined by an equilibrium between this coulomb force, the attractive force of oppositely charged particles, a small van der Waals' attractive force, and the repulsive interaction between electrons resulting from the overlapping of electron clouds as two nuclei approach each other. The relative magnitude of the ionic forces may be predicted in a general way from properties of the ions—their size, valence, and electronic structure. The magnitudes of the ionic forces determine the strength and stability of the crystal. It follows that any properties, physical or chemical, which have any relation to the building up or tearing down of the crystal must be dependent upon the strength and, in turn, upon the size, valence, and structure of the ions of which the crystal is composed. Such properties are:

Lattice energy	Compressibility
Heat of formation	Hardness
Heat of sublimation	Ionization
Heat of combustion	Melting point, boiling point
Heat of hydration	Solubility
Hydrolysis, acidity, basicity	

As the nature of the bond departs from the pure ionic and the bond is more or less homopolar, certain characteristic properties suggest, in a very general way, a loosening of the electrons of the bond holding the ions together. We shall find that this

partial change in bond type is related to such properties as ionic diffusion, color, photochemical sensitivity, and photoelectric conductivity. Many of the properties which measure the strength of crystals are also affected.

In the following pages, an attempt will be made to correlate with the size of the ions or atoms and the nature of the bonding force¹ some of the important properties of crystals predominantly ionic; and to show that it is possible, in general, to predict the properties of any binary compound from these known properties of its building stones. Some of the very fundamental relations between ionic structure and properties will be considered rather superficially, since their detailed treatment is somewhat involved. It must be remembered that the main purpose is to demonstrate the general usefulness of the principles of crystal chemistry, and to this end the relation between ionic structure and the so-called "macroscopic" properties of compounds (melting point, boiling point, solubility, hardness, hydrolysis, acidity, color, photochemical sensitivity, etc.), which are familiar to the average student of inorganic chemistry, will be emphasized.

Lattice Energy.—The lattice energy of an ionic crystal is the energy change when a number of positive and negative ions, separated by an infinite distance, are brought together in a crystal lattice, separated by the finite distance r , the interionic distance in the crystal. The attractive force of two oppositely charged ions with valences Z_1 and Z_2 and at a distance r from each other is $Z_1Z_2e^2/r$, where e is the unit of electrical charge (4.770 e.s.u.). But in a crystal lattice, we must consider more than two ions. In the NaCl structure, for example, each sodium ion is coordinated to 6 chloride ions in the first sphere and 12 sodium ions in the next sphere, 8 chloride ions in the third, and so on. These interact upon each other in such a way that the potential

$$\phi = \frac{-e^2}{r} \left(\frac{6}{1} - \frac{12}{\sqrt{2}} + \frac{8}{\sqrt{3}} \dots \right)$$

in which the summation is endless. This summation does not

¹ Again, properties inconsistent with the normal ionic bond may be viewed as the result of the influence of polarization or of a growing covalent bonding force. In general, the latter interpretation is to be preferred.

depend upon the distance between ions in the crystal, but only upon the geometric arrangement of these ions. It may be represented by a constant A , known as the Madelung constant,¹ the value of which depends upon the crystal lattice, as shown in Table 65. The attractive potential, then, of ions in a crystal lattice may be written

$$\Phi = -\alpha^2 e^2 \mu \frac{A}{r}$$

where α is the largest common factor of the valences of the ions, and μ is the number of molecules in the unit cell.

But there is also a repulsive force between neighboring ions of opposite charge, the influence of which is to be considered in determining the lattice energy. This repulsive force is similar to that operating between atoms in a noble gas which give rise to the b term in van der Waals' equation.

In a crystal in equilibrium, the attractive and repulsive forces must be balanced, and this balance is related to the distance r between the ions. The repulsive forces may be assumed to decrease as the distance r increases. Taking this force into consideration, the following expression may be derived² for the lattice energy of a crystal:

$$U = \frac{\alpha^2 e^2 N A}{R_0} \left(1 - \frac{1}{n} \right) \quad (1)$$

where R_0 is the characteristic equilibrium distance, N is the Avogadro number, and n is a constant determined from the compressibility of the crystal. Values for n have been obtained for the alkali halides by several investigators, as shown in Table 66. It is evident that n depends upon the size of the ions.

Recently a new expression for lattice energy has been derived³ in which the n th power repulsive term is replaced by an exponential term. A term also is added to include the van der Waals' attraction energy between the ions.

¹ MADELUNG, H., *Z. Physik*, **19**, 524 (1918).

² For a detailed treatment of this derivation, see Jack Sherman, *Chem. Rev.*, **11**, 98 (1932); A. E. van Arkel and J. H. de Boer, "Chemische Bindung," Chap. III, S. Hirzel, Leipzig, 1931.

³ BORN, M., and J. E. MAYER, *Z. Physik*, **75**, 1 (1932).

Consider how the lattice energy varies with the structure and arrangement of the ions in a crystal.

TABLE 65.—MADELUNG CONSTANTS*
Structure

	A_{∞}
NaCl.....	2.201785
CsCl.....	2.035356
Sphalerite.....	2.38309
Wurtzite.....	2.386
Fluorite.....	7.33058
Rutile.....	7.70
Anatase.....	8.04
CdI ₂	6.21
β -Quartz.....	9.5915
Corundum.....	45.825

* SHERMAN, JACK, *Chem. Rev.*, **11**, 93 (1928).

TABLE 66.—REPULSIVE EXPONENTS FOR ALKALI HALIDES*

	n_{\dagger}	n_{\ddagger}	n_{\S}	H
LiF	5.9	6.0	He 5
LiCl	8.0	7.0	Ne 7
LiBr	8.7	7.5	Ar, Cu ⁺ 9
NaCl	9.1	9.0	8.0	Kr, Ag ⁺ 10
NaBr	9.5	9.0	8.5	Xe, Au ⁺ 12
NaI	...	10.0	9.5	

* The table is reproduced from Jack Sherman, *Chem. Rev.*, **11**, 93 (1932). Pauling's values have been averaged from the suitable values in the last column, thus Na⁺ has the Ne configuration and Br⁻ the Kr, hence n for NaBr is found to be $(7 + 10)/2 = 8.5$, as given under Pauling.

† SLATER, J. C., *Phys. Rev.*, **23**, 488 (1924).

‡ LENNARD-JONES, J. E., *Proc. Roy. Soc. (London)*, **A106**, 441, 463, 709 (1928).

§ PAULING, LINUS, *J. Am. Chem. Soc.*, **49**, 765 (1927).

Evidently the valence is the most significant term in the equation for lattice energy; U increases with an increase in valence as a result of the increase of α^2 . In a rather indirect manner an increase in valence also increases A in some cases as shown in Table 65. Lattice energy also increases as the distance R between the ions decreases; it increases with decreasing cation and anion radii. Small ions can be closer together, and, as the distance between them decreases, the attractive force increases. That the effect of the valence upon lattice energy is much greater than that of interionic distance is shown by the following com-

TABLE 67.—DATA FOR THE BORN-HABER CYCLE FOR TYPICAL BINARY COMPOUNDS*

Crystal.....	a_0	n	U_0	U	Q	I	S	D	E
LiF	4.02	6.0	238.9	240.1	144.7	123.8	38.3	32.2	98.9
NaF	4.619	7.0	213.8	215.0	136.6	118.0	26.0	32.2	97.8
KF	5.33	8.0	189.2	190.4	134.5	99.6	21.7	32.2	97.6
RbF	5.63	8.5	180.6	181.8	132.8	95.9	19.9	32.2	99.0
CsF	6.008	9.5	171.6	172.8	131.5	89.4	19.1	32.2	99.4
LiCl	5.143	7.0	192.1	193.3	97.5	123.8	38.3	28.9	95.2
NaCl	5.628	8.0	179.2	180.4	98.2	118.0	26.0	28.9	90.7
KCl	6.277	9.0	163.2	164.4	104.9	99.6	21.7	28.9	90.7
RbCl	6.54	9.5	157.7	158.9	104.9	95.9	19.9	28.9	90.7
CsCl	4.11	10.5	147.7	148.9	106.6	89.4	19.1	28.9	96.1
LiBr	5.49	7.5	181.9	183.1	83.7	123.8	38.3	26.9	89.6
NaBr	5.982	8.5	170.5	171.7	86.3	118.0	26.0	26.9	85.6
KBr	6.586	9.5	156.6	157.8	94.2	99.6	21.7	26.9	84.6
RbBr	6.854	10.0	151.3	152.5	96.1	95.9	19.9	26.9	86.3
CsBr	4.28	11.0	142.3	143.5	97.5	89.4	19.1	26.9	89.4
LiI	6.00	8.5	169.5	170.7	65.0	123.8	38.3	25.4	81.8
NaI	6.462	9.5	159.6	160.8	69.5	118.0	26.0	25.4	78.1
KI	7.05	10.5	147.8	149.0	78.9	99.6	21.7	25.4	76.6
RbI	7.32	11.0	143.0	144.2	80.8	95.9	19.9	25.4	77.8
CsI	4.56	12.0	134.9	136.1	83.9	89.4	19.1	25.4	81.7
MgO	4.208	7.0	938.9	940.1	146	520.6	36.5	59.2	-178
CaO	4.802	8.0	840.9	842.1	151.7	412.9	47.5	59.2	-171
SrO	5.15	8.5	789.7	790.9	141	383.8	39.7	59.2	-167
BaO	5.53	9.5	745.8	747.0	133	349.0	49.1	59.2	-157
MgS	5.19	8.0	777.1	778.3	82.2	520.6	36.5	66.6	-72.4
CaS	5.68	9.0	720.6	721.8	114	412.9	47.5	66.6	-80.8
SrS	6.01	9.5	686.2	687.4	113	383.8	39.7	66.6	-84.3
BaS	6.37	10.5	654.7	665.9	111	349.0	49.1	66.6	-80.2
CaSe	5.912	9.5	697.6	698.8	88.4	412.9	47.5	55	-95
SrSe	6.23	10.0	665.9	667.1	90.1	383.8	39.7	55	-99
BaSe	6.59	11.0	635.9	647.1	88.2	349.0	49.1	55	-96

Crystal.....	n	U_0	Q	I	S	$E-D$	U_{exp}	U_{theor}	ΔU
AgF	8.5	206.7	48.7	173.6	67	66.3	223.0	207.9	15.1
MgF ₂	7.0	695.0	264.3	520.6	36	132.6	688.8	696.8	-8.0
CaF ₂	8.0	615.9	289.4	412.9	47	132.6	617.2	617.7	-0.5
SrF ₂	8.5	585.7	289.3	383.8	39	132.6	580.2	587.5	-7.3
BaF ₂	9.5	554.6	281.6	349.0	49	132.6	547.1	556.4	-9.3
MnF ₂	8.0	654.5	170.9	532.5	74	132.6	645.0	656.3	-11.3
FeF ₂	8.0	655.9	154.2	560.9	94	132.6	676.3	657.7	18.6
CuF ₂	8.0	691.8	160.7	578.9	82	132.6	692.9	689.6	-4.7
NiF ₂	8.0	695.3	187.8	593.3	85	132.6	733.5	697.1	36.4
CdF ₂	8.5	626.9	172.5	594.6	27	132.6	661.9	628.7	33.0
PbF ₂	9.5	578.9	159.4	515.5	47	132.6	589.7	580.7	9.0
CuCl	9.0	204.9	32.5	177.3	82	63.6	228.1	206.1	22.0
AgCl	9.5	186.1	30.3	173.6	67	63.6	207.3	187.3	20.0
TlCl	10.5	158.1	48.7	140.2	46	63.6	170.9	159.3	11.6
SrCl ₂	9.5	491.8	197.7	383.8	40	127.2	494.0	493.6	0.4
CuBr	9.5	196.5	24.6	177.3	82	60.2	223.6	197.7	25.9
AgBr	10.0	180.1	23.9	173.6	67	60.2	204.3	181.3	23.0
TlBr	11.0	153.7	41.0	140.2	46	60.2	166.6	154.9	11.7
CuI	10.5	186.5	15.8	177.3	82	53.8	221.2	187.7	33.5
AgI	11.0	174.7	15.1	173.6	67	53.8	201.9	175.9	26.0
TlI	12.0	147.2	30.1	140.2	46	53.8	162.1	148.4	13.7
CdI ₂	11.0	475.2	48.9	594.6	27	107.6	563.1	477.0	86.1
PbI ₂	12.0	459.1	41.8	515.5	47	107.6	497.1	460.9	36.2

*SHERMAN, JACK, *Chem. Rev.*, 11, 93 (1932).

parative values. Thus, for a maximum difference in interionic distances, we have

	A-X, A	U, kg. cal.
LiF	2.008	240.1
CsI	3.95	136.1

but for a change in valence, with little change in A-X distance

	A-X, A	U, kg. cal.	Corrected energy for two ions
LiF	2.008	240.1	240.1
MgF ₂	1.99	695.0	463.4
MgO	2.10	940.1	940.1

Values for the lattice energies (and other thermal properties) of typical binary compounds are given in Table 67. An inspection of these values shows that:

1. The theoretical lattice energy is slightly higher for compounds with *B* cations than for compounds with *A* cations of the same size and valence.

2. A difference in the interionic distance does not cause so great a difference in the lattice energies of compounds with *B* cations as in the lattice energies of compounds with *A* cations. Thus

$$U_{\text{NaCl}} - U_{\text{NaI}} = 19.6$$

$$U_{\text{AgCl}} - U_{\text{AgI}} = 11.4$$

3. A comparison of U_{exp} and U_{theor} suggests the nature of the bonding forces.

This relation between *A* and *B* cations may be attributed to the fact that, partly because of the influence of the covalent bond, the *B* cations have low compressibilities (see Table 70) and therefore higher values for *n* (see Table 67). For Na⁺ (radius = 1.00 Å) *n* = 7, while for Ag⁺ (radius = 1.00 Å), *n* = 10. From Equation (1) it may be seen that an increase in *n* causes a slight increase in *U*, and that since the term $1 - \frac{1}{n}$ becomes nearer unity, an increase in *n* also reduces the effect of a change in the other terms of the equation upon the value of *U*.

The influence of crystal structure upon the Madelung constant and thus upon lattice energy is evident from Table 65.

Heats of Formation.—When two elements unite to form a compound, a definite amount of heat is evolved, known as the chemical heat of formation. This is a fair measure of the stability of a compound¹ because, to decompose it into its uncharged elements, the same amount of heat must be added. In building a compound from its elements there are several energy changes, the magnitudes of which may be given in heat units. These changes are represented by the Born-Haber cycle.

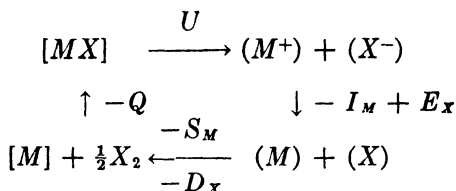

where S_M = heat of sublimation of the metal, D_X = heat of dissociation of the nonmetal, I_M = ionization potential of the metal, E_X = electron affinity of the nonmetal, U = lattice energy of the crystal, and Q = heat of formation. In accordance with the law of the conservation of energy, the total energy change must be zero, *i.e.*,

$$-Q = S + D + I - E - U$$

In Table 68 is shown the part played by each of these terms in determining the heats of formation or stabilities of typical binary compounds. A positive sign means that energy is absorbed in the process; a negative that energy is evolved.

These compounds have been chosen to show the trend of the terms involved, with the ionic properties; size, valence, and electronic structure. A comparison of NaCl and KCl suggests variations in the terms with the size of the cation, whereas a

¹ More precisely, the free energy of formation measures the stability, but the heat of formation is adequate in most cases and is a more convenient quantity to use:

$$F = Q - TS,$$

where F = free energy, Q = heat of formation, and TS = an entropy term.

comparison of KCl and KI shows the effect of a change in the size of the anion. A comparison of NaCl and BaO indicates the influence of valence and a comparison of NaCl and AgCl shows the effect of the electronic structure of the ion. Of course, to establish a definite trend, a longer list of compounds must be

TABLE 68.—THE BORN-HABER CYCLE FOR TYPICAL IONIC COMPOUNDS*

	<i>S</i>	<i>D</i>	<i>I</i>	<i>E</i>	<i>U</i>	<i>Q</i>	<i>A-X, A</i>	<i>R_A, A</i>	<i>R_X, A</i>
NaCl	26	29	118	- 91	-180	- 98	2.81	1.00	1.81
KCl	22	29	100	- 91	-164	-105	3.14	1.33	1.81
KI	22	25	100	- 79	-148	- 79	3.53	1.33	2.20
AgCl	67	29	174	- 91	-207	- 30	2.77	1.13	1.81
BaO	49	59	349	-171	-747	-133	2.77	1.31	1.40

* Values for *S*, *D*, *I*, *E*, *U*, and *Q* are in kilogram calories.

examined. Table 67 shows such a list, from which it may be observed that there are very definite relations between the nature of the ions in a compound and the magnitude of the thermochemical properties tabulated.

The heat of sublimation *S* and the heat of dissociation *D* are not, of course, properties of the ions. The former is concerned with the metallic state and varies directly with the melting point of a metal, as may be seen from the data in Table 69. These terms are relatively small and show little variation.

Evidently ionization potential *I* and electron affinity *E* are very important in their influence upon the stability of a crystal. For ions of equal valences, the more easily a metal atom gives up its valence electrons, and the greater the attraction of a negative atom for electrons, the greater will be the heat of formation and stability of the compound.

The ionization potential of a metal decreases as the size of the cation increases; K⁺ has a lower ionization potential than Na⁺. A comparison of the data for NaCl and BaO shows that *I* increases with the valence of the ion. *I* is evidently greater for *B* cations than for *A* cations, as may be seen by comparing NaCl and AgCl.

The electron affinity *E* of the negative element usually cannot be determined directly. It is calculated from the Born cycle when the other terms are known. For the halogens, *E* decreases

as their size increases, *i.e.*, the smaller halogen tends to form the most stable crystalline halide, other things being equal. The electron affinities of the divalent O⁻, S⁻, and Se⁻ are opposite in sign to those of the halogens, because heat is absorbed in attaching a second electron to a particle already made negative by the addition of the first electron.

TABLE 69.—THERMAL DATA FOR METALS*

Metal	Melting point °K.	Heat of fusion	Heat of vaporization	Heat of sublimation	
				at 25°C.	at 0°K.
Aluminum.....	932	2.35	52	55	55
Antimony.....	903	4.5	43	49	
Arsenic.....	1090	5.6	23.2	30.4	
Barium.....	931	1.40	46	49.1	
Cadmium.....	595	1.50	25.2	27.2	27.2
Calcium.....	1083	3.14	42.6	47.5	47.4
Copper.....	1356	2.70	77.0	81.9	81.6
Gold.....	1336	3.15	85.0	91	91
Lead.....	600	1.20	46	47.4	47.6
Magnesium.....	923	1.70	33.6	36.5	36.3
Mercury.....	234.4	0.55	14.7	15.2	15.4
Molybdenum.....	2895	8.38	140	155	155
Nickel.....	1725	4.25	77	85	
Palladium.....	1822	3.65	110	118	
Platinum.....	2046	6.26	116	125	125
Potassium.....	336	0.57	21	21.6	21.8
Rubidium.....	311	0.55	19.3	19.9	
Silicon.....	1688	3.71	79	85	84
Sodium.....	371	0.63	25.2	26	26
Silver.....	1234	2.60	63	67	67
Tin.....	505	1.66	75	78	78
Tungsten.....	3655	11.2	186	210	210
Zinc.....	692	1.74	29.1	31.6	31.5

* SHERMAN, JACK, *Chem. Rev.*, **11**, 136 (1932).

The heat of formation, like the lattice energy, increases as valence increases and as the radius of the anion decreases. With the decrease in the cation radius, however, the heat of formation decreases, and lattice energy increases. There are three conflicting forces in operation here, as may be seen from the data for the alkali halides in Table 67. With increasing size of the

cation, the ionization potential decreases, tending to increase stability; with increasing size of the anion, the electron affinity decreases, tending to reduce stability; and the resulting increase in interionic distance makes for a smaller lattice energy.

Consider again the equation for the Born cycle

$$Q = -I + U + E - D - S$$

and substitute for I , $(e^2/r_M)N$, which says, simply, that the ionization potential is a function of the radius of the metal, r_M . For U , substitute $e^2N/(r_A + r_X)$, since with the valences constant the lattice energy of a given crystal structure depends almost entirely upon the interionic distance. Then we have

$$Q = \left(-\frac{e^2}{r_M} + \frac{e^2}{r_A + r_X} \right) N + E - D - S$$

It is evident that if the halide is varied, as in the series NaF, NaCl, NaBr, NaI, in going from F^- to I^- , E is decreased and r_X is increased. This means that Q will be decreased. But if the size of the cation is increased, as in the series LiCl, NaCl, KCl, RbCl, then r_M increases and r_A increases only slightly faster and the term $e^2/(r_A + r_X) - e^2/r_M$ will increase. The heat of sublimation will also vary, but to a much smaller extent. Therefore, an increase in the size of the cation causes an increase in the stability (heat of formation) of the compound, but a decrease in the lattice energy, $e^2/(r_A + r_X)$.

This influence is evident in the data for U and Q in Table 67. It is also true that the hydrogen halides are less stable than the corresponding alkali halides, owing, again, to the small cations in the former. This relationship holds for a complex ion such as the trinitride. The acid is explosive; the alkaline earth salts are fairly stable [$Ba(N_3)_2$ decomposes $120^\circ C.$, $Sr(N_3)_2$ at $110^\circ C.$, $Ca(N_3)_2$ at $110^\circ C.$]. The alkali salts are still more stable, except LiN_3 , which is explosive. On the other hand, the trinitrides of the B cations are explosive. The difference in stability of the alkali and heavy metal azides may also be interpreted by means of Pauling's adjacent charge rule.¹ This rule prevents resonance to a structure where adjacent atoms have the same charge. In covalent (heavy metal) azides such a condition is possible and

¹ PAULING, LINUS, and L. O. BROCKWAY, *J. Am. Chem. Soc.*, **59**, 13 (1937).

resonance is restricted to two structures; while the ionic (alkali) azides can resonate between three structures and are therefore more stable.

The same stabilizing influence of the larger central atom may be observed in many other instances where the bonds are not particularly ionic. Consider, for example, the fourth group halides: Least stable is Cl_4 which decomposes slowly at room temperature; CF_4 is the most stable of the carbon tetrahalides. The silicon tetrahalides are more stable. SiCl_4 is stable up to 1100°C ., TiCl_4 , ZrCl_4 , and HfCl_4 decompose very little at 2000°C . The iodides are much less stable, so that one may prepare the metals directly from these compounds.¹ Mutual repulsion of the surrounding atoms increases as their sizes increase and probably accounts for the decreasing stability.

The heats of formation, contrary to the lattice energies, are less for compounds with *B* cations than for those with *A* cations of the same size and valence. The data of Table 67 suggest that this is due primarily to the large ionization potential of an 18-electron shell cation.

To summarize, a crystal may be more easily broken down into ions (*i.e.*, has a lower lattice energy): (1) the larger the anion, (2) the larger the cation, (3) the lower the valence. A compound of an *A* cation will ionize more readily than one of a *B* cation, other things being equal. A crystal has a stronger tendency to decompose into atoms (*i.e.*, has a lower heat of formation, is less stable): (1) the larger the anion, (2) the smaller the cation, (3) the lower the valence. A compound of a *B* cation is less stable than one of an *A* cation.

Compressibility.—The resistance of a crystal to compression should be determined primarily by the compactness of its building stones. The data presented in Table 70 tend to confirm this viewpoint. For the alkali halides with the NaCl structure, the compressibility increases, as one would expect, as the building stones become farther apart. For the cesium and thallos halides with the CsCl structure, the compressibilities are lower than for halides with the NaCl structure. This is consistent with the transition of the rubidium halides from the NaCl

¹ The stability of the *molecule*, discussed here, is not to be confused with the stability of the crystals of these compounds, discussed later.

structure to the CsCl structure caused by high pressure and involving a contraction of 10 to 14 per cent in volume.¹ That is, the ions in CsCl are already in a more compact arrangement than in the NaCl structure and are not condensed further by an

TABLE 70.—COMPRESSIBILITY OF SOLIDS*

	F	Cl	Br	I	O	S
Li	1.53	3.50	4.30	7.20		
Na		4.18	5.09	7.1		
K	3.30	5.65	6.68	8.56		
Rb		7.40	7.97	9.54		
Cs		5.90	7.0	9.3		
Tl		4.9	5.3	6.9		
Ag		2.40	2.74	4.11		
Ca	1.23	4.36	4.85			
Sr		3.32	4.11			
Ba		2.77	3.66			
Cd		5.95				
Zn					0.78	1.30
Pb						1.91
SnO ₂	0.49		FeS ₂	0.70		
TiO ₂	0.59		FeAsS	0.99		

* From "International Critical Tables," McGraw-Hill Book Company, Inc., New York.

external pressure as much as the ions in the NaCl structure. The compressibilities of AgCl and AgBr are lower than those of NaCl and NaBr because, although the interionic distances are comparable, the ions have already been drawn abnormally close together in the silver salts as a result of strong polarization and the influence of a covalent bond. In AgI the structure has changed from one of C.N. 6 to the ZnS structure with C.N. 4 (a less compact structure), and a higher compression is possible.

The compressibilities of the alkaline earth halides do not appear consistent, except that they are lower than the alkali

¹ BRIDGMAN, P. W., *Z. Krist.*, **67**, 363 (1928); PAULING, LINUS, *Z. Krist.* **69**, 35 (1928).

halides, a trend to be expected because of their higher valence. Whereas silver halides cannot be compressed so much as the sodium halides and SnO_2 (B cation) has a lower compressibility than TiO_2 (A cation), CdCl_2 with a B cation has a higher compressibility than CaCl_2 with an A cation. This is worth noting because CdCl_2 crystallizes in a layer lattice, a structure weak in one direction.

From the rather meager data available three observations may be made:

1. Other things being equal, the farther apart the building stones in a crystal, the more they can be compressed.
2. The more close packed the ions (the higher the coordination number), the less can they be further compressed: as illustrated by a comparison of halides with the CsCl structure (C.N. 8) with those of the NaCl structure (C.N. 6), by a comparison of AgCl and AgBr (C.N. 6) with AgI (C.N. 4), and by a comparison of the compressibility of the fluorite structure with that of the CdCl_2 layer lattice.
3. Other things being equal, the more the ions have drawn each other abnormally close together (through covalent bond influence or higher valence), the less can they be further compressed.

In short, compressibility is greatly influenced by the arrangement, the close packing, of the ions. It is influenced by the size of the ions and the nature of the bonds between them indirectly as these factors influence the crystal structure.

Hardness. Melting Points.—Although resistance to compression is determined chiefly by the compactness of the building stones of a crystal, hardness or resistance to deformation is influenced by the distance between building stones and also by the forces between them which prevent adjacent atomic planes from slipping. The breakdown of a crystal by heat (melting), on the other hand, is directly opposed only by the interionic forces. Other factors may affect the melting point indirectly, in so far as they determine the strength of the forces between ions.

The data of Tables 71, 72, 73, and 74 have been arranged to illustrate the effect of ionic size, valence, the electronic structure of the ions, and crystal structure, respectively, upon the hardness and melting points of ionic and covalent-ionic crystals.¹

¹ All values for hardness are those of V. M. Goldschmidt, *Skrifter Norske Videnskaps-Akad. Oslo.*, no. 8 (1926); the melting point data are from the

Hardness and Melting Point vs. Interionic Distance.—It is self-evident, from the data in Table 71, that the strength of a crystal, as measured by its hardness, decreases as the distance between the ions increases. This follows for ionic and covalent-ionic crystals, for series of different valences and for *A* cations or *B* cations. In general, the melting points vary in like manner.

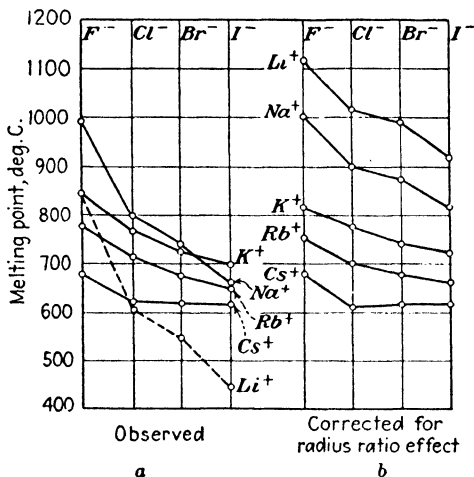

FIG. 36.—Melting points of the alkali halides. [From Pauling, *J. Am. Chem. Soc.*, **50**, 1036 (1928).]

The melting points of the alkali halides do not seem to vary consistently with the strength, as measured by hardness. They decrease regularly as the size of the anion increases, but not as the size of the cation increases. The experimental melting points have been plotted in Fig. 36*a*. Fajans¹ has accounted for these discrepancies on the assumption that the ions are deformed to some extent. Pauling² has shown, however, that if corrections are made for the radius ratio effect, the variations of the melting points are as in Fig. 36*b*. Here the melting points increase as the corrected interionic distances decrease, entirely in accordance

"International Critical Tables," McGraw-Hill Book Company, Inc., New York and N. A. Lange, "Chemical Handbook," Handbook Publishing Company, Sandusky, Ohio, 1934.

¹ FAJANS, KASIMIR, *Z. Krist.*, **61**, 41 (1925); "Radioactive Elements and Isotopes," p. 65, Cornell University Press, Ithaca, N. Y., 1932.

² PAULING, LINUS, *J. Am. Chem. Soc.*, **50**, 1036 (1928).

TABLE 71.—RELATION OF HARDNESS AND MELTING POINTS TO INTERIONIC DISTANCES

A. Univalent. A Cations. NaCl Structure. Ionic Bonds. (Hardness only. For melting points, see Fig. 36)

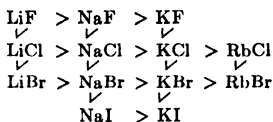

Univalent B Cations.

	F	Cl	Br	I	
Cu		2.44	2.46	2.62	Interionic dist., A Hardness, Mohs' scale Melting point, °C. Crystal structure
		2.5	2.4	2.4	
		422 ZnS	504 ZnS	605 ZnS	
Ag	2.46	2.77	2.87	2.81	Interionic dist., A Hardness, Mohs' scale Melting point, °C. Crystal structure
	435 NaCl	455 NaCl	422 NaCl	1.5 ZnS	

B. Univalent-divalent. A Cations.

B Cations.

	Mg	Ca	Sr	Ba		Zn	Cd
F	1.99	2.36	2.50	2.68	Interionic dist., A Hardness, Mohs' scale Melting point, °C.....	872	520
	4.5	4.0	3.5	3.0			
Cl	1396	1330	1190	1280	Melting point, °C.....	365	568
	712	772	873	962			
Br	700	760	643	847	Melting point, °C.....	394	580
	d	575	402				
I					Melting point, °C.....	446	385

C. Divalent. A Cations. NaCl Structure.

B Cations.

	Mg	Ca	Sr	Ba		Zn	Cd	Hg
O	2.10	2.40	2.57	2.77	Interionic dist., A.... Hardness, Mohs' scale Melting point, °C.....	1.97 5.0 1800		
	6.5	4.5	3.5	3.3				
	2800	2570	2430	1933				
S	2.59	2.84	3.00	3.18	Interionic dist., A.... Hardness, Mohs' scale Melting point, °C.....	2.35 4.0 1850	2.52 3.2 1750	2.53 3.0 subl. 446
	4.5	4.0	3.3	3.0				
	d	d						
Se	2.74	2.96	3.12	3.21	Interionic dist., A.... Hardness, Mohs' scale Melting point, °C.....	2.45 3-4 1100	2.63 3.0 1350	2.63 2.8 subl.
	3.5	3.2	2.9	2.7				
Te		3.17	3.32	3.49	Interionic dist., A.... Hardness, Mohs' scale Melting point, °C.....	2.64 3.0 1238	2.80 2.8 1041	2.79 2.6
		2.9	2.8	2.6				

D. Trivalent. A Cations.

B Cations.

AIP	AlAs	AsSb		GaP	GaAs	GaSb
2.36	2.44	2.64	Interionic dist., A..... Hardness, Mohs' scale.....	2.35	2.44	2.64
5.5	5.0	4.8		5.0	4.2	4.5

E. Tetravalent. Diamond Structure

CC	SiC	SiSi	GeGe	
1.54	1.89	2.35	2.43	Interionic dist., A Hardness, Mohs' scale Melting point, °C.
10	9.5	7.0	6.0	
3500	2700	1420	958	

d = decomposes.

with expectations. The same sort of irregularity is encountered with the melting points of the alkaline earth halides—the change in melting point does not vary consistently with variations in

TABLE 72.—VARIATION OF HARDNESS AND MELTING POINTS WITH VALENCE
A. A Cations. Ionic Structures, NaCl, CaF₂, or SnO₂

Valence.....	1-1	2-1	2-2	2-3	2-4	3-3	4-4	3-3	2-2
Compound.....	LiF	MgF ₂	MgO	Al ₂ O ₃	TiO ₂				
A-X dist., A.....	2.02	1.99	2.10	1.90	1.96				
Hardness, Mohs' scale.	3.3	4.5	6.5	9.0	6.5				
Melting point, °C.....	870	1396	2800	2050	1640d				
Compound.....	NaF	CaF ₂	CaO	ThO ₂	SeN	TiC		
A-X dist., A.....	2.31	2.36	2.40	2.42	2.23	2.23		
Hardness, Mohs' scale.	3.2	4.0	4.5	6.5	7.8	8.9		
Melting point, °C.....	992	1330	2570	2800	3180		
Compound.....	NaCl	BaF ₂	BaO	AlSb			
A-X dist., A.....	2.81	2.68	2.77	2.64			
Hardness, Mohs' scale.	2.5	3.0	3.3	4.8			
Melting point, °C.....	804	1280	1933						

B. B Cations

Compound.....	CuCl	ZnS	GaP	SiSi		
A-X dist., A.....	2.34	2.35	2.35	2.35		
Hardness, Mohs' scale.	2.5	4.0	5.0	7.0		
Melting point, °C.....	422	1850	1420		
Compound.....	CuBr	CoCl ₂	ZnSe	GaAs	GeGe	AsAl	
A-X dist., A.....	2.46	2.50	2.45	2.44	2.43	2.44	
		approx.							
Hardness, Mohs' scale.	2.4	3.4	4.2	6.0	5.0	
Melting point, °C.....	504	subl.	1100	958		
Compound.....	CuI	CdCl ₂	ZnTe	GaSb	SeCd
A-X dist., A.....	2.62	2.66	2.64	2.64	2.62
Hardness, Mohs' scale.	2.4	3.0	4.5	3.0
Melting point, °C.....	605	568	1238	1350
Compound.....	AgI	CdTe	InSb	SnSn		
A-X dist., A.....	2.81	2.80	2.79	2.80		
Hardness, Mohs' scale.	1.5	2.8	3.8			
Melting point, °C.....	552d	1041						

d = decomposes.

the size of the cations. Possibly a correction for the radius ratio effect is needed in these ionic crystals, the structures of several of which have not yet been determined. Certainly atomic arrange-

ment plays a part in this group. The sharp drop in melting point from MgF_2 to MgCl_2 , MgBr_2 , and MgI_2 may be attributed to the layer-lattice structure of the last three.

It is of considerable interest to find MgO and CaO very strong but MgS and CaS easily decomposed. There is no evidence of this weakness in either the heats of formation or the hardness of these compounds.

The high melting points of the tetravalent crystals with the diamond structure, shown in Table 71*E*, are often attributed to their high valence. However, their strengths are probably dependent largely upon the covalent bond and small interatomic distances, since the melting point of germanium (quadrivalent, if ionic) is not appreciably higher than that of univalent CuI even though the interatomic distance is somewhat larger in the latter. To find that the strength, as measured by melting point, is quite independent of valence is consistent with the existence of the covalent bond in these crystals. But consider the melting points of the divalent compounds of the *B* cations which crystallize like ZnS , shown in Table 72*B*. For constant interionic distances, the melting points are more than double those of the corresponding univalent salts. Apparently strength, as implied by melting point, increases, as does the hardness of these same compounds, with an increase in valence. This is difficult to reconcile with a covalent bond and is further evidence of the existence of a bond at least partly ionic. Of course, the melting points of the alkaline earth oxides, in which the bond is essentially ionic,¹ are more than three times those of the alkali halides.

Hardness and Melting Points vs. Valence (Table 72).—Among ionic compounds with *A* cations and crystallizing in the NaCl , CaF_2 , or TiO_2 structure, there is a rather consistent increase in strength, measured by hardness and melting points, with increasing valence. Dioxides with the rutile structure seem to have consistently low melting points; Al_2O_3 and MgS are also somewhat out of line.

¹ But see DE BOER, J. H., and E. J. W. VERWEY, *Rec. trav. chim.*, **55**, 431 (1936). The authors have calculated lattice energies of the alkaline earth oxides and believe that discrepancies with experimental values indicate a strong covalent bonding influence in this group. Of course, this evidence of bond type is, at best, only suggestive because of the approximations involved.

TABLE 73.—VARIATION OF HARDNESS AND MELTING POINT WITH ELECTRONIC STRUCTURE

Univalent	A cation;		B cation;	
	NaCl structure	ZnS structure	NaCl structure	NaCl structure
Compound.....	NaF	CuCl		
A-X dist., A.....	2.31	2.34		
Hardness, Mohs' scale.....	3.2	2.5		
Melting point, °C.....	992	422		
Compound.....	LiCl	CuI	AgF	
A-X dist., A.....	2.57	2.62	2.46	
Hardness, Mohs' scale.....	3.0	2.4		
Melting point, °C.....	614 ¹	605	435	
Compound.....	NaCl	AgI	AgCl	AgBr
A-X dist., A.....	2.81	2.81	2.77	2.87
Hardness, Mohs' scale.....	2.5	1.5		
Melting point, °C.....	804	552d	455	422
Uni-divalent	CaF ₂ structures TiO ₂	CaF ₂ structures TiO ₂	CdCl ₂ structure	
Compound.....	CaF ₂	CdF ₂		
A-X dist., A.....	2.36	2.34		
Hardness, Mohs' scale.....	4.0	4.0		
Melting point, °C.....	1330	520		
Compound.....	MgF ₂	ZnF ₂ MnF ₂		
A-X dist., A.....	1.99	2.04 2.16		
Hardness, Mohs' scale.....	4.5	4.0		
Melting point, °C.....	1396	872 856		
Compound.....	SrF ₂	PbF ₂		CdCl ₂
A-X dist., A.....	2.58	2.58		2166
Hardness, Mohs' scale.....	3.5	3.2		
Melting point, °C.....	1280	855		568
Compound.....	MgCl ₂ (CdCl ₂ struct.)			MnCl ₂
A-X dist., A.....	2.63			2.63
Melting point, °C.....	712			650
Divalent	NaCl structure	ZnS structure	NaCl structure	
Compound.....	CaO			CdO
A-X dist., A.....	2.40			2.34
Hardness, Mohs' scale.....	4.5			
Melting point, °C.....	2670			1000 d
Compound.....	SrO MgS	CdS HgS		
A-X dist., A.....	2.57 2.59	2.52 2.53		
Hardness, Mohs' scale.....	3.5 4.5-5	3.2 3.0		
Melting point, °C.....	2430 d	1750 446 subl.		
Compound.....	BaO	CdTe HgTe		PbO
A-X dist., A.....	2.77	2.80 2.79		2.66
Hardness, Mohs' scale.....	3.3	2.8 2.0		
Melting point, °C.....	1923	1041		888
Compound.....	SrS CaSe			PbS
A-X dist., A.....	3.00 2.96			2.97
Hardness, Mohs' scale.....	3.3 3.2			2.8
Melting point, °C.....	d d			1120
Compound.....	BaS			PbTe
A-X dist., A.....	3.18			3.22
Hardness, Mohs' scale.....	3.0			2.3
Melting point, °C.....	d			917
Ditetravalent:	A cation		B cation	
Compound.....	SiO ₂			GeO ₂
A-X dist., A.....	1.72			1.77
Hardness, Mohs' scale.....	7.0			5.0
Melting point, °C.....	1700 approx.			1100
Ditriavalent:				
Compound.....	Al ₂ O ₃			Fe ₂ O ₃
A-X dist., A.....	1.90			2.10
Hardness, Mohs' scale.....	9.0			
Melting point, °C.....	2050			1560
Trivalent:				
Compound.....	AlP AlSb AlSb			GaP GaAs GaSb
A-X dist., A.....	2.34 2.44 2.64			2.35 2.44 2.65
Hardness, Mohs' scale.....	5.5 5.0 4.8			5.0 4.2 4.5
Tetavalent:				
Compound.....	TiC(NaCl) SiSi(ZnS)			GeGe(ZnS)
A-X dist., A.....	2.23 2.35			2.43
Hardness, Mohs' scale.....	8-0 7.0			6.0
Melting point, °C.....	3180			958

d = decomposes.

For *B* cations, hardness increases regularly with valence. Melting point increases with valence up to the tetravalent metals if we except CoCl_2 and CdCl_2 , weak layer lattices.

Hardness and Melting Point vs. Electronic Structure (Table 73). In comparing the relative hardness and melting points of *A* and *B* cations, the other variables, valence, crystal structure, and interionic distance, have been held constant. Without exception the compounds of *B* cations are weaker, in respect to both hardness and melting points, than are the *A* cation compounds. It will be recalled that these compounds also have lower heats of formation and their instability was attributed principally to the difficulty with which the cation ionizes. In short, we are dealing with an intermediate covalent-ionic bond which has the attributes of a loosened or weakened bond.

Hardness and Melting Point vs. Crystal Structure (Table 74).—Data on this comparison are meager and not very conclusive. The brevity of the list in Table 74 is forced by the necessity of comparing only those compounds in which the other variables, valence, interionic distance, and electronic structure, may be held constant. Several general observations may be made from this table:

1. The transition NaCl to ZnS structure apparently has little effect, either on hardness or on melting point.
2. The transition CaF_2 (SnO_2) to a layer lattice (CdCl_2 , CdI_2) is accompanied by a marked decrease in strength, as measured by melting point.
3. The NiAs structure appears to be weaker than the ZnS structure; and the FeS_2 lattice is weaker than the CaF_2 structure. It would be interesting to have more data for these groups.

One would like to know the cause of the wide variation in melting points of CrS , FeS , CoS , and NiS , all with the same interionic distance and the same valences, all transition elements, and all with the NiAs structure. The melting points do increase consistently as the number of electrons in the *M* shell decreases.

Melting Points of the Dioxides.—The dioxides of tetravalent elements form an interesting group. In Table 75 the melting points and hardnesses are compared with the interionic distances, electronic structure of the cations, crystal structures, and heats of formation.

TABLE 74.—VARIATION OF HARDNESS AND MELTING POINT WITH CRYSTAL STRUCTURE

	NaCl vs. ZnS				
	AgCl	AgBr	AgI		
Compound.....	AgCl	AgBr	AgI		
Interatomic dist., A.....	2.77	2.87	2.81		
Hardness, Mohs' scale.....	1.5		
Melting point, °C.....	455	422	552		
Compound.....	CdO	ZnS		
Interatomic dist., A.....	2.34	2.35		
Hardness, Mohs' scale.....	4.0		
Melting point, °C.....	1000 d	1850		
Compound.....	MgO	BeS		
Interatomic dist., A.....	2.10	2.10		
Hardness, Mohs' scale.....	6.5	7.5		
Compound.....	CaO	BeTe		
Interatomic dist., A.....	2.40	2.43		
Hardness, Mohs' scale.....	4.5	3.8		
Compound.....	ScN	TiC	AlP	SiSi	
Interatomic dist., A.....	2.23	2.23	2.34	2.35	
Hardness, Mohs' scale.....	7-8	8-9	5.5	7.0	
	CaF ₂ -SnO ₂		vs. CdCl ₂ -CdI ₂		
Compound.....	BaF ₂		CdCl ₂		
Interatomic dist., A.....	2.68		2.66		
Hardness, Mohs' scale.....	3.0				
Melting point, °C.....	1280		568		
Compound.....	PbF ₂		MgCl ₂	MnCl ₂	
Interatomic dist., A.....	2.58		2.63	2.63	
Melting point, °C.....	855		712	650	
	CaF ₂		vs. FeS ₂		
Compound.....	CaF ₂		FeS ₂		
Interatomic dist., A.....	2.36		2.28		
Melting point, °C.....	1330		1171		
	ZnS vs. NiAs				
Compound.....	ZnS	CoS	NiS	FeS	CrS
Interatomic dist., A.....	2.35	2.30	2.28	2.28	2.28
Melting point, °C.....	1850	1100	797	1193	1550
Compound.....	ZnSe	NiAs			
Interatomic dist., A.....	2.45	2.44			
Melting point, °C.....	-1100	968			
Compound.....	CdSe	NiSb			
Atomic dist., A.....	2.63	2.64			
Melting point, °C.....	1350	1158			

d = decomposes.

Hardness seems to decrease fairly regularly as the interionic distance increases. Not so, however, for the melting points, which are consistent with the heats of formation; they bear no relation to the interionic distances, in fact, those with the highest

TABLE 75.—MELTING POINTS AND HARDNESS OF THE DIOXIDES

Formula	A-X	Electronic structure of cation	Crystal structure	C.N.	M.P.	Hardness	Q
SiO ₂	1.73	2-8	SiO ₂	4	1670	7.0	201.4
GeO ₂	1.80	2-8-18	SiO ₂	4	1100	5.0	
MnO ₂	1.84	2-8-13	SnO ₂	6	d	6-7	126.0
VO ₂	1.93	2-8-9	SnO ₂	6	1967		209.1
TiO ₂	1.96	2-8-8	SnO ₂	6	1640 d	6-6.5	218.4
IrO ₂	1.98	2-8-18-32-13	SnO ₂	6			
OsO ₂	1.99	2-8-18-32-12	SnO ₂	6			
WO ₂	2.00	2-8-18-32-10	SnO ₂	6	Oxides in air		126.2
SnO ₂	2.06	2-8-18-18	SnO ₂	6	1127	6-7	138.1
PbO ₂	2.16	2-8-18-32-18	SnO ₂	6	290 d	5-5.5	62.4
TeO ₂	2.21	2-8-18-18-2	SnO ₂	6		3.5-3.8	78.3
ZrO ₂	2.21	2-8-18-8	CaF ₂	8	2700		178.7
CeO ₂	2.34	2-8-18-7	CaF ₂	8	1950		234.9
UO ₂	2.37	2-8-18-32-18-10	CaF ₂	8	2176		256.6
ThO ₂	2.41	2-8-18-32-18-8	CaF ₂	8	2800		330.9

d = decomposes.

melting points are the ones with the largest cations. These irregularities are somewhat reminiscent of those found for the alkali and alkaline earth halides and may be due to a radius ratio effect. Without question, the melting points, on the whole, increase as the coordination number of the crystal structure increases, those with the fluorite structure being the most stable. The melting points of SiO₂ and GeO₂ are lower, relatively, than would be expected from the small size of the cation, and the low coordination number may have some bearing upon this. There also appears to be some correlation between stability and electronic structure. Those cations with a completed 8- or 18-electron shell are, in general, the most stable. PbO₂ may seem contradictory, until one realizes that the Pb⁺⁺ is more stable than Pb⁺⁺. Among the crystals with the fluorite

structure, the relatively low melting points of CeO_2 and UO_2 are consistent with their incompletely filled outer electron shells.

The Influence of Crystal Environment upon Stability.—In a series of compounds like NaF , MgF_2 , AlF_3 , SiF_4 , PF_5 , and SF_6 , a sudden increase in volatility or decrease in melting point is a direct result of the arrangement of the ions and the distribution of the bonds in the crystal. The argument, briefly, is this: NaF and MgF_2 are typical ionic crystals, throughout which ionic bonds between oppositely charged particles extend in all three crystallographic directions. AlF_3 forms an ionic lattice, but in general the AX_3 compounds are apt to form weakened layer lattices. In SiF_4 there is the possibility of the four fluorines completely surrounding each silicon and screening it so that only a weak residual force extends from the central, electropositive silicon beyond the four electronegative fluorines to attract neighboring molecules. The SiF_4 group may exist as a molecule in the crystal lattice and the forces holding these molecular building stones together will be very weak, making for a weak crystal. To put the matter somewhat more briefly, the sudden change in stability comes at the point where the coordination number of the electropositive element becomes equal to the stoichiometric ratio of X to A in the compound formula.¹ Thus for NaF , MgF_2 , and AlF_3 , the coordination numbers characterizing the crystal structure are six or eight, while the $X:A$ ratio is 1, 2, and 3, respectively. In SiF_4 the C.N. is 4, as is the $X:A$ ratio.

The sharp change in volatility or electrical conductivity is not necessarily due to a transition from the ionic to the covalent bond, as is frequently stated,² although undoubtedly in most cases, the covalent bond assumes increasing importance. Indeed, we know that the strength of the covalent bond is of the same order of magnitude as that of the ionic bond. However, the transition is essentially one from ionic to *molecular* crystals and the decreased stability is a result of a change from ionic to weak *molecular* forces.

¹ PAULING, LINUS, *J. Am. Chem. Soc.*, **54**, 988 (1932); KOSSEL, W., *Ann. Physik*, **49**, 229 (1916).

² GRIMM, H. G., and H. WOLFF, "Handbuch der Physik," vol. XXIV, no. 2, p. 1024, Julius Springer, Berlin, 1933; SIDGWICK, N. V., "The Covalent Link in Chemistry," Cornell University Press, Ithaca, N. Y., 1933.

TABLE 76.—THE STABILITY OF TYPICAL IONIC AND MOLECULAR CRYSTALS

A. Melting Points (°C.) of Fluorides*						
LiF 870	BeF ₂ 800	BF ₃ -127	CF ₄ -80			
NaF 980	MgF ₂ 1396	AlF ₃ 1040	SiF ₄ -77	PF ₅ -83		SF ₆ -55
KF 880	CaF ₂ 1360	ScF ₃	(-65)‡ TiF ₄ (284)‡	VF ₅ (111)‡		SeF ₆

B. Melting Points and Equivalent Conductivities† of Chlorides						
LiCl 613 166	BeCl ₂ 440 0.086	BCl ₃ -107 0	CCl ₄ -22 0			Compound Melting point, °C. Equivalent conductivity
NaCl 804 133.5	MgCl ₂ 718 28.8	AlCl ₃ 194 1.5 × 10 ⁶	SiCl ₄ -70 0	PCl ₅ 148 (pressure) 0		Compound Melting point, °C. Equivalent conductivity
KCl 768 103.5	CaCl ₂ 772 51.9	ScCl ₃ 930 15	TiCl ₄ -30 0			Compound Melting point, °C. Equivalent conductivity
RbCl 715 78.2	SrCl ₂ 873 55.7	YCl ₃	SrCl ₄ 300	CbCl ₄ 194 2 × 10 ⁻⁷		Compound Melting point, °C. Equivalent conductivity
CaCl 646 66.7	BaCl ₂ 925 64.6	LaCl ₃ 907 29	HfCl ₄	TaCl ₅ 221 3 × 10 ⁻⁷	WCl ₆ 275 2 × 10 ⁻⁶	Compound Melting point, °C. Equivalent conductivity
			ThCl 810 16	UCl ₆ 567 0.34		Compound Melting point, °C. Equivalent conductivity

C. Melting and Boiling Points of Aluminum, Silicon, and Stannic Halides				
AlF ₃ 800	AlCl ₃ 183 194	AlBr ₃ 268 97.5	AlI ₃ 382 191	Compound Boiling point, °C. Melting point, °C.
SiF ₄ -77 -65	SiCl ₄ 57 -70	SiBr ₄ 153 5	SiI ₄ 290 120.5	Compound Boiling point, °C. Melting point, °C.
SnF ₄ 705	SnCl ₄ 114 -30	SnBr ₄ 202 31	SnI ₄ 340 143	Compound Boiling point, °C. Melting point, °C.

* Melting points and boiling points from "International Critical Tables," McGraw-Hill Book Company, Inc., New York.

† Equivalent conductivities from H. G. Grimm and H. W. Wolf, "Handbuch der Physik," vol. XXIV, No. 2, p. 1024, Julius Springer, Berlin, 1933. These data were originally compiled by Biltz and Klemm who, like Grimm, have published numerous papers on this subject. See *Z. physik. Chem.* and *Z. anorg. allgem. Chem.*, 1922 to 1927.

‡ Figures in parentheses are boiling points.

As a matter of fact, there is no reason to postulate that the bonds in SiF_4 are entirely different from those in AlF_3 . It has been suggested, that the bond in SiF_4 is partly ionic and partly covalent, and a measurement, by electron diffraction, of the S - F distance in SF_6 suggests that even in this compound (and in SeF_6 and TeF_6) the bond is more ionic than covalent.¹ Of course, the small fluoride ion has a strong electron affinity and thus a strong tendency to form the ionic bond.

The full effect of the weak molecular force is manifested when the size and number of the negative atoms or ions with respect to the electropositive element to which they are attached are such that the central atom may be completely surrounded and its attractive force effectively screened. Innumerable data are available to demonstrate in a convincing manner the effect of the increasing size and number of the surrounding atoms or ions upon the stability of binary compounds. Some of these are listed in Table 76. The table is practically self-explanatory, and the sudden break in strength in going from left to right along a horizontal row is readily understood. That this break occurs farther to the right for the lower rows is to be expected, for the size of the central atom is increasing from top to bottom. The boiling points of SiF_4 , TiF_4 , and VF_5 are used for comparison since the melting points of the last two are not available.

In Table 76*B*, the equivalent conductivities of the fused chlorides are given as well as their melting points. The equivalent conductivities were measured just above the melting points, except BeCl_2 , determined at 35°C . There is a sudden break in conductivity at BeCl_2 , at AlCl_3 - SiCl_4 , at SeCl_3 - TiCl_4 , etc. When a crystal melts, it breaks at its weakest link. The breakdown of a molecular crystal gives no indication of the nature or strength of the intramolecular forces. A molecular crystal may be unstable, yet the molecules of which it is built may be very stable and difficult to decompose. When the molecular TiCl_4 crystal breaks down, TiCl_4 molecules exist in the melt and the latter is, of course, nonconducting; not necessarily because the intramolecular forces are covalent, but because the mobile units in the melt are neutral molecules.

¹ BROCKWAY, L. O., and LINUS PAULING, *Proc. Natl. Acad. Sci.*, **19**, 68 (1933).

Table 76C carries on the matter from a slightly different angle. In Table 76A and B, the sudden change in properties comes with a decreasing radius of the electropositive element and the increase in the number of electronegative elements available for screening the central atom or ion. In Table 76C, the size of the electropositive central element remains constant, as does the number of surrounding electronegative elements; but the size of the electronegative elements increases, and the same abrupt change in properties occurs. Thus AlF_3 is an ionic crystal with a relatively high boiling point, while a sharp drop is encountered in AlCl_3 . The boiling point increases from AlCl_3 to AlI_3 , from SiF_4 to SiI_4 , and from SnCl_4 to SnI_4 are in accordance with the increasing molecular weights in these series. (The boiling points of the aluminum halides are higher than those of the tin halides, probably because the former are polymerized as Al_2X_6 .) Thus, if the electronegative atoms are large enough to completely surround and screen the central atom, then the boiling point increases in the series F-Cl-Br-I; but if the central atom is not surrounded by fluoride, then the boiling point decreases in the series F-Cl-Br-I until the halide becomes large enough to screen the central atom, and, from that point on, the boiling point again increases in the normal manner.

The same relation of stability to environment may be observed in a series of the oxyhalides. WOF_4 boils at 190°C ., while WOCl_4 boils at 227.5°C . One may say that in the fluoride the central atom is completely surrounded and the higher boiling point of the chloride results from its higher molecular weight. But if the central atom is not completely screened in the fluoride, one must expect the chloride to be less stable; thus VOF_3 boils at 480°C ., and VOCl_3 boils at 127°C .

Many other examples of the influence of the relative numbers and relative sizes of atoms or ions upon the stability of their compounds might be given. To mention a few, at random:

1. SF_6 is well known, but not SCl_6 . SCl_4 is the highest known chloride of sulfur, and S_2Br_2 is the highest bromide known.

2. Similarly, we have MoF_6 , but not MoCl_6 , MoCl_5 being the highest molybdenum chloride known.

3. An increase in volatility may be observed in a series of oxides as the relative sizes of the cations increase; but for the oxides,

the charges on the central atom must be six in order to have three surrounding anions, and the chances of having four screening anions are slim. This accounts, in part, for the relatively small number of gaseous oxides known. Some interesting data are shown in Table 77.

TABLE 77.—STABILITY OF TYPICAL OXIDES, AS INDICATED BY MELTING POINT, °C.

Na ₂ O subl.	MgO 2800	Al ₂ O ₃ 2050	SiO ₂ 1600	P ₂ O ₅ sub. 250	SO ₃ 16.8	Cl ₂ O ₇ explosive	
Cs ₂ O subl. 1000	BaO 1923	La ₂ O ₃ 2000	HfO ₂ 2812	Ta ₂ O ₅ d 1470	WO ₃ 2130		OsO ₄ 130

d = decomposes.

In the second row, the central atoms are larger, and the break in stability, suggesting the formation of a molecular lattice, comes farther to the right. In both series the break comes farther to the right than with the halides since the number of halide atoms per central atom may be twice the number of oxygens.

Let us summarize at this point the influence of crystal structure, of ionic properties (size, valence, and electronic structure), of bond type, and of the relative number of electronegative elements bonded to each electropositive atom upon the strength and stability of crystals as indicated by compressibility, hardness, melting point, and boiling point.

The resistance of a crystal to compression depends chiefly upon the interionic distances and the crystal structure, the arrangement of the building stones. If the distances are large and the atoms or ions loosely packed (*viz.* structures with low coordination numbers), then considerable compression may be expected.

Hardness is a measure of resistance to deformation. This is determined chiefly by the distance between atoms or ions and by the forces holding them together.

Melting point is a measure of the resistance of the crystal to disruption by heat. It is determined primarily by the strength of the bonds within the crystal. This strength, of course, is influ-

enced by interionic distance (in ionic crystals), valence, electronic structure of the ions, and the crystal structure.

The data in Tables 71 to 77 summarize the evidence supporting these generalizations.

Solubility.—Solubility also measures, in a sense, the strength or stability of a crystal.

A salt is soluble in water when the attraction of the ions for water molecules is stronger than the attraction of the ions for each other, or, to put it a bit more precisely, when the energy of hydration is greater than the lattice energy. In general, the small cations may be expected to exert a greater attraction for water than do anions, but since the water molecule is asymmetric, it may be shown that a negative ion will have a higher energy of hydration than a positive ion of the same size.¹

It is difficult to make a direct calculation of the heat of hydration (an approximation of the energy of hydration) of an ion because several layers of water surrounding the ion contribute to this value. Possibly the number of water molecules in the first layer is determined by the radius ratio rule. We may approach the heat of hydration indirectly through the relationship $-U = H + L$, where U = lattice energy, required to dissociate the solid into vapor ions; L = heat of solution at infinite dilution, the energy required to convert the solid into a dilute solution; H = heat of hydration, an approximation of the energy involved in the hydration of the vapor ions. We then have the cycle

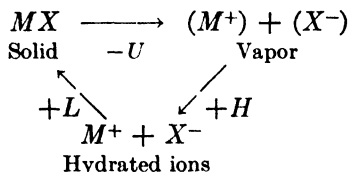

The heat of solution may be determined experimentally. The lattice energies are, of course, available. Since heats of hydration are measured at infinite dilution, in a compound AX , H_{A^+} will be unaffected by H_{X^-} . The heats of hydration of the ions are additive, so that $H_{A^+} + H_{X^-} = H_{AX}$. From the heats of hydration of the alkali halides, and similar data it has been possible to

¹ See, for example, VAN ARDEL, A. E., and J. H. DE BOER, "Chemische Bindung," p. 222, S. Hirzel, Leipzig, 1931.

compute values for heats of hydration of the ions shown in Table 78.

TABLE 78.—HEATS OF HYDRATION OF SEVERAL IONS*
(kg. cal.)

H ⁺	Li ⁺	Na ⁺	K ⁺	Rb ⁺	OH ⁻	F ⁻	Cl ⁻	Br ⁻	I ⁻
255	131	98	77	73	80 approx.	123	83	73	63

* VAN ARKEL, A. E., and J. H. DE BOER, "Chemische Bindung," p. 222, S. Hirsfel, Leipzig, 1931.

The heat of hydration increases with decreasing size of the cation or anion and with increasing valence. The heat of hydration of a *B* cation is greater than that of an *A* cation of the same

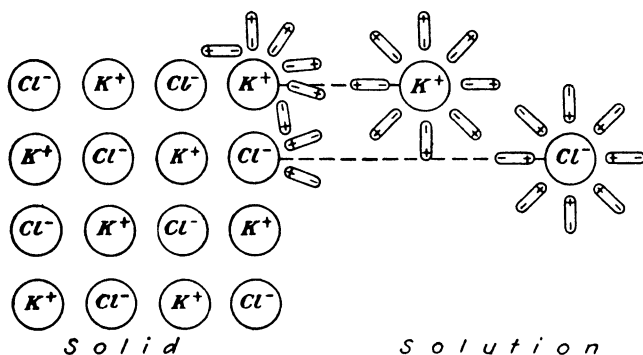

FIG. 37.—The solution of a crystal in water. (From Hildebrand, "Principles of Chemistry," 1932, by permission of The Macmillan Company, New York.)

size and valence. This is probably due to the strong polarizing effect of the former and its tendency to form a covalent bond.

Solubility may also be pictured as the result of the weakening, by the solvent, of the bonds within the crystal, according to the relation

$$F = \frac{e_1 \times e_2}{d^2 \times D}$$

where F = attractive force between ions, e_1 and e_2 = charges on ions, d = distance between ions, D = dielectric constant of solvent. Thus, water is a good solvent for ionic crystals because it is a strong dipole and has a high dielectric constant which tends to neutralize the forces between the ions. The polar water molecules surrounding a crystal may be considered to penetrate

the lattice, pry the ions apart, and carry them away, as shown schematically in Fig. 37. In many cases they are not carried far. It is rather surprising to learn, for example, that in a saturated solution of sodium chloride the sodium and chloride ions are only about twice as far apart as they are in the crystal.

Solubility and Ionic Radii.—The relation of solubility to ionic radii or interionic distances is shown for the alkali halides, in Table 79, and for the alkaline earth halides and the halides of zinc and cadmium in Table 80.

TABLE 79.—SOLUBILITIES OF THE ALKALI HALIDES (MOLES IN 1,000 PARTS WATER) AT 0°C. (UNLESS INDICATED IN PARENTHESES)

	F	Cl	Br	I
Li	0.1 (18)	16		11
Na	1.0 (15)	6.1	11	10
K	16 (18)	3.7	4.5	7.6
Rb	12 (18)	6.4	5.8	6.5 (6.9)
Cs	24 (18)	9.6	6.0 (25)	1.7

TABLE 80.—SOLUBILITIES OF THE DIVALENT HALIDES (Moles per liter)

	F	Cl	Br	I
Mg	0.0012 (18)	5.6	5.0	4.3
Ca	0.0002 (18)	5.36	6.25	6.0
Sr	0.0009	2.7	3.4	4.8
Ba	0.009	1.5	3.3	7.5 (40°C.—BaI ₂ ·2H ₂ O)
Zn	Trace	32 (25)	26 (40)	14
Cd	0.3 (25)	5	2.25	2.2

It is difficult to find any consistent trend in these data, nor is this surprising, since solubility is influenced by lattice energy and heat of hydration and these are affected differently by ionic radii.

Solubility and Valence.—With increasing valence, the lattice energy of ionic crystals increases much more rapidly than does the energy of hydration. The term $e_1 \times e_2$ in the expression $F = \frac{e_1 \times e_2}{d^2 \times D}$ also increases. Thus solubility decreases very sharply as valence increases, as shown by typical data listed in

Table 81. This table may, of course, be greatly extended, and the trend will be found to be consistent.

TABLE 81.—SOLUBILITY VS. VALENCE (A-X DISTANCES RELATIVELY CONSTANT)
(Moles per liter)

Valence.....	1-1	2-1	2-2	3-2	4-2	3-3	4-4	3-1 Layer lattice	4-1 Molecu- lar lattice
Compound.....	LiF	MgF ₂	MgO	Al ₂ O ₃	TiO ₂	ScN	TiC		
A-X dist., A.....	2.02	1.99	2.10	1.90	1.96	2.23	2.23		
Solubility.....	0.1	0.0002	0.00015	‡	‡	‡	‡		
Compound.....	NaF	CaF ₂	CaO	ThO ₂				AlCl ₃	ThCl ₄
A-X dist., A.....	2.31	2.36	2.40	2.42					
Solubility.....	1.0	0.0002	‡	‡	6.0	vs
Compound.....	NaCl	BaF ₂	BaO	PrCl ₃	SnI ₄
A-X dist., A.....	2.81	2.68	2.77		
Solubility.....	6.1	0.009	0.1	4.2	vs

vs = very soluble; ‡ = insoluble.

The influence of valence upon solubility is evident. In the first horizontal row and in the first three vertical rows are typical ionic crystals (except ScN and TiC) and, as valence increases, solubility drops rapidly; in fact, only the uni-univalent salts show an appreciable solubility, and of the halides of copper, silver, and thallium, only the fluorides. Passing from the strictly ionic crystals into the field of atomic crystals (ScN, TiC), layer lattices (AlCl₃ and PrCl₃), and molecular crystals (ThCl₄ and SnI₄), the strength of the crystal, as measured by stability, is, of course, no longer directly controlled by valence.

Solubility and Electronic Structure of the Ions.—A B cation exerts a strong polarizing effect and an increasing tendency to form the covalent bond, and the lattice energy and the energy of hydration are both higher than they are for an A cation of the same size and valence. Whether in substituting a B cation for an A cation heat of hydration or lattice energy increases to the greater extent appears to depend upon whether water or the negative ion of the compound can be more strongly polarized or favors more pronounced covalent bonding. If the anion is more

easily polarized than water, then lattice energy may be expected to increase more rapidly than does heat of hydration; and the compound with the *B* cation is less soluble. If the anion is less easily polarized than water, then the heat of hydration increases more rapidly than the lattice energy, and the solubility of the *B* cation compound is greater; *i.e.*, the *B* cation tends to form a stronger bond with water molecules than with the anions. The effect of this relationship is shown in Table 82.

TABLE 82.—SOLUBILITY VS. ELECTRONIC STRUCTURE OF THE CATION
(Grams per 100 g. water)

	F	Cl	Br	I
Na ⁺	4.0	35.7	116	158
Ag ⁺	182.0	0.000089	8.4×10^{-6}	3×10^{-7}
Tl ⁺	80	0.21	0.024	0.002
Hg ₂ ⁺⁺	Forms Hg ₂ O	0.0001	2×10^{-9}	2×10^{-8}

The fluorides (and chlorates and nitrates) of the *B* cations are more soluble than those of the corresponding alkalis, probably because water can form a stronger bond with the cation than can the fluoride ion, either through polarization or because of the contribution of covalent binding. The other halides of *B* cations are less soluble than the alkali halides because the halogen is more strongly polarized than is water.

The same sort of relation is to be found among the divalent ions. Because the anion is more strongly polarized than water (*e.g.*, O⁻, S⁻) or, as is more likely in this case, because of the growing influence of the covalent bond, the compounds of the *B* cations are less soluble than those of the *A* cations. Thus ZnO, ZnS, CdS, HgO, CuO, FeO, NiO, etc., are less soluble than CaO, BaO, CaS, and BaS. If the water is more strongly polarized than the anion, then the reverse is true; CaSO₄, SrSO₄, and BaSO₄ are less soluble than ZnSO₄ and CuSO₄. Furthermore, within the series of alkaline earth salts there are interesting variations in solubility. Compare the solubilities of the alkaline earth sulfates and hydroxides in Table 83.

Of the sulfates, MgSO₄ is the most soluble, possibly because Mg⁺⁺, being the smallest cation, has the greatest polarizing effect

on the easily polarized water. With the hydroxides, however, the reverse is true. The hydroxyl ion is more easily polarized than water, hence the smallest cation may polarize it the most and thus forms the least soluble hydroxide. MgO is less soluble

TABLE 83.—SOLUBILITIES OF ALKALINE EARTH SULFATES AND HYDROXIDES
(Grams per 100 g. water)

MgSO ₄	26.9	Mg(OH) ₂	0.0009
CaSO ₄	0.176	Ca(OH) ₂	0.185
SrSO ₄	0.011	Sr(OH) ₂	0.41
BaSO ₄	0.0001	Ba(OH) ₂	4.29

than CaO; while MgSO₄ is more soluble than CaSO₄; Mg⁺⁺ is more strongly polarizing than is Ca⁺⁺ and O⁻ is more strongly polarized than is SO₄⁻.

This polarizing influence may account, too, for the high solubility of certain salts of sodium as compared with those of potassium, rubidium, and cesium and of magnesium as compared with calcium, strontium, barium, and radium, as shown in Table 84.

TABLE 84.—SOLUBILITIES OF SOME ALKALI SALTS
(Moles per liter)

M	Na	K	Rb	Cs
MCIO ₄	<i>vs</i>	0.11	0.041	0.05
M ₂ PtCl ₆	<i>vs</i>	23 × 10 ⁻⁴	24 × 10 ⁻⁴	1.17 × 10 ⁻⁴

M	Mg	Ca	Sr	Ba	Ra
MSO ₄	2.16	7.8 × 10 ⁻³	5.3 × 10 ⁻⁴	9.7 × 10 ⁻⁶	6.5 × 10 ⁻⁶
MC ₂ O ₄	2.7 × 10 ⁻³	4.2 × 10 ⁻⁵	24 × 10 ⁻⁵	33 × 10 ⁻⁵	

vs = very soluble.

Sodium and magnesium are relatively small and strongly polarizing ions and water is polarized more easily than the ClO₄⁻, PtCl₆⁻, SO₄⁻, and C₂O₄⁻.

All this has a very interesting bearing upon our scheme of qualitative analysis as shown in Table 85. To precipitate the univalent *B* cations, we add an ion (Cl, Br, or I) which is more strongly attracted than is water. If we were to add H₂F₂ as a

first group reagent instead of HCl, the alkali cations would be precipitated at that point. The HCl does not precipitate the divalent *B* cations or any tri- or tetravalent cations because the halides of these form weak, and therefore soluble, layer or molecular lattices. To precipitate the divalent *B* cations, we add a divalent sulfide ion which will be polarized more strongly than water and tends to form a bond not so easily broken by water. This precipitates an *AX* compound, thus avoiding the formation

TABLE 85.—SCHEME OF QUALITATIVE ANALYSIS*

Reagent..	HCl	H ₂ S acid solution					(NH ₄) ₂ S				(NH ₄) ₂ CO ₃		
Ions precipitated.	Ag ⁺ Tl ⁺ Pb ⁺⁺ Hg ⁺	Cd ⁺⁺ Hg ⁺⁺ As ⁺⁺⁺ Sb ⁺⁺⁺ Bi ⁺⁺⁺ Sn ⁺⁺	Ge ⁺⁺ Sn ⁺⁺ Pb ⁺⁺ As ⁺⁺⁺ Sb ⁺⁺⁺ Bi ⁺⁺⁺	Cu ⁺⁺ Ru ⁺⁺⁺ Rh ⁺⁺⁺ Pd ⁺⁺ Os ⁺⁺ Ir ⁺⁺⁺ Pt ⁺⁺	V ⁺⁵ W ⁺⁵	Fe ⁺⁺ Co ⁺⁺ Ni ⁺⁺ Cr ⁺⁺⁺ Zn ⁺⁺ Mn ⁺⁺	Ti ⁺⁺ Zr ⁺⁺ Ce ⁺⁺ Th ⁺⁺	Al ⁺⁺ :Be ⁺⁺ Sc ⁺⁺⁺ Y ⁺⁺⁺ La ⁺⁺⁺ Ce ⁺⁺ Rare earths	Mg ⁺⁺ :Li ⁺ Ca ⁺⁺ Sr ⁺⁺ Ba ⁺⁺ Ra ⁺⁺	Na ⁺ K ⁺ Rb ⁺ Cs ⁺			
Number of valence electrons..	1-2	2-5	2-3	2-4	5-6	2-3	4	3	2	2	1	1	
Number of outer electrons	18	18	18 + 2	<i>T</i>	8	18 <i>T</i>	8	8	2	8	2	8	

T = transition ion.

Mg⁺⁺ precipitates as the carbonate only in the absence of NH₄⁺

* GRIMM, H. G. and H. W. WOLFF, "Handbuch der Physik," vol. XXIV, No. 2, Julius Springer, Berlin, 1933.

of a layer lattice. With an acid sulfide, we are able to precipitate most of the remaining *B* cations, the cations of the larger transition elements, and even the largest (*V*⁺⁵ and *W*⁺⁵) of the *A* cations. The smaller transition cations and the tri- and tetravalent *A* cations, however, are precipitated in basic solution: the precipitation of some of them depends upon the attraction by the cation of the very polarizable hydroxyl ion (see Hydrolysis) to form an insoluble hydroxide. Only the alkaline earths and alkalis are left. We expect the alkaline earths to be separated from the alkalis by a divalent anion because of the known influence of valence upon solubility.

It has, of course, become evident by this time why certain salts, particularly those of the *B* cations, can be dissolved in ammonia when they are insoluble in water. Ammonia, although a weaker dipole than water, can be more strongly polarized, and, when in a strong electric field, its induced dipole moment is greater than that of water. The *B* cations can attract ammonia

more strongly than water. The ammonia molecule $\begin{array}{c} \text{H} \\ \text{:N:H} \\ \text{H} \end{array}$ con-

tributes its extra electron pair to the bond, tending to form, in most cases, a bond with an appreciable covalent component. We find that ammonia can break down the AgCl, AgBr, and AgI lattices where water fails. Similarly, salts of Zn, Cd, and Cu form ammonia complex ions which are soluble and stable in solution. Of the *A* cations, Mg^{++} , since it is the smallest and most strongly polarizing of the alkaline earths, is soluble in ammonia.

Hydrolysis. Acids and Bases.—Salts of weak acids or weak bases, particularly those of metals whose hydroxides are insoluble, hydrolyze when dissolved in water. Now, the hydroxide ion is very easily polarized, and in accordance with the principles developed above, we may expect the hydroxides of the smaller cations and of the *B* cations to be particularly insoluble or only weakly ionized, since these are the cations which will exert the strongest polarizing influence upon the hydroxide ion. To correlate the tendency to hydrolyze with electronic structure of the ion, we need only bear in mind that those ions which can polarize the hydroxide ion most strongly are those most apt to hydrolyze. It follows that hydrolysis should take place to a greater extent with small cations than with large ones. Thus, of the fourth group chlorides ThCl_4 , HfCl_4 , ZrCl_4 , TiCl_4 , SiCl_4 , and CCl_4 , the degree of hydrolysis increases in the order ThCl_4 to SiCl_4 . ThCl_4 , in fact, hydrolyzes very little and shows considerable tendency to ionize. For the *A* cations in the second group, hydrolysis increases in the order Ba^{++} to Be^{++} .

The tendency of a compound to hydrolyze increases with the valence of its cation. Only the alkali and alkaline earth salts undergo relatively little hydrolysis. Hydrolysis is marked for the trivalent aluminum ion and others of both the *A* and *B* subgroups and is practically complete for most cations whose

valence exceeds three. The *B* cations, of course, hydrolyze more strongly than *A* cations of the same size and valence.

Acids and Bases.—All oxides form hydrates. The question arises as to why some split off hydroxide ions to form bases and others split off hydrogen ions to form acids. In a general way, the answer to this question has already been anticipated to some extent. No doubt the size of the positive ion and the nature of the bonding forces are of paramount importance in influencing the hydrated oxide to become a base or an acid. A hydroxyl ion is not attracted so strongly to a large cation of low valence as it is to a small cation of higher valence, *i.e.*, the reaction $MOH \rightarrow M^+ + OH^-$ proceeds more readily for the larger, univalent and divalent cations—the base-forming cations.

Acids and bases were discussed from a slightly different viewpoint some years ago by Kossel¹ and later by Lewis.² Consider the compound *MOH*. If *M* loses electrons easily (*i.e.*, if it is large and of low valence) the *M*-OH bond is weak and a base is formed. But if *M* has a strong attraction for electrons (*i.e.*, is small, highly charged, and tends to form an electron-pair bond), then the electron cloud around oxygen is drawn toward *M*, thus weakening the O-H bond and allowing the hydrogen to break off to form an acid.

Thus, NaOH is basic because sodium gives up its valence electron readily. ClOH is acid because the chlorine has a strong attraction for electrons and tends to draw them away from the O-H bond. Acetic acid is a weak acid; but if chlorine atoms are substituted for the hydrogens of the methyl group,

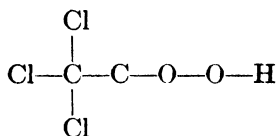

they tend to draw to themselves the outer electrons of all the atoms in the molecule. Thus the O-H bond is weakened as the number of substituted chlorines increases, and the strengths of mono-, di-, and trichloroacetic acids increase in the order named.

¹ KOSSEL, W., *Ann. Physik*, **49**, 229 (1916).

² LEWIS, G. N., "Valence and the Structure of Atoms and Molecules," p. 142, Reinhold Publishing Corporation, New York, 1923.

This sort of analysis may be carried throughout the periodic table, and, as is well known, the change "base to acid" shifts farther to the right for each succeeding period, somewhat as follows:

1. Period	LiOH	Be(OH) ₂	B(OH) ₃		
2. Period	NaOH	Mg(OH) ₂	Al(OH) ₃		
3. Period	KOH	Ca(OH) ₂	Sc(OH) ₃	Ti(OH) ₄	
		CuOH	Zn(OH) ₂		
4. Period	RbOH	Sr(OH) ₂	Y(OH) ₃	Zr(OH) ₄	Cb(OH) ₅
		AgOH	Cd(OH) ₂	In(OH) ₃	
5. Period	CsOH	Ba(OH) ₂	La(OH) ₃	Hf(OH) ₄	Ta(OH) ₅
		AuOH	Hg(OH) ₂	Tl(OH) ₃	Pb(OH) ₄

In each case the last hydroxide given is amphoteric, and the next element to come is acidic. The influence of ionic size on basicity is clearly shown. In this connection the basicity of the rare earths is of interest. La(OH)₃ is rather strongly basic, but the rare earth cations become less basic in character from lanthanum on. We see, too, that the last amphoteric hydroxide is in the fifth group in the fifth period as well as in the fourth period, since Cb and Ta are of similar sizes.

Evidently the *B* cations, exerting a greater attraction for the easily polarized hydroxyl group and having a stronger attraction for electrons than do the *A* cations, tend to prevent the hydroxyl group from splitting off to give a basic solution. We find Zn(OH)₂ amphoteric in the third *B* subgroup as compared with Ti(OH)₄ in the *A* subgroup; and In(OH)₃ in the fourth *B* subgroup as compared with Cb(OH)₅ in the *A* subgroup.

A number of useful applications of this correlation of acidity with ionic size and ionization potential might be described. To cite only one, a recent study of the acid strength of inorganic cations and the basic strength of inorganic acetates in acetic acid is an interesting case in point.¹ The dissociation of inorganic acetates in acetic acid decreases (*i.e.*, the bond, C₂H₃O₂-metal, becomes stronger) with decreasing size and increasing charge of the metal ion. The acid strength of cations in acetic acid increases with decreasing size and increasing charge of the cations.

Color of Crystals.—A crystal of copper sulfate transmits blue light because there are electrons in the crystal which change

¹ KOLTHOFF, I. M. and A. WILLMAN, *J. Am. Chem. Soc.*, **56**, 1014 (1934).

energy levels in the proper regions to absorb all the rest of the white light which enters the crystal, letting only blue light pass through. A strong ionic crystal like NaCl is colorless and transparent because all of the electrons are so tightly held that their vibration is not of the proper frequency to absorb any light passing through them. The same is true of strong covalent crystals like diamond. It is among those crystals in which intermediate bonds prevail that color is found.

The color of the ions of the transition elements has been attributed¹ to the electrons which are able to shift from the outer valence shell to the adjacent 18 shell. Similarly, as Lewis² suggested some time ago, the color of the other binary compounds may be associated with a loosening of the electron structure, characteristic of the mixed bond. He represented such a state by placing the shared electron pair nearer the negative atom; thus Ag :I, rather than halfway between (Cl:Cl), their position in the normal covalent bond. The same loosened bond is to be expected as a result of deformation when a strongly polarizing B cation combines with an easily polarized anion.³ *The colored binary compounds are restricted entirely to compounds of the transition elements and the B cations.*⁴ The relation between intensity of color and this "loosening" of the electron structure is clearly shown in Table 86. As the electrons are loosened to the point where they are able to absorb visible light, the first color produced is yellow, and with further loosening the other colors follow. The silver halides offer a typical example. The fluoride crystallizes in the NaCl structure and the F⁻ is not polarized; the salt is colorless. With the more easily polarized Cl⁻, the color appears and increases in intensity with the change Cl⁻ to Br⁻ to I⁻, which is accompanied by a loosening of the lattice. The case of ZnO is interesting. Evidently zinc is the least polarizing of the group and does not produce a colored oxide. When zinc oxide is heated,

¹ LADENBURG, R., *Naturwissenschaften*, **8**, 6 (1920); *Z. Elektrochem.*, **26**, 262 (1920).

² LEWIS, G. N., *J. Am. Chem. Soc.*, **38**, 762 (1916).

³ FAJANS, KASIMIR, *Naturwissenschaften*, **11**, 165, (1923).

⁴ But the very unstable compounds CaCl and BaCl have been prepared and, as might be anticipated, are highly colored. ABEGG, R., "Handbuch der anorganische Chemie," vol. II, pp. 105, 253, Leipzig, 1905.

however, the heat augments the loosening effect and the oxide assumes a yellow color which is lost when the temperature falls. This is not due to an allotropic change. The same type of color change is familiar in the ruby, which changes from red to green when it is heated above approximately 400°C. There is no

TABLE 86.—THE COLORS OF BINARY SALTS

	F	Cl	Br	I	O	S	SO ₄	H ₂ O	NH ₃
Na	c	c	c	c					
Cu ^{II}	c	yellow brown	brown black		black	black	c	blue	darker blue
Ag	c	faint yellow	yellow	dark yellow	brown black	black	c		
Hg	c	c	yellow	yellow					
Zn	c	c	c	c	c	c	c		
Cd	c	c	yellow	brown	brown	yellow	c		
Hg ^{II}	c	c	yellow	yellow red	red or yellow	red or black	c		
Pb ^{II}	c	c	yellow	yellow	c	black	c		
Sn ^{II}	c	c	yellow	red	c	yellow	c		

c = colorless.

evidence to indicate that this color change is due to another crystalline form.¹ That the positive ions in Table 86 are not in themselves colored is indicated by the existence of the colorless fluorides and sulfates—compounds in which the bond is more strongly ionic. It follows without question, therefore, that the color of these compounds is due to a property of the bond between the ions—a result of their interaction upon each other. Pb⁺⁺ is colorless and I⁻ is colorless; but, put them together and the brilliant yellow of PbI₂ appears.

We shall see later that the brilliant colors of many of the Werner complexes are probably due to loosened, intermediate type bonds between the metal atoms and their coordinated molecules. Cu⁺⁺, for example, is apparently colorless, but Cu(H₂O)₄⁺⁺ is blue and Cu(NH₃)₄⁺⁺ is a more intense blue. Recently the cupric hydrate of heavy water, Cu(D₂O)₄⁺⁺, has been described as greener than

¹ STILLWELL, C. W., *J. Phys. Chem.*, **30**, 1441 (1926).

$\text{Cu}(\text{H}_2\text{O})_4^{++}$, and less intense in color,¹ suggesting less loosening and less deformation of the D_2O molecule, which is to be expected.

It is evident that color appears in those substances which are characterized by a high molecular refractivity; the same loosening of electrons is responsible for both phenomena—color and high refractivity.

Electrical Conductivity by Ionic Diffusion.—The electrical conductivities of molten ionic salts are of the same order of magnitude, but the electrical conductivities of these same crystalline salts show great differences.² The order of these differences is shown in Table 87, in which the values in column 2 are the ratios of the conductivities of the melts, just above the melting points, to the conductivities of the crystals just below the melting points.³ A striking feature of these data is that the conductivity

TABLE 87.—ELECTRICAL CONDUCTIVITY IN THE REGION OF THE MELTING POINTS

(Conductivity above Melting Point/Conductivity below Melting Point)

KNO_3	20,000
LiNO_3	10,000
KCl	9,000
NaCl	3,000
TlCl	160
TlBr	130
TlI	100
AgCl	30
AgBr	5
AgI	0.9

of solid AgI is actually about 10 per cent greater than that of molten AgI .

Ionic conductivity in solids appears to bear some relation to the predominant type of bond in the crystals.⁴ This is illustrated in Fig. 38, showing the “degeneration” of a silver ion to a metallic silver atom via the solid series AgNO_3 , AgCl , AgBr , AgI , Ag_2S , Ag_2Te , Ag_3Sb , Ag_4Sn , Ag_3Au , Ag . The magnitude of the ionic conductivity, as measured by diffusion in the solid, is shown along

¹ BELL, J., *Nature*, **137**, 534 (1936).

² TUBANDT, C., and S. EGGERT, *Z. anorg. Chem.*, **110**, 196 (1920); JOFFE, A., *Ann. phys.*, **72**, 461 (1923).

³ VON HEVESY, G., *Z. physik. Chem.*, **101**, 337 (1922); *Z. Physik*, **36**, 481 (1926).

⁴ VON HEVESY, G., *Z. Elektrochem.*, **34**, 463 (1928).

the vertical axis. The region of greatest diffusion is the region of greatest loosening, the region where a mixed ionic-covalent bond is to be expected; the rate of ionic diffusion begins to decrease when the intermediate-type bond becomes predominantly covalent, and it decreases very rapidly from this point to the metallic bond.

As ionic conduction, or diffusion, decreases down the right-hand side of the curve in Fig. 38, electronic or metallic conduction

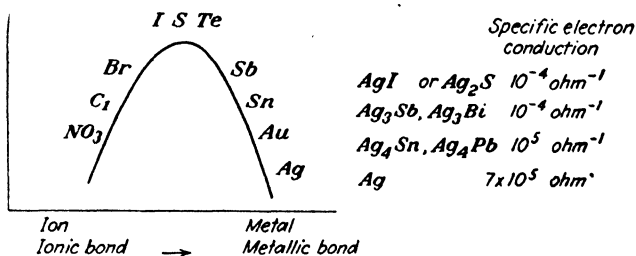
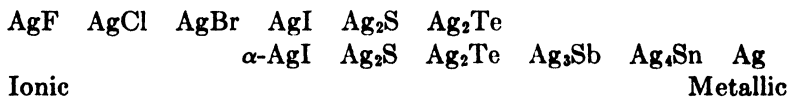

FIG. 38.—The "degeneration" of a silver ion to a metallic silver atom, as measured by diffusion in the solid (measured qualitatively along the vertical axis.) [From von Hevesy, *Z. Elektrochem.*, **34**, 463 (1928)].

increases, according to the figures at the right again evidencing the transition toward the metallic bond.

At the crest of the curve, in the region of extreme loosening of the lattice, the compounds are polymorphic, perhaps to some extent, as a result of this loosened bond. There are two crystalline forms of AgI, Ag₂S, and Ag₂Te, and the transition from the ionic to the metallic bond seems to take place, through these allotropic forms, as:



The degeneration of an anion may also be followed through the loosening of an ionic lattice and ionic bonds to the formation of a molecular lattice and covalent bonds, as shown in Fig. 39. The rates of vibration of chlorine are plotted vertically, and the transition from an ionic to a molecular lattice, as polarization and the influence of the covalent bond increase, is shown horizontally.

The transition from one extreme type to the other via a loosened lattice is evidenced by the high rate of vibration of the anion.

The mechanism of ionic conduction in solids has received considerable attention recently and the crystal structures of several compounds with relatively high ionic conductivities have been determined. Of these, α - Ag_2HgI_4 and the high temperature form of AgI are the most interesting.

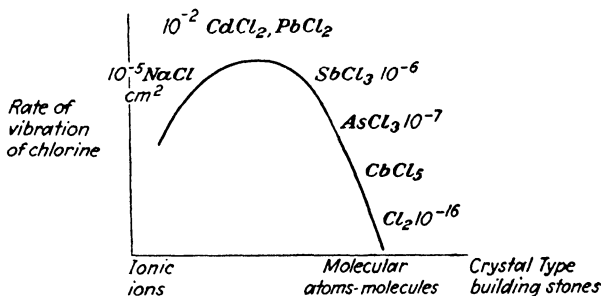

FIG. 39.—The “degeneration” of a chloride ion to a chlorine atom through the “loosening” of an ionic lattice. [From von Hevesy, *Z. Elektrochem.*, **34**, 463 (1928).]

In crystals of α - Ag_2HgI_4 , with which Cu_2HgI_4 is isomorphous,¹ the iodine atoms form a face-centered cubic lattice, in the four second largest interstices of which the two silver and one mercury atoms are statistically distributed. The structure is thus characterized by empty lattice points, to which the metal ions may move and thus carry the current.

The structure of AgI , stable above 145.8°C. is said to be even more unusual.² The iodine ions are no longer in closest packing but are on a body-centered cubic lattice. Intensity measurements suggest that the two silver atoms in the unit cell are distributed in 42 discrete symmetrical openings in the anion lattice, *i.e.*, the silver is free to take up any space available and move freely from one space to another. In a very real sense the silver is no longer in the solid state, for it is truly fluid, the rigid iodine lattice being responsible for maintaining the structure. Ag_2S and Ag_2Se are said to have structures similar to α - AgI .³

¹ KETELAAR, J. A. A., *Z. physik. Chem.*, **B 26**, 327 (1934); *Z. Krist.*, **87**, 436 (1934).

² STROCK, L. W., *Z. physik. Chem.*, **B 25**, 441 (1934); **B 31**, 132 (1936).

³ RAHLFS, P., *Z. physik. Chem.*, **B 31**, 157 (1936).

AgBr, although it does not crystallize in an "empty space" lattice (other spaces between bromine atoms are not large enough for silver atoms), is a reasonably good conductor. When AgBr acts as a conductor, the silver atoms are said to migrate into inter-lattice space, leaving empty spaces in the silver lattice, while the bromide atoms do not move.¹

Thus, the picture which has been drawn of these structures bears a certain formal resemblance to the metallic state. In the latter, electrons are free to move about somewhat in a lattice of positive ions, and electronic conductivity results. In crystals of the α -AgI type particularly, metallic cations are relatively free to move about in a lattice of negative ions, and ionic conductivity takes place.

Metallic, or electron conduction in salts must depend upon electrons released from their usual participation in ionic or homopolar bonds. Marked photoelectric conductivity, therefore, may be anticipated for those crystal lattices in which electrons in the bond are already loosened. It is these electrons which may be loosened still further, under the influence of light, to the point where they take part in metallic conduction. Accordingly, the data in Table 88 are entirely in accord with what we should expect; the salts in which conductivity may be induced by light are those of *B* cations and easily polarized anions, salts in which a covalent bond becomes influential.

TABLE 88.—PHOTOELECTRIC CONDUCTIVITY OF SOME BINARY COMPOUNDS*

	F	NO ₃	SO ₄	CO ₃	Cl	Br	I	O	S
K	—	—	—	—	—	—	—	—	—
Na	—	—	—	—	—	—	—	—	—
Ba	—	—	—	—	—	—	—	—	+
Sr	—	—	—	—	—	—	—	—	+
Ca	—	—	—	—	—	—	—	(—)	+
Tl	—	—	—	+	+	+	+	+	+
Ag	—	—	—	+	+	+	+	+	+
Pb	—	—	—	+	+	+	+	+	+
Cu	—	—	—	—	—	(+)	+	+	+
Hg	—	—	—	(+)	—	—	+	+	+

* GUDDEN, B., and R. POEL, *Z. Physik*, **16**, 42 (1923).

¹ WAGNER, C., and J. BEYER, *Z. physik. Chem.*, **B 32**, 113 (1936).

Photosensitivity.—Without question, the marked photosensitivity of the silver halides bears some relation to their loosened lattice structure. It is interesting to recall that ZnS, a part of lithopone, darkens on exposure to light but regains its white color when kept in the dark. Various explanations have been offered for this very practical difficulty. In this case also the photosensitivity probably is related to a loosened, intermediate bond.

Properties of NiAs and FeS₂ Structures.—Until now, our discussion has been principally of ionic crystals. It has been shown incidentally that molecular crystals are relatively weak, and in Table 74 the suggestion is given that crystals of the NiAs and FeS₂ structures are weaker, other things being equal, than ionic or covalent crystals. The crystals of this type are also insoluble in water, since they do not ionize readily. They are apt to be soft. Their metallic properties are striking; they tend to be opaque with metallic luster, and, perhaps most characteristic of all, they are able to dissolve an appreciable excess of either component. By their electrical properties they may be distinguished both from ionic and from metallic compounds. Their electrical conductivity is appreciable—which is not true of most ionic compounds. In contrast to metallic compounds, however, their conductivity increases rapidly with the addition of impurities; whereas in a metallic compound, the conductivity is a maximum when it is pure and decreases rapidly as impurities are added.

Atomic Crystals of Binary Compounds.—Normal covalent crystals—and it is by now apparent that there are very few among the inorganic binary compounds—are relatively strong, as evidenced by the yardsticks used in this discussion, *viz.*, hardness, melting points, solubility, and so on. SiC, TiC, ScN are typical examples.

Summary.—The influence of the structure of a crystal and of the size, valence, and electronic structure of its building stones upon some of the physical and chemical properties of binary compounds, has been considered at length.

These relationships, dealing mainly with ionic crystals, may be summarized briefly as follows:

1. Lattice energy, the measure of the tendency of an ionic crystal to break down into ions,

- a. Increases with decreasing size of the cation.
- b. Increases with decreasing size of the anion.
- c. Increases with decreasing interionic distance.
- d. Increases with valence.
- e. Is greater for *B* cation compounds than for those with *A* cations.

2. Heat of formation, a measure of the tendency of a crystal to break down into atoms or molecules,

- a. Increases with increasing size of the cation.
- b. Increases with decreasing size of the anion.
- c. Increases with valence.
- d. Is greater for compounds of *A* cations than for those of *B* cations.

3. Compressibility, a measure of resistance to compression,

- a. Is greater, the farther apart the ions or atoms in a crystal.
- b. Is greater, the less close packed the structure, the lower its coordination number.
- c. Decreases as polarization or valence decreases.
- d. Decreases as the influence of the covalent bond increases.

4. Hardness, a measure of the resistance to deformation,

- a. Increases with decreasing interionic or interatomic distance.
- b. Increases with valence.
- c. Is greater for compounds of *A* cations than for those of the *B* cations.

5. Melting point, a measure of the resistance to disruption by heat,

- a. Increases with decreasing size of the anion.
- b. Varies irregularly with the size of the cation until corrected for the radius ratio effect.
- c. Increases with valence.
- d. Is greater for compounds of *A* cations than for those of *B* cations.
- e. Is lower for layer lattices than for typical ionic lattices; and is lowest for molecular crystals.
- f. Decreases as the number of anions per cation in the compound increases, *i.e.*, depends upon the crystal environment.
- g. Is lower for the NiAs and FeS₂ structures than for ionic lattices, other variables being equal.

6. Solubility in water, a measure of the resistance of an ionic lattice to disruption by the hydration of its ions,

- a. Increases, in general, with increasing size of the anions.
- b. Increases frequently with increasing size of the cations; the correlation is not perfect.

- c. Decreases with increasing valence of both ions in strictly ionic crystals; increases with increasing valence if layer or molecular lattices are formed.
- d. Is less for compounds of *A* cations than for those of *B* cations if the anion is less easily polarized than is water.
- e. Is greater for compounds of *A* cations than for those of *B* cations if the anion is more easily polarized than is water.
- f. Is greater for layer and molecular lattices than for ionic lattices.

7. Hydrolysis is dependent upon the strong deformation of the hydroxyl ion, and the tendency to hydrolyze

- a. Increases with decreasing size of the cations.
- b. Increases with increasing valence of the cation.
- c. Is greater for the compounds of the *B* cations than for those of the *A* cations.

8. Acidity and basicity,

- a. The acidity of a positive element increases as its attraction for electrons increases, thus
- b. Other things being equal, a *B* cation is less basic than an *A* cation.

9. Properties of the "loosened" bond.

Certain properties characteristic of compounds of *B* cations, or cations of the transition elements, with easily polarized anions, imply that certain of the electrons have become more or less loosened. This tendency is manifested by the following properties of such compounds.

- a. Color.
- b. Conductivity by ionic diffusion—loosened ions, rather than electrons.
- c. Polymorphism.
- d. Photoelectric conductivity.
- e. Photosensitivity.

The foregoing summary refers principally to crystals with ionic or covalent-ionic bonds. The influence of bond type upon the properties of crystals may be summarized briefly as follows:

1. The ionic bond. Strength and related properties depend upon the size, valence, and electronic structure of the ions and, in many cases, upon the crystal structure.
2. The covalent-ionic bond. These crystals are weaker, owing to the "loosened" bond, except that they are more resistant to ionization, therefore less soluble. They tend to be colored and may be photosensitive.
3. The covalent-metallic bond, the NiAs and FeS₂ structures. Properties are a mixture of those of the two pure types. They are usually less soluble,

but otherwise weaker than ionic crystals. They bear a resemblance to metals; are apt to be opaque and show a metallic luster and considerable metallic conductivity which increases with their degree of impurity. They can dissolve an excess of either constituent.

4. The covalent bond in atomic crystals. The strength and related properties are apt to be greater than for ionic compounds, but of the same order of magnitude.

5. The molecular bond. Weak crystals. Low melting points, soft; the melts are nonconductors. Hydrolyze readily. Soluble in nonionizing (molecular) solvents.

CHAPTER VII

THE STRUCTURES OF TERNARY COMPOUNDS

The crystal structures of the ternary compounds are governed by the same principles as are those of the simpler binary compounds. The building stones may be ions, atoms, or radicals. In a compound of the general type $A_m(BX_n)_y$, the ionization potential of B will determine, in large part, whether or not a radical is formed.

In general, the crystalline structures of the ternary compounds are characterized by lower symmetry than are those of the binary compounds. In the latter, cubic and hexagonal crystals predominate; while crystals of the ternary compounds are more often rhombic, rhombohedral, monoclinic, or triclinic. The substitution of a nonspherical radical for a more or less spherical single atom or ion is largely responsible for this lower symmetry. In order to replace the spherical O^{2-} in a model of a crystal of CaO , for example, by a flat, triangular CO_3^{2-} radical, it is necessary to stand the cubic model on one corner with the cube diagonal perpendicular and flatten it somewhat. Thus the c axis is made shorter than the a and b axes, and a rhombohedron is formed. When this is done, space is made available for the substitution, and the model of crystalline calcite results. Similar adjustments must be made in actual crystals so that the atoms or ions may be arranged in the closest possible packing and the most stable configuration. It may, therefore, simplify the discussion somewhat to keep in mind that, in a sense, the crystal structures of the ternary compounds are usually cubic or hexagonal structures which have been distorted to accommodate nonspherical building stones.

In binary ionic compounds of the type A_mX_n , it is possible to define the general structure reasonably well from the $R_A:R_X$ ratio, which determines the coordination number of the crystal; and from a knowledge of the polarization properties of A and X ,

and the types of bonds between them. To establish the influence of size upon the structure of ternary ionic crystals, it is advantageous to consider the radius ratios $R_A:R_X$, $R_B:R_X$ and $R_A:R_B$. But not all the building stones in ternary crystals are ions, and the use of ionic radii to predict coordination numbers must be approached with caution.

The nature of the forces within radicals has been the subject of much discussion. There is no reason to believe that they are pure ionic bonds; the small, highly charged central ion has too great an ionization potential. Until recently, the conception of polarized ions and polarized ionic bonds was generally favored in dealing with radicals.¹ However, with the rapid development of the wave-mechanical interpretation of chemical bonds, it has been helpful to treat radicals in terms of covalent binding.

Pauling has treated the carbonate and some other radicals from the standpoint of the covalent bond,² but he does not imply that the bonds are normal. It is suggested that "if one atom is more electronegative than the other, the wave function can be formed by adding to the normal covalent bond-wave function an additional ionic term."³ Slater⁴ has also shown that many of the common radicals may be interpreted in terms of the electron-pair bond. From energy considerations, however, he suggests that, although the assumption of covalent bonds yields a lower energy value for the nitrate radical, the energy calculated assuming an ionic bond is sufficiently low to justify the conclusion that the ionic term is appreciable in the actual bonding force.

Mulliken treats a molecule or radical, not as a group of atoms or ions with a definite number of electron pairs, but as a set of nuclei surrounded by an electron configuration similar to that of a free atom in an electric field.⁵ This, of course, is the most precise way to approach the matter from the physical standpoint, but the results obtained are not so easy for the chemist to apply

¹ See for example, GOLDSCHMIDT, V. M., *Trans. Faraday Soc.*, **25**, 253 (1929); and elsewhere; FAJANS, KASIMIR, *Z. Krist.*, **61**, 18 (1925); "Radio Elements and Isotopes," Cornell University Press, Ithaca, N. Y., 1931; ZACHARIASEN, W. H., *J. Am. Chem. Soc.*, **53**, 2123 (1931).

² PAULING, LINUS, *J. Am. Chem. Soc.*, **53**, 1367 (1931).

³ PAULING, LINUS, *J. Am. Chem. Soc.*, **54**, 3570 (1932).

⁴ SLATER, J. C., *Phys. Rev.*, **37**, 481 (1931); **38**, 325 (1931).

⁵ MULLIKEN, R. S., *Phys. Rev.*, **40**, 55 (1932); **41**, 49 (1932).

as are those derived by Pauling's somewhat less rigorous treatment. Mulliken's viewpoint is not concerned with the nature of bonds between atoms or ions but deals only with the interactions of all the electrons around all the nuclei. His treatment does, however, imply the existence of an ionic term in the bonding energy between atoms.¹

Based on a consideration of the available evidence, therefore, we shall picture the radicals of the oxygen acids as groups of atoms held together by bonds essentially covalent but with an ionic term of small magnitude.

It follows that the coordination number of the central atom in a radical will be limited by the number of electron-pair bonds which can be formed. Thus, the elements of the first short period, having a maximum of 8 electrons in the *L* shell, can form no more than four covalent bonds. When the central atom forms covalent bonds by building up an 18-electron shell, more than four such bonds may exist. However, the mutual repulsion of overlapping electron clouds of oxygen atoms may affect the stability of the group and limit the coordination number still further. Thus the sizes of *B* and *X* and the $R_B:R_X$ ratio become important in predicting the structure of radicals.

This raises the question as to the proper numerical values to be used for the radii in computing the $R_B:R_X$ ratios if, indeed, it is reasonable to treat the relationship quantitatively. In the CO_3^- group, the radius of oxygen indicated by the C-O distance is less than 0.60 Å; the radius indicated by the O-O distance in the same group (2.18 Å) is about 1.09 Å; whereas its radius in the direction of the cations is approximately the normal ionic radius, 1.40 Å. Obviously, even though the C-O bonds are thought to be essentially covalent, atomic radii do not fairly represent the conditions which determine the packing characteristics of the atoms.

Some of the most successful attempts to systematize the coordination numbers in radicals have been made by treating the radicals as though their bonds were ionic. However, experimental confirmation of predictions based on this interpretation

¹ For a more detailed discussion of the molecular orbit theory and the Heitler-London-Pauling-Slater treatment see J. H. van Vleck, and A. Sherman, *Rev. Modern Phys.*, **7**, 224 (1935).

does not necessarily verify the existence of ions in radicals. Many years ago Kossel¹ calculated the energy involved in the combination of oppositely charged ions to form a complex ion or radical. His method was a simplified one, proceeding on the assumption that all ions are spherical and that only coulomb forces are involved in the attraction and repulsion of these ions. Using this approximation, Kossel found the following to be the most stable coordinations of negative ions around a central ion of approximately the same size:

	Examples
Central ion of charge +2 coordinates 4 univalent negative ions	K ₂ BeF ₄
Central ion of charge +3 coordinates 4 univalent negative ions	KBF ₄
Central ion of charge +4 coordinates 6 univalent negative ions	K ₂ SiF ₆
Central ion of charge +5 coordinates 8 univalent negative ions	None known
Central ion of charge +2 coordinates 2 divalent negative ions	
Central ion of charge +3 coordinates 3 divalent negative ions	H ₂ BO ₂
Central ion of charge +4 coordinates 4 divalent negative ions	K ₄ SiO ₄
Central ion of charge +5 coordinates 4 divalent negative ions	K ₂ PO ₄ , K ₃ SbS ₄
Central ion of charge +6 coordinates 4 divalent negative ions	K ₂ SO ₄
Central ion of charge +7 coordinates 6 divalent negative ions	H ₂ IO ₆
Central ion of charge +8 coordinates 6 divalent negative ions	Ca ₂ O ₈ O ₄ F ₂

The coordination of negative ions around a central ion, as listed above, is derived purely from energy calculations, assuming that both ions are of approximately the same size. Geometrical limitations have not been considered. When the radii of the positive and negative ions differ, there is no fundamental difference in the reasoning, but the familiar influence of relative sizes and the radius ratio come into play. The maximum coordination number in any given case depends not only upon the charge of the central ion, but also on the relative sizes of the ions. Thus, the small B⁺³ coordinates only four F⁻, whereas the larger Al⁺³ holds six F⁻. Although energy calculations would permit a five positive ion to coordinate eight univalent negative ions the number is geometrically limited to six.² Although a four positive central ion is, from the energy standpoint, most stable with four coordinated divalent negative ions, there is room for only three

¹ KOSSEL, W., *Ann. Phys.*, **49**, 229 (1916).

² Apparent exceptions are (NH₄)₂ZrF₇ and H₄PbF₆. In (NH₄)₂ZrF₇ only six F⁻ are coordinated by the Zr⁺⁴. The structure of (NH₄)₂ZrF₇ closely resembles that of KMgF₃. ZrF₆⁻ groups and Mg⁺⁺ ions occupy corresponding lattice points, as do NH₄⁺ and F⁻. When the formulas are written KMgF₃ and F(ZrF₆)(NH₄)₂, the reason for the approximate isomorphism is suggested. HASSEL, O., and H. MARK, *Z. Physik*, **27**, 89 (1924).

O^- around the small C^{+4} , whereas the larger Si^{+4} coordinates four O^- . Usually four is the maximum number of divalent negative ions coordinated by any central ion. H_6TeO_6 , H_6IO_6 , and Ag_4GeS_6 are apparent exceptions.

Considerable success in predicting the coordination numbers of the small central atoms in radicals has been obtained through the application of the univalent radii, first used by Pauling.¹ These radii represent the relative extension in space of the outer electron shells of the ions. The usual coordination numbers of the central atoms in radicals, as indicated by the ratio of the univalent radii, are shown in Table 89. This table of coordination numbers proves to be very useful (1) for the classification of known acids and salts, (2) for the critical evaluation of the formulas of complex salts, and (3) for the prediction of the probable existence of salts not yet isolated. It is recognized, for example, that B^{+3} , C^{+4} , and N^{+5} form the radicals BO_3^{-3} , CO_3^{-2}

TABLE 89.—RATIOS OF UNIVALENT RADII: CATION/OXYGEN*

Be^{++}	B^{+3}	C^{+4}	N^{+5}	RO_3 region		
0.25	0.20	0.17	0.14			
Mg^{++}	Al^{+3}	Si^{+4}	P^{+5}	S^{+6}	Cl^{+7}	RO_4 region
0.48	0.41	0.37	0.34	0.31	0.28	
Zn^{++}	Ga^{+3}	Ge^{+4}	As^{+5}	Se^{+6}	Br^{+7}	Kr^{+8}
0.50	0.46	0.43	0.04	0.37	0.35	0.33
Cd^{++}	In^{+3}	Sn^{+4}	Sb^{+5}	Te^{+6}	I^{+7}	Xe^{+8}
0.65	0.59	0.55	0.51	0.47	0.44	0.42
RO_6 region						

* PAULING, LINUS, *J. Am. Chem. Soc.*, **54**, 1895 (1933).

and NO_3^- . Although H_4SiO_4 and H_3PO_4 are known, H_4CO_4 and H_3NO_4 are not known to exist as such, probably because C^{+4} and N^{+5} are not large enough to coordinate four O^- . B^{+3} , the largest of the three, is able to form BO_4^{-5} when it is stabilized by a surrounding shell $W_{12}O_{18}(OH)_{36}$ (see page 300). In the crystalline metaborates, *viz.*, $Ca(BO_2)_2$, B^{+3} is actually surrounded by three O^- .² In potassium pentaborate, $KB_5O_8 \cdot 4H_2O$, it appears that four of the borons have C.N. 3 and the fifth, C.N. 4.³ The C.N. 4 in the BX_4 group is consistent with such

¹ PAULING, LINUS, *J. Am. Chem. Soc.*, **49**, 765 (1927); **54**, 1895 (1933).

² ZACHARIASEN, W. H., *Proc. Natl. Acad. Sci.*, **17**, 617 (1931).

³ ZACHARIASEN, W. H., private communication.

well-known compounds as H_4SiO_4 , H_3PO_4 , HClO_4 , H_3AsO_4 , H_2SeO_4 , and $\text{Be}(\text{H}_2\text{O})_4\text{SO}_4$. In radicals such as Cl_2O_7 , P_2O_7 , and S_2O_7 , there are two oxygen tetrahedra having one corner in common and the positive ions at the center. I^{+7} , near the minimum radius ratio for C.N. 6 is found in KIO_4 but usually in compounds like H_5IO_6 , Ag_5IO_6 , etc. Compounds like CaSnO_3 crystallize in the perovskite structure, in which each Sn^{+4} coordinates six O^- . $\text{Na}_2\text{SnO}_3 \cdot 3\text{H}_2\text{O}$ should really be written $\text{Na}_2\text{Sn}(\text{OH})_6$.

The practical usefulness of the concept of univalent radii and coordination numbers is nicely illustrated by its application to the structural formulas of the antimonates.¹ The formula $\text{K}_2\text{H}_2\text{Sb}_2\text{O}_7 \cdot x\text{H}_2\text{O}$, given for potassium antimonate in many older books, and KSbO_3 , as sometimes assigned, are both inconsistent with the chemical properties of the compound, as has been pointed out by Mellor in his treatise. He suggests the formula KH_2SbO_4 , consistent with the knowledge that the anion is singly charged and the salt gives an acid reaction. The ionic radii of Sb^{+5} and O^- , however, suggest a C.N. 6 for the former, and Pauling has proposed the formula $\text{KSb}(\text{OH})_6$, which is consistent with the amount of water of crystallization found in most antimonates.

Although the covalent bond conception is being used with increasing success in predicting structures through the characteristic directional properties of these bonds, it must be admitted that the quantum mechanical treatment of the covalent bond has not yet been developed to predict coordination numbers, except in those cases where the directional properties are peculiar to this type of binding. Until energy calculations have been made showing the instability of four oxygens around a central carbon atom, no positive, direct evidence of the nonexistence of the CO_4 group will have been furnished by the covalent bond viewpoint.

When one visualizes a radical, the CO_3^- , for example, simply as an assemblage of four nuclei around which the electron distribution may be represented in a rather definite way, the nature of the C-O bond need not be specified. However, the C-O and O-O distances are definite and may usually be determined experimentally. These factors, of course, control the

¹ PAULING, LINUS, *J. Am. Chem. Soc.*, **54**, 1895 (1933).

packing of oxygens around a central atom, and, in the last analysis, they are the criteria which should be used, rather than a radius ratio based on radii established arbitrarily by a definition of the nature of the C-O bond.¹ But it is easier to systematize the arrangement of atoms in crystals if one is permitted to visualize the packing of more or less spherical units with definite, though arbitrary radii. The use of the univalent radii is justified empirically by the results obtained.

The Structures of ABX_3 Compounds.—In Table 90, the $R_A:R_X$, $R_B:R_X$, and $R_A:R_B$ ratios are listed for a large number of ABX_3 crystals. The compounds have been arranged first in the order of increasing size of the central atom B (using univalent radii) and have been divided into three classes on this basis. Within each class they are arranged in order of the increasing radius of A . Assuming that A , B , and X are rigid spheres, it will be recalled that the number of X which can be packed around and touching A or B , and the arrangement of the packing, depend upon the relative radii of A or B and X , as shown in Table 1, Chap. I. That these same simple packing considerations, so useful in classifying the structures of the binary compounds, serve reasonably well for the prediction and organization of the more complicated structures of ternary compounds is shown in Tables 91 and 92. Radius ratios are based on univalent radii. The great majority of the ABX_3 compounds crystallize in one or more of the nine structures listed in these tables.

¹ The experimental C-O distance (approximately 1.31 Å) in CO_3^{2-} may be accounted for in one of three ways:

1. The sum of the ionic crystal radii, 1.51 Å corrected for a decrease in coordination number from 6 to 3, gives the value 1.28 Å (a contraction of about 15 per cent, see Chap. II).

2. The sum of the univalent radii, 2.01 Å, corrected for valence and coordination number gives 1.25 Å. See Chap. II, p. 50:

$$\begin{aligned} \text{To correct for valence, } R_{\text{univ}} &= R_i \frac{n-1}{\sqrt{z_1 z_2}} \\ (\text{see Table 20}) \quad 2.01 &= R \times 1.468 \\ R &= 1.37 \text{ Å} \end{aligned}$$

To correct for coordination number, $1.37 \text{ Å} \times 0.91 = 1.25 \text{ Å}$
(see Table 19)

3. The sum of the covalent radii, corrected for double and single bond resonance is 1.28 Å. PAULING, LINUS, and M. L. HUGGINS, *Z. Krist.*, **87**, 227 (1934).

TABLE 90.—STRUCTURE CLASSIFICATION OF SOME ABX₃ COMPOUNDS

Compound	Structure	R _A , A		R _B , A		R _X , A	Radius ratios of univalent radii		
		1	2	1	2	1	R _A :R _X	R _B :R _X	
Class I:									
LiNO ₃	Calcite	0.68	0.68	0.30	0.11	1.76	0.39	0.17	
NaNO ₃		0.98	0.98	0.30	0.11	1.76	0.66	0.17	
MgCO ₃		0.85	0.71	0.33	0.15	1.76	0.48	0.19	
ZnCO ₃			0.74	0.33	0.15	1.76		0.19	
FeCO ₃			0.75	0.33	0.15	1.76		0.19	
MnCO ₃			0.80	0.33	0.15	1.76		0.19	
CdCO ₃			0.97	0.33	0.15	1.76		0.19	
CoCO ₃			0.72	0.33	0.15	1.76		0.19	
AgNO ₃ (high).....			1.13	0.30	0.11	1.76		0.17	
KNO ₃ (low).....			1.33	1.33	0.30	0.11	1.76	0.75	0.17
CaCO ₃ (low).....			1.17	0.98	0.33	0.15	1.76	0.66	0.19
CaCO ₃ (high).....		Aragonite	1.17	0.98	0.33	0.15	1.76	0.66	0.19
KNO ₃ (high).....			1.33	1.33	0.30	0.11	1.76	0.75	0.17
BrCO ₃	1.33		1.15	0.33	0.15	1.76	0.75	0.19	
PbCO ₃			1.21	0.33	0.15	1.76		0.19	
BaCO ₃			1.51	1.31	0.33	0.15	1.76	0.85	0.19
RbNO ₃	RbNO ₃	1.48	1.48	0.30	0.11	1.76	0.84	0.17	
CaNO ₃		1.67	1.67	0.30	0.11	1.76	0.95	0.17	
TlNO ₃			1.44	0.30	0.11	1.76		0.17	
Class II:									
NaClO ₃	NaClO ₃	0.98	0.98		0.39	1.76	0.56		
NaBrO ₃		0.98	0.98		0.53	1.76	0.56		
AgClO ₃ (high).....			1.13		0.39	1.76			
AgClO ₃ (low).....	AgClO ₃								
AgBrO ₃					0.53	1.76			
KClO ₃	KClO ₃	1.33	1.33		0.39	1.76	0.75		
RbClO ₃		1.48	1.48		0.39	1.76	0.84		
CaClO ₃		1.67	1.67		0.39	1.76	0.95		
KBrO ₃		KBrO ₃	1.33	1.33		0.53	1.76	0.75	
RbBrO ₃			1.48	1.48		0.53	1.76	0.84	
CaBrO ₃			1.67	1.67		0.53	1.76	0.95	
Class III:									
MgTiO ₃	Ilmenite	0.86	0.71	0.92	0.62	1.76	0.48	0.52	
FeTiO ₃			0.75	0.92	0.62	1.76		0.52	
MnTiO ₃			0.80	0.92	0.62	1.76		0.52	
LiCbO ₃			0.68	0.68	0.99	0.67	1.76	0.39	0.56
NiTiO ₃				0.69	0.92	0.62	1.76		0.52
CdTiO ₃ (high).....				0.97	0.92	0.62	1.76		0.52
CdTiO ₃	Perovskite		0.97	0.92	0.62	1.76		0.52	
CaTiO ₃		1.17	0.98	0.92	0.62	1.76	0.66	0.52	
CaTiO ₃		1.67	1.67	0.92	0.62	1.76	0.95	0.52	
KIO ₃		1.33	1.33		0.94	1.76	0.75		
KCbO ₃		1.33	1.33	0.99	0.67	1.76	0.75	0.56	
CaZrO ₃		1.17	0.98	1.08	0.78	1.76	0.66	0.61	
CaSnO ₃		1.17	0.98		0.71	1.76	0.66	0.55	
YAlO ₃		1.19	0.93	0.75	0.61	1.76	0.67	0.43	
KMgF ₃		1.33	1.33	0.85	0.71	1.33	0.75	0.48	
KNiF ₃		1.33	1.33		0.69	1.33	0.75		
CaCdBr ₃		1.67	1.67		0.97	1.96	0.95		
CaCdCl ₃		1.67	1.67		0.97	1.81	0.95		

1 = univalent radii; 2 = crystal radii.

Radicals exist as discrete building units in the crystal lattices of the Class I and Class II structures. The number of nearest neighbors X surrounding each ion B (i.e., the coordination number of B) is the same as the stoichiometrical number of X ions in each molecule. In Class III, with each B surrounded by six X ,

TABLE 91.—CLASSIFICATION OF ABX_3 STRUCTURES ON THE BASIS OF $R_B:R_X$

Class	$R_B:R_X$	C.N. of B		Structure types
		Pre- dicted	Actual	
I	0.17–0.19	3	3	Calcite, aragonite, $RbNO_3$
II	0.40 (estimated)	4	3	$NaClO_3$, $KClO_3$, $KBrO_3$, $AgClO_3$
III	0.52–0.61	6	6	Perovskite, ilmenite
IV	0.36	4		$AlPO_3$, $ASiO_3$ —none with BX_3 radical known

TABLE 92.—CLASSIFICATION OF ABX_3 STRUCTURES ON THE BASIS OF $R_A:R_X$

Class	$R_A:R_X$	C.N. of A		Structure types
		Pre- dicted	Actual	
I	(0.39) 0.48–0.75	6	6	Calcite
	0.66–0.85	8	9	Aragonite
	0.95	8		$RbNO_3$
II	0.56	6	6	$NaClO_3$ $AgClO_3$
	0.75–0.95	8	9	$KClO_3$, $KBrO_3$
III	(0.39) 0.48–	6	6	Ilmenite
	(0.56) 0.62–0.95	8	12	Perovskite

it is impossible to conceive of BX_3 radicals in the crystal as such. The situation is somewhat analogous to that which obtains for the molecular lattice of a binary compound. In the series NaF , MgF_2 , AlF_3 , SnF_4 , for example, the molecule exists as a structural unit only in SnF_4 , when the number of fluoride ions coordinated to the cation is equal to the stoichiometric number of fluoride ions in the compound.

Structures of Class I.—The calcite, aragonite, and RbNO_3 structures are very similar in their general features, and their structural transition, in that order, is strictly logical.¹ Their structural classifications are: rhombohedral, orthorhombic, and orthorhombic, respectively. To the uninitiated, however, it is often surprising to realize how minute a change in the arrangement of the building stones may be involved in this change of crystallographic system. Calcite, described on page 22 and illustrated in Fig. 6, Chap. I, is a NaCl structure which has been distorted by the replacement of spherical Cl^- by triangular CO_3^- groups. X-ray data suggest that the carbon atom lies at the center of an equilateral triangle of oxygen atoms, all four atoms being in the same plane. This arrangement is consistent with the prediction from univalent radius ratios. If the bonds are conceded to be covalent, a derivation of the directional properties of these bonds leads either to the coplanar group,² or to one in which the carbon is oscillating slightly above and below the plane of the oxygens, the time average being, again, a coplanar group.³ In aragonite, the only important change is a rotation of the CO_3^- groups through 30 deg., with respect to their positions in calcite,⁴ in order to make room for the larger cations *A* (see Fig. 40). The resulting arrangement may be considered a distorted NiAs lattice. The nine nearest oxygen neighbors are not equidistant from each *A* ion, so that the C.N. 9 is to be taken as an idealized value.

RbNO_3 differs from calcite principally in the orientation of the NO_3^- groups, of the same size and shape as the CO_3^- radical. In calcite, the plane of the radicals is perpendicular to the cube diagonal of the crystal; in RbNO_3 , the birefringence of the crystal is best explained on the assumption that the NO_3^- groups do not all lie in parallel planes. Again, the realignment of these disk-shaped radicals is necessitated by the need for larger spaces to accommodate the larger cations.

¹ For a detailed description of these and all other structures discussed in this chapter, see R. W. G. Wyckoff, "The Structure of Crystals," 2d ed., Reinhold Publishing Corporation, New York, 1930, and 2d ed. Supplement, 1934. Also P. P. Ewald and C. Hermann, "Strukturbericht," Akademische Verlagsges., Leipzig, 1931, and later volumes.

² SLATER, J. C., *Phys. Rev.*, **38**, 325 (1931).

³ PAULING, LINUS, *J. Am. Chem. Soc.*, **53**, 1367 (1931).

⁴ BRAGG, W. L., *Proc. Roy. Soc. (London)*, **A 105**, 16 (1924).

It is evident that it does not take much to alter the plan of the building stones from that of calcite to that of aragonite, and the crystallization of those ABX_3 compounds of certain metals of a critical size may be influenced by conditions of temperature and pressure so that they may occur as either calcite or aragonite, *i.e.*, polymorphism is to be expected at these critical size values (see Table 90).

Consider the influence of polarization or of the electron-pair bond upon the crystal structures of the Class I, ABX_3 compounds. From the $R_A:R_X$ ratio, $AgNO_3$ might be expected to crystallize like calcite or aragonite, but actually the form stable at room

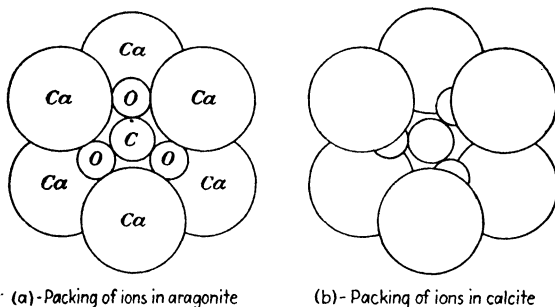

FIG. 40.—Ionic arrangement in the two forms of calcium carbonate. [From W. L. Bragg: *Proc. Roy. Soc. (London)*, A 105, 16 (1924), by permission of the Royal Society.]

temperatures is of a lower symmetry than either of these owing to the nature of the silver ion. At higher temperatures, $AgNO_3$ is isomorphous with calcite; which suggests that increasing temperature reduces the influence of polarization or loosens the covalent bond, as the case may be. The same influence is at work in the case of $TlNO_3$, which is isomorphous with $RbNO_3$ only at higher temperatures.

In Class I crystals the $A-X$ distances are those predicted from ionic radii, indicating that the $A-X$ bond is essentially ionic.

Structures of Class II.—As the central ion B increases in size, a new structural class is established when the $R_B:R_X$ ratio becomes greater than 0.22. The structures of Class II are built of ions; a simple cation, as indicated by the $A-X$ distances in the crystals and an anion radical.

The compounds falling in this class are the bromates and chlorates. The general coordination features of their structures have been listed in Tables 91 and 92. They differ particularly from the Class I structures, however, in the shape of the radical, as indicated by X-ray diffraction data. X-ray evidence suggests a planar configuration for the CO_3^- and NO_3^- radicals and for the BO_3^{-3} group as found in hambergite, $\text{Be}_2(\text{BO}_3)(\text{OH})$,¹ and as more recently determined in InBO_3 , ScBO_3 , and YBO_3 .²

The ClO_3^- and BrO_3^- groups, on the contrary, are definitely pyramidal. It was pointed out some time ago³ that the planar or pyramidal shape of a BX_3 radical is related to the electronic structure of the central ion B . Treating these radicals from the covalent standpoint [*i.e.*, ClO_3 as made up of $\text{Cl}^{++}(\text{O}^{-1})_3$] Slater⁴ observed that, while Cl^{++} had 2s and 3p electrons, only the 3p's contribute to valence, forming three bonds which tend to be at right angles to each other, thus favoring a pyramidal structure. Supposedly the unshared s electrons will be concentrated as far away from the 3p's as possible as suggested also by Mulliken,⁵ who emphasized the existence of two unshared electrons in the ClO_3^- group.

It follows that all other BX_3 radicals in which the ion B has 2s and 3p valence electrons should possess the pyramidal form of ClO_3^- and BrO_3^- . Such groups are SO_3^- , AsO_3^{-3} , SbO_3^{-3} , and PO_3^{-3} , of which the first three have been studied by X-ray diffraction, although not in ABX_3 compounds.⁶

The assumption that the AsS_3^{-3} and SbS_3^{-3} groups are pyramidal in Ag_3AsS_3 and Ag_3SbS_3 , respectively, has been shown to be compatible with the observed X-ray data.⁷

¹ ZACHARIASEN, W. H., *Z. Krist.*, **76**, 289 (1931).

² GOLDSCHMIDT, V. M., and H. HAUPTMANN, *Nachr. Ges. Wiss. Göttingen, Math.-physik., Klassen*, p. 53, 1932.

³ ZACHARIASEN, W. H., *J. Am. Chem. Soc.*, **53**, 2123 (1931).

⁴ SLATER, J. C., *Phys. Rev.*, **37**, 481 (1931); **38**, 325 (1931).

⁵ MULLIKEN, R. S., *Phys. Rev.*, **40**, 59 (1932).

⁶ ZACHARIASEN, W. H., and H. E. BUCKLEY, *Phys. Rev.*, **37**, 1295 (1931). Na_2SO_3 . BOZORTH, R. M., *J. Am. Chem. Soc.*, **45**, 1621 (1923). As_2O_3 and Sb_2O_3 .

⁷ HOFMANN, W., *Z. Krist.*, **92**, 161 (1935); HARKER, D., *J. Chem. Physics*, **4**, 38 (1936).

Of the Class II structures, AgClO_3 is of particular interest because it again illustrates that increasing temperature appears to reduce the abnormal influence of Ag^+ . According to the $R_A:R_X$ ratio, AgClO_3 should be isomorphous with NaClO_3 , but it is only at elevated temperatures that the cubic, NaClO_3 form of AgClO_3 crystallizes. At room temperatures AgClO_3 crystallizes in the tetragonal system.

The possible occurrence of ABX_3 compounds, in which the $R_B:R_X$ ratio lies between 0.22 and 0.41 but the ion B has a completed outer electron shell, has been discussed by Zachariasen.¹ Such ions are Be^{++} , Si^{+4} , P^{+5} , V^{+5} , Ge^{+4} , and As^{+5} . It has been found that in all of the compounds of these ions whose structures have been analyzed (*e.g.*, BeO , BeAl_2O_4 , SiO_2 , Ag_3PO_4 , YVO_4 , GeO_2), the coordination number of the B ion is four. Apparently these ions cannot form ABX_3 structures with BX_3 radicals; but rather with polymerized groups, either chains or closed rings of tetrahedra, such as those commonly found in silicates. Aluminum metaphosphate, $\text{Al}(\text{PO}_3)_3$, although not strictly an ABX_3 compound, illustrates the form the BX_3 radical may be expected to take. The structure contains a P_4O_{12} group; each phosphorus coordinates four oxygens tetrahedrally and each tetrahedron shares two corners with other tetrahedra and the other two corners with AlO_6 octahedra.²

Structures of Class III.—When the $R_B:R_X$ ratio is greater than 0.41, indicating a coordination of six X ions around each B ion, the radical BX_3 can no longer exist as such. Further evidence of this is the predominance of the perovskite structure, a pseudocubic lattice, suggesting that the problem of packing involves only relatively spherical units and not nonspherical complex groups.

The perovskite structure, usually described as cubic, may be visualized with ions A at the corners of the cube, X ions face-centered, and body-centered B ions.³ There are then six X ions around each B , and twelve X around each A ion. The A - X

¹ ZACHARIASEN, W. H., *Skrifter Norske Videnskaps-Akad. Oslo*, no. 4 (1928).

² PAULING, LINUS, and JACK SHERMAN, *Z. Krist.*, **96**, 481 (1937).

³ WYCKOFF, R. W. G., "The Structure of Crystals," 2d ed., p. 277, Reinhold Publishing Corporation, New York, 1930.

and $B-X$ distances are the expected interionic distances, the $B-X$ distance being about the same as the $A-X$ distance in the rutile structure. Most crystals with the perovskite structure are anisotropic, showing that they are not truly cubic but are orthorhombic or monoclinic. The degree of distortion may be expressed by the so-called "tolerance factor"¹ determined as follows:

For octahedral coordination of X around B , $R_B:R_X > \sqrt{2} - 1$ and $R_A + R_X = \sqrt{2}(R_B + R_X)$. The radii must be corrected for coordination number. The increase in radius when the coordination number increases from six to twelve is about 6 per cent, whereas the $B-X$ distances in perovskite crystals have been found to compare with the $A-X$ distances in rutile crystals—about 5 per cent less than the standard radius for C.N. 6 as found in the NaCl structure.²

The corrected equation, then, is

$$1.06(R_A + R_X) = t\sqrt{2}[0.95(R_B + R_X)],$$

where t = the tolerance factor. The perovskite structure appears to be stable when the corrected tolerance factor is $1.00 \pm$ approximately 0.1. Tolerance factors of some of the crystals with the perovskite structure are shown in Table 93.

TABLE 93.—TOLERANCE FACTORS FOR SOME CRYSTALS WITH THE PEROVSKITE STRUCTURE

Compound	t	Compound	t
CdTiO ₃	0.93	NaCbO ₃	0.90
CaTiO ₃	0.94	KCbO ₃	1.02
SrTiO ₃	1.02	CaZrO ₃	0.90
BaTiO ₃	1.09	SrZrO ₃	0.97
KIO ₃	0.90	KNiF ₃	1.00
RbIO ₃	0.95	KZnF ₃	0.99

t = tolerance factor.

¹ ZACHARIASEN, W. H., *Skrifter Norske Videnskaps-Akad. Oslo*, no. 4, p. 152, (1928).

² This appears to be true only when $X = O^-$. When $X = F^-$, a univalent ion, the $B-X$ distance corresponds to the sum of the radii as found in the NaCl structure.

Those with a tolerance factor nearest unity are isotropic (SrTiO_3 , KNiF_3 , KZnF_3); they are of truly cubic symmetry. With tolerance factors varying widely from unity (CdTiO_3 , CaZrO_3), the lack of cubic symmetry is so pronounced that it may be detected even from the X-ray diffraction data.

With a decrease in the $R_A:R_B$ ratio, *i.e.*, as the *A* and *B* ions become more nearly the same size, the perovskite structure gives way to that of ilmenite, a hexagonal structure closely related to that of corundum. When $R_A:R_B$ equals unity, the typical

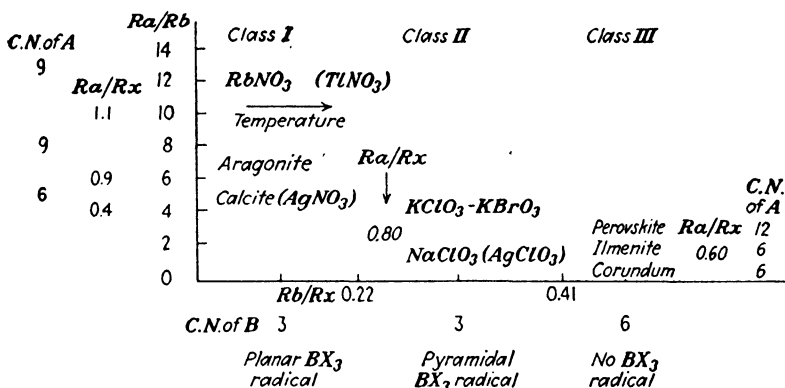

FIG. 41.—Classification of ABX_3 compounds according to crystal structure.

structures of the A_2X_3 compounds come into the picture. The change from the perovskite to the ilmenite structure reduces the number of *X* ions surrounding each *A* ion from 12 to 6, and the transition, perovskite to ilmenite, should occur when the $R_A:R_X$ ratio falls below 0.73. Actually, as may be seen from Table 90, for those compounds isomorphous with ilmenite, the $R_A:R_X$ ratio of the A_2X_3 type compound is less than 0.60. This low $R_A:R_X$ ratio accounts for the transition, perovskite to ilmenite (corundum), upon the substitution of a smaller ion *A* in the perovskite structure. Were the $R_A:R_X$ value of the A_2X_3 compound higher, as when the Al^{+3} in YAlO_3 is replaced by Y^{+3} , the transition would be from perovskite to the C-type sesquioxide structure; and the replacement of Al^{+3} by La^{+3} in LaAlO_3 would result in a perovskite to A-type sesquioxide transition (see Chap. V).

TABLE 94.—CLASSIFICATION OF SOME ABX₄ COMPOUNDS

Compound	Structure					Radius ratios of univalent radii			
		R _A		R _B		R _X (1), A	R _A :R _X	R _B :R _X	
		1	2	1	2				
CaSO ₄	CaSO ₄	1.17	0.98	0.62	0.29	1.76	0.67	0.35	
NaClO ₄ (low)		0.98	0.98	0.55	0.26	1.76	0.56	0.31	
NaClO ₄ (high)	KClO ₄ (high)	0.98	0.98	0.55	0.26	1.76	0.56	0.31	
KClO ₄ (high)		1.33	1.33	0.55	0.26	1.76	0.75	0.31	
RbClO ₄ (high)		1.48	1.48	0.55	0.26	1.76	0.84	0.31	
CsClO ₄ (high)		1.67	1.67	0.55	0.26	1.76	0.95	0.31	
NH ₄ ClO ₄ (high)		1.50	1.50	0.55	0.26	1.76	0.85	0.31	
TiClO ₄ (high)		1.44	1.44	0.55	0.26	1.76		0.31	
AgClO ₄ (high)		1.13	1.13	0.55	0.26	1.76		0.31	
BaSO ₄		BaSO ₄	1.51	1.31	0.62	0.29	1.76	0.85	0.35
SrSO ₄	1.33		1.15	0.62	0.29	1.76	0.75	0.35	
PbSO ₄	1.21		1.02	0.62	0.29	1.76		0.35	
KMnO ₄	1.33		1.33	0.72	0.46	1.76	0.75	0.41	
KClO ₄ (low)	1.33		1.33	0.55	0.26	1.76	0.75	0.31	
RbClO ₄ (low)	1.48		1.48	0.55	0.26	1.76	0.84	0.31	
CsClO ₄ (low)	1.67		1.67	0.55	0.26	1.76	0.95	0.31	
NH ₄ ClO ₄ (low)	1.50		1.50	0.55	0.26	1.76		0.31	
TiClO ₄ (low)	1.44		1.44	0.55	0.26	1.76		0.31	
KBF ₄	1.33		1.33	0.39	0.24	1.33	0.75	0.29	
EuSO ₄	1.17								
ZrSiO ₄	ZrSiO ₄		1.08	0.87	0.66	0.44	1.76	0.61	0.38
YPO ₄			1.20	0.93	0.63	0.34	1.76	0.68	0.36
ThSiO ₄			1.02	1.02	0.66	0.44	1.76		0.38
CaCrO ₄			1.17	0.98	0.75	0.35	1.76	0.67	0.42
YVO ₄		1.20	0.93	0.85	0.35	1.76	0.68	0.48	
CaWO ₄	CaWO ₄	1.17	0.98	*0.91	0.65	1.76	0.67	0.52	
BaWO ₄		1.51	1.31	*0.91	0.65	1.76	0.85	0.52	
CaMoO ₄		1.17	0.98	0.91	0.62	1.76	0.67	0.52	
BaMoO ₄		1.51	1.31	0.91	0.62	1.76	0.85	0.52	
SrMoO ₄		1.33	1.15	0.91	0.62	1.76	0.75	0.52	
PbMoO ₄		1.21	1.02	0.91	0.62	1.76		0.52	
PbWO ₄		1.21	1.21	0.65		1.76			
KIO ₄		1.33	1.33	0.80	0.50	1.76	0.75	0.44	
RbIO ₄		1.48	1.48	0.80	0.50	1.76	0.84	0.44	
LiIO ₄		0.68	0.68	0.80	0.50	1.76	0.39	0.44	
AgIO ₄		1.13							
KReO ₄		1.33	1.33			1.76	0.75		
BPO ₄		BPO ₄	0.40	0.24	0.63	0.34	1.76	0.24	0.36
BAeO ₄			0.40	0.24	0.70	0.47	1.76	0.24	0.40
AlPO ₄		AlPO ₄	0.75	0.57	0.63	0.34	1.76	0.42	0.36
AlAsO ₄	0.75		0.57	0.70	0.47	1.76	0.42	0.40	

1 = univalent radii; 2 = crystal radii. * Estimated.

The structures of the ABX_3 compounds conform to the rules of crystal chemistry which have been found to hold for simpler compounds. In general the coordination number of B ions is that which is to be expected from a consideration of the $R_B:R_X$ ratio. The coordination number of A sometimes differs from that to be expected from the size of A . The form in which a compound crystallizes depends upon the values of $R_A:R_X$ and $R_B:R_X$, and upon the nature of the bonding forces, as summarized in Tables 91 and 92, and the schematic diagram in Fig. 41.

The Compounds ABX_4 .—Of the compounds of this general formula which have been studied, the majority crystallize in one of seven structures: $BaSO_4$, $CaSO_4$, $CaWO_4$, $ZrSiO_4$, $KClO_4$ (high temperature), $MgWO_4$, BPO_4 . We shall find that the structure is related to the relative sizes of the building stones.

From the detailed data of Table 94, a partial list of ABX_4 compounds, the crystal chemistry of this general group may be summarized as in Table 95.

TABLE 95.—THE CRYSTAL CHEMICAL CLASSIFICATION OF THE ABX_4 COMPOUNDS

$R_B:R_X$	C.N. of B		$R_A:R_X$	C.N. of A		Structure type
	Pre- dicted	Actual		Pre- dicted	Ac- tual	
0.31–0.35	4	4	0.56–0.67	6	4+4*	$CaSO_4$, orthorhombic
0.31	4	4	(0.56) 0.75–0.95	8	(8)	$KClO_4$ (high) cubic
0.31–0.40	4	4	0.75–1.00	8	12	$BaSO_4$, orthorhombic
.52–0.54	6	4 (loose)	0.67–0.85	6–8	4+4*	$CaWO_4$
0.38–0.42(0.48)	4(-6)	4	0.61–0.68	6	4+4*	$ZrSiO_4$
0.36–0.40	4	4	0.24–0.42	4	4	BPO_4 , $(AlPO_4)$

* Eight neighbors, but four nearer than the other four.

In spite of the tetrahedral coordination of the BX_4 ion, which is somewhat spherical in shape, the crystallization of ABX_4 compounds in the cubic system is the exception rather than the rule. Orthorhombic and monoclinic crystals prevail. $CaSO_4$ and $BaSO_4$ are $NaCl$ structures which have been distorted, probably by the steric hindrance of the tetrahedral BX_4 group. At high temperatures the perchlorates, isomorphous with $BaSO_4$

at room temperatures, crystallize in the cubic high-KClO₄ structure, a NaCl lattice in which cations *A* occupy the Na⁺ positions and anions *BX*₄ occupy the Cl⁻ positions and are, according to a recent report, rotating.¹ Evidently, as the temperature increases the tetrahedral group becomes more nearly spherical in shape, probably because of an "unlocking" of the tetrahedra permitted by a slight expansion of the lattice. This results in the greater mobility of the group.² The transition, BaSO₄ structure to (high) KClO₄ structure, then, is caused by an increase in temperature and a resulting increase in symmetry of the building stones.

A decrease in the size of *A* causes the transition BaSO₄ structure to CaSO₄ structure. These three, BaSO₄, high-KClO₄, and CaSO₄, are typical ionic structures in which the *BX*₄ radical is a well-defined structural unit.

The transition $\left(\begin{array}{c} \text{BaSO}_4 \text{ structure} \\ \text{CaSO}_4 \text{ structure} \end{array} \right)$ to CaWO₄ structure occurs as the size of *B* increases. There are still four *X* atoms surrounding each *B* atom, but the *B-X* distance is much larger and the close-knit radical *BX*₄ no longer exists. The compounds are much less acidic.

The CaWO₄, or scheelite lattice, is characterized by its remarkably wide range of stability. The size of the ion *A* which can be accommodated ranges from Li⁺ (0.68 Å) to NH₄⁺ (1.50), and the *R*_A:*R*_X ratio from 0.64 to 0.85. Some structures seem much more "elastic" than others and are able to tolerate much wider changes in the sizes of the ions; and the CaWO₄ structure is one of these.

Although the positions of the oxygen atoms in the MgWO₄ structure³ have not been established with certainty, it is reasonably safe to say that in this structure the cations *A* occupy smaller spaces between oxygens than they do in CaWO₄ and may even exhibit a lower coordination number.

¹ FINBAK, C., and O. HASSEL, *Z. physik. Chem.*, **B 32**, 130 (1936).

² That form of NH₄NO₃ stable at highest temperature gives the simple diffraction pattern of CsCl, best explained on the assumption that the NO₃⁻ and NH₄⁺ radicals are rotating.

HENDRICKS, S. B., E. POSNJAK, and F. C. KRACEK, *J. Am. Chem. Soc.*, **54**, 2766 (1932).

³Said to be the structure of ZnWO₄, FeWO₄, MnWO₄, NiWO₄, CoWO₄.

The transition CaWO_4 structure to ZrSiO_4 structure is probably influenced in large measure by the nature of the bonds, as well as by the relative ionic radii. Both the A and B ions, particularly the latter, are generally smaller in the ZrSiO_4 structure, and both tend to be highly charged and equally prone to form the covalent bond with oxygen.

In sharp contrast to the flexible scheelite lattice, the symmetry of zircon appears to involve rather exacting volume requirements, owing to the closer packing of the oxide ions and the greater rigidity of the BO_4 tetrahedra. Some years ago the prediction was made¹ that the substitutes for the zirconium in the ZrSiO_4 structure were limited to thorium and lead and that germanium might be substituted for silicon. The mineral thorite (ThSiO_4) has been described as isomorphous with zircon but unstable,² whereas the structure of PbSiO_4 is not known. To the above ions Vegard might have added the following: for the A cation, Y^{+3} (1.06), Ca^{++} (0.98), and Ce^{+3} (1.01); and for the B radical PO_4^{-3} , VO_4^{-3} , AsO_4^{-3} , and CrO_4^{-2} . As indicated in Table 94, YPO_4 , YVO_4 , and CaCrO_4 have already been confirmed, whereas CePO_4 has been found to have a different structure.

A decrease in the size of the cation A accompanies the $\text{ZrSiO}_4 \rightarrow \text{BPO}_4$ transition. The BPO_4 lattice is constructed of linked oxygen tetrahedra, sharing corners. A atoms are at the centers of half of these, while B atoms lie at the centers of the others. BPO_4 and BaSO_4 may be looked upon as distorted high-cristobalite structures. AlPO_4 ³ and AlAsO_4 ⁴ also built of linked oxygen tetrahedra, are said to bear a formal resemblance to the quartz structure.

The following analogy may be drawn between ABX_3 and ABX_4 structures:

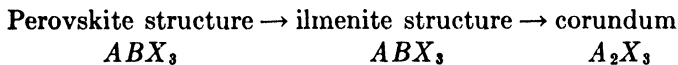

¹ VEGARD, L., *Skrifter Norske Videnskaps-Akad. Oslo*, no. 6 (1927).

² VEGARD, L., *Phil. Mag.*, **32**, 93 (1916).

³ HUTTENLOCHER, H. F., *Z. Krist.*, **90**, 508 (1935).

⁴ MACHATSCHKI, F., *Z. Krist.*, **90**, 314 (1935).

TABLE 96.—CRYSTAL CHEMICAL CLASSIFICATION OF SOME A_2BX_4 COMPOUNDS

Compound	Structure	R_A	R_B	R_X	$R_A : R_B$	$R_A : R_X$	$R_B : R_X$
Ag_2MoO_4	Spinel	1.13	0.62	1.40	0.55	0.81	0.44
Cr_2CdO_4		0.65	0.97	1.40	0.67	0.48	0.69
Fe_2CdO_4		0.67	0.97	1.40	0.69	0.49	0.69
Al_2CoO_4		0.55	0.72	1.40	0.76	0.39	0.51
Cr_2CoO_4		0.65	0.72	1.40	0.90	0.48	0.51
Co_2O_4		0.72	0.72	1.40	1.00	0.51	0.51
Co_2S_4		0.72	0.72	1.80	1.00	0.40	0.40
Co_2SnO_4		0.72	0.71	1.40	1.00	0.51	0.51
Al_2CuO_4		0.55	0.75 approx.	1.40	0.74	0.39	0.53
Co_2CuS_4		0.72	0.75	1.80	0.96	0.40	0.41
Fe_2CuO_4		0.67	0.75	1.40	0.89	0.49	0.53
Al_2FeO_4		0.55	0.75	1.40	0.74	0.39	0.53
Cr_2FeO_4		0.65	0.75	1.40	0.87	0.48	0.53
Fe_2O_4		0.67	0.75	1.40	0.89	0.49	0.53
Al_2MgO_4		0.55	0.78	1.40	0.71	0.39	0.55
Co_2MgO_4		0.72	0.78	1.40	0.92	0.51	0.55
Cr_2MgO_4		0.65	0.78	1.40	0.83	0.48	0.55
Fe_2MgO_4		0.67	0.78	1.40	0.86	0.49	0.55
$Fe_2(Mn, Fe, Mg)O_4$		0.67	0.80-0.67-0.78	1.40			
Mg_2SnO_4		0.78	0.71	1.40	1.10 (0.91)	0.55	0.51
Al_2MnO_4		0.55	0.80	1.40	0.69	0.39	0.57
Cr_2MnO_4		0.65	0.80	1.40	0.81	0.48	0.57
Fe_2MnO_4		0.67	0.80	1.40	0.84	0.49	0.57
Al_2NiO_4		0.55	0.69	1.40	0.80	0.39	0.50
$(Co, Ni)_2(Ni, Co)O_4$		0.72-65	0.65-0.72	1.40			
Fe_2NiO_4		0.67	0.69	1.40	0.97	0.49	0.50
Ni_2S_4		0.69	0.65	1.80	1.06 (0.94)	0.38	0.36
Al_2ZnO_4		0.55	0.83	1.40	0.66	0.39	0.60
$Co ZnO_4$		0.72	0.83	1.40	0.87	0.51	0.60
Cr_2ZnO_4		0.65	0.83	1.40	0.78	0.48	0.60
Fe_2ZnO_4		0.67	0.83	1.40	0.81	0.49	0.60
Zn_2SnO_4		0.83	0.71	1.40	1.17 (0.86)	0.60	0.50
Zn_2TiO_4		0.83	0.62	1.40	1.34 (0.75)	0.60	0.44
$K_2Cd(CN)_4$	1.33	0.97	1.95	1.37 (0.73)	0.68	0.50	
$K_2Hg(CN)_4$	1.33	1.10	1.95	1.21 (0.83)	0.68	0.56	
$K_2Zn(CN)_4$	1.33	0.83	1.95	1.60 (0.62)	0.68	0.43	
Li_2MoO_4	Phenacite	0.68	0.62	1.40	1.10	0.49	0.44
Li_2WO_4		0.68	0.65	1.40	1.05	0.49	0.48
Be_2SiO_4		0.39	0.44	1.40	0.90	0.28	0.31
Li_2BeF_4	0.68	0.39	1.33	1.70	0.51	0.30	
Al_2BeO_4	Chrysoberyl	0.55	0.39	1.40	1.40	0.39	0.28
Mg_2SiO_4		0.83	0.44	1.40	1.90	0.60	0.31
Na_2SO_4	Na_2SO_4	0.98	0.29	1.40	2.9	0.70	0.21
Ag_2SO_4		1.13	0.29	1.40	3.3	0.80	0.21
Ag_2SeO_4		1.13	0.42	1.40	2.8	0.80	0.29
K_2SO_4	K_2SO_4	1.33	0.29	1.40	4.6	0.95	0.21
K_2SeO_4		1.33	0.42	1.40	3.2	0.95	0.29
K_2CrO_4		1.33	0.52	1.40	2.6	0.95	0.37
Cs_2SO_4		1.67	0.29	1.40	5.7	1.2	0.21
$(NH_4)_2SO_4$		1.56	0.29	1.40	5.4	1.1	0.21
Rb_2SO_4		1.48	0.29	1.40	5.1	1.1	0.21
K_2PdCl_4							
K_2PtCl_4							
$(NH_4)_2PdCl_4$							

The Structures of A_2BX_4 Compounds.—Most of the A_2BX_4 compounds crystallize in one of five structures: the spinel, Al_2MgO_4 ; the chrysoberyl, Al_2BeO_4 ; the K_2SO_4 structure, which is closely related to that of chrysoberyl; the phenacite, Be_2SiO_4 ; and the K_2PtCl_4 structures. The influence of the size of the building stones upon the structure of an A_2BX_4 compound is shown in Table 97, summarized from the detailed data in Table 96. Crystal radii are used here, since most of the univalent radii are not available.

TABLE 97.—CRYSTAL CHEMICAL CLASSIFICATION OF A_2BX_4 COMPOUNDS

$R_B:R_X$	C.N. of B		$R_A:R_X$	C.N. of A		$R_A:R_B$	Structure
	Pre- dicted	Actual		Pre- dicted	Actual		
0.39–0.69	4–6	4	0.39–0.81	4–8	6	0.62–1.00	Spinel
0.31–0.46	4–6	4	0.29–0.48	4–6	4	0.9–1.7	Phenacite
0.28–0.31	4	4	0.40–0.60	4–6	6	1.4–1.9	Chrysoberyl
0.24–0.29	4	4	0.70–0.80	6–8	6	2.8–3.3	Na_2SO_4
0.21–0.37	4	4	0.95–1.2	8	8	2.6–5.7	K_2SO_4
0.28–0.46	4	4	0.28–0.48	4–6	8	1.05–1.7	K_2PtCl_4

The spinels are, perhaps, the most interesting of this group from the structural standpoint because the arrangement is stable through a wide range of ionic sizes and because a great variety of compounds have been found to crystallize like spinel. Compounds as different chemically as Al_2MgO_4 , Fe_3O_4 , and $K_2Cd(CN)_4$ are all isomorphous. Another characteristic of the artificial spinels is their ability to hold in solid solution an excess of aluminum, perhaps as $\alpha-Al_2O_3$, which is said to crystallize like spinel.¹ Sometimes A is the cation of higher charge, sometimes B . A or B may be the larger cation. It is also a common occurrence for A and B to be distributed quite at random in the lattice, rather than at equivalent lattice points. Because the structure tolerates this ready interchange of cations the composition of certain spinels may be varied continuously through substitution.

¹ RINNE, F., *Neues Jahrb. Mineral. Geol. Beilage Band*, A 58, 43 (1928); HÄGG, G., *Z. physik. Chem.*, B 29, 88 (1935).

The distances in spinel imply that the crystal is essentially ionic. Because the radii of A and B are of the same order of magnitude, the BX_4 radical, although it exists geometrically, has little chemical significance in most cases. In $K_2Zn(CN)_4$ and a few others, the BX_4 radical does have a physical meaning, because of the stronger bond formed between the zinc ion and the easily distorted, unsymmetrical cyanide ion.

Chrysoberyl is, structurally, very similar to spinel. In the former the oxygen ions are nearly close-packed hexagonal; in the latter they approximate cubic close packing. In phenacite, because of the lower $R_A:R_X$ value, the A ions as well as the B ions are surrounded by four oxygen ions in an approximately tetrahedral arrangement. Both of these structures are built of A , B , and X ions.

The K_2SO_4 structure resembles chrysoberyl in a general way, but differs from it in the symmetry of the structural units. Also, in K_2SO_4 , characterized by a large $R_A:R_B$ ratio, the BX_4 radical has a real physical meaning. The $A-X$ distances are ionic. The SO_4^{2-} radical also exists as such in the Na_2SO_4 structure, which differs from the K_2SO_4 structure in the orientation of the SO_4 tetrahedra with respect to the cations, smaller in Na_2SO_4 than in K_2SO_4 .

The structure of the K_2PdCl_4 group¹ is peculiar. The four X atoms lie at the corners of a square, rather than at the corners of a tetrahedron. This confirms Werner's prediction of many years ago, based on the apparent existence of cis and trans compounds of this type. Pauling has shown that the unique directional properties of the $B-X$ bonds brand them as covalent rather than ionic bonds. The $K-Cl$ distance, practically the same as in KCl , indicates that the $A-X$ bond is ionic. It is probably the abnormal planar distribution of the Cl ions which permits the coordination of eight by each A ion, rather than the six predicted from the radius ratio.

The Structures of $S_mO_n^{-2}$ Groups.—The special arrangement of the central ion and its coordinated negative ions in actual crystals is of great interest. The BX_3 and BX_4 radicals have been discussed. Systematic studies of some of the more complex groups are being undertaken. There is, for example, a striking

¹ DICKINSON, F. G., *J. Am. Chem. Soc.*, **44**, 2404 (1922).

relationship between all $S_mO_n^{-2}$ groups.¹ The pyrosulfite (S_2O_5)⁻² group proves to have the structure shown in Fig. 42 in which the angles between sulfur and oxygen range from 102 to 116 deg. It follows that the correct structural formula for the pyrosulfite group is

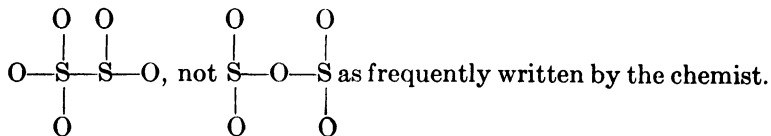

In the sulfate group² the oxygens are at the corners of an almost regular tetrahedron, the S lying at the center. Pauling³ and Slater⁴ have shown by a wave-mechanical treatment that the angle between S and O bonds tends to be tetrahedral, and all experimental data confirm this. By removing one oxygen from each of two sulfate tetrahedra and joining the two exposed sulfurs, the dithionate ion (S_2O_6)⁻² is formed. Each sulfur is surrounded tetrahedrally by three oxygens and one sulfur. Thus the structural formula usually given for dithionic acid, HO_3S-SO_3H , is confirmed. With the removal of one oxygen from the dithionate group,⁵ the pyrosulfite radical, as illustrated, is formed. Similarly atoms ACDE in Fig. 42 represent the structure of the SO_3^{-2} complex, as determined in Na_2SO_3 .⁶ It is to be supposed, although not yet verified, that the atoms BFG represent the structure of SO_2^{-2} ; whereas the S atoms, AB, are the familiar S_2 group of the pyrite crystal. The radicals $S_2O_2^{-2}$, $S_2O_3^{-2}$, and $S_2O_4^{-2}$ must also be derived from the basic structure shown. The $S_2O_8^{-2}$ in $(NH_4)_2S_2O_8$ is made up, as shown in Fig. 43, of two oxygen tetrahedra, joined by an O-O bond, with a sulfur atom at the center of each.⁷ The trithionate ion

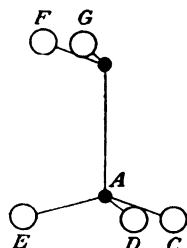

FIG. 42.—The pyrosulfite group. [From W. H. Zachariassen: *Phys. Rev.*, **40**, 923 (1932).]

¹ ZACHARIASEN, W. H., *Phys. Rev.*, **40**, 923 (1932).

² ZACHARIASEN, W. H., and G. E. ZIEGLER: *Z. Krist.*, **81**, 92 (1931).

³ PAULING, LINUS, *J. Am. Chem. Soc.*, **53**, 1367 (1931).

⁴ SLATER, J. C., *Phys. Rev.*, **37**, 481 (1931).

⁵ HUGGINS, M. L., and G. O. FRANK, *Am. Mineral.*, **16**, 580 (1931).

⁶ ZACHARIASEN, W. H., and H. E. BUCKLEY, *Phys. Rev.*, **37**, 1295 (1931).

⁷ ZACHARIASEN, W. H., and R. C. MOONEY, *Z. Krist.*, **88**, 63 (1934).

$(S_3O_6)^{-2}$ may be pictured,¹ as in Fig. 44, as two oxygen tetrahedra sharing one corner, a sulfur at the center of each tetrahedron and the oxygen at the shared corner replaced by the third sulfur.

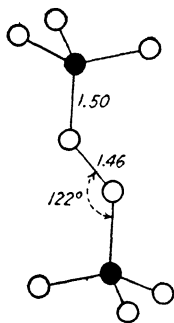

FIG. 43.

FIG. 43.—The persulfate group. [From W. H. Zachariasen and R. C. Mooney: *Z. Krist.*, **88**, 63 (1934)].

A comparison of the interatomic distances found in the several sulfur-oxygen complexes bears further testimony to the structural relationships of this interesting group. These interatomic distances are shown in Table 98.¹

The Stability of Complex Ionic Compounds.—

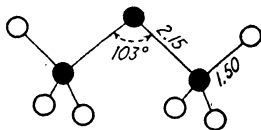

FIG. 44.

FIG. 44.—The trithionate group. [From W. H. Zachariasen: *Z. Krist.*, **89**, 529 (1934).]

Generally speaking, the stability of a complex compound is influenced by the same factors which determine the solubility of a binary compound and may be treated, qualitatively, in much the same manner.

TABLE 98.—INTERATOMIC DISTANCES IN SULFUR-OXYGEN COMPLEX IONS

S-O distance, A		S-S distance, A	
Na_2SO_3	1.39	FeS_2	2.14
Na_2SO_4	1.49	$K_2S_2O_5$	2.18
$K_2S_2O_5$	1.47	$K_2S_3O_6$	2.15 (average)*
$(NH_4)_2S_2O_8$	1.50		
$K_2S_2O_8$	1.50		

* This value from W. H. Zachariasen and R. C. Mooney, *Z. Krist.*, **88**, 63 (1934).

A crystal dissolves when the attraction of the ions for water molecules is greater than the attraction of the ions for each other; or, when the heat of hydration is greater than the lattice energy. Strong crystals, those with high lattice energies, are least soluble, because they are most difficult to break down. Similarly, in complex formation, the strongest crystals, if they

¹ ZACHARIASEN, W. H., *Z. Krist.*, **89**, 529 (1934).

form complex ions, form the least stable complexes. Consider by way of illustration, the stabilities of the alkaline earth carbonates in relation to the equilibrium $MO + CO_2 \rightleftharpoons MCO_3$, where M is the metal ion. The heat of formation¹ Q of MCO_3 is equal to the heat evolved by the addition of CO_2 to the oxide A , less the energy required to expand the MO lattice, as measured by its lattice energy U , or

$$Q = A - U \quad (1)$$

Thus, the stronger the MO lattice, the smaller will be the positive heat of formation of the carbonate and the lower its stability. Of the alkaline earth ions, Mg^{++} is the smallest, and therefore the lattice energy of MgO is the highest of the oxides. It follows that $MgCO_3$ is the least stable of the carbonates, and this is confirmed by the experimental data. At atmospheric pressure, the alkaline earth carbonates evolve CO_2 at the following temperatures:

	$MgCO_3$	$CaCO_3$	$SrCO_3$	$BaCO_3$
CO_2 evolved, °C.....	230	817	1130	1297
Lattice energy U of oxides, kg. cal..	940	840	790	747

Evidently this increasing stability of the carbonates is dependent upon the decreasing strength of the oxides (a lower value of U in Equation (1) results in a higher value for Q).

Because of their lower valence, the lattice energies of the alkali oxides are lower, and the alkali carbonates are more stable than the alkaline earth carbonates. The small Li^+ builds the strongest oxide lattice, and lithium carbonate is the least stable of the carbonates. The lattice energy of LiO is 693 kg. cal., and Li_2CO_3 evolves CO_2 at 1270°C.

The peroxides of the alkalis are more stable than those of the alkaline earths. Of all the peroxides (alkalies and alkaline earths), Cs_2O_2 is the most stable, whereas BaO_2 is the most stable of the alkaline earth peroxides.

Thermal data for a number of divalent sulfates are shown in Table 99. Although these data are rather fragmentary, they

¹ Q is the heat of formation from the oxide and CO_2 , not from the elements.

conform to the trends outlined. The stronger the metallic oxide, the more energy is required to expand the lattice to accommodate the larger radical, and the less stable will be the resulting sulfate. The size and electronic structure of the metallic cation influence directly the lattice energy of the oxide and therefore, indirectly, the stability of the sulfate.

TABLE 99.—THERMAL DATA FOR SOME DIVALENT SULFATES

	MgSO ₄	CaSO ₄	SrSO ₄	BaSO ₄	ZnSO ₄
Radius of cation, A	0.78	1.06	1.27	1.43	0.83
Heat of formation:					
Oxide + SO ₂ , kg. cal		84	95.6	102	
Metal + O ₂ + SO ₂ , kg. cal	232	249	260	266	159
Lattice energy of oxide, kg. cal	940	840	790	747	970
Decomposition temperature, °C.		1000 approx.		1550	427

To summarize, the stability of a complex compound increases with increasing size and decreasing charge of the cation.

This bears an interesting relationship to the stability of the alkali polyhalides. Their occurrence involves the formation of a complex halide anion, the actual existence of which has been demonstrated by freezing point¹ and conductivity² measurements, probably by the polarization of a neutral halogen molecule. If a stable polyhalide is to be formed, the energy of polarization of the neutral molecule must be greater than the lattice energy of the simple halide. NaF cannot form a stable polyhalide for the same reason that it does not readily dissolve in water—the lattice energy is too high. It is impossible to break down the NaF lattice, by the polarization of either a halogen molecule or a water molecule. In fact, no fluorides form polyhalides, and chloride polyhalides are not particularly stable. The weakest of the alkali halide crystals forms the most stable polyhalide. The temperatures at which halogen is evolved from typical polyhalides at atmospheric pressure are shown in Table 100.³

¹ EPHEIM, "Anorganische Chemie," p. 183, T. Steinkopff, Dresden, 1922.

² BRÖNSTED and PEDERSON, *Z. physik. Chem.*, **103**, 307 (1923).

³ VAN ARKEL, A. E., and J. H. DEBOER, "Chemische Bindung," p. 175, S. Hirzel, Leipzig, 1931.

Because the lattice energy of CsI is the lowest of all the alkali halides, the polyhalides of CsI are the most stable. The stabilities of the polyhalides decrease as the lattice energies of the simple halides increase, *i.e.*, stability decreases with decreasing size of the cation or anion. It is of interest to note that decomposition is always such that the simple halide with the highest lattice energy is formed. Thus, CsICl₂ decomposes to give CsCl + ICl, rather than CsI + Cl₂.¹

TABLE 100.—TEMPERATURE AT WHICH HALOGEN IS EVOLVED FROM TYPICAL POLYHALIDES

CsII ₂	250	CsBrBr ₂	147.5	RbII ₂	192	RbBrBr ₂	105.5
CsIBr ₂	242.5	CsBrCl ₂	138	RbIBr ₂	186.5	RbBrCl ₂	93
CsICl ₂	209	CsClBr ₂	124	RbICl ₂	151	RbClBr ₂	81

Inevitably, the size of the coordinated halogen molecule influences the stability of the polyhalides, although the relationship is not obvious. With decreasing size of the molecule (I₂ to F₂) the necessary disruption of the lattice decreases, but the polarizability of the neutral molecule, and therefore the energy of addition, also decreases. The data in Table 100 indicate that the more polarizable molecule builds the more stable polyhalide. CsII₂, for example, is more stable than CsICl₂.

The stability of the polyhalides, then, increases in the order K⁺ to Rb⁺ to Cs⁺; Cl⁻ to Br⁻ to I⁻; Cl₂ to Br₂ to I₂.

¹ CLARK, G. L., *Am. J. Sci.*, **7**, 113 (1924).

CHAPTER VIII

THE STRUCTURES OF THE SILICATES

Perhaps the greatest single accomplishment of crystal chemistry has been the systematization of the silicate minerals, baffling to chemists and crystallographers alike because of their apparently complicated crystallographic and chemical structures. The laws of crystal chemistry, the influence of ionic and atomic size, polarization properties, and the nature of bonding forces upon the packing of ions and atoms have clarified the situation and demonstrated that all of the very complex silicate crystals are formed in accordance with these same elementary structural principles.

The silicates, as a group, are characterized by the large number of variations in the silicon-oxygen ratio which occur from one compound to another. There is little wonder that chemists have always found it somewhat difficult to rationalize formulas like Mg_2SiO_4 , $\text{Sc}_2\text{Si}_2\text{O}_7$, $\text{BaTiSi}_3\text{O}_9$, $\text{CaMg}(\text{SiO}_3)_2$, $\text{Ca}_2\text{Mg}_5(\text{Si}_4\text{O}_{11})_2(\text{OH})_2$, and $\text{Mg}_3\text{Si}_4\text{O}_{10}(\text{OH})_2$. This was first attempted by postulating a bewildering number of acids of silicon and classifying silicates according to their supposed acid groups.

However, led by the excellent pioneering work and continued efforts of the Braggs¹ and their coworkers, the X-ray analysis of a large number of silicate minerals revealed the reason for the apparent variable combining power of silicon. In all silicates, the silicon atoms are to be found at the centers of oxygen tetrahedra. Thus the tetravalency of silicon is maintained. But these tetrahedra may exist independently or may share corners, edges, and, rarely, faces in a variety of ways. Obviously when two or more silicons may share the same oxygen in this fashion, the silicon-oxygen ratio in the formula will vary accordingly.

¹ An extremely interesting and up-to-date account is given by W. L. Bragg, "Atomic Structures of Minerals," Cornell University Press, Ithaca, New York, 1936.

It is now possible to classify all of the silicates whose structures are known into a very few groups, arranged according to the manner of linking of the silicon-oxygen tetrahedra.

1. Self-contained groups:

a. SiO_4 . Single tetrahedra. Examples: The orthosilicates. Garnet,¹ $(\text{Fe}, \text{Mn})_3\text{Al}_2(\text{SiO}_4)_3$; olivine,² Mg_2SiO_4 .

The structure of olivine, Mg_2SiO_4 (shown in Fig. 45), is perhaps one of the simplest of the silicates to visualize. The $\text{SiO}__4$ groups

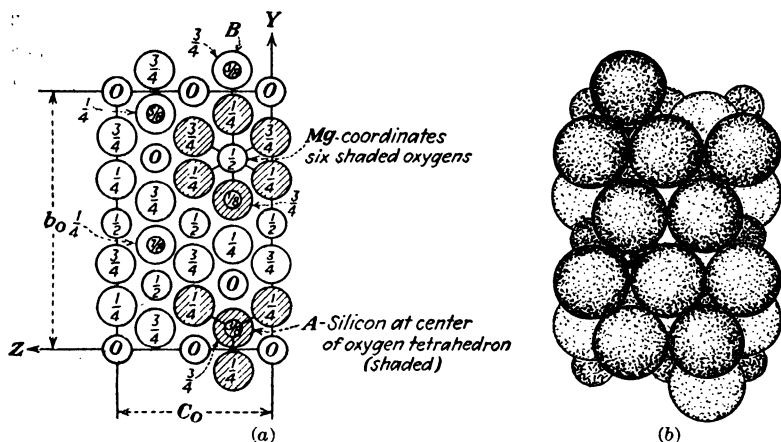

FIG. 45.—(a) The unit prism of olivine, Mg_2SiO_4 , projected upon its a-face. Atoms of O, Mg and Si are represented by large, intermediate and small circles. (b) A packing drawing of a. Only one small Si atom is shown. It is evident that the structure is characterized by close-packed oxygens. (From Wyckoff, "The Structure of Crystals," by permission of the Reinhold Publishing Corporation, New York.)

exist independently in the lattice, just as the SO_4 ion is to be found as such in crystalline sulfates. The atoms of those SiO_4 groups, occurring within the unit cell pictured, are shaded and connected; one such group is in the lower right-hand corner of the cell. Each magnesium ion is surrounded octahedrally by six oxygens. For example, in the figure, one Mg^{++} is shown coordinating the six shaded oxygen atoms. These positively charged metallic ions serve to bind together the negative SiO_4 radicals, and it will be seen that they are distributed uniformly throughout the cell.

¹ MENZER, G., *Z. Krist.*, **69**, 300 (1928).

² TAYLOR, W. H., and J. WEST, *Proc. Roy. Soc. (London)*, **A 117**, 132 (1928).

Since each silicon coordinates four oxygens, the "effective valence" of each Si-O bond must be one; similarly, because each Mg ion coordinates six oxygens, the effective valence of each Mg-O bond is $\frac{2}{3} = \frac{1}{3}$. Further study of Fig. 45 reveals that each oxygen has as nearest neighbors one silicon and three magnesiums. Thus, the usual valence rules are satisfied, since the total bonding power of the oxygen atom's four neighbors is $1 + \frac{1}{3} + \frac{1}{3} + \frac{1}{3} = 2$.

b. Si_2O_7 . Two tetrahedra, sharing one oxygen corner. The positive metallic ions are to be found between these negative Si_2O_7 groups, binding them together. The Si_2O_7 group is shown

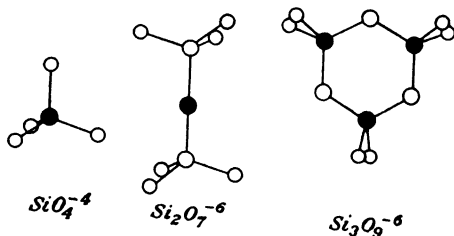

FIG. 46.—Arrangement of SiO_4 tetrahedra in the SiO_4 , Si_2O_7 and Si_3O_9 groups. [From W. L. Bragg: *Z. Krist.*, **74**, 269 (1930).]

in Fig. 46. Examples: Thortveitite,¹ $\text{Sc}_2\text{Si}_2\text{O}_7$; hardystonite,² $\text{Ca}_2\text{ZnSi}_2\text{O}_7$; melilite,³ $(\text{Ca}, \text{Na})_2(\text{Mg}, \text{Al})(\text{Si}, \text{Al})_2\text{O}_7$.

c. Si_3O_9 . Three tetrahedra, sharing three corners with each other to form a closed ring, as illustrated in Fig. 46. These Si_3O_9 groups are held together by positive metallic ions distributed between them. Example: Benitoite,⁴ $\text{BaTiSi}_3\text{O}_9$.

2. Silicon-oxygen endless chains:

a. The pyroxenes, SiO_3 groups. Simple chains of SiO_4 tetrahedra, each sharing two oxygen atoms, as in Fig. 47a. The acid radical SiO_3 is considered to extend the full length of the crystal. Example: Diopside,⁵ $\text{CaMg}(\text{SiO}_3)_2$.

b. Double chains, Si_4O_{11} groups. As in Fig. 47b. Example: Tremolite,⁶ $\text{Ca}_2\text{Mg}_6(\text{Si}_4\text{O}_{11})_2(\text{OH})_2$.

¹ ZACHARIASEN, W. H., *Z. Krist.*, **73**, 1 (1930).

² WARREN, B. E., and O. P. TRAUTZ, *Z. Krist.*, **75**, 525 (1930).

³ WARREN, B. E., *Z. Krist.*, **74**, 131 (1930).

⁴ ZACHARIASEN, W. H., *Z. Krist.*, **74**, 139 (1930).

⁵ WARREN, B. E., and W. L. BRAGG, *Z. Krist.*, **69**, 168 (1928).

⁶ WARREN, B. E., *Ind. Eng. Chem.*, **24**, 419 (1932).

In these single- and double-chain crystals the metallic ions form the links between parallel chains. The binding force between chains is ionic and is not so strong as the Si-O bonds along the chain. This gives rise to the well-known fibrous nature of asbestos and the amphiboles.

3. Silicon-oxygen sheets, Si_2O_5 groups. If the double chain is extended, as in Fig. 48, a sheet is formed. The metallic ions

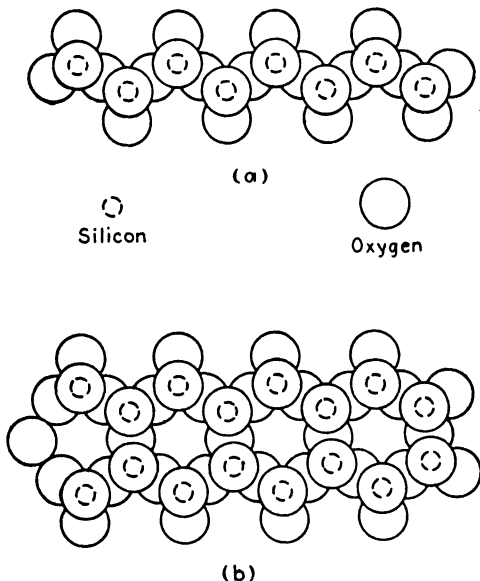

FIG. 47.—Silicon-oxygen chains. (a) Single chains. The pyroxenes (SiO_3) group. (b) Double chains. The amphiboles (Si_4O_{11}) group. [From Warren: *Ind. Eng. Chem.*, **24**, 419 (1932).]

furnish the ionic forces between sheets, weaker than the silicon-oxygen bond within sheets, hence the minerals with this structure tend to cleave in thin layers. Examples: The micas.¹ General formula: $\text{KX}_n\text{Y}_4\text{O}_{10}(\text{OH}, \text{F})_2$; muscovite,² $(\text{OH})_2(\text{K}, \text{Na})\text{Al}_2(\text{Si}_3\text{AlO}_{10})$. The chlorites.³ General formula: $\text{X}_m\text{Y}_4\text{O}_{10}(\text{OH})_8$; talc,⁴ $\text{Mg}_3\text{Si}_4\text{O}_{10}(\text{OH})_2$.

¹ PAULING, LINUS, *Proc. Natl. Acad. Sci.*, **16**, 123 (1930).

² JACKSON, W. W., and J. WEST, *Z. Krist.*, **76**, 211 (1930).

³ PAULING, LINUS, *Proc. Natl. Acad. Sci.*, **16**, 578 (1930).

⁴ GRUNER, J. W., *Z. Krist.*, **66**, 412 (1934).

The physical properties of talc, the micas, and the brittle micas bear the expected relationship to their general structures.¹ All three are "layer" lattices. In the micas, the Si(Al)-O layers are held together by K^+ or Na^+ ; in the brittle micas, the layers are bound together by Ca^{++} . The forces required to separate layers in the micas are not so great as those required to separate layers in the brittle micas. The former are therefore more elastic and not so hard as the latter. A talc crystal is built of electrically neutral layers, held together only by residual forces. These

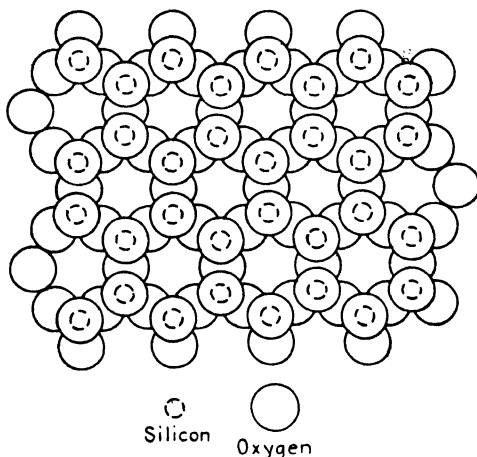

FIG. 48.—Silicon-oxygen sheets. Example: The micas. [From Warren, *Ind. Eng. Chem.*, **24**, 419 (1932).]

are therefore easily separated and account for the soft, soapy feeling of talc. The relative hardness of these layer structures, on the Mohs' scale are: talc, 1 to 2; the micas, 2 to 3; the brittle micas, $3\frac{1}{2}$ to 6.

4. Three-dimensional silicon-oxygen network. An extension in three dimensions of the silicon-oxygen sheets.

There are three general types of these networks, based on various $(Si, Al)O_2$ frameworks.²

a. Skeleton network of squares and collapsed octagons—the feldspar type and the closely related borosilicate, danburite,³ $CaB_2Si_2O_8$.

¹ PAULING, LINUS, *Proc. Natl. Acad. Sci.*, **16**, 128 (1930).

² PAULING, LINUS, *Z. Krist.*, **74**, 213 (1930).

³ DUNBAR, C., and F. MACHATSCHKI, *Z. Krist.*, **76**, 133 (1930).

b. Those based on squares and hexagons—the ultramarine and sodalite type.¹

c. Those based on hexagons alone—tridymite (SiO_2) and nephelite, NaAlSiO_4 .²

That interesting group of minerals known as the zeolites form three-dimensional network structures. The zeolites are peculiar in that the metallic ions may be changed or the water removed without any apparent change in the skeleton structure. No doubt this may take place because the framework is more open than that of the similar feldspar type.

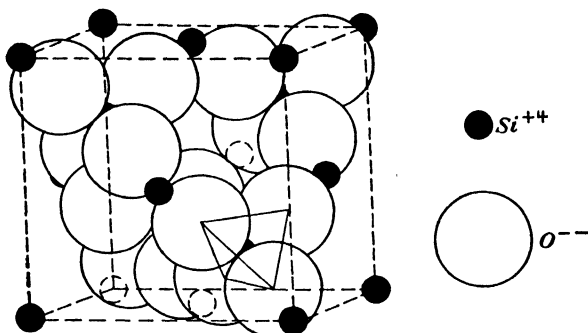
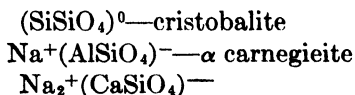

FIG. 49.—The cristobalite structure, showing characteristic silicon-oxygen tetrahedra. (Reproduced, by permission, from the *Encyclopaedia Britannica*.)

One of the most familiar uses of the zeolites is in softening water: When hard water is caused to filter through a zeolite, the Ca^{++} and Mg^{++} in the water replace the Na^+ in the zeolite.

The several forms of silica are also special networks of SiO_4 tetrahedra. One of these, cristobalite, is shown in Fig. 49.

An interesting series of structures may be derived from cristobalite, without any fundamental change in the network structure, by replacing half of the Si^{++} successively by Al^{+3} and Ca^{++} . To maintain the necessary positive charge, Na ions are added interstitially.³ Thus:



¹ BARTH, T. F. W., *Z. Krist.*, **83**, 405 (1932) (sodalite, $\text{Na}_4\text{Al}_3\text{Si}_3\text{O}_{13}\text{Cl}$); JÄGER, F. M., *Bull. soc. franç. mineral.*, **53**, 183 (1930) (ultramarines).

² BANNISTER, F. A., *Mineralog. Mag.*, **22**, 569 (1931).

³ BARTH, T. F. W., and E. POSNJAČ, *Z. Krist.*, **81**, 376 (1932).

This last formula appears to be that of an orthosilicate with separate SiO_4 tetrahedra. Crystallographically, however, it has a CaSiO_4 framework.

Certain nonsilicates have recently been found to have this same cristobalite structure, *viz.*, $\text{K}_2\text{O}\cdot\text{Al}_2\text{O}_3$ and $\text{K}_2\text{O}\cdot\text{Fe}_2\text{O}_3$ and $\text{Na}_2\text{O}\cdot\text{Al}_2\text{O}_3$.¹ Alkali ions are interstitial in a framework of AlO_4 or FeO_4 tetrahedra.

A similar case is the feldspar series

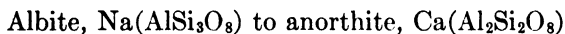

These are only two of the countless complex silicates which may be derived, by additions to or substitutions in the simple classification of general types enumerated above, *viz.*, separate, paired, and ring tetrahedra as discrete groups, and SiO_4 tetrahedra in single and double chains, sheets, and three-dimensional networks. The transition of tremolite and hornblende, via substitution, is another case in point.²

Tremolite, $\text{H}_2\text{Ca}_2\text{Mg}_5(\text{SiO}_3)_8$ to hornblende,
 $\text{H}_2(\text{Ca, Na, K})_{2-3}(\text{Mg, Fe, Al})_5((\text{Al, Si})\text{O}_3)_8$

The large group of aluminosilicates are frameworks, formed by the substitution of Al for Si, of AlO_4 tetrahedra for SiO_4 tetrahedra.³ Si^{+4} may also be replaced by B^{+3} or Be^{+2} in indefinite, as well as stoichiometric amounts, and ions like Mg^{+2} , Fe^{+3} , and Al^{+3} or Ca^{+2} and Na^{+} are interchangeable, the possibility of substitution depending upon relative sizes, not upon relative valences. Thus, from diopside, $\text{CaMg}(\text{SiO}_3)_2$, the mineral augite is derived, with the general formula

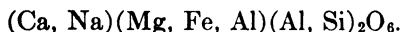

As an illustration of the balancing of electrostatic charges by suitable substitution, this may be broken down into the following specific formulas:

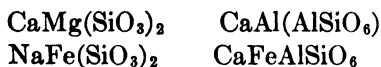

¹ BARTH, T. F. W., *J. Chem. Phys.*, **3**, 323 (1935).

² WARREN, B. E., *Z. Krist.*, **72**, 493 (1929).

³ See, for example, TAYLOR, W. H., *Proc. Roy. Soc. (London)*, **A 145**, 80 (1934).

The simple silicates may also be varied by the addition of groups or chains or sheets of oxides or hydroxides, giving rise to series of basic silicates. Olivine, Mg_2SiO_4 , combined with $Mg(OH)_2$ sheets, for example, forms the series

Norbergite, $Mg(F, OH)_2Mg_2SiO_4$ to
clinohumite, $Mg_7(Mg(F, OH))_2(SiO_4)_4$

The presence of sheets of $Mg(OH)_2$ stabilizes the otherwise unstable $MgSi_2O_5$ to form talc, $MgSi_2O_5 \cdot 2Mg(OH)_2$.

Kaolin, $(OH)_4Al_2Si_2O_5$, is a neutral double-layer structure, bearing a certain resemblance to mica. The $(Si, Al)_2O_5$ layers in mica are held together by positive cations; the Si_2O_5 layers in kaolin alternate with Al, OH layers, the neutral double layers, Si_2O_5

Al, OH, being held only by weak secondary forces.¹ Doubtless the so-called "base-exchange" phenomenon characteristic of clays and soils is also dependent upon the structure of these substances—the occurrence of the basic ions, weakly bound in the lattice interstices.² The facility with which various metallic ions may be introduced into the zeolitic structure depends, among other things, upon their sizes, and this suggests a picture of metallic ions weaving their way through a $Si(Al)-O$ network.

Germanium forms an extended series of compounds isomorphous with the silicates. Mg_2GeO_4 , germanium olivine; Be_2GeO_4 , germanium phenacite, and germanium pyroxenes are known.³ Recently it has been reported that Zn_2SiO_4 and Zn_2GeO_4 are isomorphous, as are Cs_2SiF_6 and Cs_2GeF_6 .⁴ It is probable that future investigations will reveal a rather complete structural analogy of the germanates and silicates.

Because of the comparable sizes of the silicon and phosphorus atoms, a similarity in the structure of silicates and phosphates may also be anticipated. PO_4 tetrahedra have been found in KH_2PO_4 and some other orthophosphates. The P_2O_7 group analogous to Si_2O_7 has been identified in the pyrophosphates MP_2O_7 ,

¹ TAYLOR, W. H., *J. Am. Ceram. Soc.*, **16**, 418 (1933).

² TAYLOR, W. H., *Proc. Roy. Soc. (London)*, **A 145**, 80 (1934).

³ GOLDSCHMIDT, V. M., *Nach. Ges. Wiss. Göttingen Geschäft. Mitt.; Math.-physik. Klassen*, 1931, 184.

⁴ SCHÜTZ, W., *Z. physik. Chem.*, **B 31**, 292 (1936).

where $M = \text{Si, Ti, Zr, Hf, or U}$.¹ Of these, SiP_2O_7 is unusual because the silicon coordinates six oxygens rather than four, the four coordination being assumed by the smaller phosphorus. $\text{Al}(\text{PO}_3)_3$, the first metaphosphate to be analyzed, contains a complex P_4O_{12} group consisting of four PO_4 tetrahedra in a closed ring, each sharing two corners with its neighbors.² Incidentally, this analysis is illustrative of a very useful procedure in crystal-structure determinations, *viz.*, the determination of the space group, the prediction of a likely structure with the aid of certain structural principles, and finally the confirmation of this prediction by the comparison of observed and calculated intensities of X-ray reflections.

The several types of silicates, classified according to the silicon-oxygen ratio and the spatial distribution of the SiO_4 tetrahedra, are summarized in Table 101.

TABLE 101.—CLASSIFICATION OF SILICATES

Acid radical	Si:O	Structural unit
SiO_4	1:4	Single tetrahedron
Si_2O_7	1:3.5	Double tetrahedron
Si_3O_9	1:3	3-Tetrahedron ring
$(\text{SiO}_2)_n$	1:3	Single chain
$(\text{Si}_4\text{O}_{11})_n$	1:2.75	Double chain
$(\text{Si}_2\text{O}_6)_n$	1:2.5	Endless sheet
$((\text{Si, Al})\text{O}_2)_n$	1:2	Three-dimensional net
$(\text{SiO}_2)_n$		

The crystal chemistry of the silicates has proved a valuable supplement to difficult chemical analyses in establishing the formula for a silicate mineral.³ Mauguin's work⁴ on the micas, cited by Bragg, offers an illustration. The relative amounts of H, K, Mg, Fe, Al, Si, F, and O may be determined by analysis, but these relative proportions may vary widely, and it is impossi-

¹ LEVI, G. R., and G. PEYRONEL, *Z. Krist.*, **92**, 190 (1935); PEYRONEL, G., *ibid.*, **94**, 311 (1936).

² PAULING, LINUS, and JACK SHERMAN, *Z. Krist.*, **96**, 481 (1937).

³ BRAGG, W. H., and W. L. BRAGG "The Crystalline State," vol. I, p. 238, George Bell & Sons, Ltd., London, 1933.

⁴ MAUGUIN, C., *Bull. soc. franç. minéral.*, **51**, 285 (1928); *Compt. rend.*, **186**, 879 (1928); MAUGUIN, C., and L. GRABER, *Compt. rend.*, **186**, 1131 (1928).

ble to define arbitrarily the absolute amounts in a unit or to set up any "standard" composition from which variations may be assumed to occur. Mauguin found that when composition, density, and unit cell dimensions were determined simultaneously, all variations in composition must be expressed in terms of 48 ($O^- + F^-$), these large anions forming a constant crystal skeleton for all micas. In muscovite there are four molecules of $(OH)_2KAl_2(Si_3AlO_{10})$ per unit cell. As the Al and Si in Si_3AlO_{10} vary, the electrical charges are balanced by a variation in the number of large cations, K^+ , or the substitution of Ca^{++} for K^+ . Mg_3^{++} , Fe_3^{++} , or Fe_2^{+3} may be substituted for the small cation Al_2^{+3} .

Tremolite is often given the formula $CaMg_5(SiO_3)_4$, with the understanding that there is a small and supposedly insignificant amount of water (approximately 2.2 per cent) present. Warren's structural analysis¹ showed this water, present as OH^- , to be essential to the architectural plan of the unit cell, which leads to the formula $(OH)_2Ca_2Mg_5(Si_4O_{11})_2$. Obviously it would be difficult to choose between the two formulas by chemical analysis alone.

Although space does not permit a detailed description of specific silicate structures, it is interesting to consider the general methods which have been used and are being used to arrive at these structures.

Bragg, in his original approach to the silicate structures, was guided by the following principles:

1. Oxygen ions, being the largest, form the skeleton of all silicate crystals. (It is interesting to note that errors in the assignment of formulas to silicates have frequently occurred because the importance of oxygen in the formula has not been realized.)

2. The several metallic ions of the silicate were fitted into suitable gaps in this oxygen skeleton. The arrangement depends upon interionic distances and ionic radii. The coordination numbers will, as usual, depend upon the values of the radius ratios of the ions where predominantly ionic bonds are involved. Silicon always occurs in silicates surrounded tetrahedrally by four oxygens. This oxygen tetrahedron with a Si^{+4} at its center is

¹ WARREN, B. E., *Z. Krist.*, **72**, 42 (1929).

common to all silicates and to the several forms of SiO_2 . The silicon and oxygen ions are probably only partially ionized, and their tetrahedral arrangement may therefore be the result of the combined influence of the radius ratio and of the tetrahedral covalent bonding force.

The coordination numbers (for silicates, the number of neighboring oxygen ions) of other elements found in silicates may usually be determined from the ionic radius ratios since the bonds between the metallic ions and the oxide ion are essentially ionic. Thus, for example, eight oxygen ions are found to surround every sodium ion.

3. The oxide ions are shared by the metallic elements; in fact, the silicon-oxygen tetrahedra, either individuals or groups, are connected with other like groups by the metallic ions.

4. In keeping with the principles of isomorphism, the oxide ion may be replaced by the fluoride ion or the hydroxyl group.

5. The cations tend to be distributed symmetrically throughout the crystal, since this affords the greatest electrical stability.

These principles were used very successfully in some of the first analyses of silicate structures by Bragg and his coworkers, when structures thought to be relatively close packed were selected purposely.¹

Pauling, in his approach to the structure of the silicates and other complex crystals² adopts as a starting point the principle that each metallic ion, including Si^{+4} , lies at the center of a polyhedron, its corners occupied by anions. It is assumed that the cation-anion distance is determined by the sum of the radii, and the coordination number is determined by the radius ratio of the ions. The crystal may be synthesized from these polyhedra. Thus, whereas Bragg's early method was to erect a framework of anions to build a silicate structure, Pauling used as building blocks the polyhedra defined by the number and size of the metallic ions and built from the ground up.

A summary of the smaller metallic ions found in silicates, together with their characteristic coordination numbers and the

¹ For detailed accounts of this work, see W. L. Bragg, *Trans. Faraday Soc.*, **25**, 291 (1929); *Z. Krist.*, **74**, 273 (1930); W. H. Bragg and W. L. Bragg, "The Crystalline State," vol. I, p. 131, George Bell & Sons, Ltd., London, 1933. Details to be given in a later volume.

² PAULING, LINUS, *J. Am. Chem. Soc.*, **51**, 1010 (1929).

strength of their electrostatic bonds, is given in Table 102. The large cations (C.N. 8) are not included because their polyhedra are subject to considerable distortion and do not make suitable building blocks. This conception of polyhedral building units can only be safely applied under the following additional restrictions:

1. The anions must not be easily polarized (O^- and F^- , but not OH^- , fulfill this requirement).

2. The bonds must be essentially, but not exclusively, ionic. They should not be definitely nonionic. Compounds of the 18-shell atoms cannot be considered.

TABLE 102.—COORDINATION NUMBERS FOR IONS IN OXIDES, AND STRENGTH OF ELECTROSTATIC BONDS IN COMPLEX CRYSTALS

Ion	$R_A:R_{O^-}$	Coordination number		Strength of electrostatic bond
		Predicted	Found	
B^{+3}	0.20	3	3 or 4	1 or $\frac{1}{2}$
Be^{+2}	0.25	4	4	$\frac{1}{2}$
Li^+	0.34	4	4	$\frac{1}{4}$
Si^{+4}	0.37	4	4(6)	1
Al^{+3}	0.41	4 or 6	4 or 6	$\frac{2}{3}$ or $\frac{1}{2}$
Mg^{+2}	0.47	6	4 or 6	$\frac{1}{2}$ or $\frac{1}{3}$
Ti^{+4}	0.55	6	6	$\frac{2}{3}$
Sc^{+3}	0.60	6	6	$\frac{1}{2}$
Mo^{+6}	0.53	6	4 or 6	$\frac{2}{3}$ or 1
Zr^{+4}	0.62	6	6 or 8	$\frac{2}{3}$ or $\frac{1}{2}$

Subject to certain limiting conditions, polyhedra may be joined by either the sharing of corners or the sharing of edges or faces.

The Sharing of Corners.—In a stable, coordinated structure, the electric charge of each anion tends to compensate the strength of the electrostatic valence bonds reaching to it from the cations at the centers of the polyhedra of which it forms a corner. Although this principle is not exactly satisfied in all cases, it should be approximated. Pauling lists several typical examples in which it holds. Thus in beryl, an oxygen may be shared by two silicon ions (sum of charges of bonds to oxygen = $1 + 1 = 2$) or by one silicon, one beryllium, and one aluminum

($1 + \frac{1}{2} + \frac{1}{2} = 2$). In topaz, each oxide is common to one silicon and two aluminum ions ($1 + \frac{1}{2} + \frac{1}{2} = 2$), while each fluoride is attached to two aluminum ($\frac{1}{2} + \frac{1}{2} = 1$). In chondrodite, $H_2Mg_3Si_2O_{10}$, an oxide is common to one silicon tetrahedron and three magnesium octahedra ($1 + \frac{1}{3} + \frac{1}{3} + \frac{1}{3} = 2$).

The Sharing of Edges and Faces.—The presence of shared edges, and particularly of shared faces, in a coordinated structure decreases its stability; the decrease is large for cations with high valences and small coordination numbers and is especially large in case the radius ratio approaches the lower limit for geometrical stability of the polyhedron. The loss of stability results from the close approach of cations. The sharing of an edge between regular tetrahedra reduces the cation-cation distance in the two polyhedra to 0.58 of its value when only corners are shared, while the sharing of faces reduces this distance to 0.33 of its original value. Between octahedra the effect is not so great. Apropos of the above discussion is the order of stability of the three forms of TiO_2 , rutile, brookite, and anatase, the first being the most stable. The number of shared edges of the TiO_6 octahedra which make up the structures are two, three, and four, respectively.

Whereas the use of regular polyhedral building blocks leads to the construction of an ideal structure, the actual building units are usually distorted polyhedra, and it is convenient to consider means for the prediction, qualitatively at least, of the nature and amount of distortion to be expected. For example, cation-cation repulsion will shorten shared edges and the edges of shared faces, and it has actually been found that the O-O distance in shared edges and the edges of shared faces is shortened; in Al_2O_3 , for example, to 2.50 Å. The sum of the ionic radii is 2.80 Å. Secondly, the cation-cation repulsion may displace the cations from the centers of their polyhedra. This effect is particularly strong if the radius ratio is near the lower limit for geometrical stability. It causes a greater displacement of the Al^{+3} ions from the centers of the face-sharing octahedra in corundum ($R_A:R_X = 0.41$) than of the Fe^{+3} ions in hematite ($R_A:R_X = 0.48$).

The lower the valence and the larger the coordination number of the cations at the centers of oxygen polyhedra, the greater their

tendency for sharing edges. Thus, SiO_4 tetrahedra share only corners with AlO_6 octahedra, but may share edges with MgO_6 octahedra in olivine or with ZrO_8 polyhedra, as in zircon.

The Nature of Contiguous Polyhedra.—In a crystal containing different cations, those with large valences and small coordination numbers tend to form isolated polyhedra. This requirement follows from the necessity of having those units with the highest positive charges as widely separated as possible. In silicates, therefore, SiO_4 tetrahedra will share no elements with each other if their independent existence be stoichiometrically possible, *i.e.*, if there are, in the stoichiometric formula, four or more O^- for each Si^{+4} . When the number of oxygens per silicon is less than four, then corners may be shared but never edges or faces.

Pauling has described the value of these principles when applied to the problem of the structure of complex compounds. With them he has been able to predict the structure of brookite¹ and of topaz.² Utilized to supplement X-ray diffraction data, they often facilitate the assignment of atomic positions in complex crystals when X-ray data alone are quite inadequate for the purpose.³ They offer a valuable check of the validity of any complex structure analysis.

Certain simplifying and explanatory generalizations regarding the nature of silicates may be derived from these principles.

In the simple orthosilicates, containing aluminum and a divalent metal R^{++} , each oxygen ion would be expected to form one corner of a SiO_4 tetrahedron, an AlO_6 octahedron, and two R^{++} polyhedra to satisfy its valence $1 + \frac{1}{2} + (\frac{1}{4} \text{ or } \frac{3}{4}) =$ approximately 2 (see Table 101). There would therefore be four times as many oxygens as silicons, six times as many oxygens as aluminums, and four times as many oxygens as R^{++} ; in short, the general formula might be predicted as $R_3^{++}\text{Al}_2\text{Si}_3\text{O}_{12}$. The garnets are the most important minerals to confirm this prediction, $(\text{Fe}^{++}, \text{Mn}^{++})_3\text{Al}_2(\text{SiO}_4)_3$.

A coordination of four is to be expected for Al^{+3} in silicates containing a K^+ (C.N. = 8). The valence principle would

¹ PAULING, LINUS, and J. H. STURDIVANT, *Z. Krist.*, **68**, 239 (1928).

² PAULING, LINUS, *Proc. Natl. Acad. Sci.*, **14**, 603 (1928).

³ PAULING, LINUS, *Z. Krist.*, **73**, 97 (1930) (pseudo brookite, Fe_2TiO_6); **83**, 442 (1933) (zuniyite, $\text{Al}_3\text{Si}_5\text{O}_{20}(\text{OH}, \text{F})_3\text{Cl}$).

require four K^+ polyhedra, one silicon tetrahedron, and one aluminum octahedron to have a corner in common, if Al^{+3} is assigned a valence of three. There is not room enough for this arrangement. With aluminum C.N. 4, however, an oxygen can share one SiO_4 , one AlO_6 , and only two K^+ polyhedra, contributing a total of $1 + \frac{3}{4} + \frac{3}{8} = 2$ positive charges to the oxide ion. In a crystal with such a structure there would be one K^+ for each Al^{+3} , a condition which is fulfilled in the important feldspars, such as $KAlSiO_4$, $KAlSi_3O_8$.

An interesting application of these principles of structure is illustrated by the synthesis of the 12-acids of tungsten.¹ Typical example of this group are:

(1)	(2)	(3)	(4)
12-tungsto-boric acid	$H_9(B(W_2O_7)_6)$	$H_3BW_{12}O_{40} \cdot xH_2O$	$H_3(BO_4 \cdot W_{12}O_{18}(OH)_{16})$
12-tungsto-silicic acid	$H_8(Si(W_2O_7)_6)$	$H_4SiW_{12}O_{40} \cdot xH_2O$	$H_4(SiO_4 \cdot W_{12}O_{18}(OH)_{16})$
12-tungsto-phosphoric acid	$H_7(P(W_2O_7)_6)$	$H_2PW_{12}O_{40} \cdot xH_2O$	$H_2(PO_4 \cdot W_{12}O_{18}(OH)_{16})$

These and similar compounds have been systematized and have generally been treated in terms of the Werner coordination theory² which postulates the existence of groups $(BO_6)^{-9}$, $(SiO_6)^{-8}$, and $(PO_6)^{-7}$ in which the oxygen atoms are replaced by $W_2O_7^-$ groups, giving the formulas listed in column 2, above. This classification, however, cannot represent the true state of affairs, for the neutral salts of these acids show that there are usually four less replaceable hydrogen ions than are indicated above. More reasonable and now generally accepted formulas are those listed in column 3.

Although tungsten usually coordinates four oxygen ions to form the tungstate ion, WO_4^- , its size would permit the coordination of six oxygens to form an octahedral unit. Assuming that these octahedra are joined by the sharing of corners by oxygen atoms, a group of 12 WO_6 octahedra may be arranged so that each octahedron shares three corners and has three unshared corners. Since the W^{+6} furnishes a positive charge of one to each corner of its octahedron, the valences of the O^- at shared corners are

¹ PAULING, LINUS, *J. Am. Chem. Soc.*, **51**, 2868 (1929).

² MIOLATI, A., *J. prakt. Chem.*, (2) **77**, 417 (1908); ROSENHEIM, A., *Z. anorg. Chem.*, 1910 to 1917 (numerous papers); EPHRAIM, F., "Inorganic Chemistry," pp. 405-419, Gurney and Jackson, London, 1926.

satisfied. The valences of the 36 oxygens at unshared corners may be satisfied by adding to each a H^+ . Now at the center of this electrically neutral $W_{12}O_{18}(OH)_{36}$ group is a space which is just large enough to admit a BO_4^{-5} , SiO_4^{-4} , or PO_4^{-3} tetrahedron. This tetrahedron tends to stabilize the large groups by introducing large negative ions in a region of positive charge, which also tends to complete a close-packed arrangement. A structure of less than twelve octahedra would not afford sufficient space for this stabilizing tetrahedron. The application of structural principles, based on the size and coordination properties of ions, then, leads to the formulas in column 4, which are consistent with three characteristics of these compounds.

1. The number of replaceable hydrogens agrees with that found by experiment.

2. There is no WO_4^- radical, as such.

3. The large amount of water found in these crystals is accounted for. There are $18H_2O$ per mole as water of constitution. Apparently it is only when the actual water content is more than 18 molecules that water of crystallization is present.

The structures of $H_3PW_{12}O_{40}\cdot 5H_2O$, $H_3PW_{12}O_{40}\cdot 29H_2O$, and related substances recently described¹ are not strictly in accordance with the predictions. Each phosphorus coordinates four oxygens tetrahedrally, each of which shares a corner of three WO_6 octahedra, giving a total of four positive charges for each of these oxygens. The octahedra share edges, a very unusual position for octahedra with such a highly charged central ion as W^{+6} . The radical differs from that predicted by Pauling in that the oxygens surrounding the central phosphorus are also shared by the tungsten, rather than being attached to the phosphorus only. There are no OH^- groups in the radical; all water is present as H_2O molecules, as "ice of crystallization." Keggin recognizes that this structure violates Pauling's valence rule. He pictures the large anion as a whole, composed of a positive center and a negative shell, and not as a group of individual atoms or ions connected by specific valence bonds. Possibly the bonds are nonionic, and this would account for the nonconformity with Pauling's rule. Keggin's anion structure has been

¹ KEGGIN, J. F., *Proc. Roy. Soc. (London)*, A 144, 75 (1934).

confirmed¹ and a detailed analysis has been made of the positions of the water molecules in the 29 hydrate. It is particularly interesting that the H₂O-H₂O distances in the crystal vary only by the probable experimental error from 2.86 Å, although they may be attached by three, four, or seven bonds to neighboring oxygen atoms or water molecules.

Glasses.—The structure of glass has been a problem of great interest for many years. It has been described as a supercooled liquid; it might be considered an amorphous solid. Nothing has been known, however, of the actual structural relationship of the various atoms in a glass.

Glassy silica may be devitrified to form crystalline cristobalite, and the most intense line of the cristobalite diffraction pattern corresponds approximately to the same interplanar spacing as does the one diffuse diffraction ring of the glass. It has therefore been reasoned that the diffuse ring pattern of vitreous silica suggests the presence in the glass of very small crystallites of cristobalite.² Several objections to the crystallite structure have been pointed out.³

Assuming an analogy between the vitreous structure and that of liquids and substances of high molecular weight (*e.g.*, resins) which form amorphous masses without definite melting points, Hägg has suggested that the glass-forming substances are those which contain large, cumbersome groups which cannot move readily into place in a regular crystal lattice as the material solidifies.⁴ He visualizes the chain, sheet, and three-dimensional networks, typified by certain silicates, as fulfilling these requirements. Ca(BO₂)₂, for example, consists of chains of BO₂ triangles sharing corners, the chains held together by Ca⁺⁺. When heat is applied, the Ca-O bonds are said to break first, and the chains are no longer held rigidly in place. Additional heat will break the chains into shorter lengths, still sufficiently large to impart to the melt its high viscosity. They are not small crystallites of the original crystal, however, because they have lost their

¹ BRADLEY, A. J., and J. W. ILLINGWORTH, *Proc. Roy. Soc. (London)*, **A 157**, 113 (1936).

² RANDALL, J. T., H. P. ROOKSBY, and B. S. COOPER, *Z. Krist.*, **75**, 196 (1930).

³ ZACHARIASEN, W. H., *J. Am. Chem. Soc.*, **54**, 3841 (1932).

⁴ HÄGG, G., *J. Chem. Physics*, **3**, 42 (1935).

rigidity and symmetry. When the melt cools, these irregular structural units are too large and inert to assume specific positions in a regular crystal lattice. In contrast to the potentially vitreous crystal, a substance like NaCl or KClO₃ breaks down into small units when heat is applied; because the Na-Cl or K-ClO₃ bonds all break at once, the substances have sharp melting points; and, because the structural units are small, they can reunite in a symmetrical, crystalline pattern.

Orthosilicates do not form glasses, as do the chain, sheet, and network silicates. Sulfur and selenium, which exist in somewhat vitreous states are possessed of chain structures, although the sulfur chain is closed to form a ring of eight sulfur atoms. The orthophosphates form glasses with difficulty, the pyrophosphates, H₄P₂O₇, and metaphosphates, HPO₃, more easily because the lower oxygen ratios in the last two necessitate network structures or at least large anion groups.

The most comprehensive description of the vitreous state was proposed by Zachariasen¹ in 1932 who, unlike Hägg, chose to reason from the crystalline to the vitreous state. His description has since been extended by Warren² whose quantitative treatment of the X-ray diffraction intensities for glasses has led him to support the general picture proposed by Zachariasen and described briefly in the following paragraphs.

Glasses have approximately the same strength as crystals of similar composition, and it may be assumed that the forces holding the atoms or ions together are similar in glass and in crystals.

As in crystals, the atoms in glass must form a three-dimensional network, but unlike that of crystals, this network is not periodic or symmetrical. A comparison of the schematic representations in two dimensions for the arrangement of the atoms in a crystal (Fig. 50a) and of the same atoms in a glass (Fig. 50b) illustrates the difference between the crystal and the glass more clearly than words can express it. This arrangement has been completely confirmed by a recent Fourier analysis by Warren and coworkers.³

¹ ZACHARIASEN, W. H., *J. Am. Chem. Soc.*, **54**, 3841 (1932).

² WARREN, B. E., *Z. Krist.*, **86**, 349 (1933); *Phys. Rev.*, **45**, 657 (1934); *J. Am. Ceram. Soc.*, **17**, 249 (1934).

³ WARREN, B. E., H. KRUTTER, and O. MORNINGSTAR, *J. Am. Ceram. Soc.*, **19**, 202 (1936).

Since the atoms are structurally inequivalent, the breakdown of the network with rising temperature is continuous rather than sharp. Some bonds will break before others, giving rise to large groups which account for the high viscosity of glasses.

The lack of a definite chemical formula for a glass suggests an irregular three-dimensional network, without periodicity or symmetry, and the isotropy and transparency of glass are consistent with such a picture.

Consider the nature of these networks. Goldschmidt¹ found that, for those oxides which can exist in the vitreous form, the

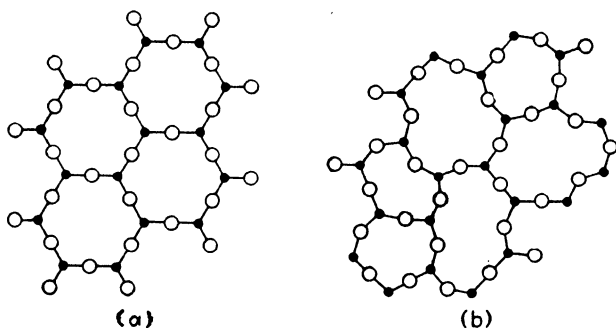

FIG. 50.—(a) Lattice of a two-dimensional crystal A_2O_3 . (b) Lattice of the same compound in vitreo. [From Zachariasen, *J. Am. Chem. Soc.*, **54**, 3841 (1932).]

radius ratio of the ions lies between 0.2 and 0.4 and is usually about 0.3. This suggests a tetrahedral or possibly a triangular coordination of oxygens around the central cation, and it is proposed that these polyhedra form a network by the sharing of corners, as in the typical silicate networks. Inasmuch as glasses devitrify very slowly, it may be further assumed that their energy content is of the same order of magnitude, but slightly higher than that of a crystal of the same composition. This requirement imposes certain limitations on the network structure, *viz.*:

1. An oxygen atom is linked to not more than two cations.
2. The number of oxygen atoms surrounding the cation must be small.
3. The oxygen polyhedra share corners but not edges or faces.
4. At least three corners of each polyhedron must be shared.

¹ GOLDSCHMIDT, V. M., *Skrifter Norske Videnskaps-Akad. Oslo*, no. 8, 137 (1926).

Rules 1 and 3 must be imposed to prevent a regular periodicity in the network and the formation of a true crystal lattice.

Oxides of the general type AO , of which BeO is a typical example, do not satisfy Rule 1, and therefore, although the radius ratio in BeO is within the required limits, it never forms a glass.¹ Oxides of the types A_2O_3 , AO_2 , and A_2O_5 satisfy the rules 1, 3, and 4 if the oxygen atoms form triangles (in A_2O_3) or tetrahedra (in AO_2 and A_2O_5) around each atom A . Oxides AO_3 , A_2O_7 , and AO_4 in which the oxygens form octahedra or cubes around each atom A appear to violate rule 2, for no vitreous forms of these oxides are known. It may be shown geometrically that a continuous network of octahedra or cubes must be periodic and symmetrical.

The cations that satisfy the radius ratio rule, which coordinate either three or four oxygen atoms, and which may be expected to form vitreous oxides are: B^{+3} , P^{+3} , As^{+3} , Sb^{+3} ; Si^{+4} , Ge^{+4} ; P^{+5} , As^{+5} , and probably Sb^{+5} , V^{+5} , Cb^{+5} , and Ta^{+5} . Of these B_2O_3 , As_2O_3 , Sb_2O_3 (probably), SiO_2 , GeO_2 , P_2O_5 , As_2O_5 have already been prepared, and the existence of Sb_2O_3 and V_2O_5 is indicated.

Oxide Glasses in General (A_mB_nO).—It follows that a glass made up of two or more oxides must contain appreciable amounts of one of the oxides listed above. This constituent forms the triangle or tetrahedral framework, and, if it is to meet the requirements listed above, it must include relatively large holes, bounded by oxygen atoms. Into these holes may be fitted the larger basic cations A , always found in glasses.² Because there is no periodicity to the framework, the holes are distributed statistically, and an indefinite number of these holes may be filled by basic ions. Thus glass, as is well known, has no definite chemical formula.

Furthermore, the cations A which may exist in these holes in the framework must meet certain requirements. Their presence must not alter the potential energy of the glass appreciably. Repulsive potentials will arise between cations A and B , and these must be kept at a minimum. Thus, the charge on A must be small and the distance $A-B$ must be large, *i.e.*, the radius of A

¹ But BeF_2 fulfills all these postulated requirements and is known to form a typical vitreous structure.

WARREN, B. E., *Z. Krist.*, **89**, 481 (1934).

² WARREN, B. E., and A. D. LORING. *J. Am. Ceram. Soc.*, **18**, 269 (1935).

must be large. The cations which fulfill these criteria and which are usually found in glasses are: Na^+ , K^+ , Ca^{++} , Ba^{++} , Pb^{++} .

The electrical conductivity of glass may doubtless be attributed to the actual migration of these cations through the network. Pyrex glass, relatively poor in cation *A*, is a very poor conductor. It was shown some years ago that α quartz conducts a current only along the principal axis, in which direction the packing of spheres leaves channels which permit the passage of Li^+ and Na^+ , but not K^+ .¹

The mechanism of conduction, as related to the supposed structure of glass, bears a close resemblance to the phenomenon of base exchange as related to the structure of the zeolites. The glass and zeolite structures are very similar. They differ fundamentally in that the glass framework is without periodicity or symmetry, whereas the zeolite framework is a true crystalline structure.

Although the broad conception of the vitreous structure as described by Zachariassen is essentially the same as that proposed much later by Hägg, Zachariassen's theory is more detailed and precise in its application. Both picture three-dimensional networks which break down into large, slow-moving groups; but Zachariassen goes further in that he offers conditions for the existence of these networks and sets up requirements for their formation without periodicity or symmetry.²

The general picture of the silicate structure which has been described in the foregoing pages has an interesting bearing upon the position of silicon in the periodic table. Considering its neighbors, we find that Mg and Al form continuous ionic lattices; P, S, and Cl form structural groups which lead to weak molecular lattices; C is able to combine with itself to form the chains and rings of organic chemistry; and Si (and apparently Ge) is able to form, through oxygen linkages, $-\text{Si-O-Si-O-Si-O-Si}-$, the SiO_4 tetrahedral polymers, chains, sheets, and networks which differentiate the silicates from the majority of other inorganic salts.

¹ BRAGG, W. H., *Proc. Roy. Soc. (London)*, A 109, 405 (1925).

² ZACHARIASEN, W. H., *J. Chem. Physics*, 3, 162 (1935).

CHAPTER IX

THE STRUCTURES OF WERNER COMPOUNDS

At about the turn of the century, Werner¹ proposed a very ingenious system for the classification of complex compounds. He included the familiar oxygen salts but was more particularly concerned with the molecular structure of the hydrates, ammoniates, and ternary compounds other than oxygen salts, such as K_2PtCl_4 , $KMgF_3$, and the like.

When Werner proposed his coordination theory, it was common practice to write the structural formulas of oxygen salts as follows:



This system failed, however, for compounds like KBF_4 , $KMgF_3$, and many others, and compounds of this type were frequently considered to be double salts, written $KF \cdot BF_3$, $KF \cdot MgF_2$, etc. It was Werner's contention that a compound like $KMgF_3$ does not differ, structurally, from NH_4IO_3 or $CaTiO_3$; and that KBF_4 and $BaSO_4$ are alike in their essential structural characteristics. He proposed that there exists a type of secondary valence in addition to the primary valence, or combining power, as it was then recognized; and that, exercising this secondary valence, ions (usually positive ions) have the power to coordinate other ions of opposite charge, or sometimes neutral molecules, to form complex ions. He observed that the number of ions or molecules which can be coordinated is usually four or six, and suggested that these are arranged tetrahedrally or octahedrally around the central ion. The number of ions or groups which can be held through secondary valences by any central ion has been termed the coordination number of the latter. Werner used the term coordination number in connection with the structure of a single complex molecule,

¹ WERNER, ALFRED, *Z. anorg. Chem.*, **3**, 267 (1893).

whereas the crystal chemist uses it to describe the arrangement of atoms or ions in a crystal, but the term has the same meaning in both cases.

The coordination theory proved very useful in reconciling many of the ammoniates and hydrates with the accepted ideas of valence, particularly when the number of NH_3 or H_2O molecules in the compound is four or six. The familiar $\text{Co}(\text{NH}_3)_6\text{Cl}_2$, for example, was written

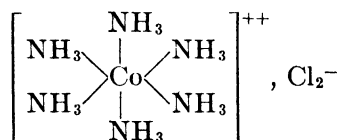

and it was suggested that the ammonia molecules lie at the corners of an octahedron about the Co^{++} , the coordination number of which is six.

The remarkable fact is that Werner's coordination theory was launched with very little supporting experimental evidence. It was largely theoretical, and the data which were available made only indirect contributions to the conclusions drawn. Ever since its proposal, however, data have accumulated which bear witness to Werner's keen insight. First, the electronic theory of valence¹ substituted for the old structural formula $\text{Ba} \begin{array}{c} \diagup \text{O} \diagdown \\ \diagdown \text{O} \diagup \end{array} \text{S} \begin{array}{c} \diagup \text{O} \diagdown \\ \diagdown \text{O} \diagup \end{array}$,

the electronic formula $\text{Ba}^{++} \begin{array}{c} \text{:}\ddot{\text{O}}\text{:} \\ \text{:}\ddot{\text{O}}\text{:}\ddot{\text{S}}\text{:}\ddot{\text{O}}\text{:} \\ \text{:}\ddot{\text{O}}\text{:} \end{array}$, and for KBF_4 ,

$$\text{K}^+ \begin{array}{c} \text{:}\ddot{\text{F}}\text{:} \\ \text{:}\ddot{\text{F}}\text{:}\ddot{\text{B}}\text{:}\ddot{\text{F}}\text{:} \\ \text{:}\ddot{\text{F}}\text{:} \end{array}$$

Then the crystalline structures of many of these complex compounds were determined, and at every turn Werner's predictions have been shown to be well founded. KBF_4 is isomorphous with BaSO_4 ; in crystals of the former, BF_4 tetrahedra

¹LEWIS, G. N., "Valence and the Structure of Atoms and Molecules," Reinhold Publishing Corporation, New York, 1923; *J. Chem. Physics*, **1**, 17 (1933); NOYES, W. A., *Chem. Rev.*, **17**, 1 (1935). A review of electronic theories.

actually exist, whereas the BaSO₄ crystal is built of Ba⁺⁺ and SO₄ tetrahedra. A crystal of Co(NH₃)₆Cl₂ has the structure of CaF₂; the F⁻ lattice points are occupied by the Cl⁻, while Co(NH₃)₆⁺⁺ groups lie at the Ca⁺⁺ lattice points. The NH₃ molecules are located at the corners of a regular octahedron, attached to the central Co⁺⁺ by forces which are essentially nonionic in character.

The Crystalline Structures of the Werner Compounds.—The list of compounds of this type for which structures have been determined grows very rapidly. A few general observations must suffice to show that the elementary rules of crystal chemistry may be extended to include even these complex structures. The majority of the Werner compounds which have been analyzed are those with the general formula A₂BX₆. They generally crystallize in one of the five structures listed in Table 103, even though they include a wide variety of intricate formulas, typified, in part, by those given in this table.

TABLE 103.—THE STRUCTURES OF SOME TYPICAL WERNER COMPLEXES

Structure.	(NH ₄) ₂ PtCl ₆	(NH ₄) ₂ Pt(CNS) ₆	Sr(H ₂ O) ₆ Cl ₂
Examples.	K ₂ PtCl ₆ Co(NH ₃) ₆ Cl ₂ Co(5NH ₃ ·H ₂ O)SO ₄ Br Fe(NH ₃) ₆ (BF ₄) ₂ Cd(NH ₃) ₆ (SO ₃ F) ₂ K ₂ SeBr ₆ Ca(NH ₃) ₆ Br ₂ Co(NH ₂ ·CH ₃) ₆ I ₂ (CH ₃ (C ₂ H ₅) ₃ P) ₂ SnCl ₆ * (NH ₄) ₂ MoO ₃ F ₂ †	Rb ₂ Pt(CNS) ₆ K ₂ Pt(CNS) ₆	Ba(H ₂ O) ₆ I ₂ , and other hexahydrates of alkaline earth halides Ca(H ₂ O) ₆ Br ₂
Structure.	Distorted (NH ₄) ₂ PtCl ₆	Ni(H ₂ O) ₆ SnCl ₆ ‡	
Examples.	(N(CH ₃) ₄) ₂ SiF ₆ § (N(C ₂ H ₅) ₃ CH ₃) ₂ SnCl ₆	Co(NH ₃) ₆ ·Co(CN) ₆ Co(NH ₃) ₅ H ₂ OFe(CN) ₆ Co(NH ₃) ₄ (H ₂ O) ₂ Co(CN) ₆ , etc.	

* COREY, R. B., and R. W. G. WYCKOFF, *Radiology*, **15**, 241 (1930).

† PAULING, LINUS, *J. Am. Chem. Soc.*, **46**, 2738 (1924).

‡ PAULING, LINUS, *Z. Krist.*, **72**, 482 (1930).

§ COREY, R. B., *Z. Krist.*, **89**, 10 (1934).

|| WYCKOFF, R. W. G., and R. B. COREY, *Am. J. Sci.*, **18**, 437 (1929).

The large majority are isomorphous with $(\text{NH}_4)_2\text{PtCl}_6$, which may be described as a CaF_2 lattice, in which the Ca^{++} positions are occupied by the BX_6 radicals PtCl_6^- , $\text{Co}(\text{NH}_3)_6^{++}$, $\text{Co}(\text{NH}_3)_5(\text{H}_2\text{O})^{++}$, $\text{Fe}(\text{NH}_3)_6^{++}$, $\text{Cd}(\text{NH}_3)_6^{++}$, SeBr_6^- , $\text{Co}(\text{NH}_2\cdot\text{CH}_3)_6^{++}$, whereas the F^- positions are occupied by those ions in each compound which correspond to the A_2 ions in the general formula $A_2\text{BX}_6$. In the examples given, the A_2 ions are K_2^{++} , Cl_2^- , SO_4Br^- , $(\text{BF}_4)_2^-$, $(\text{SO}_3\text{F})_2^-$, Br_2^- , I_2^- , $[\text{P}(\text{C}_2\text{H}_5)_3\text{CH}_3]_2^{++}$, and, in the distorted $(\text{NH}_4)_2\text{PtCl}_6$ structure, $[\text{N}(\text{CH}_3)_4]_2^{++}$ and $[\text{N}(\text{C}_2\text{H}_5)_3\text{CH}_3]_2^{++}$. Several of the compounds listed deserve a word of explanation. $(\text{NH}_4)_3\text{MoO}_3\text{F}_3$ contains one too many NH_4^+ groups per molecule to crystallize in the CaF_2 lattice: $(\text{NH}_4)_2\text{MoO}_3\text{F}_3$, however, completes the CaF_2 lattice points, and the additional NH_4 groups occupy positions at the middle of the edges $(0\ 0\ \frac{1}{2}, 0\ \frac{1}{2}\ 0, \frac{1}{2}\ 0\ 0)$ and at the center $(\frac{1}{2}\ \frac{1}{2}\ \frac{1}{2})$ of the unit cube (see Fig. 4, Chap. I). When the group which occupies the F^- points of the CaF_2 lattice becomes too large [as $\text{N}(\text{CH}_3)_4^+$ and $\text{N}(\text{C}_2\text{H}_5)_3\text{CH}_3^+$], it cannot be accommodated without distortion of the lattice and the formation of a unit of structure with slightly unequal dimensions.

The $\text{Ni}(\text{H}_2\text{O})_6\text{SnCl}_6$ structure is roughly isomorphous with CsCl . The lattice points are occupied by $\text{Ni}(\text{H}_2\text{O})_6^{++}$ and SnCl_6^{++} units, both of which are essentially spherical, the water molecules and Cl^- being coordinated octahedrally around the Ni^{++} and Sn^{++} , respectively.

One of the outstanding characteristics of the complex oxygen compounds discussed in an earlier chapter is their low symmetry, as compared with the prevailing cubic and hexagonal symmetry of the binary compounds. In strong contrast, the structures of these more complex Werner compounds are of high symmetry, the cubic CaF_2 and CsCl -like structures predominating. From the crystal chemical viewpoint, the reasons for the occurrence of these simple structures are obvious. The BX_6 group, corresponding to the cation A in the binary type formula, is large; it therefore maintains the $R_A:R_X$ ratio above 0.73, the lower limit for the stability of the CaF_2 arrangement. The octahedral BX_6 group is not easily polarized, and, because of its size, it cannot polarize the anions; the building stones are therefore essentially spherical. A comparison of the structures of

CoI_2 and $\text{Co}(\text{NH}_3)_6\text{I}_2$ serves to illustrate the effect of these factors. The former has the structure of CdI_2 , a layer lattice common among binary compounds for which the radius ratio lies below 0.73 (for CoI_2 , it is 0.36) and in which an easily distorted anion is polarized by a small, highly charged cation. But, let the Co^{++} coordinate six NH_3 molecules; it increases in size, loses its polarizing effect on the I^- , and the conditions favoring the CaF_2 structure become operative.

Of course, the wide range of substitutions which can be made for NH_4^+ , Pt^{+6} , or Cl^- in the $(\text{NH}_4)_2\text{PtCl}_6$ structure bear further witness to the proposition that the structure of a crystal depends upon the relative numbers and relative sizes of its building stones. The CaF_2 structure is very tolerant of variations in the sizes of cations and anions.

Of the Werner compounds, the hydrates and ammoniates deserve special attention. Invaluable pioneering work in the study of the complex ammoniates is linked with the names of Ephraim, Biltz, and Grimm.¹ O. Hassel, S. B. Hendricks, and R. W. G. Wyckoff have been the principal contributors to our knowledge of the crystal structures of the Werner complexes.

Although both hydrates and ammoniates are more apt to crystallize with four or six molecules of water or ammonia, hydrates are known with from 1 to 31 molecules of water and ammoniates with from 1 to 20 molecules of ammonia. Werner's system obviously does not provide for such complexes, and in the past they have proven somewhat baffling from the structural standpoint.

The Structures of Hydrates and Ammoniates.—It now appears that water may exist in a crystal in three different forms, *viz.*:

1. Water of constitution—the structural unit being the OH ion.
2. Water of crystallization—the structural unit being the H_2O molecule, which is coordinated to a definite central ion, or is required in a definite position in the crystal lattice to maintain the stability of the latter.
3. Zeolitic water—molecules of water occupying holes in the lattice and not a factor in its stabilization. Infrared absorption

¹ See in particular, numerous publications of these authors, usually in *Z. anorg. allgem. Chem.* BILTZ, W., *Z. anorg. Chem.*, **139**, 93 (1932), is a summary of work up to that date.

spectra recently determined are said to show that the water is absorbed by weak physical forces only, since the wave lengths of the water bonds in the zeolites are the same as those for pure water.¹

When a hydrate contains four or six H₂O per molecule, it may be anticipated that these are present as water of crystallization, generally coordinated tetrahedrally or octahedrally to the positive ion. Such is the case in BeSO₄·4H₂O, the structure of which is a packing of Be(H₂O)₄⁺⁺ and SO₄⁻ tetrahedra, and in NiSnCl₆·6H₂O, built of Ni(H₂O)₆⁺⁺ and SnCl₆⁻ octahedra. Gypsum has an interesting structure. It is a layer lattice in which layers of Ca and SO₄ ions are separated by planes of water molecules, accounting satisfactorily for the cleavage properties. Possibly each water molecule forms hydroxyl bonds with oxygen atoms of SO₄⁻ in successive layers. Each calcium ion coordinates six O⁻ and two H₂O.² It has been reported that part of the water may be removed from gypsum without any alteration of the lattice.³

Often, when the number of H₂O per molecule is other than four or six, it is found that all or part of the water is strongly held water of constitution,⁴ or is zeolitic water. The former is found in the crystals of many of the hydroxides or hydrous oxides, Al₂O₃·H₂O, Al₂O₃·3H₂O, Zn(OH)₂; in many silicates and in other complex minerals, such as hambergite, built of BO₃ triangles and Be(O₃OH) tetrahedra.⁵

The zeolites, as typified by natrolite, are three-dimensional networks of SiO₄ tetrahedra which lose or take up water molecules without any apparent change in crystal structure. It has also been found that many hydrates other than the zeolites contain so-called "zeolitic" water—water lying in holes in the crystal lattice, more or less apart from the general plan of the structure. The water molecule in Pd(NH₃)₄Cl₂·H₂O and the fifth molecule in CuSO₄·5H₂O are of this nature, as is that in (NH₄)₂C₂O₄·H₂O.⁶ Analysis of the structure of NiSO₄·7H₂O

¹ PASSERINI, L., *Gazz. chim. ital.*, **65**, 534 (1935).

² WOOSTER, W. A., *Z. Krist.*, **94**, 375 (1936).

³ CASPARI, W. A., *Proc. Roy. Soc. (London)*, **A 155**, 41 (1936).

⁴ But in LiClO₄·3H₂O there are six H₂O coordinated to each Li⁺.

⁵ ZACHARIASEN, W. H., *Z. Krist.*, **76**, 289 (1931).

⁶ HENDRICKS, S. B., and M. E. JEFFERSON, *J. Chem. Physics*, **4**, 102 (1936).

shows an arrangement of SO_4 tetrahedra, $\text{Ni}(\text{H}_2\text{O})_6$ octahedra, and an extra molecule of water.¹ Although they resemble the water in zeolites in regard to position, these water molecules differ in that their removal disrupts the crystal lattice; an indication, borne out by their heat of decomposition, that they are more firmly held than typical zeolitic water molecules.

In all of the ammoniates for which the crystal structures are known, the ammonia molecules are coordinated like water of crystallization. The stepwise replacement of 6NH_3 by $6\text{H}_2\text{O}$ in crystals of compounds like $\text{Co}(\text{NH}_3)_6\text{Cl}_2$, without any alteration of the crystal lattice, offers sufficient evidence of the spacial equivalence of the water and ammonia molecules.

The Occurrence and Stability of Hydrates and Ammoniates.—A complex ion is formed when a simple ion attracts other ions or molecules. The central ion of the complex usually attracts molecules which are permanent dipoles, molecules such as water or ammonia; but, in the formation of polyhalides, for example, a complex ion may be formed by the attraction of a molecule, like I_2 , which is not a permanent dipole but becomes polarized in the proper environment.

The conditions for the stability of hydrates and ammoniates are similar to those governing the stability of the complex oxygen salts, discussed previously. The mechanism of complex formation is also, in a general way, akin to the mechanism of solution. Solution in water involves the breakdown of a crystal and the formation of a complex, hydrated ion; solution in ammonia involves similar breakdown with the formation of ammoniated ions.

The coordination of ammonia or water molecules by a simple positive ion may be represented by the reaction

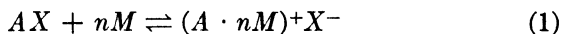

In order that the complex may be formed, the ions A and X in the simple crystal must be separated to make room for n molecules of M . As an approximation, if the reaction is to go to the right, the energy E^2 liberated by the coordination of nM to A must be

¹ BEEVERS, C. A., and C. M. SCHWARTZ, *Z. Krist.*, **91**, 157 (1935).

² More precisely, the course of Reaction (1) is determined by the free energy change. There may be an entropy term sufficiently large to influence the reaction.

greater than the lattice energy U of AX . That is, in the relation

$$Q = E - U \quad (2)$$

the heat of the reaction $AX + nM \rightarrow (A \cdot nM)X$ must be positive. Obviously relatively strong dipoles of small volume, of which water and ammonia are typical examples, favor complex formation of this type.

It is a relatively simple matter to define in a qualitative way the factors which influence complex formation. The term E , in Equation (2), may be evaluated if the attraction of the metallic ion A for molecules M is considered to be due to the formation of a covalent bond or to the influence of polarization. Those atomic and ionic properties which influence the nature of the bonding force and also the degree of polarization have been examined in some detail. In general, it may be stated that the A cations tend to form so-called "ion-dipole" bonds, largely as a result of the polarization of the neutral polar molecule; whereas complex formation by the B cations probably involves considerable covalent bonding energy.

1. *The Size of the Central Ion.*—For ions with the same valence and electronic structure, a small ion tends to form a complex more readily than a large ion, probably because it polarizes the dipole more strongly. Thus $\text{LiCl} \cdot 5\text{NH}_3$ is a stable compound, whereas ammoniates of KCl , RbCl , and CsCl are unknown. CaCl_2 crystallizes with six molecules of water, and the Ba ion in BaCl_2 can coordinate only two. Sodium salts are more frequently hydrated than are potassium salts, as witness:

$\text{Na}_2\text{SO}_4 \cdot 7\text{H}_2\text{O}$	K_2SO_4
$\text{Na}_2\text{SO}_4 \cdot 10\text{H}_2\text{O}$	
$\text{Na}_2\text{CrO}_4 \cdot 10\text{H}_2\text{O}$	K_2CrO_4
$\text{Na}_2\text{CO}_3 \cdot 7\text{H}_2\text{O}$	$\text{K}_2\text{CO}_3 \cdot 2\text{H}_2\text{O}$
$\text{Na}_2\text{CO}_3 \cdot 10\text{H}_2\text{O}$	
$\text{Na}_2\text{Cr}_2\text{O}_7 \cdot 2\text{H}_2\text{O}$	$\text{K}_2\text{Cr}_2\text{O}_7$
$\text{Na}_2\text{PtBr}_6 \cdot 6\text{H}_2\text{O}$	K_2PtBr_6
$\text{NaBr} \cdot 2\text{H}_2\text{O}$	KBr

The influence of the size of the metal ion upon lattice energy must not be overlooked, but the evidence indicates that as A grows smaller its attraction for the neutral dipole increases faster than does the lattice energy.

2. *The size of the anion* bears an important relation to complex formation as it determines lattice energy. Although KCl forms no ammoniates, the complexes $\text{KBr}\cdot 4\text{NH}_3$ and $\text{KI}\cdot 6\text{NH}_3$ are known. Associated with Cl^- , Li^+ can coordinate only 5NH_3 , whereas in the I^- , Li^+ coordinates 7NH_3 . The lattice energies of the potassium or lithium halides decrease in the direction $\text{Cl} \rightarrow \text{Br} \rightarrow \text{I}$, because of the increasing size of the anion. The chlorides and bromides of Al^{+3} , In^{+3} , and Ga^{+3} form ammoniates with 14NH_3 , while the iodide coordinates 20NH_3 . The fluorides

TABLE 104.—MAXIMUM NUMBER OF AMMONIA MOLECULES COMBINING WITH POSITIVE IONS IN HALIDES

Number of NH_3	Positive Ions
20	Ce^{+4} , Au^{+3}
18	Th^{+4} , Zr^{+4} , Sn^{+4}
12	Fe^{+3} , Nd^{+3}
11.5	Sm^{+3}
10	$\text{Co}^{++}(\text{Cl})$, $\text{Zn}^{++}(\text{Cl})$, Tl^{+3} , $\text{Ba}^{++}(\text{I})$
9	Al^{+3} , Sn^{++} , $\text{P}^{+5}(\text{Br})$
8	Ca^{++} , Sr^{++} , Ba^{++} , Pb^{++} , Ti^{+4} , Ta^{+5} , $\text{P}^{+5}(\text{Cl})$
7	$\text{Li}^+(\text{I})$, Nb^{+5}
6.5	$\text{Li}^+(\text{Br})$
6	Be^{++} , Ni^{++} , $\text{Co}^{++}(\text{Br, I})$, Co^{+3} , Fe^{++} , Cu^{++} , Mn^{++} , $\text{Zn}^{++}(\text{Br, I})$, Cd^{++} , Mg^{++} , Pt^{+4} , Cr^{+3} , Si^{+4} , Sb^{+5} , La^{+3} , $\text{Na}^+(\text{I})$, $\text{K}^+(\text{I})$, NH_4^+ , metallic Ca, Sr, and Ba
5.75	$\text{Na}^+(\text{Br})$
5	$\text{Li}^+(\text{Cl})$, P^{+3}
4	Te^{+4} , As^{+3} , Pt^{++} , $\text{K}^+(\text{Br})$
3	Cu^+ , Ag^+ , Ti^+ , Bi^{+3} , In^{+3} , $\text{Rb}^+(\text{Br})$
2	Au^+ , Sb^{+3}
0	Cs^+ , Ce^{++} , $\text{K}^+(\text{Cl})$, $\text{Rb}^+(\text{Cl})$

because of the small anion and high lattice energy form neither hydrates nor ammoniates.¹ Further evidence of the importance of the size of the anion may be found in Table 104, showing the maximum number of NH_3 molecules combining with positive ions in halides.²

Clark recognized the influence of relative ionic sizes upon the stabilities of ammoniates many years ago when he observed that the greater the difference in size of cation and anion, the larger the

¹ KLEMM, W., *Z. anorg. allgem. Chem.*, **163**, 240 (1927).

² CLARK, G. L., *Am. J. Sci.*, **7**, 8 (1924).

cavities in the space lattice available for coordinated molecules, and therefore, the more stable the coordination compound formed.¹ He emphasized the geometric limitations rather than the energy relations.

3. *The Charge of the Central Ion.*—The polarizing power of an ion increases with valence, as does the tendency to covalent bond formation. It is evident from Table 104 that the univalent metal ions coordinate very few ammonia molecules, whereas the complexes containing more than 10NH_3 are those of tri- and tetravalent ions. Univalent ions which coordinate six or more ammonia molecules are rare. The influence of the charge of an ion on its coordination number, as derived by Kossel, has already been described.

The charge of the central ion as it affects lattice energy and thus, indirectly, complex formation must be considered. Hydrates and ammoniates of divalent compounds with high lattice energies, like the oxides and sulfides, essentially ionic lattices, are unknown. Only the halides of divalent metals which crystallize for the most part in relatively weak layer lattices form stable complexes. In structures of this type, with increasing charge of the ion, the attraction for the dipole increases faster than does the lattice energy, and for the di-divalent compounds (oxides and sulfides) the reverse is true.

4. *The charge of the anion* is also significant. Complex formation becomes increasingly difficult as the charge of the anion increases, other things being equal, because under these conditions the strength of the crystal, which must be broken down to admit the coordinated molecules, is increasing.

5. *The Electronic Structure of the Central Ion.*—Cations of the *B* subgroups are more strongly polarizing than those of the *A* subgroups and exert a greater tendency to form the covalent bond. It is not surprising, then, that the 18-shell cations and the cations of the transition elements form complex ions more readily than those with the rare-gas configuration. Typical illustrations of this tendency are given in Table 105.² In

¹ CLARK, G. L., and H. K. BUCKNER, *J. Am. Chem. Soc.*, **44**, 230 (1922); CLARK, G. L., A. J. QUICK, and W. D. HARKINS, *J. Am. Chem. Soc.*, **42**, 2483 (1920).

² VAN ARKEL, A. E., and J. H. DEBOER, "Chemische Bindung," p. 190, S. Hirzel, Leipzig, 1931.

general, hydrates and ammoniates, particularly the latter, are more common among the transition and *B* cations than among the *A* cations.

It has already been noted that, for the *A* cations, the stability of the complex ion increases with increasing size of the anion. For the *B* cations the reverse is true. Thus, although the heat of formation of $\text{Li}(\text{NH}_3)_3\text{Cl}$ is 34.5 kg. cal. and that of $\text{Li}(\text{NH}_3)_3\text{I}$ is 42.0 kg. cal., the heat of formation of $\text{Ag}(\text{NH}_3)_3\text{Cl}$ is 30.0 kg. cal. and

TABLE 105.—INFLUENCE OF ELECTRONIC STRUCTURE OF CENTRAL ION ON COMPLEX STABILITY

Complex	<i>A</i> cations size, <i>A</i>	Heat of formation, kg. cal.	Complex	<i>B</i> cations size, <i>A</i>	Heat of formation, kg. cal.
$\text{Li}(\text{NH}_3)_3\text{Cl}$	0.68	34.5	$\text{Cu}(\text{NH}_3)_3\text{Cl}$		37.2
$\text{Ca}(\text{NH}_3)_4\text{Cl}_2$	1.06	51.8	$\text{Cd}(\text{NH}_3)_4\text{Cl}_2$	1.03	55.5
$\text{Mg}(\text{NH}_3)_3\text{Cl}_2$	0.78	38.7	$\text{Zn}(\text{NH}_3)_3\text{Cl}_2$	0.83	44.2

of $\text{Ag}(\text{NH}_3)_3\text{I}$ is 24.0 kg. cal.¹ This inversion probably may best be attributed to the greater influence of the covalent bond. The lattice energies of the *B* cation halides are augmented much more by the increasing covalent bonding term than are the lattice energies of the *A* cation halides. In the formation of the complex, the energy required to overcome the strongly covalent Ag-I bond is greater than that required to overcome the Ag-Cl bond with a smaller covalent term and the stability of the iodide ammoniate is therefore lower than that of the chloride. In contrast to the data for the chlorides in Table 105, the ammoniates of the bromides and iodides of *A* cations are quite apt to be more stable than those of the bromides and iodides of *B* cations.

6. *The Size of M.*—When the coordinated molecule *M* is small, it occupies less space and therefore less energy is required to separate A^+ and X^- . Again, when *M* is small, the radius ratio limitation will permit the central ion to coordinate a larger number of *M* molecules. Finally, when *M* is small, its dipole center can approach nearer to the coordinating ion, the energy liberated by the formation of the complex will be greater, and the stability

¹ BILTZ, W., and H. G. GRIMM, *Z. anorg. allgem. Chem.*, **145**, 63 (1925).

of the complex will increase. In short, small neutral molecules, of which water and ammonia are the best examples, show the greatest tendency to form complexes.

It is possible for relatively large molecules or groups to form complexes when they are unsymmetrical in shape and the dipole center lies near one end. As shown schematically in Fig. 51,

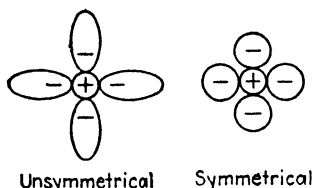

FIG. 51.—Schematic representation of coordination of unsymmetrical molecules as compared with symmetrical molecules.

four sausage-shaped molecules may be as easily held, in regard to available space and distance between centers of charge, as can four spherical molecules of perhaps only one-quarter their size. Organic hydroxides and amines can frequently form complexes, although they are invariably less stable than the corresponding hydrates or ammoniates. The large coordinated molecules form a large complex cation, and the lattice energy of the complex crystal will therefore be small. Thus

Compound	Heat of Formation,* kg. cal.
$\text{Li}(\text{NH}_3)_3\text{Cl}$	34.5
$\text{Li}(\text{NH}_2\text{CH}_3)_3\text{Cl}$	34.4
$\text{Li}(\text{NH}(\text{CH}_3)_2)_3\text{Cl}$	24.1
$\text{Li}(\text{NH}_2\text{CH}_3)_2\text{Cl}$	23.8
$\text{Li}(\text{NH}(\text{CH}_3)_2)_2\text{Cl}$	16.5
$\text{Li}(\text{N}(\text{CH}_3)_3)_2\text{Cl}$	13.1

* SIMON, A., and R. GLAUNER, *Z. anorg. allgem. Chem.*, **178**, 177 (1929); A. E. VAN ARKEL and J. H. DE BOER, "Chemische Bindung," p. 163, S. Hirzel, Leipzig, 1931.

Ethyl alcohol, ether, pyridine, and many other polar molecules are known to form complexes¹ of which $\left(\text{Mg}(\text{C}_2\text{H}_5\text{O})\left(\text{C}_5\text{H}_5\text{N}\right)_5\right)_2$ may be picked as a typical example.

7. *The Polarity of M.*—In general, a molecule with a large dipole moment shows a stronger tendency to form complexes. Again, water and ammonia stand first in this respect.

The molecule with the largest dipole moment is not necessarily the one to form the most stable complexes. The dipole moment of water is greater than that of ammonia, but, because of its

¹ See, for example, a recent review of newly prepared coordination compounds. WARDLAW, W., *Ann. Repts. (London)*, **30**, 96-110 (1933).

greater polarizability, a strong moment may be induced in ammonia by strongly polarizing cations. Thus, in certain instances, its total dipole moment may be greater than that of water.

Of the univalent positive ions, H^+ is the only one small enough to form an ammoniate more stable than the hydrate. When ammonia is added to an acid solution, the ammonium ion, NH_4^+ , is formed at the expense of the hydronium ion, H_3O^+ . For the lithium halides, the ammoniates and hydrates are about equally stable, but the hydrates of the larger alkali halides are more stable than the ammoniates. Of the divalent *A* cations, only the ammoniates of beryllium are more stable than the hydrates.

Other things being equal, the ammoniates of the *B* cations are apt to be more stable than the hydrates. This leads back to the consideration of solubility. Silver chloride is insoluble in water because the attraction of the Ag ion for water molecules is not strong enough to overcome the lattice energy of the crystal; but Ag^+ can attract the ammonia molecule more strongly than it can water, and silver chloride is therefore soluble in ammonia.

Many ammoniates of the *B* cations and transition element cations are prepared by displacing the water from the hydrates by the addition of ammonia, emphasizing further the greater stability of these ammoniates, as compared with the hydrates.

A comparison of the complex-forming tendencies of water and ammonia is not complete without mention of the possible occurrence of the hydrogen bond, much more likely to function as a bonding instrument for water molecules than for ammonia. There are indications that through the formation of hydrogen bonds, water often enters into complex formation where ammonia cannot.

Molecular Complexes.—Ionic fluorides cannot coordinate ammonia because the high lattice energy of the crystals cannot be overcome. However, SiF_4 , PF_5 , etc., fluorides which crystallize in molecular lattices, form ammonia complexes readily, since to expand a weak molecular lattice requires very little energy.

Similarly, H_2S , which is too weak a dipole to form complexes with ionic crystals, forms compounds like $SnCl_4 \cdot 2H_2S^1$ with the molecular crystal of $SnCl_4$.

¹ BILTZ, W., and E. KEUNECKE, *Z. anorg. allgem. Chem.*, **147**, 171 (1925).

Change of Lattice Type by Complex Formation.—It is possible to transform a layer lattice into a molecular lattice or an ionic lattice by the addition of ammonia molecules. One molecule of NH_3 , added to AlCl_3 , joins with the Cl^- to screen the Al^{+3} so that the layer lattice of AlCl_3 is transformed into a typical molecular lattice, in which $\text{AlCl}_3 \cdot \text{NH}_3$ molecules exist as discrete units of structure. From the coordination standpoint, the progressions $\text{AlCl}_3 \rightarrow \text{AlCl}_3 \cdot \text{NH}_3$ and $\text{AlCl}_3 \rightarrow \text{SiCl}_4$ involve a change from a partially ionic to a molecular lattice for the same reason. Four negative or dipolar building units around the positive ion are able to isolate it from other positive ions so that it forms a distinct structural unit. Many years ago it was suggested that the lower amines might be viewed as molecular complexes.¹ If more NH_3 molecules are added to AlCl_3 , an ionic lattice is formed.

CoCl_2 crystallizes as a layer lattice, but $\text{Co}(\text{NH}_3)_6\text{Cl}_2$ forms a typical ionic lattice.

The Nature of the Bonds within a Complex Ion.—A central ion, positive or negative, may coordinate ions or atoms [as in $\text{K}_4\text{Fe}(\text{CN})_6$ or K_4FeF_6], dipole molecules [as in $\text{Pt}(\text{NH}_3)_6\text{Cl}_4$ or $\text{Cr}(\text{H}_2\text{O})_6\text{Cl}_3$], or nonpolar molecules (as in $\text{CsI} \cdot \text{I}_2$). The central element need not be an ion; methane and chlorine, as well as the rare gases,² can form hydrates. Lithium and calcium and other metals form ammoniates.³

Evidently there is no new and unique bonding force which is responsible for all complex formation; rather, the bonds differ in different complexes, and they are types which have already become familiar. In general, they are doubtless intermediate in character and the predominant type may be surmised from characteristic properties.

When the coordinated members are ions or atoms, then the bond is essentially ionic or predominantly covalent or of a truly intermediate character, depending upon the nature of the coordinated group. A consideration of magnetic moments often

¹ CLARK, G. L., *Am. J. Sci.*, **7**, 21 (1924).

² VILLARD, P., *Compt. rend.*, **123**, 377 (1896) (hydrates of methane and chlorine); FORCRAND, R. DE, *ibid.*, **176**, 355 (1923); **181**, 15 (1925).

³ BILTZ, W., and G. F. HUTTIG, *Z. anorg. allgem. Chem.*, **114**, 241 (1920).

gives the clue. Thus Pauling,¹ using the wave mechanics, has calculated that for electron-pair bonds the magnetic moment should be 1.73 and for the ionic bond, 5.91. The experimental values are for $K_4Fe(CN)_6$ and K_4FeF_6 , 2 and 5.88, respectively, suggesting that the bond in $Fe(CN)_6^{-4}$ is essentially covalent,² while that in FeF_6^{-4} is largely ionic. This, after all, is in keeping with the known qualitative characteristics of the CN and F ions. The former is easily polarized and commonly forms a bond more nearly covalent; the F^- is not easily polarized and tends to form an ionic bond in all its compounds.

The bond coordinating neutral polar molecules (*e.g.*, H_2O or NH_3) to an ion [as in $Cr(H_2O)_6^{+3}$] has been termed an ion-dipole bond and is probably essentially ionic in nature when the cation is an 8-shell ion. When water or ammonia is coordinated to an 18-shell ion, characterized by a tendency to form covalent bonds, the coordinating bond is more apt to be of an intermediate type. Thus magnetic susceptibility measurements indicate that while Co^{+3} is paramagnetic, $Co(NH_3)_6^{+3}$ is diamagnetic;³ *i.e.*, electrons have moved from the ammonia molecules toward the complex to form a bond which is essentially covalent.

Experience has shown that the colors of crystals are closely associated with a loosened covalent-ionic bond, and the intense coloring of most of the Werner complexes is suggestive of a loosened, covalent-ionic bond in these compounds.

A general consideration of the magnetic moments of complexes has led to the proposal that trivalent and bivalent manganese, chromium, iron, and cobalt form six strong electron-pair bonds with CN^- and in some cases with other groups, including NH_3 , Cl^- and NO_2 . The bonds in $Co(NH_3)_6Cl_3$, $(Co(NH_3)_5Cl)Cl_2$, and $(Co(NH_3)_4Cl_2)Cl$, for example, are thought to be essentially covalent. Transition groups generally form predominantly electron-pair bonds with CN^- [as in $Fe(CN)_6^{-3}$], ionic bonds with F^- [as in $(FeF_6)^{-3}$], and ion-dipole bonds with water [as in $Fe(H_2O)_6^{+3}$]. With other groups the bond type varies.⁴

¹ PAULING, LINUS, *J. Am. Chem. Soc.*, **54**, 1002 (1932).

² VAN VLECK, V. H., and A. SHERMAN, *Rev. Modern Phys.*, **7**, 206 (1935), believe that there is an appreciable amount of ionic binding in this complex.

³ BILTZ, W., *Z. anorg. allgem. Chem.*, **164**, 245 (1927).

⁴ PAULING, LINUS, *J. Am. Chem. Soc.*, **53**, 1400 (1931).

It is interesting to note that Langmuir recognized these differences in bond types many years ago, although he did not use the same nomenclature in their designation.¹

The unique directional properties of the coordinate bonds in palladous and platinous coordinated compounds probably identify these bonds as covalent.²

The formation of the rare-gas hydrates is said to be due to the polarization of the rare gas. No hydrates are known for helium and neon, the least polarizable of the group.³ Probably van der Waals' forces predominate in this type of compound.

Any description of the nature of the coordinate bond must take cognizance of the prevalence of coordination numbers of four and six in complex ions but must not overlook the existence of a large number of compounds in which the number of water or ammonia molecules is not four or six. In keeping with the point of view which has been followed throughout this book, the prevalence of four and six coordination groups may be attributed to spacial limitations and to the formation of covalent bonds. The sizes of the ammonia and water molecules and of the other ions involved are such that the radius ratios are within the limits for octahedral and tetrahedral coordination. When the complex ion contains more than six water or ammonia molecules, there is reason to believe that the additional molecules are in a second sphere, not so tightly held to the central ion as the nearest neighbors.⁴ The higher ammoniates are much less stable, and in changing from a hexammoniate to a higher one, there is apt to be little color change or volume change.

¹ LANGMUIR, I. J., *J. Am. Chem. Soc.*, **41**, 930 (1919).

² PAULING, LINUS, *J. Am. Chem. Soc.*, **53**, 1388 (1931); and see page 170.

³ VILLARD, P., *Compt. rend.*, **123**, 377 (1896); FORCRAND, R. DE, *ibid.*, **176**, 355 (1923); **181**, 15 (1925).

⁴ CLARK, G. L., *Am. J. Sci.*, **7**, 19 (1924).

CHAPTER X

ISOMORPHISM, MIXED CRYSTALS, POLYMORPHISM

The conditions governing isomorphism and polymorphism have frequently been implied in these pages. Now, with all of the necessary evidence recounted, it will be advantageous to review and summarize this evidence as it pertains to these important phenomena.

Isomorphism.—That the crystal structure of a substance depends upon the relative numbers, relative sizes, and polarization properties of its building stones and upon the kinds of forces holding them together has been shown to apply in a general way to all of the types of compounds whose structures have been analyzed. It necessarily follows that two or more substances containing the same relative numbers of building stones, of the same relative sizes and with similar binding forces will be isomorphous. Innumerable data to confirm this viewpoint may be found in the tables in the preceding chapters.

The variation in size of the building stones which is permissible in a series of isomorphous substances depends, of course, upon the crystal structure of the series. There are long isomorphous rows and short ones. The scheelite structure, for example, is very tolerant of rather wide variations in the size of its ions and forms a long series of isomorphous compounds. The tetragonal structure of PbO and SnO, on the other hand, is very exacting in its requirements for stability and only a short series of crystals with this structure is known.

If their sizes are compatible, ions of different electronic structures may occur in isomorphous crystals. Thus many of the difluorides of both *A* subgroup and *B* subgroup cations are isomorphous with fluorspar, CaF₂.

Isomorphism does not depend upon valence, as countless illustrations will testify. Al₂MgO₄, Li₂WO₄, and Mg₂TiO₄ are isomorphous; NaAlSi₃O₈ and CaAl₂Si₂O₈ are isomorphous; KIO₃, LaAlO₃, and CaTiO₃ are isomorphous, as are RbBF₄ and BaSO₄.

Crystalline substances are isomorphous when the *relative* sizes of their building stones are approximately the same. If these isomorphous substances are to form mixed crystals, the absolute sizes of corresponding building stones must also be within certain limits. From a consideration of a great quantity of empirical data, Goldschmidt has concluded¹ that crystalline miscibility may be expected when the sizes of corresponding atoms or ions in the lattices in question do not vary by more than 15 per cent of the size of the smaller.

There is a further restriction upon the formation of mixed crystals. Even though the absolute sizes of the building stones are within the required limits, it is apparently impossible to form mixed crystals from solution if the substances involved differ greatly in solubility. Thus BaSO_4 and KMnO_4 do not form mixed crystals, although they are structurally isomorphous. The same is true of CaCO_3 and NaNO_3 .²

Because of these restrictions, *isomorphous substances do not necessarily form mixed crystals.*

A number of interesting instances of mixed crystal formation have been described recently which seem to belie the statement that isomorphous substances must contain the same relative numbers of building stones. The case of CaF_2 and YF_3 has long been known and suggests that there may be more Y^{+3} in calcium minerals, masked by the Ca^{++} , than is generally supposed. These fluorides are miscible in the solid state up to 50 per cent of YF_3 . SrF_2 and LaF_3 form mixed crystals.³ The mutual solid solubility of MgCl_2 and LiCl (see page 202, Chap. V) is another case in point. Other pairs miscible in the crystalline state are: $\text{Co}(\text{NH}_3)_6\text{I}_2$ and $\text{Co}(\text{NH}_3)_6\text{I}_3$; $(\text{NH}_4)_2\text{SiF}_6$ and $(\text{NH}_4)_3\text{AlF}_6$; LiMnPO_4 and Li_3PO_4 ; the calcium, strontium, barium, and lead tungstates and molybdates with the rare-earth tungstates and molybdates.

These rather unexpected cases of solid miscibility have recently been considered in the light of the existence of the

¹ GOLDSCHMIDT, V. M., *Skrifter Norske Videnskaps-Akad. Oslo*, no. 2, p. 83 (1926).

² BILTZ, W., and SCHACKMAN, *Z. anorg. allgem. Chem.*, **218**, 139 (1934).

³ KETELAAR, J. A. A., and P. J. H. WILLEMS, *Rec. trav. chim.*, **56**, 29 (1937).

so-called "subtraction" lattice and the formation of interstitial crystals.¹

The structure of $(\text{NH}_4)_3\text{AlF}_6$ is the same as that of $(\text{NH}_4)_2\text{SiF}_6$, except that ammonium ions have been introduced into vacant positions in the $(\text{NH}_4)_2\text{SiF}_6$ structure.² In the mixed crystals, then, the $\text{Si}(\text{Al})\text{F}_6$ framework is constant, but the number of lattice positions occupied by ammonium ions increases as the number of silicons replaced by aluminum increases.

The isomorphism of $\text{Co}(\text{NH}_3)_6\text{I}_2$ and $\text{Co}(\text{NH}_3)_6\text{I}_3$ is thought to be possible because even the unusually large I ion may enter the CaF_2 lattice of $\text{Co}(\text{NH}_3)_6\text{I}_2$ interstitially, since the $\text{Co}(\text{NH}_3)_6^{++}$ group is still larger and offers spacious interstices.³

LiMnPO_4 and Li_3PO_4 , both of the olivine type, appear to be featured by a dominating anion.⁴ Mg^{++} , Fe^{++} , Mn^{++} , and Li^+ may be located in the largest octahedral interstices in the deformed, close-packed hexagonal packing of oxygen ions. The number of these octahedral interstices which are occupied does not seem to be important to the stability of the crystal.

Solid solutions of alkaline earth tungstates or molybdates with the rare-earth tungstates or molybdates are said to result in an increase in the number of vacant cation positions as the concentration of the trivalent cation rises.⁵

It is evident, of course, that the crystalline pairs which have been discussed are not strictly isomorphous; that they are to be taken as evidence of the miscibility of nonisomorphous pairs under special conditions and not as evidence of the isomorphism of substances in which the relative numbers of building stones differ. In short, *the formation of mixed crystals is not always evidence of the isomorphism of the pure components.*

Polymorphism.—Polymorphism is a morphotropic structural change brought about, not by chemical substitution, but by an alteration of thermodynamical factors. Polymorphism, therefore, is to be anticipated for a compound, the relative sizes of the

¹ HÄGG, G., *Z. Krist.*, **91**, 114 (1935).

² PAULING, LINUS, *J. Am. Chem. Soc.*, **46**, 2748 (1924).

³ HASSEL, O., and H. KRINGSTAD, *Z. anorg. allgem. Chem.*, **209**, 281 (1932).

⁴ ZAMBONINI, F., and F. LAVES, *Z. Krist.*, **83**, 26 (1932).

⁵ ZAMBONINI, F., and G. R. LEVI, *Rend. accad. Lincei*, **149**, 225, 303, 377, 462 (1925).

building stones of which place it near the limit of an isomorphous series. An AX_2 compound, for example, characterized by a radius ratio of approximately 0.70, might be expected to exist in two allotropic forms, the fluorite and the rutile structures. The relative sizes of the ions in CaCO_3 and KNO_3 are in such a critical range, and these two substances may crystallize in either the calcite or the aragonite structure, depending upon temperature and pressure conditions or upon the presence of certain impurities.

Buerger and Bloom¹ have recently written an interesting historical account of polymorphism and have proposed a general theory of the phenomenon. Briefly, they suggest that, although the static arrangement of atoms in a crystal under negligible pressure may be expected to correspond to the lowest energy state, other arrangements are possible with rising temperature. That is, the most stable configuration at absolute zero may prove to be an unstable vibrational mode when the atomic clusters begin to vibrate appreciably.

In several instances the rotation of radicals in crystals has been shown to cause polymorphism. Molecular rotation in crystals has been treated from the wave-mechanical standpoint by Pauling.² He predicted that in the high temperature modifications of NH_4I , NH_4Br , and NH_4Cl the NH_4 ions are rotating and should be considered to be spherical rather than tetrahedral. The five forms of NH_4NO_3 have been shown to bear a definite relation to the rotation of the NH_4^+ and NO_3^- radicals.³ In a hexagonal form, stable below -18°C ., both radicals are fixed; in a second form, stable between -18 and $+32^\circ\text{C}$., the NH_4^+ rotates and the NO_3^- is fixed. There is a third form, stable between $+32$ and $+84^\circ\text{C}$. and orthorhombic; a fourth, tetragonal, stable between 84 and 125°C ., in which the NO_3 group rotates about the normal to the plane of the group; and the high temperature form, isomorphous with CsCl , in which both radicals are rotating freely and may therefore be considered as spherical building blocks in the crystal. The polymorphism of NaN_3 ,⁴

¹ BUERGER, M. J., and M. C. BLOOM, *Z. Krist.*, **96**, 182 (1937).

² PAULING, LINUS, *Phys. Rev.*, **36**, 430 (1930).

³ KRACEK, F. C., S. B. HENDRICKS, and E. POSNJAK, *Nature*, **128**, 410 (1931).

⁴ KRACEK, F. C., *J. Am. Chem. Soc.*, **53**, 1183, 2609, 3339 (1931).

Na_2SO_4 ,¹ RbNO_3 , CsNO_3 , and TlNO_3 ² have also been attributed to rotating molecular groups.

In a recent discussion of the philosophical implications of rotating molecules in crystals, Smyth³ has observed that rotating groups constitute, in a sense, a partial transition to the liquid state. In liquid ammonium nitrate at 175°C., ammonium and nitrate ions are vibrating about points which move about very slowly; in crystalline ammonium nitrate at 165°C. the only difference is that the points about which the ions move are fixed. To one observing the interior of the substance this difference would be trifling.

Barth has recently classified the several mechanisms of polymorphic changes, depending upon the special manner in which the atoms in the crystal lattice rearrange themselves.⁴ There are three: (1) The sluggish or delayed inversion change of one type of structure into another. This is a complete breaking up of the lattice, as in the quartz-tridymite transition. (2) Polysyngony, rapid inversions; a dislocation of all or some of the atoms, with or without thermal rotation, such as α -cristobalite \leftrightarrow β -cristobalite. (3) Gradual changes, initiated by thermal rotation and not accompanied by any changes in the positions of the atoms, such as in NaNO_3 . In cases 2 and 3 the types of structure are preserved.

Crystal Synthesis.—The silicates are difficult to study because of the great strength of their crystals, as manifested in high melting points, limited solubilities, slow reaction rates, hardness, and refractivity. The same difficulties are experienced with the titanates and zirconates.

Goldschmidt has called attention⁵ to the possibility of applying the crystal chemical conception of isomorphism to the study of the chemical constitution of these resistant compounds. Given any silicate mineral, it should be possible to build or synthesize a crystal, isomorphous with the silicate, but much weaker, by assembling ions of corresponding sizes and polariza-

¹ KRACEK, F. C., and C. J. KSANDA, *J. Phys. Chem.*, **34**, 1741 (1930).

² FINBAK, C., and O. HASSEL, *Z. physik. Chem.*, **B 35**, 25 (1937).

³ SMYTH, C. P., *Proc. Am. Phil. Soc.*, **76**, 485 (1936).

⁴ BARTH, T. F. W., *Am. J. Sci.*, **27**, 273 (1934).

⁵ GOLDSCHMIDT, V. M., *Skrifter Norske Videnskaps-Akad. Oslo*, no. 8, p. 127 (1926).

tion properties, but of lower valences. Consider the synthesis of a weak model for ThO_2 : First, this is an AX_2 compound, and the model must also be an AX_2 compound. To accomplish the purpose of the synthesis, the valences of *both* of the model ions must be lower than those of ThO_2 , and to assure isomorphism, the size (and to some extent the polarizing power) of the model cation must be approximately that of Th^{+4} , and the size (and to some extent the polarizability) of the model anion must be approximately that of O^- . Thus F^- (1.33 Å), but not OH^- (1.40 Å), may be substituted for O^- (1.40 Å) and Ca^{++} (1.06 Å) for Th^{+4} (1.10 Å). Thus we derive CaF_2 , a weakened model of ThO_2 , as indicated by their relative melting points. Similarly, one may choose LiCl as a weakened MgO , or MgF_2 as a weakened model for TiO_2 . A group of crystals and their weakened models are given in Table 106. The strengths of

TABLE 106.—WEAK MODELS OF STRONG CRYSTALS

Strong crystals		Weak models	
Compound	Ionic radii	Compound	Ionic radii
MgO	0.78 1.40	LiF	0.78 1.33
TiO ₂	0.64 1.40	MgF ₂	0.78 1.33
ThO ₂	1.10 1.40	CaF ₂	1.06 1.33
SiO ₂	0.39 1.40	BeF ₂	0.34 1.33
SrTiO ₃	1.27 0.64 1.40	KMgF ₃	1.33 0.78 1.33
BaSO ₄	1.43 0.3 1.40	KBF ₄	1.33 0.24 1.33
KAlSi ₂ O ₆	1.33 0.57 0.39 1.40	RbLiBe ₂ F ₆	1.43 0.78 0.34 1.33
CaMgSi ₂ O ₆	1.06 0.78 0.39 1.40	NaLiBe ₂ F ₆	0.98 0.78 0.34 1.33
KCbo ₃	1.33 0.73 1.40	KNiF ₃	1.33 0.69 1.33

complex ionic crystals are evidently determined by the same factors which control the strength of the crystals of binary compounds, *viz.*, the distance between ions and the magnitude of their electrostatic charges. BaSO_4 decomposes at $1580^\circ\text{C}.$, whereas the weakened model KBF_4 decomposes at about $500^\circ\text{C}.$ BaSO_4 is practically insoluble in cold water (0.00011 g. per 100 g. water), but KBF_4 is appreciably soluble (1.42 g. per 100 g. water). KCbo_3 is harder (4.5) than KNiF_3 (3.5).

A rather convincing demonstration of the extent to which this model building may be carried in some cases is afforded by the

comparison of Zn_2SiO_4 and its weak model Li_2BeF_4 , certain characteristic properties of which are shown in Table 107.¹

In contrast to many fluoberyllates, which usually solidify in glassy form, $NaLiBe_2F_6$, the weakened model of diopside, crystallizes readily from the melt. It forms double-refracting crystals with the cleavage similar to that of diopside, and X-ray diffraction data show the crystal structure and lattice dimensions of the two to be similar.

TABLE 107.—PROPERTIES OF Zn_2SiO_4 AND ITS WEAKENED MODEL Li_2BeF_4

	Zn_2SiO_4	Li_2BeF_4
Ionic radii.....	0.83 0.39 1.40	0.78 0.34 1.33
Lattice dimensions.....	$a = 8.04A, c = 9.34A$ $c/a = 1.161$	$a = 7.60A, c = 8.85A$ $c/a = 1.165$
Crystallographic properties.	Rhombohedral prismatic habit; cleavage parallel to $10\bar{1}0$ and 0001	Rhombohedral prismatic habit; cleavage parallel to $10\bar{1}0$ and 0001
Optical properties.....	Positive double refraction, rather weak = 0.02 approx.	Positive double refraction, very weak = 0.006 approx.
Index of refraction.....	1.70 approx.	1.30 approx.
Hardness.....	5.5	3.8
Melting point.....	1509.5	470 approx.
Solubility.....	Insoluble in water	Very soluble in water

Weak models of silicate glasses may be constructed. BeF_2 is the weak model of SiO_2 ; and $NaLiBe_3F_8$ and $KLiBe_3F_8$ are weakened, glass-forming models of the feldspars. These fluoberyllate glasses in general have an average hardness of 3 to 4, as compared with 5 to 7 for the silicate glasses. Their indexes of refraction are remarkably low, a majority being below 1.33. Doubtless their unusual optical properties could be put to very practical use were it not for objectionable properties, such as high solubility, which are also characteristic of a weakened model.

Although the desirability of synthesizing weakened crystal models has been stressed, the building of strengthened models may be equally important in certain cases. Nature takes advan-

¹ GOLDSCHMIDT, V. M., *Skriifter Norske Videnskaps-Akad. Oslo*, no. 8, p. 132 (1927)

tage of the principles which control the strength of crystals. The proposed mechanism of the formation of dental enamel is an interesting case in point.¹ Provided with carbon, oxygen, nitrogen, sulfur, phosphorus, fluorine, chlorine, calcium, and sodium, nature's problem is to form a substance which will crystallize from water solution at about 37°C. and form crystals of the greatest possible hardness. To satisfy these requirements those ions with the highest valences are selected, *viz.*, Ca^{++} and PO_4^{-3} . Because the formation of a hydrate or acid salt is inhibited, the calcium phosphate is built as a complex in a calcium halide. Thus we have the mineral apatite, $\text{Ca}_5(\text{PO}_4)_3\text{Cl}(\text{F})$. Since the hardness of a crystal increases with decreasing interionic distances, the smallest halogen ion produces the hardest crystal, and dental enamel is said to have the formula $\text{Ca}_5(\text{PO}_4)_3\text{F}$.

"COMPOUNDS" OF VARIABLE COMPOSITION

Frequently in the foregoing pages mention has been made and examples given of so-called compounds of variable composition. The rapid increase in the number and variety of descriptions of such substances is one of the more recent and interesting contributions of X-ray analysis to crystal chemistry and must exert a significant influence on some of the most fundamental chemical concepts.

The intermetallic compounds have been found to be so generally variable in composition that at the moment the term compound has been abandoned and they are spoken of as intermediate phases, to include both solid-solution-like and compoundlike phases. But the distinction between a solid solution and a compound can only be one of arbitrary definition. The crystal chemist may logically define a compound as an aggregation of atoms of two or more elements mutually attracted to each other and having a characteristic crystal structure. If this definition is accepted, then there are compounds of variable composition. For convenience these may be divided into three groups: substitution, addition, and subtraction compounds. Examples of all three have already been given, but it will be useful to emphasize them again.²

¹ NEUBURGER, M. C., Ahrens Sammlung chem. u. chem.-tech. Vortrag, p. 108, 1933.

² For an interesting classification of crystal structures with "defect lattices," see L. W. Strock, *Z. Krist.*, **93**, 285 (1936).

1. Substitution Compounds.—These compounds are characterized by completely filled lattices; variation in composition is affected by the continuous replacement of one atomic species by another within certain limits. Compounds of this type are common among the silicates. There is the phenomenon of base exchange in the zeolites and certain clays. The transition from tremolite, $\text{H}_2\text{Ca}_2\text{Mg}_5(\text{SiO}_3)_8$, to hornblende, $\text{H}_2(\text{Ca}, \text{Na}, \text{K})_{2-3}(\text{Mg}, \text{Fe}, \text{Al})_5(\text{Al}, \text{SiO}_3)_8$ is accomplished by the replacement of silicon atoms by aluminum. NaAlSiO_4 may be derived, structurally, from SiO_2 , cristobalite, by the substitution of aluminum for silicon and the interstitial addition of sodium. In a sense, mixed crystals may be considered as compounds of this type. In all these the essential nature of the bonding forces is not changed during substitution.

2. Addition Compounds.—To this group belong those intermediate alloy phases such as γ phases which can dissolve an excess of one (or both) components without any change in crystal structure. The interstitial alloys of carbon, nitrogen, and hydrogen with the transition elements are addition compounds. With the addition of an excess of one component, there is a noticeable change in the nature of the bonding forces.

3. Subtraction Compounds.—These are not necessarily compounds of variable composition in the same sense as are the substitution and additional compounds, although they may be. Their compositions, however, always vary slightly from simple stoichiometric proportions. Their crystals are characterized by incompletely filled lattice points. The vacant iron positions in the FeO and FeS structures have already been mentioned.

M_3P_2 is said to crystallize as a deformed fluorite structure, the phosphorus on a face-centered cubic lattice, and the magnesium atoms occupying only three-fourths of the available tetrahedral position.¹

$\gamma \text{Al}_2\text{O}_3$ and $\gamma \text{Fe}_2\text{O}_3$ are cubic, like the spinels but with one-ninth of the cation positions vacant.² This explains their isomorphism with the spinels and the ability of spinel to dissolve an excess of alumina.

¹ STACKELBERG, M., and R. PAULUS, *Z. physik. Chem.*, **B 22**, 305 (1933).

² HÄGG, G., *Z. physik. Chem.*, **B 29**, 95 (1935); KORDES, E., *Z. Krist.*, **91**, 193 (1935).

In Li_3PO_4 it is said that three-fourths of the larger octahedral positions of the olivine structure are occupied by lithium; while in the isomorphous olivine only one-half of these positions are filled by magnesium and in monticellite, MgCaSiO_4 , one-half by magnesium and calcium.¹

The sodium tungsten bronzes, with the general formula Na_xWO_3 , crystallize in the perovskite structure. When $X = 1$, all the perovskite lattice points are filled, and the crystal is golden yellow. As the sodium content decreases, the color of the crystal darkens and the valence of the tungsten ion increases. There is a decrease in the size of the unit cell as the sodium content decreases, but there is no change in the arrangement of the ions. In the blue-violet bronzes, $\frac{2}{3}$ of the original sodium ion places are vacant.²

$\gamma\text{Al}_2\text{O}_3$ is said to have $1\frac{1}{3}$ molecules per unit cell, the $2\frac{2}{3}$ aluminum atoms distributed statistically but not equally in the 12 large openings between four oxygens. The cations preserve a definite lattice-building tendency.³

In the high temperature form of Cu_2Se , containing four molecules in the unit cell, four copper atoms fill tetrahedral positions to form the zinc-blende structure CuSe , whereas the remaining four copper atoms are said to be distributed statistically in 36 other positions.⁴

Thus, in four typical subtraction lattices the percentages of unoccupied lattice points are:

$\gamma\text{Al}_2\text{O}_3$	11 per cent
$\alpha\text{Ag}_2\text{HgI}_4$	25 per cent
$\gamma'\text{Al}_2\text{O}_3$	78 per cent
αAgI	95 per cent

The high temperature form of AgI is said to crystallize so that two silver atoms are distributed statistically in 42 lattice positions. If this is so, then all semblance of a silver lattice is gone; the silver atoms are free to move into any available space in a rigid iodine lattice. They are truly fluid in the usual meaning of the term, moving in an environment of crystalline iodide.

¹ ZAMBONINI, F., and F. LAVES, *Z. Krist.*, **83**, 26 (1932).

² HÄGG, G., *Z. physik. Chem.*, **B 29**, 192 (1935).

³ VERWEY, E. J. W., *Z. Krist.*, **91**, 317 (1935).

⁴ RAHLFS, P., *Z. physik. Chem.*, **B 31**, 152 (1936).

Such structures as these emphasize the truth of the statement: "The sharp division of solid, liquid, and gas has long been recognized; but, as is customary in most science, continued investigation has dulled the sharpness."¹

What of the law of definite proportions and the law of multiple proportions, which are taught, as the very roots of the science, to every beginner in chemistry? If these are laws, then removed from their jurisdiction are all intermetallic compounds, many silicates and organic compounds, many phosphides, sulfides, selenides, and tellurides, certain oxides and iodides, and some complex crystals. A "law" subject to so many exceptions is of doubtful value. It is to be thought of, rather, as merely a definition of a certain restricted type of compound; one, indeed, in which the elements "are always present in the same proportion by weight." The "law" was formulated in a day when the known chemical compounds were comparatively simple ones. To be sure, Berthollet said at that time that it was not proper to apply the law to all chemical compounds, but he was overruled. But today it appears that Berthollet's viewpoint has been completely, if somewhat tardily, substantiated.

¹ SMYTH, C. P., *Proc. Am. Phil. Soc.*, **76**, 485 (1936).

CHAPTER XI

THE STRUCTURES OF ORGANIC CRYSTALS

Organic crystals are generally molecular. The points on the crystal lattice are occupied by molecules, and, because these are large, the unit cells are large. Unless the molecules are nearly spherical, the symmetry of an organic crystal is low.

In the analysis of organic crystals, the problem of crystal chemistry is to study the size and shape of the molecules and the nature of the intra- and intermolecular forces. The structural organic chemist, of course, has always been interested in the arrangement of the atoms in molecules. Crystal structure analyses have provided independent confirmation of the accepted stereochemical concepts of organic chemistry; they have refined and endowed with greater physical reality the tetrahedral carbon atom and the planar benzene ring.

More recently, by precise Fourier analysis of a limited number of organic crystals, the crystal chemist has been able to push beyond the bounds of the structural organic chemist in two directions. Firstly, the lengths of bonds between atoms within molecules have been accurately determined. It has been shown that the lengths and valence angles of the C-C (aliphatic) and C-C (aromatic) bonds are different and characteristic. The nature of other typical linkages are closely related to the bond lengths. Secondly, in certain cases when the stereochemistry of the organic chemist could give no conclusive evidence in favor of a particular structure, the crystal structure analysis has served to define specifically the arrangement of the atoms in a molecule.

The structures of hundreds of organic crystals have been described in part. However, the present discussion will be limited to a consideration of the few key structures which have furnished the most accurate knowledge of the shapes and sizes of molecules, the building stones of organic crystal chemistry, and of the interatomic distances.

The Structural Analysis of Organic Crystals.—Organic crystals baffle complete analysis because the individual atoms are hard to detect and identify by the usual X-ray methods. Carbon, nitrogen, and oxygen, being of comparable weights, all have about the same diffraction effect upon X-rays and can be distinguished, one from the other, only with considerable difficulty. Hydrogen is too light to diffract X-rays appreciably and the positions of hydrogen atoms in organic crystals are, as a rule, speculative.

Organic compounds containing heavier elements lend themselves more readily to the accurate determination of their crystal structure. For this reason, the organometallic series, of which the substituted ammonium compounds are typical examples, have been investigated with considerable success.¹ Here the positions of the metal atoms may be readily defined and with this framework, the lighter groups may be located with more assurance. Reference has already been made, in the discussion of Werner complexes, to this type of compound.

Fortunately, with the complete atomic positions known in a few fundamental structures, the approximate atomic positions in many related compounds need not be determined by direct X-ray analysis. They may be inferred with considerable accuracy when the unit cell and symmetry of the crystal have been established. This is made possible because of the existence of homologous series and because of the rigidity of the framework of an organic molecule, even though it may be subjected to the addition, subtraction, or substitution of certain of its members. In the analysis of a new structure, therefore, the crystal chemist determines the size of the unit cell, the space group, and the symmetry of the crystal. The general arrangement of the molecules in the cell may usually be established from the X-ray diffraction data, supplemented by knowledge of the shape of the molecules, of the interatomic distances in related compounds, and of the optical properties, the habit, and the cleavage of the crystal. Ultimately, the atomic positions may be approximated in many structures by a trial-and-error process, assuming for the interatomic distances values found in similar structures. Finally, in many cases where the approximate atomic positions have been

¹ See particularly the work of R. W. G. Wyckoff and coworkers; and more recently R. B. Corey.

found, one or more projections of the structure by double Fourier analysis make possible the accurate and direct determination of exact atomic positions as well as the distribution of electron density.

As carbon is the framework of all organic molecules, so the arrangements of carbon in diamond and in graphite may be taken as the points of departure from which the distribution of carbon atoms in all organic molecules appear to be derived. In the light of X-ray diffraction studies, the tetrahedral bonds of the carbon, long assumed by the organic chemist, have become a physical reality. They exist in the diamond, which may be considered a giant molecule built of carbon atoms, each of which coordinates tetrahedrally four others, to which it is held by electron-pair bonds 1.54 Å in length. Graphite, it will be recalled, is a layer lattice. Each carbon is bound to three others in the same plane at a distance of 1.42 Å, the distance between planes being 3.40 Å.

Crystals of Aliphatic Compounds.—Structurally, the aliphatic crystals are offspring of the diamond. The tetrahedral bonds of carbon are characteristic of aliphatic molecules large or small. CBr_4 and Cl_4 are cubic, isomorphous with SnI_4 . The unit cell contains eight molecules, in each of which the halogen atoms are coordinated tetrahedrally to the carbon atom. Tetramethyl methane, $\text{C}(\text{CH}_3)_4$, is probably isomorphous with these. In erythritol, $\text{C}(\text{CH}_2\text{OH})_4$, the carbon bonds are said to be tetrahedral.¹

The effect of paraffin wax upon X-rays was observed as early as 1913² and the structures of long-chain aliphatic compounds, the waxes and fatty acids, have been studied with considerable interest ever since. The structure of the paraffin $\text{C}_{29}\text{H}_{60}$ has been most accurately described.³ The crystal is orthorhombic; $a = 7.45$, $b = 4.97$, $c = 77.2$ —a long, narrow unit cell in which the long chains of the hydrocarbon lie parallel to the c axis. The

¹ However, small deviations from the exact tetrahedral angles may be expected when unlike groups are attached to the carbon atom, and such deviations are said to be permitted by the quantum mechanical treatment of tetrahedral bonds. VAN VLECK, J. H., and A. SHERMAN, *Rev. Modern Phys.*, **7**, 203 (1935).

² FRIEDRICH, W., *Z. Physik*, **14**, 317 (1913).

³ MULLER, A., *Proc. Roy. Soc. (London)*, **A 120**, 437 (1928); *Trans. Faraday Soc.*, **25**, 347 (1929).

crystalline paraffin, therefore, consists essentially of sheets 77.2 Å thick. The distance between carbon atoms along the *c* axis is not 1.54 Å, as in diamond, but it is possible to measure very accurately the distance between alternate carbon atoms (*viz.*, twice the distance between carbon atoms) as 2.54 Å. Now, if the distance 1.54 Å between carbon atoms is assumed, and it is further predicated that the carbon atoms form a zigzag chain and that the angle of the zigzag is $109^{\circ}28'$, the tetrahedral angle; then the calculated distance *A* in Fig. 52 is 2.52 Å. The agreement with the experimental value of 2.54 Å has been accepted as evidence of a zigzag structure for the long-chain compounds and for the persistence of the tetrahedral carbon bonds even

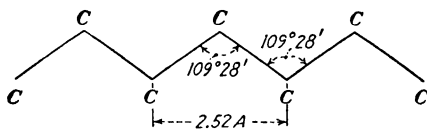

FIG. 52.—Section of a zigzag hydrocarbon chain showing probable arrangement of carbon atoms.

in these structures. This structure is said to account satisfactorily for the alternating properties of long chains with odd- and even-numbered carbon atoms.¹ In even-numbered carbon chains, the end groups are parallel; in odd-numbered chains, they lie at an angle to each other. This difference in orientation necessitates a difference in the inclination of the chains in the layers which, in turn, influences the physical properties of the crystal. Although in the paraffins the long-chain molecules are oriented perpendicularly in the layers, this is not true of all long-chain compounds. An increase in layer thickness of less than 1.26 Å for each carbon atom added to the chain is indicative of an inclined molecule; and the thickness of the layer is not a measure of the length of the molecule in such cases.

The zigzag aliphatic chain was long held in some doubt because the structure of *n*-amyl ammonium chloride, $\text{NH}_3\text{C}_5\text{H}_{11}\text{Cl}$, and similar substances isomorphous with $\text{NH}_3\text{CH}_3\text{I}^2$ seemed to require a straight chain with a C-C distance of only 1.05 Å. However, the conception of molecular rotation in crystals has reconciled

¹ MULLER, A., *Proc. Roy. Soc. (London)*, A **124**, 317 (1929).

² HENDRICKS, S. B., *Z. Krist.*, **68**, 189 (1928); **74**, 29 (1930).

the apparent inconsistencies.¹ Long zigzag chains, rotating about the x -axis would be compatible with the size of the unit cell of $\text{NH}_3\text{C}_6\text{H}_{11}\text{Cl}$. In fact, it has been shown that at liquid-air temperatures the cross section of the unit cell is actually larger by the amount required to accommodate stationary zigzag chains.² Conversely, paraffin crystals heated almost to the melting point produce modified diffraction patterns indicative of a rotation of the molecules around their long axes.³

The available evidence indicates that cyclohexane forms a puckered ring, geometrically similar to that found in diamond.⁴ This is of particular interest in comparison with the structure of the aromatic carbon ring, since the puckered ring of cyclohexane emphasizes the persistence of the tetrahedral carbon bonds in aliphatic compounds.

The Structure of Aromatic Compounds.—The benzene ring, as it exists in graphite, is the standard building stone of all crystals of aromatic compounds. Early doubts as to the choice between a planar and a puckered ring have been entirely dispelled. The experimental evidence is overwhelmingly in favor of the planar ring, as it exists in such compounds as hexamethyl benzene,⁵ hexachlorobenzene,⁶ durene,⁷ naphthalene,⁸ anthracene,⁹ *p*-diphenyl benzene,¹⁰ *s*-triphenyl benzene,¹¹ and chrysene.¹² In general, the condensed ring systems form rigid, flat molecules and as their number increases, the parallel sheets formed appear to approach more closely the actual structure of graphite.

Graphite, on the other hand, may be reversibly oxidized to graphitic acid, the benzene-ring layers being pried apart from

¹ PAULING, LINUS, *Phys. Rev.*, **36**, 430 (1930).

² HENDRICKS, S. B., *Nature*, **126**, 167 (1930).

³ MULLER, A., *Proc. Roy. Soc. (London)*, **A 127**, 417 (1930).

⁴ HASSEL, O., *Z. Elektrochem.*, **37**, 540 (1931).

⁵ LONSDALE, K., *Proc. Roy. Soc. (London)*, **A 123**, 494 (1929); *Trans. Faraday Soc.*, **25**, 352 (1929).

⁶ LONSDALE, K., *Proc. Roy. Soc. (London)*, **A 133**, 536 (1931).

⁷ ROBERTSON, J. M., *Proc. Roy. Soc. (London)*, **A 141**, 594 (1933).

⁸ ROBERTSON, J. M., *Proc. Roy. Soc. (London)*, **A 142**, 674 (1933).

⁹ ROBERTSON, J. M., *Z. Krist.*, **84**, 321 (1933); *Proc. Roy. Soc. (London)*, **A 140**, 79 (1933).

¹⁰ PICKETT, L. W., *Proc. Roy. Soc. (London)*, **A 142**, 333 (1933).

¹¹ LONSDALE, K., *Nature*, **133**, 67 (1934).

¹² IBALL, J., *Proc. Roy. Soc. (London)*, **A 146**, 140–153 (1934).

3.4 to 6.9 Å, and by subsequent hydration to 11.3 Å.¹ This large reversible change in crystal structure was apparently unique, but it has since been found that the clay mineral montmorillonite takes up water in a similar manner.²

$B_3N_3H_6$ is interesting because, judging from the electron-diffraction data,³ it appears to have the same structure as benzene. This is not surprising when one recalls that the number of planetary electrons is the same for the B_3N_3 group as for C_6 and, further, that graphite and BN are isomorphous. The B-N distance has been reported as $1.47 \pm .07$ Å, as compared with C-C distance of 1.42 Å in graphite.

Thus, the detailed analysis of a few organic crystals has demonstrated:

1. The existence of the tetrahedral carbon atom in the aliphatic compounds.
2. The existence of the plane benzene ring, as found in graphite, as the fundamental structural unit in aromatic compounds.

Recent crystal analyses of benzoquinone⁴ and *p*-dinitrobenzene⁵ suggest distorted benzene rings (see page 343). The structure of the latter is unusual in some respects and should be verified. Every organic chemist knows that the properties of these compounds are not wholly those of the typical aromatic, and it is not surprising to find by this independent means that the true benzene ring probably has no real physical existence in benzoquinone and *p*-dinitrobenzene.

The very accurate structural analysis of cyanuric triazide⁶ is perhaps the most impressive example thus far of a case in which the crystal chemist has been able to surpass the structural organic chemist in defining precisely the shape of a molecule. It has been proven that the triazide group is linear but not centro-

¹ HOFMANN, U., and A. FRENZEL, *Ber.*, **B 63**, 1248 (1930).

² HOFMANN, U., K. ENDELL, and D. WILM, *Z. Krist.*, **86**, 340 (1933); NAGELSCHMIDT, G., *Z. Krist.*, **93**, 481 (1936).

³ STOCK, A., and R. WIERL, *Z. anorg. allgem. Chem.*, **203**, 228 (1931).

⁴ ROBERTSON, J. M., *Nature*, **134**, 138 (1934); *Proc. Roy. Soc. (London)*, **A 150**, 106 (1935).

⁵ JAMES, R. W., G. KING, and H. HORROCKS, *Proc. Roy. Soc. (London)*, **A 153**, 225 (1935).

⁶ KNAGGS, I., *Proc. Roy. Soc. (London)*, **A 150**, 576 (1935); *J. Chem. Phys.*, **3**, 241 (1935); HUGHES, E. W., *J. Chem. Phys.*, **3**, 1 (1935).

symmetrical, *i.e.*, the distance between the nitrogen attached to the ring and the central nitrogen is 1.26 Å; while the distance between the outer nitrogens is 1.11 Å. This lends support to Sidgwick's¹ suggestion that the structure is the result of a resonance between $-\text{N} = \text{N} \rightleftharpoons \text{N}$ and $-\text{N} \leftarrow \text{N} \equiv \text{N}$.

Recent analyses of metaldehyde² and paraldehyde³ are of considerable interest. The latter is a six-membered ring of alternating carbon and oxygen atoms, the C-O distance being 1.43 ± 0.02 Å. To each carbon in the ring are attached a hydrogen atom and a methyl group, the C-C distance being 1.54 Å. Metaldehyde, a tetramer of formaldehyde, forms an eight-membered C-O ring; a rather unusual structure to the organic chemist. In neither of these aldehydes is there an aldehyde group as such. In both, the angles in the ring are tetrahedral, thus forming a staggered ring typical of aliphatic carbon. In metaldehyde the methyl groups are said to be rotating.

Interatomic Distances.—In Table 108 are listed the distances between two carbon atoms in the same molecule, as found experimentally in the several crystalline compounds indicated.

It is notable that the different types of C-C linkages are manifested in a very real manner by the distances between the carbon atoms. However, for a given type, the interatomic distance is remarkably constant, irrespective of the other atoms with which the carbon atoms are associated and regardless of the properties of the compound as a whole, whether it be solid or gaseous. As further evidence of this, it has been stated that the heats of rupture of the C-C links are almost identical in two such widely different substances as diamond and solid ethane.⁴

Of course, the most significant result of the determination of interatomic distances is the well-established difference in length of the C-C (aliphatic) and C-C (aromatic) bonds.

Although the interatomic distances in benzoquinone are not so accurately known as most of those in Table 108, they are of

¹ SIDGWICK, N. V., *Trans. Faraday Soc.*, **30**, 801 (1934).

² PAULING, LINUS, and D. C. CARPENTER, *J. Am. Chem. Soc.*, **58**, 1274 (1936) (X-ray diffraction).

³ CARPENTER, D. C., and L. O. BROCKWAY, *J. Am. Chem. Soc.*, **58**, 1270 (1936) (electron diffraction).

⁴ FAJANS, KASIMIR, *Ber.*, **53**, 643 (1920); **55**, 2826 (1922).

particular interest. There are two C-C distances in the distorted ring, 1.50 Å and 1.32 Å. But these distances are characteristic

TABLE 108.—C-C DISTANCES, INTRAMOLECULAR

Link	Substance	Distance, Å	Method	Reference	
C—C Aliphatic	Diamond	1.54	Crystal structure	<i>a</i>	
	<i>n</i> -Paraffins	1.58	Crystal structure	<i>b</i>	
	C ₃ (CH ₃) ₆ , side chain	1.55	Crystal structure	<i>c</i>	
	Metaldehyde	1.54 ± .03	Crystal structure	<i>d</i>	
C—C Aromatic	Dibenzyl H ₃ C-CH ₃	1.58	Crystal structure	<i>k</i>	
	Graphite	1.42	Crystal structure	<i>d</i>	
	C ₆ (CH ₃) ₆	1.42	Crystal structure	<i>c</i>	
	Naphthalene	1.45	Crystal structure	<i>e</i>	
	Anthracene	1.45	Crystal structure	<i>f</i>	
	Durene	1.41	Crystal structure	<i>g</i>	
	Benzene vapor	1.39	Electron scattering	<i>j</i>	
	Dibenzyl C-C	1.41	Crystal structure	<i>k</i>	
	C (aromatic)-C (aliphatic)	Dibenzyl C-CH ₂	1.47	Crystal structure	<i>k</i>
		C ₆ (CH ₃) ₆	1.48	Crystal structure	<i>c</i>
Durene		1.48	Crystal structure	<i>g</i>	
C—C (between rings)	<i>p</i> -Diphenylbenzene	1.48	Crystal structure	<i>h</i>	
C=C	Ethylene	1.31	Electron-diffraction	<i>i</i>	
	Allene	1.34		<i>i</i>	
C≡C	C ₂ Br ₂	1.20	Crystal structure	<i>l</i>	

a. EHRENBERT, W., *Z. Krist.*, **63**, 320 (1926).

b. MULLER, A., *Proc. Roy. Soc. (London)*, **A 114**, 542 (1927); **A 120**, 437 (1928).

c. LONSDALE, K., *Proc. Roy. Soc. (London)*, **A 123**, 494 (1929).

d. PAULING, LINUS, and D. C. CARPENTER, *J. Am. Chem. Soc.*, **58**, 1274 (1936).

e. ROBERTSON, J. M., *Proc. Roy. Soc. (London)*, **A 142**, 674 (1933).

f. ROBERTSON, J. M., *Proc. Roy. Soc. (London)* **A 140**, 79 (1933); *Z. Krist.*, **84**, 321 (1933).

g. ROBERTSON, J. M., *Proc. Roy. Soc. (London)* **A 141**, 594 (1933).

h. PICKETT, L. W., *Proc. Roy. Soc. (London)* **A 142**, 333 (1933).

i. PAULING, LINUS and L. O. BROCKWAY, *J. Am. Chem. Soc.*, **59**, 1223 (1937).

j. PAULING, LINUS, and L. O. BROCKWAY, *J. Chem. Phys.*, **2**, 867 (1934).

k. ROBERTSON, J. M., *Proc. Roy. Soc. (London)*, **A 146**, 473 (1934); **A 150**, 348 (1935).

l. BROCKWAY, L. O., and H. LEVI, in publication. See BROCKWAY, L. O., *Rev. Modern Phys.*, **8**, 261 (1936).

of the C-C bond (aliphatic) and the C=C bond, respectively, and imply that in this modified ring the double bonds are fixed, as shown in Fig. 53. The C-O distance of 1.14 Å may be taken

as an indication that this is a double bond, C=O, although the length of the C=O bond in urea is 1.25 Å.

From the relative values for the single, double, and triple bonds of carbon, the lengths of other double and triple bonds have

TABLE 109.—OBSERVED AND CALCULATED VALUES OF THE LENGTHS OF SINGLE, DOUBLE, AND TRIPLE BONDS; AND EXPERIMENTAL EVIDENCE OF THEIR ACCURACY

C	Values obsd., Å	N	Values, Å	O	Values, Å
C—C	1.54	N—N	1.40	O—O	1.32
C=C	1.34	N=N	1.22	O=O	1.14 (obsd.)
C≡C	1.20	N≡N	1.10 (obsd.)	O≡O	1.02

Link	Obsd., Å	Calc., Å	Source	Method	Reference
C—N	1.44	1.47	(CH ₂) ₆ N ₄	Crystal structure	<i>a</i>
C—N	1.37	1.47	Urea	Crystal structure	<i>b</i>
C—N	1.37	1.47	Thiourea	Crystal structure	<i>c</i>
C—N	1.47	1.47	Methyl azide	Electron diffraction	<i>d</i>
C—N	1.38	1.47	Cyanuric triazide	Crystal structure	<i>f</i>
C=N	1.31	1.28	Cyanuric triazide	Crystal structure	<i>f</i>
C=S	1.64	1.62	Thiourea	Crystal structure	<i>c</i>
C=O	1.25	1.24	Urea	Crystal structure	<i>b</i>
C≡N	1.18	1.15	Cyanogen	Electron diffraction	<i>e</i>
N=N	1.26	1.22	Methyl azide	Electron diffraction	<i>d</i>
N=N	1.26	1.22	Cyanuric triazide	Crystal structure	<i>f</i>
N≡N	1.11	1.10	Cyanuric triazide	Crystal structure	<i>f</i>
N≡N	1.10	1.10	Methyl azide	Electron diffraction	<i>d</i>

a. DICKINSON, R. G., and A. L. RAYMOND, *J. Am. Chem. Soc.*, **45**, 22 (1923).

b. WYCKOFF, R. W. G., *Z. Krist.*, **81**, 102 (1932).

c. WYCKOFF, R. W. G., and R. B. COREY, *Z. Krist.*, **81**, 386 (1932).

d. BROCKWAY, L. O., and LINUS PAULING, *Proc. Natl. Acad.*, **19**, 860 (1933).

e. BROCKWAY, L. O., *Proc. Natl. Acad.*, **19**, 868 (1933).

f. KNAGGS, I., *Proc. Roy. Soc. (London)*, **A 150**, 576 (1935); *J. Chem. Phys.*, **3**, 241 (1935).

been calculated,¹ assuming the percentage change in each case to be the same as the observed change in lengths of the C—C bonds. Table 109 shows the lengths of these bonds and also the calculated and observed values for several links for which the

¹ PAULING, LINUS, and L. O. BROCKWAY, *J. Am. Chem. Soc.*, **59**, 1223 (1937).

experimental values are known with reasonable certainty. Disagreement between observed and calculated values may be due to resonance between two or more bond types as discussed below.

The electron diffraction method of analysis of the structure of organic molecules, particularly of gases, is now being used very effectively. A very complete review discussing this method, its accuracy, and the significance of the results obtained, has recently appeared.¹ It should be noted that, in general, the earlier values of interatomic distances, determined by electron diffraction are not particularly accurate.



FIG. 53.—Structure of benzoquinone, as it may be deduced from X-ray data.

With the increasing degree of accuracy of the experimental values for interatomic distances, it may be possible to estimate the nature of the single-bond-double-bond resonance in molecules; and an attempt to do this has already been made.² A curve showing the relation between interatomic distance and

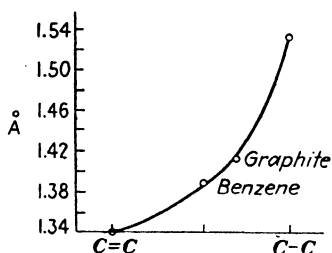

FIG. 54.—Estimation of single-bond-double-bond resonance from carbon-carbon distances. [PAULING, LINUS, and L. O. BROCKWAY, *J. Am. Chem. Soc.*, **59**, 1223 (1937).]

single-bond-double-bond resonance may be plotted as shown in Fig. 54, using the known C-C distances shown there. It has been assumed that the C-C bond in benzene is equivalent to $1\frac{1}{2}$ and that in graphite to $1\frac{1}{3}$. Resonance between two structures apparently leads to an interatomic distance which is nearly as small as the smallest of those for an individual structure. Thus, C-C in benzene is 1.39 A, yet the resonance is probably about equal between C-C (1.54 A) and C=C (1.38 A).

Similar curves may also be plotted to indicate resonance between C—O and C=O, or N—O and N=O.

Using these empirical curves, one may obtain data like those recorded in Table 110.

¹ BROCKWAY, L. O., *Rev. Modern Phys.*, **8**, 231 (1936).

² PAULING, LINUS, L. O. BROCKWAY, and J. Y. BEACH, *J. Am. Chem. Soc.*, **57**, 2705 (1935). PAULING, LINUS, and L. O. BROCKWAY, *J. Am. Chem. Soc.*, **59**, 1213 (1937).

It is proposed that the average C-C distance in aromatic hydrocarbons should approach the value 1.42 Å as the size of the

TABLE 110.—INTERATOMIC DISTANCES VS. BOND TYPE

Molecule	Bond	Obsd. length, Å	Amount of double bond
Cyclopentadiene.....	C—C	1.46	0.20
<i>p</i> -Diphenylbenzene.....	C—C	1.48	0.14
Biphenyl.....	C—C	1.48	0.14
Cyanogen.....	C—C	1.43	0.29
Diacetylene.....	C—C	1.43	0.29
Urea.....	C—N	1.37	0.28

hydrocarbon increases. Thus for benzene C-C = 1.39 Å; and in naphthalene, anthracene, and phenanthrene C-C = 1.41 Å.

TABLE 111.—C-C MINIMUM APPROACH IN ADJACENT MOLECULES

Distance, Å	Compound	Reference
3.64	C ₂ H ₆	<i>a</i>
3.69	C ₆ (CH ₃) ₆	<i>a</i>
3.72	C ₆ H ₁₂ N ₄	<i>a</i>
3.82	<i>m</i> -C ₆ H ₄ (NO ₂) ₂	<i>a</i>
3.6–3.9	C ₂₉ H ₆₀	<i>a</i>
3.40	Graphite (between layers)	<i>a</i>
3.87	Durene	<i>b</i>
3.60	Naphthalene	<i>c</i>
3.70	Anthracene	<i>d</i>
3.92	<i>p</i> -Diphenylbenzene	<i>e</i>
3.83	Cellulose (between chains)	<i>f</i>
3.7 (HC-CH)	Dibenzyl	<i>g</i>
4.1 (HC-CH ₂)		
3.45(C-CH)		
3.36(C-O)	Benzoquinone	<i>h</i>
3.62 (O-O)		

a. HENDRICKS, S. B., *Chem. Rev.*, **7**, 431 (1930).

b. ROBERTSON, J. M., *Proc. Roy. Soc. (London)*, **A 141**, 594 (1933).

c. ROBERTSON, J. M., *Proc. Roy. Soc. (London)*, **A 142**, 674 (1933).

d. ROBERTSON, J. M., *Proc. Roy. Soc. (London)*, **A 140**, 79 (1933).

e. PICKETT, L. W., *Proc. Roy. Soc. (London)*, **A 142**, 333 (1933).

f. MARK, H., and K. H. MEYER, *Ber.*, **69**, 593 (1928).

g. ROBERTSON, J. M., *Proc. Roy. Soc. (London)*, **A 146**, 473 (1934).

h. ROBERTSON, J. M., *Nature*, **134**, 138 (1934).

There seems to be a remarkably constant distance of closest approach between carbon atoms of neighboring molecules in a variety of organic crystals. Some of the more accurately known values, calculated from X-ray data, are listed in Table 111. These values are, at best, subject to greater error than the intramolecular distances in Table 108.

The Hydrogen Domain.—As yet, nothing has been said concerning the size of the hydrogen atom in organic crystals. Its position, of course, cannot be detected by X-rays. The lengths of the C-H and N-H bonds, as determined from band spectra, are about 1.13 Å and 1.08 Å, respectively.¹

The C-H distance in metaldehyde has been reported as 1.06 Å.²

There has recently been made an ingenious attempt to define the "atomic domain" of hydrogen in organic crystals through a stereochemical approach.³ It is concluded that the hydrogen radius depends upon the nature of the atom to which it is bound. The following values for the hydrogen-domain radius are deduced:

	Angstrom
In methane.....	1.002 (molecules of CH ₄ rotating)
In ethane.....	1.165
In ethane.....	0.96 (molecules rotating)
(CH ₂) ₆ N ₄	1.29
Anthracene.....	1.29
Naphthalene.....	1.29
(CH ₃) ₆ C ₆	1.06

It is interesting to note that when a group containing hydrogen rotates in the crystal lattice there is less room for each hydrogen to occupy than when the group is stationary.

There is another side to this picture of the atomic domain of hydrogen. The constant distance of closest approach between carbon atoms of neighboring molecules in a variety of organic crystals, as listed in Table 110, is only slightly greater than the distance between layers in graphite, where there are no hydrogen atoms. Evidently presence of hydrogen atoms does not affect the C-C distance much.

¹ HENDRICKS, S. B., *Chem. Rev.*, **7**, 431 (1930).

² PAULING, LINUS, and D. C. CARPENTER, *J. Am. Chem. Soc.*, **58**, 1274 (1936).

³ MACK, E., *J. Am. Chem. Soc.*, **54**, 2141 (1932).

One of the more interesting applications of crystal chemistry in the field of organic chemistry is the study of the optical activity of the substituted diphenyls. Attempts have been made to determine the smallest groups or atoms which, in the ortho positions of the molecules, can prohibit rotation as a result of steric hindrance. With four ortho methyl groups, racemization is negligible;¹ with F and NH₂, racemization occurs, but very slowly.² Assuming the usual atomic radii for F (0.68) and N (0.71), these atoms in the ortho positions should not hinder rotation. Based on this and other evidence,³ Sidgwick has proposed the existence of an "envelope" of rather constant thickness, surrounding organic molecules, and suggests that this extension of the sphere of influence of the F and NH₂ groups is sufficient to cause steric hindrance⁴ in the diphenyls. The evidence presented by the diphenyls hardly justifies the assumption of an envelope completely surrounding the entire diphenyl molecule. Rather, it need merely be assumed that the spheres of mutual repulsion of the nitrogen and fluorine atoms extend beyond the chosen atomic radii.

Intramolecular Forces in Organic Crystals.—In the hydrocarbons, the bonds between molecules are weak van der Waals' forces. The fairly constant minimum distance of approach of molecules in a number of different crystals (see Table 111) suggests that these forces are of the same order of magnitude in every case.

Local dipoles, such as the hydroxyl group, present in sugars and alcohols, cause such molecules to pack together so that dipoles of opposite signs are adjacent.

Electrostatic forces, similar to those in ionic crystals, are to be found in crystals of the amino acids and other organic acids and bases. In general, heteropolar compounds in which forces stronger than van der Waals' forces are operative, build stronger crystals, and crystals with greater regularity of molecular arrangement.

¹ MOYER, W. W., and R. ADAMS, *J. Am. Chem. Soc.*, **51**, 630 (1929).

² KLEIDERER, E. C., and R. ADAMS, *J. Am. Chem. Soc.*, **53**, 1575 (1931).

³ The greater distance between atoms in neighboring molecules, owing to their mutual repulsion, than between linked atoms in the same molecule.

⁴ SIDGWICK, N. V., *Ann. Repts. (London)*, **29**, 67 (1932).

Summary.—The organic crystal is built of molecules.

The structure of an organic crystal depends primarily upon the shape of its building stones and the nature of the forces between them.

The tetrahedral carbon atom in aliphatic compounds leads to somewhat spherical building stones in the simpler molecules; long zigzag chains, as in the paraffins; or puckered rings, as in cyclohexane.

The flat benzene ring, as found in graphite, is the fundamental building stone in all aromatic crystals.

The accurate measurement of interatomic distances within molecules has shown that:

1. The length of the aliphatic C-C bond is constant in different compounds, as is that of the aromatic C-C bond; but the two are characteristically different.

2. The lengths of single, double, and triple C-C bonds are different and characteristic.

3. In general, the length of a bond is indicative of the nature of the bond.

CHAPTER XII

NATURAL FIBERS

In the preceding chapters it has been shown in a general way how the properties of crystals are related to the size and bonding properties of their building stones. The properties which have been discussed are those of *single* crystals of the substance in question. In most of our dealings with solids, however, we handle a quantity of material usually containing a large number of relatively small crystals. Calcium carbonate does exist in nature in large single crystals (Iceland spar), but in its most used forms (marble, chalk, and the like) the individual crystals are very small. A single crystal is usually recognized by its transparency, even though it may not be perfectly formed; whereas an aggregate of small crystals, even though just as compact in appearance, will generally not be transparent. In most inorganic crystalline aggregates the crystals are assembled in a haphazard manner, showing no regularity in their arrangement. There is, however, a large group of important substances, mostly animal or vegetable in nature, known as fibers. The properties of these fibers are due not only to the properties of the single crystals of which they are built, but also to the arrangement or orientation of these crystals in the whole. Thus although both are essentially cellulose, the tensile strength of a cotton fiber approximates that of copper wire, while that of a ramie or flax fiber may approach the strength of a good steel wire. Any study of the nature of solids, then, would be incomplete without a consideration of these crystalline fibers.

The characteristic orientation of the building stones of all fibers may be easily visualized with the aid of the following illustration. Consider a large number of matchsticks (tetragonal crystals, if the cross section is square) piled carelessly in random orientation. If an ordinary rake be drawn through this pile there will be a tendency for the long axes of the match "crystals"

to line up in the direction in which the rake has been drawn. The same tendency for "lining up" may be noticed when grass is raked. Moreover, the greater the number of times the pile is raked, the more perfect will be the alignment of the matches. A clear picture of this simple process should be kept in mind throughout the following discussion, for it simulates in a general way the forces which are responsible for the production of all natural and artificial fibers. The match "crystals" have assumed a preferred orientation, lying with their long axes more or less parallel. In the following pages we shall use the term "fiber" in this structural sense—aggregate in which crystals or chain molecules show a preferred orientation, the direction in which they are aligned being that of the fiber axis. It is because of this orientation that the properties of fibers along the fiber axis differ from their properties perpendicular to this axis and differ greatly from a random aggregate of crystals of the same chemical composition.

It should be evident that the greatest tendency for fibering will be found among those substances whose molecules are long; and the longer they are in comparison to their width the more apt are they to form fibers. Obviously, if we were to rake marbles instead of matchsticks, no end of raking would cause any orientation or fibering of these spherical bodies.

Because of their long molecules, fibering is very common among long-chain hydrocarbons and their derivatives, and the existence of fibers, of groups of molecules all oriented in the same direction, has far-reaching influences of great practical importance. The melting points of the long-chain hydrocarbons depend upon the fact that in the solid form these molecules lie side by side. The relatively weak molecular or van der Waals' forces between parallel long molecules are naturally greater than those between shorter molecules of the same general character. A common characteristic of the paraffins and indeed of all chain compounds and more complicated fibers is that the chemical formulas of a whole series are essentially similar, but there is a gradual change in physical properties dependent upon the length of the molecule. This change would not occur if the molecules were not fibered, *i.e.*, if they did not align themselves in parallel bundles. Matches in a brush heap arrangement would not be expected to increase

their attraction for each other as their length increased. If anything, the longer sticks would be more loosely packed when there is no orderliness in this packing. But, because the molecules tend to line up parallel as they become appreciably longer than they are wide, only the first four of the paraffin hydrocarbons are gases, the next ten or twelve are liquids at room temperatures, and from then on, the long chains form solids, increasing in solidity as the number of carbon atoms in the chain increases, from the relatively soft vaseline, to paraffin wax and harder waxes. Carried to the extreme, this picture leads to an interesting possibility of the existence of molecules so long that, when they form fibers, the forces holding the chain molecules together are actually stronger than the forces within a simple molecule. When this situation exists, as the temperature of the substance is raised, the intramolecular forces give way before the intermolecular. It is a fact that hydrocarbons containing more than seventy carbon atoms in the chain decompose rather than melt.¹ Fortunately, from the practical standpoint, it is a characteristic of natural textile fibers to decompose before they melt.

Any child knows that it is much more fun to slide on a soft, velvety carpet than on a rag rug. It is the pile of the carpet which makes it so much more slippery. For the same reason, the lubricating oils reduce friction and function as good lubricants; their molecules tend to line up parallel to each other and perpendicular to the bearing surface, forming a submicroscopic pile which functions exactly like that of the rug. Astbury has pointed out an interesting comparison of this lubrication by long-chain oils with the lubrication by graphite. "If slipping on oil is like slipping on the carpet, then slipping on graphite is like stepping on a mat on a polished floor." There is no need to describe the too familiar result of this unfortunate move.

This tendency of long-chain molecules to lie parallel results in a fairly rigid layer, and the rigidity increases with the length of the molecules. Anyone who has tried to put up a ready-made picket fence, one of those rolls of wooden pickets wired together,

¹ CAROTHERS, W. H., J. W. HILL, J. E. KIRBY, and R. A. JACOBSON, *J. Am. Chem. Soc.*, **52**, 5299 (1930), have suggested that the upper limit of distillability of long-chain polymers may lie at a molecular weight of 1200 to 1500.

the COOH has a tendency to do the same thing, and it does, but it is unable to drag the rest of the molecule after it into the water. That would be a case of the tail wagging the dog. As a result, we find oleic acid molecules aligned on the surface of the water, the active ends submerged in the water, the other ends standing up on the surface like the pile of a carpet.

The soaps, like sodium or potassium oleate, are long-chain molecules with active heads. When a solution of soap comes in contact with oil or grease, the soap molecules are torn between two attractions. The molecules as a whole resemble the long molecules of the oil, and oil and soap therefore mix readily, but the active ends of the soap retain their strong attraction for water. If we could peer into the emulsion formed when oil and water are shaken up with soap or when grease is removed from the hands by washing with soap and water, we should see tiny droplets composed of oil and soap molecules and, on the surface layer of the drops, all the soap molecules lined up with their active ends pointing outward towards the water. Emulsifying agents and wetting agents, so useful in industry, are long, fiber molecules which tend to line up parallel to each other forming a relatively tough layer.

In general, the molecules of oils and soaps are about ten times longer than they are thick. They are, in reality, the babes in the family of fibers, hardly worthy of the name when we compare them with some of the very long textile fibers, fibers which may be several hundred times as long as they are thick. In comparing the occurrence and behavior of these simple molecular fibers with the more complicated ones to be discussed, it is helpful to keep in mind the picture of the pile of a carpet as it is related to the woven fabric. This pile consists of relatively short fibers, secured at one end and roughly parallel, the other ends more or less free to move about. For the woven fabric, much longer fibers must be used, and they are fixed in a more permanent relationship to each other in the yarn. These conditions are necessary to give strength to the yarn. The lengths of the simple molecules bear about the same relation to the molecules of the common textile fiber as the pile of a carpet bears to the fibers of a woven fabric.

One of the most interesting generalizations to which the X-ray study of the structure of growing things has led is that all the

materials of the plant and animal world which are commonly referred to as fibers are also fibers in the structural sense just described. The uninitiated do not ordinarily think of cellulose, wool, and the like as crystalline substances, but microscopic and X-ray evidence indicate that there is an orderly arrangement of the building stones in these materials. However, in structures produced by organisms, forces are active which are not ordinarily present in solutions during the formation of crystals *in vitro*, and it may be the presence of these forces which prevents a clean-cut crystalline regularity in the structure.

X-RAY ANALYSIS OF FIBER ORIENTATION

X-ray analysis has proved very useful in the investigation of the structures of fibers, particularly in the determination of the manner of orientation of the groups of crystals in the fiber. The general procedure is very simple, although for special purposes various refinements may be employed. A beam of X rays is allowed to pass through a small bundle of the fibers, and the diffraction pattern is recorded on a photographic film.

Although it is not our purpose to undertake the interpretation of X-ray diffraction patterns, a word about the patterns produced by fibers should be of considerable interest.¹ When an X-ray beam is passed through a single crystal, the resulting pattern is one of symmetrically distributed points, as shown in Fig. 56. Now, if this single crystal were powdered very fine, and the X-ray beam passed through the powder, according to the law of averages, the crystals would lie in every possible position with respect to the X-ray beam. The spots of the single crystal Laue pattern would be extended to the familiar concentric rings of the Debye-Scherrer or powder pattern. There is another common type of diffraction pattern known as the rotation pattern, obtained by rotating a single crystal around only one of its axes, set perpendicular to the direction of the X-ray beam. A rotation pattern is shown in Fig. 57*a*. Under these conditions, only a limited number of the planes in the crystal lattice come into positions defined by the Bragg law to permit diffraction by the

¹ For a detailed and very readable discussion of this subject, see W. T. Astbury, "The Fundamentals of Fiber Structure." Oxford University Press, New York, 1933.

X-rays. The pattern is characterized by spots arranged on a well-defined equator line and symmetrical arcs above and below this equator.

Now, it happens that the diffraction pattern of a well-formed fiber is very similar to a rotation diagram. Compare, for example, Figs. 57*a* and 57*b*. Figure 57*a* is the pattern produced when a single crystal of a silver nitrate-urea addition compound is rotated around an axis perpendicular to the X-ray beam.

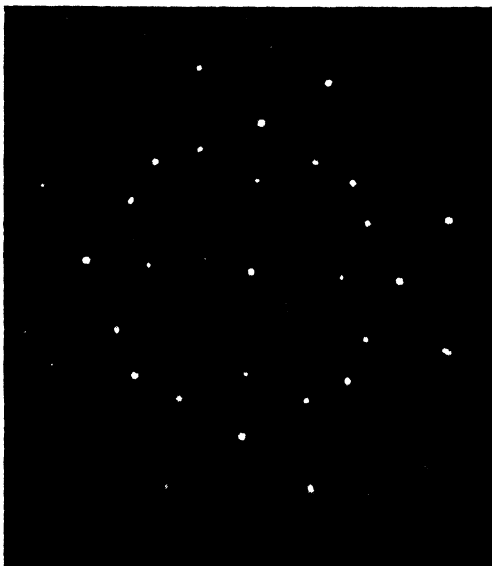

FIG. 56.—A Laue pattern of sodium chloride. (Courtesy of G. L. Clark.)

Figure 57*b* is the diffraction pattern produced by a variety of asbestos, a typical mineral fiber. Figure 57*c* is the pattern of ramie, a cellulose fiber. Figure 57*d* is the diffraction pattern of a bacterial cellulose membrane, softened in NaOH and stretched.¹ Figure 57*e* is a fiber pattern of chitin, a substance very similar to cellulose in which the secondary hydroxyl on the α carbon atom of the latter is replaced by an acetamide group.² It is formed in the skeletons of insects, crustacea, and other invertebrates. The diffraction pattern shown is that of a lobster

¹ Sisson, W. A., *J. Phys. Chem.*, **40**, 343 (1936).

² Meyer, K. H., and H. Mark, *Ber.*, **61**, 1936 (1928).

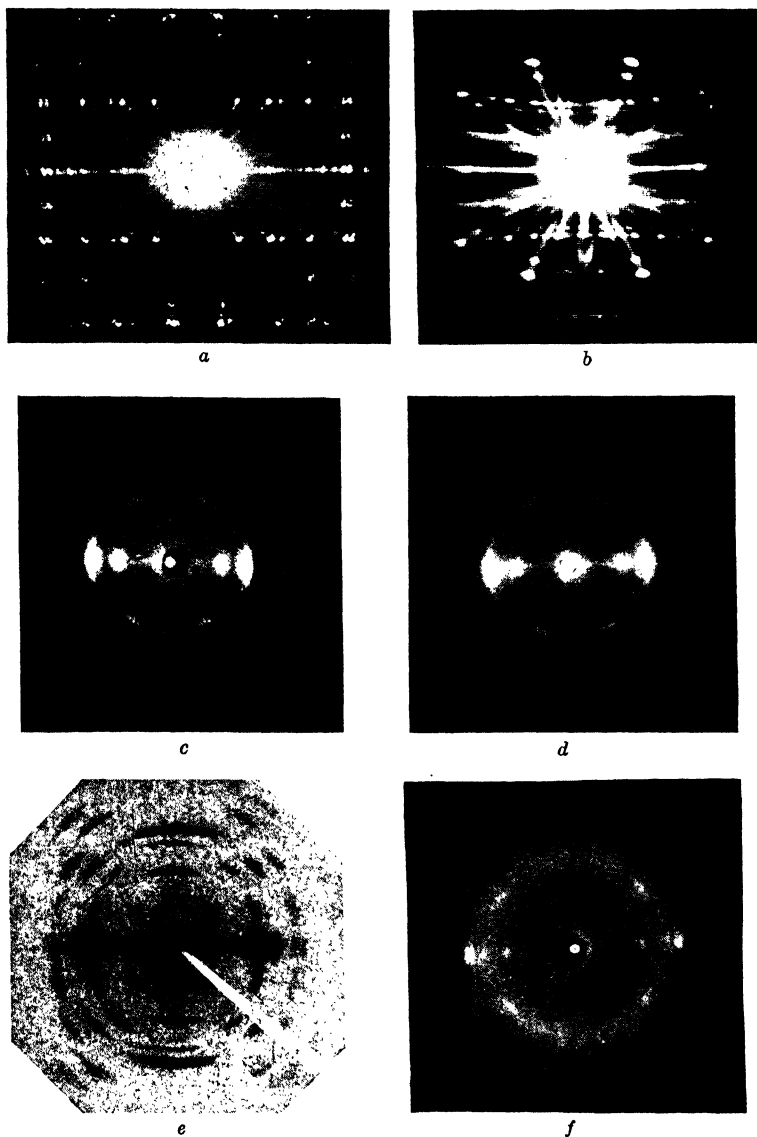

FIG. 57.—X-ray diffraction patterns of typical fibers. (a) A rotation diagram for a single crystal. (*G. L. Clark.*) (b) Asbestos, a typical mineral fiber. (*G. L. Clark.*) (c) Ramie. (*G. L. Clark.*) (d) A bacterial cellulose membrane, softened in NaOH and stretched. (*W. A. Sisson.*) (e) Chitin, a lobster tendon. (*G. L. Clark.*) (f) Stretched rubber. (*G. L. Clark.*)

tendon.¹ Figure 57f is a pattern for stretched rubber. It is difficult to escape the conviction that all of these are the result of molecular orientation leading to the same sort of crystalline arrangement. Inasmuch as the fibers are not mechanically rotated during the exposure, the crystals must lie in such a way that the effect of rotation is produced. This is the case with the orientated matchsticks. When they are raked into line, only the long axes of the crystals are parallel to each other. In regard to the two axes perpendicular to this, no regularity has been produced. It is evident that, given enough sticks to permit a statistical distribution, the axes a and b perpendicular to the parallel c axes, could lie in every possible direction through 360 deg., producing the same effect upon X-rays as the rotation around the c axis of a single crystal.

Unfortunately, very few natural fibers have structures sufficiently regular to give the detailed diffraction pattern of ramie. From the practical standpoint, however, this is not so serious a handicap as it might appear. The physical properties of fibers are most noticeably affected by the orientation of the long molecules of cellulose which go to make up the fiber. These may be parallel to each other and to the fiber axis, as they are in ramie and in some woods. Such an alignment produces a fiber with the most marked directional properties. The molecules may be parallel to each other but lie on a spiral at a fairly constant angle to the fiber axis; this arrangement is characteristic of some compression wood fibers—fibers which grow on the underside of boughs and the leaning side of trunks. The long molecules may not be parallel to each other, they may deviate more or less from this orderly arrangement, and the deviation may be from the alignment parallel to the fiber axis or from the perfect spiral orientation. Of course, the greater the deviation from a parallel orientation, *i.e.*, the less perfect the fiber structure, the less marked will be the directional properties of the fiber. The importance of this fact will develop as specific fiber materials are considered.

A means of estimating the direction of orientation of the molecules and the perfection of their orientation in a crystalline fiber

¹ CLARK, G. L., and A. F. SMITH, *J. Phys. Chem.*, **40**, 863 (1936). This is an extremely interesting paper on chitin, chitosan, and derivatives.

is of great practical value. The manner in which this may be done from the X-ray diffraction pattern is shown in a general

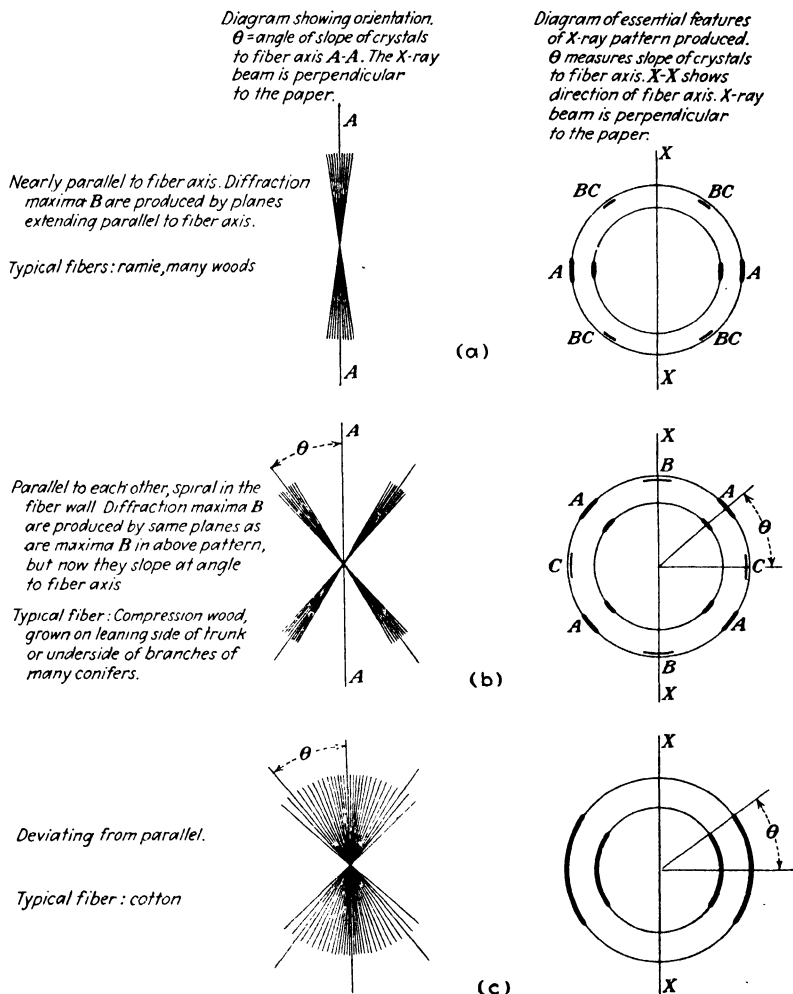

FIG. 58.—Relation between orientation of crystallites in a fiber and the X-ray diffraction pattern produced.

way in Fig. 58 and has been discussed very clearly in considerable detail by Sisson.¹ By observing the intensity distribution

¹ Sisson, W. A., *J. Phys. Chem.*, **40**, 343 (1936).

around the concentric rings of the patterns, it is possible to determine in a general way:

1. The type of orientation (see Sisson).

2. The angle of slope of the crystals to the fiber axis, if this angle is fairly constant.

3. The average slope and the approximate deviation from this average, if the angle of slope is not constant.

The difference between the orientation of fibers in Figs. 58b and 58c is particularly significant. Too often the pattern of Fig. 58c, particularly as produced by cotton, has been attributed to fibers oriented on a spiral, not parallel to the fiber axis "but inclined at a roughly constant angle to it."¹ It may be readily demonstrated that crystalline fibers oriented on a spiral at a roughly constant angle to the fiber axis produce a diffraction pattern like that of Fig. 58b, not like Fig. 58c.² A section of Lombardy poplar in which the fibers are well oriented parallel to the fiber axis will produce the pattern of Fig. 58a. This same section may be mounted on a goniometer so that the fiber axis makes an angle A with the axis of rotation, and the axis of rotation is perpendicular to the X-ray beam. Then, if the section is rotated during the exposure, the pattern of Fig. 58b is produced. But the effect of this rotating specimen upon an X-ray beam is exactly the same as that of a stationary fiber in which the crystals lie parallel to each other on a spiral at a constant angle A to the fiber axis.³

NATURAL FIBERS

A great deal could be written about the structure of fibers and, indeed, their microscopic structure particularly has been studied for many years with great profit. Our chief purpose is to show the influence upon physical properties of that orientation of crystals which has been defined as fibering or fiber structure; those features of structure which are usually invisible in the microscope and are at the very bottom of the behavior of fibers. The discussion will be limited to this phase of the subject.

¹ ASTBURY, W. T., "Fundamentals of Fiber Structure," p. 88, Oxford University Press, New York, 1933.

² STILLWELL, C. W., *Physics*, 4, 167 (1933).

³ See also SISSON, W. A., *Ind. Eng. Chem.*, 27, 51 (1935), for "synthesis" of oriented cellulose patterns.

Asbestos.—One of the most perfect of all natural fibers, and the only natural fiber commonly found among minerals is asbestos (see Fig. 57*b*). The essential feature of crystalline asbestos, the skeleton or framework of silicon-oxygen chains upon which the crystal is built, has already been described in the chapter on the silicates. It may be recalled that these chains run in the direction of the fiber axis and since the silicon-oxygen bond along the chains is stronger than the forces between chains, the tensile strength of the fibers is very high, but they may be split apart with ease.

Cellulose Fibers. *General.*—Although we are here concerned primarily with the ultimate crystal structure of fibers, it will be profitable for those not familiar with them to know something of their microscopic structure before considering those units of structure which cannot be seen with the microscope. Cotton fibers are approximately cylindrical in cross section, averaging about 0.02 mm. in diameter and about 20 to 60 mm. in length, although these values may vary considerably. The cylinders are hollow, and the fibers as a whole show corkscrew-like twists along their lengths. In the cell wall a number of spiral striations may be seen, sloped at various angles to the fiber axis, and, when suitable chemical treatment is applied, it may be shown that these striations mark the positions of smaller cellulose units of which the wall is built—long, threadlike bodies known as “fibrils.”¹

Recently it has been reported that the cotton fiber membrane may be resolved into small beadlike units. It has been demonstrated that in very young cotton fibers this beadlike structure develops, and it would appear that as the fiber matures the stringing of these beads, end to end, marks the beginning of fibril development.² Although this structure has disappeared in the mature fiber, a careful disintegration of the fiber with hydrochloric acid reveals, first the fibril and finally these same beadlike units, first in chain formation and finally isolated as single beads.³

¹ For a detailed description of cotton and other textile fibers, see J. M. Matthews, “Textile Fibers,” John Wiley & Sons, Inc., New York, 1924.

² FARR, W. K., and S. H. ECKERSON, *Contrib. Boyce Thompson Inst.*, **6**, 189 (1934).

³ FARR, W. K., and S. H. ECKERSON, *Contrib. Boyce Thompson Inst.*, **6**, 309 (1934).

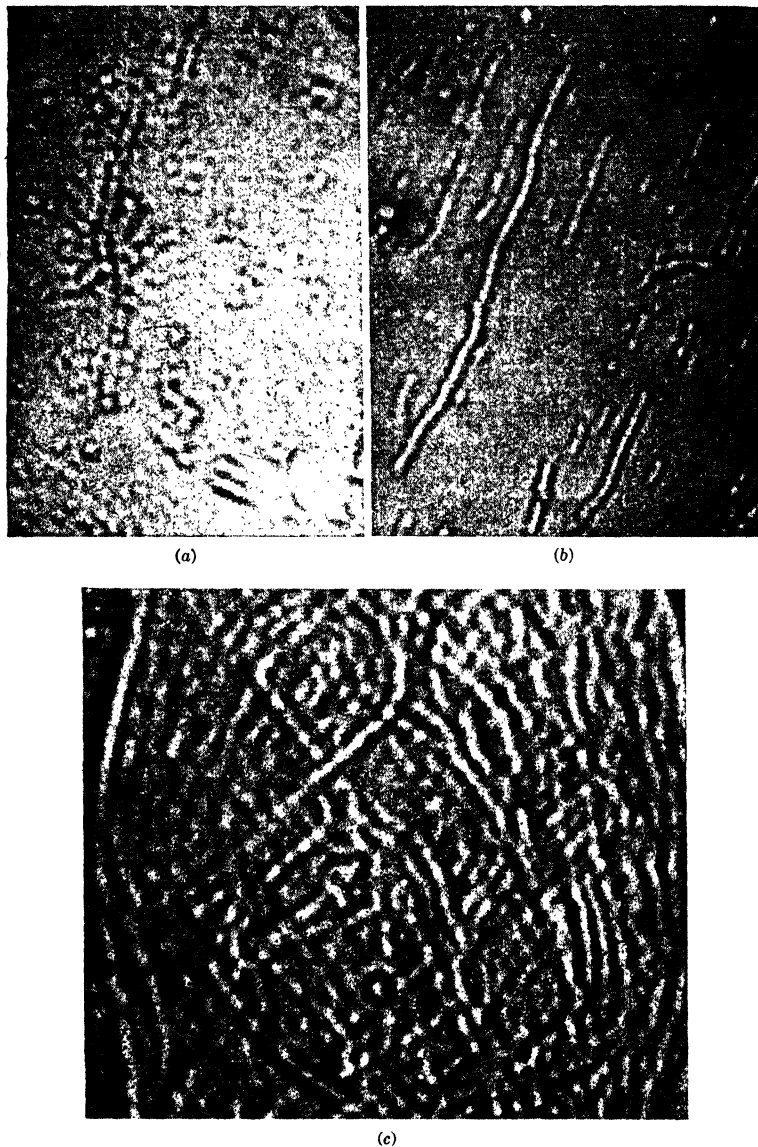

FIG. 59.—(a) Early stage of fibril formation from cellulose particles in young cotton fiber $\times 900$ enlarged to 1350. (b) Fibrils and cellulose particles dissected from membrane of young cotton fiber. $\times 1250$. (c) Disintegration of the membrane of a mature cotton fiber by treatment with approximately 25 per cent H_3PO_4 and slight pressure. $\times 900$ enlarged to 1350. (Courtesy of W. K. Farr.)



(a)



(b)

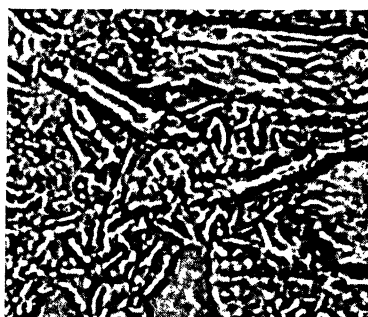

(c)

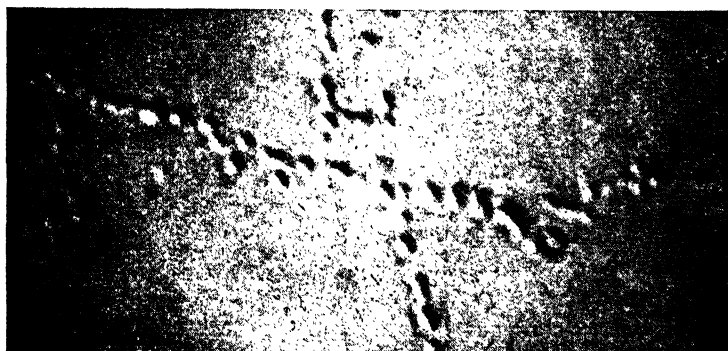

(d)

FIG. 60.—Disintegration of cotton fiber by treatment with HCl (sp. gr. 1.10). (a) After 2½ hr. treatment. The fibril and particle structure of the membrane are suggested. $\times 350$. (b) After 18 hours' treatment. $\times 350$. (c) Extreme disintegration after 5 days' treatment. $\times 350$. (d) Separate particles at higher magnification. $\times 1630$. (Courtesy of W. K. Farr.)

It is interesting to find that in the young fiber and in the mature fiber these beads are always about the same size and appear to be the same structural unit. Photomicrographs showing stages in the development of the cotton fiber and in its disintegration are reproduced in Figs. 59 and 60. Chitin,¹ which is structurally similar to cellulose, is reported to exist in the glands of a worm of Northern Europe as tiny beads, strongly anisotropic and giving every indication of being well-organized crystallites.



FIG. 61.—Schematic diagram of a highly magnified wood fiber. [From G. W. Scarth and J. D. Spier; *Trans. Roy. Soc. (Canada)*, (3) **23**, 288 (1929).]

Wood fibers are much shorter than cotton, varying in length from 1 to 3 mm., depending upon the distance from the pith. A diagram of the structure of a highly magnified, typical wood fiber is shown in Fig. 61. In Fig. 62 photomicrographs of actual wood fibers show several stages of disintegration, first into the fibrils, then into smaller units called "fusiform bodies."² These tiny, microscopic forms are constructed by nature from the invisible building stones, the unit cells of crystalline cellulose which are described in the following pages. It has been reported that the fusiform bodies can be broken down into still smaller units, spherical when separated

from the parent body, and about 4,500 Å in diameter.³

The chief constituent of all plant fibers is cellulose.⁴ Because some cellulose fibers (ramie and flax) produce a very detailed X-ray diffraction pattern, investigators have been able to learn more about their crystal structure than about the structures of the other natural fibers. It is convenient, therefore, to consider the cellulose fiber in some detail as a point of departure for our understanding of the structure and behavior of fibers in general.

¹ BORODIN, D. N., *Z. Morphol. Okol. Tiere*, **7**, 26 (1929).

² RITTER, G. J., *Ind. Eng. Chem.*, **21**, 289 (1929).

³ RITTER, G. J., and R. M. SEBORG, *Ind. Eng. Chem.*, **22**, 1329 (1930).

⁴ Wood contains much less cellulose than any of the other plant fibers—only about 50 per cent. Wood contains approximately 30 per cent of lignin.

The Unit Cell of Cellulose.—A chemical analysis of cellulose shows it to be a carbohydrate containing carbon, hydrogen, and oxygen in the ratio $C_6H_{10}O_5$. Its formula is usually written $(C_6H_{10}O_5)_n$ because the number of $C_6H_{10}O_5$ groups in the molecule is indefinite. The organic chemist writes its structural formula as follows:

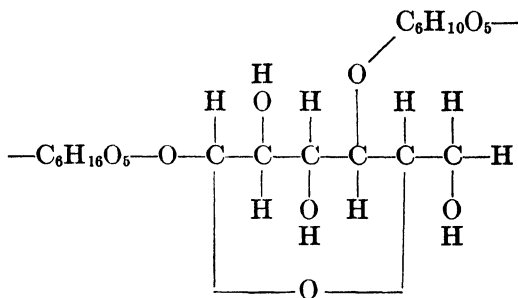

The unit is spoken of as a glucose residue, since it is formed from glucose $C_6H_{12}O_6$ by the removal of water. When to this information furnished by the chemist the X-ray data are added, another picture of the grouping of the atoms in cellulose develops. Figures 63 and 64 show several views of this arrangement as it has most recently been described.¹ It is significant that the atoms do not all lie in the plane of the ring but are arranged in a zigzag fashion in order to permit tetrahedral valence angles for the carbon atoms.

It is believed that in the formation of the fiber wall glucose molecules, present in solution, approach the growing wall and, as they attach themselves to it, water is split away.² The glucose residues are thought to unite with each other through so-called "oxygen bridges," forming chains of indefinite length. In the model shown, the oxygen bridge has been made symmetrical in relation to the carbon atoms which it connects in order to give constant valence angles. The chains are the backbone of the cellulose fiber.

¹ MEYER, K. H., and L. MISCH, *Helv. Chim. Acta*, **20**, 236 (1937).

² For detailed descriptions of the possible mechanism of cell wall growth, see O. L. Sponsler, *Plant Physiol.*, **4**, 329 (1929); F. T. Pierce, *Trans. Faraday Soc.*, **26**, 809 (1930); O. L. Sponsler, *J. Am. Chem. Soc.*, **56**, 1599 (1934).

The deduction of the structure of cellulose has been a cooperative effort, a result of the correlation of chemical and X-ray data. The chemical evidence alone first contributed the conception of glucose residues, linked together by oxygen atoms attached

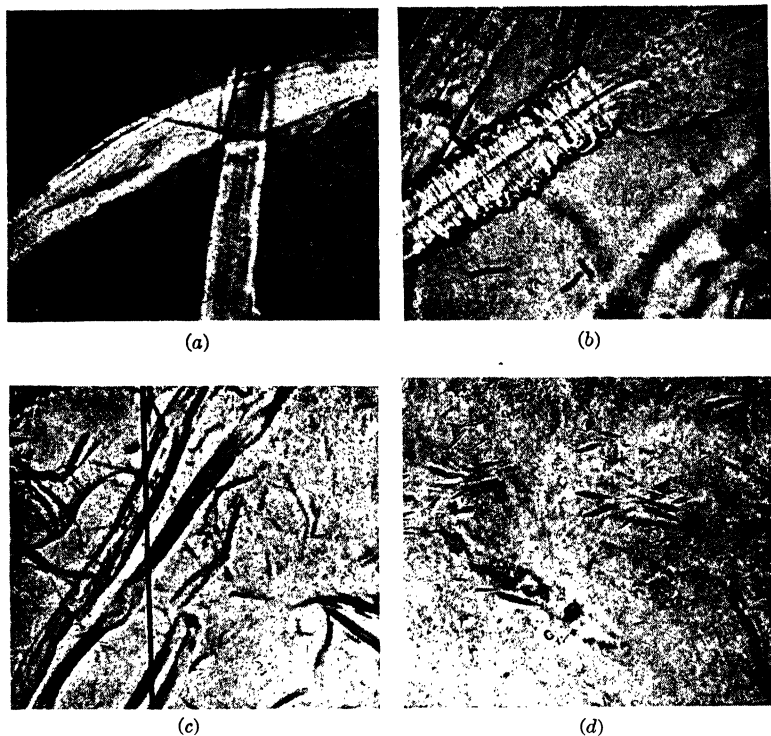

FIG. 62.—Several stages in the disintegration of wood fibers. (a) Partially loosened fibrils of the inner layers of an elm fiber. Magnified about 650 times. (b) Windings of the fibrils of the outer layer of a loblolly pine fiber, and extreme transverse swelling of the inner layers from which the outer layer has been dissolved. Magnified about 650 times. (c) Isolated elm fibrils with larger sections of elm fibers. Magnified about 650 times. (d) Fusiform bodies from elm fibers. Magnified about 800 times. (Courtesy of G. J. Ritter.)

to the 1-4 carbon atoms of neighboring residues to form cellobiose. The X-ray analysis established the distance 10.3 Å as the identity period along the fiber axis. It was then realized that if the proper atomic diameters were substituted it would take two glucose residues to extend along the axis 10.3 Å. It will be recalled that the unit cell is the smallest part of a crystal which shows the

characteristic "building plan" of the crystal. Since the length of the unit cell of cellulose must be that of two glucose residues, the lower $C_6H_{10}O_5$ group is evidently not in the same relative position as is the upper one, but, as pictured in Figs. 63 and 64, is rotated through 180 deg.¹ However, at this stage of the analysis, it is not a simple matter to establish the details of structure with certainty, and there have been several interpretations of the X-ray data, each leading to a slightly different arrangement of the atoms in the unit cell. Meyer and Mark² and Sponser and Dore³ were among the first to propose a structure for crystalline cellulose. They were in general agreement, except that they chose different axes on which to build their crystals.⁴ According to Meyer and Mark the cell is monoclinic, $a = 8.3$, $b = 10.3$, $c = 7.9$, $\beta = 84^\circ$; whereas Sponser and Dore described it as essentially rhombic, with the same b axis and identity period, 10.3 A. Later descriptions of the details of the structure were attempted to make the arrangement of the atoms consistent with the X-ray intensity data and the most likely atomic radii and valence angles, as these became better understood from the study of other organic crystals. The arrangement proposed by Meyer and Misch of the atoms in the cellobiose unit (Fig. 63) and of these groups in the unit cell (Fig.

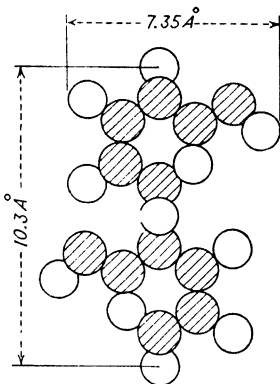

FIG. 63.—Arrangement of atoms in cellulose. The cellobiose unit. [From K. H. Meyer and L. Misch, *Helv. Chim. Acta*, **20**, 235 (1937).]

most likely atomic radii and valence angles, as these became better understood from the study of other organic crystals. The arrangement proposed by Meyer and Misch of the atoms in the cellobiose unit (Fig. 63) and of these groups in the unit cell (Fig.

¹ According to E. SAUTER [*Z. physik. Chem.*, **B 35**, 83 (1937)] alternate glucose residues are rotated through about 90 deg. This structure was determined by means of a radically new X-ray diffraction technique. Since the structure is quite different from any proposed heretofore, its acceptance must await independent verification.

² MEYER, K. H., and H. MARK, *Ber.*, **B 61**, 593 (1928); "Der Aufbau der hochpolyeren organischen Naturstoffe," p. 94, Hirschwaldsche Buchhandlung, Leipzig, 1930; MARK, H., "Physik und Chemie der Cellulose," Julius Springer, Berlin, 1932.

³ SPONSLER, O. L., and W. H. DORE, "Fourth Colloid Symposium Monograph," p. 174, Williams & Wilkins Company, Baltimore, 1926; Sponser, O. L., *Quart. Rev. Biol.*, **8**, 1 (1933), a summary of previous work.

⁴ BRAGG, W. H., *Nature*, **125**, 634 (1930).

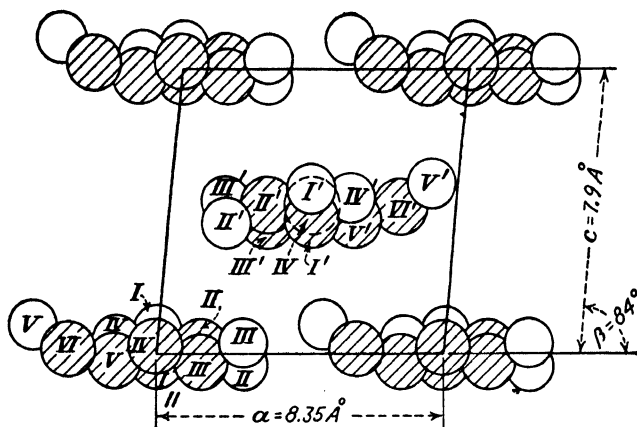

Fig. 64a.—The unit cell of cellulose. Projection on the plane ac , perpendicular to b , the direction of the fiber axis.

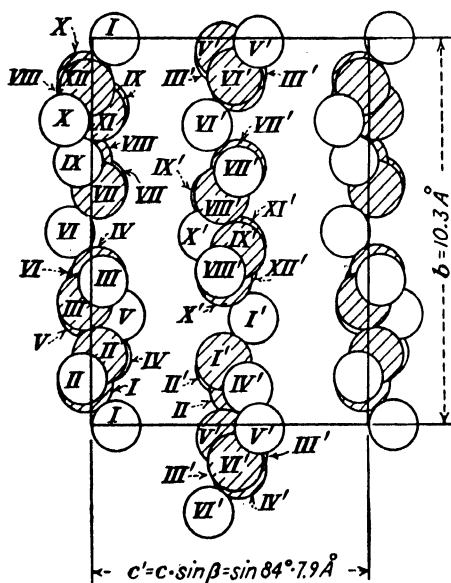
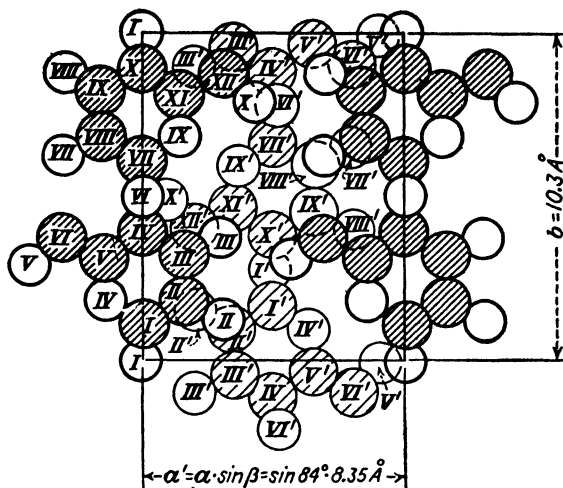
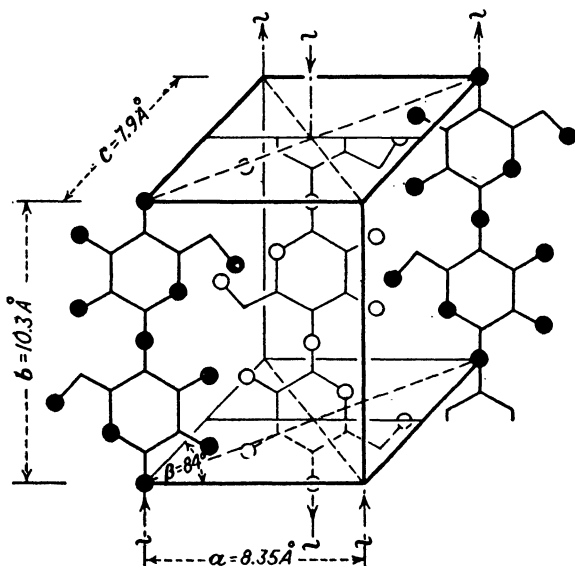

Fig. 64b.—The unit cell of cellulose. Projection in the plane bc , perpendicular to a .



(c)

FIG. 64c.—The unit cell of cellulose. Projection on the plane ab , perpendicular to c .



(d)

FIG. 64d.—Schematic representation of the unit cell of native cellulose. [All four parts of Fig. 64 from K. H. Meyer and L. Misch, *Helv. Chim. Acta*, **20**, 236 (1937).]

64) are said to more nearly satisfy all the requirements than any previous model. The atoms are so arranged that all the C-C distances are 1.54 ± 0.01 A and all the C-O distances are 1.45 ± 0.03 A. There are four glucose residues in a unit cell, and the glucose residues in the center chain of the cell are staggered with respect to those in the chains at the corners. The primary unit of structure is the chain, running lengthwise of the crystal; a secondary structure of cross hairs may be pictured, strengthened by hydroxyl bonds,¹ the OH-OH distance being 2.6 A.

Cellulose, therefore, is an example of a molecular crystal in so far as the points on the lattice are occupied by $C_6H_{10}O_5$ groups rather than by ions or atoms. When used in connection with cellulose, the term "molecule" loses its usual significance. Evidently the $C_6H_{10}O_5$ group is not a molecule since it does not occur as a separate entity but is connected to other similar groups through valence bonds. An entire chain might be thought of as a molecule, but the chains are probably of widely different lengths. This, indeed, may be one reason for the very different values which have been obtained for the "molecular weight."

Molecular weight determinations are made, not on cellulose fibers but after these fibers have been broken down by various chemical reagents. Cuprammonium is believed to be the only reagent which will disperse cellulose with a limited amount of degradation. The advantages and limitations of the many methods used for the determination of average molecular weights of cellulose and cellulose derivatives have been discussed thoroughly by Kraemer and Lansing² whose latest value for cotton cellulose, obtained by the sedimentation of a cuprammonium dispersion, is 300,000. Values of 100,000 were obtained for regenerated cellulose.³ These values compare with 56,000 for cotton cellulose determined previously by the same method.⁴ The opinion has been offered⁵ that the ultracentrifuge method cannot be counted upon too heavily to give accurate absolute values; in fact, the whole question of molecular weights of cellulose and its derivatives is at present very confusing.

¹ BERNAL, J. D., *Proc. Roy. Soc. (London)*, **A 151**, 384 (1935).

² KRAEMER, E. O., and W. D. LANSING, *J. Phys. Chem.*, **39**, 153 (1935).

³ KRAEMER, E. O., and W. D. LANSING, *Nature*, **133**, 870 (1934).

⁴ STAMM, A. J., *J. Am. Chem. Soc.*, **52**, 3047 (1930).

⁵ KRAEMER, E. O., and W. D. LANSING, *J. Am. Chem. Soc.*, **55**, 4319 (1933).

So far we have considered only the crystal structure of the cellulose. The probable position of the cellulose crystals with relation to the fiber as a whole is also of interest. The unit cells may lie in concentric orientation, with the same face always toward the lumen, or there may be a completely haphazard array of fibers in the cell wall; in either case the crystals would lie in every possible position with respect to the X-ray beam passing through them perpendicular to the fiber axis, inasmuch as a large number of fibers is usually required to produce the diffraction pattern. Evidently, if a single fiber could be split and flattened out and the X-ray beam passed through this section, then it would be possible to tell at once whether the same crystal faces were parallel to each other or whether the arrangement was haphazard. A cellulose fiber has actually been found which is large enough to permit this experiment. The large cells of the seaweed *Valonia*, 10 to 20 mm. in diameter, are ideal for the purpose; and it has been shown that in *Valonia* the planes separated by the distance 6.1 Å (Sponsler's unit cell) are tangential to the surface of the split cell.¹ Sponsler holds that it is a fair assumption that this same orientation exists in other cellulose fibers.² On the other hand Sisson³ has proposed that, in fibers in which the crystalline cellulose is well oriented on a spiral, the crystals are not arranged with the same face always tangential to the cell wall. The use of a photometric method developed by Sisson and Clark for measuring diffraction intensities offers a very convenient means of recording intensity data, although it is not necessarily a more accurate method of detecting intensity differences and has not yet revealed any detail in X-ray diffraction patterns which could not be observed by a visual inspection of the films. However, Sisson has shown that it can be used more accurately than the eye for arranging a series of films in the proper order.⁴

While X-ray analysis, aided by other physical and chemical facts, has revealed its long-chain crystalline backbone, there

¹ SPONSLER, O. L., *Nature*, **125**, 633 (1930).

² See also SPONSLER, O. L., *J. Am. Chem. Soc.*, **56**, 1599 (1934).

³ SISSON, W. A., and G. L. CLARK, *Ind. Eng. Chem. Anal. Ed.*, **5**, 296 (1933); SISSON, W. A., *Ind. Eng. Chem.*, **27**, 51 (1935).

⁴ SISSON, W. A., private communication.

are well-known properties of the cellulose fiber which indicate that it is not composed entirely of a single crystal or even a completely crystalline aggregate. The X-ray diffraction pattern shows evidence of amorphous material; the characteristic swelling and plastic flow must be explained. To account for these properties, at least two types of crystalline discontinuity in the cellulose fiber have been postulated and two additional types have been described microscopically. They are: The micellar structure, the discontinuous chain structure, the recent beadlike membrane structure for cotton, and growth rings for both wood and cotton. All are subdivisions of the fibril, which has been a recognized microscopic unit of the fiber for some time.

The Discontinuity of Crystalline Cellulose. 1. *The Micellar Structure.*—The conception of the micelle in plant fibers is a relatively old one, first proposed by Nägeli. The proponents of the micellar theory hold that X-ray and other evidence indicate that the fiber material is probably broken up into submicroscopic particles approximately 50 by 50 by 500 Å in size.¹ It is supposed that these micelles are imbedded in an amorphous matrix, cellulosic or otherwise, and are oriented with respect to the fiber axis. They are, in short, individual crystals of cellulose, which move as units during swelling or plastic flow within the fiber.

2. *The Discontinuous Chain Structure.*—Sponsler and others² have proposed that these discrete particles or micelles do not exist. Rather, the crystalline regularity of the cellulose chains may be interrupted by minute warped or bent sections of these long chains. There are no breaks to form separate particles, but the warped regions are essentially amorphous to X rays because the cellulose chains are irregular. This explanation of the discontinuity of crystalline cellulose is, say its adherents, much more in keeping with the general picture of the mechanism of cell-wall growth and is thus preferable to the micellar conception.

¹ HENGSTENBERG, J., and H. MARK, *Z. Krist.*, **69**, 271 (1928). Their results are based on calculations with a formula involving width of diffraction rings—a formula which holds only when certain assumptions are made—assumptions which may not hold for cellulose.

² SPONSLER, O. L., *Quart. Rev. Biol.*, **8**, 1 (1933); NEALE, S. M., *Trans. Faraday Soc.*, **29**, 228 (1933); ASTBURY, W. T., *ibid.*, **29**, 193 (1933); PIERCE, F. T., *ibid.*, **29**, 51 (1933).

3. *The crystallite or particle structure* has recently been described in the cotton fiber by Farr and Eckerson.¹ These beadlike particles, judging from microscopic evidence, appear to be repeated structural units in the fiber. They might be included in a broad definition of the term "micelle." They are not, however, the micelles of Mark. It is reported that they are giants, many times larger than the submicroscopic micelle inferred from X-ray data, about 10,000 by 15,000 Å in size² and thus beadlike rather than rod shaped. It has been observed³ that the particle is consistent with the X-ray data and that a micellar or discontinuous structure is not necessary.

4. *Growth Rings*.—When a cotton fiber, grown under normal field conditions, is cut transversely and swelled in suitable reagents, the microscope reveals concentric growth rings, which look much like the annual rings of a tree. These were described first by Ball many years ago and have recently been studied in detail by Anderson,⁴ Kerr,⁵ and Bailey.⁶ Controlled growing conditions indicate that in cotton these rings are composed of alternate dense and porous portions resulting from alternating slow and rapid growth during the night and day of a 24-hr. cycle. When cotton is grown under constant illumination at constant temperature, the rings do not appear. These rings are reported to be about 0.3μ thick, and it is pointed out that it is difficult to conceive of such rings being built of particles over 1.0μ in diameter. The "bead" structure and the growth-ring structure appear at the moment to be incompatible. The visual microscopic evidence seems to be equally convincing for both, and further data pertaining to these structures will be extremely interesting.

The Growth of Cellulose Crystallites.—From the botanical standpoint, it is of interest to know how long it takes for this rather complicated structure to develop in the growing plant

¹ FARR, W. K., and S. H. ECKERSON, *Contrib. Boyce Thompson Inst.*, **6**, 189, 309 (1934).

² FARR, W. K., *Paper Trade J.*, **101**, 183 (1935).

³ FARR, W. K., and W. A. SISSON, *Contrib. Boyce Thompson Inst.*, **6**, 315 (1934).

⁴ ANDERSON, D. B., American Chemical Society meeting, spring, 1937.

⁵ KERR, T., *Protoplasma*, **27**, 229 (1937).

⁶ BAILEY, I. W., and T. KERR, *J. Arnold Arboretum*, **16**, 273 (1937).

fibers, *i.e.*, how long a time is required for the fibers to become structurally mature.

Apparently, the microscopic beads are present in a 4-day cotton ovule, and these begin to string together at 11 days (Fig. 59).¹ X-ray studies have shown² that, at 14 days, the cellulose is crystalline and that 32-day cotton shows definite evidence of fiber structure which reaches its maximum degree of orientation at 52 days. These data were obtained from untreated fibers. More recently it has been shown that purified fibers only 5 days old contain crystalline cellulose identical with that in mature fibers.³ Apparently in the early stages of fiber development the cellulose pattern is masked by noncellulosic material. Anderson has stated that longitudinal growth takes place in the cotton fiber for 15 days and then transverse growth up to 52 days.

In radial growth in the trunk of a white fir, crystalline cellulose is present in the initial layer of cells of young fibers formed in the cambium, but it is randomly oriented. Fibers reach maturity in respect to the preferred orientation of their cellulose crystallites at the age of about 10 days.⁴ Cellulose crystallites in terminal growth at the end of branches are randomly oriented, as they probably are in the first several rows of radial growth near the tip of a branch. This lack of orientation—of structural maturity—seems to depend upon the position of the fiber near the tip rather than upon its age. There is no perceptible influence at the tip of a branch which might cause the “laying down” of the crystallites in a preferred direction. In the slow-growing white fir and maple, the random orientation persists back from the tip into the previous year’s growth, a distance of perhaps 10 in. In the faster growing Lombardy poplar, preferred orientation is also detected about 10 in. from the tip but is attained well within the current year’s growth. Orientation of the crystallites in fiber walls near the growing tip of a branch

¹ FARR, W. K., and S. H. ECKERSON, *Contrib. Boyce Thompson Inst.*, **6**, 189 (1934).

² CLARK, G. L., W. K. FARR, and L. W. PICKETT, *Ind. Eng. Chem.*, **22**, 474 (1930).

³ SISSON, W. A., *Contrib. Boyce Thompson Inst.*, **8**, 389 (1937).

⁴ RITTER, G. J., and C. W. STILLWELL, *Paper Trade J.*, **98**, 277 (1934).

is primarily a function of their distance from tip and pith and is not directly dependent upon their age.

It is said¹ that in cork the cellulosic material never does assume a preferred orientation.

Once formed, crystalline cellulose is reasonably stable. Fourteen-day-old beech shoots produce the same X-ray diffraction pattern as wood from a tree 385 years old;² and the cellulose in the spruce top of a 1691 Stradivarius is almost as well oriented as that in spruce grown this year.³

Thus far, we have considered the ultimate building stones of cellulose, the glucose residues, and from them have constructed the crystalline material of the fiber. Briefly, the fiber wall has been described as being built up of glucose residues, linked together by strong valence forces through oxygen bridges, into long chains which extend, in general, lengthwise of the fiber. The individual chain molecule of cellulose is only a few angstrom units thick, but may be several hundred glucose residues long. Four interpretations of the crystalline discontinuity in the fiber have been suggested, but definite acceptance of any one of these suggestions must await further evidence.

All cellulose fibers, regardless of their source, apparently have the same fundamental crystalline structure, the same unit cell, and the same chain molecules of glucose residues.⁴ The cellulose fibers differ greatly in the degree of orientation of these long-chain crystals in the fiber walls, and these variations

¹ PRINS, J. A., *Physica*, **1**, 752 (1934).

² HESS, K., M. LÜDTKE, and H. REIN, *Liebigs Ann. Chem.*, **466**, 58 (1928).

³ LARK-HOROVITZ, K., and W. I. CALDWELL, *Nature*, **134**, 23 (1934).

⁴ Almost alone in his denial of the long-chain molecule stands Hess [see, for example, HESS, K., and C. TROGUS, *Z. physik. Chem.*, Bodenstein vol., 388 (1931)]. He cites as evidence the invariable recurrence of the distance 5.15 Å in natural cellulose and in all cellulose derivatives, which suggests, says he, that the glucose residue exists as a separate and distinct unit in the structure. Otherwise, the breakdown would not always result in a unit of this one particular size. He does not believe that there is an oxygen bridge between residues to form a cellobiose unit. While the weight of opinion is against this view, as is a preponderance of the evidence, it is hardly safe to consider it definitely ruled out. See also HESS, K., and C. TROGUS, *Ergebnisse tech. Röntgenkunde*, **4**, 21 (1934); *Chem. Zentr.*, 1935, part I, p. 707; *C. A.*, **30**, 5029 (1936).

influence in a large degree the properties of fibers of cellulose from different plants.

Ramie and Cotton.—It is interesting to compare the properties of these two common cellulose fibers, because they represent the two extremes of structure in regard to the orientation of the cellulose chains.

In ramie the cellulose crystallites lie in a very orderly fashion almost parallel to the axis of the fiber (see Fig. 57c). Ramie (and flax), therefore, have the greatest tensile strength of all natural fibers (see Table 121 Chap. XIII). On the other hand, these fibers are relatively brittle, do not weave easily, and, when woven, form a harsh fabric—witness linen as compared with cotton fabric. This variation in properties is characteristic of fibers. Perfect alignment makes for great strength and rigidity in the fiber direction; and the more perfect the orientation, the more brittle the fiber becomes in the transverse direction.

In cotton the crystallites are not perfectly arranged; they are inclined at an angle to the fiber axis, and this spiral angle may vary over a range of 30 deg. or more (see Fig. 58). Thus cotton has not the tensile strength of ramie, but it is a more resilient fiber and weaves into a softer fabric. That there is a rather definite correlation between crystallite orientation and the tensile strength of raw cotton fibers is shown by the data in Table 112.¹

TABLE 112.—RELATION OF CRYSTALLITE ORIENTATION TO TENSILE STRENGTH OF RAW COTTON

Observed Chandler Strength 10 ³ lb. per square inch	Slope of Fibrils as Measured by X-ray Diffraction
111.9	24.2
105.0	23.2
92.2	30.5
92.0	34.1
84.4	35.6
84.0	38.5
82.7	37.3
80.0	37.5
72.9	42.6
71.9	43.0

The more perfect parallel orientation of the building stones in ramie results in a denser packing of these crystallites and opposes

¹ Sisson, W. A.: *Textile Research*, 7, 425 (1937).

the penetration of various reagents, whereas the irregularity of the crystallites in cotton permits penetration to a greater extent. For this reason it is more difficult to mercerize or dye flax and ramie than it is to perform the same treatment on cotton. Ramie does not swell so readily or so extensively as cotton, since swelling is caused by the penetration of water or solution between the cellulose chains.

Cellulose fibers are not elastic. They will stand very little stretching before the structure itself gives way, and any further stretching is accompanied by internal slipping of the long molecules, resulting in a permanent deformation. An attempt has been made to relate the maximum extensibility of the fiber to the degree of orientation of the crystallites.¹ This is probably qualitatively true, for it is well known that the extensibility of cotton is greater than that of ramie or flax; the latter are not ductile fibers. Astbury² points out that an artificial or natural silk which shows almost perfect orientation can be extended some 20 per cent, so that there must be other important factors involved.

The Swelling of Cellulose Fibers.—Inasmuch as wet cellulose fibers give essentially the same diffraction pattern as dry ones, we know that most of the water adsorbed by a fiber penetrates between the crystallites, but does not penetrate into them. We have no assurance that part of the water does not penetrate a short distance into the crystallites, because the X-ray method is not sensitive enough to detect the disruption of a few cellulose chains on the surface of the crystallites. When one considers the huge total surface of the individual crystallites of a fiber, the amount of water which they take up is not at all surprising.

Penetration of foreign molecules depends upon their size and their ability to overcome the cohesive forces across the crystallites. Water is one of the most effective penetrating substances because the molecules are relatively small and their attraction for the forces emanating from the cellulose chains is high.

¹ PRESTON, J. M., *Trans. Faraday Soc.*, **29**, 65 (1933).

² ASTBURY, W. T., discussion of paper by H. Mark, *Trans. Faraday Soc.*, **29**, 6 (1933); VAN ITTERSON, G. JR., discussion of paper by H. Mark, *Trans. Faraday Soc.*, **29**, 6 (1933).

Benzene, on the other hand, is not able to penetrate fibers to any extent.¹

When water enters a fiber, the latter undergoes a marked and characteristic swelling. It is a well-known fact that the lateral swelling of fibers is much greater than the longitudinal swelling. The reason for this is related to the way in which the water goes

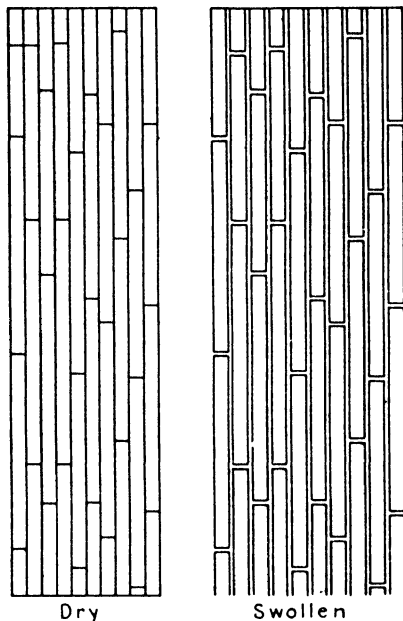

FIG. 65.—Schematic diagram to show the cause of marked transverse swelling in fibers. (From W. T. Astbury, "Fundamentals of Fiber Structure," Oxford University Press, New York, 1933.)

between the crystallites and is clearly shown in Fig. 65. A viscose fiber swells in water about 40 per cent laterally and only 5 per cent longitudinally.² A swollen fiber is much less rigid because the water separating the crystallites acts as a lubricant and also reduces the cohesive force between the chains. It is possible to stretch cellulose when wet and to bring about a more

¹ Wool fibers cannot be swelled in octyl alcohol, but if they are "pried apart" first with methyl alcohol molecules, the larger octyl alcohol molecules will then swell them further. SPEAKMAN, J. B., *Proc. Roy. Soc. (London)*, A **132**, 167 (1931).

² HALL, A. J., *Cellulose*, **1**, 275 (1930).

perfect alignment of the cellulose chains in the direction of stretching. The resistance of a cellulose fiber to twisting is also less when it is wet, and it is therefore essential that a relatively high humidity be maintained during the spinning of textile fibers.

The swelling of cellulose by water is doubtless of great importance in the dyeing process. Cellulose fibers will adsorb dyes from aqueous solutions but not from organic solutions or from suspensions. Hall suggests¹ that it is necessary for the water molecules to pry apart the cellulose crystallites before the dye can penetrate the fiber. Most organic molecules are too large to play the role of the opening wedge in this process. Hall has described an interesting experiment to support this viewpoint: Two strips of cellophane are cut, at right angles to each other, from the same sheet. Since the cellulose crystallites are oriented in the machine direction in a cellophane sheet, in strip 1 the crystallites will be lined up lengthwise of the strip, while in No. 2 they will lie more or less parallel crosswise of the strip. Now, when both are immersed in an aqueous solution of a direct dye (chlorazol fast helio BK) and weighted, strip 2 takes up more dye than does strip No. 1 and also more than an unweighted square of the same sheet. This may be explained on the assumption that stretching increases the lateral distances between crystallites in No. 2 and decreases these distances in No. 1, thus facilitating the penetration of the dye in the former case.

Although it has been emphasized that, in the case of cellulose, most of the water taken up is held between the crystallites, not within them, there are cases where adsorbed water may actually penetrate between the individual chains in a crystallite. This has been detected in wool, in which a slight change in the X-ray pattern indicates an actual change in the size of the unit cell, caused by the penetration of this water.² The swelling of gelatin (see page 393) involves considerable penetration of water into the crystallites.

Wood.—The most interesting feature of wood fibers is the great variation in structure which they exhibit. A typical wood fiber is shown diagrammatically in Fig. 61. The slope of the fibrils

¹ *Ibid.*

² ASTBURY, W. T., "Fundamentals of Fiber Structure," p. 163, Oxford University Press, New York, 1933.

in the primary layer of the fiber walls seems to vary, depending upon the conditions of growth. Even though we have scarcely made a beginning in the study of this aspect of the structure of the wood fiber, the following points of interest may be listed.

1. The crystallites of cellulose in the fiber wall may lie parallel to the fiber axis (Fig. 66a) or at a constant slope to this axis and parallel to each other (Fig. 66b); or they may be less per-

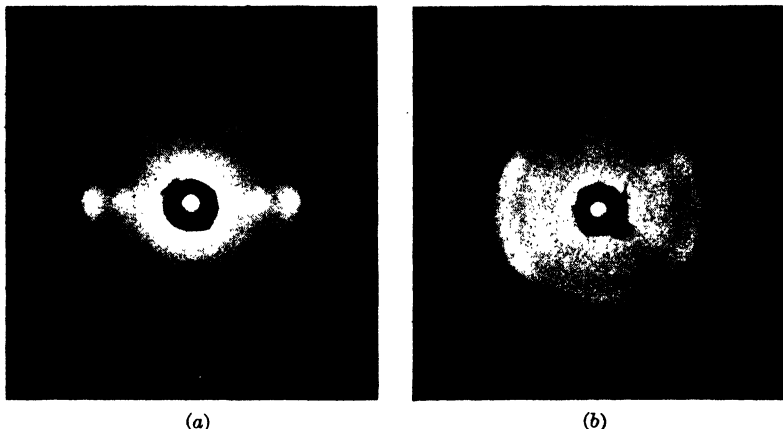

FIG. 66.—Diffraction patterns indicating typical orientation of the crystallites in wood fibers. (a) Lombardy poplar. Wood nearest the bark on the upper side of the branch, about 3 ft. from the growing tip. The crystallites lie almost parallel to the fiber axis. (b) Redwood compression wood. The cellulose crystallites lie almost parallel to each other at a definite slope to the fiber axis. [From C. W. Stillwell, *J. Chem. Education*, **10**, 164 (1934).]

fectly oriented, deviating usually from the spiral arrangement in Fig. 58.

2. The orientation of the crystallites is influenced by:

- a. Species of wood.
- b. Season of growth. Summerwood is usually more perfectly oriented than springwood of the same variety. Whichever season favors the formation of denser wood will produce fibers in which the crystallites are more perfectly oriented.¹
- c. Position of growth. In compression wood, formed on the leaning sides of trunks or the undersides of branches, the crystallinities are more perfectly oriented.

¹ PIENKOWSKI, S., *Z. Physik*, **63**, 610 (1930); SCHMIDT, E., *Z. Physik*, **71**, 696 (1931).

In branches of Lombardy poplar, the orientation of crystallites in the fibers is influenced markedly by their distance from the growing tip and from the pith.¹ A diagram of a typical branch is shown in Fig. 67. This is a composite of data obtained from five different branches of the same tree. The orientation of crystallites described is that in the outer fibers, next to the bark. The cellulose crystallites are in random orientation for a foot or more from the growing tip; almost perfect parallel orientation is found on the top of the branches from this point to a point a few inches out from the parent branch or trunk. Next to the parent branch there are two kinds of fibers, some with the parallel orientation of crystallites, and some with the spiral orientation typical of compression wood. On the underside of the branch, there is a region of parallel orientation in from the tip, followed by an extended region in which the crystallites deviate about ± 20 deg. from the parallel as shown in the small figure in the diagram; then, next to the parent branch, there again occur fibers in which the crystallites are oriented on a spiral—compression wood fibers. It should be noted that the difference between the “upper-” and “undersides” of the branches is not due primarily to their positions, one above the other, for the same variations occur in a branch which grows practically vertically, as many poplar branches do. Also of particular interest is the observation that the types of orientation at the tip and next to the parent branch are independent of the age and the length of the branch and are consistent in all the branches which have been examined. This follows even in a young branch only 13 in. long, as shown in Fig. 67c. In this case the intermediate zone is practically eliminated, or overlapped with the “joint” zone. The cellulose crystallites are in random orientation 10 to 12 in. back from the tip, and within 4 in. of the joint the orientation is like that in this same region of a large branch.

There is also a change in orientation of crystallites at varying distances between bark and pith, as illustrated in the two cross-sectional diagrams in Fig. 68.

Aside from its interest to botanists, it is important to understand the structure of wood fibers because, as would be expected, the mechanical properties of the wood are related to this struc-

¹ RITTER, G. J., and C. W. STILLWELL, *Paper Trade J.*, **98**, 277 (1934).

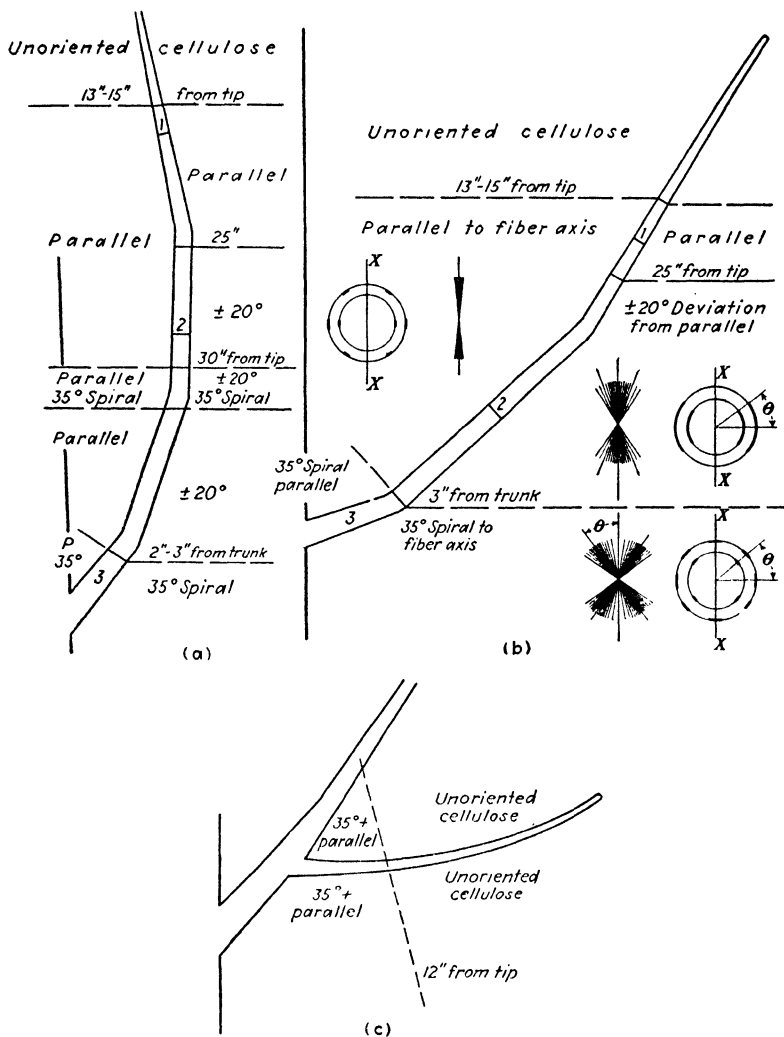

FIG. 67.—Diagram showing orientation of cellulose in fiber walls of Lombardy poplar branches. (a) and (b) Two branches of the same tree, growing at different angles to the perpendicular trunk. (c) A small branch of the same tree, growing from a larger branch as shown.

ture. Woods in which the fibers are built up of crystallites lying more or less parallel to the fiber axis are those which split easily, have high tensile strength, and undergo little longitudinal shrinkage. That the effect is of very practical magnitude is shown by the data listed in Table 113.

When the orientation in the fiber walls is less perfect, the wood is tougher but is not so strong and may shrink so badly that it is worthless for structural purposes.

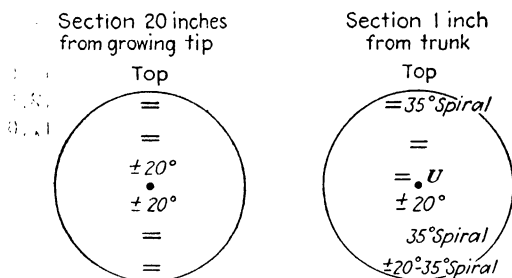

FIG. 68.—Relation of the orientation of crystallites in Lombardy poplar fibers to their distance from the pith. = Crystallites parallel to fiber axis. $\pm 20^\circ$, crystallites as in Fig. 58c or see Fig. 67. U, unoriented cellulose.

To make a violin with an even, soft tone, wood in which the fibers are not well oriented is usually selected for the back. The orientation of the crystallites in wood may influence the velocity of sound in different directions, and the mellowness of the tone is evidently at its best when the fibers do not have marked directional properties. The top of a violin, however, is made of very perfectly fibered spruce.¹

Protein Fibers. *Natural Silk.*—Silk produces a fiber X-ray diagram, which indicates that it is crystalline and that, according to our fundamental definition of a fiber, the crystals are more or less perfectly aligned in a given direction—the direction of the fiber axis. The silk protein (fibroin) forms long-chain molecules which build up into some sort of aggregate resembling the cellulose crystallites.

The “link” in the fibroin chain is an α amino acid residue. There is a series of α amino acids, important in biological processes of the proteins, all of which may be represented by the

¹LARK-HOROVITZ, K., and W. I. CALDWELL, *Nature*, **134**, 23 (1934).

TABLE 113.—RELATION BETWEEN SLOPE OF FIBRILS AND LONGITUDINAL SHRINKAGE

	Longitudinal shrinkage,* %	Slope of fibrils, deg.
Normal redwood:		
Springwood.....	0.310	32.8
	0.340	30.9
	0.289	31.2
	0.279	32.9
Summerwood.....	0.031	12.0
	0.052	11.0
	0.031	12.5
	-0.031	11.0
Loblolly pine		
	1.259	40.0
	1.200	41.0
	1.146	42.0
	0.903	39.0
	0.546	35.0
	0.505	33.0
	0.595	32.0
	0.225	13.0
	0.242	14.0
	0.225	13.0
	0.262	20.0

* These wood specimens were furnished and the longitudinal shrinkages determined by Mr. Koehler of the Forest Products Laboratory.

general formula $\text{NH}_2-\overset{\text{H}}{\underset{\text{R}}{\text{C}}}-\text{COOH}$, in which R stands for a

univalent radical. Two different α amino acids may combine with the elimination of a molecule of water as follows:

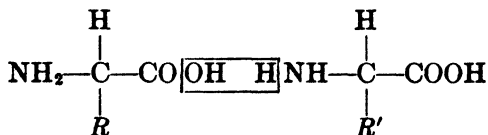

The $-\text{CO}-\text{NH}-$ is known as the peptide linkage. About 1900, Emil Fischer showed that these molecules can combine through

the peptide linkage to form very long chains of the general type.

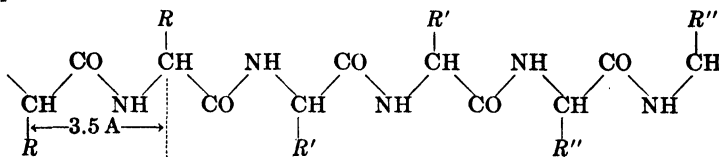

A zigzag chain of this sort is to be expected because the valence bonds of both carbon and nitrogen are very nearly at the tetrahedral angle of $109^{\circ}28'$. The most significant feature to be noted is that each amino acid residue, regardless of the nature of R, takes up the same distance, 3.5 Å, along the main chain. The fibroin of natural silk is believed to be made up in large part of

only two of the simplest amino acids, glycine $\text{NH}_2\text{-}\overset{\text{H}}{\underset{\text{H}}{\text{C}}}\text{-COOH}$

and alanine $\text{NH}_2\text{-}\overset{\text{H}}{\underset{\text{CH}_3}{\text{C}}}\text{-COOH}$. The residues of these acids

form the chain

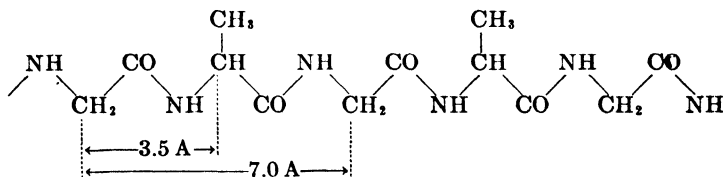

The single acid residue takes up the usual distance 3.5 Å in the chain. It may be seen that the "repeat" distance along the chain is 7.0 Å, just the length of two residues.

Knowledge of the crystalline structure of silk has come about through a correlation of chemical and X-ray information. Taking into account the approximate radii of the atoms involved, and assuming the zigzag structure with tetrahedral angles, the 3.5 and 7.0 Å distances along the chains may be computed. Turning to the X-ray pattern of fibroin, we obtain an independent check of these distances which points to the essential validity

of the assumed structure, relatively parallel chains of long fibroin molecules. Astbury has made a striking comparison which gives some idea of the size of a fibroin molecule. "If a globe of the earth, 10 inches in diameter, were expanded to the actual size of the earth, 8,000 miles in diameter, the molecules of silk would appear as ropes some 10 feet long and 1 inch thick."¹ The typical protein fiber molecule is thus some 120 times as long as it is wide, resembling the cellulose chain in this respect. In general, we shall find that protein crystallites are not so sharply defined as those in cellulose—possibly because the side chains, the *R* groups, vary in size and prevent the perfect parallel orientation of the main chains.

As with cellulose fibers, the degree of orientation of the crystallites influences greatly the strength of the fiber. By the simple expedient of precipitating natural silkworm secretion in a suitable medium and then stroking it repeatedly in the same direction between two fingers, the orientation of the crystallites may be improved and the tensile strength raised from 10 to 30 kg. per square millimeter.²

Silk also resembles the cellulose fibers in that it can be stretched only slightly before a permanent deformation is produced. Again, after the first small elongation, any further strain produces internal slippage of the chain molecules.

Wool, Hair.—Apparently all animal hairs are built of the same α keratin. The same X-ray pattern is produced by human hair, wool, and porcupine quills; by fingernails, whalebone, and cow's horn. This structure among protein fibers from whatever source seems to be about as constant as that of cellulose from various sources. Silk is an important exception. The identity period along the fiber axis of wool is 5.1 Å as compared with the 7.0 Å of silk. As is often the case when an exception to a generalization arises, the effort to explain the difference in identity period has actually brought out a very significant structural relationship between the silk and wool fibers.

Wool differs fundamentally from cellulose and silk in that stretching causes a transition from one crystal form (α keratin)

¹ ASTBURY, W. T., "Fundamentals of Fiber Structure," Oxford University Press, New York, 1933.

² VON WEIMARN, P. P., *Trans. Faraday Soc.*, **29**, 13 (1933).

to another (β keratin). Stretching cellulose or silk merely brings about a more perfect alignment of the crystallites without changing their structure.

The marked elasticity of wool has, of course, been known for some time. Only recently, however, has its elasticity been shown to be related to the positions of the chains of long keratin molecules, the fundamental fiber structure. The structural analysis of the wool fiber, and the remarkable correlation of this molecular structure with the unique physical properties of the fiber are due mainly to the efforts of Astbury and his coworkers,¹ and represent a most interesting application of the X-ray method of crystal analysis in the hands of individuals with keen insight and constructive imagination. Although the discussion in the following pages may be couched in terms which imply that the structures of protein fibers have been firmly established, the reader must keep in mind throughout that this picture of the protein fiber has not been unequivocally proved by X-ray studies. It is, at best a picture which is consistent with the known facts, both the physical properties of wool and the somewhat fragmentary X-ray diffraction data which are available, but is not proved by these facts.

Some people have a weakness for reading the last chapter of a mystery story first. Let us start at the end of the story of the structure of wool. In a word, the side chains, the amino acid residues, jutting out from the main long-chain keratin molecules, appear to hold the key to the situation. They account, apparently, for the peculiar properties of wool, properties which are of the utmost importance in all practical handling of these fibers.

It will be recalled that silk fibroin is composed essentially of the two simplest amino acids, glycine and alanine, the side chains of which are, respectively, H and CH₃; both rather inconsequential as side chains, to say the least. In the case of silk, then, these side chains can exert little opposition to the natural tendency of the long, main chains to line up parallel to each other and, as has been observed, in natural silk the chains are relatively well oriented, parallel to the fiber axis. In wool the side chains

¹ See, for example, ASTBURY, W. T., "The Fundamentals of Fiber Structure," Oxford University Press, New York, 1933. ASTBURY, W. T., and H. J. WOODS, *Trans. Roy. Soc. (London)*, A **232**, 333 (1933), and others.

become an important factor. By the hydrolysis of keratin, it has been found that the residues of glutamic acid, arginine, and cystine are present. That the side chains are larger and more complex in wool than in silk is also suggested by the distances between the main chains—in silk, 4.5–6.1 Å; in keratin, 9.8 Å.¹ Cystine is a double amino acid and can actually act as a cross link between two neighboring chains. Astbury has likened these side chains to the rungs of a ladder, the main chains being the sides. Thus

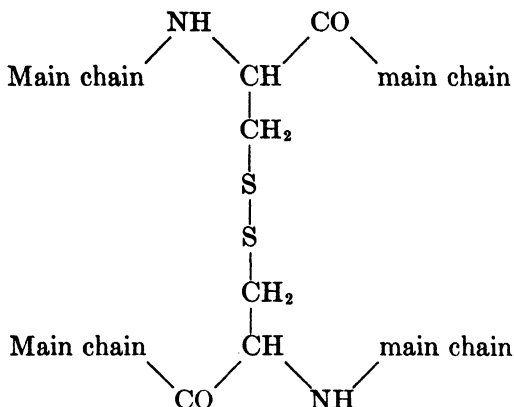

Some of the side chains in wool are apt to be polar, so that the ends will be positive or negative. There may be introduced, therefore, forces which tend to overcome the natural urge of the main chains to lie parallel to each other. These forces are set up by the natural attraction or repulsion of the several varieties of side chains. As a result, the main chain is unable to lie extended but is crimped, curled, or contracted. This is the form of α keratin, the substance of wool as we ordinarily find it. The X-ray diffraction evidence indicates that the identity period along the fiber axis in wool is 5.1 Å, as compared with 7.0 Å in silk fibroin. The side chains, on the basis of their interaction and consequent influence upon the extension of the main chains, may be placed in one of four groups which, including the two already mentioned, are as follows:

¹ KRATKY, O., and S. KURIYAMA, *Z. physik. Chem.*, B 11, 363 (1931).

1. Cystine—complete cross rungs.
2. Salt-forming bridges, ionic linkages, as in gelatin,¹ myosin, and muscle.²
3. Ethers.
4. Inactive.

Wool can be stretched to about twice its original length if the stretching is carried out slowly, under hot water. It

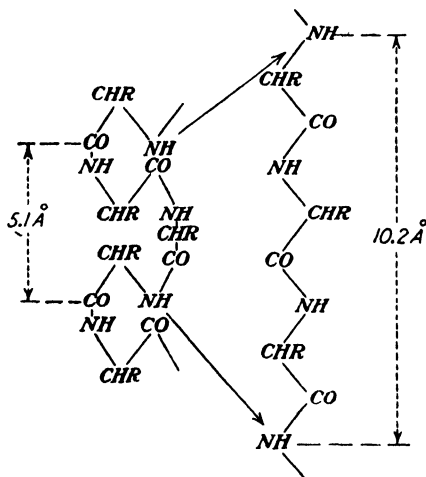

FIG. 69.—Diagram showing the relation of folded protein molecule in unstretched hair (left) to the same molecule extended in stretched hair (right). (From Astbury, "Fundamentals of Fiber Structure," by permission of the Oxford University Press, New York.)

is believed that this stretching process actually stretches the main chains of the α keratin, pulling them out into the elongated, roughly parallel positions which they occupy in silk. The X-ray pattern of stretched wool, or β keratin, shows an identity period of 7.0 A, exactly that of silk fibroin. Furthermore, the elongation of an individual protein chain, measured from the X-ray diffraction patterns of α and β keratin, is just 100 per cent, exactly the same as the elongation of the wool fiber, measured with a

¹ HESS, K., and C. TROGUS, *Biochem. Z.*, **262**, 131 (1933); ASTBURY, W. T., and W. R. ATKIN, *Nature*, **132**, 348 (1933).

² BOEHM, G., *Kolloid-Z.*, **61**, 269 (1932). In soluble proteins, like ovalbumin, the side chains are said to be unattached. MILLER, W. S., K. G. CHESLEY, H. V. ANDERSON, and E. R. THEIS, *J. Am. Leather Chem. Assoc.*, **27**, 174 (1932).

yardstick. These relations are shown graphically in Fig. 69. The identity period, or the distance along the chains between "repeats" in the sequence of structural units, is 7.0 Å, but the actual elongation is from 5.1 Å in the α keratin to 10.2 Å in the extended β keratin.

Wool will stretch only when wet under tension, and it will stretch to its 100 per cent limit only when steamed or soaked in water above 90°C. The action of water is not difficult to visualize. It penetrates between the chains in such a manner as to weaken the mutual interaction of the side chains—the rungs of the keratin ladder—so that their resistance can be overcome by the applied tension and the main chains pulled out to their extended positions.

What happens when the chains are pulled out? Will they stay there, and if so, how long? The answers to these questions have, of course, always been of the utmost importance in the textile industry, and it is of considerable interest to speculate upon the relation of these properties to the fundamental molecular arrangement in the fibers. It must be emphasized that the following discussion, like much of that which has gone before, is nothing more than a logical interpretation of rather fragmentary experimental data. The data available are far from adequate to definitely prove the validity of this interpretation.

Wool normally occurs in the contracted, or α keratin, form. This is the stable form. Wool can change form most easily in the presence of water: in fact, water is essential to permit complete reversibility of the equilibrium

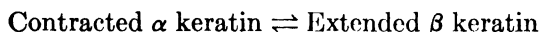

Some of the characteristic stretching and shrinking properties of wool which are of particular interest are the following:¹

1. Dry wool may be stretched only about 20 per cent; at normal humidities wool may be stretched 20 to 40 per cent; and in saturated water vapor, at ordinary temperatures, slow stretching will produce an elongation of 70 per cent. This relation of stretch to humidity is taken advantage of in spinning operations, which are carried out at relatively high humidities to prevent

¹ ASTBURY, W. T., "The Fundamentals of Fiber Structure," Oxford University Press, New York, 1933.

breaking. At high humidities and elevated temperatures, the stretch can be as much as 100 per cent. The first 2 per cent is reversible and is in accordance with Hooke's law. Further stretching begins the transformation of α into β keratin and involves a fundamental change in the fiber structure. At 100 per cent extension, the transformation is complete. It may well be, perhaps, as suggested by Astbury, that different parts of the keratin chains cannot be extended with equal ease because of the different strengths of bonds between the side-chain rungs of the ladder.

2. Stretched wool (β keratin) will shrink to its original length (change entirely to α keratin) if maintained at 100 per cent relative humidity. It shows practically no tendency to shrink if dried under tension and then maintained in the bone-dry condition after the tension is removed. At intermediate humidities the contraction will be proportional. According to our picture of the wool fiber "ladder" structure, the higher the humidity, the more water can penetrate the fiber to reduce the mutual attraction of the side chains, which tends to restrict the contraction of the main chains.

3. This permanent elongation, which can be imparted to wool by stretching and drying under tension, will be lost the first time the wool gets wet.

4. A stretched wool fiber tends to relax, or lose its state of tension, if left moist; and accompanying this evidence of a more permanent structural change, there is a slowing down of the rate of contraction to the original length, after tension is removed. This interesting property permits a kind of annealing process during spinning operations. The stresses within a fiber under tension can be reduced simply by allowing it to stand in a damp place between operations.

5. If a wool fiber is stretched 50 per cent in cold water and then placed in steam for only 2 min., it will, when the tension is removed, *contract to a length about one-third shorter than its original length*. Now, if a fiber is stretched 50 per cent, held under tension in steam for 20 min., and then released from the tension, it will return only to its original length. If it is stretched 50 per cent and steamed 2 hr. under tension, it will, when the tension is released, return only part way to its original length. If, at any

time during the steaming operations, the fiber is removed from the steam before the tension is released, it will remain extended without the aid of tension. It is possible to picture a very interesting series of events within the wool fiber. The 2-min. steaming is evidently enough to loosen the side-chain links and leave the main chains in an unrestricted "free" state. The chains are then able to coil up even more than they were originally, since their original positions were related to the influence of the side chains. Apparently the loosening action of steam is followed by the formation of new linkages—a realignment of forces—which produces a permanent set and restricts the contraction of the main chains. The maximum permanent set extension which can be obtained is about 35 per cent. X-ray evidence shows that this permanent set is actually the result of the failure of β keratin to revert to the contracted α keratin.

We have attributed the more familiar stretching and shrinking of wool to the weakening of the mutual attractive and repulsive forces of the side-chain amino acid residues forming the rungs of the ladder of which the main chains, lengthwise of the fiber, are the sides. These forces are probably largely the result of salt linkages, since it is believed that the end units of many of the side chains are acidic or basic ions and they are known to be present in approximately equal proportions. How may the contraction of a keratin chain to less than its original length be explained? The X-ray evidence shows that during the change α keratin to β keratin the rungs of the ladder are of constant length and keep the sides the same distance apart. It is well within the realm of possibility, however, that certain drastic treatments would break apart rungs not loosened by the ordinary means and permit a realignment of forces which might cause the main chains to buckle toward each other in the plane of the rungs, as well as in the planes perpendicular to the rungs, thus producing an even greater shortening of these chains. There are X-ray data which suggest that this mechanism is quite probable.

It may seem a far cry from the α keratin \leftrightarrow β keratin transformation to the permanent wave of human hair, but an explanation of the permanent wave is apparent in the above discussion.

When a hair is bent, and wet at ordinary temperatures, the outer arc is stretched more than the inner, is converted partly into β keratin and, when dried, will remain in this form until it is moistened again. This is the secret of the finger wave. If the bending is accompanied by the use of steam or mild alkalis, then the "set" can, as we have seen, be made more or less permanent.

Feather keratin differs from the keratin of mammalian hairs in that it has an identity period of 3.08 A along the fiber axis, instead of 3.5 A. This identity period can be extended to about 3.3 A without any fundamental change in the fiber structure. Astbury has observed that tortoise shell keratin is the same as feather keratin and has suggested that this may indicate a close relationship between birds and reptiles.¹

Collagen and Gelatin.—The structure of collagen has engaged the interests of a great many investigators. The protein in this fiber is similar to that in α keratin, and a recent critical study² reveals that the true identity period of the fiber is 9.75 A, a multiple of 3.25 A, which may be assumed to be the length of an amino acid residue (as compared with 3.5 A in silk). Very long spacings in the direction of the fiber axis have been measured in collagen³ (about 432 A) and also in tendon.⁴ Although the full meaning of these spacings is not clear, their existence is significant, for they indicate that in tendon the long parallel polypeptide chains are not bound together by irregularly spaced chains. The spacings along the fiber axis as well as in the transverse directions must be regular. The tendon may be built of crystallites regularly arranged, each crystallite being, in effect, a single large molecule.⁵

Incidental to the study of collagen fibers, a lateral spacing of 48 A was found which has not been reported for tendon. This appears to be peculiar to the collagen of the intestinal wall and

¹ ASTBURY, W. T., *Ann. Repts. (London)*, **28**, 322 (1931).

² CLARK, G. L., and J. A. SCHAAD, *Radiology*, **27**, 339 (1936).

³ CLARK, G. L., E. A. PARKER, J. A. SCHAAD, and W. J. WARREN, *J. Am. Chem. Soc.*, **57**, 1509 (1935).

⁴ WYCKOFF, R. W. G., R. B. COREY, and J. BISCOE, *Science*, **82**, 2120 (1935).

⁵ COREY, R. B., and R. W. G. WYCKOFF, *J. Biol. Chem.*, **114**, 407 (1936); CLARK, G. L., and J. A. SCHAAD, *Radiology*, **27**, 351 (1936).

is thought to be produced by a thin film of highly oriented wax molecules on the surface of the individual collagen fibers.¹

When collagen fibers take up water at room temperature and consequently swell, the characteristic long spacing (432 Å) is not disturbed. If, however, the water is taken up at 70°C., the fiber contracts suddenly and the X-ray pattern indicates that although the large structural units are present, they are in random orientation as they are in gelatin. By swelling again and drying under tension, almost perfect fibering is regained, *but the 432 Å spacing is absent*. This long spacing is apparently characteristic of the natural fiber only and may account for the great strength of collagen as compared with gelatin. Swelling with alkalis destroys the long spacing and results in a substantial loss of tensile strength. Chrome tanning shortens the long spacing to about 408 Å but exerts no other apparent effect on the structure of collagen.

Gelatin, being the hydrolysis product of collagen, is usually considered to be made up of particles of partially degraded collagen. Apropos of this viewpoint, a recent study of the molecular-weight distribution of gelatin is of considerable interest. This is an outcome of the development of a theory for the determination of average molecular weights of mixtures using the ultracentrifuge.² The results obtained are given in Table 114. Their specific value as quantitative information must be qualified.

TABLE 114.—EQUIVALENT MOLECULAR-WEIGHT DISTRIBUTION OF GELATIN

Molecular Weight	Percentage by Weight of Total
Less than 5,000	13
5,000 to 10,000	17
10,000 to 20,000	23
20,000 to 30,000	13
30,000 to 50,000	14
50,000 to 100,000	12
100,000 to 200,000	6
200,000 to 500,000	2

Gelatin films can be stretched some 300 per cent,³ and this results in a more perfect alignment of the long-chain molecules,

¹ CLARK, G. L., and J. A. SCHAAD, *Radiology*, **27**, 352 (1936).

² LANSING, W. D., and E. O. KRAEMER, *J. Am. Chem. Soc.*, **57**, 1369 (1935).

³ BERGMANN, M., and B. JACOBI, *Kolloid-Z.*, **49**, 46 (1929).

accompanied by a large increase in the tensile strength of the film, as shown by the following figures:

Gelatin, unstretched 4.4 kg. per square millimeter
 Gelatin, stretched 300 per cent. 9.3 kg. per square millimeter

The swelling of gelatin and of collagen presents an interesting contrast to that of cellulose. In the latter the taking up of water does not alter the distance between chains in the crystallites—practically all the water is adsorbed between the crystallites, in the disorganized, noncrystalline part of the fiber. When gelatin or collagen swells, the water does go between the chains in the crystallites, forcing them apart, so that the greater the water content of the gel, the larger is the distance between protein chains, as shown in Table 115.

TABLE 115.—VARIATION IN LATTICE SPACING WITH SWELLING OF GELATIN

Water content, per cent.	Dry	25	50	100	200
Lattice spacing, A.	11.1	13.1	14.0	15.7	16.2

This swelling behavior of gelatin is very similar to that of graphitic acid. When graphite is swelled in sulfuric or nitric acid, it takes up oxygen, turns brown, and loses its metallic properties. This oxygen forces the carbon layers in the graphite crystals apart from 3.4 to 6.15 A. Then, when this graphitic acid is washed with water, the distance between layers of carbon atoms expands further, more or less proportionally to the amount of water taken up, until when 80 per cent of water has been adsorbed, the distance between layers is 11.3 A. Prolonged drying removes water and the distance between the carbon atom layers is reduced to 6.4 A. No amount of drying will bring the layers to their original distance, 6.15 A.¹

It has been observed that fibrous collagen (tendon) is somewhat analogous to rubber in regard to its stretching behavior. Tensile strength data on stretched and unstretched tendon are given in Table 116.

¹ HOFMANN, U., and A. FRENZEL, *Ber.*, **63**, 1248 (1930).

TABLE 116.—TENSILE STRENGTH OF TENDON*
(Kilogram per square millimeter)

Tendon, swine:.....	11.0
Heated and shrunk at 80°C., with loss of fibering....	3.0
Stretched again to original length.....	10.6

* BERGMAN, M., and B. JACOBI, *Kolloid-Z.*, **49**, 46 (1929).

The X-ray evidence of fibering may be checked in a convincing manner by freezing. The stretched tendon, frozen, cleaves along the fiber axis; the shrunk tendon breaks into lumps.

Muscle.—In a muscle at rest, the molecules are contracted and are in random orientation. The relaxed muscle does not have a fibrous structure in the sense in which we are using that term. When the muscle is stretched, however, the large protein molecules are extended and oriented in the direction of stretching and a true fiber results. As with wool, this change is reversible. When the tension is released, the molecules fall back into random orientation.

An interesting relation exists between these three protein fibers—silk, wool, and muscle. There is only one form of crystalline silk, unaltered by stretching. There are two forms of wool and the stretched form, β keratin, is analogous to silk (see Fig. 69). Strange as it may seem, the structure of unstretched wool closely resembles that of stretched muscle. The normal contraction of stretched muscle suggests that it should be possible to contract unstretched wool and, as mentioned above, this can be done.

Rubber.—In unstretched rubber the long molecular chains are folded in some way, possibly as coiled spirals.

Although this general picture of the structure of unstretched rubber has been held for some time, only recently has it been validated, in part, by a Fourier analysis.¹ The intensity data show that each carbon atom has two nearest carbon neighbors at approximately 1.52 Å (the aliphatic C-C link is 1.54 Å) and 3.4 neighbors at 2.68 Å. These results may be satisfied without assuming coiled chains, although they do not preclude such chains. The distance to the nearest carbon in a neighboring chain is shown to be about 5 Å, which is a fairly definite distance of closest approach common to molecules of many organic liquids,

¹ SIMARD, G. L., and B. E. WARREN, *J. Am. Chem. Soc.*, **58**, 507 (1936).

but nothing further can be deduced regarding the relationship of neighboring chains. A schematic picture of the long-chain molecules in amorphous rubber, compatible with the X-ray intensity data, is shown in Fig. 70.

When rubber is stretched, the long-chain molecules of C_5H_8 "links" are extended and line up in the direction of stretching. When the tension is released, the fiber structure is lost. The change is reversible under ordinary conditions. In rubber, there are no side chains, as in keratin, to maintain a regular arrangement during contraction. This may account for the loss of the fiber structure when tension is released.

Why is a rubber band elastic, whereas the elasticity of a cotton thread is negligible to the ordinary observer? We may find at least one reasonable clue to this difference in the preceding discussion. Those substances (wool, muscle, rubber) in which the fibering process—the extension and orientation of the long molecules—is reversible are the fibers which appear to be, from the practical standpoint, the elastic fibers. Under very drastic treatment, freezing for example, a rubber band can be given a more or less permanent set, *i.e.*, the $(C_5H_8)_n$ chains will not curl up again when the tension is released. Rubber which has been set in this way is found to have lost all of its elasticity. It is no more like the original rubber in this respect than is a cotton string. It has the attributes of a true fiber. Transverse swelling is much more marked than longitudinal; it can be readily split in the fiber direction.¹

Mack² has proposed an interesting theory of the elasticity of rubber. There appear to be only two reasonable and possible sources of the force required to pull extended rubber molecules back to the unstretched positions when tension is released.

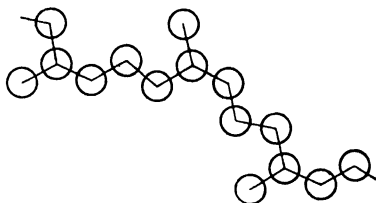

FIG. 70.—A schematic representation of the long-chain molecule in unstretched rubber. [From Simard and Warren, *J. Am. Chem. Soc.*, **58**, 509 (1936).]

¹ HOCK, L., *Gummi-Ztg.*, **39**, 1740 (1925).

² MACK, EDWARD, JR., *J. Am. Chem. Soc.*, **56**, 2757 (1934).

These are (1) residual valences of the double bonds¹ and (2) van der Waals' forces between hydrogen atoms on the surface of the molecules. Mack suggests that the available evidence favors the latter. Thus, in extending a group of rubber molecules the van der Waals' attraction due to hydrogen atom contacts must be overcome. The process is essentially that of evaporation of hydrogen atoms from a virtually liquid surface. Furthermore, as this extension occurs, the theory proposes that rotation takes place around certain double bonds and that potential energy of bond rotation is acquired by the system. Then, when the tension is released, the molecule simply returns to the lower energy form, the folded or coiled molecule. Mack has discussed many of the familiar mechanical and thermal properties of rubber and related substances in the light of this theory.

The relative ease with which the orientation of cellulose, protein, and rubber fibers may be affected is of interest. To alter the orientation in cellulose fibers rather vigorous chemical treatment is necessary until the forces between the crystallites have been weakened. Only after that has been accomplished can tension be successfully applied to increase the orientation of these crystallites in the direction of the tension. They are literally "pulled into line." As has been mentioned, the crystallites in natural silk may be coaxed into a more perfect alignment by repeated gentle stroking of the fiber suspended in a suitable medium. These two are not elastic; the change is not reversible in the usual sense. Wool, next in order, may be altered simply by the application of tension when the fiber is wet. Muscle or rubber molecules, as we have seen, may be fibered under tension without any preliminary treatment of the fiber.

¹ FIKENSCHER, H., and H. MARK, *Kautschuk*, **6**, 2 (1930); *Rubber Chem. Tech.*, **3**, 201 (1930).

CHAPTER XIII

SYNTHETIC FIBERS

A synthetic fiber, in the broad sense, is any solid in which a preferred orientation of the structural units has been induced by mechanical means.

The Drawing and Rolling of Metals.—The most perfect example of a synthetic fiber is a properly drawn wire. In an annealed casting, the individual crystals are in random orientation. When the metal is cold-drawn into a fine wire by repeated passages through a series of dies, the planes upon which slip occurs most readily tend to become oriented parallel to the wire axis. These are the planes most thickly populated with atoms. In the body-centered cubic crystals they are the 110 planes, the face diagonals; in the face-centered cubic metals they are the body diagonals, the 111 planes.¹ An interesting fact about hard- (cold-) drawn wires is that the orientation of the crystals is much more perfect at the center than toward the surface. At the center of the wire the flow of metal is predominantly in the direction of drawing. Near the surface, however, there is pressure toward the center of the wire (since its diameter is being reduced) added to tension in the direction of drawing, and, under these two conflicting influences, there is confusion and the crystals cannot line up in a regular fashion. At the outer surface of a hard-drawn wire, therefore, there is practically no evidence of preferred orientation of the crystal grains.

The crystals in a metal may be oriented in a different way by rolling, bending, or any other fabricating process in which the metal is caused to flow in a preferred direction. The degree and type of orientation produced by rolling depend in great

¹ OWEN, E. A., and G. D. PRESTON, *Proc. Phys. Soc. (London)*, **38**, 122 (1926). Note that the mechanism of orientation in metals differs from that in animal and plant fibers, in which it depends upon the existence of long-chain molecules.

measure upon the number of times the sheet is rolled. Investigation has shown that the first effect of the rolls is to break up the crystal grains in the metal sheet. After several passes of an ordinary low-carbon steel, the crystals begin to assume a preferred orientation—the sheet becomes fibered. These two stages in the change during rolling are indicated in the X-ray diffraction patterns in Fig. 71.

The orientation of the crystals in these man-made fibers has, as in natural fibers, a profound effect upon their properties. This may readily be seen from typical tensile strength data shown

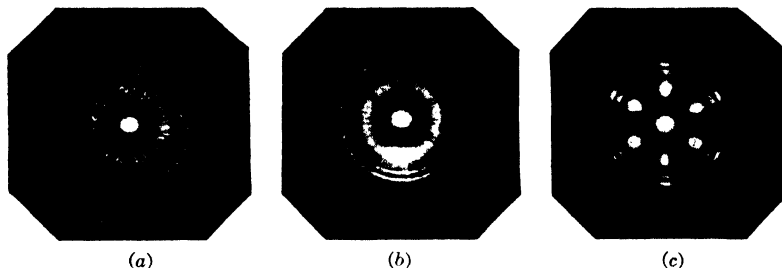

FIG. 71.—Diffraction patterns showing fiberizing of sheet steel, as produced by cold rolling. (a) Annealed sheet before rolling. (b) Intermediate stage. Up to this point the rolling has produced only fragmentation of the grains. (c) Final rolled sheet. The crystal grains have been strongly oriented by the rolling process. (Courtesy of G. L. Clark.)

in Table 117. These are average values for cold-drawn steel and for aluminum, rolled and drawn.

It is evident that any treatment which tends to improve the orientation of the crystals in the metal will increase the tensile strength; indeed, the strength of steel wire is more than double that of the original rod from which it was drawn. Not all the added strength results from the orientation of the crystals, however. The fragmentation and distortion of grains which occur during any cold working of the metal also contribute to the strength.

The same cold working which produces an increase in the tensile strength also increases the brittleness of a metal. This may not decrease the usefulness of a wire, but is a serious handicap in the use of rolled sheets. Most sheet steel, for example, is fabricated into various shapes, such as automobile fenders, and must be pliable enough to bend without breaking. The

annealing of rolled sheets is therefore a vital part of the process. When a sheet is heated to the right temperature, the mobility of the crystals is increased, and they depart from their orderly arrangement and tend to reassume the random positions which they occupied before rolling. The temperature and time of annealing will determine the degree to which this rearrangement occurs and will, in turn, control the properties of the finished sheet. A properly annealed sheet is pliable and may be fabri-

TABLE 117.—THE EFFECT OF COLD DRAWING, ROLLING, AND ANNEALING ON THE PROPERTIES OF MILD CARBON STEEL AND ALUMINUM

	Reduction, per cent	Tensile strength, lb. per sq. in.	Elongation, per cent
0.1 per cent carbon steel—drawn			
Green rod.....	..	68,000	25
First draft.....	35	93,000	3
Third draft.....	70	130,000	2
Fifth draft.....	85	145,000	1.5
Annealed after fifth draft.....	..	62,000	26
Aluminum:			
Cast.....	..	11,000	
Cold drawn to $1\frac{3}{16}$ in.....	..	19,500	
Cold drawn to $1\frac{3}{16}$ in., annealed.....	..	16,600	
Rolled $\frac{1}{4}$ in. sheets.....	..	18,700	
Rolled $\frac{1}{4}$ in. sheets, annealed.....	..	13,200	
Rolled $\frac{1}{20}$ in. sheets.....	..	20,500	
Rolled $\frac{1}{20}$ in. sheets, annealed.....	..	13,100	

cated successfully. The data for the "green rod" and "annealed after fifth draft" in Table 117 show clearly the effect of annealing on the properties of the wire.

One might suspect that if a wire were drawn hot, or a sheet rolled when hot, the crystals would never get a chance to "settle down" in an oriented position. As a matter of fact, this is exactly what happens. The properties of steel are not altered to the same extent by hot rolling, nor is there the same X-ray evidence that the crystals have become oriented. Metal fibers, then, are produced by cold working.

The change in structure brought about by heat treatment of cold-worked metals is not to be confused with the so-called "tempering" of steel. In the latter case the alteration of properties is due to a different sort of structural change within the steel.

Fibered Ionic Crystals.—It has recently been possible to build, by drawing, crystalline fibers of certain ionic substances. Silver chloride is said to become oriented along the 111 planes, silver bromide along the 100 planes. Thallous chloride and thallous bromide, wire-drawn at 100°C. and 2,000 atm., show no fiber structure, but when greater pressures are applied, the fibrous structure appears. These fibered ionic crystals are like other fibers in that they show a higher tensile strength along the fiber axis than do unoriented crystals.¹

Fibered Synthetic Resins.—The synthesis of fibers from linear polyesters, by Carothers and coworkers, throws considerable light on the mechanism of fiber formation. In general, it has been observed that polymers, many times longer than wide or thick, are crystalline. These include polymers with simple side chains, or none at all—like cellulose, silk fibroin, the polyesters of certain dibasic acids and glycols. As the length and complexity of the side chains increase, as in wool, feather keratin, tendon, vinyl polymers,² and others, the crystallinity is less marked. Essentially nonlinear addition polymers—bakelite and the glyptals—are amorphous.³ It is understood that the term "crystalline" as used here may imply merely a parallel orientation of the long axes of the molecules.

The dependence of fiber formation upon the length of the chain molecules has been demonstrated in striking fashion.⁴

¹ LEVI, G. R., and M. Tabet, *Atti accad. Lincei*, **18**, 574 (1933); **19**, 723 (1934).

² JOHNSON, English patent, 419,826 (1933), notes that threads of polymerized vinyl compounds are improved as regards mechanical properties by stretching them while in a plastic state at elevated temperature and allowing them to cool while stretched. Polymerized aryl olefines have also been fibered under tension. English patent, 419,900 (1933).

³ CAROTHERS, W. H., *Chem. Rev.*, **8**, 415 (1931).

⁴ CAROTHERS, W. H., and J. W. HILL, *J. Am. Chem. Soc.*, **54**, 1559, 1566, 1579 (1932); CAROTHERS, W. H., and F. J. VAN NATTA, *J. Am. Chem. Soc.*, **55**, 4717 (1933).

A polyester derived from dibasic acids of the series $\text{HOOC}-(\text{CH}_2)_x\text{COOH}$ and glycols of the series $\text{HO}(\text{CH}_2)_y\text{OH}$ ¹ shows no signs of colloidal behavior or of fibering if its molecular weight is below 5,000. It dissolves readily in chloroform to form a mobile solution; it melts sharply and solidifies to a hard, or waxy opaque mass. The same polymer with a molecular weight from 10,000 to 20,000 is harder and tougher, dissolves slowly, after swelling, to form a very viscous colloidal suspension. It has little tendency to flow, after melting, unless raised to a relatively high temperature. Both the low and the high weight polymers are crystalline.

Fibering of the high molecular weight polymers has been successfully induced by three methods:

1. A rod dipped into the molten mass and drawn out produces parallel orientation of the molecules to form a true fiber.

2. A solution of the polyester may be extruded from a rayon spinneret in the form of a fine thread. If the thread is dried under tension, it is transparent, strong, and resilient and shows evidence of the orientation of the long-chain molecules in the direction of tension. If the thread is allowed to dry without tension, it appears opaque, is weak and brittle, and has no directional properties. It is not a fiber in the structural sense.

3. A nonfibrous thread, formed by extrusion without tension, may be cold-drawn by applying tension in the lengthwise direction. As it is permanently extended several-fold, the opaque thread becomes transparent and lustrous, and it assumes all of the structural characteristics of the true fiber. Its strength in the direction of drawing increases about sixfold, comparing favorably (16 to 24 kg. per square millimeter) with the strength of cotton (28 kg. per square millimeter) and that of silk (35 kg. per square millimeter).

Table 118 shows the influence of the molecular weight, and thus the length of the molecule, of the polyester upon its fibering properties.

In short, these long-chain molecules, as they crystallize, behave exactly like logs floating in a millpond. If the logs are long, small groups of parallel logs tend to form; the shorter the logs, the less apparent is this tendency. The flow of long-chain

¹ CAROTHERS, W. H., and J. W. HILL, *J. Am. Chem. Soc.*, **54**, 1559 (1932).

molecules through the spinneret orifice is like the flow of logs down a river. As they pass through a narrow, swiftly moving section of the stream, logs, long in proportion to their diameters, will line up with their lengths parallel to the direction of flow. If the logs are short, only slightly longer than they are thick, this orientation will not be so prevalent.

TABLE 118.—POLYESTERS FROM ω -HYDROXYDECANOIC ACID

Molecular weight	Calc. length, A	M.P., °C.	Spinnability	Tensile strength, kg. per sq. mm
780	60	66-67	Absent	
1720	123	72-74	Absent	
3190	188	74-75	Absent	
4170	313	74-76	Absent	
5670	440	73-75	Very short fibers, no cold drawing	
7330	570	74-75	Long fibers, but cold drawing absent	Very weak
9330	730	75-76	Long fibers which cold draw	Very weak
16900	1320	77-78	Easily spins and cold draws	13.1
20700	1610	77-78	Spins with difficulty, but easily draws	12.3
25200	1970	75-80	Spins above 210°C. and cold draws	7.0

Ordinarily a fiber built of long structural units in random, brush-heap orientation, is pliable; while an improvement in orientation (*e.g.*, the change, cotton to ramie) increases rigidity. On the contrary, Carothers and Hill report that a thread made by forcing a polyester through a spinneret consists of unoriented crystallites and is brittle; and after orientation of these crystallites by cold drawing, the pliability of the thread is increased.¹

This behavior of the polyester fiber may be explained on the assumption that the crystallites in these fibers are relatively short. An analysis of the two types of structure on this basis makes the differences in properties quite apparent. A brush heap of long, interlocked units is, by reason of its structure, characteristically pliable. Paper is such a substance. A thread or sheet made of short crystals in random orientation, however, is brittle because there is no reinforcement by inter-

¹ CAROTHERS, W. H., and J. W. HILL, *J. Am. Chem. Soc.*, **54**, 1579 (1932).

locking of the crystals. Films formed from most resins are unsatisfactory because they are either tacky or brittle. They cannot be made flexible without becoming sticky. Flexibility must be imparted to such films by lowering the softening point, because the long-chain molecules are not sufficiently long to form an interlocking system. A sheet of high grade gelatin is pliable and not easily broken, but a film formed from gelatin which has been broken down by hydrolysis (*i.e.*, the molecules shortened) is relatively brittle. Paper is wiry, but a dry sheet of cellophane is extremely brittle. Gloor¹ has recently observed that cellulose nitrate films are brittle if made from low viscosity nitrocotton of a calculated chain length of 158 A or less, but are pliable when the chain length of the nitrocotton exceeds 200 A.

Now, when crystallites are forced into parallel orientation by cold drawing, long crystallites, rigid in themselves, overlap and interlock to such an extent that the fiber as a whole is rigid. On the other hand, shorter crystallites, although they may be rigid individually and are in an essentially parallel alignment, do not overlap sufficiently to form a rigid fiber. They may, however, overlap and interlock enough to eliminate some of the brittleness of the unoriented crystals and permit a modicum of pliability.

In these synthetic polyester fibers, then, it appears that a group of parallel fibers, long-chain molecules, form a crystallite; and that the fiber is built of these crystallites which, judging from the mechanical properties of the fiber formed, are not so long in proportion to their width as are cellulose and similar fibers.

Carothers and Hill found that the polyesters were too soluble in certain solvents and too easily melted to be of practical value as industrial fibers. The polyamids, on the other hand, are so insoluble and infusible that they cannot be readily converted to a

¹ GLOOR, W. E., *Ind. Eng. Chem.*, **27**, 1162 (1935). Gloor's comparison of the minimum molecular length for pliable films with the minimum length suitable for fiber spinning (as found by Carothers and Hill) is somewhat misleading. The question of fibering is not involved to any great extent in the matter of brittle or pliable films of nitrocotton. The strength of the film is largely dependent upon the degree of interlocking of the structural units in a brush-heap arrangement and therefore upon the length of these units.

form suitable for spinning. They therefore compromised these by preparing a polyester-polyamid which proved to have intermediate and highly practical properties.¹ The nature of the long chains of these synthetic fibers, as compared with those of the most perfect natural fibers, may be shown as follows:

Cellulose. . .

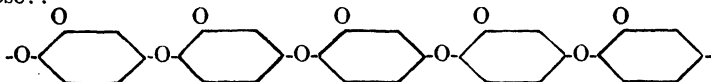

Silk -NH-R-CO-NH-R₁-CO-NH-R-

Polyester,
from di-
basic
acid and
glycol. . .

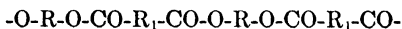

Polyester-

polyamid -O-R-CO-NH-R₁-CO-NH-R₁-CO-O-R-CO-

That these polyesters do form typical fibers, comparable in general structure to the natural fibers, is shown in a striking manner by the diffraction patterns in Fig. 72, taken by Fuller.² The series of materials represented by these patterns exhibits some interesting fibrous properties. When two simple polyesters are melted and stirred together, the product is termed a mixed polyester and, when cold-drawn, produces the pattern of Fig. 72c. According to Fuller's measurements, this consists of the superimposed patterns of the two simple polyesters.³ When two different dicarboxylic acids are condensed with the same glycol, or two glycols with the same acid, a product is obtained comparable to a mixed polyester in composition but with the different units chemically combined. This has been termed a copolyester, and its pattern is shown in Fig. 72d. When it contains only ethylene ester units, as does the one shown, only the pattern of one of the simple polyester parents appears. Cold drawing of a simple polyester or of the copolyester produces a single homogeneous fiber which fractures cleanly. A fiber drawn from a mixed polyester, on the other hand, is apt to fray at the ends when it breaks, and a microscopic examination reveals

¹ CAROTHERS, W. H., and J. W. HILL, *J. Am. Chem. Soc.*, **54**, 1566 (1932).

² FULLER, C. S., in press; see also, FULLER, C. S., and C. L. ERICKSON, *J. Am. Chem. Soc.*, **59**, 344 (1937).

³ This does not hold for all of the mixed polyesters which were examined.

a bundle of fine fibers, formed apparently because the two polyesters are incompatible and one is dispersed as globules in the other. These are evidently drawn out into fibrous form, the continuous phase acting as a cementing material. A more

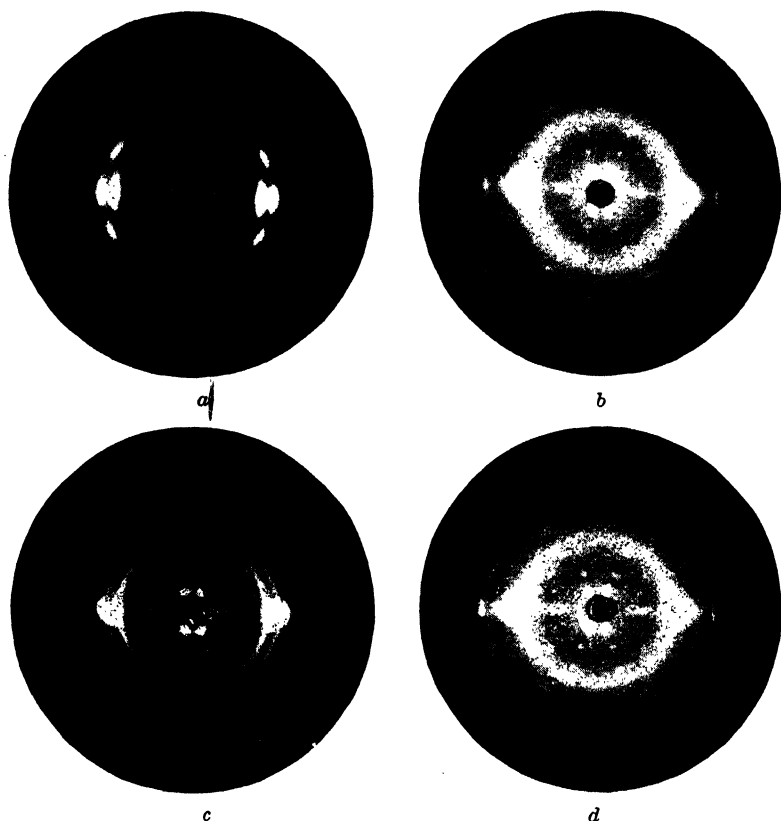

FIG. 72.—Diffraction patterns of synthetic polyester fibers. (a) Polyethylene succinate. (b) Polyethylene sebacate. (c) Mixture of a and b. (d) Sebacic and succinic acids with ethylene glycol. (Courtesy of C. S. Fuller.)

detailed comparison of the mechanical properties of fibers of mixed polyesters and copolyesters should prove very interesting.

Fibers of simple polyesters have considerable tensile strength and a fairly high elastic recovery,¹ resembling ramie in their stress-strain characteristics. Freshly prepared copolyesters, on

¹ CAROTHERS, W. H., and J. W. HILL, *J. Am. Chem. Soc.*, **54**, 1568 (1932).

the contrary, behave in general like natural rubber, although the tensile strength is lower. As these polyesters age, their elastic properties change to resemble those of gutta-percha and balata. This change probably results from a slow crystallization. Although the X-ray pattern of a stretched copolyester indicates some improvement in orientation, it is not sufficient to account for the marked elasticity of the fiber, and Fuller suggests, therefore, that the appreciable amount of amorphous material present must be responsible for the elasticity.

Recent crystallographic studies of the polymerization of the polyoxymethylenes have suggested a possible mechanism of chain formation.¹ Trioxymethylene crystallizes in the hexagonal system.

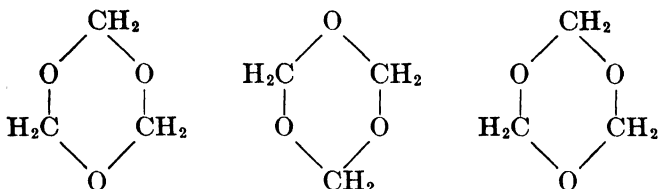

When exposed to light in the presence of free formaldehyde, nuclei are formed, and starting from them, fibrous polyoxymethylene,

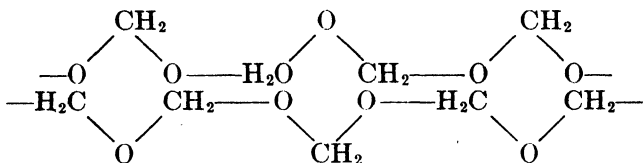

appears as a result of an interchange of covalent bonds, made possible by the apposition of appropriate molecules by crystal forces. As suggested by Bernal and Crowfoot,² this shift in covalent bonds is nature's adaptation of the "zipper" principle and the mechanism may be quite common in fiber formation.

Fibered Bacterial Cellulose.—The fibering tendencies of bacterial cellulose membranes³ may be conveniently studied

¹ KOHLSCHUTTER, H. W., and L. SPRENGER, *Z. physik. Chem.*, **B 16**, 284 (1932); SAUTER, E., *Z. physik. Chem.*, **B 18**, 417 (1932); **B 21**, 161 (1933); *Z. Krist.*, **83**, 340 (1932).

² BERNAL, J. D., and D. CROWFOOT, *Ann. Repts. (London)*, **30**, 425 (1933).

³ BARSHA, A. J., and H. HIBBERT, *Can. J. Research*, **10**, 170 (1934), and earlier papers in the same journal.

because the cellulose need not be treated with a swelling agent to render it plastic. It has been found that when this membrane is extended in one direction the long chain or b axes line up parallel to this direction; whereas if the membrane is constricted in one direction, the 101 planes are oriented normal to that direction. These 101 planes apparently function in a manner analogous to the glide planes in metals. But the mechanism appears to be one of crystallite flow, rather than plane slip, and it is therefore largely dependent upon the shape of the crystallites.¹ Attraction of polar groups may also influence the type of orientation.

Mercurized Cotton.—If a wad of cotton is soaked in a solution of caustic soda (14 to 28 per cent by weight) and then thoroughly rinsed, it looks about as it did before the treatment. It has added reactivity, however, and possibly added strength, as was discovered nearly a century ago by Mercer.² On the other hand, if this treatment is carried out with the cotton fibers under tension, the fibers assume a lustrous sheen characteristic of mercerized cotton. It was a simple thing, this application of tension to the fibers,³ but its discovery was of the most far-reaching importance to textile manufacturers.

The caustic soda treatment causes a change in the crystalline cellulose. There is a difference of opinion as to whether the NaOH actually combines with cellulose, forming a sodium cellulosate⁴ or an addition compound $C_6H_{10}O_5 \cdot XNaOH$,⁵ or whether it is simply adsorbed⁶ by the cellulose fibers. The evidence, pro and con, has been sifted by Bancroft and Calkin.⁷

¹ Sisson, W. A., *J. Phys. Chem.*, **40**, 355 (1936). The details given in this paper and another soon to be published on the orientation of cellulose in regenerated films are extremely interesting and of the utmost importance.

² MERCER, English patent, 13,296 (1850).

³ THOMAS and PREVOST, English patent, 20,714 (1896).

⁴ NEALE, S. M., *J. Textile Inst.*, **20**, 373T (1929).

⁵ MEYER, K. H., and H. MARK, "Der Aufbau der hochpolymeren organischen Naturstoffe," Hirschwaldsche Buchhandlung, Leipzig, 1930. VIEWEG, W., *Z. angew. Chem.*, **37**, 1008 (1924).

⁶ COWARD, H. F., and L. SPENCER, *J. Textile Inst.*, **14**, 32T (1923); LEIGHTON, A., *J. Phys. Chem.*, **20**, 32 (1916).

⁷ BANCROFT, W. D., and J. B. CALKIN, *Textile Research*, **4**, 119, 159 (1934); *J. Phys. Chem.*, **39**, 1 (1935).

A number of different diffraction patterns, all differing from that of native cellulose, have been described for the products formed by the treatment of cellulose with caustic soda. In general these patterns have been indistinct and difficult to interpret. However, Hess and Trogus¹ have obtained very sharp diffraction patterns for three different soda celluloses, formed under different conditions of treatment of cellulose by sodium hydroxide.

As a result of the correlation of X-ray data with adsorption equilibrium data, Calkin² has proposed that the treatment of cellulose with caustic results in the formation of an addition compound, perhaps $C_6H_{10}O_5 \cdot 2NaOH$, which is adsorbed on the native cellulose although this is only one possible interpretation of his data.

It is obviously necessary to draw rather fine distinctions if one is to take a position on this question. No compound of cellulose and sodium hydroxide, either a salt or an addition compound, has even been defined by analysis. The X-ray data, which are the strongest evidence of compound formation, might be the result of some type of preferential adsorption. Perhaps sodium hydroxide molecules may be adsorbed unequally by, or penetrate unequally into, the cellulose lattice, prying the long chains apart more in one direction than in others and forcing a rearrangement. Of course, the term "preferential adsorption" raises the question as to where adsorption ceases and compound formation begins. It has been pointed out in a preceding chapter that, on the basis of bonding forces, it is difficult to draw a line between compound formation and adsorption. We know that many organic molecules have relatively active polar groups which might adsorb preferentially; just as adsorption can take place more readily on certain faces of crystals than on others because of the presence of residual electrical forces of *the same nature as those which cause compound formation*. It is a fair assumption that the attractive forces within the cellulose-soda complex are neither the van der Waals' forces generally associated with adsorption, nor the pure covalent bonds characteristic of the typical organic molecule, but are an average of these two.

¹ HESS, K., and C. TROGUS, *Z. physik. Chem.*, **B 11**, 381 (1930).

² CALKIN, J. B., *J. Phys. Chem.*, **40**, 27 (1936).

To return to mercerized cotton, when the caustic soda is washed out, pure cellulose remains, but it has a different crystal structure from that of the original, native cellulose.¹ Pretreated or mercerized cellulose may be considered as an allotropic form of cellulose, and, strange as it may seem, it is probably the stable form. This is indicated by the fact that whenever the native cellulose structure is loosened by any reagent which alters the structure and the reagent washed out the cellulose crystallizes in the regenerated rather than the native form.² Why the native cellulose should be a metastable form is not known, but the situation is not unique in nature. The oyster builds the pearly part of its shell of aragonite, although the outer part is calcite. In the pearly part, organic matter is preferentially adsorbed by the growing CaCO_3 crystals in such a way that the formation of calcite is inhibited, but the formation of metastable aragonite is favored.³ It is entirely possible that the same situation may accompany the growth of cellulose.

The desirable properties of mercerized cellulose are due partially to the fibering—the orientation of the cellulose crystallites, produced by tension, in the direction of the fiber axis. To this orientation may be due the characteristic luster, for, without the application of tension during the process, a lustrous surface is not formed.⁴

The X-ray diffraction patterns show definitely the effect of tension upon the orientation of the crystallites in a mercerized fiber.⁵ The long chains may be as nearly parallel as they are

¹ SPONSLER, O. L., *J. Am. Chem. Soc.*, **50**, 1947 (1928); MEYER, K. H., and H. MARK, "Der Aufbau der hochpolymeren organischen Naturstoffe," Hirschwaldsche Buchhandlung, Leipzig, 1930.

² MEYER, K. H., and N. P. BADENHUIZEN, *Nature*, **140**, 281 (1937), have recently reported the conversion of viscose into native cellulose, as evidenced by the X-ray diagrams, by treating it first with boiling formamide and then with glycerin.

³ SAYLOR, C. H., *J. Phys. Chem.*, **32**, 1441 (1928).

⁴ CLIBBENS, D. A., *J. Textile Inst.*, **14**, 217T (1923), has suggested that the luster has something to do with the cuticle, which may be partly removed. His results are somewhat contradictory, however. It has also been suggested [HARRISON, *J. Soc. Dyers Colourists*, **31**, 198 (1915)] that the smoothness of a mercerized surface influences luster. See also, BARRATT, T., *J. Soc. Chem. Ind.*, **43**, 593B (1924).

⁵ See, for example, CLARK, G. L., *Ind. Eng. Chem.*, **22**, 474 (1930).

in ramie. It has also been shown that the refractive index of a cellulose fiber is a measure of the degree of orientation of the crystallites with respect to the fiber axis¹ and may be used as a qualitative test for the degree of mercerization. The following data, from Preston, are interesting:

	Angle of Slope of Crystallites to Fiber Axis
Native flax.....	0° approx.
Flax, mercerized, tension.....	0°
Flax, mercerized, no tension.....	34°
Native cotton.....	30-35° approx.
Cotton, mercerized, tension.....	20.5°
Cotton, mercerized, no tension.....	35.6°

Evidently, the mercerization of cotton, under tension, improves greatly upon the orientation in the native cotton, and the properties of the mercerized product bear this out.

Mercerized cotton takes up dyes more readily than does native cotton, as illustrated by the data in Table 119. This new arrangement of the cellulose chains appears to be easier for reagents to get at.

TABLE 119.—ADSORPTION OF BENZOPURPURIN BY COTTON*
Dye Absorbed,
Per Cent

Unmercerized.....	1.53
Mercerized, tension.....	2.90
Mercerized, no tension.....	3.39

* KNECHT, E., *J. Soc. Dyers Colourists*, **24**, 68 (1908); **24**, 107 (1908).

Cotton pretreated² with $ZnCl_2$ takes up more NaOH than does native cotton, and cotton mercerized under tension with $ZnCl_2$ takes up less NaOH than the pretreated,³ probably because tension contracts the transverse spaces between the crystallites.

The greater the concentration of caustic soda present, the smaller is the effect of tension upon the orientation of cellulose crystallites during mercerization. That tension does orient the crystallites is shown, further, by the fact that mercerized cotton takes up less of water, caustic soda, and other reagents than

¹ PRESTON, J. M., *Trans. Faraday Soc.*, **29**, 65 (1933).

² Mercerized without tension.

³ NEALE, S. M., *J. Textile Inst.*, **22**, 320T (1931).

does pretreated cotton.¹ Furthermore, it has been shown that the extensibility of pretreated cotton is considerably greater than that of the same cotton mercerized,² implying that the orientation of the crystallites is more perfect in mercerized cotton than in pretreated, before the extension occurs.

The foregoing discussion of mercerization and mercerized cotton has been, of necessity, rather fragmentary. Because our interest is primarily in fiber structure, the discussion has been limited to the selection, more or less at random, of data which will leave little doubt of the very practical importance of variations in this fiber structure: variations which, because they concern the arrangement of atoms and molecules, invisible even to the microscope, might otherwise be put aside by the practical man as facts of only academic interest.

Regenerated Cellulose.—Cellulose may be completely dispersed by caustic soda in carbon bisulfide. The crystalline structure is broken down and the cellulose goes into colloidal solution. In the familiar viscose process, the alkaline dispersion is spun through a spinneret into an acid bath and a fiber is thus precipitated continuously. This product is known as regenerated cellulose. It has the characteristic diffraction pattern of mercerized cotton. Mechanically, the process resembles that of the silkworm spinning his thread.

The first rayon fibers were not of the highest quality; they lacked tensile strength and disintegrated too easily when washed. We are now sufficiently well versed in the structure and properties of fibers to predict that both of these defects may be minimized if the orientation of the cellulose crystallites in the fiber can be improved. It should be possible to improve the orientation by the application of tension to the fiber at some stage in the process after its formation, but before it dries and before the crystallites become set. By the ingenious expedient of drying rayon threads under tension, the tensile strength of the commercial product has actually been increased several-fold (see Table 121) and rayon has become a much more useful product.³

¹ URQUHART, A. R., *J. Textile Inst.*, **17**, 557 (1927).

² BARRATT, T., *J. Textile Inst.*, **13**, 17T (1922).

³ Of course, many factors other than spinning under tension have contributed to the development of rayon to its present quality.

The process is somewhat analogous to the cold drawing of wire in so far as it results in better orientation of the crystals. Here the analogy ceases; the possibility of strengthening the fiber depends upon the presence of building units much longer than they are broad or thick.

An alkaline solution of cellulose may be precipitated in sheets instead of threads. Cellophane is formed in this manner. If these are dried under tension, directional properties indicating an orientation or fiberiing of the crystallites will be found. A strip cut in the cross-machine direction, for example, shows a load versus elongation curve characteristic of a ductile fiber; while a strip cut in the machine direction shows a curve indicating lack of ductility.¹ Ductility is to be expected in fibers in which the crystallites are poorly oriented. Moreover, stretching and drying Cellophane under tension increase the tensile strength in the direction of stretch by several hundred per cent.²

The directional strains set up by orientation of the crystallites during the casting of sheets of regenerated cellulose are of considerable practical importance, as anyone who prints this material can testify. Influenced by the moisture in the atmosphere as well as by the application of ink, such sheets tend to curl in a very unpredictable way.

The properties of acetate rayon may be influenced in a very practical manner by the tension under which the threads are spun; tensile strength, dyeing properties, and luster are particularly sensitive to tension. The properties of rayon threads already formed may be affected by stretching after softening with hot water, steam, or some organic swelling agent. This procedure is particularly useful to restore the luster of delustered rayon, and exerts a remarkable effect on crease resistance. Stretching increases the creasing of rayon.³ The effect might be anticipated, because the more perfect orientation of the fibers induced by stretching should result in more brittle, less resilient fibers.

It is of interest to note that cellulose is not thermoplastic, apparently because the cohesive forces between chains are too strong to be broken down at temperatures lower than the

¹ MARK, H., *Trans. Faraday Soc.*, **29**, 6 (1933).

² MARK, H., *Melliands' Textilber.*, **10**, 695 (1929).

³ HALL, A. J., *Am. Dyestuff Repr.*, **25**, 533 (1936).

decomposition temperature. Cellulose is made plastic in the usual sense by swelling agents, so that water and caustic soda are to cellulose or wool what heat is to rubber and other truly thermoplastic substances.

Many cellulose derivatives are thermoplastic in the usual sense, whereas cellulose itself is not. In the former, the introduction of relatively large radicals in place of hydroxyl groups reduces the cohesive forces between chains to the point where they can be influenced appreciably by moderate heat. This is true of the trinitrate, the triacetate, the butyrate, and the laurate. Furthermore, they soften at a lower temperature, the larger the esterifying group added. Additional evidence of the weakening effect of these large radicals is to be found in tensile strength measurements. That of cellulose acetate is 9 to 12 kg. per square millimeter, and its elongation is 15 to 25 per cent; while the tensile strength of cellulose stearate is only 0.5 kg. per square millimeter, and its elongation as high as 140 per cent. It is essentially plastic at room temperature.

Sheppard has found¹ that sheets of cellulose acetate are anisotropic (indicating an orientation of crystallites) if dried under tension or if an isotropic sheet is swelled and then stretched to dry. If a sheet is evaporated on solid supports, without tension, there is a uniaxial orientation of the crystallites; if evaporation is on liquid mercury, there is no evidence of orientation. The same cellulose acetate may be made to form either a brittle or flexible film on drying, depending upon the solvent used. Preferred orientation of the crystallites may well be involved.

Artificial Fibering of Proteins.—The familiar procedure, drying under tension, has recently been employed with some success to improve the quality of catgut sutures.² As one would predict, drying under tension causes a much more perfect alignment of the long molecules in the direction of the fiber axis. The effect of this improved fibering upon tensile strength is suggested in Table 120.

That this more perfect orientation of the chain molecules is apt to affect the adsorption characteristics of the ligature and its

¹ SHEPPARD, S. E., *Trans. Faraday Soc.*, **29**, 77 (1933).

² CLARK, G. L., R. K. FLEGE, and P. F. ZIEGLER, *Ind. Eng. Chem.*, **26**, 440 (1934).

reactivity toward reagents in general goes without saying. This is an important feature as it is related to contact with the body fluids. It has been shown, for example, that the protein fibers, listed in the order of their ability to take up and hold increasing amounts of water are: silk, horsehair, wool, collagen, muscle, gelatin.¹ The relative positions are just the same when they

TABLE 120.—EFFECT OF TENSION DRYING ON STRENGTH OF FINISHED CATGUT

Run	Drying tension, kg.	Tensile strength, kg. per square centimeter
1	2.27	18.5
	2.27	20.2
	0	16.6
8	2.27	19.2
	0	16.4
9	3.18	16.4
	0	15.2
10	4.54	18.5
	0	14.8
	4.54	18.7
	4.54	21.6

* From CLARK, G. L., R. K. FLEGE, and P. F. ZIEGLER, *Ind. Eng. Chem.*, **26**, 440 (1934).

are listed in the order of decreasing orientation of the long protein chains. Silk forms the most perfect fiber, whereas gelatin shows evidence of fibering only when stretched.

Gelatin or glue rendered insoluble by treatment with formaldehyde may well be the result of fibering. Whenever a protein is treated with formaldehyde, the diffraction patterns show a very strong interference corresponding to a distance between parallel protein chains.² This may be the result of the more perfect parallel alignment of a greater number of protein

¹ LLOYD, D. J., *Trans. Faraday Soc.*, **29**, 132, 554 (1933).

² CLARK, G. L., and J. H. SCHENK, *Radiology*, **28**, 357 (1937).

chains, and thus the formation of very large particles which are difficult to disperse. Proteins insoluble in water are not readily attacked by formaldehyde until they have been swelled. This is true of zein, a prolamine, and of hair, feathers, and tendon. Because all of the proteins examined, except silk, show similar diffraction effects when treated with formaldehyde, it is suggested that the reaction of formaldehyde on proteins takes place at the amide nitrogen. At any rate it appears to be very closely connected with the fundamental structure of the molecule.

Summary.—In general, a fiber is any crystalline aggregate in which the crystals show a preferred orientation, the direction of orientation being that of the fiber axis. This structural conception includes minerals and metals as well as the animal and plant products commonly called fibers.

Animal and plant fibers are built of long molecular chains, the links of which are held together by primary valences. Where these chains lie parallel to each other, according to a fixed plan, a crystalline form of matter exists. In cellulose at least, a large proportion of the fiber is composed of crystalline material, the nature of which has been described. In protein and other fibers the crystals are not always so well formed.

The crystallites in a fiber may be oriented so that the primary valence chains are roughly parallel to the fiber axis, or inclined at an angle to this axis.

Fibers may consist of extended molecular chains (*e.g.*, cellulose, natural silk, stretched rubber, stretched wool) or possibly of folded molecular chains (*e.g.*, unstretched rubber, unstretched wool). The elastic fibers appear to be those in which the extension of the molecular chains is reversible (*e.g.*, wool, rubber, muscle).

The fibrous form of matter is very important in our understanding of solids because preferred orientation of the crystalline groups gives directional properties to such solids. Among the most significant of these properties are (1) tensile strength in the direction of the fiber axis, (2) brittleness or resiliency at right angles to this axis, and (3) the resistance offered by the fibers to the penetration of reagents. The changes which may be produced in the strength of fibers are not merely of theoretical interest. They are of sufficient magnitude to be of practical

significance. In Table 121 are listed comparative tensile strengths of some of the substances which have been discussed in the preceding pages.

TABLE 121.—TENSILE STRENGTHS OF SOME COMMON FIBERS
(Kilograms per square millimeter)

Steel.....	50-160*
Copper.....	20- 50*
Flax.....	60-110*
Ramie.....	70- 80*
Cotton.....	28- 44*
Silk, natural fiber.....	35- 44*
Silk, natural secretion, in mass.....	10†
Silk, natural secretion, mechanically oriented....	30†
Rayon, ordinary.....	18- 20‡
Rayon, well oriented.....	60‡
Rubber, ordinary.....	15- 20‡
Rubber, well oriented.....	60‡
Gelatin, unstretched.....	4.4§
Gelatin, stretched.....	9.3§
Tendon, swine, natural.....	11§
Tendon, heated and orientation destroyed.....	3§
Same tendon, stretched to original length.....	10.6§
Synthetic fiber from polyester.....	16- 24

* MARK, H., *Trans. Faraday Soc.*, **29**, 6 (1933).

† VON WEIMARN, P. P., *Trans. Faraday Soc.*, **29**, 13 (1933).

‡ CLARK, G. L., *Ind. Eng. Chem.*, **22**, 474 (1930).

§ BERGMANN, M., and B. JACOBI, *Kolloid-Z.*, **49**, 46 (1920).

|| CAROTHERS, W. H., *Chem. Rev.*, **8**, 416 (1931).

One cannot fail to be impressed by the similarity in behavior of all fibers, which emphasizes the relation between their structure and properties. It is so striking that one may with reasonable certainty predict the general properties of any fiber. The tensile strength of natural silk is increased by stroking it, when in a plastic condition, with the fingers; the tensile strength of steel wire is increased by drawing it through a die. The longitudinal shrinkage of wood is least when the fibrils lie parallel to the fiber axis; the elasticity of rubber is negligible when the long-chain molecules are "set" parallel to the direction of stretching; elongation of steel wire is least when the crystal grains are most regularly oriented parallel to the axis of the wire—and so it goes. The same sort of treatment produces the same crystal orientation, and this in turn imparts the same directional properties to the fiber, whether it be animal, vegetable, or mineral—fashioned by nature or by man.

APPENDIX

TABLE 122.—ATOMIC AND IONIC RADII

Atom No.	Element	Atomic radii 1	Ion	Ionic radii, C.N.6			
				2	3	4	
1	H	See p. 57	H ⁻ , H ⁺	See p. 57			
2	He						
3	Li	1.50	Li ⁺	0.68	0.60	0.78	
4	Be	1.112	Be ⁺⁺	0.39	0.31	0.34	
5	B		B ⁺³	0.24	0.20		
6	C	0.77	B-O† C ⁺⁴	0.19	0.15	0.20	1.35(BO ₃)‡
7	N	0.53	CN ⁻ C-O N ⁺⁵ NH ₄ ⁺		0.11	0.1-2 1.43	1.95 1.31(CO ₃)§ 1.50*
8	O		N-O O ⁻ OH ⁻ F ⁻	1.40	1.40	1.32	1.23(NO ₃)‡ 1.33*
9	F	0.68		1.33	1.36	1.33	
10	Ne	1.60					
11	Na	1.86	Na ⁺	0.98	0.95	0.98	
12	Mg	1.595	Mg ⁺⁺	0.71	0.65	0.78	
13	Al	1.48	Al ⁺³	0.55	0.50	0.57	
14	Si	1.172	Si ⁺⁴ Si ⁻⁴ Si-O P ⁺⁵	0.44	0.41 2.71	0.39 1.98	1.63**
15	P(black)	1.08	P ⁺⁵ P-O P ⁺³	0.34	0.34	0.3-4	1.56**
16	S(rhombic)	1.06	S ⁺⁶ S ⁺² S-O	1.85	2.12 1.84	0.34 1.74	1.49**
17	Cl	0.97	Cl ⁺⁷ Cl ⁻ Cl-O	1.81	0.26 1.81	1.81	1.45**
18	A	1.91					
19	K	2.27	K ⁺	1.33	1.33	1.33	
20	Ca	1.97	Ca ⁺⁺	0.98	0.99	1.06	
21	Sc		Sc ⁺³	0.78	0.81	0.83	
22	Ti	1.45	Ti ⁺⁺ Ti ⁺³ Ti ⁺⁴	0.62	0.68	0.64	0.76* 0.70*
23	V	1.313	V ⁺³ V ⁺⁴ V ⁺⁵		0.59†† 0.59	0.61 0.4	0.75* 0.57*
24	Cr	α1.246 β1.35 γ1.22	Cr ⁺³ Cr ⁺⁶		0.52	0.65 0.34-4	0.70*
25	Mn	α1.24 β1.26 γ1.29	Mn ⁺⁺ Mn ⁺⁴ Mn ⁺⁷		0.80†† 0.50†† 0.46	0.91 0.52	
26	Fe	α1.238 β1.26	Fe ⁺⁺ Fe ⁺³		0.75††	0.83 0.67	
27	Co	1.25	Co ⁺⁺ Co ⁺³		0.72††	0.82	0.65*

TABLE 122.—ATOMIC AND IONIC RADII.—(Continued)

Atom No.	Element	Atomic radii 1	Ion	Ionic radii, C.N.6			
				2	3	4	
28	Ni	1.243	Ni ⁺⁺		0.69††	0.78	
29	Cu	1.275	Cu ⁺		0.96		0.58* approx.
30	Zn	1.329	Zn ⁺⁺		0.74	0.83	
31	Ga	1.22	Ga ⁺³		0.62	0.62	
32	Ge	1.22	Ge ⁺⁴		0.53	0.44	
33	As	1.25	Ge ⁻⁴		2.72		
			As ⁺³				0.69*
			As ⁺⁵		0.47		
			As ⁻³		2.22		
34	Se	1.16	As-O				2.01(AsO ₃)‡
			Se ⁺⁶	1.96	0.42	0.3-4	
35	Br	1.13	Se ⁻²		1.98	1.91	
			Br ⁺⁶		0.39		
36	Kr	2.0	Br ⁻	1.96	1.95	1.96	1.68(BrO ₃)‡
			Br-O				
			Rb ⁺	1.48	1.48	1.49	
			Sr ⁺⁺	1.15	1.13	1.27	
37	Rb	2.43	Rb ⁺				
38	Sr	2.14	Sr ⁺⁺				
39	Y	1.79	Y ⁺³	0.93	0.93	1.06	
40	Zr	1.58	Zr ⁺⁴	0.79	0.80	0.87	
41	Cb	1.426	Cb ⁺⁴		0.67††	0.69	
			Cb ⁺⁵		0.70		
42	Mo	1.36	Mo ⁺⁴		0.66††	0.68	
			Mo ⁺⁶		0.62		
43	Ma						
44	Ru	1.322	Ru ⁺⁴		0.63††	0.65	0.60*
45	Rh	1.342	Rh ⁺³			0.69	0.75*
			Rh ⁺⁴				0.65*
46	Pd	1.372	Pd ⁺⁺				0.50*
47	Ag	1.441	Ag ⁺		1.26	1.13	0.97*
48	Cd	1.486	Cd ⁺⁺		0.97	1.03	
49	In	1.62	In ⁺³		0.81	0.92	
50	Sn	1.40 gray 1.508 white	Sn ⁺⁺				1.02?*
			Sn ⁺⁴		0.71	0.74	0.65*
51	Sb	1.439	Sn ⁻⁴		2.94		
			Sb ⁺³				0.90?*
			Sb ⁺⁵		0.62		
			Sb ⁻³		2.45		
52	Te	1.44	Sb-O				2.22(SbO ₃)‡
			Te ⁺⁴		0.81††	0.89	0.84
			Te ⁺⁶		0.56		
53	I	1.35	Te ⁻	2.18	2.21	2.11	
			I ⁺⁵			0.94	
			I ⁺⁷		0.50		
54	X	2.2	I ⁻	2.19	2.16	2.20	
55	Cs	2.62	Cs ⁺	1.67	1.69	1.65	
56	Ba	2.17	Ba ⁺⁺	1.31	1.35	1.43	
57	La	1.86	La ⁺³	1.06	1.15	1.22	
58	Ce	1.81	Ce ⁺³			1.18	
			Ce ⁺⁴	0.89	1.01	1.02	
59	αPr	1.82	Pr ⁺³			1.16	
			Pr ⁺⁴		0.92††	1.00	
60	αNd	1.81	Nd ⁺³				1.08*
63	Eu		Eu ⁺⁺				1.17††
64	Gd		Gd ⁺³			1.11	
68	Er	1.87	Er ⁺³			1.04	
69	Tm		Tm ⁺³			1.04	
70	Yb		Yb ⁺³			1.00	
71	Lu		Lu ⁺³			0.99	
72	Hf	1.57					
73	Ta	1.427					
74	W	β1.37 α1.26	W ⁺⁴		0.66††	0.68	
			W ⁺⁶				0.65?*

TABLE 122.—ATOMIC AND IONIC RADII.—(Continued)

Atom No.	Element	Atomic radii 1	Ion	Ionic radii, C.N.6			
				2	3	4	
75	Re	1.367					
76	Os	1.335	Os ⁺⁴		0.65††	0.67	
77	Ir	1.354	Ir ⁺⁴		0.64††	0.66	
78	Pt	1.384	Pt ⁺⁺				0.52*
			Pt ⁺⁴				0.55?*
79	Au	1.439	Au ⁺		1.37		
80	Hg	1.50	Hg ⁺⁺		1.10	1.12	
81	Tl	β 1.71	Tl ⁺		1.44††	1.49	
		α 1.70	Tl ⁺²		0.95	1.05	
82	Pb	1.746	Pb ⁺⁺		1.21*	1.32	1.18*
			Pb ⁺⁴		0.84	0.84	0.70*
83	Bi	1.55	Bi ⁺³				1.20*
			Bi ⁺⁵		0.74		
88	Th	1.79	Ra ⁺²				1.52‡‡
90	U	β 1.48	Th ⁺⁴		1.02††	1.10	
92		α 1.41	U ⁺⁴		0.97††	1.05	

Column 1. NEUBURGER, M. C., *Z. Krist.*, **93**, 1 (1936).

Column 2. ZACHARIASEN, W. H., *Z. Krist.*, **80**, 137 (1931) calc.

Column 3. PAULING, LINUS, *J. Am. Chem. Soc.*, **49**, 765 (1927), calc.

Column 4. GOLDSCHMIDT, V. M., *Ber.*, **60**, 1263 (1927), empirical.

* WYCKOFF, R. W. G., "The Structure of Crystals," p. 192, Reinhold Publishing Corporation, New York, 1931. Wyckoff's values have been given when they differ markedly the other data, or when they supplement the other data.

† In B-O, C-O, N-O, Si-O, P-O, S-O, Cl-O, Br-O, Sb-O the numerical value is the inter-atom distance, not a radius.

‡ ZACHARIASEN, W. H., *J. Am. Chem. Soc.*, **53**, 2123 (1931).

‡ PAULING, LINUS, L. O. BROCKWAY, and J. Y. BEACH, *J. Am. Chem. Soc.*, **57**, 2705 (1935).

** ZACHARIASEN, W. H., private communication.

†† PAULING, LINUS, *J. Am. Chem. Soc.*, **49**, 765 (1927), empirical values.

‡‡ PAULING, LINUS, *J. Am. Chem. Soc.*, **59**, 1132 (1937).

‡‡ SCHULEE, G. E. R., *Z. physik. Chem.*, **B 32**, 430 (1936).

TABLE 123.—TABLE OF UNIVALENT RADII

Valence	-3	-2	-1	1	2	3	4	5	6	7
			H	Li	Be	B	C	N		
<i>Z</i>			1.36	0.68	0.55	0.42	0.38	0.35		
<i>P</i>			2.08	0.60	0.44	0.35	0.29	0.25		
	N	O	F	Na	Mg	Al	Si	P	S	Cl
<i>Z</i>	2.02	1.76	1.33	0.98	0.89	0.79	0.69	0.66	0.64	0.63
<i>P</i>	2.47	1.76	1.36	0.95	0.82	0.72	0.65	0.59	0.53	0.49
	P	S	Cl	K	Ca	Sc	Ti	V	Cr	Mn
<i>Z</i>	2.56	2.20	1.81	1.33	1.17	1.03	0.88	0.82	0.70	0.68
<i>P</i>	2.79	2.19	1.81	1.33	1.18	1.06	0.96	0.88	0.81	0.75
	As	Se	Br	Rb	Sr	Y	Zr	Cb	Mo	
<i>Z</i>	2.62	2.29	1.96	1.48	1.34	1.19	1.07	0.98	0.90	
<i>P</i>	2.85	2.32	1.95	1.48	1.32	1.20	1.09	1.00	0.93	
	Sb	Te	I	Cs	Ba	La	Ce			
<i>Z</i>	2.77	2.47	2.19	1.67	1.49	1.30	1.14			
<i>P</i>	2.95	2.50	2.16	1.69	1.53	1.39	1.27			

Z. ZACHARIASEN, W. H., *Z. Krist.*, **80**, 137 (1931).

P. PAULING, LINUS, *J. Am. Chem. Soc.*, **49**, 765 (1927).

TABLE 124.—ELECTRONIC STRUCTURE OF NEUTRAL ATOMS

<i>n</i> = Atom.	K 1			L 2			M 3			N 4				O 5			P 6			Q 7
	<i>s</i>	<i>s</i>	<i>p</i>	<i>s</i>	<i>p</i>	<i>d</i>	<i>s</i>	<i>p</i>	<i>d</i>	<i>m</i>	<i>s</i>	<i>p</i>	<i>d</i>	<i>s</i>	<i>p</i>	<i>d</i>	<i>s</i>			
H	1																			
He	2																			
Li	2	1																		
Be	2	2																		
B	2	2	1																	
C	2	2	2																	
N	2	2	3																	
O	2	2	4																	
F	2	2	5																	
Ne	2	2	6																	
Na	2	2	6	1																
Mg	2	2	6	2																
Al	2	2	6	2	1															
Si	2	2	6	2	2															
P	2	2	6	2	3															
S	2	2	6	2	4															
Cl	2	2	6	2	5															
Ar	2	2	6	2	6															
K	2	2	6	2	6	1	1													
Ca	2	2	6	2	6	2	2													
Sc	2	2	6	2	6	1	2													
Ti	2	2	6	2	6	2	2													
V	2	2	6	2	6	3	2													
Cr	2	2	6	2	6	5	1													
Mn	2	2	6	2	6	5	2													
Fe	2	2	6	2	6	6	2													
Co	2	2	6	2	6	7	2													
Ni	2	2	6	2	6	8	2													
Cu	2	2	6	2	6	10	1													
Zn	2	2	6	2	6	10	2													
Ga	2	2	6	2	6	10	2	1												
Ge	2	2	6	2	6	10	2	2												
As	2	2	6	2	6	10	2	3												
Se	2	2	6	2	6	10	2	4												
Br	2	2	6	2	6	10	2	5												
Kr	2	2	6	2	6	10	2	6												
Rb	2	2	6	2	6	10	2	6					1							
Sr	2	2	6	2	6	10	2	6					2							
Y	2	2	6	2	6	10	2	6	1				2							
Zr	2	2	6	2	6	10	2	6	2				2							
Cb	2	2	6	2	6	10	2	6	4				1							

TABLE 124.—ELECTRONIC STRUCTURE OF NEUTRAL ATOMS.—(Continued)

n = Atom	K 1			L 2			M 3			N 4				O 5			P 6			Q 7
	s	s	p	s	p	d	s	p	d	m	s	p	d	s	p	d	s			
Mo	2	2	6	2	6	10	2	6	5		1									
Ma	2	2	6	2	6	10	2	6	6		1									
Ru	2	2	6	2	6	10	2	6	7		1									
Rh	2	2	6	2	6	10	2	6	8		1									
Pd	2	2	6	2	6	10	2	6	10											
Ag	2	2	6	2	6	10	2	6	10		1									
Cd	2	2	6	2	6	10	2	6	10		2									
In	2	2	6	2	6	10	2	6	10		2	1								
Sn	2	2	6	2	6	10	2	6	10		2	2								
Sb	2	2	6	2	6	10	2	6	10		2	3								
Te	2	2	6	2	6	10	2	6	10		2	4								
I	2	2	6	2	6	10	2	6	10		2	5								
X	2	2	6	2	6	10	2	6	10		2	6								
Cs	2	2	6	2	6	10	2	6	10		2	6			1					
Ba	2	2	6	2	6	10	2	6	10		2	6			2					
La	2	2	6	2	6	10	2	6	10		2	6		1	2					
Rare earths	2	2	6	2	6	10	2	6	10	1-14	2	6		1	2					
Hf	2	2	6	2	6	10	2	6	10	14	2	6		2	2					
Ta	2	2	6	2	6	10	2	6	10	14	2	6		3	2					
W	2	2	6	2	6	10	2	6	10	14	2	6		4	2					
Re	2	2	6	2	6	10	2	6	10	14	2	6		5	2					
Os	2	2	6	2	6	10	2	6	10	14	2	6		6	2					
Ir	2	2	6	2	6	10	2	6	10	14	2	6		7	2					
Pt	2	2	6	2	6	10	2	6	10	14	2	6		8	2					
Au	2	2	6	2	6	10	2	6	10	14	2	6		10	1					
Hg	2	2	6	2	6	10	2	6	10	14	2	6		10	2					
Tl	2	2	6	2	6	10	2	6	10	14	2	6		10	2	1				
Pb	2	2	6	2	6	10	2	6	10	14	2	6		10	2	2				
Bi	2	2	6	2	6	10	2	6	10	14	2	6		10	2	3				
Po	2	2	6	2	6	10	2	6	10	14	2	6		10	2	4				
—	2	2	6	2	6	10	2	6	10	14	2	6		10	2	5				
Nt	2	2	6	2	6	10	2	6	10	14	2	6		10	2	6				
—	2	2	6	2	6	10	2	6	10	14	2	6		10	2	6		1		
Ra	2	2	6	2	6	10	2	6	10	14	2	6		10	2	6		2		
Ac	2	2	6	2	6	10	2	6	10	14	2	6		10	2	6	1	2		
Th	2	2	6	2	6	10	2	6	10	14	2	6		10	2	6	2	2		
Pa	2	2	6	2	6	10	2	6	10	14	2	6		10	2	6	3	2		
U	2	2	6	2	6	10	2	6	10	14	2	6		10	2	6	5	1		

TABLE 125.—TETRAHEDRAL ATOMIC RADII*

	Be	B	C	N	O	F
	1.07	0.89	0.77	0.70	0.66	0.64
	Mg	Al	Si	P	S	Cl
	1.40	1.26	1.17	1.10	1.04	0.99
Cu	Zn	Ga	Ge	As	Se	Br
1.35	1.31	1.26	1.22	1.18	1.14	1.11
Ag	Cd	In	Sn	Sb	Te	I
1.53	1.48	1.44	1.40	1.36	1.32	1.28
Au	Hg	Tl	Pb	Bi		
1.50	1.48	1.47	1.46	1.46		

* PAULING, LINUS, and M. L. HUGGINS, *Z. Krist.*, **87**, 205 (1934).

TABLE 126.—NORMAL-VALENCE RADII FOR NONMETALLIC ATOMS

Single-bond Radii*					Double-bond Radii† (Factor 0.87)			
	H	(0.375 A in H ₂)			B	C	N	O
	0.28				0.80	0.67	0.61	0.57
B	C	N	O	F		Si	P	S
0.89	0.77	0.70	0.66	0.64		1.06	1.00	0.95
	Si	P	S	Cl	Triple-bond Radii† (Factor 0.78)			
	1.17	1.10	1.04	0.99		C	N	O
	Ge	As	Se	Br		0.61	0.55	0.52
	1.22	1.21	1.17	1.14		Si	P	S
	Sn	Sb	Te	I		0.99	0.93	0.88
	1.40	1.41	1.37	1.33				
	Pb	Bi						
	1.46	1.51						

* PAULING, LINUS, and M. L. HUGGINS, *Z. Krist.*, **87**, 205 (1934).† PAULING, LINUS, and L. O. BROCKWAY, *J. Am. Chem. Soc.*, **59**, 1223 (1937)

TABLE 127.—OCTAHEDRAL ATOMIC RADII FROM PYRITE TYPE CRYSTALS*

Valence	Fe	Co	Ni	Ru Os	Rh Ir	Pd Pt	Ag Au
II	1.23	1.32	1.39	1.33	1.43	1.50	1.54 (by extrapolation)
III		1.22	1.31		1.32	1.42	1.49
IV			1.21			1.31	1.41

Square Atomic Radii*

Co ^I	Ni ^{II}	Cu ^{III}	Rh ^I Ir ^I	Pd ^{II} Pt ^{II}	Ag ^{III} Au ^{III}
1.23	1.22	1.21 Cu ^{II} 1.32†	1.33	1.32	1.31

Trigonal Prism Atomic Radii*

Crystal	<i>d</i> obsd.	Radius calc.	
MoS ₂	2.41	1.37	Mo ^{IV}
WS ₂	2.48	1.44	W ^{IV}

* PAULING, LINUS, and M. L. HUGGINS, *Z. Krist.*, **87**, 205 (1934).† HARKER, D., *Z. Krist.*, **93**, 136 (1936).

Number of electrons in outer shell of ion

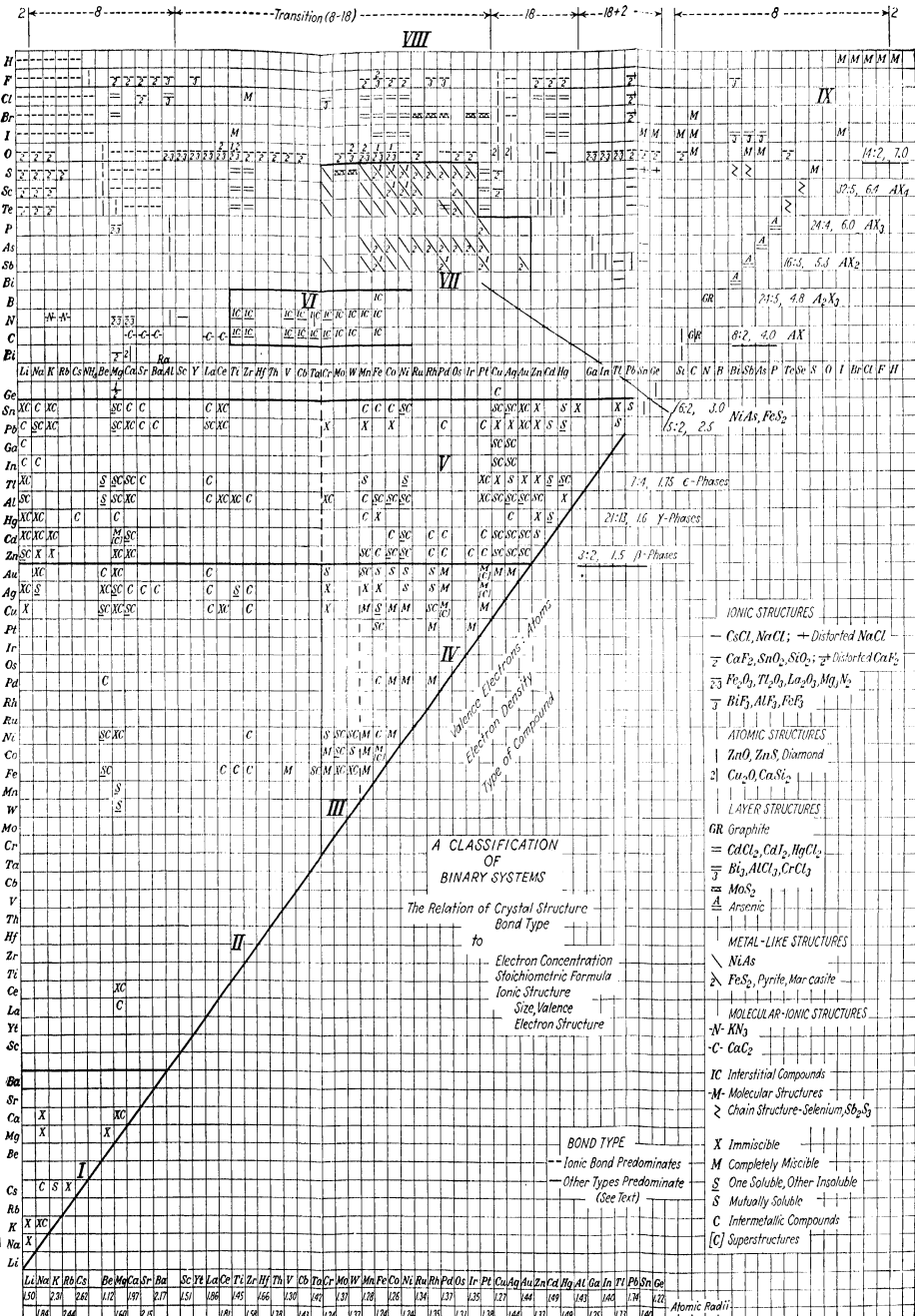

CHART A.

SUBJECT INDEX

A

- ABX_3 compounds, stability of, 282, 283
structure of, 23, 265-267
- ABX_4 compounds, stability of, 284
structure of, 274-277
- A_2BX_4 compounds, structure of, 278-280
- AX compounds, bond types in, 186
strength of, 27-30, 225-235
structure of, 9-13, 17-20, 177-186
- AX_2 compounds, bond types in, 207
strength of, 225-235
structure of, 13, 14, 20-22, 186-198
- AX_3 compounds, structure of, 199
- A_2X_3 compounds, structure of, 198
- AX_4 compounds, structure of, 201
- AX_6 compounds, structure of, 201
- Acids, 29, 246-248
- Addition compounds, 201-203
- Age hardening of alloys, 118, 119
- Aliphatic compounds, structure of, 336
- Alloys, classification of, Chart A, facing 424
formation of, 99
of iron, 114, 116
(*See also*, Intermediate phases; Solid solutions)
- Ammoniates, stability of, 313
structure of, 311
- Arsenic, structure of, 65
- Asbestos, structure of, 289, 355, 359
- Atomic crystals, strength of, 28
- Atomic radius, definition of, 33
factors influencing, 33, 39
influence of, on isomorphism, 324

- Atomic radius, of metals, 77-83
methods of determining, 52-57

B

- Bases, 29, 246-248
- BaSO, structure of, 274-277
- Beta phases, of alkalis, 147
of alkaline earths, 147
electron concentration in, 127, 139
properties of, 134, 138
structure of, 127-133, 139
- BN, structure of, 9, 185
- Boiling points as criteria of bond type, 166
- Bond, nature of, in binary compounds, 167, 186, 207
classification of crystals according to, 209
within complex ions, 320
in hydrogen halides, 167
influence, on color, 248-251
on ionic diffusion, 251-253
on photoelectric conductivity, 254
on photosensitivity, 255
on properties of, crystals, 257
(*See also*, Covalent bond; Hydrogen bond; Hydroxyl bond; Ion-dipole bond; Ionic bond; Metallic bond; Van der Waals' forces)
- Born-Haber cycle, for binary ionic compounds, 217, 219
- BPO₄, structure of, 274-277
- Bragg equation, 4
- Brass, ductility of, 134
electrical resistance of, 134
structure of, 126

- Brass, tensile strength of, 134
- Brittleness, of cellulose fibers, 324
of metal wire, 398
of regenerated cellulose fibers, 412
of synthetic resin fibers, 402, 403
- C
- CaC₂, structure of, 195
- CaCO₃, structure of, 23, 267, 268
- CaF₂, occurrence of, 187
structure of, 13
- CaSO₄, structure of, 274-277
- CaWO₄, structure of, 274-277
- C-C distance, aliphatic, 341, 342
aromatic, 341
minimum, in adjacent molecules, 344
- CdCl₂, occurrence of, 190
structure of, 190-192
- CdI₂, occurrence of, 189
structure of, 21, 189
- Cellophane, structure and swelling of, 377
- Cellulose fibers, bacterial, 406-407
crystalline, discontinuity of, 370, 371
growth rate of, 360, 371
molecular weight of, 368
stability of, 373
structure of, 363-368
swelling of, 377
(See also Cotton fibers; Ramie fibers; Wood fibers)
- Chain structures, classification of, 209
in silicates, 288, 289
- Close-packed structures, 68
- C-N distance in organic compounds, 342
- CO₂, structure of, 13, 196
- Collagen, structure of, 391
effect, of chrome tanning, 392
of swelling, 392
- Color, of atomic crystals, 248-251
effect of "loosened bond" on, 249-251
- Color, of ionic crystals, 248-251
of metals, 96
- Commensurable crystals, 37
- Compounds of variable composition, 156, 157, 201-203
- Compressibility of AX compounds, 224, 225, 256
- Coordination number, of ABX₃ structures, 267
of ABX₄ structures, 275
of A₂BX₄ structures, 279
of AX structures, 13, 186, 207
of AX₂ structures, 14, 207
of A₂X₃ structures, 198
of binary crystals, 207
definition, 12
effect, on atomic radii, 49
of radius ratios on, 12
in radicals, 23, 24, 267, 275, 279
in Werner complexes, 307
- Cotton fibers, crystalline orientation in, 374
discontinuity of, 370
disintegration of, 359-362
growth rate of, 360, 371
mercerized, 407-411
properties of, 374
structure of, 359
- Covalent bond, in alloys, 137, 138
directional properties of, 162, 164, 170, 171
effect of, on AX structures, 17, 18, 180-182
on AX₂ structures, 20-22
on color, 248-251
on coordination number, 18
on interatomic distance, 17, 19
on strength of ionic crystals, 29, 164
formation of, 16
identification of, 170-177
in metals, 87
properties of, 257
in radicals, 22, 29, 260, 261
transition, to ionic bond, 165-170
to van der Waals' force, 210, 211

- Cristobalite**, occurrence of, 188
 structure of, 13
Crystal lattice, 6
Crystal structure, as evidence of
 bond type, 175
 influence of, on equivalent conductivity, 234-236
 on hardness, 231-238
 on melting point, 231-238
Crystal synthesis, 327
Crystals, molecular, 30
 molecular rotation in, 326
 mosaic structure in, 92-94
 weakened models of, 328
CsCl, occurrence of, 177-180
 structure of, 9
Cu₂Al, structure of, 127
Cu₃Sn, structure of, 127
CuZn, structure of, 127
- D
- Definite proportions**, law of, 333
 exceptions to, 156, 157, 291-293, 330-333
Diamond, structure of, 67
Diffusion of ions in solids, 251-254
Diphenyls, optical activity of, 346
Ductility, of β , γ , and ϵ phases, 134
 of brass, 134
 of metals, 94
- E
- 8-N rule**, 68
Elasticity, of cellulose fibers, 375
 of silk fibers, 384
 of synthetic fibers, 406
 of wool fibers, 385
Electrical conductivity, in β , γ , and ϵ phases, 134
 in brass, 134
 in glass, 306
 in ionic crystals, 251-254
 in metals, 84
 in solid solutions, 120
Electron affinities, 161
Electron distribution, in Cl^- , 41
 in metallic structures, 72
 in Na^+ , 41
Electron concentration, in β phases, 127
 in γ phases, 128
 in ϵ phases, 133
 influence on nature of binary systems, 208
 quantum mechanical prediction of, 140
 in saturated solid solutions, 106
Electronic structure, effect, on bond type, 203-207
 on hardness, 230-231
 on melting points, 230, 231
 on solubility, 243
 on stability, 316, 317
 of neutral atoms, 421
Elements, allotropy of, 66, 81
 classification of, 62
 structure of, 62
Elongation, of fiber, 399
 of wool fibers, 287
Epsilon phases, electronic concentration in, 133, 139
 properties of, 134, 138
 structure of, 133, 139
Equivalent conductivity, relation to bond type, 234-237
- F
- FeS**, structure of, 9
FeS₂, nature of bonds in, 195
 occurrence of, 193
 properties of, 255
 structure of, 196
Fiber orientation, X-ray analysis of, 353-358
Fibers, definition of, 349
 diffraction patterns of, 355, 378, 405
 synthesis of, 358
 formation of, 349, 416
 by drawing, 384, 397, 401, 405

- Fibers, formation of, by drying under tension, 401, 407, 409-413
 by stretching, 384, 392, 394, 401, 407
 properties of, brittleness, 374, 398, 399, 402, 403, 412
 elasticity, 375, 385, 405, 406
 elongation, 387, 399, 412
 pliability, 374, 398, 399, 402, 403, 413, 415
 reactivity, 375, 410, 412, 415
 shrinkage, 382
 swelling, 375, 393
 tensile strength, 374, 381, 384, 393, 394, 398, 400, 405, 406, 412-415
- G
- Gamma phases, electron concentration in, 128, 139
 properties of, 134
 structure of, 127-133, 139
- Gelatin, effect of formaldehyde on, 414
 molecular weight distribution in, 392
 properties of, 393
- Glasses, occurrence of, 304-306
 structure of, 302
- Graphite, structure of, 67
- Growth rings in cellulose fibers, 371
- H
- Hardness, of binary compounds, 28, 225-239, 256
 of crystals with intermediate type bonds, 29, 225-239
 of interstitial alloys, 144
 of metals, 94
 of solid solutions, 117
- Heat of formation of binary compounds, 219-222
- Heats of hydration, 240
- Hydrates, stability of, 313
 structure of, 311
- Hydrogen atom, wave mechanical picture of, 39
- Hydrogen bond, 58
- Hydrolysis, 246, 257
- Hydroxyl bond, 59
- Hume-Rothery rule, 126, 128
 possible exceptions to, 132, 140
- I
- Ilmenite, structure of, 267, 273
- Inorganic fibers, 400
- Interatomic distances, 33, 54-56
 as indication of bond type, 17, 173, 176, 344
 influence, on hardness, 226
 on melting point, 226
 in organic crystals, 340
 in radicals, 265, 282
 relation to ionization, 77-83
- Intermediate phases, 127-154
 of alkalis and alkaline earths, 146-149
 definition of, 99
 of fixed composition, 149
 interstitial, 140-146
 nature of bonds in, 137
 properties of, 134-136
 structure of, 125-149
 superlattices, 151-153
- Intermetallic compounds, 123
 definition of, 154-157
 (*See also* Intermediate phases)
- Interstitial solid solutions, 113
- Iodine, structure of, 61
- Ion-dipole bond, 321
- Ionic bond, occurrence of, 159-161
 properties of, 257
 transition to covalent bond, 165-170
- Ionic radii, 417-424
 determination of, 34-52
 effect, of coordination number on, 49
 of covalent binding on, 17
 of electronic structure on, 45-47
 of radius ratio on, 51

- Ionic radii, effect, of valency on, 50
 influence, on crystal structure, 10,
 12, 14, 265-275
 on solubility, 241
 variations in, 33
- Ionization potential, influence on
 bond information, 159
- Iron, binary alloys of, 114, 116
- Isomorphism, 25, 26, 323
- K
- KBrO₃, structure of, 267, 270
 KClO₄, structure of, 274-277
 K₂PtCl₄, structure of, 278-280
 K₂SO₄, structure of, 278-280
- L
- Lanthanide contraction, 47
- Lattice energy, as criterion of bond
 type, 170, 172
 in ionic crystals, 214-219, 255
- Layer-lattice structures, arsenic, 65
 CdCl₂, 190
 CdI₂, 21
 effect of polarization on forma-
 tion of, 21, 190
 graphite, 67
 MoS₂, 192
 occurrence of, 21, 189, 205, 209,
 290
 properties of, 231, 232
 in silicates, 289-290
- Long-chain compounds, fibering of,
 349-352
 structure of, 336
- M
- Melting points, of binary com-
 pounds, 28, 225-239, 256
 of crystals with intermediate type
 bonds, 29
 of solid solutions, 122
- Metal fibers, 397-400
- Metallic bond, 68-70
 properties of, 257
- Metallic state, 68-72
 electron gas theory of, 70
 quantum mechanical theories of,
 71
- Metals, allotropy of, 81
 color of, 96
 ductility of, 94
 electrical conductivity of, 84
 ferromagnetism of, 89
 hardness of, 94
 ionization of, 78-81
 melting points of, 85, 90, 91, 94,
 221
 superconductivity of, 88
 surface tension of, 95
 structure of, 68, 76, 77
 thermal conductivity of, 84
 thermal data for, 221
- Mica, structure of, 289, 290
- Mixed crystals, 324
- Molecular complexes, 319
- Molecular lattice, occurrence of, 30,
 205
- Molecular rotation in crystals, 326
- MoS₂, occurrence of, 192
 structure of, 192
- N
- NaCl, occurrence of, 177-180
 structure of, 9
- NaClO₃, structure of, 267-270
- Na₂SO₄, structure of, 278-280
- (NH₄)₂PtCl₆, structure of, 309, 310
- (NH₄)₂Pt(CNS)₆, structure of, 309,
 310
- NiAs, occurrence of, 182-185
 properties of, 184, 255
- Ni(H₂O)₆SnCl₆, structure of, 309,
 310
- N-N distances in organic com-
 pounds, 342
- Normal valence radii, 55, 423

O

- Octahedral radii, 56, 424
- Oils, fibering of, 352
- Olivine, structure of, 287

P

- Paramagnetic susceptibilities, as criteria of bond type, 170, 171
- Particle structure in cotton, 371
- Perovskite, structure of, 267-270
- Phenacite, structure of, 278-280
- Phosphotungstic acids, structure of, 300
- Photodissociation of molecules, as criterion of bond type, 170, 171
- Photoelectric conductivity, relation to bond type, 254
- Photosensitivity, relation to bond type, 255
- Pliability, of cellulose fibers, 374
 - of synthetic fibers, 402
 - of wire fibers, 398
- Polarization, influence on crystal structure of, 17, 18, 164
 - magnitude of, 16
 - measurement of, 165
- Polyhalides, stability of, 285
- Polymorphism, 27, 325
- Pyroxenes, structure of, 288

Q

- Qualitative analysis, scheme of, 245

R

- Radicals, bonds in, 22, 260, 261
 - BX_3 groups, plane, 268
 - pyramidal, 269
 - coordination numbers in, 23, 24, 262-265
 - $S_mO_n^{-2}$ groups, structure of, 280
- Radii, atomic (*see* Atomic radius)
 - ionic (*see* Ionic radii)
 - metallic, 417

- Radii, normal valence, 55, 423
 - octahedral, 56, 424
 - square, 57, 424
 - tetrahedral, 54, 56, 423
 - trigonal, 57, 424
 - univalent, 42, 420
 - use in radicals, 263-265
- Radius ratio, effect, on interionic distances, 51
 - on structure, of AX compounds, 12, 177, 180, 186
 - of AX_2 compounds, 14, 188, 190
 - of A_2X_3 compounds, 198
 - of radicals, 261-263
 - of silicates, 298
- rule, 14
- Ramie fibers, crystalline orientation in, 374
 - properties of, 374
- Reactivity, of cellulose fibers, 375
 - of mercerized fibers, 410
 - of protein fibers, 414, 415
 - of regenerated cellulose, 412
- Regenerated cellulose fibers, 411
- Repulsion exponents, 43
- Resonance in organic crystals, 343
- Rubber, structure of, 394

S

- Selenium, structure of, 64
- Silicates, classification of, 287-289, 294
 - strength of electrostatic bonds in, 297
- Silk fibers, properties of, 384
 - structure of, 381
- Si-O networks, 290
 - in glasses, 303-306
- SnI_4 , structure of, 30
- $S_mO_n^{-2}$ groups, structure of, 280-282
- Soaps, fibering of, 352
- Solid solutions, deviations from Vegard's law, 109
 - electrical conductivity of, 120
 - extent of, 103-113

- Solid solutions, of ionic crystals, 202**
 melting points of, 122
 primary interstitial, 113
 primary substitutional, 100
 properties of, 115
 secondary, 113
 thermal conductivity of, 122
Solubility, of binary compounds, 239-246, 256
Spinel, structure of, 278-280
Square radii, 57
Subtraction compounds, 201-203, 324, 325, 331-333
Superconductivity, 88
Superlattices, 151-154
Swelling, of cellulose fibers, 375-377
 of gelatin, 393
Synthetic resin fibers, 400-402
- T**
- Tendon, properties of, 394**
Tensile strength, of β brass, 134
 of β phases, 134
 of catgut sutures, 415
 of cotton fibers, 374
 of fibers, 416
 of γ phases, 134
 of gelatin, 393, 394
 of ionic fibers, 400
 of metals, 94
 of regenerated cellulose fibers, 412
 of silk, 384
 of synthetic resin fibers, 405, 406
 of wire, 398
 of wood, 381
Tetrahedral radii, 54, 56, 423
Thermal conductivity, of metals, 84
 of solid solutions, 122
Thermoplasticity of long-chain molecules, 412
TiO₂, rutile, occurrence of, 187
 structure of, 13
Tolerance factor, 272
- Transition elements, ionization of, 130**
Trigonal prism radii, 57, 424
- U**
- Unit cell, 6**
Univalent radii, 42, 263-265, 420
- V**
- Valence, influence of, on bond type, 207, 262**
 on coordination number, 262
 on crystal structure, 207, 262
 on hardness, 228, 229
 on melting point, 228, 229
 on solubility, 242
 quantum mechanical interpretation of, 169
Van der Waals' forces, 210, 211, 257, 346
Variable composition, compounds of, 156, 157, 291-293, 330-333
Vitreous state, structure of the, 302
- W**
- Water, of constitution, 311**
 of crystallization, 311
 zeolitic, 311
Wood fibers, crystallite orientation in, 377-380
 physical properties of, 381, 382
 rate of growth of, 372
 structure of, 362, 364
Wool fibers, properties of, 384-391
- Z**
- Zeolites, 291**
ZnO, occurrence of, 180-182
 structure of, 9
ZnS occurrence of, 180-182
 structure of, 9

PHARMACEUTICS