

Birla Central Library

PILANI (Jaipur State)

Engg College Branch

Class No :- 626.8

Book No :- I 83 I .

Accession No :- 32319

IRRIGATION PRINCIPLES AND PRACTICES



PLATE I. John A. Widtsoe, Ph.D., L.L.D., Pioneer Irrigation Scientist, Author, and Administrator.

IRRIGATION PRINCIPLES AND PRACTICES

BY

ORSON W. ISRAELSEN, PH.D.

Member, American Society of Civil Engineers

Member, American Society of Agricultural Engineers

Professor of Civil Engineering, Utah State Agricultural College

NEW YORK

JOHN WILEY & SONS, INC.

LONDON: CHAPMAN & HALL, LIMITED

COPYRIGHT, 1932
BY ORSON W. ISRAEISEN

*This book or any part thereof must not
be reproduced in any form without
the written permission of the publisher.*

FIFTH PRINTING, FEBRUARY, 1948

Printed in U. S. A.

THIS BOOK

**IS DEDICATED TO THE RESEARCH WORKERS OF AMERICA,
WHOSE ACHIEVEMENTS IN THE ADVANCEMENT OF SCIENTIFIC
KNOWLEDGE OF IRRIGATION ARE BECOMING INCREASINGLY
RECOGNIZED AS OF BASIC VALUE TOWARD THE PERPETUATION
OF A PERMANENTLY PROFITABLE SOIL PRODUCTIVITY UNDER
IRRIGATION**



PLATE II. — Date palm, Salt River Project, Arizona. (Courtesy: U. S. Bureau of Reclamation.)

PREFACE

My major objective in the preparation of this volume has been to meet the needs of college and university students who seek information concerning the aspects of irrigation which are not considered in works on irrigation engineering. These aspects of irrigation, which are sometimes referred to as the agricultural phases, are of special interest to students of agriculture and of agricultural engineering. They are also of interest to civil engineering students. Although the needs of students have been given first consideration, and irrigation principles therefore stressed, a considerable amount of material describing modern methods and practices also is included. Water commissioners, irrigation company officers, superintendents of irrigation projects, water masters, ditch riders, county agricultural agents in the western states, and intelligent irrigation farmers are all interested in the dissemination of knowledge that will make possible better irrigation practices and more efficient and economical use of irrigation water. In addition to providing for the needs of college students, I have aimed to include also material that will be of value to leaders in irrigation affairs who recognize the basic importance of proper use and control of irrigation water to the perpetuation of profitable agriculture in arid regions.

Experience in teaching a course in irrigation practice to agricultural and engineering students, and in teaching courses in the design of irrigation and drainage systems to engineering students, has convinced me that elementary equations are really of great value to agricultural as well as to engineering students. For example, I think it is much easier to establish clearly in the mind of a student who has had a beginners' course in algebra, including the use of logarithms, the influence of canal roughness, cross-section, and slope, on the velocity of water, and on the discharge of the canal, by means of the equations of Chapter II than by lengthy descriptions in sentences without the use of symbols and equations. With the possible exception of Chapters X and XV, a student who has the minimum of mathematics required for college entrance, by exerting reasonable effort, can obtain, without aid from the instructor, a clear understanding of all the equations presented and of the principles which the equations embody. It is probable that some aid from instructors in the analysis and use of the equations of Chapters X and XV will be found desirable.

Because the working of problems and the answering of questions are helpful means of obtaining a clear understanding of principles, there is included as an appendix a set of problems and questions for each of Chapters II to XVIII, inclusive, most of which consider subject matter of general application in irrigation practice, regardless of the particular crop irrigated.

Irrigation engineers, agronomists, and soil and plant scientists, are recognizing more and more the need of a study of the elements of the physical properties of soils as a basis for intelligent advancement of practices in the application of irrigation water. Uniform distribution of irrigation water and adequate (but not excessive) depth of water penetration into the soil would be much easier to obtain if it were possible for the irrigator by simple inspection to see how deeply into the soil his irrigation water penetrates, and to estimate by direct means the amount of water stored in each foot of soil. But, since these things cannot be determined by inspection, it is essential to determine them by indirect means. The equations of Chapter IX are simple practical tools which, when used in the light of available information concerning moisture percentages in typical soils before and after irrigation, enable the irrigator better to understand what becomes of the water he applies to his soils.

A study of the movement of water in soils is difficult because of the many variable factors involved. Some simplifying assumptions have been made in the treatment of the topic in Chapter X.

Efficient use of water in irrigation is being encouraged by increased knowledge concerning its consumptive use — a topic which in recent years has been of unusual interest. Much more experimental data are needed on the relations of crop yield to water consumed — a subject treated in Chapter XV. Of equal importance is the proper interpretation of available experimental data, on which Chapter XVIII presents an analytical method that is comparatively new.

There are, as yet, no generally accepted definitions of efficiency and economy in irrigation. Certain definitions are proposed which it is hoped will stimulate further interest and merit the consideration of appropriate groups of scientific workers in irrigation with a view to the formulation of definitions that may be generally adopted.

Information concerning the irrigation of standard crops, briefly summarized, will probably be of interest to readers other than college students.

In humid climates there is a growing interest in irrigation for truck crops, small fruits, and orchards. Therefore the value, extent, and possibilities of irrigation in humid climates are briefly considered.

And, finally, there are enumerated some of the problems of irrigation that must be solved in order completely and efficiently to utilize the available water supplies of arid regions.

I have endeavored to examine all available irrigation literature in the preparation of this volume. Liberal use has been made of the publications of the agricultural experiment stations and of the United States Department of Agriculture. Acknowledgment is gratefully made to the Utah and the California State Experiment Stations for the use of published experimental data and illustrations, and also for several unpublished pictures on orchard irrigation supplied by the Division of Irrigation Investigations and Practice of the University of California. A large amount of material and many illustrations have been obtained from the publications of the Bureau of Agricultural Engineering.

Following each chapter there is a brief list of references.

To students and to colleagues I am deeply indebted for aid in the preparation of this volume. I am especially grateful to Professor George D. Clyde, who has read the manuscript and offered helpful suggestions. Drs. Willard Gardner, D. S. Jennings, N. E. Edlefsen, and L. A. Richards, and Professors I. M. Winsor and F. M. Coc and Mr. Wells A. Hutchins have read parts of the manuscript and have given valuable aid.

Messrs. V. R. Bennion, L. K. Hill, and C. H. Milligan have assisted in the preparation of tables and figures, and Mr. Milligan has assisted in checking problems.

To Dr. J. Brownlee Davidson I am grateful for stressing the possibility of service in the preparation of the book.

Readers who discover errors will confer a favor by calling them to my attention.

ORSON W. ISRAELSEN

LOGAN, UTAH.
January, 1932.

CONTENTS

CHAPTER	PAGE
I. INTRODUCTION	1
Definition, extent, status, and phases of irrigation. Relations of the farmer, the community and the public to irrigation.	
II. SOURCES AND CONVEYANCE OF IRRIGATION WATER	13
Precipitation, streams, and reservoirs. Driving and retarding forces. Energy and hydraulic grade lines, velocity and discharge equations and water conveyance structures	
III. MEASUREMENT OF IRRIGATION WATER	36
Units of water measurement, orifices and weirs with equations and discharge tables, the Parshall Flume, current meters, and irrigation-stream dividers.	
IV. PUMPING WATER FOR IRRIGATION	65
Power requirements, efficiencies, pumping lifts, primitive and modern pumping methods, types of pumps, kinds and costs of fuel, and sources of water for irrigation pumping.	
V. IRRIGATION METHODS	95
Flooding, furrow, sub-irrigation and spraying methods. Time rate of application and depths of water required. Distribution of water.	
VI. FARM IRRIGATION IMPLEMENTS AND STRUCTURES	125
Implements for making borders, corrugations and deep furrows. Farm irrigation diversion and conveyance structures.	
VII. SOME PROPERTIES OF SOILS	140
Texture, structure, real and apparent specific gravity, pore space, permeability, specific water conductivity, depth, plant food compounds, and excess soluble salts of soils.	
VIII. BASIC SOIL AND WATER RELATIONS	147
Soil water, surface tension, film pressure, equilibrium conditions, and moisture constants.	
IX. STORAGE OF WATER IN SOILS	161
Water stored, soil augers and tubes, moisture contents and capacities, field studies of capillary water storage, and filling the capillary reservoir.	

CHAPTER	PAGE
X. THE MOVEMENT OF WATER IN SOILS	189
Potentials, potential gradients, equipotential regions, moisture content and capillary potential, velocity in, and discharge through soils, water transmission factors, steady capillary water flow and capillary flow in field soils.	
XI. IRRIGATION AND ALKALI	213
Climate and alkali, kinds of alkali, movement of salts in soils, water table influence, reducing evaporation, toxic limits and methods of temporary control, lowering of water table and management of alkali land. Origin and danger limits of alkali water for irrigation.	
XII. TRANSPIRATION AND EVAPORATION	226
Transpiration, transpiration ratio, and transpiration efficiency defined. Factors influencing transpiration efficiency, including available plant food, soil moisture content, nature and vigor of plant. Reducing evaporation, vegetative mulches and evapo-transpiration ratio.	
XIII. TIME OF IRRIGATION	237
Crop needs, limiting moisture conditions, appearance of crop, available water, wilting moisture percentage, growth rate above wilting, moisture needs of different soils, and seasonal use by different crops. Available water supply and fall, winter and spring irrigation.	
XIV. CONSUMPTIVE USE OF WATER IN IRRIGATION	251
Consumptive use definitions and analysis and difficulties in measuring. Consumptive use measurements in tanks and in field experimental plots.	
XV. RELATION OF CROP YIELD TO WATER CONSUMED	264
Research agencies and methods, sources of water used, deep percolation losses and review of experimental work on crop yield-water relations.	
XVI. SOCIAL AND ADMINISTRATIVE ASPECTS OF IRRIGATION	281
Individual and mutual enterprises, commercial companies, Desert Land act, Carey act, irrigation, districts and United States projects. Water laws, legislation concerning, and adjudication and acquisition of water rights. Distribution of water.	
XVII. AMOUNTS OF WATER USED IN IRRIGATION	297
The duty of water, use ratios, points of measurement and kinds of use. Biological, chemical, physical and other factors influencing use of water. Records of water used.	

CONTENTS

CHAPTER	PAGE
XVIII. EFFICIENCY AND ECONOMY IN IRRIGATION	308
Efficiency and economy in water application, conveyance and delivery. Irrigation efficiency. Economical consumptive use—analysis and illustrations.	
XIX. IRRIGATION OF CEREALS	321
Methods and time of irrigating and water requirements of wheat, oats, barley, rye, and corn.	
XX. IRRIGATION OF ALFALFA	333
Methods and time of irrigating, water requirements and root distribution of alfalfa.	
XXI. IRRIGATION OF SUGAR BEETS AND POTATOES	344
Methods and time of irrigating, and water requirements of sugar beets and potatoes.	
XXII. IRRIGATION OF ORCHARDS	355
Methods and time of irrigating and water requirements of apples, peaches, citrus, and other fruit trees.	
XXIII. IRRIGATION IN HUMID CLIMATES	379
Irrigation supplementary to and deficiencies in rainfall, humid-climate crops irrigated, experimental results, extent of irrigation, water supplies and amounts needed.	
XXIV. THE PROBLEMS OF IRRIGATION	389
Classes of irrigated land, including lands fully irrigated, lands partially irrigated, and lands not yet irrigated. Water supplies and exchanges. Irrigation and hydroelectric power, city water supplies and coordinated uses of water. The unfinished task.	
PROBLEMS AND QUESTIONS	399
INDEX	411

PARTIAL LIST OF SYMBOLS USED

- A** area of land in acres covered with water at any time, t , while irrigating a border strip
- A_s** apparent specific gravity of soil
- a** cross-section area of stream of water, in square feet; also, area of land irrigated in acres; also, price per ton of the crop on the farm
- b** bottom width of a canal, in feet; also, cost per acre annually of rental, tillage operations, etc.
- C** coefficient of discharge or a constant (differences in usage are indicated by use of the prime, that is, C' C'' , etc.)
- c** annual cost of water per acre-foot
- D** depth of soil moistened, inches or feet; also, mean depth of water in feet
- D_f** deep percolation losses from the farm
- d** depth of water applied, inches or feet; also, diameter of a water film in the soil
- E_a** water application efficiency
- E_c** water conveyance efficiency
- E_i** irrigation efficiency
- E_t** transpiration efficiency in per cent
- E_u** consumptive use efficiency
- e** evaporation from water surface
- F** driving force per unit mass
- F_g** driving force per unit mass due to gravity
- F_f** friction or retarding force per unit mass
- F_p** driving force on unit mass, due to pressure differences
- g** acceleration due to gravity or force of gravity per unit mass; also, amount of water absorbed from gravitational ground water
- H** head in feet above the crest of a weir; also, depth of any point vertically below the water surface
- HP** brake horse power
- HP_w** water horse power
- H_f** total quantity of water supplied the farm
- h** vertical lift of water, in feet; also, drop in elevation of water surface due to flow through a submerged orifice, measured in feet; also, distance from water surface to middle of orifice opening; also, height of water column in a capillary tube or in an unsaturated soil column
- h_c** fall of water surface in a canal in distance l
- h_0** difference in head, i.e. ($h_2 - h_1$), due to pressure differences
- h_s** head due to elevation
- h_p** head due to pressure
- h_f** drop in hydraulic grade line or loss of head in friction due to flow a distance l
- i** net income per ton
- K** a constant
- KWH** kilowatt hours
- k** specific water conductivity

- k_s transmission constant; also, hydraulic permeability; also, coefficient of permeability
 L effective length of weir crest in feet
 L' measured length of weir crest in feet
 l length of path of flow of water
 M number of months; also, mass of a body
 m mean seasonal moisture content; also, the amount of water absorbed from stored capillary water
 N the total number of acre-feet of water annually available
 n roughness coefficient or "retardation factor"
 P_w moisture percentage on the *dry weight basis*
 P_v moisture percentage on the *volume basis*
 P the total profits for an entire area, in dollars
 p rate at which water percolates into the soil; also, intensity of water pressure; also, pressure of a film
 p' pressure difference, i.e., $p_2 - p_1$
 q stream flow or discharge, in cubic feet per second, c.f.s.
 Q_h quantity of available heat in day-degrees, during crop year
 R time rate of water application in cubic feet per second per acre
 R_s real specific gravity of soil
 R_f surface run-off from the farm
 r hydraulic radius, i.e., ratio of water cross-section area to wetted perimeter; also, the crop season rainfall; also, radius of a sphere, or of a capillary tube or of a water film in the soil
 r_1 major radius of an ellipsoid
 r_2 minor radius of an ellipsoid
 S percentage pore space in soil
 s slope of water surface; also, the hydraulic slope
 T surface tension; also, weight of water transpired; also, the general physical dimension, time
 t time in hours that water runs on a strip of land; also, time required to irrigate a given area
 U consumptive use of water annually
 U_f farm consumptive use annually
 v velocity of water in feet per second
 W_f water delivered to a farm
 W_s water stored in the farm soil
 W_t water transpired by a crop
 W weight or force of gravity
 $\sum W_f$ sum of the amounts of water delivered to the farms under a canal
 w weight of a cubic foot of water; also, net seasonal amount of irrigation water
 y yield of crop annually; also, average depth of water in inches as it flows over the land
 y_d the weight of dry matter plant yield
 ρ density, i.e., mass per unit volume
 θ angle side of canal makes with the horizontal

NOTE: Each of these symbols is also defined where it is first used in an equation. This list is presented for convenience of reference.

IRRIGATION PRINCIPLES AND PRACTICES

CHAPTER I

INTRODUCTION

Irrigation is an age-old art. Civilizations have risen on irrigated lands; they have also decayed and disintegrated in irrigated regions. In the United States and Canada, irrigation is yet in its youth. Most men who are well informed concerning irrigation are certain of its perpetuity, so long as it is intelligently practiced. Others insist that a civilization based on agriculture under irrigation is destined sooner or later to decline, because some ancient civilizations based on irrigation have declined. The perpetuity of civilized peoples is probably dependent on many factors, of which a permanently profitable agriculture is vitally important. Some of the principles and practices essential to permanently profitable agriculture under irrigation are considered in this volume.

1. Irrigation Defined. — Irrigation is defined as the artificial application of water to soil for the purpose of supplying the water essential to plant growth. Water may be applied by flooding in different ways; or in furrows large or small; or by applying water underneath the land surface by sub-irrigation and thus causing the ground water to rise; or by sprinkling the land surface — all these methods of applying water to soil are forms of irrigation. In some regions, usually classed as humid, crops are grown satisfactorily every year without irrigation, the necessary soil moisture being supplied by rainfall. In other regions, the rains during some years supply all the water needed by crops, but during other years, only part of the necessary water. In years of low rainfall it is economically advantageous in these regions to supply supplemental water by irrigation, the value of the increase in crop yields thus obtained being greater than the cost of irrigation. In regions of very low annual rainfall, and in those where little or no rain falls during the crop-growing season, even though the total annual rainfall is fairly high, irrigation is essential every year in order to produce crops. However, in nearly all areas where irrigation is practiced, crops get some water from the rains, either as moisture stored in the soil from the time of the rainy period to

the period of crop growth, or as moisture added to the soil directly by the crop-season rains. Thus it is apparent that irrigation is essentially a practice of supplementing the natural precipitation for the production of crops.

2. Extent of Irrigation. — It is estimated that one-third of the earth's surface receives less than 10 inches of water annually, and that an additional third receives only 10 to 20 inches. The United States Bureau of Commerce has recently given the geographical distribution of regions of deficient rainfall roughly as follows: The southwestern parts of Africa, South America, and Australia; the northern part of Africa; the northern and western parts of North America and Asia; and parts of southern Europe. These areas include parts of Canada west of the one-hundredth meridian; northwestern India up to the Ganges; the greater portion of Australia; Palestine and Iraq; considerable portions of South Africa and adjacent areas; and the Sudan. There are also large semi-arid areas in China, Japan, Turkestan, Egypt, the western United States, Mexico, and countries in South America. A summary of the extent of irrigation in the world is given by the Bureau of Commerce as follows:

CONTINENT	MILLIONS OF ACRES IRRIGATED
North America	26.8
South America	6.6
Europe	14.8
Asia	140.8
Africa	10.3
Oceania	1.2
<i>Total</i>	<u>200.5</u>

It thus appears that there are approximately 200 million acres of irrigated land in the world, of which Asia has nearly three-fourths and North America slightly more than one-eighth.

The major part of the irrigated land in North America is in the western United States — approximately 20 million acres. The approximate location of this irrigated land is shown in Fig. 1. As indicated in Chapter XXIII, there is now some irrigation in the eastern United States, although, because the irrigated areas are relatively small, they are not shown on the map. In some parts of the eastern United States the natural rainfall usually supplies enough water to meet all the needs of growing crops. Parts of the West, such as central and southern California, depend almost wholly on irrigation because the rainfall during the crop-growing season is insufficient in amount.

3. Nature of Irrigation Agriculture. — Irrigation farming is essentially cooperative with respect to crop production — it is optionally

cooperative with respect to harvesting and marketing. The pioneer development of modern irrigation in America by the "Mormon" col-

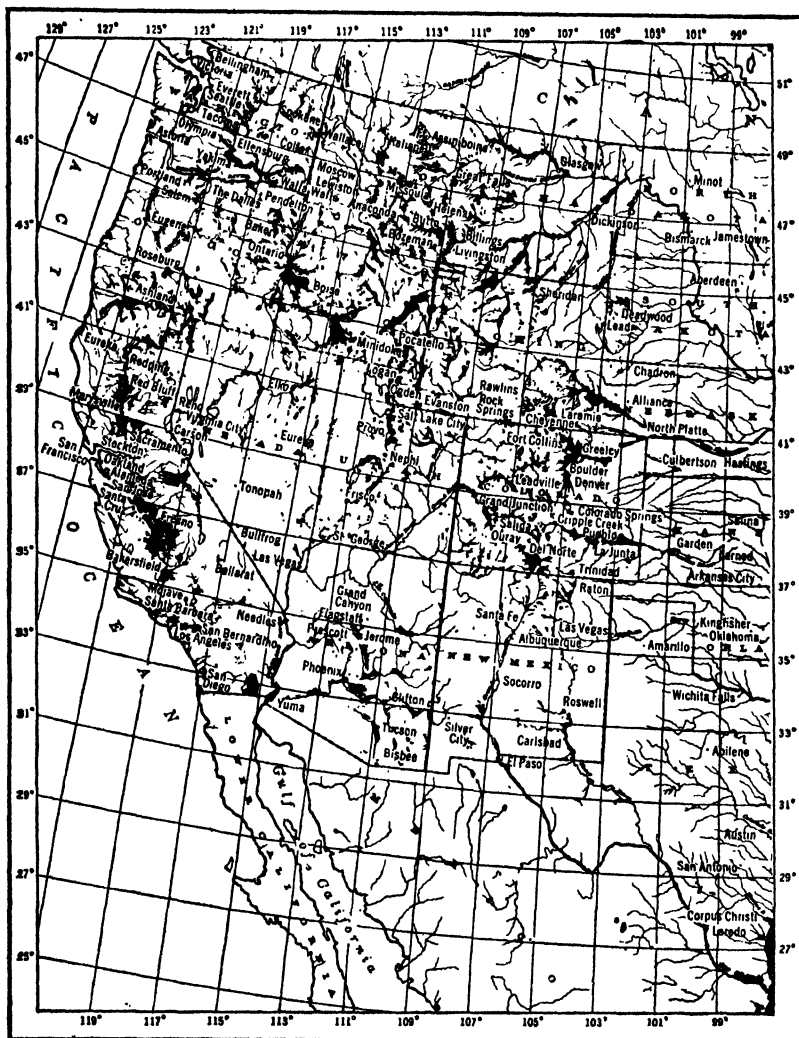

FIG. 1. — Map of the western United States showing approximate location and extent of irrigated areas. (U. S. Bureau of the Census.)

onies was distinctly cooperative, even though, in many Utah localities, only small groups of men were required to divert and use all the water of a given stream. Likewise, the pioneer efforts in Colorado and

California were essentially cooperative. During pioneer days small diversion weirs and short canals were the rule — today great dams, large reservoirs, diversion weirs, headgates, powerful pumps, and long canals with flumes, siphons, tunnels, drops, chutes, wasteways, spillways, and take-out gates are required to supply water to the modern irrigation area. Although these requirements are essentially engineering, a phase of irrigation with which this volume deals only in a limited way, they are of importance to the irrigation farmers who must so use the water made available by these expensive works as to produce the revenue with which to pay their cost and maintenance.

American irrigation is as yet in the period of youth — merely approaching maturity. In the beginning, cooperation of small groups of men was urgently essential to accomplish the tasks of the pioneer in desert regions; the building of dams and canals with crude implements and man power, supplemented sometimes by oxen and horses, demanded the loyal cooperation of leaders and followers in each community. Today, cooperative effort is even more important than during the pioneer times, although it is of a somewhat different nature. Massive storage dams are now being built, as well as long diversion canals and other irrigation structures above enumerated. These structures, together with power plants on irrigation systems, command the cooperative effort of large groups of people guided by skilled engineers, and industrial and agricultural leaders.

4. Present Status of Irrigation in the United States. — The task of utilizing all the arid-region lands of the United States that may ultimately be irrigated is only about half accomplished. Probably 50 per cent of the ultimate irrigable area yet remains non-productive because of lack of water. The capital investment necessary to reclaim the remaining half will far exceed relatively the investment that has been made to supply water for the area now irrigated. The largest reservoirs, the longest canals, the most expensive tunnels, and the deepest inverted siphons, are yet to be built. Clearly, the time when these monumental structures will be built, for the final control of the water supply of the West for irrigation, cannot be precisely predicted. The essential fact is that, so long as the population of our country is materially increased each decade, the demand for further utilization of water for irrigation will also increase. The rate of population increase in the western states is especially significant. During the decade 1920 to 1930 the population of the seven states on the Pacific slope increased from less than 7 million to more than 9.5 million; an increase of approximately 41 per cent, as compared to a population increase of 16 per cent for the country as a whole.

5. The Phases of Irrigation. — Many and varied are the irrigation questions which confront the people of the arid regions of the world. For decades and even centuries, strong men in different countries have struggled with the problems of water diversion, conveyance, distribution, and use for food production. Arid-region peoples by means of irrigation must overcome sterility or low productivity due to dryness — then after irrigation water is provided and used for a few years some soils again become sterile because of excess irrigation, water-logging, and alkali concentrations.

Irrigation is often viewed from three aspects or phases, namely, engineering, agricultural, and economic and social. There are no impenetrable barriers between these phases of irrigation; rather, the problems in one phase are to a very great extent dependent on those of another. The major responsibilities of those who work in each phase of irrigation are enumerated in the following sections.

6. Engineering Phases. — The engineer has the responsibility of designing and building the structures essential to the storage, diversion, conveyance, delivery, and distribution of water to irrigators. It is clearly important that irrigation structures be substantially built so that they may be safely relied on during critical periods. The failure of a large storage dam not only causes the loss of large property investments, but sometimes results also in the loss of the lives of many people. The washing out of a diversion dam, or the breaking of a canal, causes not only the loss of a year's crop, owing to failure to obtain water when most needed, but also loss of the money invested in such works. Modern irrigation further demands that the engineer build structures economically. Some projects are so situated that large quantities of water must be pumped from rivers, lakes, or reservoirs, in order to reach the land. The design and installation of suitable pumping machinery also are the responsibilities of the engineer. The many outstanding irrigation structures in the West affirm silently but convincingly the skillful achievements of American engineers.

A less conspicuous but equally perplexing responsibility confronting the irrigation engineers is the determination of the water needs of, and the water supplies for, large areas of irrigated land. Irrigated lands vary widely in their water needs; the water supply likewise varies greatly. Reliable predictions of the approximate water yield of a river system from month to month and year to year are based only on painstaking measurements of rainfall, snowfall, and stream discharges for many years. Many "rough estimates" were of necessity made in the earlier years of irrigation. Unfortunately, the estimates of water supply frequently have been too high and estimates of the water needs

too low, with disastrous results to many irrigation projects. The engineer has made remarkable progress in his ability to cope with these and related irrigation problems, but the opportunities for advancement are yet very great; for the best results, he must work in close cooperation with the soil and plant scientists.

7. Agricultural Phases. — The agricultural phases of irrigation are essentially concerned with the use of irrigation water on the farm or with irrigation practices. Naturally, therefore, there are many more people who are directly concerned with the agricultural than with the engineering phases. Indeed, every irrigation farmer must decide important questions concerning his irrigation practice, and some of these questions have to be decided each year — they cannot be decided once for all time. For example, there are no specific rules applicable to all arid-region climates, to all soils, and for all crops as to when irrigation water should be applied to the soil. Likewise, the seasonal amount of irrigation water required to produce crops most economically under different climatic and soil conditions is a question that perplexes many irrigation farmers.

Other agricultural aspects of irrigation are the determination of the proper quantity of water to apply to the soil in single irrigations, the best methods of application in order to distribute the water as nearly uniformly as possible, the capacities of different soils for irrigation water, and the movement of water in the various irrigated soils.

It is axiomatic among persons best informed concerning the agricultural aspects of irrigation that in order to make the most efficient use of irrigation water the methods and practices employed must be based on the conditions provided by nature in the locality concerned. These natural conditions are largely the conditions of climate and of soils. Clearly the crops grown are selected to some extent according to the climatic conditions under which the farmer works. The agricultural engineer has both the opportunity and the responsibility of finding the necessary facts with which to aid the irrigator to answer correctly the many perplexing questions in the agricultural aspects of irrigation.

8. Climate and Irrigation. — The snow and the rains, the winds, the humidity of the air, the temperature, the sunshine, the length of growing season — all these climatic factors influence irrigation practice. In some localities, such as parts of Arizona, California, New Mexico, and western Texas, irrigation is practiced from 10 to 12 months of every year, and is essential to satisfactory crop production. In other places, like parts of Montana and of western Canada, the rainfall during some years is so abundant that irrigation is of doubtful value, if not really harmful. It should therefore be clearly kept in mind that *irrigation*

is fundamentally a practice of supplementing that part of the natural precipitation which is available for crop production. Remembering this, it is evident that the amount of water used in irrigation practice varies from place to place and from time to time as the natural precipitation available to crops varies. There are a few arid valleys in which the natural precipitation is so small that it is of negligible value in crop growth, but as a general rule the moisture made available by nature should be carefully conserved for the use of plants. Moreover, it should also be considered in estimating the irrigation needs of soils and crops.

9. Soils and Irrigation. — The influences of soil properties on irrigation practice are of very great importance. It is probably conservative to say that as a rule the importance of soil influences on irrigation practice is much under-estimated. Some soils consist of coarse particles loosely compacted, and these are highly permeable to water. Others consist of fine particles tightly compacted, and these are almost impermeable to water. Recent research shows that some soils transmit water several thousand times faster than other soils. The permeability of a soil greatly influences irrigation practice. Highly permeable soils tend to cause excessive water losses through deep percolation, whereas impermeable soils are difficult to moisten adequately. Soils also act as storage reservoirs in which irrigation water is held between the periods of irrigation for the use of plants. The size of soil particles, their compactness, the depth of the soil, the organic matter it contains, and the position of the ground water — all these influence the amount of water that the irrigator can store in his soil in a single irrigation and hence influence the required frequency of irrigation. The depth of the soil also influences greatly its capacity as a storage reservoir for water and the necessary frequency of irrigation. And it should always be remembered that *variation* in size of soil particles, in compactness, in permeability, and in depth from place to place is the rule, not the exception. In fact, there is no such thing as uniformity in *natural* soils. Consequently, the irrigation farmer finds it very essential to study his soil carefully in order to be able to make his irrigation practices conform most nearly to the conditions of the soil on which he desires to produce crops profitably.

Arid-region soils vary not only in physical properties, which directly influence methods of irrigation and water requirements, but also in chemical properties, i.e., in the *presence* of adequate amounts of available plant food substances, and the *absence* of excessive amounts of toxic or harmful soluble salts. As a rule, the irrigation farmer whose good fortune it is to be located on highly productive soils provided with an adequate amount of irrigation water is successful in making a living and

meeting his irrigation expenses; on the contrary, the farmer whose ill fortune it is to be located on poorly productive soils is frequently unable to make a good living and also meet his expenses. In some cases, the productivity of the soil is decreased from year to year because of the gradual rise of the ground water and the accumulation of alkali salts, so that some farmers who were successful in the early years of irrigation find difficulty in meeting their obligations during the later years because of declining productivity of the soil.

The conditions of soil productivity above described are peculiar to irrigated regions. Clearly, however, the irrigation farmer, like the humid-climate farmer, must intelligently consider the problems of maintenance of soil productivity even with the best arid-region soils, in order to assure a permanently profitable agriculture. Detailed consideration of the methods of maintaining soil fertility is beyond the scope and the purpose of this volume. Suffice it here to say that the experiences of farmers in the older irrigated sections of the western United States seem to have established the fact that, in order to maintain a high productive capacity of soils, intelligent soil management and application of barnyard manure or the plowing under of green manure crops, or use of other fertilizers is really essential.

10. The Irrigation Farmer.—The difficulties and the failures in farming on new irrigation projects have been much heralded in recent years, and the irrigation farmer seems to have had more than his share of discredit for the failures that have occurred. Undoubtedly, a strong vigorous man who has been reared on an irrigated farm and had experiences in irrigation farming, when aided and inspired by a devoted, intelligent, industrious, rural-minded wife, will succeed under conditions that will cause the failure of a man inexperienced in irrigation farming who is also discouraged and weakened by a discontented city-minded wife unaccustomed to the privations of pioneer life. Between these two extremes there are, of course, a great variety in the capacities, the experience, the determination, the vision, the industry, and the courage of irrigation farmers and their wives. The financial difficulties that have developed on some of the newer American irrigation projects since the World War, including the federal projects, have adequately demonstrated the need of reasonable selection of the irrigation farmer in the settlement of new irrigation projects in order to guard against unfortunate misfits on the land, preventable financial failures, and pathetic family disappointments sometimes followed by permanent weakening or wrecking of individuals.

However, the student of irrigation should keep continuously in mind the fact that on the older irrigation projects of the West, and of other

countries, average men and women are maintaining permanent homes and rearing families successfully. As in humid-climate farming, and indeed in other phases of American industrial life, the man of high native capacity, great vision, and untiring energy, ultimately acquires a position of leadership and financial security, whereas the man who is seriously lacking in these characteristics ultimately reaches a place of servitude if not one of actual financial dependence. In writing the "specifications for the irrigation farmer," who will succeed on the new American irrigation project, there has been a tendency to specify only the type of man who will succeed in spite of adverse conditions on the farm, and who can, if necessary, leave the farm and acquire success in the competition of industrial city life. This tendency is probably justified, in part at least, by the importance of guarding against the failure of individuals on new irrigation enterprises, because the project success rests so largely on the success of every unit in the entire enterprise.

11. The Irrigation Community. — As used herein, the irrigation community is defined as the group of families which obtain irrigation water by means of dams, canals, ditches, etc., owned and operated by the group, or by any other single enterprise, public or private, incorporated or unincorporated. To illustrate, it is assumed that a 60,000-acre irrigation project is occupied by an irrigation community of 1000 families, each operating a farm of 60 acres. If only one family fails each year and moves away, the community will probably have little difficulty in finding another family to occupy the vacated farm. Furthermore, the prompt payment of irrigation assessments by 999 families will provide ample funds with which to pay all regular irrigation costs, as well as special assessments made necessary by the occurrence of unusual conditions. However, if 100 families fail and move away, the replacements will be more difficult and costly; and the irrigation revenues from 90 per cent of the people may be inadequate to meet all the irrigation expenses. As a matter of fact, many American irrigation communities struggle for years in the early development of their projects with only one-half or less of the total arable project land for which water is available actually producing crops. Many perplexing factors contribute to these delays in settlement of all the project lands. It is of the utmost importance that leaders in irrigation expansion and the formation of new irrigation enterprises keep clearly in mind that ultimate payment of irrigation costs must be made by the irrigation community, and that the final source of revenue is the increased production of the land by means of actual irrigation. If a substantial number of the original members of an irrigation community are by temperament, experience, and lack of capital, unprepared for irrigation farming, and hence soon leave the project, or if a

significant percentage of the land is of low productivity, or if the water supply is materially insufficient, the irrigation community is sure to work at a low efficiency. In such cases, financial difficulties and ultimate financial collapse are almost inevitable. The subject of irrigation economics is large and complex; many factors of national and international scope are involved.

Two elements are common to colonization problems on nearly all irrigation projects: these are the basic facts that irrigation is distinctly a community enterprise, and that an adequate number of irrigation farmers on each project, each working under reasonably favorable conditions, is fundamentally essential to the financial success of any project.

12. Social Phases of Irrigation. — A satisfying social situation is essential to the success of any community enterprise. Men and women work most efficiently when encouraged, stimulated, and inspired by the ideals, the growth, and the advancement of the family, the school, and the church. Other community institutions, such as the farm bureau, the public library, and wholesome public amusements, contribute greatly to the contentment and thus to the efficiency of the irrigation community. It is of course apparent that family, school, and church progress are dependent, in part, on the financial status of the members of the community. But financial strength alone, though essential to a satisfactory social situation, is insufficient to assure its attainment. In addition there must be provided competent social leadership. In the schools of the irrigation communities there should be intelligent teachers who are inspired by the beauties of rural life, who understand the necessity of the perpetuation of the ideals of government in a democracy, and who inspire children and parents to the attainment of the best in cooperative effort. In the churches there must be leaders who are interested in the common problems of the community, who inspire men to bury bigotry and conceit, and who impress their associates with the beauty and the satisfaction that comes to humanity by cultivating faith and tolerance. The proper kind of leadership in the schools and the churches of irrigation communities attracts and holds men and women whose major objective is to build homes and rear strong families under rural conditions. And the men and women who are guided by the objective of building homes usually contribute largely to the satisfying social conditions which are so essential to the success of irrigation communities.

13. Public Interests in Irrigation. — The American public, for nearly three-quarters of a century, has shown a definite interest in irrigation progress. In varying degree, all the western states have enacted laws

providing for the orderly acquirement of irrigation water rights and for the distributio. of public waters to those who have acquired rights to their use in irrigation. The states also have enacted laws governing the creation and the activities of irrigation corporations, both private and public. Many of the states consider irrigation a definite public benefit and have encouraged its advancement by exempting irrigation works from taxation.

The Federal Congress, in 1866, recognized the value of irrigation by enacting a law for the protection of water rights which had become vested through actual use of water in irrigation. In 1877 it encouraged irrigation expansion by providing for the granting of individual ownership to certain public lands provided necessary improvements were made, and a certain portion of the land of each entry was actually cultivated. In 1894 the Federal Government enacted a law for the transfer, to each of the western states, of one million acres or more; provided the state would make satisfactory arrangements with private enterprise to construct irrigation works and supply water to be used by bona-fide land settlers. And finally, through the outstanding federal reclamation legislation of 1902, the Congress provided definitely for the use of public non-interest-bearing funds to construct irrigation works and supply water to settlers. The above very brief statements concerning public legislation for the encouragement of irrigation are here made to stress at the outset the fact that irrigation is basically a public activity, and that convincing recognition of this fact has been made by both the state and federal legislatures. American legislation concerning irrigation is more fully considered in Chapter XVI. The wisdom of public participation in irrigation expansion has been much debated in recent years, with special reference to the subsidizing of the construction of irrigation works by lending money without interest to irrigation projects. It is doubtless true that great care should be exercised to avoid extended irrigation development in advance of national or state needs; it is also true that with a rapidly increasing national population there will ultimately be an urgent need for using all the nation's agricultural resources. It is noteworthy that the complete utilization of all the available water supply in the western states for irrigation purposes will make possible a larger utilization of vast timber, mining, grazing, power, and other natural resources now only partly and inadequately used.

Finally, the public interest in irrigation is by no means restricted to legislation concerning water rights, to lending encouragement to private capital in irrigation expansion, and to public financing of the construction of irrigation works. Of even greater importance to the efficient and economical use of arid-region water supplies in irrigation practice

is the public interest in the study of the problems of irrigation practice. For more than one-third of a century the Federal Department of Agriculture has devoted serious attention to the study of the agricultural aspects of irrigation. Likewise, many of the state agricultural experiment stations have contributed very largely to the accumulation of a large body of information concerning irrigation practice. Public interest in the agricultural phases of irrigation is likely to become even greater as the years advance and the need for more efficient use of irrigation water increases.

This volume concerns largely the progress thus far made in the clarification of principles on which to build a permanently profitable agriculture under irrigation and the improvement of irrigation practices. This progress is probably due largely to the achievements of public irrigation research agencies.

REFERENCES

- BAKER, DONALD M., and CONKLING, HAROLD. Water Supply and Utilization, John Wiley & Sons, New York. 1930.
- ETCHEVERRY, B. A. Irrigation Practice and Engineering, Vol. 1, Use of Irrigation Water, McGraw-Hill Book Co., New York. 1915.
- FORTIER, SAMUEL. Use of Water in Irrigation, McGraw-Hill Book Co., New York. 1926.
- MEAD, ELWOOD. Irrigation Institutions, The Macmillan Co., New York. 1903.
- MEAD, ELWOOD. Helping Men Own Farms, The Macmillan Co., New York. 1920.
- TEELE, R. P. The Economics of Land Reclamation, A. W. Shaw Co., Chicago. 1927.
- THOMAS, GEORGE. The Development of Institutions under Irrigation, The Macmillan Co., New York. 1920.
- WIDTSON, JOHN A. Principles of Irrigation Practice, The Macmillan Co., New York. 1915.
- WIDTSON, JOHN A. Success on Irrigation Projects, John Wiley & Sons, New York. 1928.

CHAPTER II

SOURCES AND CONVEYANCE OF IRRIGATION WATER

Rain and snow constitute the primary sources of water for irrigation purposes. As a rule, the precipitation which falls on the valley lands in irrigated regions is of little consequence as a source of water for irrigation; that which falls on the mountain areas is the chief source of supply. The success of every irrigation project rests largely on the adequacy and dependability of its water supply. In irrigated regions it is therefore of the utmost importance that public agencies make continuous long-time records of precipitation and stream flow as a basis for intelligent and complete utilization of the water resources.

14. Precipitation and Temperature. — Moisture and heat are essential to the growth of all crops, yet, as a rule, in irrigated regions these two essentials are provided by nature at different time periods. In general, the larger precipitation occurs during cold non-crop-growing months and smaller precipitation occurs in the frost-free months during which crop growth occurs. In some irrigated valleys, notably in Nevada and California, the precipitation during the season of most rapid growth is so small that it is of no value to the crops. The fact that the precipitation is low during the months of highest mean temperatures is illustrated in Fig. 2, which reports average precipitation together with average, low, mean, and high temperatures for each month at certain towns in Utah, Oregon, Nevada, and California.

15. Annual Precipitation. — Regions which annually receive large amounts of precipitation are known as humid; those which get each year only small amounts are considered semi-arid or arid. The annual precipitation on the surface of the earth varies widely — from zero inches in desert regions such as Aswan, Egypt, to 600 inches or more at Assam, India. Where the annual precipitation is 30 inches or more, irrigation may not be essential to the economical growth of crops. However, in some localities, such as parts of the Hawaiian Islands, irrigation is profitable in spite of the fact that these regions have large annual rainfall, because the heavy rains come during the non-growing season. In other areas, such as the eastern United States, periods of drought during the growing season sometimes cause serious decreases in crop yield, and provision for irrigation during such periods is becoming increasingly profitable.

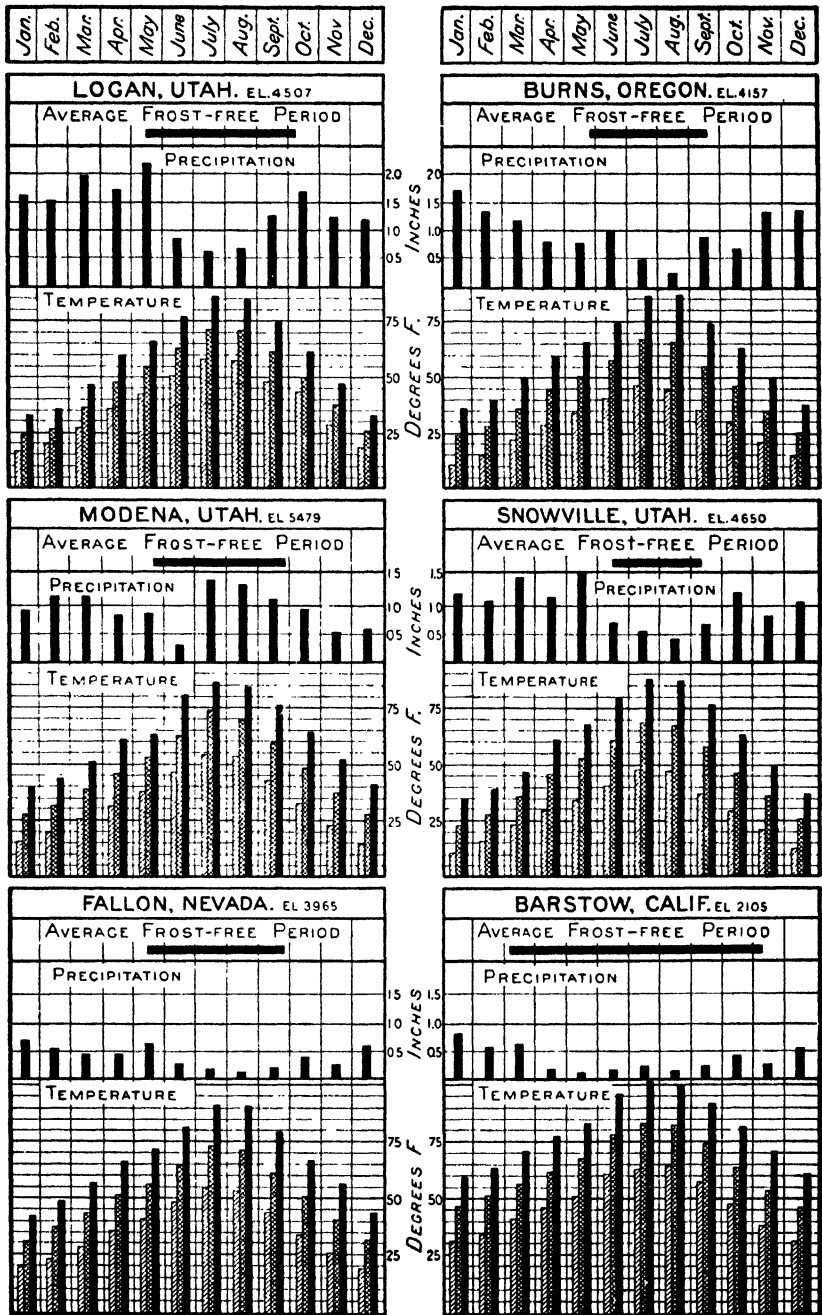

FIG. 2. — Condensed climatology of typical stations, showing average frost-free period; mean monthly precipitation; and mean minimum (lightly shaded bars), mean (double shaded bars), and maximum (solid bars) temperatures. (14)

The average annual precipitation in the United States is shown in the map of Fig. 3, prepared by Henry Gannett from data collected by the United States Geological Survey and the United States Weather Bureau. The map shows that in going east from meridian 101 the average annual rainfall increases from approximately 20 inches to 35 inches near the Great Lake states and up to 50 inches or more in the southeastern states. In the eastern parts of the Dakotas, Nebraska, Kansas, Oklahoma, and Texas, irrigation is essential only during the dry years, whereas in the western parts of these states it is nearly always advantageous. It is evident from the map that great variability exists in the mean annual precipitation of the western states. However, all the arable lands lying west of the 101 meridian, excepting parts of western Montana, Oregon, and Washington, are usually benefited by irrigation. The high annual precipitation in limited areas of northern California makes irrigation of marginal value.

16. Valley and Mountain Precipitation. — The rain and snow which fall in the irrigated valleys of the West are valuable as sources of moisture to be stored directly in the soil. In some valleys the winter precipitation stores enough moisture to germinate the seeds and maintain the growth of the young plants for several weeks. In these valleys, perennial crops also make substantial growth in the early season by using winter precipitation which has been stored in the soil. Other western valleys receive so little winter precipitation that farmers must irrigate the soil before seeding their crops in order to insure a sufficient amount of moisture to germinate the seeds and start satisfactory growth. Clearly, such valleys must depend almost wholly on the rain and snow that fall in adjacent mountain areas as a source of their supply of water for irrigation. Indeed, as a rule, in nearly all irrigated regions, the valley precipitation as a direct source of irrigation water is relatively unimportant, whereas the precipitation in the mountain areas constitutes the major source of water supply. This condition quite naturally presents to the people of arid regions very interesting and yet perplexing problems in the conveyance of water from the mountainous sources to the valley lands. It has also given rise to an urgent need for painstaking study of the seasonal and annual water yield of each mountainous area on which the rains and snows fall. The vital problems which demand intelligent solution as a basis for complete and economical utilization of nearly all western natural resources are inseparably connected with the water yield of a watershed, its conveyance to places of use, and its economical use, whether for power, irrigation, or domestic purposes. The purpose of this volume is primarily to further information essential to the economical use of water in irrigation. However, there is urgent need

for a stimulation of the public interest with a view to encouraging a wider recognition of the fact that intelligent solution of watershed-yield problems and of economical conveyance of water will appreciably advance the general welfare.

17. Water-Supply Studies. — The accumulation of dependable information concerning water supply demands not only intelligent and painstaking endeavor, but also continuous effort. Of the several major factors which have contributed to years of financial stress and ultimate financial failure of many irrigation projects, it is probable that inadequate water supply has played the greatest havoc. Over-optimism, and conclusions based on insufficient knowledge of watershed yield, have been common and expensive follies among many leading western citizens in both private and public places. Over-estimates of water supply for various projects are frequently reflected in the small areas of land actually irrigated in 20 to 30 years after the projects were initiated and after their original areas were decided. Naturally, these over-estimates have been made largely during cycles of "wet" years and have been followed by disastrous results during cycles of "dry" years. The occurrence of these climatic cycles, which cannot as yet be predicted with precision, together with the wide variations of precipitation and stream flow from one time of year to another, complicates the problem of economically using all the available water every year. Yet arid-region communities may intelligently adjust their irrigation practices, to some extent, on the basis of reliable information concerning water supplies, based on the measurement of water content of snow covers such as illustrated in Fig. 4. To outline the nature of, and procedure in, the necessary water-supply investigations is beyond the scope of this volume. It is urgent, however, that the public officials be advised as to the vital importance of the problem, and that public funds be made available in sufficient amounts to prosecute thorough investigations on every stream system concerning the watershed yield and the supply of water for further irrigation expansion.

18. Natural Streams. — During the early development of modern irrigation in America, natural stream flow supplied all the water that was needed for irrigation. The discharge of most natural streams decreases greatly during the late summer months when the largest supply of water is needed for irrigation. This fact is illustrated by Fig. 5 which gives the monthly discharge of three typical rivers in the Great Basin. The mean monthly discharge of the Logan River (Utah) for August is only 12,000 acre-feet as compared to 48,000 acre-feet in June. Basing his calculations on a 34-year period, Professor George D. Clyde has recently found that the average annual discharge of the Logan River is 228,000



(a) A potential water supply.



(b) An ideal location for snow courses.

FIG. 4. — Scenes in the study of irrigation water supplies by measurements of mountain snow covers. (Utah Agr. Exp. Sta. Circular 91.)

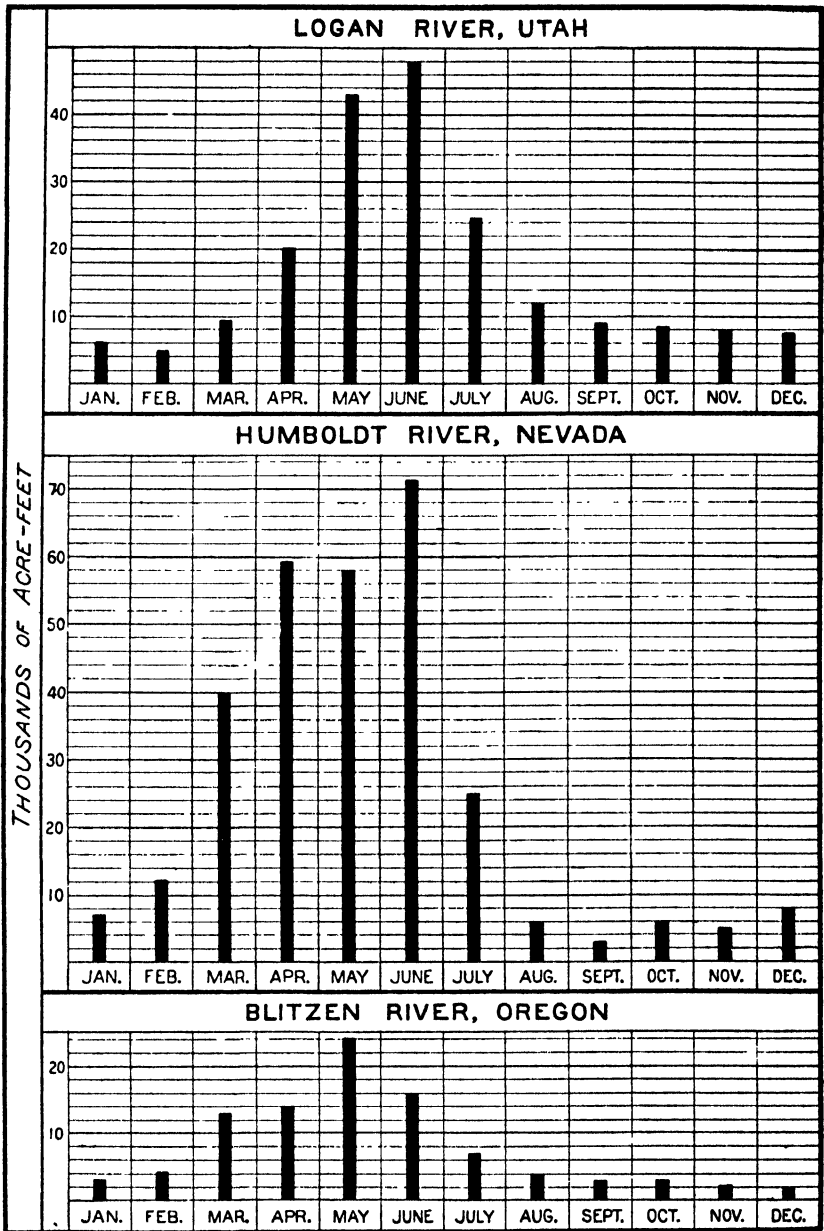

FIG. 5. — Mean monthly flow of typical rivers of the Great Basin. (U. S. Dept. Agr. Bul. 1340.)

acre-feet. It is therefore evident that, in order to use all the water of western streams for irrigation purposes, the flood waters must be held in storage reservoirs until needed on the land for irrigation.

19. Surface Reservoirs. — Many surface reservoirs have already been built in the West. The capacity of each reservoir is fixed by the natural conditions of the canyon or valley in which the water is stored, together with a height of dam sufficient to store the quantity of water needed and economically available. These capacities vary from a few acre-feet on tributaries of small streams to nearly 2 million acre-feet for one of the United States Government's new reservoirs. Likewise, the dams constructed for irrigation purposes vary from a few feet in height, built at a low cost, to massive masonry structures over 300 feet high and built at a cost of several millions of dollars. It is estimated that fully one-half of the total annual water supply of the West is yet to be used for irrigation. Of the one-half of the water supply now used, probably more than 25 million acre-feet is obtained directly from storage reservoirs. Ultimately, when the total annual water supply of the West is applied to some 40 million acres of irrigated land, probably two-thirds or more of the supply will each year be obtained directly from storage reservoirs. Provision of the necessary additional water-storage capacity will necessitate the construction of higher and more expensive dams than have thus far been built. The time at which these structures will be needed is dependent largely on the rate of increase in the national population and the increase in demand for food products.

20. Underground Reservoirs. — In certain parts of California, and in other western states, large bodies of water occur in the coarse gravels well beneath the valley land surface. Pumping water from underground sources is so widely practiced that it has become a well-established method of obtaining irrigation water. The lowering of the ground-water surface which has followed extensive pumping for irrigation in some places has proved valuable as a means of drainage. In other localities the ground-water surface has been lowered so much by irrigation pumping that deepening of wells has become necessary. Also, the lowering of the ground water has increased the pumping lift and thus made the water so obtained increasingly expensive. However, a reasonable lowering of the ground-water surface each year, in a locality where conditions are favorable for pumping, really develops capacity for subsequent underground water storage. Systematic flooding of land surfaces overlying or draining into underground reservoirs is gradually becoming a recognized method of water storage. To a limited extent the gravels under the higher lands may serve as ground-water reservoirs, provided the movement of the water toward the lower levels is not too rapid.

The advisability of spreading water over land surfaces during the periods of surplus flow as a means of storing it for later use is a question to which there is no general answer. Local conditions which determine the capacity of the ground-water storage; the method; the percentage; the cost of water recovery; and also the feasibility of equitably distributing the water stored by different irrigation interests — these and other more detailed problems demand attention in each locality as a basis for determining the advisability of such storage.

21. Conveyance of Irrigation Water. — In general, irrigated lands are situated great distances from the sources of water supply. Water obtained from natural streams and from surface reservoirs, as a rule, must be conveyed further than water obtained from underground reservoirs. Water flowing in ordinary canals moves slowly — from 1 to 3 miles per hour. The main conveyance or diversion canals of American irrigation projects vary from a few miles to 75 or more miles in length. Some projects convey water several hundred miles from storage reservoirs in the mountains by commingling the stored water with the water of natural rivers and then again diverting it into large canal systems in the valleys. Consequently, many hours, and on some projects, days, are required to convey the water from points of storage or diversion to points of use. Extraordinary knowledge, skill, and devotion to responsibility are required of the designing and the operating engineers and their staffs in order safely and economically to convey large amounts of water long distances, frequently through rugged lands and canyons. A brief survey of the natural forces which cause water flow and of the conveyance structures used on modern irrigation systems is presented in the following pages.

The principles of water flow and the problems of water conveyance are topics to which entire volumes of technical engineering books are devoted. In this book, some of the forces which cause water flow, and also some of those which retard its flow, are briefly considered. The discussion considers only steady flow, i.e., flow in which the same volume of water passes any given point in a channel during each second of time. Furthermore, with a few minor exceptions, it is assumed that there is little or no change in velocity from point to point along a channel; that is, the flow is considered uniform.

Articles 22 to 27, inclusive, deal with the forces and conditions that influence steady uniform flow; Articles 28 and 29 contain equations that are used in practice to measure the velocity and the discharge of streams. These articles are followed by brief descriptions of some structures used for conveyance of irrigation water.

22. Forces which Cause Water Flow. — Water flows as a result of being acted on by certain forces, the most important of which are:

1. The attraction of the earth, commonly spoken of as the earth-pull, or gravity; and
2. The action of pressures of different intensities which give rise to certain resultant forces.

23. Gravity, and Flow in a Canal. — Water flowing in a canal of uniform cross-section area and constant depth has a constant velocity. Every unit mass of water in a canal is attracted toward the center of the earth by a force which is continuously pulling vertically downward. The effective or resultant force which causes the flow of each unit mass of water is the component of gravity parallel to the water surface.

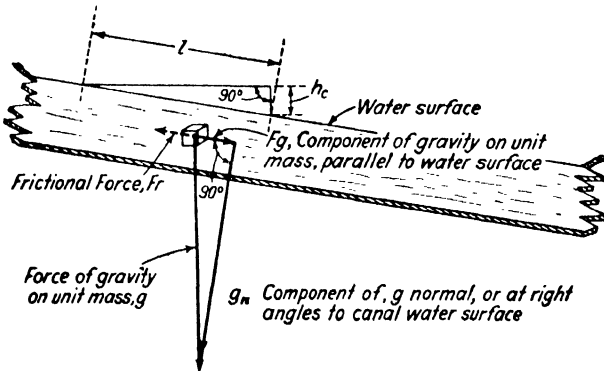

FIG. 6. — Illustrating the weight per unit mass, and its component parallel to the water surface as the driving force causes water flow in a canal.

This force is represented by the line F_g in Fig. 6. The slope is defined as the fall in water surface per given length of canal; such as 1 foot per 1000 feet. In Fig. 6 it is represented by h_c/l , as illustrated by the small triangle. The two right triangles are similar, having two sides perpendicular. It is therefore apparent that:

$$\frac{F_g}{h_c} = \frac{g}{l} \quad \text{and hence} \quad F_g = \frac{gh_c}{l} \dots \dots \dots (1)$$

It is clear from equation (1) and Fig. 6 that the driving force F_g per unit mass in the direction of flow increases as the slope of the water surface increases. If the slope is zero, i.e., if the water surface is level, $h_c =$ zero, $F_g =$ zero, and there is no flow.

24. Pressure Differences and Flow in a Level Pipe. — The intensity of water pressure at any point in a body of still water is proportional to

the depth of the point below the water surface. This law is widely used in engineering and is stated mathematically as

$$p = wH \dots \dots \dots (2)$$

where p = intensity of pressure (pounds per square foot);
 w = weight of unit volume of water (pounds per cubic foot);
 H = depth of the point vertically below the water surface (feet).

The pressure difference at two points designated as points 1 and 2 may be obtained thus:

$$p_2 = wH_2 \dots \dots \dots (a)$$

$$p_1 = wH_1 \dots \dots \dots (b)$$

Subtracting equation (b) from (a),

$$p_2 - p_1 = w(H_2 - H_1) \dots \dots \dots (c)$$

For convenience, the pressure differences at any two points, ($p_2 - p_1$), are represented by p' , and the differences in depth ($H_2 - H_1$) are represented by h_0 . It then follows that

$$p' = wh_0 \text{ and } h_0 = \frac{p'}{w} \dots \dots \dots (3)$$

The force on each unit mass causing flow through a level pipe is *proportional* to the pressure head difference h_0 or $\frac{p'}{w}$ per unit length of pipe.

Measurements of the pressure head differences are illustrated in Fig. 7, which shows a level pipe, $A-B$, connected to a reservoir, R , into which a stream of water is flowing. The inflow is just large enough to maintain the water level constant at a distance H' feet above the middle of the outlet pipe. The six small vertical tubes, called piezometers, numbered 1, 2, 3, etc., are connected with the large pipe in order to measure the pressure heads at various points along the large horizontal pipe. When the valve near the outlet end of the large pipe is closed, the water stands at the elevation E' in pipe 6, the same elevation as it is in the reservoir, and in each of the other piezometer tubes. The total pressure on unit area inside the large pipe at B is equal to the atmospheric pressure on unit area plus the water pressure due to the column of water of height H' , when the valve is closed; but as soon as it is opened, water flows out because the total pressure inside the pipe is higher than the atmospheric pressure outside. After the flow through the large pipe has reached a steady state, the water in each of the several piezometer tubes will stand as indicated by the dotted line $E-B$. The

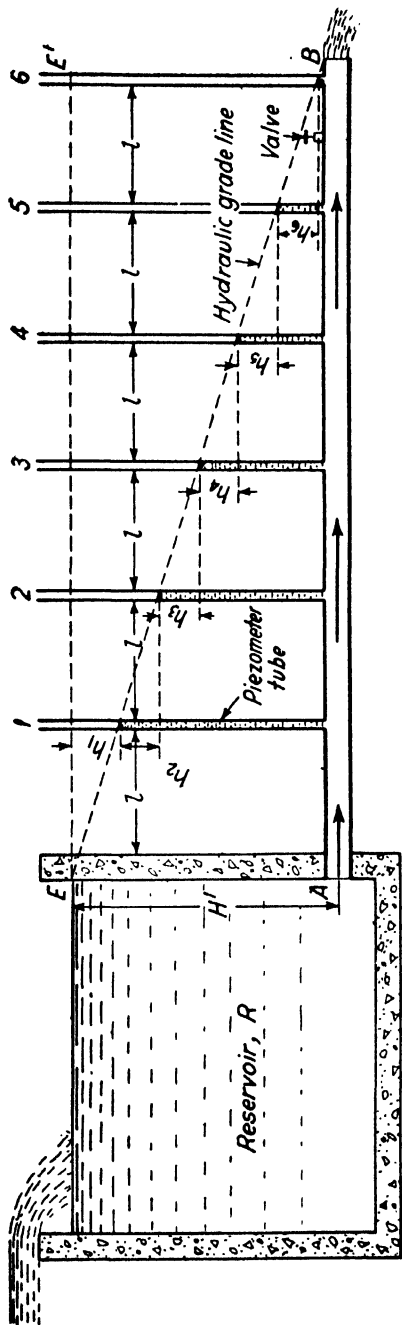

Fig. 7. — Illustrating the position of the hydraulic grade line as water flows through a horizontal pipe line from a reservoir in which the water is maintained at constant depth.

difference in the pressure heads as measured in piezometer (1) and (2) is given by the equation

$$h_2 = \frac{p_1 - p_2}{w} \dots \dots \dots (d)$$

In order to evaluate the driving force for unit mass due to those pressure head differences, it is necessary to express the weight of water per unit volume, w , in terms of mass and density.

The weight of water per unit volume is equal to its density times the force of gravity per unit mass, i.e.,

$$w = \rho g^* \dots \dots \dots (4)$$

where

- g = the force of gravity per unit mass, as used in Article 23, and
- ρ = density, or mass per unit volume.

Placing in equation (3) the value of w as given in equation (4), there results

$$p' = \rho g h_0 \quad \text{and} \quad gh_0 = \frac{p'}{\rho} \dots \dots \dots (5)$$

Remembering that the h_0 represents a pressure head difference in a given length of level pipe, l , it is not difficult to see that the resultant driving force F_p on unit mass, due to pressure head differences, is given by the equation,

$$F_p = g \frac{h_0}{l} \dots \dots \dots (6)$$

From equations (5) and (6) it is evident also that

$$F_p = \frac{p'/\rho}{l} \dots \dots \dots (7)$$

25. Flow in an Inclined Pipe. — Provided the velocity of flow is constant in a sloping pipe, the total driving force per unit mass, F , is equal to the sum of the forces $F_g + F_p$ of equations (1) and (7), i.e.,

$$F = \left(\frac{gh_0 + p'/\rho}{l} \right) \dots \dots \dots (8)$$

This is illustrated in Fig. 8. At the point (1) the combined *energy* per unit mass due to position with respect to the plane M , and to pres-

* It is shown in Chapter X that 1 cubic foot of water contains 1.94 mass units, using the *gravitational system*. To illustrate the equality of w to the product ρg we may write: $w = 62.5$ pounds, $\rho = 1.94$ geepounds, $g = 32.2$ feet per second. Then according to equation (4) $62.5 = 1.94 \times 32.2 = 62.2$. The student may work out a similar illustration using other units of weight, mass, and acceleration.

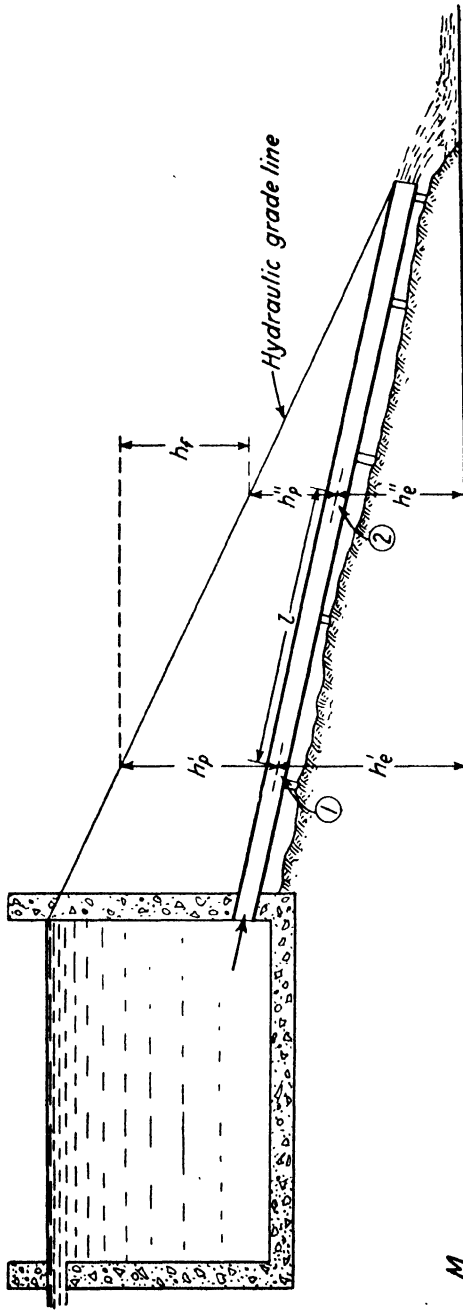

Fig. 8. — Illustrating the flow of water through a sloping pipe.

M

sure, is represented by the product $g(h_e' + h_p')$. The resultant driving force on unit mass due to the combined effect of differences in position and in pressure between the points (1) and (2) separated by a distance l is given by:

$$F = g \left(\frac{(h_e' + h_p') - (h_e'' + h_p'')}{l} \right) = \frac{gh_f}{l} \dots \dots (9)$$

where h_f = the drop in the hydraulic grade line* in the distance l as shown in Fig. 8.

Comparison of equations (1), (7), and (9) shows that the slope of the line connecting the heights to which water will rise above a pipe line because of the water pressures inside the pipe is somewhat analogous to the slope of the water surface in open channels. The foregoing analysis shows that the driving force per unit mass causing water flow, may be a component of gravity (equation 1), a pressure potential gradient, † (equation 7), or a combination of these two forces (equation 9).

26. Retarding Forces. — Motion of all substances, including water, is retarded by forces which are brought into action by the resistance of one body moving over another with which it is in contact. For example, a moving train is retarded by its contact with the earth. Forces of this type which resist motion are called *frictional forces*. The frictional forces are greater on bodies moving at high velocities than on the same bodies moving at low velocities. In a canal, the necessary condition for a constant velocity of water is that the frictional force per unit mass resisting motion, i.e., F_r in Fig. 6, is equal in magnitude to the driving force F_g . If at a given point along the canal, the slope increases, the driving force, F_g , is also increased and at this point the velocity of the water will be accelerated. The increase in velocity increases the frictional resistance until F_r again equals F_g (in magnitude). ‡ As a result of experiments on the relation of friction to velocity of water in canals and pipes, it is generally agreed that when the velocity exceeds the *critical velocity* and the flow is *turbulent*, the frictional resistance varies approximately with the square of the velocity, i.e.,

$$F_r = Cv^2 \dots \dots \dots (e)$$

where C = a constant.

* See Article 27 and Figs. 9 and 10 for the meaning of the term "hydraulic grade line."

† See Chapter X for a definition of the potential gradient.

‡ In the flow of water in ordinary canals and pipes there are eddies and cross-currents. The water particles move in rather irregular zigzag directions; such flow is spoken of as a *turbulent flow*, as contrasted to *stream-line flow*, which is characteristic of the slow flow of water through sands, or very small tubes. There are no eddies or cross-currents in stream-line flow.

Since as stated above

$$\left. \begin{aligned} F_r &= F_g \text{ (for canals)} \\ F_r &= F_p \text{ (for level pipes)} \\ F_r &= F \text{ (for sloping pipes)} \end{aligned} \right\} \dots \dots \dots (f)$$

It follows that:

$$\left. \begin{aligned} v^2 &= C' \times F_g \text{ (for canals)} \\ v^2 &= C \times F \text{ (for pipes)} \end{aligned} \right\} \dots \dots \dots (g)$$

and

and hence:

$$\left. \begin{aligned} v^2 &= C'g \frac{h_c}{l} \text{ (for canals)} \\ v^2 &= C'g \frac{h_f}{l} \text{ (for pipes)} \end{aligned} \right\} \dots \dots \dots (h)$$

Remembering that h_c/l is the slope of the water surface in a canal, that h_f/l is the hydraulic slope (Fig. 8), and that g is constant, it follows that for flow of water in a particular canal or a pipe the velocity equals a constant times the square root of the slope, i.e.,

$$v = C'' \times \sqrt{\text{slope}} \dots \dots \dots (10)$$

where $C'' = \sqrt{C'g}$.

The frictional forces which retard the velocity of water in a channel are influenced by the relative area of the surface of contact between the water and the bottom and sides of the channel per unit of length, and also by the degree of roughness of the material of which the channel is built. The relative area of surface contact between water and channel, as represented by the ratio of the cross-sectional area of the channel to the wetted perimeter, is termed the hydraulic radius, and is represented by the symbol r . For example, a rectangular channel having a bed width of 5 feet and depth of 2 feet has a cross-sectional area of 10 square feet and a wetted perimeter of 9 feet, from which the hydraulic radius is $1\frac{1}{3}$ feet. From the above definitions the student may prove that the hydraulic radius of a circular pipe running full of water is one-fourth of the diameter.

27. Energy and Hydraulic Grade Lines. — It is apparent from the preceding sections that expenditure of energy is essential to make water flow. Mechanical work is defined as the product of force times distance, and mechanical energy is the capacity for doing work. Each unit mass of water in a flowing stream has three forms of energy: one of position, one of pressure, and one of velocity. The loss in energy per unit mass of water for each unit length of canal is represented by the lines marked energy grade line in Figs. 9 and 10. The loss of energy per unit mass

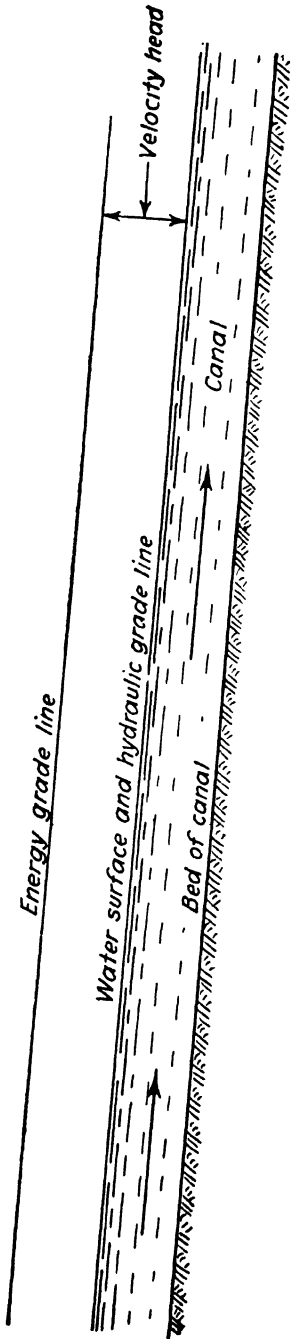

Fig. 9. — Open canal showing water surface (hydraulic grade line) and energy grade line.

per foot length of a canal of uniform cross-section and depth of water is constant as shown by the energy grade line of Fig. 9. For flow in pipes, the slope of the energy grade line changes at points where the diameter of the pipe changes, but the energy grade line always falls, as shown in Fig. 10, whereas the hydraulic grade line rises at sections where the velocity head is suddenly decreased and the pressure head increased, as also illustrated in Fig. 10.

In general, the driving force per unit mass of water is *proportional* to some function of the slope of the energy grade line, i.e., to the loss of energy per unit mass per unit length of pipe or canal. In any given pipe line of uniform diameter in which water flows at a constant velocity, the velocity is proportional approximately to the square root of the slope of the hydraulic grade line, as shown in equation (10).*

It is important to note that in computing the slope of the hydraulic or energy grade lines the length l is measured along the canal or the pipe, not along the line. The length along the canal or pipe is the same as the length of the line between two points only in the case of steady uniform flow in a canal or in a pipe in which the hydraulic or energy grade line is parallel to the pipe line. (See Figs. 6 to 10.)

Energy and hydraulic grade lines are considered further in Chapter X in connection with the study of the movement of water in soils.

* Scobey has found significant departures from the approximate relation, that the velocity is proportional to the square root of the hydraulic slope. It is beyond the scope or the purpose of this chapter to give his findings concerning the flow of water in pipes.

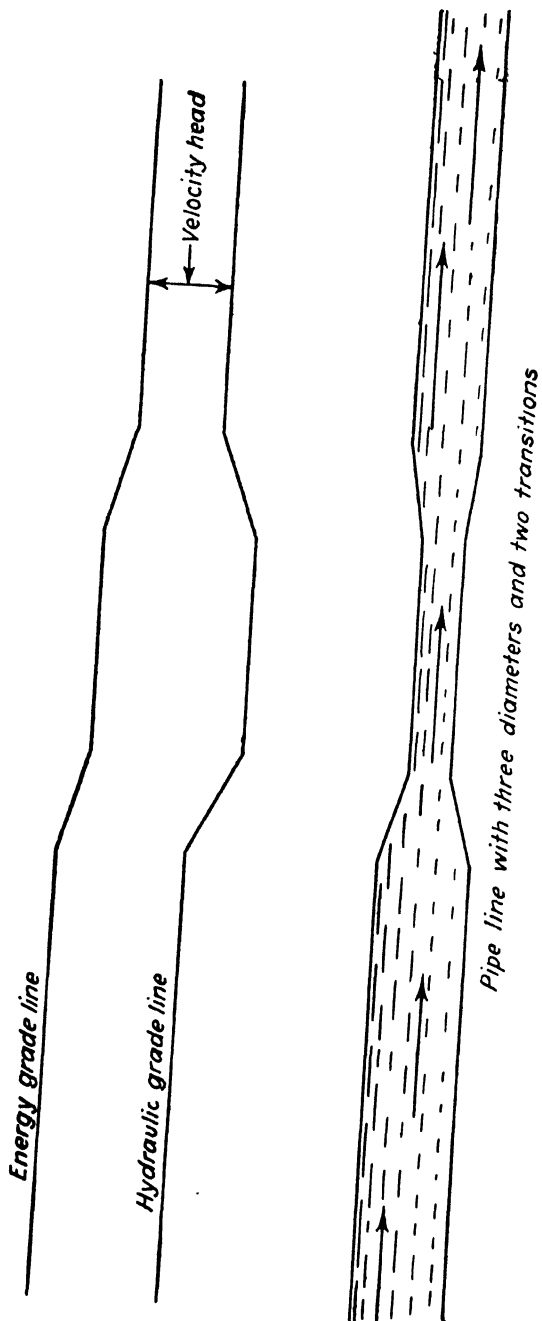

FIG. 10. — Showing that the energy grade line always falls in the direction of flow.

28. Velocity Equations. — Many valuable experiments have been conducted in order to ascertain the numerical relation between the velocity of flowing water, the degree of roughness, the hydraulic radius, and the slope of the channel; and thus obtain a velocity equation of general value. These experiments have resulted in a number of closely related velocity equations, most of which have much merit. Of these equations, the one proposed by Chezy, using the Kutter formula to evaluate C , the Manning equation, and the equations derived by Scobey are widely used. The Manning equation follows:*

$$v = \frac{1.486r^{2/3}s^{1/2}}{n} \dots \dots \dots (11)$$

in which

- v = mean velocity in feet per second;
- n = coefficient of roughness, which is also used in the Kutter formula;
- r = hydraulic radius in feet;
- s = slope of the canal water surface or the hydraulic slope.

By the use of Table I the student can select n , and he can then determine v , when r and s are known. (The selection of n from Table I is very important, as the velocity varies inversely with its value.) For known values of r and s the value of the product nv may be computed by use of equation (11). Dividing the proper value by n gives the velocity. For example, suppose that $r = 2.3$ and $s = 0.0008$. Then $nv = 0.0732$. If the canal considered is built in earth, straight and uniform, then according to Table I, $n = 0.020$. Therefore the velocity is

$$v = \frac{0.0732}{0.0200} = 3.66 \text{ feet per second}$$

29. Discharge Equation. — Fig. 11 represents a rectangular channel 2 feet wide in which water 1 foot deep is flowing as indicated by the arrows. If the mean velocity of all the water particles, v , in equation (11) be 1 foot per second, then the discharge would be 2 cubic feet per second. However, if the mean velocity were 1.5 feet per second, then the discharge (or quantity of flow) would be 3 cubic feet per second. It is apparent from the above reasoning that

$$q = av \dots \dots \dots (12)$$

- where q = quantity of flow in cubic feet per second;
- a = cross-section area of canal in square feet; and
- v = the mean velocity in feet per second.

* Manning's equation is presented here because of its simplicity despite the fact that other velocity equations are more widely used in the design of irrigation conduits.

It is very important that the student clearly understand equation (12), because it is the basis of all discharge measurements of flowing streams.

30. Earth Canals. — By far the most common type of irrigation conveyance channel is the one excavated in the natural material along the line that the water must be conveyed. When used without artificial lining of bed or sides, such a channel is called an earth canal. Excessive velocities of water in earth canals must be avoided to prevent erosion. Very few natural materials will stand velocities in excess of 5 feet per second. The low initial cost constitutes the major advantage of earth canals. The disadvantages are: (a) excessive seepage losses, (b) low velocities and therefore relatively large cross-section areas,

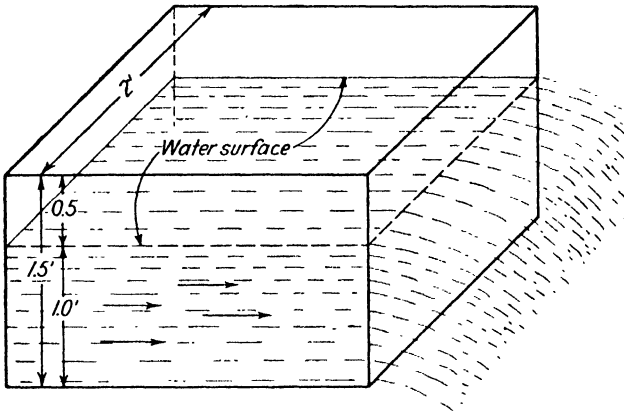

FIG. 11. — Illustrating the flow of water in a rectangular flume.

(c) danger of breaks due to erosion and the burrowing of animals, and (d) favorable conditions for growth of moss and weeds which retard the velocity. The sides of earth canals are usually built as steep as the earth will stand when wet. The slope of the sides varies from 3 horizontal to 1 vertical, to $\frac{1}{2}$ horizontal to 1 vertical, for very favorable materials. The relation of bed width to depth of earth canals is determined according to the topographic conditions. The bed width may be less than the depth, or it may be 10 or more times the depth. The most economical cross-section under favorable structural conditions is

$$\text{bed width} = 2 \times \text{depth} \times \tan \theta/2 \dots \dots (13)$$

where θ is the angle of the side slope with the horizontal. This relation applies also to lined canals. For rectangular channels $\tan \theta/2 = 1$, and hence the bed width = twice the depth.

31. Concrete-Lined Canals. — For the purposes of (1) decreasing conveyance losses, (2) providing safety against breaks, (3) preventing weed growth, (4) retarding moss growth, (5) decreasing erosion with high velocities, (6) cutting down maintenance costs, and (7) increasing the capacity of the canal to convey water, many irrigation canals are now being lined with concrete. Detail cost investigations are essential to a determination of the economic advisability of lining canals with concrete. From the viewpoint of the irrigation project, the most important single factor in a study of the advisability of lining is the annual value of the water saved by decreasing conveyance losses. In localities where water is very limited, the public interests are advanced by lining canals and thus contributing to a more economical use of the available water supply.

32. Flumes. — For crossing deep natural depressions or narrow canyons, and for conveyance of irrigation water along very steep side hills, flumes are commonly constructed either of wood, metal, or concrete. To attain economy in the use of materials for flumes, it is desirable to give the flume sufficient slope to assure a water velocity appreciably higher than in earth canals, thus making possible a proportionate reduction in canal cross-section.

33. Tunnels. — To shorten the length of the diversion canal, to avoid difficult and expensive construction on steep, rocky hillsides, and to convey irrigation water through mountains from one watershed to another, many tunnels have been constructed. It is usually economical to line the bottom and sides of tunnels through rock formations as a means of decreasing seepage losses and lessening the frictional resistance. Irrigation tunnels constructed through loose material are lined with concrete as the boring of the tunnel progresses.

34. Drops and Chutes. — It is essential to avoid excessive velocities in irrigation canals in order to prevent damage from erosion of the bottom and sides. In places where the natural slopes down which canals must flow are so high as to cause excessive velocities, at convenient points wood or concrete bulkheads are placed, over which the water is dropped several feet. The function of drops is really to dissipate the energy of the flowing stream without causing erosion. Chutes built of wood, concrete, or steel are serviceable where it is necessary to convey water down relatively steep hills which would require many drops closely spaced to control the water velocity, and in which the water would cause serious erosion if not controlled. Chutes may well be considered in three sections: (1) the transition and section of accelerating velocity, (2) the section of uniform high velocity, and (3) the stilling basin. In the first section the velocity is increased from approximately 3 feet per

second up to 20 or more feet per second, and the cross-section area of the water is proportionately decreased. In the second section, because of the very high velocity, the retarding forces are equal in magnitude and opposite in direction to the driving forces, and hence the water velocity remains constant. To dissipate the energy at the lower end of a chute, it is necessary to provide a deep stilling basin. A design which will assure the occurrence of a hydraulic jump* is an effective means of dissipating energy.

35. Inverted Siphons. — For crossing wide deep hollows, depressions, or canyons, it is customary to build pipe lines and force water through them under pressure. The cost of flumes for crossing wide depressions is so high as to prohibit their construction. Pipes used to convey irrigation water across canyons are known as inverted siphons. Such pipe lines are built either of steel, of wood staves held in place by iron bands, or of reinforced concrete. A wood stave inverted siphon across the Bear River in Idaho resists a water pressure of nearly 300 feet along the bottom of the canyon.

The stress caused by the water pressure in siphons is resisted by the unit strength and thickness of steel, in steel pipes; by the unit strength, diameter, and spacing of the bands around wood stave pipe; and by the unit strength and amount of reinforcement in concrete pipe. Large-diameter siphons require respectively thicker steel, larger and more closely spaced bands, and more steel reinforcement than small-diameter siphons under the same water pressure. The velocity of the water flowing through a siphon of given diameter is fixed by the hydraulic slope and the roughness of the inside of the pipe. The velocity is not influenced by the total water pressure inside the pipe. To determine the velocity the student may use Manning's formula given in Article 28, together with Table I. For example, consider a 6-foot diameter wood stave siphon in the best of condition, 1 mile long, having a drop in water surface of 9 feet. Then $r = 1.5$ and $s = 0.0017$; from Table I, $n = 0.01$. Therefore, $nw = 0.0803$, and hence $v = 8.03$ feet per second. As the cross-section area of a 6-foot diameter pipe is 28.3 square feet, this pipe would discharge $8.03 \times 28.3 = 227$ cubic feet per second.

NOTE: See Appendix for problems and questions for Chapters II to XVIII, inclusive.

* King's Handbook of Hydraulics, second edition, page 334.

TABLE I

HORTON'S VALUES OF *n*. TO BE USED WITH KUTTER'S AND MANNING'S FORMULAS

Surface	Best	Good	Fair	Bad
Uncoated cast-iron pipe	0.012	0.013	0.014	0.015
Coated cast-iron pipe	011	.012*	.013*	
Commercial wrought-iron pipe, black012	.013	.014*	.015
Commercial wrought-iron pipe, galvanized013	.014	.015	.017
Smooth brass and glass pipe009	.010	.011	.013
Smooth lockbar and welded "OD" pipe010	.011*	.013*	
Riveted and spiral steel pipe013	.015*	.017*	
Vitrified sewer pipe	{ .010	.013*	.015	.017
	.011			
Common clay drainage tile011	.012*	.014*	.017
Glazed brickwork011	.012	.013*	.015
Brick in cement mortar; brick sewers012	.013	.015*	.017
Neat cement surfaces010	.011	.012	.013
Cement mortar surfaces011	.012	.013*	.015
Concrete pipe012	.013	.015*	.016
Wood stave pipe010	.011	.012	.013
Plank Flumes:				
Planed010	.012*	.013	.014
Unplaned011	.013*	.014	.015
With battens012	.015*	.016	
Concrete-lined channels012	.014*	.016*	.018
Cement-rubble surface017	.020	.025	.030
Dry-rubble surface025	.030	.033	.035
Dressed-ashlar surface013	.014	.015	.017
Semicircular metal flumes, smooth011	.012	.013	.015
Semicircular metal flumes, corrugated0225	.025	.0275	.030
Canals and Ditches:				
Earth, straight and uniform017	.020	.0225*	.025
Rock cuts, smooth and uniform025	.030	.033*	.035
Rock cuts, jagged and irregular035	.040	.045	
Winding sluggish canals0225	.025*	.0275	.030
Dredged earth channels025	.0275*	.030	.033
Canals with rough stony beds, weeds on earth banks025	.030	.035*	.040
Earth bottom, rubble sides028	.030*	.033*	.035
Natural Stream Channels:				
(1) Clean, straight bank, full stage, no rifts or deep pools025	.0275	.030	.033
(2) Same as (1), but some weeds and stones030	.033	.035	.040
(3) Winding, some pools and shoals, clean033	.035	.040	.045
(4) Same as (3), lower stages, more ineffective slope and sections040	.045	.050	.055
(5) Same as (3), some weeds and stones035	.040	.045	.050
(6) Same as (4), stony sections045	.050	.055	.060
(7) Sluggish river reaches, rather weedy or with very deep pools050	.060	.070	.080
(8) Very weedy reaches075	.100	.125	.150

From "Handbook of Hydraulics" by King. McGraw-Hill Book Company, Inc., Publishers.

* Values commonly used in designing.

REFERENCES

- BAKER, DONALD M., and CONKLING, HAROLD. *Water Supply and Utilization*, John Wiley & Sons, New York. 1930.
- CLYDE, GEORGE D. *Establishing Snow Courses and Making Snow Surveys*, Utah Agr. Exp. Sta. Cir. 91. 1930.
- ETCHEVERRY, B. A. *Irrigation Practice and Engineering*, Vol. II, *Conveyance of Water*, McGraw-Hill Book Co., New York. 1916.
- KING, HORACE WILLIAMS. *Handbook of Hydraulics*, second edition, McGraw-Hill Book Co., New York. 1929.
- SCOBAY, FRED C. *The Flow of Water in Irrigation Channels*. U. S. Dept. Agr. Bul. 194, 68 p. Illus. 1915 (Reprinted 1924).
- SCOBAY, FRED C. *The Flow of Water in Wood Stave Pipe*. U. S. Dept. Agr. Bul. 376, 96 p. Illus. 1916 (Revised 1926).
- SCOBAY, FRED C. *The Flow of Water in Concrete Pipe*. U. S. Dept. Agr. Bul. 852, 100 p. Illus. 1920.
- SCOBAY, FRED C. *The Flow of Water in Riveted Steel and Analogous Pipes*. U. S. Dept. Agr. Bul. 150, 136 p. Illus. 1930.

CHAPTER III

MEASUREMENT OF IRRIGATION WATER

The economical use of water for irrigation depends very largely on measurement of water. The rapidly increasing utilization of all available water, the resultant increase in its value, and the growing tendency among irrigation companies to base annual water charges on the amount of water used, make an understanding of the principles and methods of water measurement very necessary. Moreover, many irrigators and others now realize that the vast store of information concerning the relations of water, soils, and plants that has been accumulated in years past cannot be utilized in irrigation practice without the measurement of water. The first step in a study of water measurement is to become acquainted with the units employed.

36. Units of Water Measurement. — The units of water measurement are here considered in two classes: first, those expressing a specific volume of water at rest, and second, those expressing a rate of flow. The commonly used units of volume of water at rest are the gallon, the cubic foot, the acre-inch, and the acre-foot. An acre-inch is a quantity of water sufficient to cover 1 acre 1 inch deep, which is 3630 cubic feet. An acre-foot of water will cover 1 acre 1 foot deep, and is therefore equal to 43,560 cubic feet. The commonly used units of rate of flow are gallons per minute, cubic feet per second, acre-inches per hour, and acre-feet per day. The miner's inch is also used. It is defined as the amount of water that will flow through an opening 1 inch square in a vertical wall under a pressure ranging from 4 to 7 inches. Each of the western states defines the miner's inch in terms of 1 cubic foot per second. One miner's inch is designated as $\frac{1}{50}$ of a cubic foot per second in parts of California, Idaho, Kansas, New Mexico, North Dakota, South Dakota, Nebraska, and Utah. In Arizona, Nevada, Montana, Oregon, and Central California, 1 miner's inch is equal to $\frac{1}{40}$ of a cubic foot per second, and in Colorado 38.4 miner's inches are considered equal to 1 cubic foot per second.

37. Velocity of Flow through an Orifice. — It is well known that when the water-pressure intensity inside the pipes of a domestic water system is high the water flows out of an open tap at a high velocity, and that when the pressure intensity is low it flows out slowly. If the water-

pressure intensity within the pipe were exactly equal to the pressure intensity of the air outside the pipe there would be no flow. Therefore, when taps are opened water flows out of pipes in response to pressure-intensity differences. Remembering from Article 24 that pressure intensity at any point within a body of water is proportional to the depth of the point below the water surface, it is easy to understand that the velocity of water through an opening in a vessel (or in a wall built across a stream) which is well below the water surface is greater than the velocity through an opening near the water surface. In irrigation practice it is important to know just what the velocity will be through an orifice at any vertical distance below the water surface. The basic physical law which determines the velocity of water through an orifice is the same as the law which determines the velocity of a freely falling body at any vertical distance below the point from which it began to fall.

The student who has pursued a course in elementary physics will remember that the velocity of a falling body, ignoring atmospheric friction, may be determined at any point by knowing the vertical distance through which the body has fallen from rest. Likewise, the velocity of water in feet per second escaping from an opening (orifice) in a vessel, ignoring friction, may be determined by knowing the height of the water in the vessel above the opening. Stated as an equation, this very important law of falling bodies, as applied to the flow of water, asserts that:

$$v = \sqrt{2g} \sqrt{h} \dots \dots \dots (14)$$

- where v = velocity in feet per second;
- g = the acceleration due to gravity (or the force of gravity per unit mass of water), which is 32.2 feet per second;
- h = the depth of water in feet, or maximum pressure head causing the discharge through the orifice.

If the orifice opening is very high, then the velocity of flow through the orifice will be appreciably greater near the bottom of the orifice than near the top. For the purpose of this discussion it is assumed that the orifice height is so small as compared to the pressure head of water causing the discharge that the difference between velocity near the top and near the bottom of the orifice is negligible. To illustrate the use of equation (14), assume that h in Fig. 12 = 4 feet. Then $v = \sqrt{2} \times 32.2 \times \sqrt{4} = 16.04$ feet per second, i.e., *theoretically*, water should flow through an orifice which is 4 feet below the water surface at a velocity of approximately 16 feet per second. In reality, owing to frictional resistance, the *actual* velocity is somewhat less than the theoretical velocity.

38. Discharge through an Orifice. — Remembering from equation (12) that $q = av$, it is apparent that the *theoretical* discharge through an orifice may be determined by substituting the value of v from equation (14) in the above *quantity* equation, i.e.,

$$q = a\sqrt{2g} \sqrt{h} \dots \dots \dots (15)$$

If the orifice opening in Fig. 12 were 4 inches high by 18 inches long (perpendicular to the plane of the paper), the area would be

$$a = \frac{4 \times 18}{144} \text{ square feet}$$

Experiment has shown that the actual discharge for standard orifices is

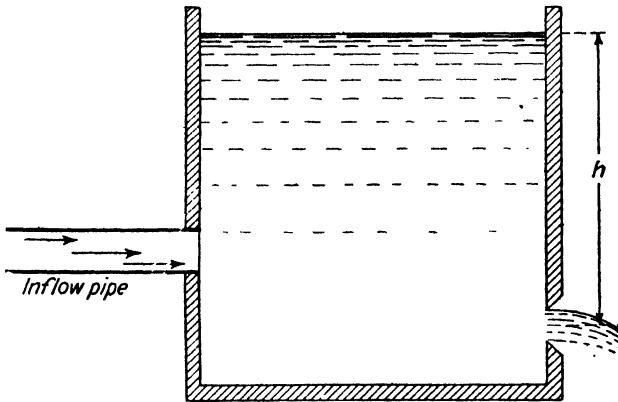

FIG. 12. — Illustrating the discharge of water through an orifice under a head, h .

approximately six-tenths the theoretical discharge, so that the actual q would be computed thus:

$$q = \frac{6}{10} \times \frac{1}{1} \times \frac{1}{2} = 4.8 \text{ c.f.s.}$$

Finally, the equation for actual discharge through an orifice is

$$q = Ca \sqrt{2g} \sqrt{h} \dots \dots \dots (16)$$

in which C is a coefficient of discharge determined by experiment. The coefficient C ranges from 0.6 to 0.8 or more, depending on the position of the orifice relative to the sides and bottom of the vessels or of the water channel, and also on the degree of roundness of the edges of the orifice.

Suppose that the height of the orifice is increased and that the water surface is lowered until it drops below the upper edge of the orifice, as shown in Fig. 13. Then the pressure head in feet, which causes the

average velocity, as represented by h of Fig. 13, is one-half of the total depth of water over the bottom edge of the orifice. The cross-section area of the stream at right angles to the direction of flow is actually less than the cross-section area of the orifice. The length of orifice being 18 inches or 1.5 feet, it is clear that the cross-section area of the stream is

$$a = 2h \times 1.5 \text{ square feet}$$

or representing the length of orifice by the symbol L measured in feet,

$$a = 2hL \text{ square feet}$$

Substituting this value of a in equation (16) it is evident that

$$q = 2C \sqrt{2g} Lh \times \sqrt{h} = 2C \sqrt{2g} Lh^{3/2}$$

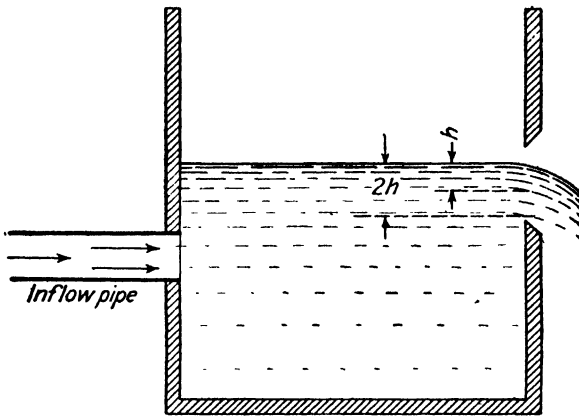

FIG. 13. — Showing that discharge through a partly-filled orifice is similar to the discharge over a weir.

Since the acceleration due to gravity, g , is nearly constant, it is convenient to represent the product $2C \sqrt{2g}$ by a single symbol, say C' , and then it follows that

$$q = C' Lh^{3/2} \dots \dots \dots (17)$$

Equation (17) gives the theoretical discharge of an orifice when the top edge of the orifice is above the water surface.

39. Discharge of Weirs. — The term weir as used in measurement of water is defined as a notch in a wall built across a stream. The notch may be *rectangular*, *trapezoidal*, or *triangular* in shape. It is apparent that the orifice in Fig. 13, when flowing partly full, is a weir according to the above definition. In measuring the flow of water over weirs, it is convenient and customary to measure the total depth, i.e., $2h$ of Fig. 13.

Although the total depth, as represented in Fig. 14 by the symbol H , does not represent the point in the stream of average velocity, it can be used in equation (17) by changing only the coefficient C' . Substituting for h its equivalent $H/2$ in (17), there results

$$q = C' L \left(\frac{H}{2} \right)^{3/2} = \frac{C'}{2^{3/2}} LH^{3/2}$$

or

$$q = C'' LH^{3/2} \dots \dots \dots (18)$$

in which $C'' = C'/2^{3/2}$.

Equation (18) is the general form for discharge of rectangular and trapezoidal weirs. Although, as shown above, it is based on the fundamental equation $q = av$, the student should note that in using equation (18) the only measurements essential are those of length of weir crest,

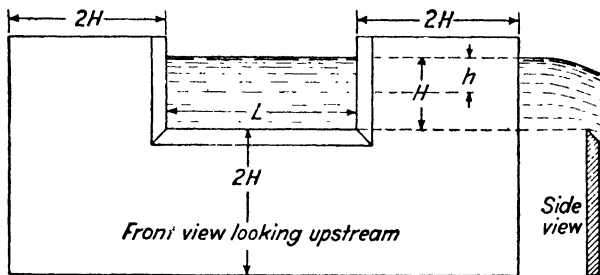

FIG. 14. — A rectangular weir with complete end contractions.

L , and depth of water flowing over it, H . The velocity need not be measured directly. The coefficient C'' , ordinarily represented by C , has been determined by experiment by many workers. For rectangular weirs it was early found by Francis to be 3.33, and hence the widely used weir discharge equation

$$q = 3.33 LH^{3/2} \dots \dots \dots (19)$$

Equation (19) without modification applies accurately only to rectangular weirs in which the length of weir is the same as the width of the rectangular channel immediately above the weir, i.e., weirs having *suppressed* end contractions. For weirs having *complete* end contractions, such as represented in Fig. 14, the effective length of weir crest, L , is found from the relation

$$L = L' - 0.2H \dots \dots \dots (20)$$

in which L' = the measured length of weir crest. In actual use of equation (19), and other discharge equations, it is customary to compute tables from the equation, using $L = 1$, and for many values of H .

Table II gives discharge per foot of length of weir crest based on equation (19) for values of H from 0.20 up to 1.24 feet. For example, columns 1 and 3 show that for a head H of 0.45 foot the discharge is 1.005 c.f.s. per foot length of weirs having *suppressed* end contractions. The effective length for a 1-foot weir having *complete* end contractions, according to equation (20), is $L = 1.00 - 0.2 \times 0.45 = 0.91$ foot, and

TABLE II

DISCHARGE IN CUBIC FEET PER SECOND (SECOND-FEET) PER FOOT OF LENGTH OF WEIR CREST BY THE FRANCIS FORMULA: $q = 3.33 H^{3/2}$

1		2		3		1a		2a		3a		1b		2b		3b	
Depth of Water or Head, H				Discharge in Second-feet (q)		Depth of Water or Head, H				Discharge in Second-feet (q)		Depth of Water or Head, H				Discharge in Second-feet (q)	
Feet	Inches			Feet	Inches			Feet	Inches			Feet	Inches			Feet	Inches
0	.20	2 $\frac{3}{4}$		0.298	0	.55	6 $\frac{5}{8}$		1.358	0.90	10 $\frac{1}{16}$		2.843				
.21		2 $\frac{1}{2}$.320		.56	6 $\frac{3}{4}$		1.395		91	10 $\frac{1}{8}$	2.890				
.22		2 $\frac{1}{2}$.344		.57	6 $\frac{1}{2}$		1.433		.92	11 $\frac{1}{16}$	2.938				
.23		2 $\frac{1}{2}$.367		.58	6 $\frac{1}{8}$		1.470		.93	11 $\frac{1}{8}$	2.986				
.24		2 $\frac{1}{4}$.392		.59	7 $\frac{1}{16}$		1.509		.94	11 $\frac{1}{4}$	3.035				
.25		3		.416		.60	7 $\frac{1}{8}$		1.547		.95	11 $\frac{3}{8}$	3.083				
.26		3 $\frac{1}{4}$.442		.61	7 $\frac{1}{4}$		1.586		.96	11 $\frac{1}{2}$	3.132				
.27		3 $\frac{1}{2}$.467		.62	7 $\frac{1}{2}$		1.626		.97	11 $\frac{3}{4}$	3.181				
.28		3 $\frac{3}{4}$.493		.63	7 $\frac{3}{8}$		1.665		.98	11 $\frac{3}{4}$	3.230				
.29		3 $\frac{1}{2}$.520		.64	7 $\frac{1}{2}$		1.705		.99	11 $\frac{5}{8}$	3.280				
.30		3 $\frac{5}{8}$.547		.65	7 $\frac{3}{4}$		1.745	1	00	12	3.300				
.31		3 $\frac{3}{4}$.575		.66	7 $\frac{5}{8}$		1.785	1	01	12 $\frac{1}{8}$	3.380				
.32		3 $\frac{1}{2}$.603		.67	8 $\frac{1}{16}$		1.826	1	02	12 $\frac{1}{4}$	3.430				
.33		3 $\frac{1}{2}$.631		.68	8 $\frac{1}{8}$		1.867	1	03	12 $\frac{1}{2}$	3.481				
.34		4 $\frac{1}{16}$.660		.69	8 $\frac{1}{4}$		1.908	1	04	12 $\frac{1}{2}$	3.532				
.35		4 $\frac{1}{8}$.689		.70	8 $\frac{3}{8}$		1.950	1	05	12 $\frac{3}{8}$	3.583				
.36		4 $\frac{1}{8}$.719		.71	8 $\frac{1}{2}$		1.992	1	06	12 $\frac{3}{4}$	3.634				
.37		4 $\frac{1}{4}$.749		.72	8 $\frac{3}{4}$		2.034	1	07	12 $\frac{7}{8}$	3.686				
.38		4 $\frac{1}{4}$.780		.73	8 $\frac{7}{8}$		2.070	1	08	13 $\frac{1}{16}$	3.737				
.39		4 $\frac{1}{2}$.811		.74	8 $\frac{7}{8}$		2.120	1	09	13 $\frac{1}{8}$	3.789				
.40		4 $\frac{1}{2}$.842		.75	9		2.163	1	10	13 $\frac{3}{16}$	3.842				
.41		4 $\frac{1}{2}$.874		.76	9 $\frac{1}{8}$		2.206	1	11	13 $\frac{1}{2}$	3.894				
.42		5 $\frac{1}{16}$.906		.77	9 $\frac{1}{4}$		2.250	1	12	13 $\frac{5}{16}$	3.947				
.43		5 $\frac{1}{8}$.939		.78	9 $\frac{3}{8}$		2.294	1	13	13 $\frac{9}{16}$	4.000				
.44		5 $\frac{1}{4}$.972		.79	9 $\frac{1}{2}$		2.340	1	14	13 $\frac{1}{2}$	4.053				
.45		5 $\frac{3}{8}$		1.005		.80	9 $\frac{5}{8}$		2.383	1	15	13 $\frac{3}{8}$	4.107				
.46		5 $\frac{1}{2}$		1.039		.81	9 $\frac{3}{4}$		2.428	1	16	13 $\frac{5}{8}$	4.160				
.47		5 $\frac{3}{4}$		1.073		.82	9 $\frac{7}{8}$		2.473	1	17	14 $\frac{1}{16}$	4.214				
.48		5 $\frac{3}{4}$		1.107		.83	9 $\frac{1}{2}$		2.520	1	18	14 $\frac{1}{8}$	4.268				
.49		5 $\frac{7}{8}$		1.142		.84	10 $\frac{1}{16}$		2.564	1	19	14 $\frac{1}{4}$	4.323				
.50		6		1.177		.85	10 $\frac{1}{8}$		2.610	1	20	14 $\frac{3}{8}$	4.377				
.51		6 $\frac{1}{4}$		1.213		.86	10 $\frac{3}{8}$		2.660	1	21	14 $\frac{1}{2}$	4.432				
.52		6 $\frac{1}{2}$		1.249		.87	10 $\frac{1}{2}$		2.702	1	22	14 $\frac{3}{4}$	4.487				
.53		6 $\frac{3}{4}$		1.285		.88	10 $\frac{3}{4}$		2.749	1	23	14 $\frac{7}{8}$	4.543				
.54		6 $\frac{3}{4}$		1.321		.89	10 $\frac{7}{8}$		2.796	1	24	14 $\frac{7}{8}$	4.598				

hence the discharge per foot of measured length is $1.005 \times 0.91 = 0.9145$ c.f.s.*

An Italian engineer named Cipolletti long ago designed a trapezoidal weir with complete contractions in which the discharge is believed to be directly proportioned to the length of weir crest. For irrigation pur-

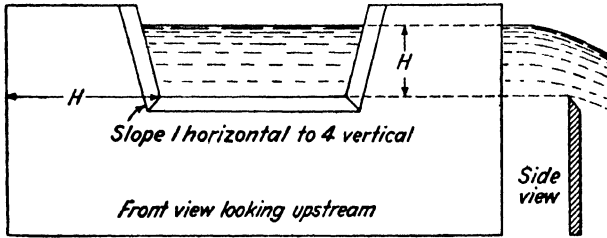

FIG. 15. — A trapezoidal, or Cipolletti weir.

poses this weir has some advantages. It has been widely used. The equation giving the discharge is:

$$q = 3.3^{3/4} LH^{3/2} \dots \dots \dots (21)$$

In this weir the sides have a slope of 1 inch horizontal to 4 inches vertical, as shown in Fig. 15. Aside from the small correction necessary on account of the fact that the sides of the weir slope outward, equation (21)

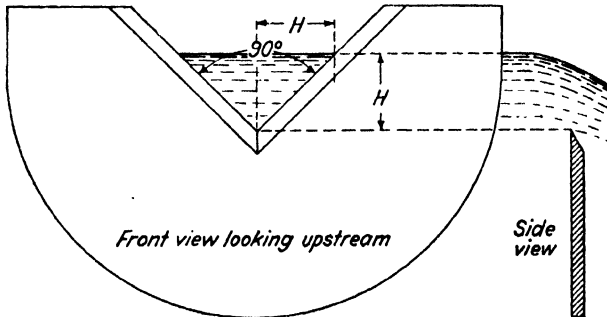

FIG. 16. — A 90°-notch triangular weir.

may be arrived at in the same way as equation (19). Table III gives discharges for the trapezoidal weir as computed from equation (21) for length of crest from 1 to 18 feet.

For the 90°-notch triangular weir shown in Fig. 16 it is evident that the water cross-section area is $H \times H$, or H^2 , and we have, therefore, from

* A very good way for the student to clarify his understanding of equation (19) is to compute discharges per foot of length for other values of H and check with Table II.

TABLE III
DISCHARGE OVER CIPOLLETTI'S TRAPEZOIDAL WEIR. FOR VARIOUS LENGTHS
AND HEADS. FORMULA: $q = 3.3\%LH^{3/2}$

Head <i>H</i> on Crest		Length of Weir Crest in Feet											
In Feet	In Inches	1	1½	2	2½	3	3½	4	5	7½	10	12½	15
Discharge in Cubic Feet per Second													
0.21	2½	0.324	0.49	0.65	0.81	0.97	1.13	1.30	1.62	2.43	3.24	4.05	4.86
.22	½	.347	.52	.69	.87	1.04	1.22	1.39	1.74	2.61	3.47	4.34	5.21
.23	¼	.371	.56	.74	.93	1.11	1.30	1.49	1.86	2.79	3.71	4.64	5.57
.24	⅓	.396	.59	.79	.99	1.19	1.39	1.58	1.98	2.97	3.96	4.95	5.94
.25	3	.421	.63	.84	1.05	1.26	1.47	1.68	2.10	3.16	4.21	5.26	6.31
.26	3½	.446	.67	.89	1.12	1.34	1.56	1.79	2.23	3.35	4.46	5.58	6.70
.27	½	.472	.71	.94	1.18	1.42	1.65	1.89	2.36	3.54	4.72	5.90	7.09
.28	⅔	.499	.75	1.00	1.25	1.50	1.75	2.00	2.49	3.74	4.99	6.24	7.48
.29	¾	.526	.79	1.05	1.31	1.58	1.84	2.10	2.63	3.94	5.26	6.57	7.89
.30	⅘	.553	.83	1.11	1.38	1.66	1.94	2.21	2.77	4.15	5.53	6.92	8.30
.31	3¾87	1.16	1.45	1.74	2.03	2.32	2.91	4.36	5.81	7.26	8.72
.32	⅞91	1.22	1.52	1.83	2.13	2.44	3.05	4.57	6.09	7.62	9.14
.33	496	1.28	1.60	1.91	2.23	2.55	3.19	4.79	6.38	7.98	9.57
.34	½	1.00	1.33	1.67	2.00	2.34	2.67	3.34	5.01	6.67	8.34	10.01
.35	¾	1.05	1.39	1.74	2.09	2.44	2.79	3.49	5.23	6.97	8.71	10.46
.36	4¼	1.09	1.45	1.82	2.18	2.56	2.91	3.64	5.45	7.27	9.09	10.91
.37	⅝	1.14	1.52	1.89	2.27	2.65	3.03	3.79	5.68	7.58	9.47	11.37
.38	⅞	1.18	1.58	1.97	2.37	2.76	3.15	3.94	5.91	7.89	9.86	11.83
.39	⅘	1.23	1.64	2.05	2.46	2.87	3.28	4.10	6.15	8.20	10.25	12.30
.40	⅙	1.28	1.70	2.13	2.56	2.98	3.41	4.26	6.39	8.52	10.65	12.78
.41	4⅞	1.33	1.77	2.21	2.65	3.09	3.54	4.42	6.63	8.84	11.05	13.26
.42	5	1.37	1.83	2.29	2.75	3.21	3.67	4.58	6.87	9.16	11.46	13.75
.43	½	1.42	1.90	2.37	2.85	3.32	3.80	4.75	7.12	9.49	11.87	14.24
.44	¾	1.47	1.97	2.46	2.95	3.44	3.93	4.91	7.37	9.83	12.28	14.74
.45	⅘	1.52	2.03	2.55	3.05	3.56	4.07	5.08	7.62	10.16	12.70	15.24
.46	5¼	1.58	2.10	2.63	3.15	3.68	4.20	5.25	7.88	10.50	13.13	15.76
.47	⅝	1.63	2.17	2.71	3.25	3.80	4.34	5.42	8.14	10.85	13.56	16.27
.48	⅞	1.68	2.24	2.80	3.36	3.92	4.48	5.60	8.40	11.20	14.00	16.79
.49	⅘	1.73	2.31	2.89	3.46	4.04	4.62	5.77	8.66	11.55	14.43	17.32
.50	6	1.79	2.38	2.98	3.57	4.17	4.76	5.95	8.93	11.90	14.88	17.85
.51	6½	1.84	2.45	3.07	3.68	4.29	4.90	6.13	9.20	12.26	15.33	18.39
.52	¾	1.89	2.52	3.16	3.79	4.42	5.05	6.31	9.47	12.62	15.78	18.94
.53	⅘	1.95	2.60	3.25	3.90	4.55	5.20	6.50	9.74	12.99	16.24	19.49
.54	⅙	2.00	2.67	3.34	4.01	4.68	5.34	6.68	10.02	13.36	16.70	20.04
.55	⅞	2.06	2.75	3.43	4.12	4.81	5.49	6.87	10.30	13.73	17.17	20.60
.56	6¾	2.12	2.82	3.53	4.23	4.94	5.64	7.05	10.58	14.11	17.64	21.16
.57	⅞	2.17	2.90	3.62	4.35	5.07	5.80	7.24	10.87	14.49	18.11	21.73
.58	7	2.23	2.97	3.72	4.46	5.20	5.95	7.44	11.15	14.87	18.59	22.31
.59	⅘	2.29	3.05	3.81	4.58	5.34	6.10	7.63	11.44	15.26	19.07	22.89
.60	¾	2.35	3.13	3.91	4.69	5.48	6.26	7.82	11.74	15.65	19.56	23.47

TABLE III (Concluded)

Head <i>H</i> on Crest		Length of Weir Crest in Feet										
In Feet	In Inches	2	2½	3	3½	4	5	7½	10	12½	15	18
Discharge in Cubic Feet per Second												
0.61	7½	3 21	4 01	4 81	5 61	6 42	8 02	12 03	16 04	20 05	24 06	28 87
.62	7½	3 29	4 11	4 93	5 75	6 57	8 22	12 33	16 44	20 54	24 65	29 58
.63	7½	3 37	4 21	5 05	5 89	6 73	8 12	12 65	16 83	21 04	25 25	30 30
.64	7½	3 45	4 31	5 17	6 03	6 89	8 62	12 93	17 24	21 55	25 86	31 03
.65	7½	3 53	4 41	5 29	6 18	7 06	8 82	13 23	17 64	22 05	26 46	31 76
.66	7½	3 61	4 51	5 42	6 32	7 22	9 03	13 54	18 05	22 56	27 08	32 49
.67	8	3 69	4 62	5 54	6 46	7 39	9 23	13 85	18 16	23 08	27 70	33 23
.68	8	3 78	4 72	5 66	6 61	7 55	9 44	14 16	18 88	23 60	28 32	33 98
.69	8	3 86	4 82	5 79	6 75	7 72	9 65	14 47	19 30	24 12	28 94	34 73
.70	8	3 94	4 93	5 92	6 90	7 89	9 86	14 79	19 72	24 65	29 58	35 49
.71	8½	4 03	5 04	6 04	7 05	8 06	10 07	15 11	20 14	25 18	30 21	36 25
.72	8½	4 11	5 14	6 17	7 20	8 23	10 28	15 43	20 57	25 71	30 85	37 03
.73	8½	4 20	5 25	6 30	7 35	8 40	10 50	15 75	21 00	26 25	31 50	37 80
.74	8½	4 29	5 36	6 43	7 50	8 57	10 72	16 07	21 43	26 79	32 15	38 58
.75	9	4 37	5 47	6 56	7 65	8 75	10 93	16 40	21 87	27 33	32 80	39 36
.76	9½	4 46	5 58	6 71	7 81	8 92	11 15	16 73	22 31	27 88	33 46	40 15
.77	9½	4 55	5 69	6 82	7 96	9 10	11 37	17 06	22 75	28 43	34 12	40 95
.78	9½	4 64	5 80	6 96	8 12	9 28	11 60	17 39	23 19	28 99	34 79	41 75
.79	9½	4 73	5 91	7 09	8 27	9 46	11 82	17 73	23 64	29 55	35 46	42 55
.80	9½	4 82	6 02	7 23	8 43	9 64	12 05	18 07	24 09	30 11	36 13	43 36
.81	9½	4 91	6 14	7 36	8 59	9 82	12 27	18 41	24 54	30 68	36 81	44 18
.82	10	5 00	6 25	7 50	8 75	10 00	12 50	18 75	25 00	31 25	37 50	45 00
.83	10	5 09	6 36	7 64	8 91	10 18	12 73	19 09	25 46	31 82	38 19	45 82
.84	10	5 18	6 48	7 78	9 07	10 37	12 96	19 44	25 92	32 40	38 88	46 65
.85	10	5 28	6 60	7 92	9 23	10 55	13 19	19 79	26 38	32 98	39 57	47 40
.86	10½	5 37	6 71	8 06	9 40	10 74	13 43	20 14	26 85	33 56	40 28	48 33
.87	10½	5 46	6 83	8 20	9 56	10 93	13 66	20 49	27 32	34 15	40 97	49 13
.88	10½	5 56	6 95	8 34	9 73	11 12	13 90	20 84	27 79	34 74	41 69	50 03
.89	10½	5 65	7 07	8 48	9 89	11 31	14 13	21 20	28 27	35 33	42 40	50 88
.90	10½	5 75	7 19	8 62	10 06	11 50	14 37	21 56	28 75	35 93	43 12	51 74
.91	10½	7 31	8 77	10 23	11 69	14 61	21 92	29 23	36 53	43 84	52.61
.92	11	7 43	8 91	10 40	11 88	14 85	22 28	29 71	37 14	44 50	53 48
.93	11	7 55	9 06	10 57	12 08	15 10	22.65	30 19	37 74	45 29	54 35
.94	11	7 67	9 20	10 74	12 27	15 34	23 01	30 68	38 35	46 02	55 23
.95	11	7.79	9 35	10 91	12 47	15 59	23.38	31 17	38.97	46.76	56 11
.96	11½	7.92	9 50	11 08	12 67	15 83	23 75	31 67	39 58	47.50	57.00
.97	11½	8 04	9 65	11 26	12 87	16 08	24 12	32.16	40 20	48 24	57 89
.98	11½	8 17	9 80	11 43	13 06	16 33	24 49	32 66	40 83	48 99	58.79
.99	11½	8 29	9 95	11 61	13 27	16 58	24 87	33 16	41 45	49 74	59 69
1 00	12	8.42	10 10	11 78	13 47	16 83	25 25	33.67	42.08	50.50	60.60

equation (15) $q = H^2 \sqrt{2g} \sqrt{h} = CH^{3/2}$ as the theoretical discharge. The actual discharge has been found by experiment to be approximately

$$q = 2.49H^{3/2} \dots \dots \dots (22)$$

Table IV gives discharges for the triangular weir.

TABLE IV
DISCHARGE TABLE FOR 90°-NOTCH TRIANGULAR WEIR*

Head in Feet	Head in Inches	Discharge in Second-feet (q)	Head in Feet	Head in Inches	Discharge in Second-feet (q)	Head in Feet	Head in Inches	Discharge in Second-feet (q)
0.20	2 ³ / ₈	0.046	0.55	6 ⁵ / ₈	0.561	0.90	10 ¹³ / ₁₆	1.92
.21	2 ¹ / ₂	.052	.56	6 ¹ / ₂	.590	.91	10 ¹ / ₂	1.97
.22	2 ⁵ / ₈	.058	.57	6 ³ / ₈	.617	.92	11 ¹ / ₁₆	2.02
.23	2 ⁴ / ₄	.065	.58	6 ¹ / ₆	.644	.93	11 ³ / ₁₆	2.08
.24	2 ⁷ / ₈	.072	.59	7 ¹ / ₆	.672	.94	11 ¹ / ₂	2.13
.25	3	.080	.60	7 ³ / ₆	.700	.95	11 ³ / ₈	2.19
.26	3 ¹ / ₆	.088	.61	7 ⁵ / ₆	.730	.96	11 ⁵ / ₈	2.25
.27	3 ¹ / ₄	.096	.62	7 ⁷ / ₆	.760	.97	11 ⁵ / ₆	2.31
.28	3 ³ / ₈	.106	.63	7 ⁹ / ₆	.790	.98	11 ³ / ₄	2.37
.29	3 ¹ / ₂	.115	.64	7 ¹ / ₆	.822	.99	11 ⁷ / ₆	2.43
.30	3 ⁵ / ₈	.125	.65	7 ³ / ₄	.854	1.00	12	2.49
.31	3 ³ / ₄	.136	.66	7 ⁵ / ₆	.887	1.01	12 ¹ / ₈	2.55
.32	3 ¹ / ₂	.147	.67	8 ¹ / ₆	.921	1.02	12 ¹ / ₄	2.61
.33	3 ¹ / ₆	.159	.68	8 ³ / ₆	.955	1.03	12 ³ / ₈	2.68
.34	4 ¹ / ₁₆	.171	.69	8 ¹ / ₂	.991	1.04	12 ¹ / ₂	2.74
.35	4 ³ / ₁₆	.184	.70	8 ³ / ₈	1.03	1.05	12 ³ / ₈	2.81
.36	4 ⁵ / ₁₆	.197	.71	8 ⁵ / ₈	1.06	1.06	12 ³ / ₄	2.87
.37	4 ⁷ / ₁₆	.211	.72	8 ⁷ / ₈	1.10	1.07	12 ¹ / ₆	2.94
.38	4 ⁹ / ₁₆	.226	.73	8 ¹ / ₆	1.14	1.08	12 ¹ / ₄	3.01
.39	4 ¹¹ / ₁₆	.240	.74	8 ⁷ / ₈	1.18	1.09	13 ¹ / ₁₆	3.08
.40	4 ¹³ / ₁₆	.256	.75	9	1.22	1.10	13 ³ / ₁₆	3.15
.41	4 ¹⁵ / ₁₆	.272	.76	9 ¹ / ₆	1.26	1.11	13 ⁵ / ₁₆	3.22
.42	5 ¹ / ₁₆	.289	.77	9 ¹ / ₄	1.30	1.12	13 ⁷ / ₁₆	3.30
.43	5 ³ / ₁₆	.306	.78	9 ³ / ₈	1.34	1.13	13 ⁹ / ₁₆	3.37
.44	5 ¹ / ₄	.324	.79	9 ⁵ / ₈	1.39	1.14	13 ¹ / ₂	3.44
.45	5 ⁵ / ₈	.343	.80	9 ⁵ / ₄	1.43	1.15	13 ¹ / ₆	3.52
.46	5 ¹ / ₂	.362	.81	9 ⁷ / ₈	1.48	1.16	13 ¹ / ₄	3.59
.47	5 ⁵ / ₈	.382	.82	9 ³ / ₆	1.52	1.17	14 ¹ / ₁₆	3.67
.48	5 ³ / ₄	.403	.83	9 ¹ / ₆	1.57	1.18	14 ³ / ₁₆	3.75
.49	5 ⁷ / ₈	.424	.84	10 ¹ / ₆	1.61	1.19	14 ¹ / ₂	3.83
.50	6	.445	.85	10 ³ / ₆	1.66	1.20	14 ³ / ₈	3.91
.51	6 ¹ / ₈	.468	.86	10 ⁵ / ₆	1.71	1.21	14 ⁵ / ₈	3.99
.52	6 ¹ / ₄	.491	.87	10 ⁷ / ₆	1.76	1.22	14 ⁵ / ₆	4.07
.53	6 ³ / ₈	.515	.88	10 ⁹ / ₆	1.81	1.23	14 ³ / ₄	4.16
.54	6 ³ / ₄	.539	.89	10 ¹ / ₂	1.86	1.24	14 ⁷ / ₈	4.24
						1.25	15	4.33

Computed from the formula: $q = 2.49H^{2.48}$.

40. Submerged Orifices.— Examining a sketch of a submerged orifice, Fig. 17, it is evident that the water cross-section area is the length of the opening times the height of the opening, or $A = l \times H$. The height through which the water falls as it passes through a submerged orifice is the difference in elevation of the water surface upstream and downstream, as shown by h in Fig. 17. Hence, from equation (16) and from experiments, the discharge for the standard submerged orifice is found to be:

$$q = \frac{6.1}{100} lH \sqrt{2g} \sqrt{h} \dots \dots \dots (23)$$

The submerged orifice is now used both in its standard form and as a combination with a headgate. Table V gives discharges for submerged orifices as computed from equation (23). It shows, for example, that,

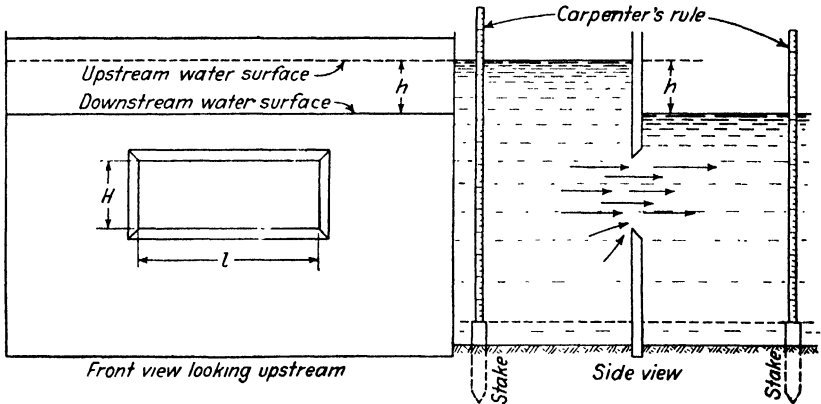

FIG. 17. — Submerged orifice.

on a submerged orifice having an opening 6 inches high by 12 inches long (area 0.5 square foot), if the upstream water surface is 3 inches or 0.25 foot higher than the downstream surface, the discharge will be 1.22 c.f.s.

41. Properties of Weirs and Orifices.— It is important to note the influence that change of depth of water, H , has on the discharge, q , for the various weirs and orifices. For example, when the stream over a rectangular weir increases till the depth H is doubled, the cross-section area, A , is doubled, and the discharge increased by 2.8 times; whereas doubling H over a trapezoidal weir slightly more than doubles the area and increases the discharge proportionally. When the H on a triangular weir is doubled, the A (area) is increased 4 times, and the discharge is increased 5.66 times, nearly. When the head of water, h , causing

TABLE V
DISCHARGE TABLE FOR SUBMERGED RECTANGULAR ORIFICES*

Head <i>H</i>		Cross-sectional Area <i>A</i> of Orifice, square feet							
Feet	Inches	0.25	0.50	0.75	1.00	1.25	1.50	1.75	2.00
0.09	1 ¹ / ₁₆	0.37	0.73	1.10	1.47	1.84	2.20	2.64	2.94
.10	1 ¹ / ₈	.39	.77	1.16	1.56	1.93	2.32	2.71	3.09
.11	1 ³ / ₁₆	.41	.81	1.22	1.62	2.03	2.43	2.84	3.24
.12	1 ¹ / ₄	.42	.85	1.27	1.69	2.12	2.54	2.97	3.39
.13	1 ⁵ / ₁₆	.44	.88	1.32	1.76	2.21	2.65	3.09	3.53
.14	1 ³ / ₄	.46	.92	1.37	1.83	2.29	2.75	3.20	3.66
.15	1 ⁷ / ₈	.47	.95	1.42	1.90	2.37	2.84	3.32	3.79
.16	1 ⁹ / ₁₆	.49	.98	1.47	1.96	2.45	2.93	3.42	3.91
.17	2 ¹ / ₁₆	.50	1.01	1.51	2.02	2.52	3.02	3.53	4.03
.18	2 ³ / ₁₆	.52	1.04	1.56	2.08	2.59	3.11	3.63	4.15
.19	2 ¹ / ₄	.53	1.07	1.60	2.13	2.67	3.20	3.73	4.26
.20	2 ³ / ₈	.55	1.09	1.64	2.19	2.74	3.28	3.83	4.36
.21	2 ⁵ / ₁₆	.56	1.12	1.68	2.24	2.80	3.36	3.92	4.48
.22	2 ³ / ₄	.57	1.15	1.72	2.30	2.87	3.46	4.02	4.59
.23	2 ⁷ / ₁₆	.59	1.17	1.76	2.35	2.93	3.52	4.10	4.69
.24	2 ⁵ / ₈	.60	1.20	1.80	2.40	3.00	3.60	4.19	4.79
.25	3	.61	1.22	1.83	2.45	3.06	3.67	4.28	4.89
.26	3 ¹ / ₁₆	.62	1.25	1.87	2.49	3.12	3.74	4.37	4.99
.27	3 ³ / ₁₆	.64	1.27	1.91	2.54	3.18	3.81	4.45	5.08
.28	3 ¹ / ₄	.65	1.29	1.94	2.59	3.24	3.88	4.53	5.18
.29	3 ³ / ₈	.66	1.32	1.98	2.64	3.30	3.96	4.62	5.28
.30	3 ⁵ / ₁₆	.67	1.34	2.01	2.68	3.35	4.02	4.69	5.36
.31	3 ³ / ₄	.68	1.36	2.05	2.73	3.41	4.09	4.77	5.45
.32	3 ⁷ / ₁₆	.69	1.38	2.07	2.76	3.46	4.15	4.84	5.53
.33	3 ⁵ / ₈	.70	1.41	2.11	2.81	3.51	4.22	4.92	5.62
.34	4 ¹ / ₁₆	.71	1.43	2.14	2.85	3.57	4.28	4.99	5.70
.35	4 ³ / ₁₆	.72	1.45	2.17	2.89	3.62	4.34	5.06	5.78
.36	4 ¹ / ₄	.73	1.47	2.20	2.93	3.67	4.40	5.14	5.87
.37	4 ³ / ₈	.75	1.49	2.23	2.98	3.72	4.46	5.21	5.95
.38	4 ⁵ / ₁₆	.75	1.51	2.26	3.02	3.77	4.52	5.28	6.03
.39	4 ³ / ₄	.76	1.53	2.29	3.05	3.82	4.58	5.35	6.11
.40	4 ⁷ / ₁₆	.77	1.55	2.32	3.09	3.87	4.64	5.42	6.19
.41	4 ⁵ / ₈	.78	1.57	2.35	3.12	3.92	4.70	5.48	6.27
.42	4 ³ / ₂	.79	1.59	2.38	3.17	3.96	4.75	5.55	6.34
.43	5 ¹ / ₁₆	.80	1.60	2.41	3.21	4.01	4.81	5.61	6.42
.44	5 ³ / ₁₆	.81	1.62	2.43	3.24	4.06	4.87	5.68	6.49
.45	5 ¹ / ₄	.82	1.64	2.46	3.28	4.10	4.92	5.74	6.56
.46	5 ³ / ₈	.83	1.66	2.49	3.32	4.15	4.98	5.81	6.64
.47	5 ⁵ / ₁₆	.84	1.68	2.52	3.36	4.20	5.04	5.87	6.71
.48	5 ³ / ₄	.85	1.70	2.54	3.39	4.24	5.08	5.93	6.78
.49	5 ⁷ / ₁₆	.86	1.71	2.57	3.42	4.28	5.14	5.99	6.85
.50	6	.87	1.73	2.59	3.46	4.32	5.19	6.05	6.92
.51	6 ¹ / ₁₆	.87	1.75	2.62	3.49	4.37	5.24	6.11	6.99
.52	6 ³ / ₁₆	.88	1.76	2.65	3.53	4.41	5.29	6.17	7.05
.53	6 ¹ / ₄	.89	1.78	2.67	3.56	4.45	5.34	6.23	7.12
.54	6 ³ / ₈	.90	1.80	2.70	3.59	4.49	5.39	6.29	7.19
.55	6 ⁵ / ₁₆	.91	1.81	2.72	3.63	4.53	5.44	6.35	7.25
.56	6 ³ / ₄	.92	1.83	2.75	3.66	4.58	5.49	6.41	7.32
.57	6 ⁷ / ₁₆	.92	1.85	2.77	3.69	4.62	5.54	6.46	7.38
.58	6 ⁵ / ₈	.93	1.86	2.79	3.73	4.66	5.59	6.52	7.45
.59	7 ¹ / ₁₆	.94	1.88	2.82	3.76	4.70	5.64	6.58	7.51

* Computed from the formula: $q = 0.61 A \sqrt{2g} \sqrt{H}$.

the discharge through a submerged orifice, is doubled, the area remains unchanged and the discharge, q , is made only 1.4 times the original discharge. Comparisons similar to the above may readily be made for any change in depth by remembering that the discharge, q , varies with the three-halves power of the depth, H , for the rectangular and trapezoidal weirs, with the five-halves power approximately for the triangular

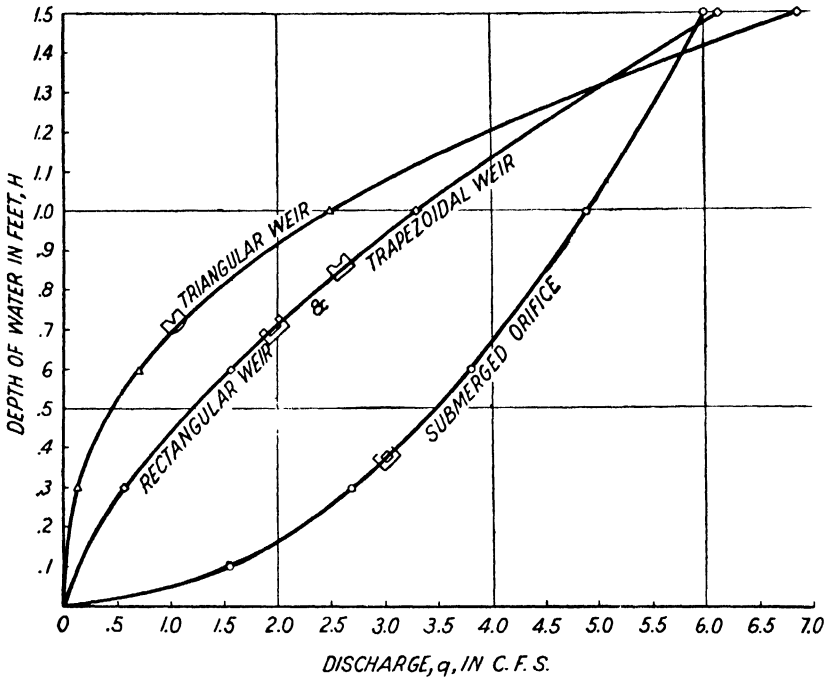

FIG. 18. — Curves showing the relation between the discharge of water in c.f.s. and the depth of water on the weir crest in feet for a 1-foot rectangular weir with suppressed end contractions, a 1-foot trapezoidal weir, a 90°-notch triangular weir, and a submerged orifice of one square foot cross-section area.

weir, and with the one-half power of the head, h , for a submerged orifice. The variations of discharge with depth of H have a very important bearing on irrigation practice and should be clearly understood by men in charge of water distribution.

In order to illustrate further the influence of change of depth on the discharge, the curves of Fig. 18 are presented. The above relations may be confirmed by examination of these curves, and of Tables II to V.

42. Advantages and Disadvantages of Weirs. — The advantages of weirs for water measurement are: (1) accuracy, (2) simplicity and ease

of construction, (3) non-obstruction of moss or floating materials, and (4) durability.

The disadvantages of weirs are: (1) the requirement of considerable fall of the water surface, or loss in head, which makes their use in sections having level land impracticable, and (2) the collection of gravel, sand, and silt above the weir, which prevents accuracy of measurement.

The greatest advantage in the use of submerged orifices is found in relatively level sections where it is difficult to obtain fall enough to

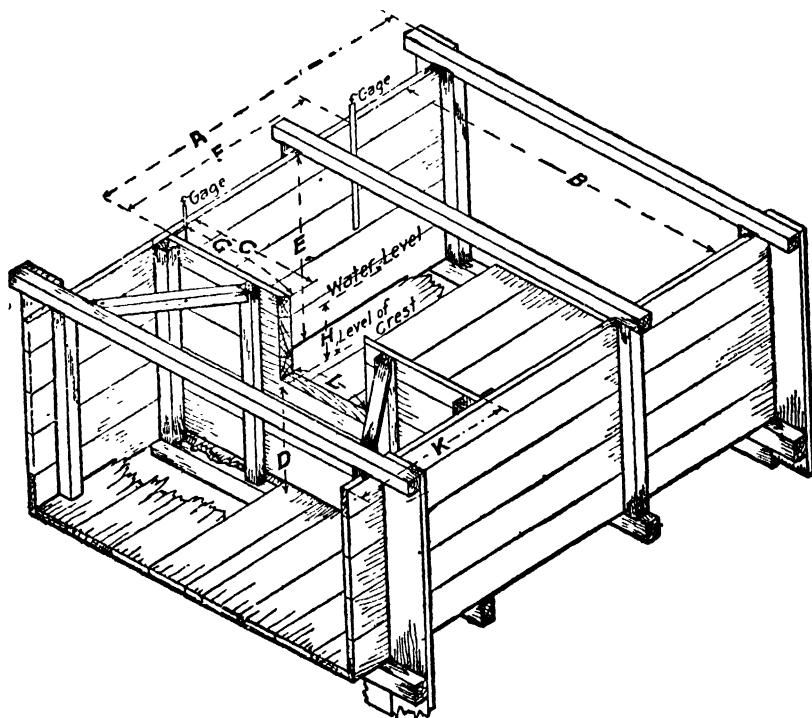

FIG. 19. — Plan of weir box. (U. S. Dept. Agr. Farmers' Bul. 813.)

use weir measurements. Orifices have in addition the advantages above enumerated for weirs.

The more serious disadvantages are: (1) collecting of floating débris, and (2) collecting of sand and silt above the orifice, and thus preventing accurate measurement.

43. Weir Box and Pond. — In the use of either of the weirs above described, the ditch or canal must be made wider and deeper than the average section of the canal for some distance upstream from the weir. This is to make the water approach the weir at a low velocity (usually

less than 0.5 foot per second) by flowing through a relatively large channel. The enlarged section of the ditch should be gradually tapered to the natural size. Cross currents just upstream from the weir must be prevented. This may be done by placing baffle boards across the weir channel.

The weir may be placed in a weir box built of lumber or concrete, as shown in Fig. 19, or it may simply be placed in an enlargement of the ditch, as shown in Fig. 20.

Less room is required when a box is used, but cleaning is made more difficult. For temporary use, the placing of a weir in the open ditch as in Fig. 20 is the more economical method.

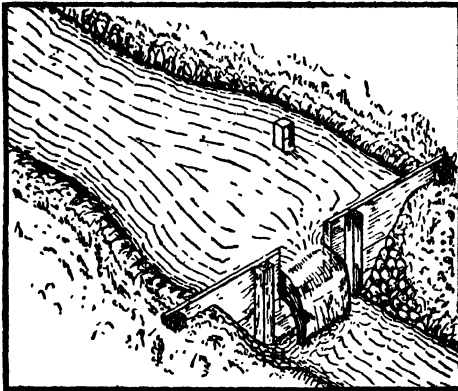

FIG. 20 — Weir notch and bulkhead in weir pond.
(U. S. Dept. Agr. Farmers' Bul. 813.)

Cleaning is also less expensive in the open ditch, as a scraper may be used. The ditch downstream must be protected with loose rock or other material to prevent washing by the falling water.

Table VI taken from Farmers' Bulletin 813 gives the sizes of weirs best adapted to measuring streams of water varying from $\frac{1}{2}$ to 22 c.f.s., and also the proper dimensions for each size of rectangular, trapezoidal, and 90°-notch triangular weirs.

The weir dimensions in Table VI illustrated in Fig. 19 are a little smaller than what would be necessary to obtain rigid accuracy, but boxes of these sizes will give results within 1 per cent of the correct values.

For temporary wooden weirs, the wood of which the weir is constructed may well be used to form also the weir crest and sides. However, since wood warps easily and the sharp edges become worn and splintered, its use on permanent weirs for crests and sides is seldom desirable without some kind of metal lining.

Clyde has brought together the following rules for setting and operating weirs:

**GENERAL REQUIREMENTS FOR PROPER SETTING AND
OPERATING WEIRS**

(1) The weir should be set at the lower end of a long pool sufficiently wide and deep to give an even, smooth current with a velocity of approach of not over 0.5 foot per second, which means practically still water.

(2) The center line of the weir box should be parallel with the direction of the flow.

(3) The face of the weir should be perpendicular, i.e., leaning neither upstream nor downstream.

TABLE VI

WEIR-BOX DIMENSIONS FOR RECTANGULAR, CIPOLLETTI, AND 90°-NOTCH
TRIANGULAR WEIRS

(All dimensions are in feet. The letters at the heads of the columns in this table refer to Fig. 19.)

Rectangular and Trapezoidal Weirs with End Contractions

Flow (Second- feet)	H Maximum Head	L Length of Weir Crest	A Length of Box Above Weir Notch	K Length of Box Below Weir Notch	B Total Width of Box	E Total Depth of Box	C End of Crest to Side	D Crest to Bottom	F Hook Gage Distance Upstream	G Hook Gage Distance Across Stream
$\frac{1}{2}$ to 3	1.0	1	6	2	$5\frac{1}{2}$	$3\frac{1}{2}$	$2\frac{1}{4}$	2	4	2
2 to 5	1.1	$1\frac{1}{2}$	7	3	7	4	$2\frac{3}{4}$	$2\frac{1}{2}$	$4\frac{1}{3}$	$2\frac{1}{2}$
4 to 8	1.2	2	8	4	$8\frac{1}{2}$	$4\frac{1}{2}$	$3\frac{1}{4}$	$2\frac{3}{4}$	5	$2\frac{2}{3}$
6 to 14	1.3	3	9	5	12	5	$4\frac{1}{2}$	$3\frac{1}{4}$	$5\frac{1}{2}$	3
10 to 22	1.5	4	10	6	14	$5\frac{1}{2}$	5	$3\frac{1}{2}$	6	3

90°-Notch Triangular Weir

$\frac{1}{2}$ to $2\frac{1}{2}$	1.00	..	6	2	5	3	$2\frac{1}{2}$	$1\frac{1}{2}$	4	2
2 to $4\frac{1}{2}$	1.25	..	$6\frac{1}{2}$	$8\frac{1}{2}$	$6\frac{1}{2}$	$3\frac{1}{4}$	$3\frac{1}{4}$	$1\frac{1}{2}$	5	$2\frac{1}{2}$

(4) The crest of the weir should be level so the water passing over it will be of the same depth at all points along the crest and sharp-crested so that the over-falling water touches the crest at only one point.

(5) The distance of the crest above the bottom of the pool should be about 3 times the depth of water flowing over the weir crest; the sides of the pool should be at a distance from the sides of the crest not less than twice the depth of the water passing over the crest.

(6) The gage or weir scale may be placed on the upstream face of the weir structure and far enough to one side so that it will be in comparatively still water, as shown in Fig. 19, or it may be placed at any point in the weir pond or box, so long as it is sufficiently above the weir to be free from the downward curve of the water as it passes over the weir crest. The zero of the weir scale or gage should be placed level with the weir crest. This may be done with an ordinary carpenter's level, or where greater refinement is desired, with an engineer's level.

(7) The crest should be placed high enough so the water will fall freely below the weir, leaving an air space under the over-falling sheet of water. If the water below the weir rises above the crest this free fall is not possible, and the weir is then said to be submerged. Unless complicated corrections are made, measurements on submerged weirs are unreliable.

(8) For accurate measurements the depth over the crest should be no more than one-third the length of the crest.

(9) The depth of water over the crest should be no less than 2 inches, as it is difficult with smaller depths to get sufficiently accurate gage readings to give close results.

(10) To prevent washing by the falling water the ditch downstream from the weir should be protected by loose rock or by other material.

There are notable differences in opinion among irrigation authorities concerning the accuracy of the different weir formulae and the suitability of different water-measuring devices. The reader who desires further information concerning weirs, especially for precise measurements of water, should consult some of the references given at the end of the chapter.

44. Measurement of Head or Depth on Weir Crest. — The measurement of the head or depth of water on the weir crest is obtained with a specially constructed scale or a carpenter's rule. The special scale, called the weir gage, must be set upstream above the bulkhead a distance no less than 4 times the depth of the water, H , flowing over the crest. This is made necessary by the downward curvature of the water surface near the crest. A scale marked off into feet, tenths, and hundredths of a foot on hard wood is satisfactory. The zero point on the scale must be set level with the crest of the rectangular or trapezoidal weir, or with the vertex of the triangular weir. If an open weir pond of sufficient width is used, the scale, or a lug upon which to place a rule, may be fastened to the bulkhead at a lateral distance from the end of the notch of not less than twice the greatest depth of water H over the crest. To get the zero point of the scale or the lug level with the crest, a carpenter's level may be used. Allowing the water to flow into the

pond and slowly rise till it flows over the weir crest is inaccurate since the water surface will rise appreciably above the crest before flow over the crest begins. Small errors in reading H cause relatively large errors in the discharge determination. To show the error in measurement caused by an error in reading of only 0.01 foot, or less than $\frac{1}{8}$ inch, Table VII, after Cone, is presented below.

TABLE VII
PERCENTAGE OF ERROR IN DISCHARGE OVER WEIRS CAUSED BY 0.01 FOOT
ERROR IN READING THE HEAD

Head		Length of Weir Crest					90° Notch
Feet	Feet Inches	Per cent 1 Foot	Per cent 1.5 Feet	Per cent 2 Feet	Per cent 3 Feet	Per cent 4 Feet	Per cent
0.20	0 2 $\frac{3}{8}$	7.2	7.5	7.5	7.6	7.6	.
.30	0 3 $\frac{5}{8}$	5.0	5.1	5.1	5.6	4.8	8.5
.50	0 6	3.5	3.2	3.0	2.9	2.9	5.0
.70	0 8 $\frac{3}{8}$	2.1	1.9	2.1	2.2	2.2	3.9
.90	0 10 $\frac{1}{2}$	1.8	1.8	1.8	1.7	1.7	2.9
1.10	1 1 $\frac{1}{2}$		1.4	1.3	1.3	1.3	2.2
1.25	1 3				1.1	1.1	2.1
1.50	1 6				0.9	1.0	.

45. Portable Weirs. — It is frequently desirable to make occasional measurements of small streams at points where the cost of the installation of permanent weirs would not be warranted. For example, the occasional measurement of surface run-off from various fields, though desirable, would hardly warrant the installation of a permanent weir. In cases of this kind, a small steel plate cut like a half circle and having a weir notch as illustrated in Fig. 21 serves well. The notch may be cut as a rectangle, trapezoid, or triangle, depending on the type of weir desired.

Portable weirs are easily installed in ditches having sandy loam, loam, or clay loam bottoms and sides. Usually, in soils of these types, it is possible to drive the weir plate into the soil with a heavy hammer or an ax. It is necessary to use a carpenter's level to avoid getting one end of the weir crest higher than the other. The depth of water flowing over the weir crest, or head, is measured by placing the end of a rule on a lug made for this purpose, as indicated in Fig. 21.

46. Weirs without End Contractions. — A standard rectangular weir without end contractions consists of a wall having a sharp crest built across a rectangular channel, high enough to cause a complete deflection of water filaments as the stream passes over the weir. The

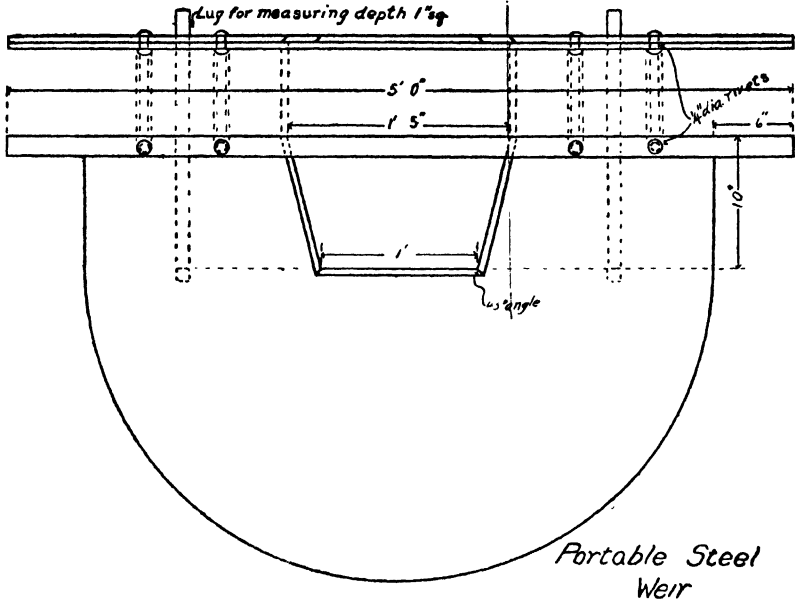

Fig. 21: — Portable steel weir. (Utah Agr. Exp. Sta. Circular 36.)

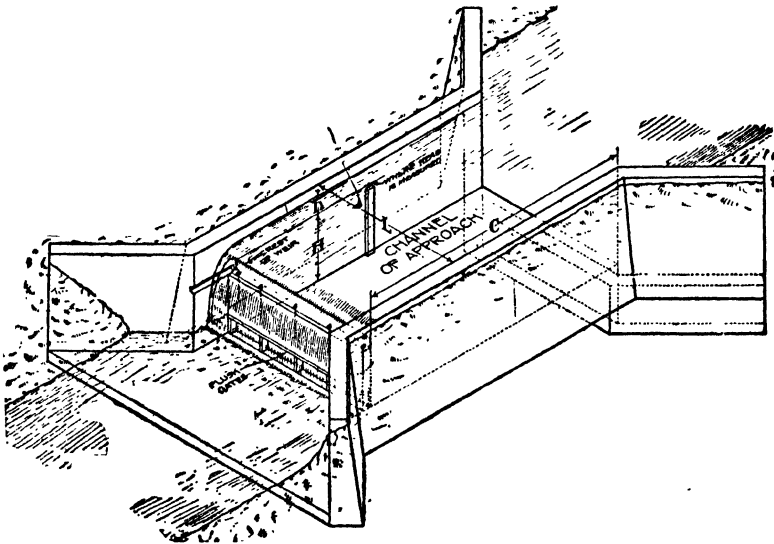

Fig. 22. — The Lyman rectangular weir without end contractions. (Utah Agr. Exp. Sta. Circular 36.)

conditions for accuracy are the same as for the standard rectangular weir with contractions, except for those relating to side contractions. This type of weir can be used only in channels having a uniform rectangular cross-section. Air holes must be made through the weir box just below the weir crest so as to fully admit air under the sheet of overfalling water.

The rectangular weir without end contractions as improved by Lyman is illustrated in Fig. 22. Extensive experiments on the discharges of the Lyman rectangular weirs with suppressed end contractions have given discharge tables of greater accuracy, particularly for weirs of different heights. Table VIII gives discharges per foot of length for weirs ranging from 0.5 foot to 3 feet in height. It shows that, for any given depth of water over the crest, the discharge decreases as the height of weir increases.

46a. Clausen-Pierce Weir Rule. — A new, simple, inexpensive method of using weirs of various types for measuring irrigation water has recently been developed by Clausen and Pierce of the Salt River Project, Arizona. This method is adapted to the measurement of widely varying discharges ranging from less than one c.f.s. to several thousand c.f.s. Confronted with the problem of measuring the water delivered to a large number of irrigators, the designers of the device used in the new method have aimed to simplify the general requirements for properly setting and operating weirs, as given in Article 43. Special attention has been given to items (1) and (7) of Article 43 relating to velocity of approach and to submergence of weirs.

The new system consists of the use of a light, graduated, extensible rod, with a piezometer on the back; measurements being made with the rod held directly on the weir crest, without allowance for velocity of approach, height of weir, or variations above and below the weir.

The measuring rod is so designed as to include the influence of velocity of approach for free-flowing (non-submerged) weirs, the discharge per inch of length of weir crest being read directly on the front face of the rod. The discharge over submerged weirs is obtained by use of the extensible feature and the piezometer of the rod in two simple operations.

Two major accomplishments of the new device, according to its designers, are:

(1) The necessity for expensive special structures in canals and ditches is eliminated, nothing being required but a rectangular section through which the stream may be made to pass.

(2) The submerged weir is brought within the scope of practical field use without the necessity for careful determination of heads or velocities, or of relatively complicated computations, providing a simple and de-

TABLE VIII
DISCHARGE TABLES FOR ONE FOOT OF LENGTH OF LYMAN'S RECTANGULAR WEIR

Head in Feet	Head in Inches	Weir 0.5 Ft. High	Weir 0.75 Ft. High	Weir 1 Ft. High	Weir 1.5 Ft. High	Weir 2 Ft. High	Weir 3 Ft. High
0.20	2 ¹ / ₂	0.32	0.31	0.31	0.31	0.31	0.31
.21	2 ¹ / ₈	.31	.31	.31	.31	.33	.33
.22	2 ¹ / ₄	.37	.36	.36	.36	.36	.36
.23	2 ³ / ₈	.39	.39	.39	.38	.38	.38
.24	2 ¹ / ₂	.42	.42	.41	.41	.41	.41
.25	3	.45	.44	.44	.44	.43	.43
.26	3 ¹ / ₈	.48	.47	.47	.48	.46	.46
.27	3 ¹ / ₄	.50	.50	.49	.49	.49	.48
.28	3 ³ / ₈	.53	.52	.52	.51	.51	.51
.29	3 ¹ / ₂	.56	.55	.55	.54	.54	.54
.30	3 ⁵ / ₈	.60	.58	.58	.57	.57	.56
.31	3 ¹ / ₂	.63	.61	.61	.60	.60	.59
.32	3 ⁵ / ₄	.66	.65	.64	.63	.63	.62
.33	3 ⁵ / ₈	.69	.67	.67	.66	.65	.65
.34	4 ¹ / ₁₆	.72	.71	.70	.69	.68	.68
.35	4 ³ / ₁₆	.76	.74	.73	.72	.71	.71
.36	4 ⁵ / ₁₆	.79	.77	.76	.75	.75	.74
.37	4 ⁷ / ₁₆	.82	.80	.79	.78	.78	.77
.38	4 ⁹ / ₁₆	.86	.84	.83	.81	.81	.80
.39	4 ¹ / ₂	.90	.87	.86	.85	.84	.83
.40	4 ¹ / ₄	.93	.91	.89	.88	.87	.86
.41	4 ³ / ₈	.97	.94	.93	.91	.90	.90
.42	5 ¹ / ₁₆	1.01	.98	.96	.94	.94	.92
.43	5 ¹ / ₈	1.05	1.01	1.00	.98	.97	.96
.44	5 ¹ / ₄	1.08	1.05	1.03	1.01	1.00	.99
.45	5 ³ / ₈	1.12	1.08	1.06	1.04	1.03	1.02
.46	5 ¹ / ₂	1.16	1.13	1.11	1.09	1.07	1.06
.47	5 ⁵ / ₈	1.21	1.16	1.14	1.12	1.11	1.10
.48	5 ³ / ₄	1.25	1.21	1.19	1.16	1.15	1.13
.49	5 ⁷ / ₈	1.29	1.25	1.22	1.20	1.18	1.17
.50	6	1.34	1.29	1.26	1.24	1.22	1.20
.51	6 ¹ / ₈	1.37	1.32	1.30	1.27	1.26	1.24
.52	6 ¹ / ₄	1.42	1.36	1.34	1.31	1.29	1.27
.53	6 ³ / ₈	1.47	1.41	1.38	1.35	1.33	1.31
.54	6 ¹ / ₂	1.51	1.44	1.42	1.39	1.37	1.35
.55	6 ⁵ / ₈	1.56	1.49	1.46	1.43	1.41	1.39
.56	6 ³ / ₄	1.60	1.53	1.50	1.46	1.44	1.42
.57	6 ⁷ / ₈	1.64	1.57	1.54	1.50	1.48	1.46
.58	6 ¹ / ₂	1.69	1.61	1.58	1.54	1.52	1.50
.59	7 ¹ / ₁₆	1.74	1.67	1.63	1.59	1.57	1.55
.60	7 ¹ / ₈	1.79	1.70	1.68	1.63	1.61	1.58
.61	7 ¹ / ₄	1.83	1.75	1.72	1.68	1.65	1.63
.62	7 ³ / ₈	1.88	1.80	1.76	1.71	1.69	1.67
.63	7 ¹ / ₂	1.93	1.85	1.81	1.76	1.73	1.71
.64	7 ⁵ / ₈	1.98	1.90	1.86	1.82	1.79	1.76
.65	7 ³ / ₄	2.04	1.93	1.89	1.84	1.81	1.78
.66	7 ⁷ / ₈	2.09	1.99	1.95	1.89	1.87	1.83
.67	8 ¹ / ₁₆	2.14	2.03	1.98	1.93	1.90	1.87
.68	8 ¹ / ₈	2.19	2.08	2.03	1.98	1.95	1.91
.69	8 ¹ / ₄	2.24	2.13	2.08	2.03	1.99	1.96
.70	8 ³ / ₈	2.30	2.18	2.13	2.07	2.03	2.00
.71	8 ¹ / ₂	2.35	2.22	2.17	2.12	2.09	2.04
.72	8 ⁵ / ₈	2.41	2.28	2.22	2.16	2.13	2.09
.73	8 ³ / ₄	2.47	2.33	2.27	2.20	2.18	2.14

pendable method of measuring any volume of flow with any difference in level between upstream and downstream water surfaces.

47. The Parshall Flume. — Working with the United States Department of Agriculture in cooperation with the Colorado Agricultural Experiment Station, Parshall has recently designed a water-measurement device in which the discharge is obtained by measuring the depression caused by forcing a stream through a contracted channel with a depressed bottom. The disadvantages of weirs and submerged orifices are largely overcome by the Parshall Flume. However, since the head,

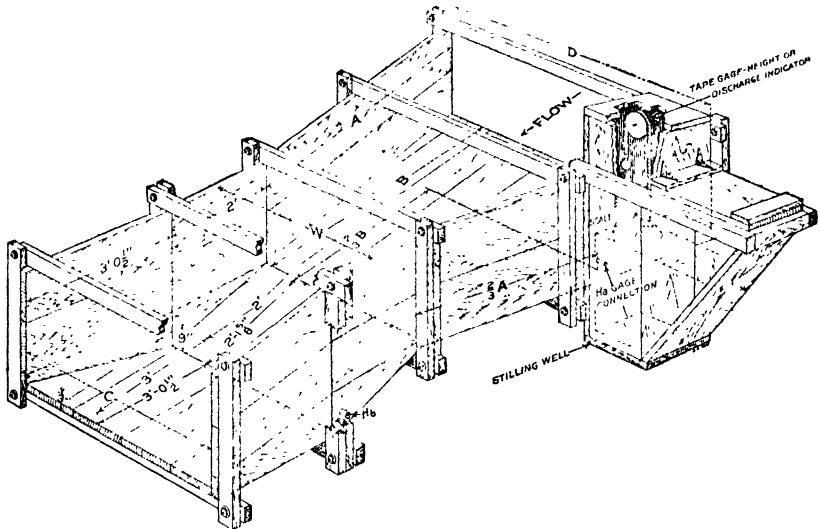

FIG. 23. — Parshall measuring flume, including stilling-well equipment with indicating tape device. Staff gage in well. (Colo. Agr. Exp. Sta. Bul. 336.)

H, on which the measurement is based is very small, great care must be exercised in determining the differences in water level to get accurate measurements. The flume is illustrated in Fig. 23.

The Parshall measuring flume is a product of many years of painstaking research. It was first known as the Venturi flume, being somewhat similar to the Venturi tube or meter early designed to measure the flow of water in pipes. Later it was designated the "Improved Venturi Flume." Details concerning its design, construction, and use are available in the recent bulletins by Parshall cited in the references for Chapter III.

48. The Current Meter. — One of the most widely used devices for measuring flowing water is the current meter, one type of which is shown

in Fig. 24a. Another meter is shown under the water in Fig. 24b in the position of actual use. The meter is calibrated by passing it through still water at a known speed and noting the number of revolutions per second. When the calibrated meter is held still in running water at the proper depth, it is thus possible to determine the average velocity of the water by observing the number of revolutions per second in the meter. It has been found in streams not over 1.5 feet in depth that the average velocity is at about 0.6 of the depth;* in streams over 1.5 feet in depth that the average velocity is represented by the average of the velocities

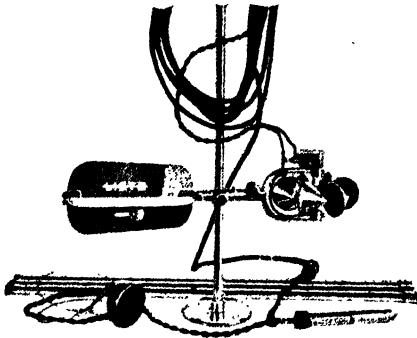

FIG. 24a. — Current meter showing rod suspension with double-end hanger and round wading base. (Courtesy: The A. Leitz Co.)

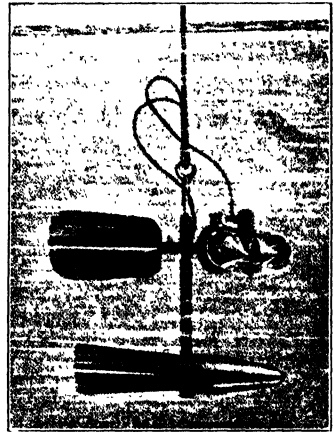

FIG. 24b. — Gurley current meter in use.

at 0.2 and 0.8 of the depth. In the measurement of flowing water it is essential that the current meter be placed at the point or points of average velocity. Another method of determining the average velocity in a stream is the integration method, in which the current meter is raised and lowered slowly and at a constant rate from the bottom to the top of the stream. On practically all the larger canals, and on rivers, discharge measurements are computed from current-meter readings of velocity and measured cross-section areas.

By measuring the discharge of a canal or river at several different stages (or depths) the engineer obtains data from which he determines a relation between the depth of the water and the discharge of the stream. The changes in depth are usually referred to a permanent bench mark,

* Some authorities have found that velocities measured at 0.6 of the depth in shallow streams usually range from 4 to 6 per cent higher than the true average velocities.

or elevation datum; and distances vertically above datum are designated "gauge heights." After measuring the discharges at various gauge heights the engineer plots a rating curve of which Fig. 25 is typical. This figure shows discharges ranging from zero c.f.s. at 0.4 foot gauge height to 100 c.f.s. at a gauge height of 2.35 feet. At any gauge heights between these limits the reader can determine the discharge from the figure. At a gauge height of 1 foot, for example, the discharge is 25 c.f.s.

The major advantages of the current meter are that they require no obstruction of stream flow and are suited to large streams. Water commissioners whose responsibility it is to distribute the public waters

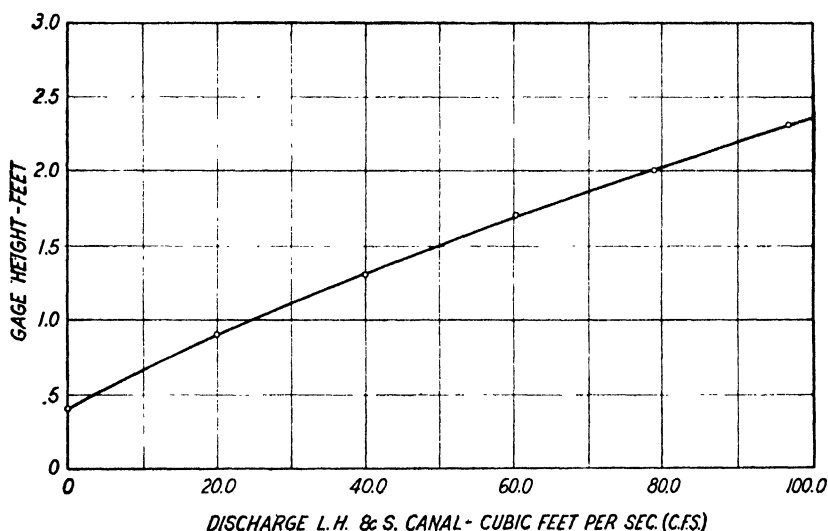

Fig. 25. — Typical rating curve for an irrigation canal.

to those entitled to their use depend for their measurements very largely on rating curves. The gauge height may be read by non-technical men, but the actual use of the meter and the making of rating tables and rating curves are tasks for the trained and experienced hydrographer or for an engineer.

During recent years Hoff has developed a comparatively simple current meter that is adapted to a wide variety of flow conditions.

49. Mechanical Measuring and Recording Devices. — During recent years a number of mechanical devices for water measurement have been designed. Most of these devices not only measure the rate of flow, but also automatically register the total amount of water passing in any given period of time. Canal companies that base water charges on the

number of acre-feet delivered to individual irrigators find self-registering devices serviceable and convenient.

Important among the devices used to date are the following: Dethridge meter, Hill meter, Venturi meter, Reliance meter, and Lyman water register. The Dethridge meter, designed and extensively used in Australia, has been carefully investigated by the United States Department of Agriculture and the Colorado Agricultural Experiment Station. It is likely that more extended use of mechanical-automatic-registering devices will be made as water increases in value and as more irrigation companies, in order to stimulate economy among their irrigators, find it necessary to base water charges on the actual amounts of water delivered.

50. The Division of Irrigation Water. — Many irrigation companies in Utah and other western states divide their streams according to the

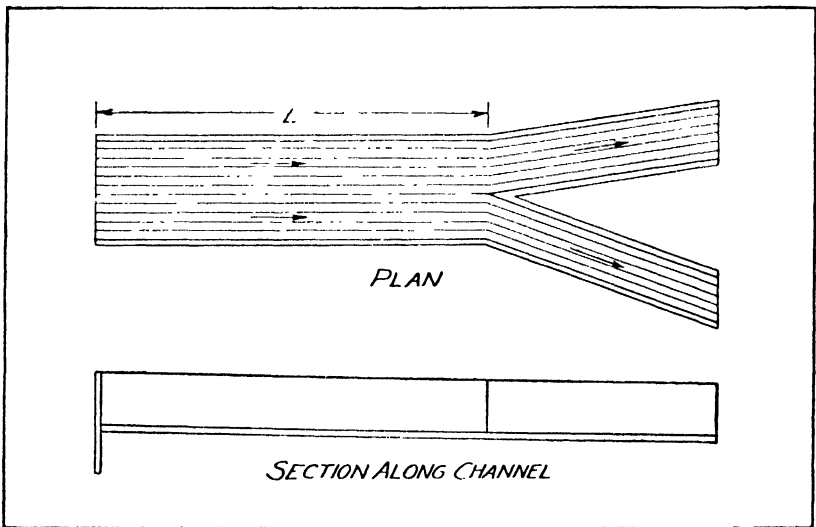

FIG. 26. — Typical divider used on streams carrying considerable gravel (Utah Agr. Exp. Sta. Circular 77).

number of shares of stock owned by individuals or groups of individuals. On the smaller streams a single company either owns the entire flow or it is divided among two or three companies, each company owning a share of the total stream. The users are not so much interested in the measurement of the water as they are in the division of the stream. For example, one company may be entitled to five-twelfths of the stream and another company to seven-twelfths of the stream. The two companies

own all the water in the stream. Many times a division must be made where it is impracticable to make a measurement.

If even an approximate division is made, there are a few principles which must be observed. The water must approach the divider in parallel paths, i.e., there must be no cross currents. To secure this condition the divider box must be placed at the lower end of a long flume or of a straight open channel. The floor of the channel immediately above the divider should be level transversely. If the water is reason-

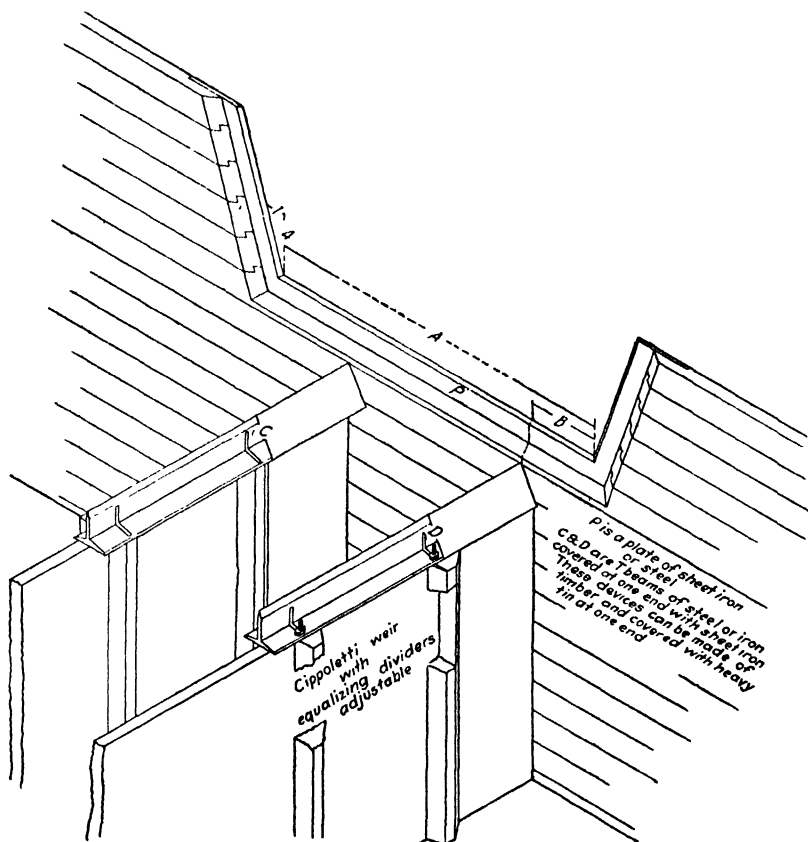

Fig. 27. — Adjustable divider (Utah Agr. Exp. Sta. Circular 6).

ably free from silt it is desirable to have the water approach the divider at a low velocity. For streams carrying considerable silt and gravel there should be no obstruction in the channel in form of bulkhead, and the velocity with which the water enters should be maintained through the structure. Fig. 26 shows a form of divider used on mountain streams

which carry considerable débris. It is very important that these structures have a long, straight channel of approach. Any gravel or débris allowed to collect in the channel of approach will cause cross currents and interfere with proper division.

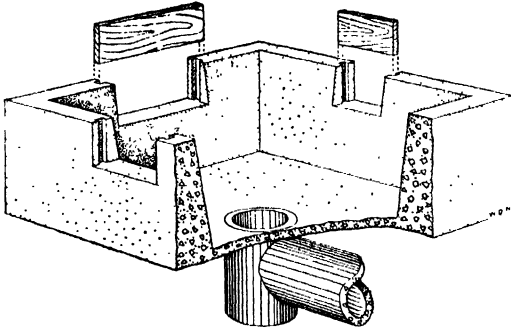

FIG. 28. — Proportional division box. (U. S. Dept. Agr. Farmers' Bul. 348.)

The flow over a weir can be easily divided by placing a sharp-edged partition below the weir to divide the stream as it falls over the crest. The crest of this partition should be placed a sufficient distance below the weir crest to permit a free circulation of air between the divider and the sheet of water falling over the weir.

The discharge over a weir is not exactly proportional to the length of

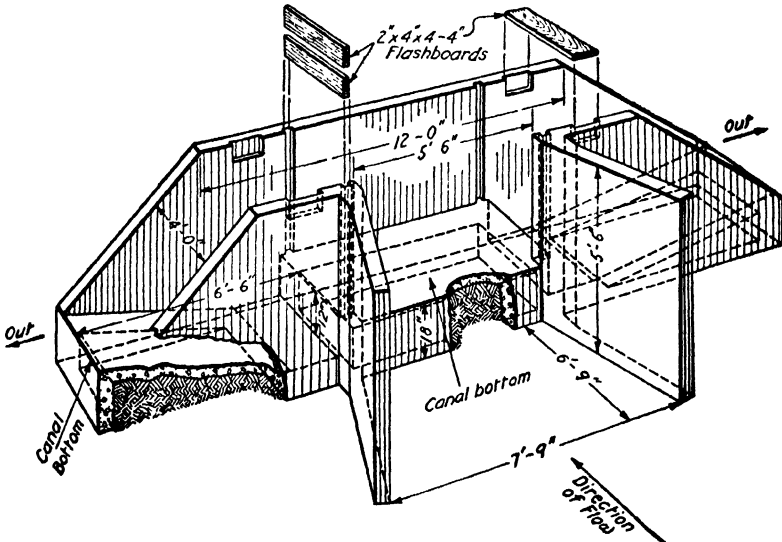

FIG. 29. — Concrete division box. (U. S. Dept. Agr. Farmers' Bul. 1243.)

the crest; the error in considering it so, however, is slight. The trapezoidal weir is the most desirable form if it is to be used as a divider. The flow over this weir is very nearly proportional to length of crest.

If it is desired to divide the stream into two parts, one taking five-sixths and the other one-sixth of the flow, the divider should be placed one-sixth of the distance from the end of the weir. Fig. 27 shows a trapezoidal weir divider fixed to divide a stream into three parts.

If it is desired to divide a stream into two equal parts, the rectangular weir, either with or without end contractions, is entirely satisfactory. In localities where water is distributed to the several parts of the farm in underground pipes it is essential to provide special boxes for making a proportional division of the water. A typical concrete proportional division box connected to a pipe line is illustrated in Fig. 28, and a concrete division box with flashboards is shown in Fig. 29.

51. Convenient Equivalents. — The following convenient equivalents are helpful in stream discharge measurements:

UNITS OF FLOW:

1. 1 c.f.s. = 50 Utah miner's inches.
2. 1 c.f.s. = 7.48 U. S. gallons per second; 448.8 (approximately 450) gallons per minute; and 646,272 gallons per 24-hour day.
3. 1 second-foot = 1 acre-inch per hour (approximately).

UNITS AT REST:

4. 1 acre-foot = 325,850 gallons = 43,560 cubic feet.
5. 1 cubic foot of water weighs 62.5 pounds.
6. 1 gallon = 8.36 pounds of water.
7. 1 gallon = 231 cubic inches (liquid measure).

REFERENCES

- ADAMS, FRANK, *et al.* Some Measuring Devices Used in the Delivery of Irrigation Water, California Agr. Exp. Sta. Bul. 247. 1915.
- CLYDE, GEORGE D. Measurement of Irrigation Water, Utah Agr. Exp. Sta. Cir. 77. 1929.
- CONE, V. M. The Colorado Statute Inch and Some Miner's Inch Measuring Devices, Colorado Agr. Exp. Sta. Bull. 207. 1915.
- CONE, V. M. Divisors for the Measurement of Irrigation Water, Colorado Agr. Exp. Sta. Bul. 228. 1917.
- ISRAELSEN, O. W. Practical Information on the Measurement of Irrigation Water, Utah Agr. Exp. Sta. Cir. 36. 1919.
- KING, H. W. Handbook of Hydraulics, second edition, McGraw-Hill Book Co., Inc., New York. 1929.
- LYMAN, RICHARD R. Measurement of Flowing Streams, Utah Engineering Exp. Sta. Bul. 5. 1912.
- PARSHALL, RALPH L. The Improved Venturi Flume, Colorado Exp. Sta. Bul. 336. 1928.
- PARSHALL, RALPH L. Measuring Water in Irrigation Channels. U. S. Dept. Agr. Farmers' Bul. 1683. 1932.

- STEWART, W. G. The Measurement of Water — A Handbook for Ditch Riders and Water Users, Idaho Agr. Exp. Sta. Bul. 127. 1922.
- WADSWORTH, H. A. Measurement of Irrigation Water on the Farm, California Agr. Exp. Sta. Cir. 250. 1922.
- WRIGHT, C. C. Units of Measurement and the Application of Irrigation Water, Washington Agr. Exp. Sta. Popular Bul. 145. 1929.

CHAPTER IV

PUMPING WATER FOR IRRIGATION

The major part of the water used for irrigation in the world flows from its source in rivers, reservoirs, or lakes to the irrigated lands in response to the force of *gravity* on each unit mass of water, as discussed in Chapter II. However, there are large areas of arable land so situated that available water cannot be brought to them by gravity. Other areas may be reached by gravity but the locations and topography with respect to the water supply are such that cost of building the necessary gravity canals, flumes, inverted siphons, tunnels, and other conveyance structures is so great that water cannot economically be brought to the land by gravity. For many of these areas, water is raised by some mechanical device from its natural sources, whether surface or underground, to the elevation of the higher parts of the land or to still higher elevations if at distant points, so that it will flow over the land by gravity for irrigation purposes. This practice of raising water, known as irrigation pumping, is widely followed in the arid regions of the world. In the humid regions of the United States it is becoming an important practice for spray irrigation.

The mechanical devices for lifting water for irrigation vary widely. Some are crude and inefficient — others are highly perfected and efficient. This chapter is concerned with the principles and problems of pumping water in relatively small quantities for individually owned farms. It does not include the engineering problems involved in the design and operation of the large irrigation pumping projects, which are as a rule owned by corporate or district or other community enterprises.

52. Power Requirements and Pumping Plant Efficiencies. — Mechanical power is defined as the time rate of doing work, and work is defined as the product of force and distance. The power units commonly used in irrigation are foot-pounds per second and horse power. Thus, to lift 2 cubic feet of water (125 pounds) a vertical distance of 1 foot each second would require 125 foot-pounds per second, provided the lifting device (pumping plant) were 100 per cent efficient. If the pumping plant efficiency were only 50 per cent it would require 250 foot-pounds per second, thus providing for a loss of one-half of the total required power in overcoming friction, in generating heat, etc. The unit of power

most commonly used in the United States is the horse power, which is 550 foot-pounds per second, or 33,000 foot-pounds per minute. One horse power would lift 1 c.f.s. a vertical distance of 8.8 feet if it were possible to get 100 per cent efficiency as shown below:

$$\text{Horse power} = \frac{1 \times 62.5 \times 8.8}{550} = 1$$

Because it is impossible to obtain an efficiency of 100 per cent, the horse power required to lift 1 c.f.s. any height, as illustrated above, is designated the "theoretical horse power." Table IX, taken from King's Handbook of Hydraulics,* gives theoretical horse power for 1 c.f.s. for heads from 0 to 100 feet. To determine the theoretical horse power required for a stream of any size, say 5 c.f.s., the reader need only multiply the observed value in the table by 5. To illustrate, Table IX shows that to lift 1 c.f.s. 45.5 feet would require, theoretically, 5.162 HP. Therefore, 5 c.f.s. would require 25.81 HP. Pumping *plant efficiency* is defined as the ratio of the power output to the power input. The electricity, gas, oil, or coal consumed by the motor or engine is the input. Therefore, if an electric motor actually consumes 51.62 HP electric current to lift 5 c.f.s. 45.5 feet the efficiency is 50 per cent. Hence, to obtain the *actual* HP requirement, one needs only to divide the theoretical requirement by the efficiency, expressed as a decimal. Thus to raise 5 c.f.s. 45.5 feet with a plant efficiency of 50 per cent requires:

$$\text{Actual HP} = \frac{25.81}{0.50} = 51.62$$

The horse power delivered by an electric motor or by an engine to the shaft it turns is known as the brake horse power. The ratio of the useful water horse power delivered by a pump (the output) to the brake horse power (the input to the pump) is defined as the pump efficiency.

To understand clearly the consumption of different fuels in pumping, it is helpful to note that, by definition

$$\text{power} = \frac{\text{work}}{\text{time}} \dots \dots \dots (24)$$

and hence that

$$\text{work} = \text{power} \times \text{time} \dots \dots \dots (25)$$

The expression horse-power-hour is used to designate the continuous consumption or delivery of 1 horse power for a period of 1 hour, and is therefore equal to $550 \times 60 \times 60$ foot-pounds of *work*. The terms *work* and *energy* are fundamentally the same and are used interchangeably.

* See references for Chap. III.

POWER REQUIREMENTS

TABLE IX

THEORETICAL HORSE POWER OF 1 CUBIC FOOT PER SECOND OF WATER, FOR HEADS FROM 0 TO 100 FEET

Head in Feet	0	.1	.2	.3	.4	.5	6	7	8	9
1	0 113	0 125	0 136	0 147	0 159	0 170	0 182	0 193	0 204	0 216
2	227	238	250	261	272	284	295	306	318	329
3	340	352	363	374	386	397	408	420	431	442
4	454	465	477	488	499	511	522	533	545	556
5	567	579	590	601	613	624	635	647	658	669
6	.681	692	.703	.715	.726	.737	.749	.760	.771	.783
7	.794	806	817	828	.840	.851	862	.874	.885	896
8	908	919	930	.942	.953	964	976	.987	.998	1 010
9	1 021	1 032	1 044	1 055	1 066	1 078	1 089	1 101	1 112	1 123
10	1 135	1 146	1 157	1 169	1 180	1 191	1 203	1 214	1 225	1 237
11	1 248	1 259	1 271	1 282	1 293	1 305	1 316	1 327	1 339	1 350
12	1 361	1 373	1 384	1 395	1 407	1 418	1 430	1 441	1 452	1 464
13	1 475	1 486	1 498	1 509	1 520	1 532	1 543	1 554	1 566	1 577
14	1 588	1 600	1 611	1 622	1 634	1 645	1 656	1 668	1 679	1 690
15	1 702	1 713	1 725	1 736	1 747	1 759	1 770	1 781	1 793	1 804
16	1 815	1 827	1 838	1 849	1 861	1 872	1 883	1 895	1 906	1 917
17	1 929	1 940	1 951	1 963	1 974	1 985	1 997	2 008	2 019	2 031
18	2 042	2 054	2 065	2 076	2 088	2 099	2 110	2 122	2 133	2 144
19	2 156	2 167	2 178	2 190	2 201	2 212	2 224	2 235	2 246	2 258
20	2 269	2 280	2 292	2 303	2 314	2 326	2 337	2 349	2 360	2 371
21	2 383	2 394	2 405	2 417	2 428	2 439	2 451	2 462	2 473	2 485
22	2 496	2 507	2 519	2 530	2 541	2 553	2 564	2 575	2 587	2 598
23	2 609	2 621	2 632	2 643	2 655	2 666	2 678	2 689	2 700	2 712
24	2 723	2 734	2 746	2 757	2 768	2 780	2 791	2 802	2 814	2 825
25	2 836	2 848	2 859	2 870	2 882	2 893	2 904	2 916	2 927	2 938
26	2 950	2 961	2 973	2 984	2 995	3 007	3 018	3 029	3 041	3 052
27	3 063	3 075	3 086	3 097	3 109	3 120	3 131	3 143	3 154	3 166
28	3 177	3 188	3 199	3 211	3 222	3 233	3 245	3 256	3 267	3 279
29	3 290	3 302	3 313	3 324	3 336	3 347	3 358	3 370	3 381	3 392
30	3 404	3 415	3 426	3 438	3 449	3 460	3 472	3 483	3 494	3 506
31	3 517	3 528	3 540	3 551	3 562	3 574	3 585	3 597	3 608	3 619
32	3 631	3 642	3 653	3 665	3 676	3 687	3 699	3 710	3 721	3 733
33	3 744	3 755	3 767	3 778	3 789	3 801	3 812	3 823	3 835	3 846
34	3 857	3 869	3 880	3 891	3 903	3 914	3 926	3 937	3 948	3 960
35	3 971	3 982	3 994	4 005	4 016	4 028	4 039	4 050	4 062	4 073
36	4 084	4 096	4 107	4 118	4 130	4 141	4 152	4 164	4 175	4 186
37	4 198	4 209	4 221	4 232	4 243	4 255	4 266	4 277	4 289	4 300
38	4 311	4 323	4 334	4 345	4 357	4 368	4 379	4 391	4 402	4 413
39	4 425	4 436	4 447	4 459	4 470	4 481	4 493	4 504	4 515	4 527
40	4 538	4 550	4 561	4 572	4 584	4 595	4 606	4 618	4 629	4 640
41	4 652	4 663	4 674	4 686	4 697	4 708	4 720	4 731	4 742	4 754
42	4 765	4 776	4 788	4 799	4 810	4 822	4 833	4 845	4 856	4 867
43	4 879	4 890	4 901	4 913	4 924	4 935	4 947	4 958	4 969	4 981
44	4 992	5 003	5 015	5 026	5 037	5 049	5 060	5 071	5 083	5 094
45	5 105	5 117	5 128	5 139	5 151	5 162	5 174	5 185	5 196	5 208
46	5 219	5 230	5 242	5 253	5 264	5 276	5 287	5 298	5 310	5 321
47	5 332	5 344	5 355	5 366	5 378	5 389	5 400	5 412	5 423	5 434
48	5 446	5 457	5 469	5 480	5 491	5 503	5 514	5 525	5 537	5 548
49	5 559	5 571	5 582	5 593	5 605	5 616	5 627	5 639	5 650	5 661
50	5 673	5 684	5 695	5 707	5 718	5 729	5 741	5 752	5 763	5 775

TABLE IX (Concluded)

THEORETICAL HORSE POWER OF 1 CUBIC FOOT PER SECOND OF WATER, FOR HEADS FROM 0 TO 100 FEET

Head in Feet	.0	1	.2	.3	4	5	6	7	8	.9
51	5 786	5 798	5 809	5 820	5 832	5 843	5 854	5 866	5 877	5 888
52	5 900	5 911	5 922	5 934	5 945	5 956	5 968	5 979	5 990	6 002
53	6 013	6 024	6 036	6 047	6 058	6 070	6 081	6 093	6 104	6 115
54	6 127	6 138	6 149	6 161	6 172	6 183	6 195	6 206	6 217	6 229
55	6 240	6 251	6 263	6 274	6 285	6 297	6 308	6 319	6 331	6 342
56	6 353	6 365	6 376	6 387	6 399	6 410	6 422	6 433	6 444	6 456
57	6 467	6 478	6 490	6 501	6 512	6 524	6 535	6 546	6 558	6 569
58	6 580	6 592	6 603	6 614	6 626	6 637	6 648	6 660	6 671	6 682
59	6 694	6 705	6 717	6 728	6 739	6 751	6 762	6 773	6 785	6 796
60	6 807	6 819	6 830	6 841	6 853	6 864	6 875	6 887	6 898	6 909
61	6 921	6 932	6 943	6 955	6 966	6 977	6 989	7 000	7 011	7 023
62	7 034	7 046	7 057	7 068	7 080	7 091	7 102	7 114	7 125	7 136
63	7 148	7 159	7 170	7 182	7 193	7 204	7 216	7 227	7 238	7 250
64	7 261	7 272	7 284	7 295	7 306	7 318	7 329	7 341	7 352	7 363
65	7 375	7 386	7 397	7 409	7 420	7 431	7 443	7 454	7 465	7 477
66	7 488	7 499	7 511	7 522	7 533	7 545	7 556	7 567	7 579	7 590
67	7 601	7 613	7 624	7 635	7 647	7 658	7 670	7 681	7 692	7 704
68	7 715	7 726	7 738	7 749	7 760	7 772	7 783	7 794	7 806	7 817
69	7 828	7 840	7 851	7 862	7 874	7 885	7 896	7 908	7 919	7 930
70	7 942	7 953	7 965	7 976	7 987	7 999	8 010	8 021	8 033	8 044
71	8 055	8 067	8 078	8 089	8 101	8 112	8 123	8 135	8 146	8 157
72	8 169	8 180	8 191	8 203	8 214	8 225	8 237	8 248	8 259	8 271
73	8 282	8 294	8 305	8 316	8 328	8 339	8 350	8 362	8 373	8 384
74	8 396	8 407	8 418	8 430	8 441	8 452	8 464	8 475	8 486	8 498
75	8 509	8 520	8 532	8 543	8 554	8 566	8 577	8 589	8 600	8 611
76	8 623	8 634	8 645	8 657	8 668	8 679	8 691	8 702	8 713	8 725
77	8 736	8 747	8 759	8 770	8 781	8 793	8 804	8 815	8 827	8 838
78	8 849	8 861	8 872	8 883	8 895	8 906	8 918	8 929	8 940	8 952
79	8 963	8 974	8 986	8 997	9 008	9 020	9 031	9 042	9 054	9 065
80	9 076	9 088	9 099	9 110	9 122	9 133	9 144	9 156	9 167	9 178
81	9 190	9 201	9 213	9 224	9 235	9 247	9 258	9 269	9 281	9 292
82	9 303	9 315	9 326	9 337	9 349	9 360	9 371	9 383	9 394	9 405
83	9 417	9 428	9 439	9 451	9 462	9 473	9 485	9 496	9 507	9 519
84	9 530	9 542	9 553	9 564	9 576	9 587	9 598	9 610	9 621	9 632
85	9 644	9 655	9 666	9 678	9 689	9 700	9 712	9 723	9 734	9 746
86	9 757	9 768	9 780	9 791	9 802	9 814	9 825	9 837	9 848	9 859
87	9 871	9 882	9 893	9 905	9 916	9 927	9 939	9 950	9 961	9 973
88	9 984	9 995	10 007	10 018	10 029	10 041	10 052	10 063	10 075	10 086
89	10 097	10 109	10 120	10 131	10 143	10 154	10 166	10 177	10 188	10 200
90	10 211	10 222	10 234	10 245	10 256	10 268	10 279	10 290	10 302	10 313
91	10 324	10 336	10 347	10 358	10 370	10 381	10 392	10 404	10 415	10 426
92	10 438	10 449	10 461	10 472	10 483	10 495	10 506	10 517	10 529	10 540
93	10 551	10 563	10 574	10 585	10 597	10 608	10 619	10 631	10 642	10 653
94	10 665	10 676	10 687	10 699	10 710	10 721	10 733	10 744	10 755	10 767
95	10 778	10 790	10 801	10 812	10 824	10 835	10 846	10 858	10 869	10 880
96	10 892	10 903	10 914	10 926	10 937	10 948	10 960	10 971	10 982	10 994
97	11 005	11 016	11 028	11 039	11 050	11 062	11 073	11 085	11 096	11 107
98	11 119	11 130	11 141	11 153	11 164	11 175	11 187	11 198	11 210	11 221
99	11 232	11 243	11 255	11 266	11 277	11 289	11 300	11 311	11 323	11 334
100	11 345	11 357	11 368	11 379	11 391	11 402	11 414	11 425	11 436	11 448

The "water horse power" is defined as the power theoretically required to lift a given quantity of water per second to a specified height. In irrigation pumping it may be termed the "output." It is apparent from the foregoing definitions that

$$HP_w = \frac{62.5qh}{550} = \frac{qh}{8.8} \dots \dots \dots (26)$$

where HP_w = water horse power;
 q = discharge in c.f.s.;
 h = vertical lift in feet.

If q is measured in g.p.m. rather than c.f.s. then

$$HP_w = \frac{8.33qh}{33,000} = \frac{qh}{3960} \dots \dots \dots (27)$$

Equations (26) and (27) are useful in determining water horse power when q and h are known. Furthermore, based on definition given above

$$\text{Pumping plant efficiency} = \frac{qh}{8.8 \times \text{horse-power input}} \dots (28)$$

Occasional field tests of plant efficiencies aid the irrigator to guard against low efficiencies and expensive operation.

Field tests have recently been made by Johnston of 91 irrigation pumping plant efficiencies in California. The results of these tests show averages of 49.8 per cent for centrifugal pumps; 40.5 per cent for deep-well turbine pumps, and 44.5 per cent for deep-well screw pumps. The maximum plant efficiency found was 70 per cent and the minimum 15.2 per cent. Johnston stresses the importance to the farmer of keeping pumping equipment in good condition, asserting that the low efficiencies found in the field study "are largely chargeable to failure on the part of the owner to keep his equipment in good running order."

53. Pumping Lifts. — The vertical distance through which water is lifted for irrigation purposes varies widely. In some localities, notably in parts of Egypt and of India, the water is lifted only a few feet; in other places, like parts of California, it is raised several hundred feet. In American irrigation practice the maximum height of lift is determined by cost limitations, not by mechanical or power limitations. From the discussion of Article 52 and from Table IX, it is apparent that for any given size of irrigation stream the power requirement is roughly proportional to the lift. Among engineers the difference in elevation of the water surface in a pond, lake, or river from which the pumped water is taken, and the water surface of the discharge canal,

is known as the "static head." In pumping from ground-water sources the static head includes also the "draw down," which is the head required to generate the power necessary to drive the same volume of water per second from the soil into the well as is received by the pump and delivered to the surface of the land. It is desirable always to avoid excessive draw down in order to avoid excessive power requirements. In addition to the static head that pumps must work against, consumption of a certain amount of power is essential to drive a given stream against the frictional resistance, sharp curves in pipes, and other factors which retard water motion. These retardation elements explain the fact that pumping-plant efficiencies range from about 75 per



FIG. 30. — The Natali, or swinging basket. (U. S. Dept. Agr. O. E. S. Bul. 130.)

cent under very favorable conditions down to 20 per cent or even less with unfavorable conditions.

In Utah and Idaho, under general farm practice, it is rarely profitable to pump water for irrigation purposes against a static head in excess of 75 feet. In parts of the Pacific coast states under intensive agriculture, water is economically pumped for irrigation against static heads of 300 feet or more. Because of the large number of variable factors influencing profits from pumping water for irrigation, it is impracticable to set specific limits of profitable pumping lifts that will apply in different localities for any length of time. It is important for farmers who contemplate irrigation pumping to keep in mind the fact that cost to the farmer of pumped water is roughly proportional to the height of

lift. Proposals to pump water through high lifts should be very carefully considered before investments are made; on the other hand, good dependable water supplies that may be made available for irrigation by pumping only a few feet should not be overlooked.

54. Primitive Irrigation Pumping Methods. —

Raising water for irrigation has been practiced for many centuries in Egypt, India, and others of the older countries where irrigation is essential to agriculture. One of the devices early used in Egypt and India known as the *Natali*, or swinging basket, is illustrated in Fig. 30. With this simple device, merely a leather bucket, two men can raise approximately 12 g.p.m. to a height of 3 to 4 feet. Based on the common assumption that a man can do $\frac{1}{3}$ HP work, the efficiency of the *Natali* is only 5 per cent.

Another primitive device, known as the *Shaduf*, still used in Egypt and some of the other older countries, is illustrated in Fig. 31. This device makes use of the principle



FIG. 31. — The Shaduf. (U. S. Dept. Agr. O. E. S. Bul. 130.)

of the lever with a suspended fulcrum and counter weight. The bucket, suspended from the long end of the pole, in some cases is made of leather, stiffened near the top with a wooden hoop. The operator throws his weight on the sweep, the bucket fills, and the counter weight raises it to the next higher channel into which the water is poured. A single *Shaduf* is operated by one man, and with it he can lift water only 5 or 6

feet, but they are sometimes installed in series of 3 or 4, thus raising the water 20 feet or more. With the Shaduf one man can raise approximately 22 g.p.m. from 5 to 6 feet; thus making an efficiency of about 25 per cent.

Still another device is the *Archimedean Screw*, illustrated in Fig. 32. Although it is as a rule operated by hand, in some parts of Egypt small engines are used to drive this device. The construction and operation are described by C. T. Johnston as follows:

“Around an iron shaft some 14 or 15 feet long is built a screw, made up of thin pieces of wood so fitted together as to be practically water-tight. A water-tight wooden cylinder is constructed around the screw. The diameter of the cylinder is ordinarily about 14 inches, and its length does not often exceed 8 or 9 feet. The pitch of the screw is about 1 revolution to $1\frac{1}{2}$ diameters. The screw is so attached that it will not revolve on the shaft. The shaft projects from both ends of the cylinder and is supported near its extremities by posts. The screw inclines 30 degrees or less to the horizon, with its lower end in the water. To the upper end of the shaft a crank is attached. This lifting device is shown in the illustration. One or two men usually operate a screw, but in rare cases, when the screw is especially large or the lift considerable, a small engine is employed. High lifts are practically impossible on account of the difficulty of supporting a screw of great length. This device is more efficient than the lifting machines contrived by the natives. One man can irrigate from 1 to 2 acres a day with this machine, provided the lift be not over 2 feet.”

A pumping device operated by animal power, as illustrated in Fig. 33, known as the *Sakiyeh*, and also as the Persian wheel, is still widely used in Egypt and in India and in some of the other older countries. Johnston describes the construction and operation in the following language:

“The Sakiyeh consists of a horizontal wooden wheel about 10 feet in diameter with cogs projecting. The wheel is supported on a vertical shaft which rests on a wooden bearing and is held in position by a wooden beam about 6 feet above the ground. The horizontal wheel, rotated by an ox, is geared to a vertical wood wheel on a horizontal shaft to which is also fastened a large vertical wheel supporting earth jars with which to raise the water.”

In some localities the Sakiyehs are turned by the current of water in the canals.

The capacity of the Sakiyeh ranges from 15 to 25 g.p.m. for lifts from 8 to 12 feet. Assuming average values of 20 g.p.m. and 10-foot lift, and assuming also that an ox can do work at the rate of $\frac{1}{2}$ HP, then the efficiency of the Sakiyeh is approximately 10 per cent.

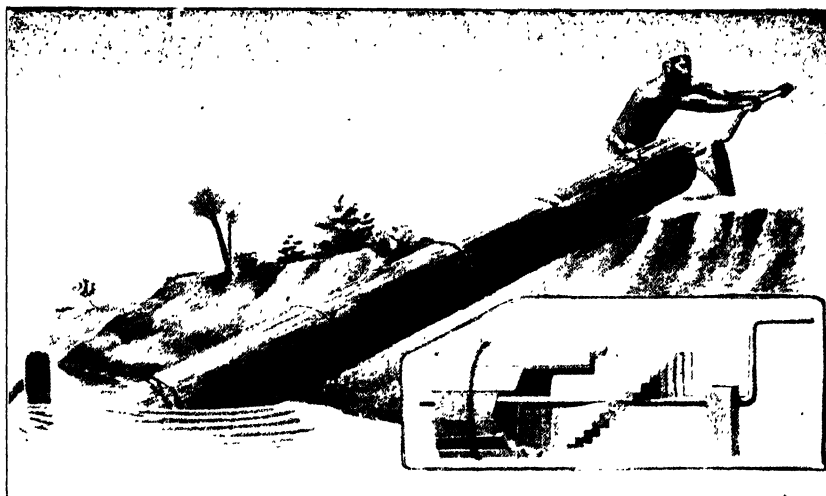

FIG. 32. — Archimedean screw, showing interior construction at right. (U. S. Dept. Agr. O. E. S. Bul. 130.)



FIG. 33. — Sakiyehs, or Persian Wheels. (U. S. Dept. Agr. O. E. S. Bul. 130.)

55. Modern Irrigation Pumping Methods. — In contrast to the primitive methods of pumping water for irrigation, of which some are briefly described above, pumping machinery of high efficiency is now commonly used on many irrigated farms. In the western United States substantial advancement has been made in the design and operation of pumps during recent years. Moreover, pumping costs are greatly reduced by obtaining the necessary energy for pumping from coal, gasoline, crude oil, and electricity rather than using the energy of man or of animals. To illustrate; assume that for irrigation pumping 1 kilowatt hour of electric energy may be purchased at a cost ranging from 1 to 3 cents. As 1 kilowatt hour equals $\frac{1}{3}$ horse-power-hour, approximately, one horse-power-hour on the basis of 1 to 3 cents per kilowatt hour would cost $\frac{3}{4}$ to $2\frac{1}{4}$ cents. A strong healthy man, in an hour, can generate about $\frac{1}{8}$

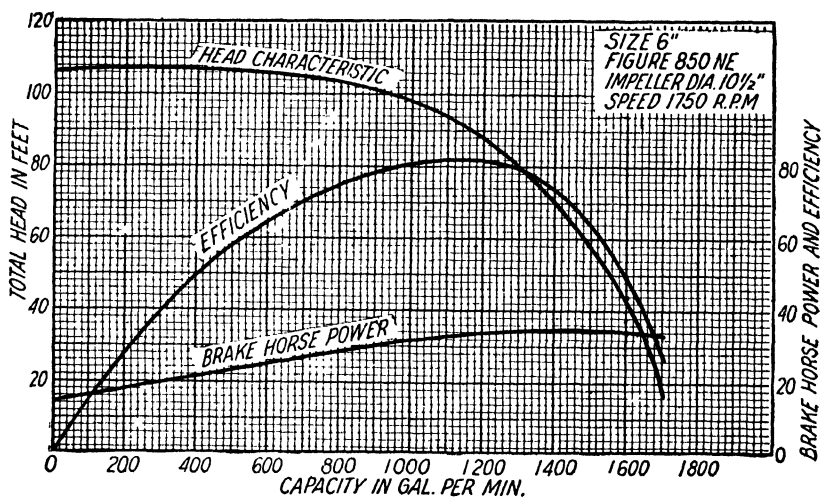

FIG. 34. — Characteristic performance curves from test records. (Courtesy: Fairbanks-Morse Company.)

horse-power-hour work. At the very low rates of 10 to 30 cents per hour for man labor, the cost of 1 horse-power-hour would range from 80 to 240 cents as compared to $\frac{3}{4}$ to $2\frac{1}{4}$ cents for electricity.

Modern irrigation pumping methods are based on many years of painstaking laboratory research, together with careful study of field pumping conditions by competent engineers. Out of these investigations there have come into use pumps of different classes and types, each suited to the different demands and conditions of operation. Typical modern irrigation pumps of different types are illustrated in

Figs. 36 to 40 and briefly described in Articles 57 to 61 following the consideration of characteristic performance curves in Article 56.

56. Pump Characteristics. — In order to use modern pumps most profitably to obtain irrigation water, it is essential to select pumps well adapted to the particular conditions of operation and thus obtain a relatively high efficiency. If the quantity of water pumped is appreciably less than the quantity for which the pump is designed, and the head is excessive, a low efficiency results. Likewise, a pump may deliver more water than it is designed for at a head lower than normal and cause the efficiency to be low. The interrelations between speed, head, discharge, and horse power of a pump are usually represented by curves which are designated the "characteristic curves." Knowledge of the characteristics of a pump enables the manufacturer and irrigator to make adaptations of the pump to the operating conditions and thus attain a relatively high efficiency and low operating cost. The characteristics of a standard horizontal-shaft centrifugal pump are shown in Fig. 34. These curves show, for example, that for quantities ranging from 700 up to 1440 g.p.m. at heads ranging from 105 feet down to 65 feet, the efficiency of the pump will be equal to or greater than 70 per cent; also that it will attain a maximum efficiency of 82 per cent at quantities from 1100 to 1200 g.p.m. and at a head of approximately 90 feet.

57. Types of Pumps. — Many different makes of pumps are used for irrigation purposes. The pumps most commonly used may be grouped into four types, namely, centrifugal; deep-well turbine; screw-type or direct flow; and reciprocating or plunger pumps. Air-lift pumps are sometimes used to develop wells, but on account of low efficiency they are rarely used for permanent pumping operating. Brief descriptions of the distinguishing mechanical features of each of the four major types of pumps are given in the following sections.

58. Centrifugal Pumps. — A centrifugal pump consists of a rotating impeller within a case into which water enters at the center and flows outward. The pump imparts energy to the water in the form of increased velocity and pressure. There are two classes of centrifugal pumps: the *volute* and the *turbine*. The essential point of difference in the two classes is the construction around the impeller of the turbine centrifugal pump of fixed diffuser vanes in order more efficiently to convert velocity energy into pressure energy. Centrifugal pumps are built both on horizontal and on vertical shafts. When driven by electrical power they are generally connected directly to the shaft of the motor provided the proper speed can be thus attained. Centrifugal pumps vary in capacity from a very few gallons per minute up to 300 c.f.s. or more. For farm irrigation purposes the pumps most commonly used

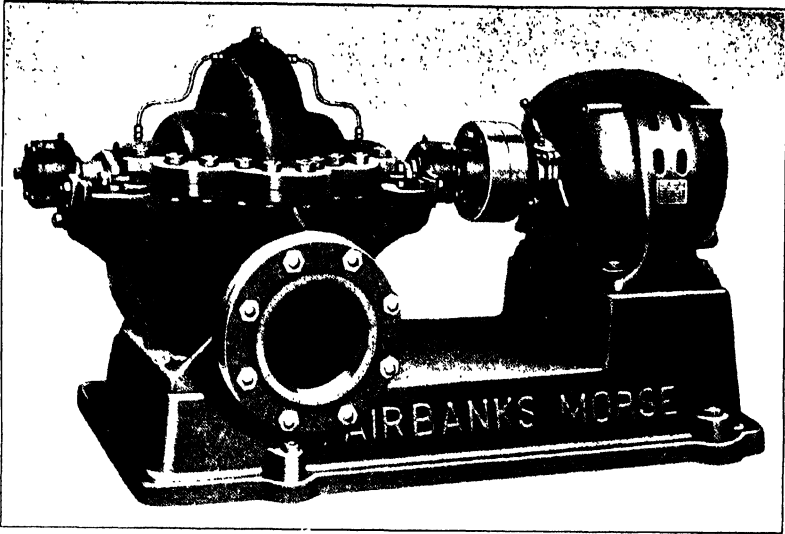

FIG. 35. -- Ball-bearing centrifugal pump direct-connected to a motor. (Courtesy: Fairbanks-Morse Company.)

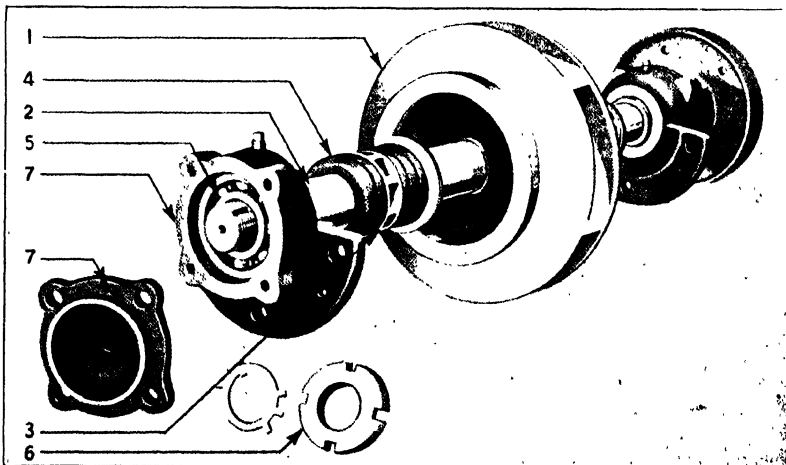

FIG. 36. — Impeller and shaft assembly of pumps showing: (1) enclosed impeller; (2) ground carbon-steel shaft; (3) water seal ring; (4) packing; (5) standard ball bearing; (6) lock nut and (7) ball-bearing housing and cover. (Courtesy: Fairbanks-Morse Company.)

vary from $\frac{1}{2}$ to 5 c.f.s. in capacity. A modern horizontal-shaft, single-stage, split case, volute centrifugal pump direct-connected to an electric motor is illustrated in Fig. 35.

Horizontal-shaft centrifugal pumps are usually set above the surface of the water to be pumped and hence are dependent on the atmospheric pressure to force water up to the pump. To start these pumps it is necessary to fill the suction pipe and pump case with water, and thus expel all the air. The operation of filling suction and pump case is designated "priming the pump." It is usually advantageous to set the pump as near the water surface as convenient and yet protect it from submergence during high water. It is especially important to avoid submergence of pumps that are direct-connected to electric motors. A maximum working vertical distance from water surface to pump at sea level is about 25 feet. At higher elevations a proportionately less maximum distance must be provided. The horizontal-shaft centrifugal pumps are relatively free from trouble, have high efficiencies, stand high speeds, and are conveniently direct-connected to electric motors. The pump illustrated in Fig. 35 operates at a speed of 1750 revolutions per minute. The shaft and impeller together with other detail parts of the pump shown in Fig. 35 are illustrated in Fig. 36.

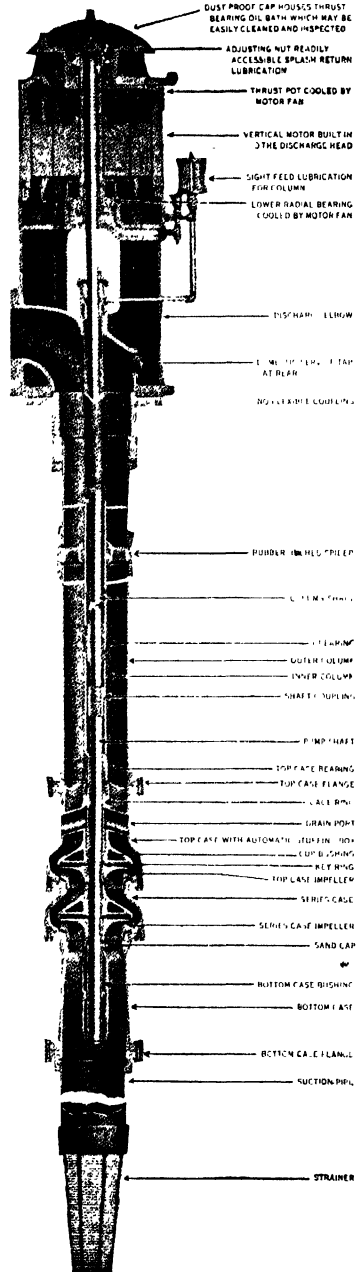

FIG. 37. — Cutaway section of two-stage Byron Jackson deep well turbine pump and motor showing details of parts. (Courtesy: Byron Jackson Company.)

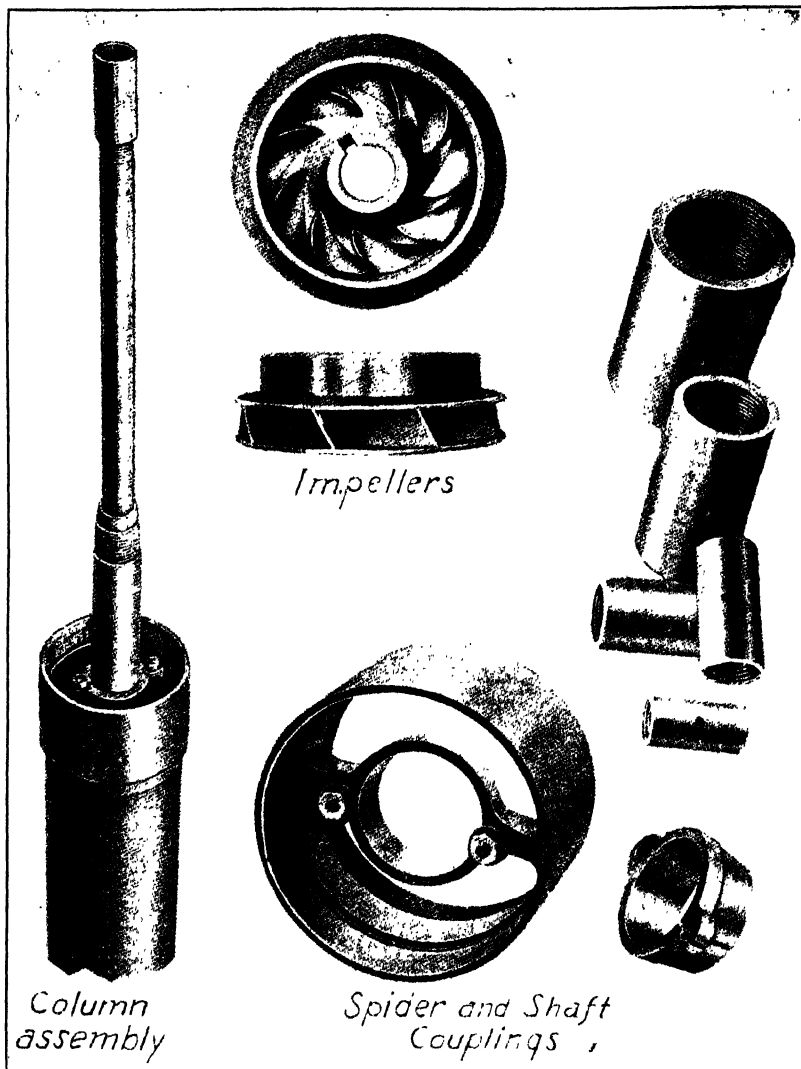

FIG. 38. — Assembly and parts of a deep-well turbine pump. (Courtesy: Byron Jackson Company.)

59. Deep-Well Turbine Pumps. — In order economically to obtain water from deep-small-diameter, machine-constructed wells, modern deep-well turbine centrifugal pumps have been developed and greatly improved. The rotating impeller is built on a vertical shaft within a compact bowl, the entire unit being known as a stage. For high lifts,

two or more stages are placed in series near the bottom of the well. Fig. 37 illustrates a two-stage, deep-well pump. The pump is driven by an electric motor or other prime mover set at the ground surface and connected by a long vertical shaft held in position by bearings built in

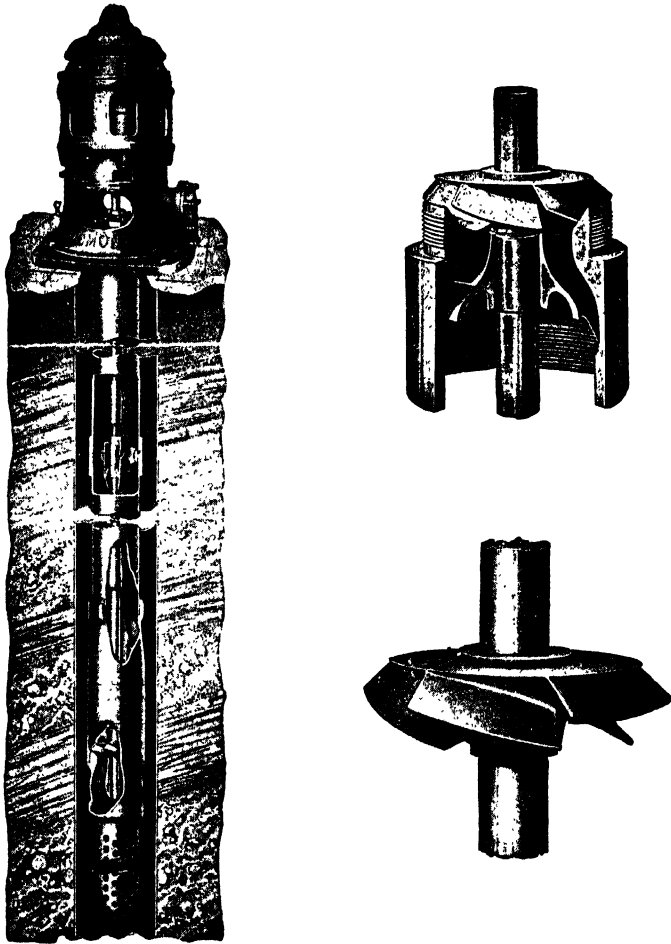

FIG. 39. — Cutaway section of Pomona Turbine Pump and Motor and details of bowl and impeller keyed to shaft. (Courtesy: Pomona Pump Company.)

the discharge pipe or column. Being submerged, the deep-well pumps have the advantage of requiring no priming and of meeting rather wide fluctuations of water surface without necessitating a resetting of the pump. They have the disadvantage of inaccessibility of operating parts and consequent difficulty of inspection. Naturally, therefore,

low efficiencies are more common than with horizontal-shaft pumps, because the deep-well pumps are too frequently permitted to continue running after bearings are worn badly, and sometimes until the pump fails to operate, before repairs are provided. Fig. 38 illustrates the several parts of a deep-well pump, showing also the position of the shaft and the column. Another form of deep-well pump is illustrated in Fig. 39. Careful inspection shows a marked difference in the impellers illustrated in Figs. 38 and 39, although both are used in deep-well turbine pumps. Although the pump illustrated in Fig. 39 is a turbine pump, it will be noted that the patented semi-open impeller resembles somewhat the screw type of impellers briefly described in Article 60.

60. Screw-Type Pumps. — The screw type of pump consists of rapidly rotating screw-like impellers fastened securely to a shaft mounted on bearings within a pipe column. The action of screw-type pumps in water is sometimes compared to the action of a rotating fan in air — both drive the surrounding fluid forward by the rotation of inclined planes. The forward distance of water movement resulting from one complete revolution of the shaft and attached screw is designated the pitch of the pump. Both horizontal and vertical drive shafts are used, the former being limited to the requirements of lifting very large quantities of water through small distances. Screw lift pumps on vertical shafts are widely used in deep wells under conditions and with advantages and disadvantages clearly stated by Johnston as follows:

“The deep-well form of screw pump is a series of low-lift pumps so mounted on a single shaft that they operate as a unit. They are assembled from sections about 6 feet long. Each section has two screws mounted in it with a single bearing which is supported in a spider frame between the two screws. The planes of the spider tend to keep the water from whirling as it travels upward. A second set of vanes is placed above the upper screw in each unit to stop the whirling action of the water leaving that screw. When it is desired to pump against a head at the surface of the well, a number of screws are nested at the bottom of the pump because the total lift per screw cannot exceed about 4 feet and should be about $2\frac{1}{2}$ to 3 feet, under which conditions this type of pump operates with very good efficiency.

“Screw pumps are subject to the same difficulties as the deep well turbines with their long shafts transmitting the power. Since it is impossible to line the drive shaft and bearings with screws located along the length of the shaft, the bearings are open to the entry of abrasive substances in the water. This disadvantage is balanced by the adaptability of these pumps to changing water tables, because sections of pump added at the top or removed from the top, as the conditions dictate, will enable the pump to follow the water levels. In contrast, the turbine requires complete withdrawal for changing the bowls whenever a lowered or raised water table necessitates it. As in the case of the

turbines, the screw pump is liable to be operated when repairs should be made. It requires no priming, since the operating parts are immersed in the water supply. As a general rule, screw pumps will handle more water than deep-well turbines of the same outside diameter."

One make of the screw-type pump used widely for irrigation purposes is illustrated in Fig. 40. This pump is designated by its makers as a *direct-flow* pump, meaning that the flow is essentially parallel to the shaft, or as termed in hydraulics, it is an *axial-flow* type. Within the column above each set of impellers there are *rectifier vanes*, the function of which is to provide axial flow.

61. Plunger Pumps.—Sliding pistons closely fitted in air-tight chambers, together with suitable automatic valves for controlling suction and discharge, constitute the basic parts of the plunger-type pumps. The capacity from a single piston is determined by the volume of the chamber, the number of movements of piston per unit of time, and the action of the pump, whether single or double. The use of plunger pumps for irrigation purposes in arid regions is restricted to localities in which only small amounts of water are needed and are available at comparatively great lifts. In humid regions, plunger pumps are popular for use in spray irrigation of gardens and small truck farms. When used for surface water supplies, the piston moves in a horizontal direction. These pumps are usually driven by electric motors or gas engines. A recent survey in New Jersey shows the average size of gas engine for plunger pumps to be a $6\frac{1}{2}$ horse power and the average capacity of pump 85 g.p.m. When the pistons and valves are in good condition plunger pumps have high efficiencies. If used for water containing large amounts of silt and sand, the moving parts are subject to excessive wear and must be inspected and kept in good condition to avoid low efficiencies.

62. Kinds and Costs of Fuel.—For small pumping plants, electricity, gasoline, crude oil, and coal constitute the more important sources of power. The cost of fuel from which to obtain the necessary power influences the total cost of pump operation and hence

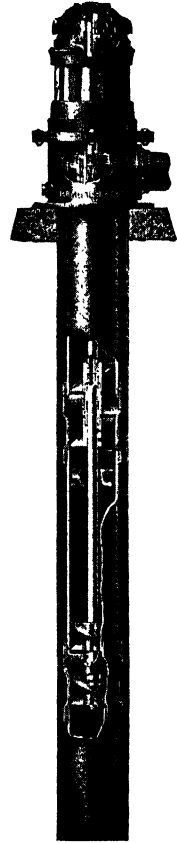

FIG. 40. — Cutaway section of a direct flow deep-well pump, showing shaft and impellers. (Courtesy: Kimball-Krough Pump Company.)

the selection of the plant. Etcheverry gives the following amounts of the several fuels as essential to develop 1 *brake-horse-power-hour*.

Electricity	$\frac{1}{10}$ kilowatt hour	Crude oil	6 pounds
Gasoline or distillate	$\frac{1}{4}$ gallon	Coal	10 pounds

To generate an amount of energy equal to 1 *brake-horse-power-hour*, Table X shows equivalent costs per *brake-horse-power-hour*, and for 1 acre-foot of water lifted 1 foot at two different pump efficiencies, these costs being based on the above fuel consumption.* Power companies usually base charges for electric service in part on the maximum

TABLE X
COST OF FUEL PER BRAKE-HORSE-POWER-HOUR†

Equivalent Unit Costs of Fuel				Fuel Costs (in Cents)		
Cost of Gasoline in Cents per Gallon	Cost of Crude Oil per Barrel (335 Pounds)	Cost of Coal per Ton	Cost of Electric Energy per Kilowatt Hour in Cents	Per Brake Horse Power per Hour in Cents	Per Acre-foot of Water Lifted 1 Foot High	
					50 Per Cent Efficiency	75 Per Cent Efficiency
6	\$0.55	\$2.00	1.11	1.00	2.75	1.83
8	.75	2.66	1.50	1.33	3.70	2.45
10	.93	3.33	1.85	1.66	4.60	3.05
12	1.12	4.00	2.22	2.00	5.50	3.65
14	1.30	4.66	2.60	2.33	6.40	4.25
16	1.50	5.33	3.00	2.66	7.30	4.90
18	1.67	6.00	3.33	3.00	8.25	5.50
20	1.85	6.66	3.70	3.33	9.15	6.10
22	2.05	7.33	4.10	3.66	10.10	6.70
24	2.25	8.00	4.35	4.00	11.00	7.35
26	2.42	8.66	4.80	4.33	11.80	7.95

* Bulletin No. 36 of the Division of Water Resources, State of California, Dept. of Public Works, entitled "Cost of Irrigation Water in California," contains a chapter on "Farm Irrigation Pumping Plants," prepared by C. V. Givan, which came to the author's attention after this book had gone to press. Mr. Givan reports one-eighth gallon consumption of gasoline per *brake-horse-power-hour* for gas engines with "Good performance," and one-sixth gallon with "Fair performance."

Diesel engines, according to Givan, are usually guaranteed to deliver one *brake-horse-power-hour* with a consumption of 0.06 gallon of fuel oil at full rated load, and 0.07 at half rated load.

Bulletin 36 contains detailed information of value to those interested in irrigation pumping.

† ("Use of Water in Irrigation." Etcheverry. McGraw-Hill Book Co. Publishers.)

demand of the consumer, regardless of the energy consumed, and in part on the energy actually used. The purpose of the power company is to encourage consumers to avoid high demands for electricity over short periods of time; and to get them to strive to use power as many hours per day and days per month as the conditions may justify. Consideration of a typical power-rate schedule will clarify the low energy costs of low demand and continuous use, as compared to high energy costs resulting from high demand and short-time use. The contract schedule provides a power charge of \$2.50 per horse power of maximum demand per month, and this charge includes 30 kilowatt hours per month per horse power. A 10-horse-power-motor will then cost the irrigator \$25 per month, which will include 300 kilowatt hours of energy. If the power company lines are connected during the month, or any part of it, the irrigator must pay \$25 whether or not he actually runs his pump. This is called the *demand* charge. If the irrigator runs his pump a few hours but overloads it so that he actually draws 12 horse power instead of 10, his monthly demand charge will be \$30, and this will entitle him to 360 kilowatt hours. Suppose that he runs his motor and pump with a 12-horse-power-load a period of 40 hours each month, just long enough to consume 360 kilowatt hours; the cost of energy consumed will be $3000/360$, or 8.33 cents per kilowatt hour — which is rather a high cost, equivalent approximately to gasoline at 45 cents a gallon.

The schedule for energy consumed after the demand charge is taken care of is as follows:

10 KWH	at	7¢
50	"	5¢
150	"	3¢
balance	"	1¢

Then if the irrigator operates his motor and pump thirty 24-hour days, or 720 hours per month at a continuous load of 12 horse power (9 KW), he uses a total of $9 \times 720 = 6480$ kilowatt hours, and his monthly cost will be:

DEMAND CHARGE:	\$30.00
12 horse power at \$2.50 per HP	
360 kilowatt hours included	
ENERGY CHARGE:	
360 kilowatt hours in demand	
10 KWH at 7¢	0.70
50 " " 5¢	2.50
150 " " 3¢	4.50
5910 " " 1¢	59.10
6480 kilowatt hours	\$96.80

Average cost per KWH = $9680/6480 = 1.49$ cents. Thus by operating his motor 720 hours per month instead of 40 hours per month the irrigator reduces the cost of electricity from 8.33 to 1.49, or to 18 per cent of the former cost.

It is of course apparent that any one farmer cannot as a rule use irrigation water continuously to advantage. The advantages in the use of large streams obtained by large motors and pumps partly compensate the irrigator for higher costs for electricity. On the other hand, it is frequently advantageous, where electricity is used for pumping, to provide small reservoirs in which to store the water during the night, thus making it possible to irrigate with a stream approximately twice the size of the pump discharge.

63. Irrigation Pumping Costs. — In order to make intelligent estimates of the cost of irrigation water obtained by pumping, and to compare these costs with the costs of water from gravity systems, it is customary to compute all pumping costs in terms of the amount of water delivered annually to the irrigated farm. The factors which determine the annual costs of pumped water are:

- a. Interest on capital invested in plant, i.e., on first cost.
- b. Taxes on plant.
- c. Depreciation on pumping machinery well and housing.
- d. Fuel or power and lubricating oils.
- e. Attendance.

The application of these several factors in arriving at the cost of water obtained by pumping is most clearly presented by working out typical examples. Three cases have recently been considered and illustrated by Code, one for a centrifugal pump and electric motor, one for the same type of pump driven by an engine consuming distillate for fuel, and one for a vertical turbine pump driven by an electric motor. These three cases are designated as Plant No. 1, Plant No. 2, and Plant No. 3, and the detail of the estimates are given in Table XI. Code's estimates show an annual cost per acre-foot ranging from \$2.99 to \$3.62, or an average of approximately \$3.30 per acre-foot.

TABLE XI

COST ELEMENTS AND ESTIMATES FOR THREE TYPICAL PUMPING PLANTS

Cost estimates are given below of three alternative plants. It is assumed that 140 acre-feet of water are to be pumped from a 12-inch well, 65 feet deep, in which the water level is 18 feet below the ground surface. For each the discharge will be 755 g.p.m., the lift 30 feet, and the water horse power 5.73.

PLANT No. 1. — Equipment to consist of a high-grade, horizontal centrifugal pump direct-connected to an electric motor in a pit 15 feet deep. The motor efficiency is to be 89 per cent and pump efficiency 60 per cent.

Cost of plant:

Well 50 feet deep below bottom of pit, drilling at \$2.50 per foot	\$ 125.00
Developing and extra cost because of pit	40.00
Well casing 12-inch, 16-gage, galvanized, 50 feet at \$1.20 per foot	60.00
Concrete pit, 6 by 8 by 15 feet, 6-inch walls	165.00
Five-inch pump, 10-horse-power-motor, starter, switches, piping and valves, installed	625.00
Transformers	300.00
Shelter and wiring	150.00
Total cost	1465.00

Operating cost:

Interest on \$1465 at 6 per cent	87.90
Taxes 1 per cent	14.65
Depreciation on machinery, \$655 at 6 per cent	39.30
Depreciation on well and shelter, \$510 at 4 per cent	20.40
Power consumed,* 1000 hours at 8 kilowatts per hour — 8000 kilowatt hours	230.00
Repairs, lubricating oil	7.00
Attendance	20.00
Total annual cost	419.25
Cost per acre per year	5.24
Cost per acre-foot	2.99

PLANT No. 2. — Equipment to consist of same quality horizontal centrifugal pump as in the preceding plant, driven by an engine using distillate for fuel. Pump efficiency to be 60 per cent.

Cost of plant:

Well, 50 feet deep, drilling at \$2.50 per foot	\$ 125.00
Developing and extra cost because of pit	40.00
Well casing 12-inch, 16-gage, galvanized, 50 feet at \$1.20 per foot	60.00
Concrete pit 6 by 6 by 15 feet, 6-inch walls	150.00
Five-inch pump, pipe and valves	340.00
Fifteen horse power engine, accessories and belt	625.00
Shelter and installation	300.00
Total cost	1640.00

TABLE XI — *Continued**Operating cost:*

Interest on \$1640 at 6 per cent.	\$ 98.40
Taxes, 1 per cent.	16.40
Depreciation on machinery, \$1115 at 9 per cent.	100.35
Depreciation on well and shelter, \$525 at 4 per cent.	21.00
Distillate consumed, 1½ gallons per hour for 1000 hours at 12¢ per gallon	160.00
Repairs and lubricating oil	35.00
Attendance	75.00
	<hr/>
Total annual cost.	506.15
Cost per acre per year	6.33
Cost per acre-foot	3.62

PLANT No. 3. — Equipment to consist of a vertical turbine pump direct-connected to an electric motor. The pump head is to be set on the well casing at the ground surface. The motor efficiency is to be 89 per cent and the pump efficiency 60 per cent.

Cost of plant:

Well, 65 feet deep, drilling at \$2.50 per foot	\$ 162.00
Developing	20.00
Well casing, 12-inch, 16-gage, galvanized, 65 feet at \$1.20 per foot	78.00
Pump and motor, installed	800.00
Transformers	300.00
Shelter, switches and wiring	150.00
	<hr/>
Total cost	1510.00

Operating cost:

Interest on \$1510 at 6 per cent.	90.60
Taxes, 1 per cent.	15.10
Depreciation on machinery, \$850 at 8 per cent.	68.00
Depreciation on well and shelter, \$360 at 4 per cent.	14.40
Power consumed,* 1000 hours at 8 kilowatts per hour — 8000 kilowatt hours	230.00
Repairs and lubricating oil	20.00
Attendance	12.00
	<hr/>
Total annual cost.	450.10
Cost per acre per year	5.63
Cost per acre-foot	3.22

* Cost of power is based on the following rates:

First 200 kilowatt hours per horse-power per season at 5¢ per KWH.
Next 100 kilowatt hours per horse-power per season at 3¢ per KWH.
All additional power at 2¢ per KWH.

In the Cache Valley, Utah, the customary irrigation company organization is the mutual stock company. One share of stock in most of the companies supplies enough water to irrigate 1 acre of land — from 2 to

3 acre-feet delivered to the farm. Fifty dollars is a common value of stock per share and \$1.50 per share a common annual stock assessment. On these bases the annual cost per acre-foot is computed thus:

Interest on \$50.00 at 6 per cent.	\$3.00
Annual stock assessment (irrigation company water stock is not taxed in Utah).	1.50
Total	\$4.50
Average annual amount of water delivered	2.5 acre-feet
Cost per acre-foot = 4.50/2.5 =	\$1.80

A complete or detailed consideration of costs of irrigation water is not within the purpose of this volume, and the above computations are given only for the purpose of illustrating methods of comparisons of cost of water obtained by pumping from wells and that obtained from a typical gravity canal.

64. Water Supplies for Irrigation Pumping. — In the western United States, ground waters form probably the major source of water supply for small irrigation pumping plants. The methods of drilling and developing wells to obtain ground water are briefly considered in Articles 67 to 70.

In many places the costs of conveying surface water to the farms that need it are greater than the costs of pumping from nearby water supplies. The result is that small pumping plants are used to obtain irrigation water from rivers, canals, ponds, lakes, and other surface sources. A noteworthy case of the use of surface water in irrigation pumping is briefly described herewith. More than 50 farmers in Cache Valley, which lies in northern Utah and southern Idaho, obtain water for irrigation by pumping from the Bear River. A valuable feature about the Bear River water supply is the assurance of an adequate quantity of water by the power company that supplies electrical energy for pumping. The power company, by installing a very large pumping plant at the outlet of Bear Lake, uses the Bear Lake as a storage reservoir to equalize the river flow for power purposes. After being pumped out of the Bear Lake, the stored water is commingled with the natural flow of the Bear River which generates electrical power at three points on the river before it reaches Cache Valley. Pumping water from the river in Cache Valley for irrigation purposes supplies a favorable market for power, and since the quantity of water pumped by the irrigators is small as compared to the total quantity in the river, the practice of irrigation pumping is encouraged by the power company. This source of water for pumping is economical, satisfactory, and reliable. The pumped water that is not consumed in the production of crops returns to the river and is used

to generate power at a plant a few miles below Cache Valley. The major crops produced with the pumped water are alfalfa, sugar beets, and the grain crops, wheat, oats, and barley.

65. Ground Waters. — Ground waters constitute a very important source of water for irrigation pumping. Pumping from wells for irrigation is practiced to a considerable extent in the older irrigated countries; notably Egypt and India. Pumping from wells is also practiced to some extent in nearly all the arid states of the West. According to the U. S. Census for 1930, Arizona irrigates nearly 105,000 acres with ground water obtained from wells by pumping and California irrigates almost one and one-half million acres with water thus obtained.

In the earlier days of pumping ground water for irrigation, many farmers entertained the misconception that ground-water supplies were unlimited. It is essential always in irrigation practice to avoid over-expansion of irrigated areas and thus bring on serious water shortages during periods of low precipitation. Special caution against over-development is necessary in the use of ground water for irrigation. Undue lowering of the ground-water surface results in higher lifts and frequently prohibitive pumping costs. Moreover, in cases of excessive pumping where horizontal-shaft pumps are used, which depend on suction lifts, it sometimes becomes necessary to deepen pump pits and lower the pumps in order to obtain sufficient quantities of water.

The extent of irrigation pumping from ground-water supplies should therefore be determined on the basis of thorough, long-time investigations of the quantity of annual inflow or recharge to the ground-water streams, basins, or reservoirs. Individual irrigators as a rule have neither time nor funds essential to such investigations, which must therefore be conducted by public agencies.

66. Wells. — For relatively small quantities of irrigation water, wells are sometimes dug by hand methods and lined either with lumber, concrete, brick, or stone masonry. In general, however, irrigation wells are drilled or bored by mechanical methods, using gasoline engines or other portable power equipment. Murdock groups the different methods of drilling wells into: (a) the churn or percussion method, and (b) the rotary method. In the churn method the drilling is accomplished by operating tools in an up-and-down motion, whereas in the rotary method the well is made by rotating the tools like boring with an ordinary auger. Mechanical methods of well drilling have the advantage of permitting the work to proceed in water, whereas the hand-dug wells require in some cases special provision to remove the water from the wells as the digging proceeds. The mechanical methods are especially advantageous where it is essential to make wells of considerable depth in

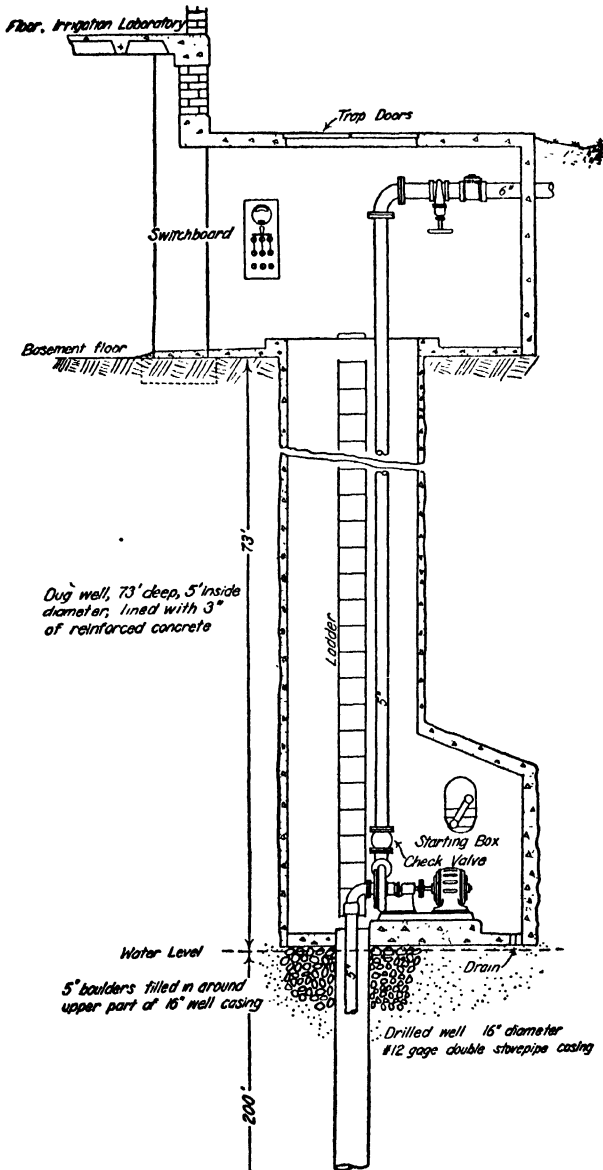

FIG. 41. — A direct-connected pumping unit in a combined pit and drilled well.
(University of Arizona Agr. Exp. Sta. Bul. 99.)

order to get a sufficient quantity of water. Drilled irrigation wells as a rule range in diameter from 6 to 40 inches. These wells are lined with sheet-metal casing, the thickness of which increases as the diameter of the well increases. In case it is desired to use a horizontal-shaft pump it is essential to dig a pit of sufficient depth to place the pump on an elevation within suction distance of the water while pumping. A com-

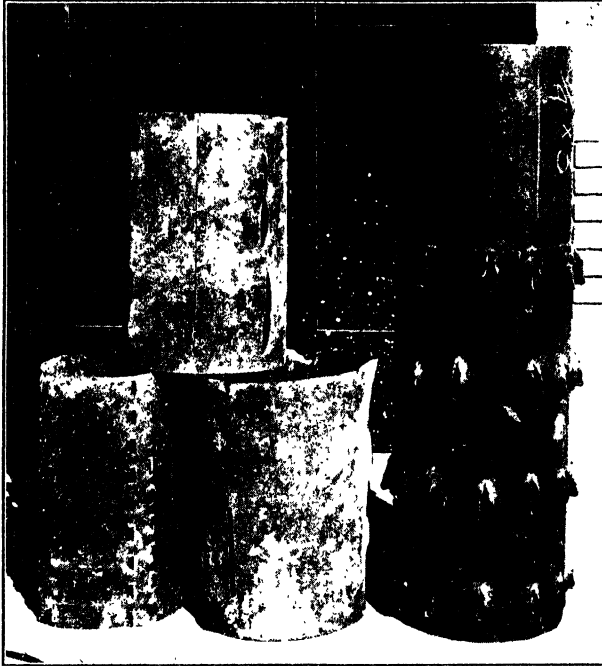

FIG. 42. — Samples of perforated casing in which the holes were made after the casing had been set in the well. The one at the right is thoroughly perforated, the one at the left fairly perforated, and the middle samples of casing are insufficiently perforated. (University of Arizona Agr. Exp. Sta. Bul. 112.)

ination of a drilled well together with a pump pit is used at the University of Arizona and is illustrated in Fig. 41. During pumping, water flows into the well through perforations in the casing commonly made after the well is drilled and the casing is placed. Great care must be exercised to assure adequate perforations of the casing without causing danger of collapse of pipe. As yet there seems to be no definite agreement among engineers as to the ratio of the total cross-section area of perforations to cross-section area of the well casing, although all agree

that adequate perforating is essential to guard against excessive loss of energy as the water flows into the well. Schwalen has assembled casings taken from wells in Arizona showing adequate, fair, and inadequate perforations as illustrated in Fig. 42.

67. Water Yield of Wells. — The size of stream of water obtained for irrigation from a well with a pumping plant is determined by one or both of two major factors, namely:

- a. The capacity of the pump and the horse power of the motor or engine; and
- b. The capacity of the well, which depends on the slope of the draw-down curve of the water surface, or pressures, the depth and effective diameter of the well, and the specific conductivity of the water-bearing material.

Pump capacities and horse-power requirements to lift given quantities of water through specified heights are well understood and may be pre-

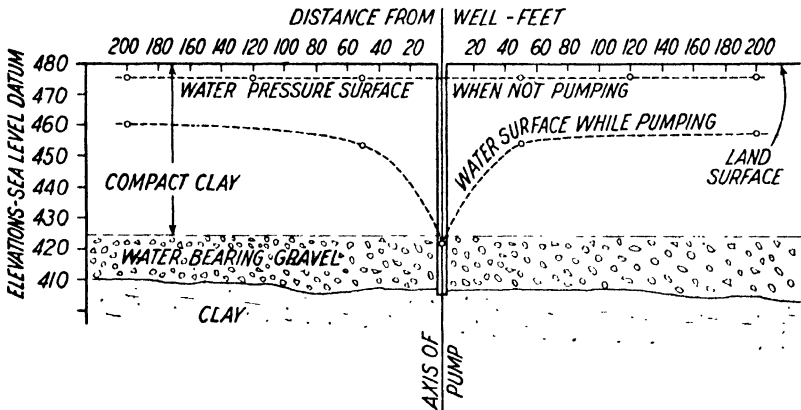

FIG. 43. — Sketch illustrating draw-down curve during pumping.

dicted with fair precision. It is far more difficult to predict the horse-power requirement to drive a specified quantity of water from the water-bearing sands or gravels into the well, because this involves the uncertain specific water conductivity (see Chapter X) of the sands and gravels through which the water flows. An illustration of a draw-down curve is shown in Fig. 43. Under conditions of rather homogeneous water-bearing sands and gravels, water flows, in general, radially toward the well. Under these conditions it moves through a series of imaginary concentric cylindrical surfaces having the well as a vertical axis. Clearly, therefore, for constant yield, as the water approaches the well its velocity must increase because the cross-section area through which it flows is

continuously decreasing. Consequently the driving force per unit mass must increase as the water approaches the well; and as the slope of the water surface is proportional to the driving force, the draw-down curve becomes steeper as the well is approached. In cases where the capacity of the pump exceeds the capacity of the well, the draw down is excessive in the immediate vicinity of the well. It is therefore desirable to provide a large "effective" diameter of well to avoid excessive draw down (or power requirements), to drive the water into the well.

68. Developing the Well. — The specific water conductivity of soils, sands, and gravels increases very rapidly with the increase in diameter of particles, as stated in Chapter X. It is therefore important that the fine particles outside the well casing be drawn into the well and brought to the surface either by pumping or by means of a sand bucket. The process of removing silts, sand, and very fine gravel so as to facilitate ready flow of water into the well is known as "developing the well." Most experienced drillers fully understand the importance of this work, and some have developed ingenious methods of washing and jetting with water and with compressed air in order to accomplish this result. One method is to plunge a sand bucket up and down near the perforations, thus drawing water into the well; another is to vary the discharge of the pump and thus cause pulsations in flow either by changing the pump speed or by regulating the discharge with valves. Development of the well is highly important to economical pumping of water for irrigation and should never be neglected. In some cases the yield of a well at a given draw down may be doubled or trebled by proper developing.

69. Battery of Wells. — In places where the water-bearing materials have low specific conductivity it is sometimes advantageous to draw water with one pump from two or more wells. This practice is illustrated in Fig. 44, in which one horizontal-shaft pump draws water from three wells at the same time. The most economical spacing of wells, where two or more are constructed to supply one pump, is a problem yet to be given thorough scientific study.

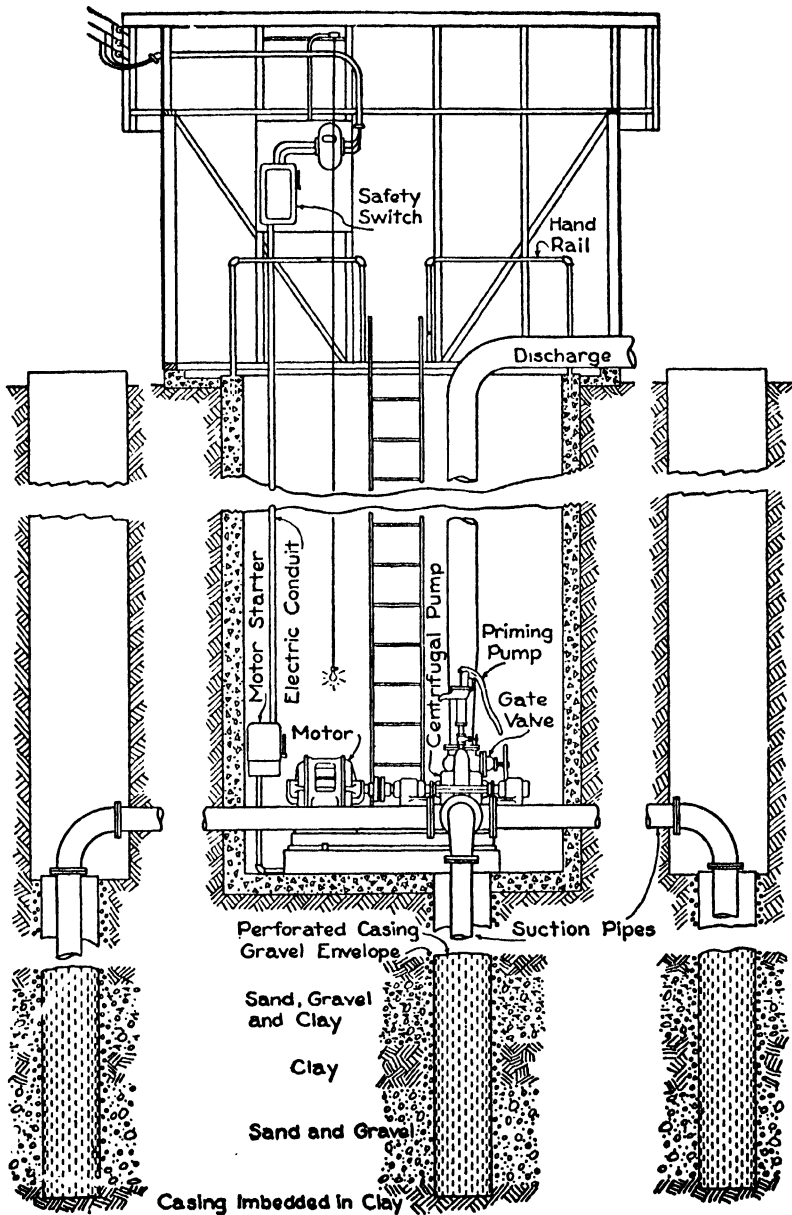

FIG. 44. — A horizontal centrifugal pump direct-connected to an electric motor in a pit, pumping from three wells simultaneously. (Colo. Agr. Exp. Sta. Bul. 350.)

REFERENCES

- BIXBY, F. L. Tests of Deep-Well Turbine Pumps, Reprint, Jour. Agr. Research, **31**, No. 3, August 1, 1925.
- BIXBY, F. L., and HARDMAN, GEORGE. The Development of Water Supplies for Irrigation in Nevada by Pumping from Underground Sources, Nevada Agr. Exp. Sta. Bul. 112. 1928.
- CODE, W. E. Suggestions Concerning Small Irrigation Pumping Plants, Colorado Agr. Exp. Sta. Bul. 350. 1929.
- EWING, PAUL A. Pumping from Wells for Irrigation, U. S. D. A. Farmers' Bul. 1404. 1924.
- ETCHEVERRY, B. A., and HARDING, S. T. The Selection and Cost of a Small Pumping Plant, California Agr. Exp. Sta. Cir. No. 117. 1923.
- JOHNSTON, C. N. Principles Governing the Choice, Operation, and Care of Small Irrigation Pumping Plants, California Agr. Exp. Sta. Cir. 312. 1928.
- JOHNSTON, CLARENCE T. Egyptian Irrigation, U. S. D. A., O. E. S. Bul. 130. 1903.
- POWERS, W. L. The Economic Limit of Pumping for Irrigation, Oregon Agr. Exp. Sta. Bul. 235. 1928.
- SCHWALEN, HAROLD C. The Stove Pipe, or California Method of Well Drilling as Practiced in Arizona, Arizona Agr. Exp. Sta. Bul. 112. 1925.
- SMITH, G. E. P. Motor Driven Irrigation Pumping Plants and the Electrical District, Arizona Agr. Exp. Sta. Bul. 99. 1924.
- WEIR, WALTER W. Effect of Pumping from Deep Wells on the Groundwater Table, Jour. Agr. Research, **34**: 663-672. 1927.

CHAPTER V

IRRIGATION METHODS

Irrigation water is applied to land in four general methods, namely: (a) flooding the surface; (b) in furrows, thus wetting only part of the surface; (c) sub-irrigation, in which the land surface is wetted little if any; and (d) spraying or sprinkling, in which the land surface is wetted much as it is by rainfall.

The several methods above mentioned are further subdivided as indicated below and as considered in the following articles.

(a). Flooding:

1. From field ditches.
2. Border.
3. Pipe.
4. Check.
5. Basin.

(b). Furrow:

1. Deep furrows for such cultivated crops as potatoes, corn, asparagus, and orchards.
2. Corrugations or shallow furrows for grains, alfalfa, and sugar beets.

(c). Sub-Irrigation:

1. Controlled by lateral supply ditches.
2. Uncontrolled by excess application of water to higher lands.

(d). Spraying or Sprinkling.

70. Primitive and Modern Flooding.— In the early irrigation of centuries past, throughout Asia and southern Europe, it seems that water was generally applied by flooding extensive areas of rather smooth, flat land. In Egypt especially, the flooding method was of general adoption, the water being forced to spread over vast tracts, especially during the season of high water.

In modern American irrigation, several improved flooding methods have been developed, namely: ordinary flooding from 1320 feet long, border flooding, pipe distribution, check and basin border method. Descriptions of each of these flooding methods are given in paragraphs.

The primitive methods of flooding large tracts of soil as it advances. flat lands are yet in use on some of the larger soil of rather irregular

Notably in parts of the San Joaquin Valley, California, thousands of acres of pasture lands are flooded during high-water periods by the use of only crudely built levees and ditches. In these primitive methods of flooding large areas, but little if any attempt is made to use water efficiently. This type of flooding is sometimes designated "wild flooding."

71. Ordinary Flooding from Field Ditches. — Where water is applied to the land from field ditches without any levees to guide its flow, or otherwise restrict its movement, the method is designated ordinary flooding. It is practiced largely in the Rocky Mountain states, especially in the places where irrigation water is relatively abundant and inexpensive.

Clearly the objective in all ordinary methods of irrigation is to store enough water in the soil at each application to supply the needs of the

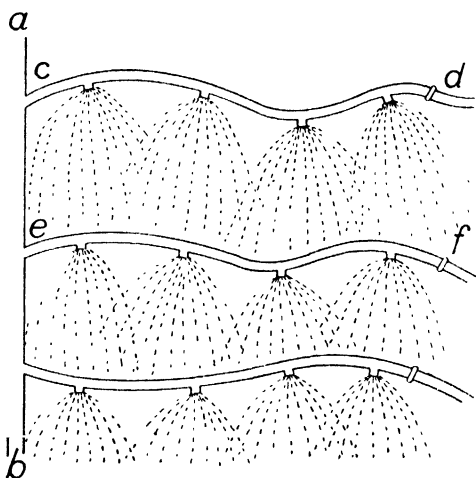

FIG. 45. — A common method of locating field ditches in the Mountain States. (U. S. Dept. Agr. Farmers' Bul. 1630.)

crop until the time of the next irrigation. The number of days between irrigations is therefore dependent primarily on the storage capacity of the soil for water and on the rate of use of water by the crop, topics which are considered in Chapters IX and XIII. It is important here to note that, in some of the flooding methods, i.e., ordinary, border, and pipe flooding, the storage capacity of the soil should be satisfied by water percolating into the upper few feet of soil during the time it is flowing over the

land surface. If the water is made to flow too quickly over the surface, an insufficient amount will percolate into the soil. On the other hand, if it is kept on the surface too long, waste will result from evaporation into the deep subsoil, gravels, or water table. It is an important and difficult problem to balance the application of these flooding methods so as to attain a high efficiency in its use. The size of stream used, the depth of water as it flows over the surface, the permeability of the soil, all influence this balance of water, as is shown more fully in Article 74.

much depends on the smoothness of the land sur-

face, the proper size of irrigation stream, and the attention and skill of the irrigator, but at best it is difficult with this method to attain a high efficiency in irrigation.

This method is extensively practiced for irrigation of grain and forage crops in the Rocky Mountain states. The water is brought to the field in permanent supply ditches and distributed from ditches built across the field as shown in Fig. 45, or from parallel ditches built down the steepest slope as shown in Fig. 46.

Distribution ditches across the field are spaced from 50 to 150 feet apart, depending on the grade of the land, the texture and depth of the soil, the size of stream, and the nature of the crop. Likewise the distances between the diversions from ditches down the steepest slope are similarly determined.

Flooding from field ditches is well adapted to

some lands that have such irregular surfaces that the other flooding methods cannot be used. However, even on lands that may advantageously be irrigated by the other flooding methods, irrigators continue to use the ordinary one because of the relatively low initial cost of preparation of land for this method. It is probable that the extra labor cost in the application of water, and the greater losses of water by surface run-off and deep percolation, offset the apparent advantages of low initial cost of preparation of land. As water becomes more valuable and labor becomes more abundant, the ordinary flooding method will doubtless be replaced by more efficient methods on land which are suitable for them.

72. Border-Strip Flooding. — Dividing the farm into a number of strips, preferably not over 30 to 60 feet wide and 330 to 1320 feet long, separated by low levees or borders, is designated the border method. Water is turned from the supply ditch into these strips along which it moves slowly toward the lower end, wetting the soil as it advances. An example of the border method adapted to a soil of rather irregular topography is shown in Fig. 47b.

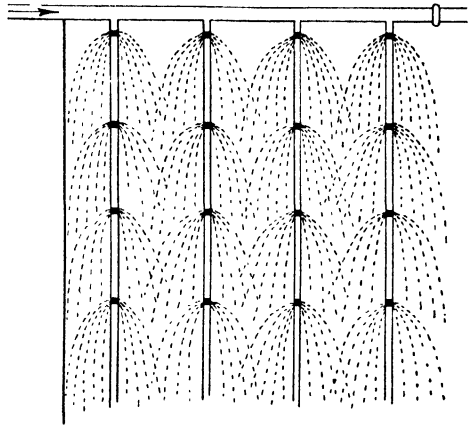

FIG. 46. — Flooding fields from parallel field ditches. (U. S. Dept. Agr. Farmers' Bul. 1630.)

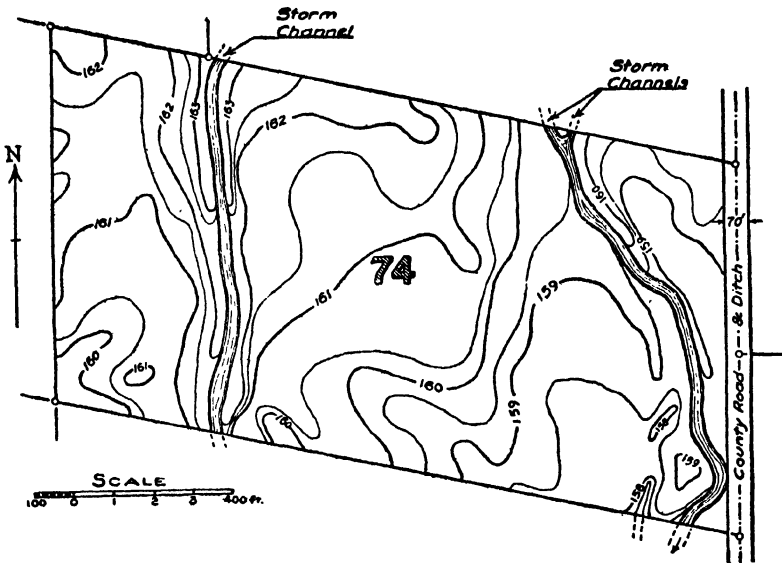

FIG. 47a. — Farm lot enlarged, showing contours. (Figs. 47 to 50, inclusive, are from U. S. Dept. Agr. Farmers' Bul. 1243.)

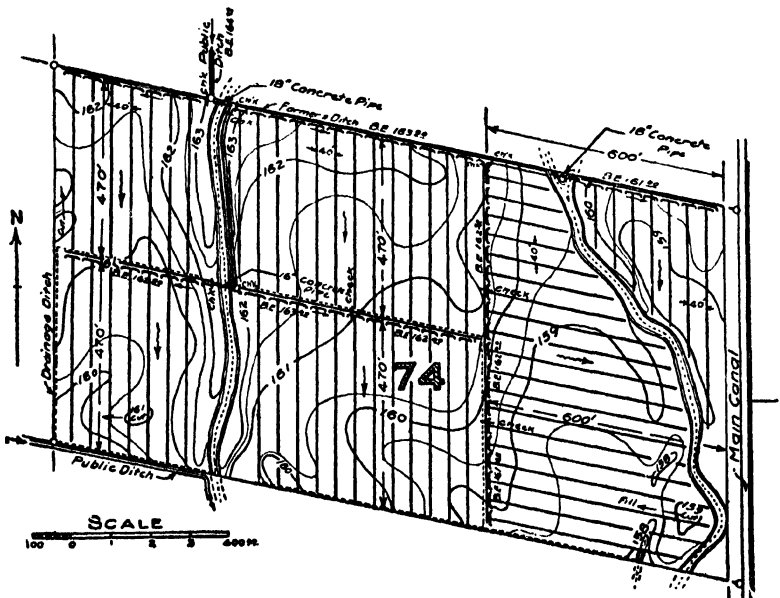

FIG. 47b. — Showing size and direction of border strips and the necessary supply ditches and draws.

Fig. 47a shows the farm lot No. 74 of the California State Durham Colony before it was prepared for irrigation. The contours indicate that the highest land is on the north border in the west half of the tract. In preparing the tract for irrigation by the border-strip method the agricultural engineers divided it into three fields as shown in Fig. 47b. The border strips in each field are 40 feet wide. In the west fields they are 470 feet long; and in the east field, because of the irregular position of the storm channels, the border strips vary in length from a minimum of approximately 150 feet to a maximum of nearly 500 feet. While irrigating the west two fields, the water flows from north to south, and in the east field it flows in two directions, as indicated by the position of the borders and the pointing of the small arrows.

The surface is essentially level between levees, so that the advancing sheet of water covers the entire width of land strip; but lengthwise of the levee the surface slopes somewhat according to the natural slope of the land. It is desirable, though not urgently essential, that the slope be uniform within each levee.

The border method permits wide variation of slopes in the direction of the water flow. If practicable, it is best to make the border slope from 2 to 4 feet per 1000 feet; but slopes as low as 1 foot per 1000 and as high as 75 feet per 1000 may be used where it is impracticable to obtain the more appropriate slopes. Special care is essential to prevent erosion of soil where the higher slopes are used.

The size of stream turned into a single border varies from $\frac{1}{2}$ to 10 c.f.s., depending on the kind of soil, the size of border, and the nature of the crop. The influences of the soil permeability and the size of border are considered in Articles 73 and 74.

Because of the relatively high initial cost of preparing land for the border method, it is desirable so to plan the location of the levees and strips that different forage and grain crops may be irrigated with the same borders. Crops which are to be furrow-irrigated, such as sugar beets, potatoes, and corn, may be grown on land on which the forage crops have been irrigated by the border method. Provided the soil conditions are favorable to lateral water movement underneath the low, broad border levees, it is practical to plant and mature crops on the levees. It is difficult to furrow the levees satisfactorily and to keep irrigation water in furrows on the levees.

The border method is suitable to soils of rather wide variation in texture. It is important, however, to study the physical soil properties in advance of preparing land for border irrigation. Rather impervious subsoils overlain by compact loams permit long border strips, whereas open soils having porous gravelly subsoils necessitate short narrow strips.

At the head of each border strip a gate is placed into the supply ditch for convenience in turning water into and out of the strip. The use of an inexpensive ridger for smoothing and completing the levees for border irrigation in the Snake River Valley, Idaho, is illustrated in Fig. 48. Newly made borders on the Hoover farm near Wasco, California, are shown in Fig. 49, and Fig. 50 typifies the small, closely spaced borders used for soils of high permeability on the Umatilla Project in Oregon.

73. Time Rate of Application of Water. — In applying water to the soil by the several flooding methods, the irrigator endeavors to cause enough water to percolate into the soil fully to moisten it to the proper

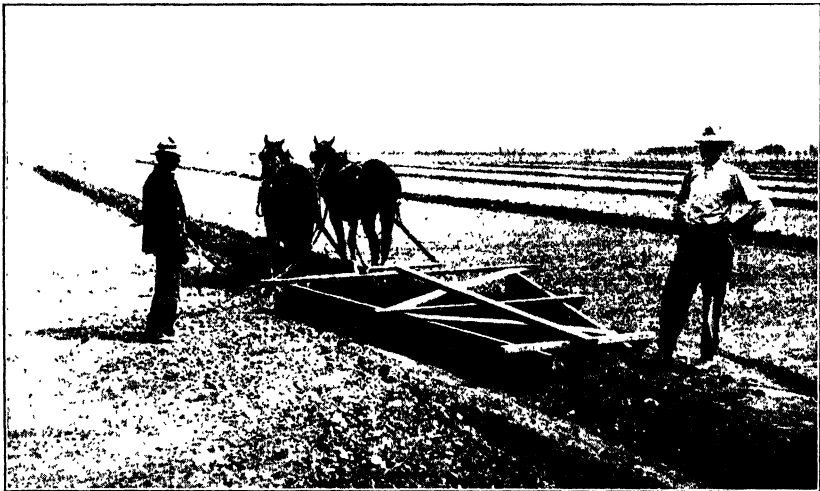

FIG. 48. — Preparing land for the border method of irrigation near Twin Falls, Idaho.

depth during the time that the sheet of water is flowing over the land surface. In furrow irrigation, especially in the use of shallow furrows, the irrigator is guided by the same objective. Ponding water on the land in order to assure its adequate percolation into the soil as a rule is impracticable in connection with either the flooding or the furrow methods. It is therefore desirable that the size of irrigation stream applied to unit area of land be varied according to the permeability of the soil to water. (See Chapter X for definition of the term *permeability*.)

When large streams are applied to unit area of soils of low permeability, excessive surface run-off occurs; whereas when small streams are applied to unit area of soils of high permeability excessive amounts of water are lost through deep percolation. The relation between size of



FIG. 49. — Newly made borders on the Hoover farm near Wasco, Calif.

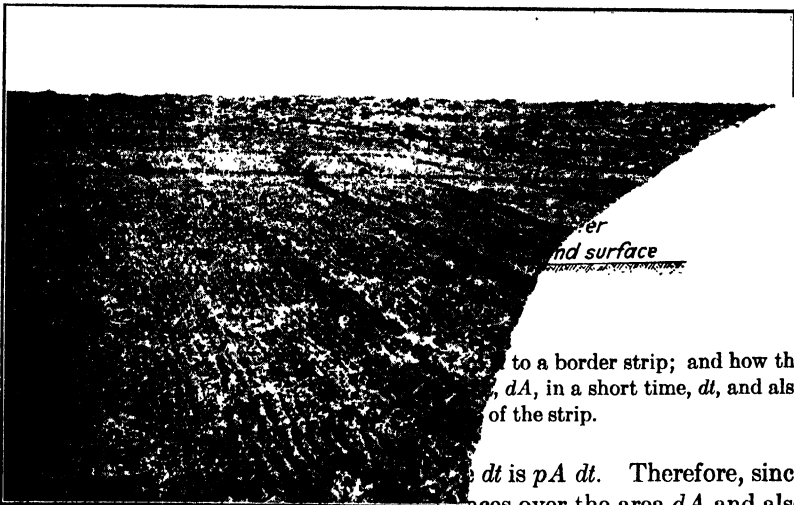

FIG. 50. — Small borders for porous soils as prepared in Oregon.

to a border strip; and how the area, dA , in a short time, dt , and also the length of the strip.

Since dA is $pA dt$. Therefore, since the water flows over the area dA and also

$$pA dt \dots \dots \dots (29)$$

$$\bar{A} \dots \dots \dots (30)$$

stream used, area of land irrigated with a given stream, and the rate of application can be most easily stated by use of a simple equation.

Let A_r = area in acres irrigated in a single run without turning the stream, e.g., in a border strip or a check.

q = the quantity of water in c.f.s. or acre-inches per hour turned into a single strip or check.

R = time rate of application in c.f.s. per acre based on the area irrigated in a single run, A_r .

The time rate of application is defined as the ratio of q to A_r , i.e.,

$$R = q/A_r$$

A study of the relation of R to the average depth, d , required to cover all the surface of a 1-acre border strip in Sacramento Valley, California, having a slope of 3 feet per 1000 feet, shows that, as the time rate increases, the required depth decreases. The results of the experiment are as follows:

RATE OF APPLICATION	DEPTH OF WATER REQUIRED, INCHES
R	d
4.6	33.0
10.1	22.3
13.5	13.9
15.3	10.1
17.8	8.3

74. Analysis of Time to Cover a Given Area with Water. — Consider a strip or other tract irrigated by flooding a thin sheet of water. Provided the soil permeability is approximately uniform the plot, the sheet of water advances most rapidly into the plot, and the amount of water going onto dry land gradually increases. In furrow irrigation the average depth of the over-irrigator is guided by the permeability are known, and if they are known in order to assure its adequacy by mathematical analysis the approximate depth during the time that the water is applied to the strip of land, as illustrated in Fig. 48. — Preparing land for irrigation.

When large streams are applied to unit area of land by flooding, excessive surface run-off is a serious problem. The amount of water going onto dry land gradually increases. In furrow irrigation the average depth of the over-irrigator is guided by the permeability are known, and if they are known in order to assure its adequacy by mathematical analysis the approximate depth during the time that the water is applied to the strip of land, as illustrated in Fig. 48. — Preparing land for irrigation.

When large streams are applied to unit area of land by flooding, excessive surface run-off is a serious problem. The amount of water going onto dry land gradually increases. In furrow irrigation the average depth of the over-irrigator is guided by the permeability are known, and if they are known in order to assure its adequacy by mathematical analysis the approximate depth during the time that the water is applied to the strip of land, as illustrated in Fig. 48. — Preparing land for irrigation.

When large streams are applied to unit area of land by flooding, excessive surface run-off is a serious problem. The amount of water going onto dry land gradually increases. In furrow irrigation the average depth of the over-irrigator is guided by the permeability are known, and if they are known in order to assure its adequacy by mathematical analysis the approximate depth during the time that the water is applied to the strip of land, as illustrated in Fig. 48. — Preparing land for irrigation.

p = rate at which water percolates into the soil of the wetted area in acre-inches per acre per hour, or simply surface inches per hour.

q = quantity of water in acre-inches per hour (c.f.s.) turned on to the strip.

t = time in hours, after the water was turned onto the land.

y = average depth of water in inches as it flows over the land.

The volume of water that flows into a border strip or onto the land in any given short time, say 1 minute, is disposed of in two ways:

1. Part flows down the strip and covers more land.
2. Part percolates into the soil.

The volume that flows into the strip in a time, dt , seconds is $q dt$. The volume that flows past any given point to wet more land is $y dA$. The

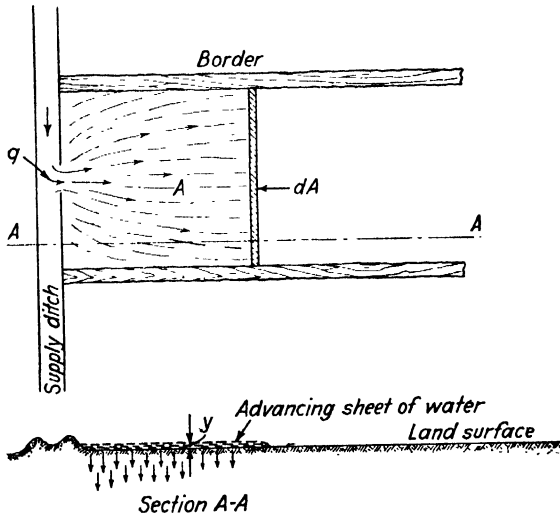

FIG. 51. — Illustrating irrigation water being applied to a border strip; and how the water moves forward to cover a very small area, dA , in a short time, dt , and also how it percolates into the soil of the upper part of the strip.

volume that percolates into the soil in time dt is $pA dt$. Therefore, since in the differential time, dt , the water advances over the area dA and also percolates into the soil of the area, A , at a rate p , it is evident that:

$$q dt = y dA + pA dt \dots \dots \dots (29)$$

and,

$$dt = \frac{y dA}{q - pA} \dots \dots \dots (30)$$

Integrating equation (30), solving for and eliminating the constant of integration, and converting from the natural logarithms to the common system of logarithms, there results, provided y and p are considered constant:

$$t = 2.303 \frac{y}{p} \log \frac{q}{q - pA} \dots \dots \dots (31)$$

The percolation rate, p , is not rigidly constant. It varies somewhat from time to time at a given *place*; and at a given *time* it varies from place to place in the field. Also p may vary slightly owing to change in the depth, y ; but the variation due to this cause is probably of no significance. To illustrate the use of equation (31), assuming p and y are constant,

let $A = 0.5$; $p = 2.0$; $q = 1.5$; $y = 2.5$

Then

$$t = 2.303 \times 2.5/2.0 \times \log 1.5/(1.5 - 2.0 \times 0.5) = 1.37 \text{ hours}$$

If the area were increased to 0.7 acre, all other factors remaining constant, it would require nearly 3.4 hours to cover the strip, during which an average depth of 7.2 inches of water would be applied. For an area greater than 0.7 acre the time and depth requirement increase rapidly, and the maximum area that could be covered, under conditions as given above, is 0.75 acre. There are as yet only meager experimental data with which to determine the rate and extent of variation of p and y with time. Until further data are obtained by experiment to verify equation (31) it is valuable only as indicating the trend of change in time required to cover different areas. In its present form it cannot be relied on for accurate results, largely because the quantities y and p , which are considered constant in the foregoing analysis, really vary during the time of irrigation.

75. Experiments on Time to Cover Different Areas with Water. —

Valuable field experiments have been conducted in the Snake River Valley, Idaho, by Bark as reported by Fortier. In the first experiment a border strip of clover land 49.5 feet wide and 2359 feet long was divided into 7 sections, each 337 feet long, containing 0.383 acre. A stream of 2.28* c.f.s. was turned into the strip at the upper end and allowed to flow 23.7 hours in order to cover the entire area of the strip 2.684 acres. The time required for water to reach the lower end of each of the 7 divisions is reported in Table XII. Column 2 shows the length of strip covered and column 3 the area of land covered by the

* Fortier reports q as "approximately 2½ c.f.s." According to the author's computations, q must equal 2.28 c.f.s. to conform to other experimental data reported.

2.28 c.f.s. stream during the respective time periods given in column 5. Column 4 shows that the time rate of application decreases from 5.8 to 0.8, and the area is increased from 0.383 to 2.684 acres; and column 6 shows that the decreases in rate necessitated an increase in mean depth of irrigation from 8.1 to 20.2 inches. The results given in Table XII suggest that a rate of application higher than 5.8 would have been better suited to the conditions because 8 inches is rather a large single irrigation. Doubtless $\frac{3}{4}$ or more of the 20.2-inch irrigation was lost through deep percolation.

TABLE XII

TIME, AND DEPTH OF WATER, REQUIRED TO IRRIGATE TWO STRIPS OF LAND NEAR RIGBY, IDAHO, WHEN WATER WAS APPLIED AT DIFFERENT RATES

1 No. of Divisions Covered in One Run	2 Length of Strip Covered, Feet	3 Area of Plot Covered, Acres	4 Rate of Application q/A	5 Time Required, Hours	6 Average Depth of Water Re- quired to Cover the Area, Inches
<i>(a) Clover Tract:</i>					
1	337	0.383	5.8	1.37	8.1
2	674	0.767	2.9	3.20	9.5
3	1011	1.150	1.9	5.20	10.3
4	1348	1.534	1.5	7.70	11.4
5	1685	1.917	1.2	10.70	12.7
6	2020	2.300	1.0	16.70	16.5
7	2359	2.684	0.8	23.70	20.2
<i>(b) Alfalfa Tract:</i>					
1	327	0.70	10.0	0.75	7.4
2	654	1.41	5.0	1.66	8.2
3	980	2.13	3.3	2.83	9.2
4	1307	2.88	2.4	4.25	10.2
5	1634	3.63	1.9	6.25	11.9
6	1960	4.39	1.6	8.25	13.0
7	2287	5.17	1.4	10.50	13.9
8	2566	5.72	1.2	13.25	16.0

The second experiment reported by Bark was conducted on an alfalfa border strip also near Rigby. The strip was 92 feet wide and 2566 feet long. It was divided into 7 plats each nearly 327 feet long, and a shorter plat approximately 280 feet long, at the lower end. A continuous stream of approximately 7 c.f.s. was run into the strip until it was completely

irrigated. The results of the experiment are presented in part *b* of Table XII. Had this long strip been divided into 3 strips, each 855 feet long, by making 2 additional cross ditches it could probably have been amply irrigated in less than one-half the time actually required. The 7.4-inch irrigation applied to the upper division was doubtless a liberal depth.

By constructing a tank 6 feet deep with a device for collecting the deep percolation losses, Bark found that more than four-fifths of the 6.6 feet applied by an irrigation farmer during a season was lost through deep percolation. He found during the following year that 10 light irri-

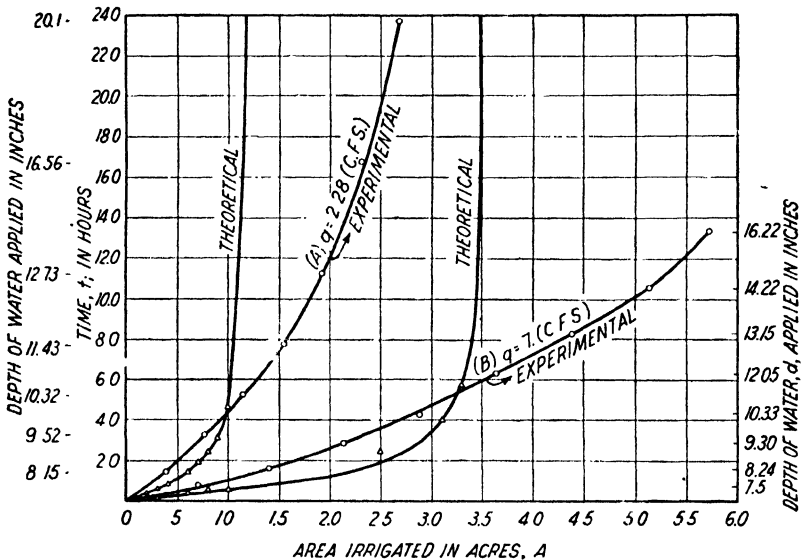

FIG. 52. — Relation of area covered and depth of water applied to time required in irrigation of border strip in Idaho.

gations of the soil in the tank produced at the rate of over 7 tons of alfalfa per acre. The total depth of water applied was 18 inches, the average depth per irrigation being only 1.8 inches.

The relations of time required and average depth of water applied to the area irrigated in a single run, as given in Table XII, are graphically presented in Fig. 52. The theoretical time and depth requirements computed from equation (31) with assumed values of γ and p are also shown in Fig. 52. The relative positions of the theoretical and experimental curves suggest that p decreases as time increases. The experimental observations of permeability reported in Chapter X also indicate that the soil is more permeable when water is first applied than later.

The results of the Idaho experiments and of the California experiments stress the fact that with porous soils irrigation water must be applied in large streams to small plats in order to prevent excessive deep percolation losses. In other words, canal company water deliveries, farm ditches, and land preparation must be so planned that irrigators may apply water to highly permeable soils at a high time rate (q/A) probably from 10 to 25 c.f.s. per acre, to avoid excessive deep percolation.

76. Check Flooding. — The check-flooding method consists of running comparatively large streams into relatively level plots surrounded by levees. This method is especially well suited to very permeable soils which must be quickly covered with water in order to prevent excessive

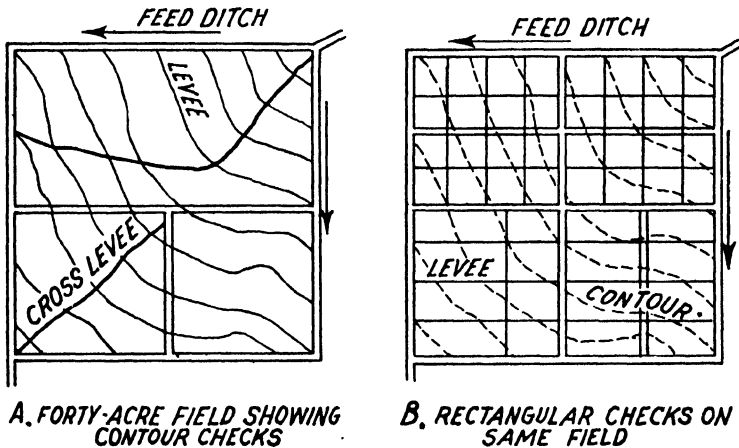

FIG. 53. — From "Use of Water in Irrigation" by Fortier. (Courtesy: McGraw-Hill Book Company.)

losses near the supply ditches through deep percolation. It is also suited to heavy soils into which water percolates so slowly that they are not sufficiently moistened during the time a sheet of water flows over them, making it necessary to hold the water on the surface to assure adequate penetration.

Checks are sometimes prepared by constructing levees along contours having vertical intervals of 0.2 to 0.4 foot and connecting these with cross levees at convenient places. These are called contour checks. A 40-acre field with contour checks is illustrated in Fig. 53a. A plan for rectangular checks on the same field is shown in Fig. 53b.

Rectangular checks, now more extensively used than contour checks, are formed by building longitudinal levees on straight lines approxi-

mately parallel to the contours, and connecting them at desirable places with levees at right angles to them.

The check method of irrigation for grain and forage crops is advantageous in localities where large irrigation streams are available and also on projects which depend on direct flow from widely fluctuating streams. In Arizona, New Mexico, and parts of California, torrential summer rains suddenly make swollen streams which must be quickly applied to the land to prevent loss of the water.

On land of very small slopes the area of each check may be several acres. In general, checks over $2\frac{1}{2}$ to 3 acres are considered less desirable than checks from $\frac{1}{2}$ acre to 2 acres.

The levees should be from 6 to 8 feet wide at the base and not over 10 to 12 inches high, because it is essential to avoid obstruction to farm machinery, and also to assure satisfactory growth of crops on the levees.



FIG. 54. — Basin irrigation in Santa Clara Valley, Calif. (U. S. Dept. Agr. Office File.)

77. Basin Flooding. — The basin method of flooding is essentially the check method especially adapted to irrigation of orchards. Usually a basin is made for each tree, but under favorable conditions of soil and surface slope, from 2 to 4 trees are included in one basin. From the supply ditch the water is conveyed to the basin, either by flowing through one basin and into another, or preferably small ditches are constructed so that the water may be turned directly from a ditch into each basin, as shown in Fig. 54, and in Fig. 168.

78. Distribution of Water. — To irrigate efficiently it is essential to distribute water uniformly, to avoid ponding and excessive deep percolation losses on one part of the field and inadequate wetting of the soil on another part. The desired objective in each irrigation by flooding is fully to moisten the soil under every square foot of land surface without permitting excessive deep percolation losses through the soil in any part of the field. Large surface run-off losses at the lower part of the field are likewise wasteful, as a rule, but these losses are so easily detected that little attention need be given them here. The objective above stated is admittedly difficult of attainment, particularly in those flooding methods in which the soil is wetted by causing a sheet of water to flow slowly over the land surface, i.e., the wild flooding and the border-strip flooding methods. Likewise, in the furrow method, which is described in Articles 81 to 83, it is difficult fully to moisten the soil and at the same time prevent excessive deep percolation. Detailed consideration of efficiencies in irrigation is given in Chapter XVIII. However, it is desirable at this point that the student become familiar with a method of accounting approximately for the water used in each irrigation as a means of estimating what portion of the water applied is actually stored in the soil for use by growing crops.

79. Estimating Water Disposal. — If the irrigator knows the size of stream delivered to his farm it is a simple matter to compute the average depth of water applied to a given area of land in a certain time. To illustrate:

Let q = the size of stream in c.f.s. (or acre-inches per hour).

a = the area of land irrigated in acres.

t = the time in hours required to irrigate the area.

d = the depth in inches that the amount of water used would cover the land irrigated if quickly spread uniformly over its surface.

The quantity in c.f.s. (or acre-inches per hour) multiplied by the time in hours equals the total number of acre-inches used. Also the number of acres covered, times the depth, in inches, equals the total number of acre-inches applied. Hence

$$da = qt \dots \dots \dots (32)$$

It is apparent that if the irrigator knows any three of the above quantities he can easily determine the other one. For convenience, however, Tables XIII, XIV, and XV (given near the end of this chapter), all of which are based on equation (32), may be used to determine directly for a 1-acre tract either the depth, d , size of stream, q , or time in hours, t ,

respectively, when each of the other factors is known. For example, Table XIII shows that a stream of 1.8 c.f.s. running 3 hours would uniformly cover 1 acre to a depth, d , of 5.4 inches. Table XIV shows, for example, that to cover 1 acre uniformly to a depth of 6 inches in 5 hours would require a stream of 1.20 c.f.s. Table XV shows, for example, that with a stream of 2.0 c.f.s. it would require 3.5 hours to supply enough water to cover 1 acre to a depth of 7 inches.

In Chapter IX it is shown that ordinary soils seldom retain an average of more than 1 acre-inch of water in each acre-foot of soil from a single irrigation. Consider, for example, a table or bench-land soil 4 feet in depth underlain by coarse sand and gravel. If the irrigator finds that under the method he is using it takes 4 hours to irrigate 1 acre using a stream of 2.8 c.f.s. he may determine from equation (32) or Table XIII that he has applied enough water to cover the land to a depth of 11.2 inches. Since the soil will hold only 4 acre-inches — the underlying sand and gravel being of great depth and having negligible capacity to hold water in the capillary form — it follows that the irrigator sustains a deep percolation loss of over 7 acre-inches, and that he must modify his method of application in order to apply water more efficiently.

80. Advantages of the Furrow Method. — In the five irrigation methods thus far described, almost the entire land surface is wetted in each irrigation. Using furrows as shown in Fig. 55 for the irrigation of some soils and crops necessitates the wetting of only a part of the surface — from one-half to one-fifth — thus reducing evaporation losses, lessening the puddling of heavy soils, and making it possible also to cultivate the soil sooner after the irrigation is completed.

Nearly all row crops are irrigated by the furrow method. In Washington, parts of Idaho, and southern Utah, grain and alfalfa crops are commonly irrigated by the use of small furrows designated as corrugations. These corrugations are especially advantageous when the available irrigation streams are small, and also for land of uneven topography. Furrow irrigation is adaptable to a great variation in slope. It is customary to run the furrows down the steepest slope, thus avoiding inconvenience due to overflowing the banks of the furrows.

81. Lengths of Furrows. — On some soils, furrows having slopes of 100 to 150 feet per 1000 feet are successfully used by allowing only very small streams to enter the furrow, and by careful inspection to control erosion. Slopes of 10 to 30 feet per 1000 feet are preferable, but many different classes of soil are satisfactorily irrigated with furrow slope from 30 to 60 feet per 1000 feet.

The length of furrows varies from 100 feet or less for gardens to as much as $\frac{1}{4}$ mile for field crops. In Utah, very few irrigators use furrows

more than 660 feet; lengths of 300 to 500 feet are far more common. Excessive deep percolation losses near the supply ditches result from use of long furrows on porous open soils.

82. Spacing and Depths of Furrows. — Spacing of furrows for irrigation of corn, potatoes, sugar beets, and other row crops is determined by the proper spacing of the crop, one furrow being provided for each row.



FIG. 55. -- Furrow irrigation in Snake River Valley, Idaho. (Photographer unknown.)

In orchard irrigation, furrows may be spaced from 3 to 6 feet apart. Soils having unusually favorable capillary properties, or impervious subsoils, may permit orchard furrows 10 to 12 feet apart. With the greater spacing it is essential to make borings with a soil auger or tube to assure adequate lateral moisture movement from furrows.

Furrows from 8 to 12 inches deep facilitate control of water and penetration into the more impervious soils. They are well suited to orchards and to some furrow crops. Other furrow crops as sugar beets are best irrigated with furrows from 3 to 5 inches deep. It is highly desirable in irrigating sugar beets and similar root crops to have the furrows deep

enough, and the stream in each small enough, so that the water cannot come in contact with the plant.

83. Water Distribution to Furrows. — Water is distributed to the furrows from earth supply ditches or from wood or concrete flumes or concrete pipe placed under the ground. In Utah and Idaho the earth supply ditch is most commonly used. Small openings are made through the bank and the water flows into one or more furrows. Fig. 56 shows four corrugations supplied from a single outlet. This method necessitates rather careful supervision to avoid erosion of the supply ditch openings, and consequent excess flow in some and diminution in others.



FIG. 56. — Four corrugations supplied from single outlet. (U. S. Dept. Agr. Farmers' Bul. 1348.)

On the other hand, it provides large flexibility, permitting a rather large stream in each furrow when the water is first turned in, thus wetting the furrow through its entire length quickly, and then decreasing it so that just enough water enters the furrow to keep it wet, and at the same time reducing the run-off from the lower end to a minimum, or preventing it entirely. Similar control of the streams from wood or concrete flumes, or through lath tubes or pipes, in the bank of the earth ditches demands equal supervision by the irrigator.

In California, Oregon, and Washington, particularly in orchard irrigation, the earth supply ditch has been largely replaced by small wood or concrete flumes or concrete pipes underground. Typical supply flumes with small turnouts are shown in Fig. 57.

84. Natural Sub-Irrigation. — In a few localities, natural conditions are favorable to the application of water to soils directly under the surface, a practice known as sub-irrigation. An impervious subsoil at a depth of 6 feet or more, a porous loam or sandy loam surface soil, uniform topographic conditions, and moderate slopes favor sub-irrigation. Under such conditions, proper water control to prevent alkali accumulation or excess water-logging usually results in economical use of water, high crop yields, and low labor cost in irrigation.

California has several large tracts of low-lying lands in the Sacramento-San Joaquin Delta that are successfully sub-irrigated. Before being

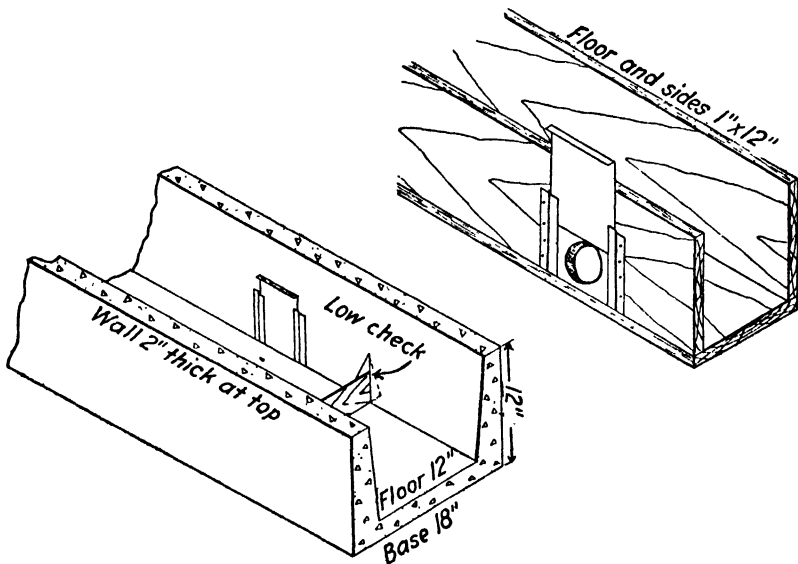

FIG. 57. — Low check in concrete flume and turnout in wooden flume. (New Mex. Agr. Exp. Sta. Circular 92.)

reclaimed some of these tracts were flooded every year by the overflow waters of the Sacramento and San Joaquin rivers. Reclamation was made possible by building large levees around tracts of several thousands of acres, followed by installing drainage systems and by pumping the water discharged from the drains over the levees into the river channels. The soils are composed largely of decayed organic matter and are known as peat, tule, or muck soils. During several months of each year, the water in the river channels, now controlled by artificial levees, is 2 to 10 feet or more higher than the land surface. In order to obtain water for irrigation, siphons are built from the channels over the levees and the

water is thus siphoned to the lands. It is distributed in a series of ditches from 2 to 3 feet deep and 1 foot wide having vertical sides. These ditches, spaced from 150 to 300 feet apart, provide adequate distribution of the water satisfactorily for irrigation of small grains and root crops.

In the Rocky Mountain states there are three notable areas on which natural sub-irrigation is successfully practiced, namely: the Egin Bench area in upper Snake River Valley, Idaho; Cache Valley, Utah; and San Luis Valley, Colorado. The conditions and procedure in the application of water are typified by the Egin Bench, Snake River Valley practice, which is described below.

85. Conditions on Egin Bench, Idaho. — The land slopes uniformly about 2 feet per 1000 feet. Surface loams and gravelly loams from 1.5 to 6 feet in depth are underlain by more porous materials which rest on impervious lava rock at depths varying from a few feet to as much as 90 feet. Early in the agricultural development of the area, attempt was made to irrigate the land by the usual flooding methods. Excessive deep percolation losses resulted, and frequent irrigation was found essential to ordinary crop yields. The gradual rise of the water table convinced the irrigators that smaller quantities of water would suffice under more favorable irrigation methods. Irrigation water is now applied in shallow ditches about 3 feet wide and spaced from 100 to 300 feet apart. In general, these ditches do not exceed $\frac{1}{4}$ mile in length. A stream from $\frac{1}{4}$ to $\frac{1}{2}$ c.f.s. is run into each ditch, from which it sinks to the ground water, causing the water table to rise high enough to moisten the root zone soil by capillary action and thus fully supply the water needs of the growing crops.

86. Sub-Irrigation and Drainage. — In some localities, natural drainage is insufficient to carry away the excess water applied in sub-irrigation. It has recently been found necessary in the Cache Valley area at Lewiston, Utah, to construct large open drains to prevent excessive water-logging and alkali accumulation. In certain favorable parts of large irrigated valleys such as the San Joaquin Valley, California, and the Salt River Valley, Arizona, where deep percolation from the flooding irrigation methods has resulted in the rise of the ground water to the extent that drainage by pumping has been found essential to maintain the soil productivity, it is possible that sub-irrigation methods may advantageously be employed.

87. Artificial Sub-Irrigation. — Under very favorable soil conditions for the production of high-priced crops on small areas a pipe distribution system is placed in the soil well beneath the surface. The process of applying water beneath the soil surface through various kinds of pipes or

other conduits is designated artificial sub-irrigation. Favorable soil conditions permitting free lateral movement of water and relatively rapid capillary movement are essential to the mechanical success of artificial sub-irrigation. Persons who are not informed concerning the several methods of irrigation are sometimes prone to over-value the advantages of artificial sub-irrigation and make expenditures on sub-irrigation systems far greater than economic results justify. The cost of this method of irrigation is usually prohibitive.

88. Conditions Favorable to Spray Irrigation. — Spray irrigation consists in applying water to the surface of the soil in the form of a fine spray somewhat as it comes in ordinary rains. This method of irrigation has been found serviceable particularly in the production of truck, berry, and other crops that yield high returns per acre. Spray irrigation is most widely practiced in the humid sections of the United States as a means of assuring continuous and rapid growth of valuable crops despite the occasional occurrence of periods of drought. Like other methods of irrigation in humid or semi-arid regions, spray irrigation with a dependable water supply constitutes a form of crop insurance. The value of the increase in crop yield as a result of irrigation, together with the insurance of a good crop, regardless of lack of rain, is evidenced by the rapid expansion of spray irrigation in the eastern states. In arid regions, spray irrigation is sometimes economical for production of especially valuable crops, particularly on land that is not well suited to irrigation by other methods.

89. Types of Spray-Irrigation Systems. — The most commonly used spray-irrigation systems are grouped into two types, namely: the overhead pipe system, and the circular spray system. These two types are well described by Mitchell and Staebner as follows.

90. Overhead Pipe System. — The spray-irrigation system most commonly used in the eastern United States consists of parallel lines of pipe about 50 feet apart, supported on rows of posts about $6\frac{1}{2}$ feet high, each line equipped with small nozzles spaced 3 to 4 feet apart. Fig. 58 illustrates this method. Each nozzle discharges a tiny stream of water perpendicularly to the pipe line, all streams emerging parallel. The water falls upon the ground and plants in tiny drops or as a mist; the entire width of about 50 feet may be irrigated uniformly by turning the pipe. The water for irrigation is pumped through underground pipes, to which the end of each nozzle line is connected by an upright pipe. At the beginning of each nozzle line is a valve, a turning union equipped with a handle to turn the pipe, and a screen to catch any sediment in the water.

The kind of system just described is commonly known as a "high-



FIG. 58. — Spray irrigation. (New Jersey Agr. Exp. Sta. Bul. 453.)



FIG. 59. — Portable spray equipment used in gardens about cold frames and hotbeds. [Luther Burbank gardens, Santa Rosa, Calif.] (U. S. Dept. Agr. Bul. 495.)

post" installation. Less frequently, posts are used only $1\frac{1}{2}$ to 4 feet high, and the system is then termed a "low-post" installation. Some systems have the nozzle lines suspended by short wires from a cable supported by posts 12 to 20 feet high and 50 to 125 feet apart.

A "portable" spray system, such as is used in some localities, consists of one or more nozzle lines that are carried from one part of the field to another as desired. They are laid upon the ground or supported on boxes, short posts, or special portable devices. Sometimes the main pipes to supply the portable nozzle lines are laid on top of the ground and moved from one field to another. A portable system is illustrated in Fig. 59.

The high-post installation is used by a great majority of the irrigators in the eastern United States. The low-post installation gives a slight saving in the cost of posts, but interferes somewhat more with farming operations than the high-post installation. When high posts are used, a light breeze is more effective in spreading the water over the field. The cable suspension type has the advantage of giving least interference with farming operations, particularly when the nozzle lines are hung higher; they are sometimes put 9 feet above the ground. However, with the nozzles more than $6\frac{1}{2}$ feet from the ground they are much less easily cleaned.

The advantage of the portable system is lower cost than the permanent installations, less piping being required, but the cost of operation is greater owing to the additional labor of moving the pipes and making the necessary connections and disconnections. Where temporary or portable supports are used this system is entirely out of the way when plowing or cultivating.

91. Circular-Spray System. — The circular-spray system distributes water from circular-spray nozzles fixed to the tops of upright pipes, sometimes called stands, distributed uniformly through the field. For irrigation of truck crops the nozzles have an elevation of 4 to 6 feet above ground and are supplied with water through the uprights, and therefore the nozzles are spaced equidistant from each other at the corners of triangles, as shown in Fig. 60. This gives a more uniform distribution of water over the field than to place the nozzles at the corners of squares or rectangles. Each lateral pipe line, and sometimes each nozzle, is controlled by a valve. This system is used very little in the eastern states. Its use is largely confined to a light soil that takes water rapidly and to crops that will not be injured by a coarse spray. The circular spray seems more particularly adapted for the irrigation of fruit than of vegetables, and is used to a considerable extent in the citrus orchards of California. There the stands are high, often holding the

nozzles above the trees, and sometimes are placed close to trees so as to be less in the way of cultivation.

92. Costs of Various Methods. — The first cost of preparing land for irrigation ranges from a few dollars up to \$400 or more per acre. Preparation for irrigation by the primitive flooding method requires the smallest financial outlay, whereas preparation for artificial sub-irrigation or for spray irrigation requires the largest investment per acre. It is authoritatively estimated that the total cost of properly preparing all the irrigated land of the West for efficient application of water will equal

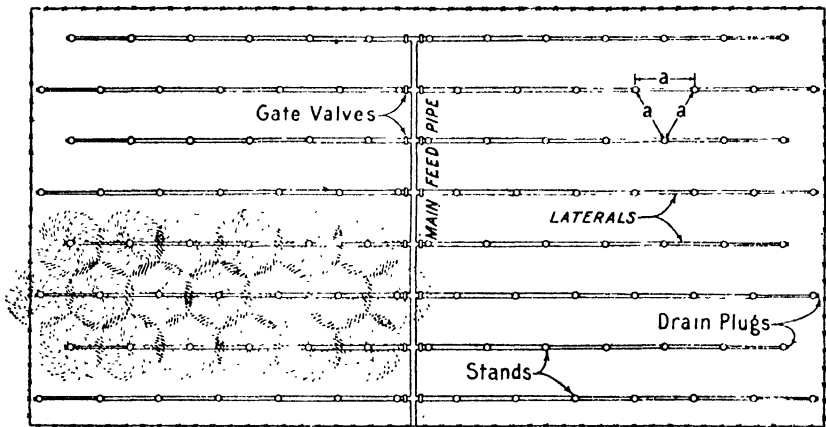

FIG. 60. — Typical plan for piping a field for a circular-spray irrigation system, showing staggered positions of nozzles to obtain the least amount of overlapping of spray. Distances marked *a* should be equal. (U. S. Dept. Agr. Bul. 1529.)

approximately the total cost of dams, canals, headgates, and other major irrigation structures required to make water available to the farm. There is still very great opportunity for improving the preparation of land by smoothing and leveling it, and by selecting widths and lengths of border strips; areas of checks; length, spacing and depth of furrows better suited to soil conditions and irrigation streams. Leading irrigation farmers study their water losses and application costs as related to the cost of improving their methods of irrigation.

Preparation for the border strip or check flooding ranges in cost from \$15 to \$50 per acre; and basin preparation, other things being equal, is somewhat more costly.

Under the large irrigation projects of the West the total irrigation costs that must ultimately be met by the farmers include not only the cost of land preparation but also the cost of the irrigation works — a

topic not within the scope of this volume. It is noteworthy, however, that in providing for irrigation by the spray method the first cost usually includes the cost of the water supply and therefore is relatively greater than, and not directly comparable to, the costs of preparing land for irrigation by the other methods. For spray systems the capital cost ranges from \$200 to \$400 or more per acre. Based on a first cost of \$250 an acre for a stationary spray irrigation plant, Williams estimates the total annual overhead and operating expense of supplying 6 acre-inches of water per year as \$51. He also indicates that the farmer's annual increase in profits per acre must exceed this amount in order to make spray irrigation financially attractive.

93. Choosing the Water Supply for Spray Systems. — The first step in designing a spray-irrigation system should be to make sure that a good supply of water is obtainable and that it will be adequate in the driest season. All doubt in this regard should be removed before any unnecessary expense is incurred. Irrigation requires a large quantity of water, and the fact that a source of supply is ample for all the other farm uses is not proof that it is sufficient for irrigation during dry periods. If the prospective irrigator has a choice of sources of supply, the cost of original installation, of operation and upkeep for each available source and the dependability of each should be considered carefully before a choice is made.

94. Common Sources of Water Supply for Spray Irrigation. — Underground water is the source of supply for most spray-irrigation systems, particularly in the Middle Atlantic states. It is obtained generally at depths of 15 to 50 feet, though a very few irrigators have wells more than 100 feet deep. The quality of underground water for irrigation is generally good. For depths not exceeding about 50 feet, driven wells are commonly used, because in the section where irrigation is most common the absence of rock or boulders permits of easy driving. Where one well has been inadequate, batteries of two to five or more wells have been used, connected together at the top. As ordinarily placed (6 to 10 feet apart), the supply is not increased in proportion to the number of wells; the flow probably would be increased by spacing the wells farther apart. The deeper wells are larger in diameter and more difficult to install than the driven type, but they furnish a larger and more dependable supply of water. Where deep wells have been used for irrigation supplies, the water generally rises to within the ordinary pumping depth, and if this does not occur the cost of pumping from deep sources may reduce greatly the profits from irrigation.

Near cities it sometimes has been practicable to procure water for irrigation from the municipal water mains. The quality of such supplies

TABLE XIII

DEPTH IN INCHES THAT A STREAM, q , c.f.s. FLOWING, t , HOURS WOULD COVER ONE ACRE IF SPREAD UNIFORMLY.

$$\text{BASED ON EQUATION (32) } d = \frac{qt}{a}$$

Line No.	Dis-charge c.f.s. q	Time in Hours, t											
		1	2	3	4	5	6	7	8	9	10	11	12
1	0.5	0.5	1.0	1.5	2.0	2.5	3.0	3.5	4.0	4.5	5.0	5.5	6.0
2	.6	.6	1.2	1.8	2.4	3.0	3.6	4.2	4.8	5.4	6.0	6.6	7.2
3	.7	.7	1.4	2.1	2.8	3.5	4.2	4.9	5.6	6.3	7.0	7.7	8.4
4	.8	.8	1.6	2.4	3.2	4.0	4.8	5.6	6.4	7.2	8.0	8.8	9.6
5	.9	.9	1.8	2.7	3.6	4.5	5.4	6.3	7.2	8.1	9.0	9.9	10.8
6	1.0	1.0	2.0	3.0	4.0	5.0	6.0	7.0	8.0	9.0	10.0	11.0	12.0
7	1.2	1.2	2.4	3.6	4.8	6.0	7.2	8.4	9.6	10.8	12.0	13.2	14.4
8	1.4	1.4	2.8	4.2	5.6	7.0	8.4	9.8	11.2	12.6	14.0	15.4	16.8
9	1.6	1.6	3.2	4.8	6.4	8.0	9.6	11.2	12.8	14.4	16.0	17.6	19.2
10	1.8	1.8	3.6	5.4	7.2	9.0	10.8	12.6	14.4	16.2	18.0	19.8	21.6
11	2.0	2.0	4.0	6.0	8.0	10.0	12.0	14.0	16.0	18.0	20.0	22.0	24.0
12	2.2	2.2	4.4	6.6	8.8	11.0	13.2	15.4	17.6	19.8	22.0	24.2	26.4
13	2.4	2.4	4.8	7.2	9.6	12.0	14.4	16.8	19.2	21.6	24.0	26.4	28.8
14	2.6	2.6	5.2	7.8	10.4	13.0	15.6	18.2	20.8	23.4	26.0	28.6	31.2
15	2.8	2.8	5.6	7.4	11.2	14.0	16.8	19.6	22.4	25.2	28.0	30.8	33.6
16	3.0	3.0	6.0	9.0	12.0	15.0	18.0	21.0	24.0	27.0	30.0	33.0	36.0
17	3.2	3.2	6.4	9.6	12.8	16.0	19.2	22.4	25.6	28.8	32.0	35.2	38.4
18	3.4	3.4	6.8	10.2	13.6	17.0	20.4	23.8	27.2	30.6	34.0	37.4	40.8
19	3.6	3.6	7.2	10.8	14.4	18.0	21.6	25.2	28.8	32.4	36.0	39.6	43.2
20	3.8	3.8	7.6	11.4	15.2	19.0	22.8	26.6	30.4	34.2	38.0	41.8	45.6
21	4.0	4.0	8.0	12.0	16.0	20.0	24.0	28.0	32.0	36.0	40.0	44.0	48.0
22	4.2	4.2	8.4	12.6	16.8	21.0	25.2	29.4	33.6	37.8	42.0	46.2	50.4
23	4.4	4.4	8.8	13.2	17.6	22.0	26.4	30.8	35.2	39.6	44.0	48.4	52.8
24	4.6	4.6	9.2	13.8	18.4	23.0	27.6	32.2	36.8	41.4	46.0	50.6	55.2
25	4.8	4.8	9.6	14.4	19.2	24.0	28.8	33.6	38.4	43.2	48.0	52.8	57.6
26	5.0	5.0	10.0	15.0	20.0	25.0	30.0	35.0	40.0	45.0	50.0	55.0	60.0

TABLE XIV

SIZE OF STREAM, q , c.f.s. FLOWING, t , HOURS REQUIRED TO APPLY A DEPTH, d , INCHES OF IRRIGATION WATER TO ONE ACRE IF SPREAD UNIFORMLY.

$$\text{BASED ON EQUATION (32) } q = \frac{da}{t}$$

Line No.	Depth in Inches d	Time in Hours, t											
		1	2	3	4	5	6	7	8	9	10	11	12
1	1.0	1.00	0.50	0.33	0.25	0.20	0.17	0.14	0.125	0.11	0.10	0.091	0.083
2	1.5	1.50	0.75	.50	.37	.30	.25	.21	.19	.17	.15	.146	.125
3	2.0	2.00	1.00	.67	.50	.40	.33	.29	.25	.22	.20	.18	.17
4	2.5	2.50	1.25	.83	.62	.50	.41	.36	.31	.28	.25	.23	.20
5	3.0	3.00	1.50	1.00	.75	.60	.50	.43	.37	.33	.30	.27	.25
6	3.5	3.50	1.75	1.18	.88	.70	.58	.50	.44	.39	.35	.32	.29
7	4.0	4.00	2.00	1.33	1.00	.80	.67	.57	.50	.44	.40	.36	.33
8	4.5	4.50	2.25	1.50	1.12	.90	.75	.64	.56	.50	.45	.41	.37
9	5.0	5.00	2.50	1.67	1.25	1.00	.83	.71	.62	.56	.50	.45	.42
10	5.5	5.50	2.75	1.83	1.37	1.10	.92	.79	.69	.61	.55	.50	.46
11	6.0	6.00	3.00	2.00	1.50	1.20	1.00	.86	.75	.67	.60	.55	.50
12	6.5	6.50	3.25	2.16	1.62	1.30	1.08	.93	.81	.72	.65	.59	.54
13	7.0	7.00	3.50	2.33	1.75	1.40	1.18	1.00	.88	.78	.70	.64	.58
14	7.5	7.50	3.75	2.50	1.87	1.50	1.25	1.07	.94	.84	.75	.68	.63
15	8.0	8.00	4.00	2.67	2.00	1.60	1.33	1.14	1.00	.89	.80	.73	.67
16	8.5	8.50	4.25	2.83	2.12	1.70	1.42	1.21	1.06	.95	.85	.77	.71
17	9.0	9.00	4.50	3.00	2.25	1.80	1.50	1.29	1.13	1.00	.90	.82	.75
18	9.5	9.50	4.75	3.16	2.38	1.90	1.58	1.36	1.19	1.06	.95	.86	.79
19	10.0	10.00	5.00	3.33	2.50	2.00	1.67	1.43	1.25	1.11	1.00	.91	.83
20	10.5	10.50	5.25	3.50	2.64	2.10	1.75	1.50	1.31	1.17	1.05	.95	.88
21	11.0	11.00	5.50	3.67	2.75	2.20	1.83	1.57	1.38	1.22	1.10	1.00	.92
22	11.5	11.50	5.75	3.83	2.87	2.30	1.92	1.64	1.44	1.28	1.15	1.05	.96
23	12.0	12.00	6.00	4.00	3.00	2.40	2.00	1.71	1.50	1.34	1.20	1.09	1.00

TABLE XIII

DEPTH IN INCHES THAT A STREAM, q , c.f.s. FLOWING, t , HOURS WOULD COVER ONE ACRE IF SPREAD UNIFORMLY.

BASED ON EQUATION (32) $d = \frac{qt}{a}$

Line No.	Dis-charge c.f.s. q	Time in Hours, t											
		1	2	3	4	5	6	7	8	9	10	11	12
1	0.5	0.5	1.0	1.5	2.0	2.5	3.0	3.5	4.0	4.5	5.0	5.5	6.0
2	.6	.6	1.2	1.8	2.4	3.0	3.6	4.2	4.8	5.4	6.0	6.6	7.2
3	.7	.7	1.4	2.1	2.8	3.5	4.2	4.9	5.6	6.3	7.0	7.7	8.4
4	.8	.8	1.6	2.4	3.2	4.0	4.8	5.6	6.4	7.2	8.0	8.8	9.6
5	.9	.9	1.8	2.7	3.6	4.5	5.4	6.3	7.2	8.1	9.0	9.9	10.8
6	1.0	1.0	2.0	3.0	4.0	5.0	6.0	7.0	8.0	9.0	10.0	11.0	12.0
7	1.2	1.2	2.4	3.6	4.8	6.0	7.2	8.4	9.6	10.8	12.0	13.2	14.4
8	1.4	1.4	2.8	4.2	5.6	7.0	8.4	9.8	11.2	12.6	14.0	15.4	16.8
9	1.6	1.6	3.2	4.8	6.4	8.0	9.6	11.2	12.8	14.4	16.0	17.6	19.2
10	1.8	1.8	3.6	5.4	7.2	9.0	10.8	12.6	14.4	16.2	18.0	19.8	21.6
11	2.0	2.0	4.0	6.0	8.0	10.0	12.0	14.0	16.0	18.0	20.0	22.0	24.0
12	2.2	2.2	4.4	6.6	8.8	11.0	13.2	15.4	17.6	19.8	22.0	24.2	26.4
13	2.4	2.4	4.8	7.2	9.6	12.0	14.4	16.8	19.2	21.6	24.0	26.4	28.8
14	2.6	2.6	5.2	7.8	10.4	13.0	15.6	18.2	20.8	23.4	26.0	28.6	31.2
15	2.8	2.8	5.6	7.4	11.2	14.0	16.8	19.6	22.4	25.2	28.0	30.8	33.6
16	3.0	3.0	6.0	9.0	12.0	15.0	18.0	21.0	24.0	27.0	30.0	33.0	36.0
17	3.2	3.2	6.4	9.6	12.8	16.0	19.2	22.4	25.6	28.8	32.0	35.2	38.4
18	3.4	3.4	6.8	10.2	13.6	17.0	20.4	23.8	27.2	30.6	34.0	37.4	40.8
19	3.6	3.6	7.2	10.8	14.4	18.0	21.6	25.2	28.8	32.4	36.0	39.6	43.2
20	3.8	3.8	7.6	11.4	15.2	19.0	22.8	26.6	30.4	34.2	38.0	41.8	45.6
21	4.0	4.0	8.0	12.0	16.0	20.0	24.0	28.0	32.0	36.0	40.0	44.0	48.0
22	4.2	4.2	8.4	12.6	16.8	21.0	25.2	29.4	33.6	37.8	42.0	46.2	50.4
23	4.4	4.4	8.8	13.2	17.6	22.0	26.4	30.8	35.2	39.6	44.0	48.4	52.8
24	4.6	4.6	9.2	13.8	18.4	23.0	27.6	32.2	36.8	41.4	46.0	50.6	55.2
25	4.8	4.8	9.6	14.4	19.2	24.0	28.8	33.6	38.4	43.2	48.0	52.8	57.6
26	5.0	5.0	10.0	15.0	20.0	25.0	30.0	35.0	40.0	45.0	50.0	55.0	60.0

TABLE XIV

SIZE OF STREAM, q , c.f.s. FLOWING, t , HOURS REQUIRED TO APPLY A DEPTH, d ,
INCHES OF IRRIGATION WATER TO ONE ACRE IF SPREAD UNIFORMLY.

BASED ON EQUATION (32) $q = \frac{da}{t}$

Line No.	Depth in Inches d	Time in Hours, t											
		1	2	3	4	5	6	7	8	9	10	11	12
1	1 0	1 00	0 50	0 33	0.25	0 20	0 17	0.14	0 125	0.11	0.10	0.091	0.083
2	1.5	1.50	0.75	.50	.37	.30	.25	.21	.19	.17	.15	.146	.125
3	2.0	2.00	1 00	.67	.50	.40	.33	.29	.25	.22	.20	.18	.17
4	2.5	2 50	1.25	.83	.62	.50	.41	.36	.31	.28	.25	.23	.20
5	3.0	3 00	1 50	1.00	.75	.60	.50	.43	.37	.33	.30	.27	.25
6	3 5	3.50	1.75	1.18	.88	.70	.58	.50	.44	.39	.35	.32	.29
7	4 0	4.00	2 00	1.33	1 00	.80	.67	.57	.50	.44	.40	.36	.33
8	4 5	4.50	2.25	1.50	1.12	.90	.75	.64	.56	.50	.45	.41	.37
9	5 0	5.00	2.50	1.67	1 25	1.00	.83	.71	.62	.56	.50	.45	.42
10	5.5	5.50	2 75	1 83	1 37	1.10	.92	.79	.69	.61	.55	.50	.46
11	6 0	6.00	3 00	2 00	1.50	1 20	1.00	.86	.75	.67	.60	.55	.50
12	6 5	6.50	3 25	2.16	1 62	1.30	1.08	.93	.81	.72	.65	.59	.54
13	7 0	7 00	3.50	2 33	1.75	1.40	1.18	1.00	.88	.78	.70	.64	.58
14	7 5	7.50	3.75	2.50	1.87	1.50	1.25	1.07	.94	.84	.75	.68	.63
15	8 0	8.00	4 00	2.67	2.00	1.60	1.33	1.14	1.00	.89	.80	.73	.67
16	8 5	8 50	4 25	2.83	2.12	1.70	1.42	1.21	1.06	.95	.85	.77	.71
17	9 0	9.00	4.50	3.00	2.25	1.80	1.50	1.29	1.13	1.00	.90	.82	.75
18	9 5	9.50	4.75	3.16	2.38	1.90	1.58	1 36	1.19	1.06	.95	.86	.79
19	10.0	10.00	5 00	3 33	2.50	2.00	1.67	1.43	1.25	1.11	1.00	.91	.83
20	10.5	10.50	5.25	3.50	2.64	2.10	1.75	1.50	1.31	1.17	1.05	.95	.88
21	11.0	11.00	5 50	3.67	2.75	2.20	1.83	1.57	1.38	1.22	1.10	1.00	.92
22	11.5	11.50	5.75	3.83	2.87	2.30	1.92	1.64	1.44	1.28	1.15	1.05	.96
23	12.0	12 00	6 00	4 00	3 00	2.40	2.00	1.71	1.50	1.34	1.20	1.09	1.00

TABLE XV

TIME IN HOURS, t , REQUIRED WITH A STREAM, q , c.f.s. TO APPLY, d , INCHES
OF IRRIGATION WATER TO ONE ACRE IF SPREAD UNIFORMLY.

$$\text{BASED ON EQUATION (32) } t = \frac{da}{q}$$

Line No.	Dis- charge c.f.s. q	Depth in Inches, d											
		1	2	3	4	5	6	7	8	9	10	11	12
1	0.5	2.00	4.00	6.00	8.0	10.00	12.0	14.00	16.00	18.00	20.00	22.00	24.00
2	.6	1.66	3.33	5.00	6.67	8.33	10.0	11.67	13.33	15.00	16.67	18.33	20.00
3	.7	1.43	2.86	4.30	5.72	7.15	8.58	10.00	11.43	12.86	14.33	15.73	17.17
4	.8	1.25	2.50	3.75	5.00	6.25	7.50	8.75	10.00	11.25	12.50	13.76	15.00
5	.9	1.11	2.22	3.33	4.50	5.56	6.68	7.78	8.88	10.00	11.10	12.25	13.33
6	1.0	1.00	2.00	3.00	4.00	5.00	6.00	7.00	8.00	9.00	10.00	11.00	12.00
7	1.2	.84	1.67	2.50	3.33	4.16	5.00	5.84	6.67	7.50	8.33	9.17	10.00
8	1.4	.71	1.43	2.14	2.86	3.57	4.28	5.00	5.71	6.43	7.14	7.87	8.57
9	1.6	.63	1.25	1.87	2.50	3.13	3.75	4.38	5.00	5.62	6.25	6.88	7.50
10	1.8	.56	1.11	1.67	2.22	2.78	3.33	3.88	4.44	5.00	5.55	6.12	6.67
11	2.0	.50	1.00	1.50	2.00	2.50	3.00	3.50	4.00	4.50	5.00	5.50	6.00
12	2.2	.45	.91	1.36	1.82	2.27	2.73	3.18	3.64	4.09	4.54	5.00	5.46
13	2.4	.42	.83	1.25	1.67	2.08	2.50	2.92	3.33	3.75	4.16	4.58	5.00
14	2.6	.38	.77	1.15	1.54	1.92	2.31	2.69	3.08	3.46	3.85	4.23	4.62
15	2.8	.36	.71	1.07	1.43	1.78	2.14	2.50	2.86	3.22	3.57	3.93	4.28
16	3.0	.33	.67	1.00	1.33	1.67	2.00	2.33	2.67	3.00	3.33	3.67	4.00
17	3.2	.31	.63	.94	1.25	1.56	1.88	2.19	2.50	2.81	3.12	3.44	3.75
18	3.4	.29	.59	.88	1.18	1.47	1.76	2.06	2.35	2.65	2.94	3.24	3.53
19	3.6	.28	.56	.83	1.11	1.39	1.67	1.94	2.22	2.50	2.78	3.06	3.33
20	3.8	.26	.55	.79	1.05	1.32	1.58	1.84	2.10	2.37	2.63	2.90	3.16
21	4.0	.25	.50	.75	1.00	1.25	1.50	1.75	2.00	2.25	2.50	2.75	3.00
22	4.2	.24	.48	.71	.95	1.19	1.43	1.67	1.90	2.14	2.38	2.62	2.86
23	4.4	.23	.45	.68	.91	1.14	1.36	1.59	1.82	2.04	2.27	2.50	2.73
24	4.6	.22	.44	.65	.87	1.09	1.30	1.52	1.74	1.96	2.17	2.39	2.61
25	4.8	.21	.42	.63	.83	1.04	1.25	1.46	1.67	1.88	2.08	2.29	2.50
26	5.0	.20	.40	.60	.80	1.00	1.20	1.40	1.60	1.80	2.00	2.20	2.40

is excellent and the cost of pumping is eliminated, but with increase in the population of the city and the corresponding increase in the demand for household use, the permanence of this source is not always assured.

Water for irrigation is procured in many cases from lakes, ponds, and streams. To be of value, any source of supply must furnish adequate quantities in the dry seasons, when the water is most needed. Very small streams, and sometimes springs, can be utilized when it is practicable to form a storage reservoir by building a dam across the waterway. Such surface waters are very likely to need straining before they are used in order to avoid clogging of the nozzles.

95. Quantity of Water Needed for Spray Irrigation. — Because spray irrigation is more widely practiced in humid than arid regions, the seasonal water needs are small compared to the needs for flooding and furrow irrigation in arid regions. During the drier seasons from 6 to 8 acre-inches per acre are needed, whereas in some years 4 inches will sufficiently supplement the rainfall to produce profitable truck crops.

Williams found that, for preparing seed beds and for irrigation of young vegetables, very small amounts of water in each irrigation will suffice — from $\frac{1}{4}$ to $\frac{1}{2}$ acre-inch per acre. For designing purposes Williams recommends as an average basis 1.0 inch per week in humid regions and 1.5 inches per week in arid regions.

REFERENCES

- ADAMS, FRANK, *et al.* Investigation of the Economical Duty of Water for Alfalfa in Sacramento Valley, California, California State Depart. Engineering Bul. No. 3. 1917.
- FORTIER, SAMUEL. Irrigation requirements of the Arable Lands of the Great Basin, U. S. D. A. Dept. Bul. 1340. 1925.
- FORTIER, SAMUEL. Practical Information for Beginners in Irrigation, U. S. D. A. Farmers' Bul. 864. 1917.
- FORTIER, SAMUEL. The Border Method of Irrigation, U. S. D. A. Farmers' Bul. 1243. 1927.
- FORTIER, SAMUEL. Irrigation Practices in Growing Alfalfa, U. S. D. A. Farmers' Bul. 1630. 1930.
- HUBER, H. F., GROSS, E. R., and LUCAS, D. B. Sprinkling Irrigation on Vegetable Farms in New Jersey, New Jersey Agr. Exp. Sta. November, 1927.
- HUBERTY, M. R., and BROWN, J. B. Irrigation of Orchards by Contours, California Agr. Ext. Service Circ. 16. 1928.
- MARR, JAMES C. The Corrugation Method of Irrigation, U. S. D. A. Farmers' Bul. 1348. 1923.
- MITCHELL, GEO. A., and STAEBNER, FREDERIC E. Spray Irrigation in the Eastern States, U. S. D. A. Farmers' Bul. 1529. 1927.
- PARKER, PHILIP A. MORLEY. The Control of Water, D. Van Nostrand Co., New York. 1915.

- STAEBNER, F. E. Surface Irrigation in the Eastern States, U. S. D. A. Farmers' Bul. 1635. 1930.
- WADSWORTH, H. A. Irrigation by Overhead Sprinkling, California Agr. Ext. Service Circ. 4. 1928.
- WILLIAMS, MILO B. Spray Irrigation, U. S. D. A. Bul. 495. Feb. 14, 1917.

CHAPTER VI

FARM IRRIGATION IMPLEMENTS AND STRUCTURES

Each one of the several methods of preparing land for irrigation outlined in Chapter V requires certain implements in order to accomplish the desired result most efficiently. The implements that are most commonly used in the preparation of land are described in this chapter. In addition to the use of properly designed implements in the preparation of land for irrigation it is essential to efficiency and economy that each irrigated farm be provided with structures that facilitate easy control and regulation of the stream of irrigation water during its application to

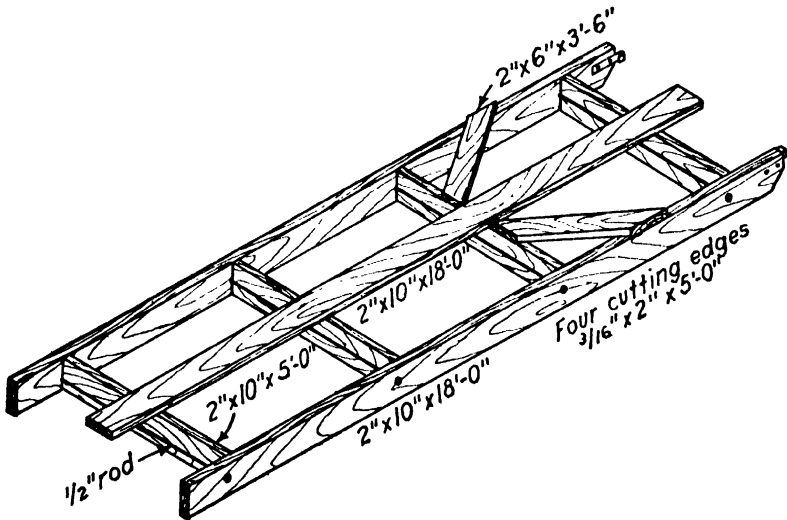

FIG. 61. — Land drag. (New Mexico Ext. Service Circular 92.)

the land. As yet, comparatively little attention has been given to irrigation structures by public irrigation research agencies, the more basic problems in the relations of irrigation practice to soils and to plants having thus far commanded major attention. The greater the available knowledge of the interrelations of soils, plants, and water, and the greater the demand for water, the more urgent it becomes that the irri-

gator be able to control the stream at his disposal and to spread the water uniformly over the land surface in order to moisten the soil to the desired depth without sustaining excessive losses of water. Some of the farm structures that facilitate the control of water are described in this chapter.

96. **Implements.** — The farm implements of first importance in irrigation are the plow, spike-tooth harrow, disc harrow, and drag or float.

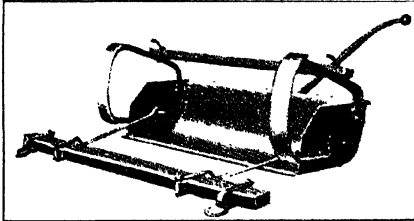

FIG. 62. — Fresno scraper.

Good plows and good plowing very greatly contribute to the possibility of uniformity in distributing irrigation water. Lands that are irrigated by the wild flooding methods especially require good plowing because, owing to the lack of specially prepared levees, there is no means of crowding water over

the higher land areas of poorly plowed fields. It is a common experience among irrigators that careless plowing of those tracts that are to

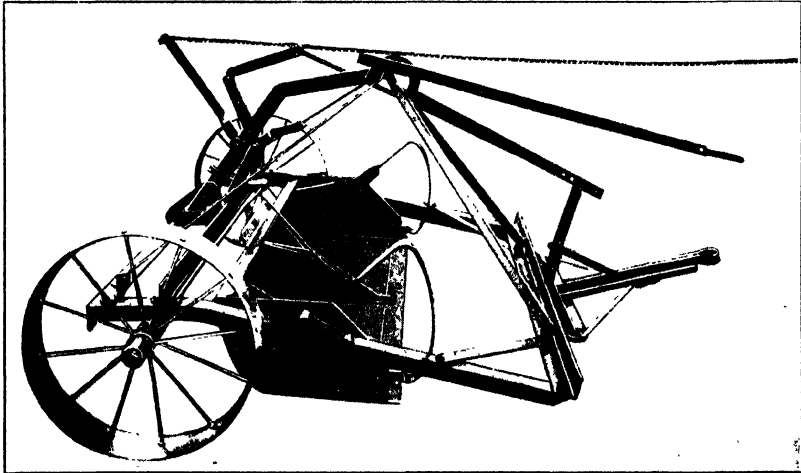

FIG. 63. — Miskin scraper tractor-drawn, one-cubic-yard capacity. (Courtesy: Miskin Scraper Works.)

be irrigated by flooding, or plowing with dull, poorly kept plows, is followed by inefficient irrigation.

Liberal use of good harrows and a drag such as illustrated in Fig. 61 may greatly reduce the ill effects of poor plowing, but the same expendi-

ture of time and energy on well-plowed land brings much more satisfactory results. Regardless of the particular method of irrigation that may be practiced, the better farmers in irrigated regions are always mindful of the importance of using carefully the better tillage implements in order to obtain a smooth land surface in which there are few if any small depressions or elevations resulting from tillage operations.

97. Implements for Making Borders. — In addition to the common tillage implements, well-built scrapers such as the Fresno, illustrated in Fig. 62, and the Miskin shown in Fig. 63, are essential to preliminary leveling and making of the levees. On some of the larger farms, special land levelers drawn by tractors, as illustrated in Fig. 64, have proved to be economical. Also standard road graders are used as shown in Fig. 65. The more commonly used implement is the homemade V-shaped drag illustrated in Fig. 66. Arizona farmers in the Salt River Valley have developed a special adjustable border implement as illustrated in Fig. 67. The steel frame attached to the rear end of the Arizona implement smooths and grades the top of the levee in the same operation which crowds the soil together to make a levee.

98. Implements for Making Corrugations. — Shallow furrows are designated as corrugations. Two types of homemade corrugators are used: one a roller around which collars of the desired thickness and depth are built; the other a drag having runners as corrugators. The roller type, illustrated in Fig. 68, compresses and compacts the soil as a means of making furrows; the drag type crowds the soil to both sides of the runner. Two kinds of homemade wooden corrugators are illustrated in Figs. 69 and 70. These corrugators, as also the roller one, are limited in use to newly plowed land. For old alfalfa land, clover land, or other land having a compact surface, heavy, well-constructed steel corrugators are needed to make satisfactory furrows. A corrugator of this type is illustrated in Fig. 71. In the sugar-beet-growing sections of the West it is customary to use standard two-horse, wheel cultivators with special small plow attachments for making the corrugations. The beet cultivator may be used for newly seeded grain or alfalfa land, but it is not well adapted to use on land on which the surface soil has become compacted. A special wheel-mounted corrugator is illustrated in Fig. 72.

99. Implements for Making Deep Furrows. — Potatoes, corn, asparagus, celery, and orchards on some soils are best irrigated from comparatively deep furrows. Especially in heavy soils, deep furrows are advisable. Many orchard crops, such as apples, peaches, lemons, olives, almonds, etc., are also best irrigated by the use of deep furrows. A common shovel plow is sometimes used for making the furrows needed.

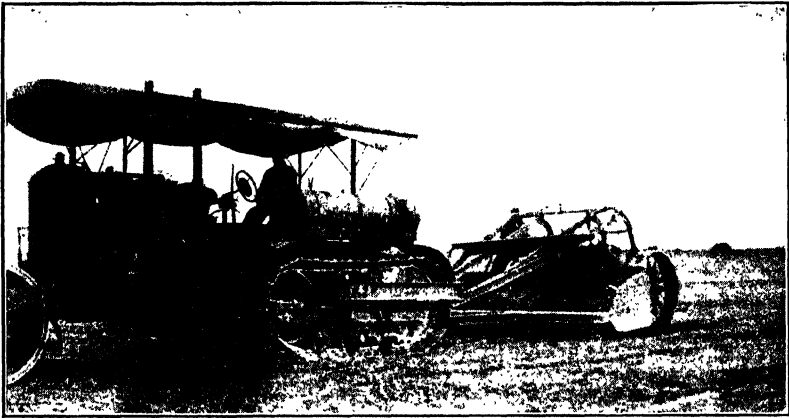

FIG. 64. — A Caterpillar tractor drawing a land leveler. (U. S. Dept. Agr. Farmers' Bul. 1243.)

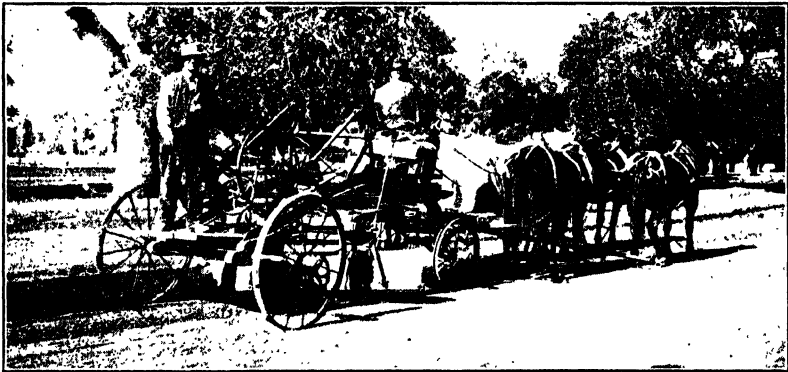

FIG. 65. — Road grader used in preparing land for border irrigation. (Figs. 65-67 from U. S. Dept. Agr. Farmers' Bul. 1243.)

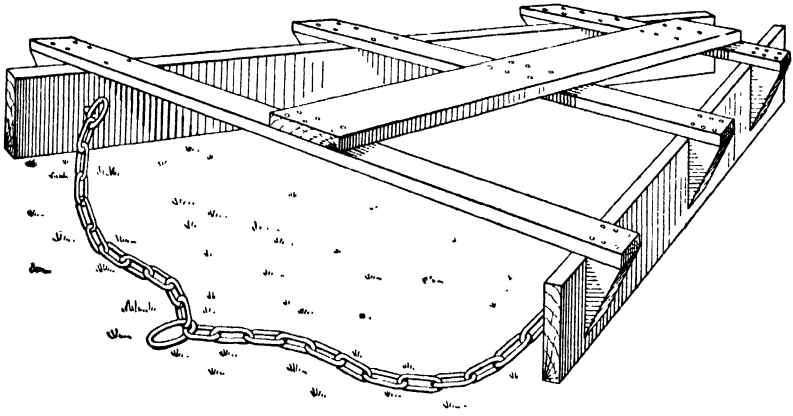

FIG. 66. — Drag used for border levees.

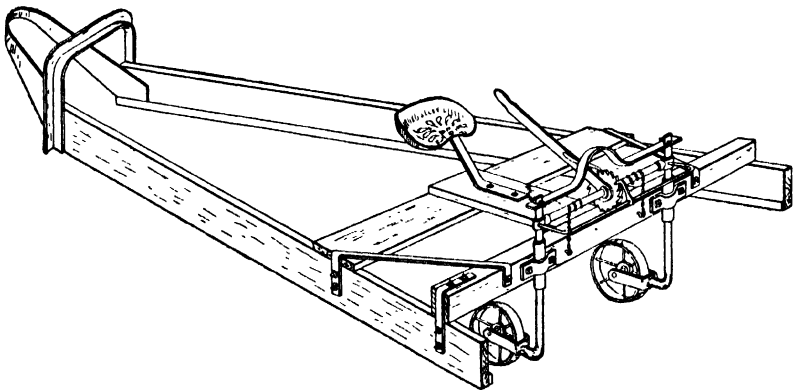

FIG. 67. — Bordering machine as designed and used in Salt River Valley, Arizona.

For orchard irrigation, land having a steep side-hill slope a standard mole board plow may well be used by throwing the soil down hill so as

to avoid overflowing of the furrows. A two-way sulky plow saves time in making deep furrows on side-hill land.



FIG. 68. — Roller corrugator. (Figs. 68 to 72 inclusive are from U. S. Dept. Agr. Farmers' Bul. 1348.)

100. Farm Irrigation Structures. — Engineers apply the word *structure* to the large dams, headgates, sluices, flumes, inverted siphons, chutes, and drops which are built to divert water from natural sources and convey it to the farms for irrigation. The devices and pieces of equipment used by the individual irrigator to divert water from a large canal into his ditch and convey it to the several parts of his farm are here designated **farm irrigation structures**. In some pioneer communities rather crude farm irrigation structures

are made to suffice even though the labor cost required in the use of such structures is sometimes very high. As a rule, it is economical, and it is always most satisfactory to the irrigator, to build structures that have the required capacity and the strength to control the water at the irrigator's will. Many irrigation canals in the West, and particularly in the Rocky Mountain states, are built along the rims of the valleys immediately above the irrigated lands so that each irrigator obtains water directly from the main canal which carries water during the entire irrigation season. On such canals satisfactory take-out structures are especially necessary. Farm irrigation structures include two general classes, namely, permanent and temporary structures. To be sure, there is no structure that is truly permanent in the strict sense of the word, but the term permanent is applied to those structures which remain in place during one or more irrigation seasons. Temporary structures are those that are moved from place to place during each irrigation, or those



FIG. 69. — Type of homemade wooden corrugator.

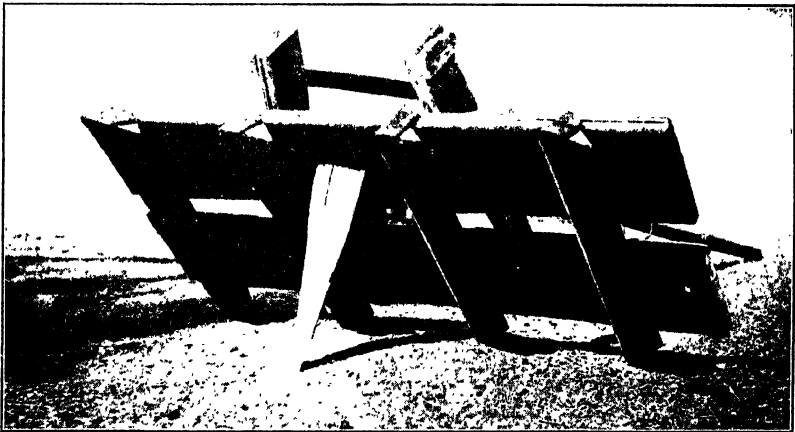

FIG. 70. — Another type of homemade corrugator.

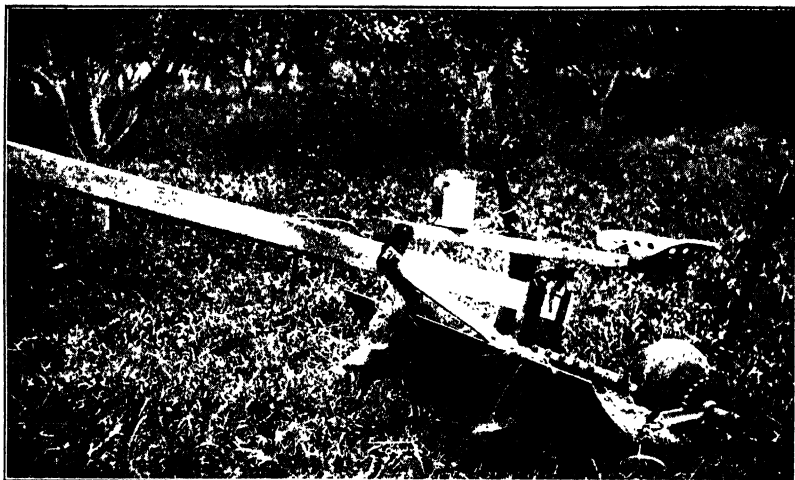

FIG. 71. — Steel corrugator.

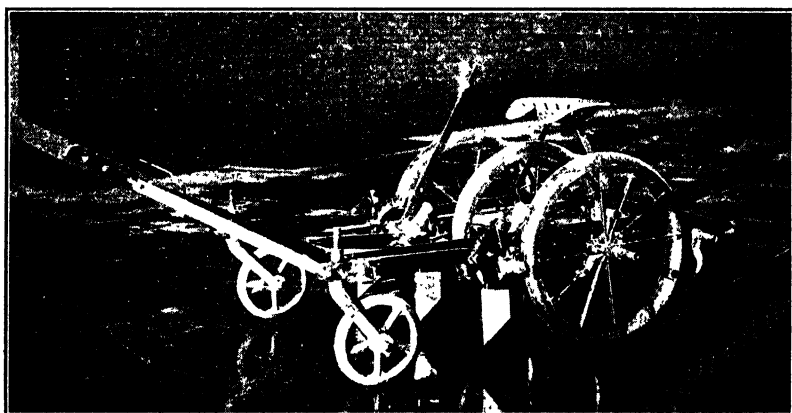

FIG. 72. — Wheel mounted corrugator.

that are built for only one season's use. A further desirable classification of structures is based on the function of the structure, and includes: diversion, conveyance, and distribution structures. The several structures in each of these classes are listed in tabular form below.

101. — Tabulated List of Farm Irrigation Structures.*

	PERMANENT	TEMPORARY
DIVERSION	Check gates	Portable steel dams
	Take-out channels	Canvas dams
	Hydrants or valves	Earth dams
	Tubes	Straw and earth dams
	Division boxes	
CONVEYANCE	Ditches	Ditches
	Flumes	Slip joint pipes
	Surface pipes	Canvas hose
	Underground pipes	
DISTRIBUTION	Surface pipes	Furrows
	Levees	Corrugations
	Spray pipes	Border strips
	Nozzles	Checks

102. Permanent Diversion Structures. — As yet there is considerable lack of uniformity in the names applied by different irrigation authorities to the several diversion structures. The author suggests the following designations with the thought that improvements will be made by those interested, until finally, well-recognized and standard terms will be agreed upon and used. A *check gate* is one placed across a stream from which it is desired to divert water. The function of check gates is analogous to that of the dam or the diversion weir on the larger natural streams at the heads of canal systems. It is suggested that the term headgate be used only to designate the regulator gates at the head of canal systems; and that gates built across laterals and ditches, for the purpose of diverting part or all of the stream be designated as *check gates*. The *take-out* is a part of the farmer's "diversion works" and is analogous to the headgate of the main diversion works on the river system. Its function is to admit a sufficient amount of water into the small lateral, the field ditch, or the furrow, and to prevent an excessive quantity from entering. Typical wooden check gates are illustrated in Figs. 73 and 74. These gates may also be used as take-out gates, although pipe or culvert take-outs are commonly used — especially to

* Structures for measuring irrigation water and for dividing a stream into different parts are described in Chapter III. The irrigation devices here classed as "temporary farm irrigation structures" are described by some authorities as "irrigation equipment."

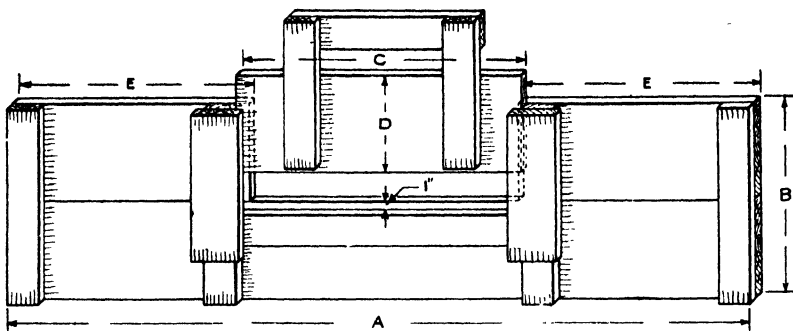

DESIGNED FOR HEADS OF	A	B	C	D	E	LUMBER THICKNESS
1 cfs - 2 cfs	8'-0"	2'-0"	3'-0"	1'-0"	2'-6"	1"
2 cfs - 5 cfs	9'-0"	3'-6"	3'-0"	2'-0"	3'-0"	1½"
5 cfs - 8 cfs	10'-0"	3'-6"	4'-0"	2'-0"	3'-0"	1½"

Fig. 73. — Standard single-wing wooden check gate. (Figs. 73 to 76 from U. S. Dept. Agr. Farmers' Bul. 1213.)

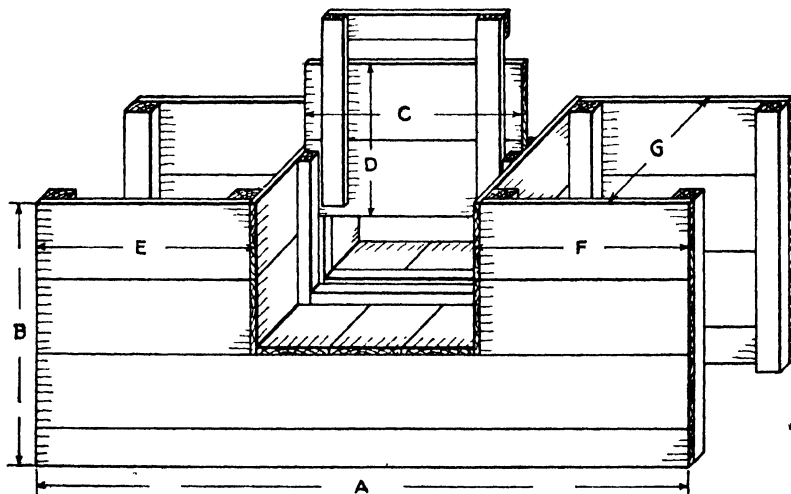

DESIGNED FOR HEADS OF	A	B	C	D	E	F	G
3 cfs - 6 cfs	9'-0"	3'-6"	3'-0"	2'-0"	3'-0"	3'-0"	2'-0"
6 cfs - 10 cfs	12'-0"	4'-0"	4'-0"	2'-0"	4'-0"	4'-0"	2'-6"
10 cfs - AND UP	14'-0"	4'-0"	5'-0"	2'-0"	4'-6"	4'-6"	2'-6"

Fig. 74. — Standard double-wing wooden check gate.

take relatively small streams out of large canals. For check gates in large canals in which the quantity of water fluctuates appreciably, it is desirable to use flashboards placed on the bottom of the stream so that the water which passes the check gate and goes on down the canal is forced to flow over the check structure — not under it. A study of the hydraulic principles of check and take-out structures as given in the

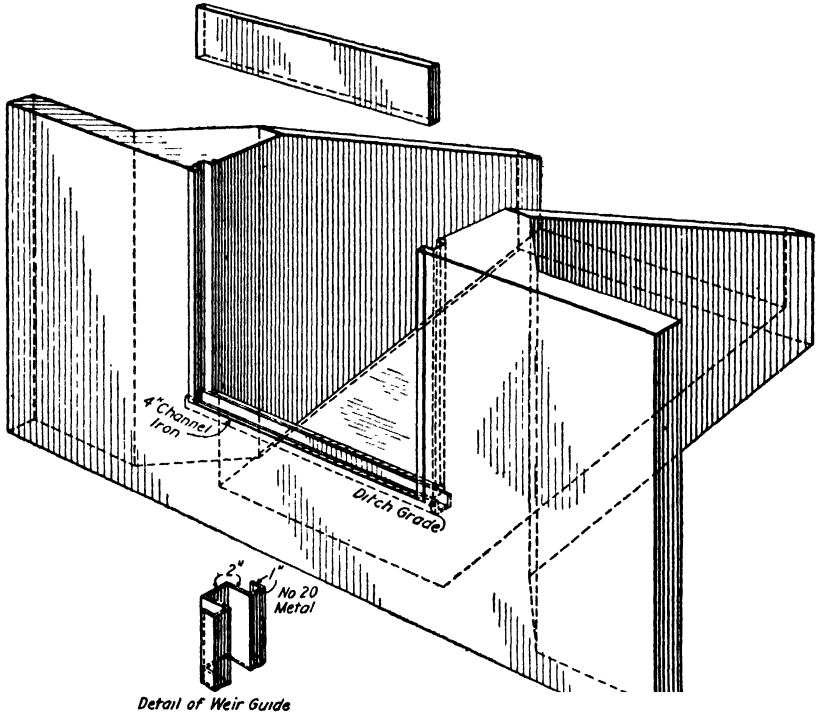

FIG. 75. — Concrete gate and wooden flashboard used on the Turlock Irrigation District. California.

following article will clarify the reasons for the foregoing statement. A well-made concrete check gate with wood flashboard used by the Turlock Irrigation District of California is illustrated in Fig. 75.

103. Hydraulic Principles of Diversion Structures. — In taking water out of a large distributary or of a main canal, it is as a rule desirable that the farmer obtain a flow as nearly constant as possible. Sudden increases in the quantity of water flowing in the canal, which occur as a result of storms or from closing of take-out gates, should be permitted to flow down the canal with as little obstruction as possible. These two

conditions, i.e., approximately constant flow for the irrigator and a minimum of obstruction in the main canal, in general may be provided by using submerged pipes or culverts as take-outs and overflow flashboards as checks in the main canal to cause the water to rise high enough to submerge the farmer's take-out gate and divert the quantity of water that he desires. To understand these principles clearly the student should review the chapter on measurement of water and in particular equations (16) and (18).

It is seen from equation (18) that H varies with the two-thirds power of q ; hence, to double the quantity of water flowing over the flashboards as checks, the depth need be increased only 1.59 times.

Equation (16) shows that h varies with the square of q ; hence to double the quantity of water flowing through a submerged culvert take-out the effective head h must be increased to 4 times the original head. It is therefore clear that the streams through a submerged take-out are subject to much less variation than those through over-pour take-outs.

104. Temporary Diversion Structures. — In order to divert water from the small ditches on the farm many irrigators use only temporary

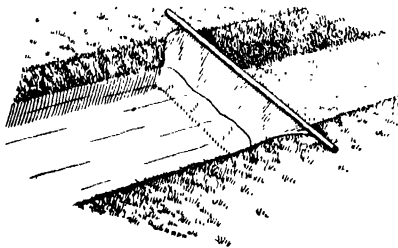

FIG. 76. — Portable canvas dam in ditch.

earth dams. The irrigator makes each dam at the time and place desired by use of an ordinary shovel. In some soils that wash easily it is helpful to use a little partly rotted straw or weeds temporarily held in place by means of wooden stakes driven into the soil of the bottom of the ditch.

Temporary earth dams are unsuited to streams of more than 2

c.f.s. and in some soils are very difficult to maintain with a stream of 1 c.f.s. or more. The labor requirement of temporary dams is greatly reduced by using portable dams of either steel or canvas. Two kinds of portable dams are illustrated in Figs. 76 and 77. Portable steel dams are suited to streams smaller than those diverted by canvas dams. For streams of 3 c.f.s. or more the steel dam required is so large as to become burdensome to move or carry about the field. Well-built canvas dams are used to divert streams as large as 5 c.f.s. or more, although streams of 2 to 3 c.f.s. are more commonly diverted by canvas dams. A rather heavy, closely woven canvas is necessary to stand the water pressure and prevent excessive leaking.

105. Water-Conveyance Structures. — The term structure as used herein applies quite as fully to ditches, levees, etc., which are made of

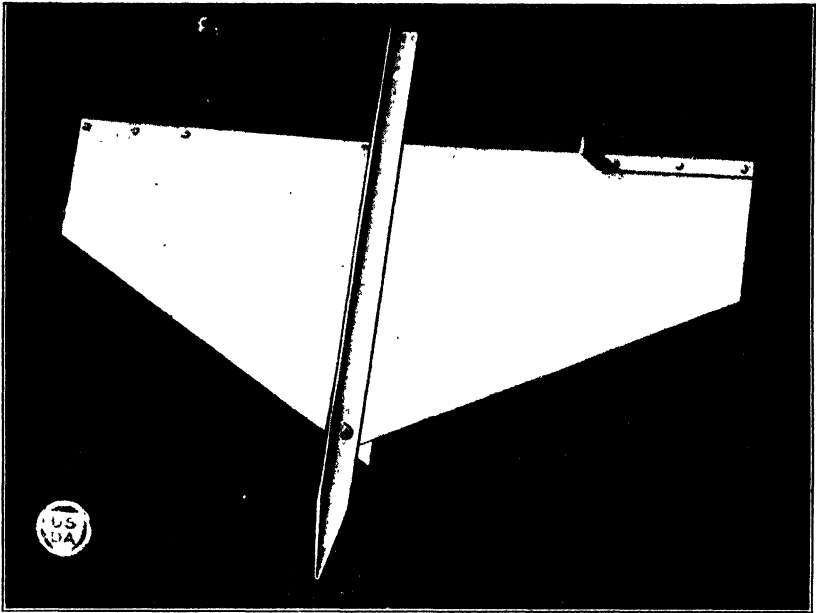

Fig. 77. --- Portable metal dam. (U. S. Dept. Agr. Farmers' Bul. 1348.)



Fig. 78. — Water flowing from underground pipe for basin irrigation in Santa Clara Valley, Calif. (U. S. Dept. Agr. Office File.)

earth as it does to those devices which are built of wood, concrete, or metal. Most of the water-conveyance structures in the West are made of earth. The quantity of water that earth ditches will convey may be estimated from the equations and the tables of Chapter II. Also the quantities that may be conveyed in flumes and pipes may be estimated from Chapter II, as there illustrated.

Conveyance of water under pressure through underground concrete pipe to various points on the farm is becoming increasingly popular, especially in the irrigation of orchards. Fig. 78 shows a stream of water emerging from an underground pipe.

Under the wild flooding method of irrigation of perennial crops such as alfalfa and orchards, nearly all the ditches are built more or less permanently. Grain crops, notably wheat, oats, and barley, usually



FIG. 79. — Use of portable galvanized-iron pipe in alfalfa irrigation. (U. S. Dept. Agr. Farmers' Bul. 899.)

require temporary ditches which are made with an ordinary plow along the higher parts or ridges of the field. The irrigation farmer is especially concerned with the smaller permanent ditches that are used to convey water to the several farms. These ditches are constructed with plows and with small ditching machines drawn by horses or traction engines. It is customary, and usually convenient, to build farm irrigation ditches along property lines even though the land slopes along the property lines vary rather widely. On excessive slopes, caution must be exercised against erosion of farm ditches, and on small slopes, it is important to guard against growth of weeds and grasses in order to maintain a satisfactory discharge capacity.

106. Distribution Structures. — The use of levees, deep furrows, and corrugations as means of distributing the water over the land surface is described in Chapter V. Also brief attention is there given to overhead pipe spray systems and to portable spray systems.

Where land surfaces are very irregular, soil permeabilities high, and water expensive, portable surface pipes are used to distribute water. Portable pipes are made of canvas, ordinarily called canvas hose, and of galvanized iron.

The use of slip-joint pipe for irrigation of an alfalfa field is shown in Fig. 79. The use of slip-joint pipe for distribution is limited to comparatively small areas in only a few irrigated regions. It is not recommended for large farms, and indeed it is rarely used in the inter-mountain irrigation states. On farms that are somewhat irregular in topographic conditions, and on which only small streams of water are available, the use of slip-joint pipe with which to distribute the water increases the water application efficiency.*

* See Chapter XVIII for definitions of efficiencies in irrigation.

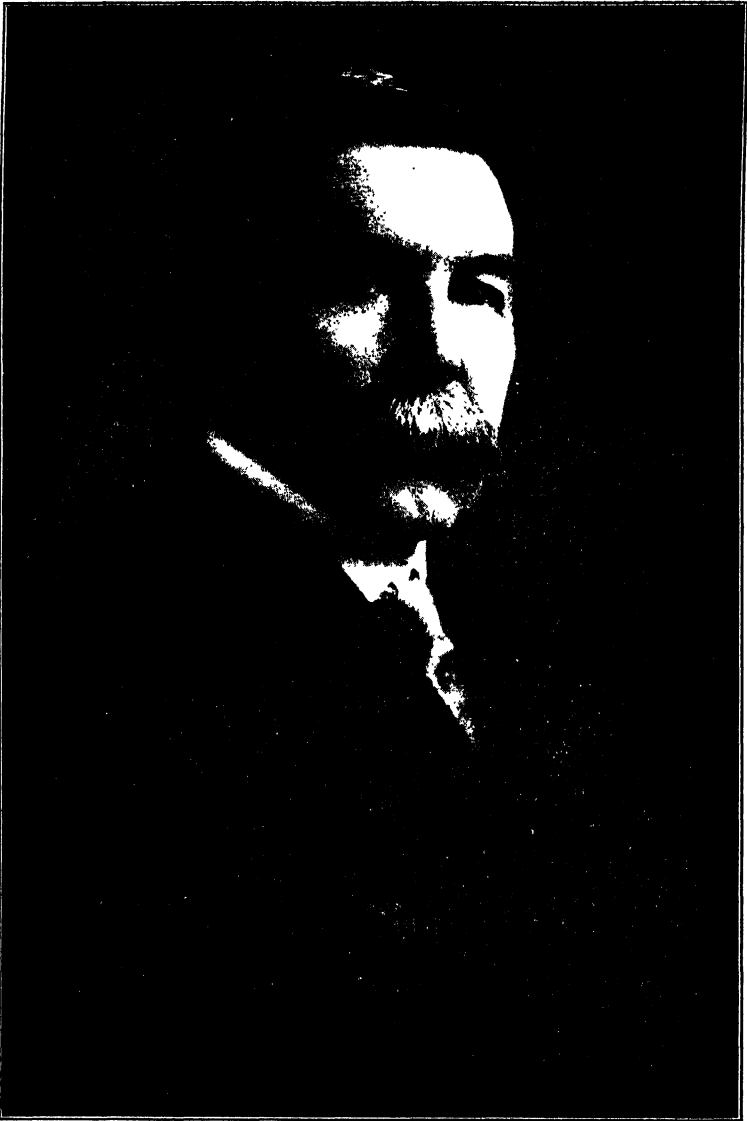

PLATE III. — Samuel Fortier, D.Sc., Civil Engineer, Eminent Irrigation Authority, Author, and Administrator.



PLATE IV. — Irrigating an orange grove, Orland Project, California. (Courtesy: U. S. Bureau of Reclamation.)

CHAPTER VII

SOME PROPERTIES OF SOILS

Among the many agencies which influence the processes of soil formation, the climate is of great importance. It is therefore natural to find significant differences in the properties of soils formed under humid climates and those formed under arid climates. Irrigated soils usually are typical of arid-climate soils. However, there is some irrigation practice in humid regions on soils formed in humid climates but irrigation practice in humid climates thus far is relatively not extensive. After long periods of irrigation, some of the properties of humid-region soils are developed in arid-region soils.

The chief source of all mineral soils is rock, although some limited areas of soils are formed largely from organic matter. The breaking down of rocks into the fine particles which form soils is a result of mechanical disintegration.

Chapters VII to XI, inclusive, are devoted to a consideration of the relationships of soils and water with special reference to the influences of these relationships on irrigation practice. Among the soil-water relations of importance in irrigated regions are the capacities of soils to retain irrigation water for the use of plants, the movement of water in soils, and the alkali content of irrigated soils, together with its translocation and concentration due to the movement and evaporation of soil water. Chapters VII and VIII are devoted to definitions of soil properties and basic soil-water relations; Chapters IX to XI are concerned with the storage and movement of water in soils, and with the alkali problem.

107. Texture.— Where the main soil-forming process is due to mechanical disintegration, relatively coarse-grained particles are found. The size of the particles is designated by the word *texture*. Sandy soils are classed as coarse textured, loam soils as medium textured, and clay soils as fine textured. The texture of a soil has a very important influence on the movement of water, the circulation of air, and the rate of chemical transformations which are of importance to plant life. The size of the soil particles has in reality a great influence on crop production the world over, but to the irrigation farmer it is particularly important because it determines, in a large measure, the amount of water

he can store in a given depth of soil. Moreover, the farmer is unable to modify the texture of his soil by any practicable means.

108. Real Specific Gravity. — The real specific gravity of a soil is defined as the ratio of the weight of a single soil particle to the weight of a quantity of water equal in volume to the particle of soil. The specific gravity of the common soil-forming minerals varies from 2.5 to more than 5.0. However, since a few minerals such as quartz and feldspar usually make up the bulk of the soil, the real specific gravity of the soils which have a low percentage of organic matter varies but little, and approaches closely an average of 2.7, which is the specific gravity of quartz. Some irrigated soils which are formed largely of organic matter have a real specific gravity of 1.5 to 2.0, depending on the amount of mineral matter present. The soils of the island areas in the San Joaquin Valley, California, are typical of the latter class.

109. Structure. — The particles of a natural soil vary greatly both in size and in shape. Soils in which the particles are relatively uniform in size have comparatively large spaces between the particles, whereas, other things being equal, the particles of those soils in which the size of the grains varies greatly become more closely packed and thus restrict the spaces between them. The finer-grained irrigated soils, if properly managed, function as groups of particles or granules, whereas, in the coarser-textured soils, each particle functions separately. The existence of granules assures a desirable soil structure. Excessive irrigation and plowing or otherwise working fine-textured soils when wet tends to break down these granules. A soil so treated is said to be puddled, and it has a poor structure. Favorable structure is essential to the satisfactory movement of water and air in fine-textured soils.

110. Apparent Specific Gravity. — The apparent specific gravity of a soil is defined as the ratio of the weight of a given volume of dry soil, air space included, to the weight of an equal volume of water. This ratio is known also as the "volume weight" of the soil. It is evident that the apparent specific gravity is influenced by the structure, i.e., the arrangement of soil particles, and by the texture and compactness. Apparent specific gravity is a soil property of great importance to the irrigation farmer, as will be shown more fully in connection with a consideration of the capacity of soils to retain irrigation water.

Compacting a soil of fixed real specific gravity will clearly increase the apparent specific gravity and decrease the space occupied by air and water, or the pore space. When working with irrigated soils, it is necessary to know the apparent specific gravity in order to account for the water applied in irrigation. This is obvious from the fact that it is impracticable to measure, by direct means, the volume of water which

exists in the form of soil moisture in a given volume of soil. It is necessary to measure the weight of water which exists in a given weight of soil by observing the loss of weight in drying, and then converting the weight percentage thus obtained, by use of the apparent specific gravity, to a volume percentage from which the volume of water in a given volume of soil may readily be determined.

The foregoing statements make it evident that the apparent specific gravity should be known for the soil in its natural condition.

Measurements of the apparent specific gravity of several different classes of soil in their natural condition in the Sacramento Valley, California, gave results as follows:

CLASS OF SOIL	APPARENT SPECIFIC GRAVITY
Silt-loam soils having fine, sandy loam subsoils	1.15
Silt-loam soils	1.31
Clay-loam soils	1.35
Clay soils	1.69

The influence of these different apparent specific gravities of soil on pore space is reported in connection with a discussion of the water capacity of soils in Chapter IX.

111. Pore Space. — The volume of a 1-inch diameter marble is 0.524 cubic inch. If the marble is placed in a cubical box having a capacity of 1 cubic inch there will remain an air space of 0.476 cubic inch, or 47.6 per cent of the total volume. The same air space will be left by any number of marbles of any diameter if arranged in **vertical** columns, as shown in part of Fig. 80. If, however, the marbles are arranged in **oblique** order, as also shown in Fig. 80, there will remain only 25.9 per cent air space. These facts show that considerable variation of pore space between spherical particles may result from change in arrangement, but they do not show the maximum range of variation that may occur in the soil. In almost every soil there is great variation in the size and the shape of the particles, and these differences in particles influence the closeness of contact and the inter-packing of small particles between large ones, thus determining the total percentage of pore space, which for convenience is represented by the symbol *S*. In general, the coarse-textured, gravelly, and sandy soils have the smaller pore space, and the fine-textured clay loams and clays have the greater pore space. It is not unusual to find a variation in irrigated soils of from 30 to 60 per cent pore space. Some clay soils, contrary to the general rule, are very compact. Certain soils in the Sacramento Valley, California, of very fine texture, have been found to have only 36 per cent pore space. To compute the percentage pore space (*S*) it is necessary only to know

the real and the apparent specific gravity of the soil. The ratio of the apparent to the real specific gravity gives the proportionate space occupied by the soil, and this subtracted from unity gives the pore space

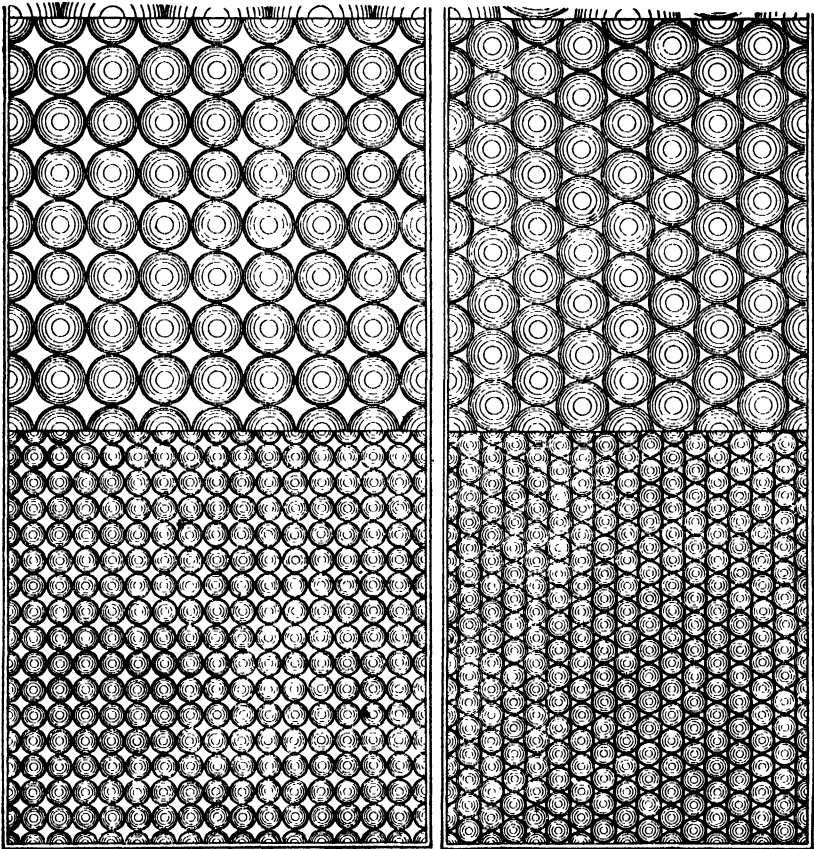

FIG. 80. — Illustrating arrangement to give maximum and minimum pore space between spherical soil grains. (U. S. Geological Survey 19th Ann. Report.)

as shown above in connection with the marble example. The pore space on a percentage basis is given by the equation:

$$S = 100(1 - A_s/R_s) \dots \dots \dots (33)$$

where S = the percentage pore space.

A_s = the apparent specific gravity.

R_s = the real specific gravity

112. Permeability. — A property of every soil of very great importance to the irrigator is the readiness with which water will penetrate it in response to the force of gravity. This property is commonly known as the permeability of the soil. Water standing on gravelly or coarse sandy soils penetrates the soil so rapidly that the water surface will be lowered several inches in an hour. On the other hand, some fine-textured clay soils are so impermeable to water that it will collect and stand on such soils seemingly with no penetration for many days. Between these two extremes there are obviously many degrees of permeability. A convenient means of expressing permeability is in terms of inches lowering of water surface per hour. For example, if an acre of level land at 9:00 o'clock is covered with water to a depth of 2 inches and at 10:00 o'clock the water is but 1 inch deep the permeability is 1 inch to the hour, neglecting evaporation losses. It is doubtless clear that in a given soil the permeability varies slightly with other factors, such as temperature and viscosity of water, but for the purposes of irrigation practice these minor variations may be ignored as is shown later in connection with a consideration of the influence of permeability on methods of irrigation.

113. Specific Water Conductivity. — Since the force of gravity on each unit mass of water in the soil always acts in a direction vertically downward, it is apparent that the term permeability as above defined applies precisely only to water that moves vertically downward under conditions in which unbalanced pressure forces are negligible or entirely absent. As a matter of fact, water may move in soils in any direction, depending on the direction of the resultant force which causes it to move. In order to distinguish clearly between the rate of the very common movement of water vertically downward in response to the force of gravity, above designated by the term permeability, and the rate of the more complex movement in any direction in response to a force of any magnitude, the term specific water conductivity is introduced and defined in Chapter X in which the principles governing the movement of water in soils are considered.

114. Depth of Arid-Region Soils. — As compared to humid-region soils, the soils of arid regions as a rule are relatively deep. Yet the importance of having an adequate depth of soil in which to store satisfactory depths of irrigation water at each application is usually given less emphasis than it merits. There are, to be sure, many areas of productive shallow soils in irrigated regions underlain at depths of 1 to 3 feet by coarse gravel, hardpan, or other formations in which plants obtain little or no sustenance. The farmer who irrigates shallow soils soon learns that frequent irrigations are essential to keep his crops growing, and also that excessive deep percolation losses usually occur when irri-

gating shallow soils that overlie coarse, porous sands and gravels. Many arid-region soils have great depth, from 10 to 25 feet or more. These deep soils, when of medium texture and loose structure, permit plants to root deeply, provide for the storage of large quantities of irrigation water in the soil, and consequently sustain satisfactory plant growth during relatively long periods between irrigations. The quantity of water actually absorbed and consumed to produce a given crop (2 tons of alfalfa for example) may be practically the same for crops grown on shallow and on deep soils, yet nearly all irrigators recognize that more water is required during the crop-growing season to irrigate a given crop on a shallow soil than is required for the same crop on a deep soil. The larger number of irrigations required for the shallow soils and the greater unavoidable water losses at each irrigation on the shallow soils account for the differences in practical water requirements during the season. The relation of the depth of soils to their water capacities is considered further in Chapter IX.

115. Plant-Food Compounds. — In order to produce large and satisfactory yields of crops, all soils, both in humid and arid regions, must have certain amounts of available plant-food compounds. Ten very important chemical elements are essential to plant growth, namely: calcium, carbon, hydrogen, iron, magnesium, nitrogen, oxygen, potassium, phosphorus, and sulphur. Of these ten chemical elements, owing to the sparse or scanty growth of native vegetation on the virgin soils of arid regions, the element nitrogen as a rule is relatively deficient in arid-region soils. Plants absorb nitrogen in the form of soluble nitrates which are dissolved in the water contained in the capillary form in the soil. In order to assure an adequate supply of available nitrogen it is essential, first, that the irrigated soils contain sufficient amounts of nitrogenous organic matter, which may be supplied from barnyard manure, or from the growing of legume crops as green manures; and second, that the soil moisture content, the structure, and the soil aeration, be made favorable to the bacterial activity which is essential to the formation of nitrates. It has been convincingly demonstrated by many experiments that, when grown in soils having an abundance of available plant food, plants consume relatively small amounts of irrigation water to produce a given crop yield; and, on the other hand, that when grown in soils that are deficient in available plant food, large amounts of water are consumed to produce a given crop yield. It is therefore vitally necessary that arid-region farmers pay particular attention to the maintenance of a high state of productivity in their soils in order to obtain a high efficiency in the consumptive use of water in crop production. The low rainfall of arid regions results in a comparatively small amount of

leaching, and hence arid soils are usually high in the more important mineral plant food elements, particularly calcium, phosphorus, and potash. The open structure of arid soils permits very favorable aeration to great depths, and consequently favorable bacterial activity occurs at much greater depths in arid- than in humid-climate soils. For a more detailed statement of the properties of arid-climate soils the reader is referred to Chapters XX and XXI of *Soils* by Hilgard.

116. Excess Soluble Salts. — The arid-region conditions of low precipitation, high evaporation, and relatively small amounts of soil leaching, though favorable to the occurrence of satisfactory quantities of calcium, phosphorus, and potash, also result in the accumulation of excessive quantities of soluble salts that retard or inhibit plant growth. These accumulations of excess soluble salts are commonly known as alkali. The most beneficial plant food compounds, such as sodium nitrates and potassium nitrates, when accumulated in the soil in excessive amounts, become harmful to plants. Though peculiar to arid regions, alkali soils are by no means of general occurrence in arid regions. There are many areas of highly productive soils of the West which have always been entirely free from alkali troubles. Moreover, these areas probably never will be adversely influenced by the occurrence or the accumulation of alkali. Nevertheless, alkali is unquestionably the cause of widespread sterility and barrenness in some arid-region soils. A large amount of research has been directed toward the solution of the alkali problem in the West. The waters of some arid-region streams and rivers contain appreciable amounts of alkali, the actual amounts being influenced by the soils from which the waters flow into the streams and rivers. Because of the importance of alkali as a property of arid-region soils and its relation to irrigation practice, an entire chapter is given to its consideration. The reader will find more detail concerning alkali in Chapter XI.

REFERENCES

- HILGARD, E. W. *Soils*, The Macmillan Co., New York. 1918.
HARRIS, F. S., and ROBINSON, J. S. Factors Affecting the Evaporation of Moisture from the Soil, *Jour. Agr. Research*, 7: 10: 439-461. 1916.
ISRAELSEN, O. W. Studies on Capacities of Soils for Irrigation Water, and a New Method of Determining Volume Weight, *Jour. Agr. Research*, 13: No. 1. 1918.
LYON, T. LITTLETON, and BUCKMAN, HARRY O. *The Nature and Properties of Soils*, The Macmillan Co., New York. 1922.

CHAPTER VIII

BASIC SOIL AND WATER RELATIONS

The functions of soil moisture in plant growth are very important. Excessive amounts of water in soils retard or inhibit plant growth and make drainage essential to profitable farming. Sterility of arid-region lands is usually caused by deficient quantities of water in the soils. Broadly speaking, therefore, irrigation is but an artificial means of properly regulating the moisture content of soils to make optimum growth of plants possible. It is, of course, true that irrigation is primarily a means of preventing deficiencies in the moisture content of soils, but intelligent irrigation practice, based on reliable knowledge of basic soil moisture relations, is also a means of preventing, or at least retarding, the occurrence of excessive quantities of water in irrigated soils. It is therefore fitting that students of irrigation give some consideration to the basic physical laws that influence the distribution, storage, and movement of water in unsaturated soils. This water is usually designated as soil moisture.

Many simple experiments by physicists have established beyond doubt the existence of inter-molecular forces of very great magnitude at small distances. These experiments show also that inter-molecular forces diminish so rapidly with distance as to become negligible at distances which are very small fractions of a millimeter. These inter-molecular forces give rise to so called "capillary phenomena" which are of special interest in the study of soil and water relations. The close contact of soil particles and the particles of very thin water films gives rise to attractive forces of large magnitude. Inter-molecular forces and the phenomenon of surface tension are of interest to students of irrigation.

117. Classes and Availability of Soil Water. — Soil water is generally classified as hygroscopic, capillary, and gravitational. The hygroscopic water is that found on the surface of the soil grains, which is not capable of movement through the action of gravity or capillary forces. Capillary water is that part in excess of the hygroscopic water which exists in the capillary spaces of the soil and which is retained against the force of gravity in a soil which permits unobstructed drainage. Gravitational water is that part in excess of the hygroscopic and capillary water which

is free to move out of the soil if favorable drainage is provided. There is no precise boundary surface between these three classes of soil water. The proportion of each class depends on the soil texture, its structure, the surface tension of the water, its temperature, and the depth of soil column considered. These classes of soil water are illustrated in Fig. 81,

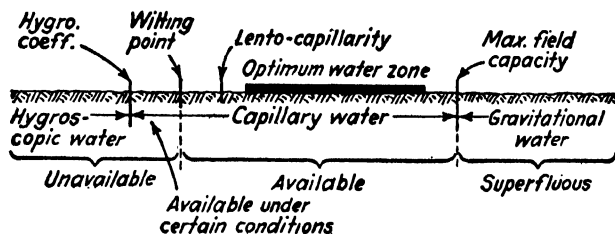

FIG. 81. — Classes of soil water and their availability to plants. (From "The Nature and Properties of Soils" by Lyon and Buckman — The MacMillan Company, Publishers.)

which also shows the optimum water zone, the unavailable, the available, and the superfluous water.

118. Surface Tension. — The phenomenon of surface tension is due to unbalanced molecular forces. In any body of water the particles in the interior of the liquid are attracted equally in all directions by the other particles of the liquid, as illustrated by the particle at the point *A*

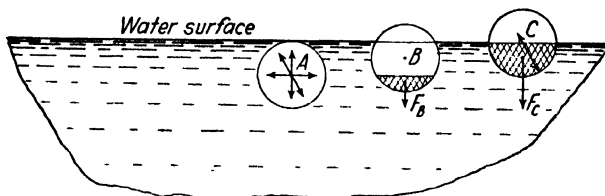

FIG. 82. — Illustrating the fact that surface tension is due to unbalanced molecular forces. ("Mechanics, Molecular Physics and Heat" — Millikan. Ginn and Company, Publishers.)

in Fig. 82. A particle on the water surface, on the contrary, is not attracted equally on all sides, since the molecules of the air surrounding the particle exert less attraction upon the surface water particle than is exerted by the interior particles of the liquid. There is consequently a resultant inward attraction along a line perpendicular to the surface of the liquid as illustrated at points *B* and *C* of Fig. 82.

119. Pressure of a Film. — In Chapter II it is shown that flow of water in pipes may be caused by forces which result from pressure differences. Attention is here directed to the fact that movement of capillary

soil moisture is caused in part by the forces which result from differences in film pressures. In the study of film pressures in unsaturated soils it is important to keep in mind the fact that the water-air surfaces are concave toward the air, and that, as a result, the film pressures are *negative*, whereas the hydrostatic pressures considered in Chapter II are *positive*. The magnitude of the film pressure can be determined provided the surface tension of the substance and the curvatures of the films are known. For example, conceive of a film surface of the shape of an ellipsoid as illustrated in Fig. 83. Consider that the ellipsoid is bisected first by a plane lying in the paper, and second by a plane at right angles to the paper. Then the magnitude of the film pressure at the point *A* is influenced by the major radius, r_1 , and by the minor radius, r_2 . It is also influenced by the surface tension of the film substance. The pressure, p , is given by an equation well known to physicists, i.e.:

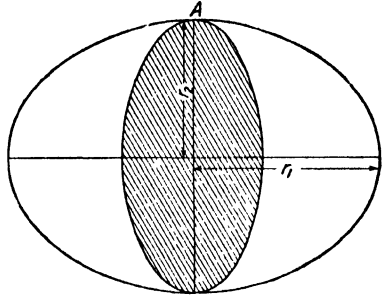

FIG. 83. — Ellipsoid surface to illustrate meaning of equation (34) giving the pressure of a film.

$$p = T(1/r_1 + 1/r_2) \dots \dots \dots (34)$$

where T represents the surface tension of the substance of which the film is composed. For a sphere, $r_1 = r_2$, it follows that

$$p = 2T/r \dots \dots \dots (35)$$

which means that the film pressure of a spherical surface is twice the surface tension divided by the radius.

In centimeter-gram-second units, p = dynes per square centimeter; T = dynes per centimeter. In Chapter II it was stated that $p = wh$, where

- p = pressure per unit area.
- w = weight (or force) per unit volume of water.
- h = height of water column over the unit area.

It is also true that $p = \rho gh$, where

- ρ = density, i.e., mass per unit volume.
- g = weight (or force of gravity) per unit mass.
- h = height of water column.

Substituting in equation (35) for p its value as just given, there results $\rho gh = 2T/r$, from which in centimeter gram second units:

$$h = \frac{2T}{\rho gr} = \frac{2T}{1 \times 981 \times r} = \frac{2 \times 75.6}{981r} = \frac{0.15}{r} \dots \dots (36)$$

Equation (36) gives the height in centimeters to which water at 0° C. will rise in a capillary tube of radius r centimeters, the surface tension being 75.6 dynes per centimeter.

Applying essentially the same reasoning as underlies equation (36) to ideal soils in which the capillary tubes are triangular in cross-section, Keen has shown that the maximum height of rise of water in centimeters is given approximately by the equation:

$$h = 0.75/r \quad \text{and} \quad h = 1.5/d \dots \dots (37)$$

in which r is the radius and d the diameter of the soil particles in millimeters.

Because of the great variability in natural soils and the changes in size of capillary tubes, the actual heights of rise of water by capillarity are usually less than the theoretical heights computed from equation (37).

Lee found that the capillary lift is limited to 4 feet in coarse sandy soil and to 8 feet in sandy or clayey soils.

In general terms, McGee says that under average conditions capillarity acts freely to 4 or 5 feet, fairly to 10 feet, and slowly to 30 or more feet.

Equation (37) shows that the film pressure applied to soil moisture increases as the radius of the capillary water film decreases. Soils of a given texture and structure having low percentages of capillary water have therefore high capillary pressures, whereas the same soils having high percentages of capillary water give rise to low capillary pressures. These facts simplify observed soil and water relations, such for example as the distribution of capillary water in the soil above a water table.

120. Equilibrium Water Conditions. — Consider a unit volume within a vertical soil column at a height h_a above the surface of free water as illustrated in Fig. 84. By equilibrium conditions it is meant that there are no unbalanced forces within the unit volume of soil, and consequently no movement of moisture. The attainment of equilibrium conditions is difficult. It may require much time together with the maintenance of constant temperature and prevention of evaporation. However, for the purpose of this chapter it is necessary only to *assume* the attainment of equilibrium conditions. Assume two further conditions:

(a) That the unit volume selected is 1 cubic centimeter; and
 (b) That the mean moisture content of the soil within the cubic centimeter is 20 per cent by volume. Then the actual weight of water within the cubic centimeter is 0.2 gram. For convenience, the 0.2 gram of water is illustrated by the black cube to the reader's left of the soil column. To the student of physics it is at once evident that the force of gravity is pulling down on the 0.2 gram of water and that the magnitude of the gravitational force is $0.2 \times 980 = 196.0$ dynes. The cubic centimeter of soil is completely surrounded by soil containing capillary water, and hence

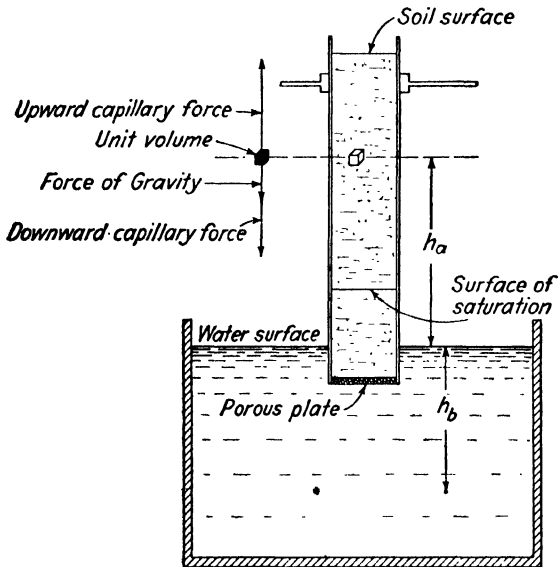

FIG. 84. — Illustrating the equal magnitude of the vertical forces which act on the water in any unit volume of a soil in which the capillary water is at equilibrium with the ground water.

there must be a downward capillary force, as illustrated in Fig. 84. But, since under equilibrium conditions there are no unbalanced forces and no capillary movement, it follows that the upward capillary force on the 0.2 gram of water is equal in magnitude to the sum of the downward capillary and gravity forces. As shown by the analysis of Article 119, the capillary forces are relatively large in soils of low moisture content and relatively small in soils of high moisture content. Hence it is apparent that in the upper part of the cubic centimeter the moisture content must be less than it is near the lower part, otherwise the upward capillary force could not exceed the downward capillary force. There-

fore, at equilibrium moisture conditions the capillary moisture content must decrease as the height of the soil above the free water surface increases.

The conclusion from the above analysis is well supported by the results of experiments on the distribution of capillary moisture in soils.

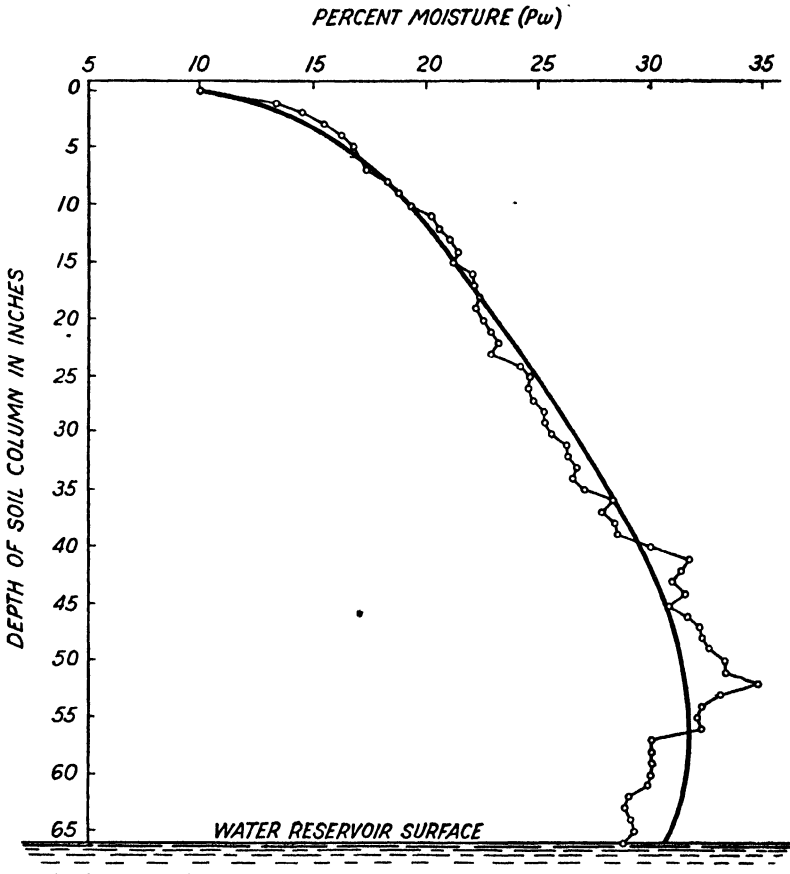

FIG. 85. — Distribution of capillary water in a vertical column of Idaho lava ash soil after 46 days in contact with a water reservoir. (U. S. Dept. Agr. Dept. Bul. 1221.)

As a result of measurements of water distribution in many soil columns of small cross-section, McLaughlin found repeatedly, subject to certain minor discrepancies near the free water surface, that the capillary moisture content of different soils after many days of contact with free

water decreased with increase in height above the free water surface. A typical illustration of McLaughlin's work is given in Fig. 85, representing the moisture distribution after a vertical column of Idaho lava ash soil had been in contact with water for 46 days. The free water surface was 66 inches below the surface of the soil column. From a point about 15 inches above the water surface the moisture content decreased with increase in height from more than 30 per cent to less than 15 per cent. Why the moisture content decreased from the water surface up to 1.5 inches is not clear. Veihmeyer, Israelsen, and Conrad studied the distribution of moisture within a thin layer of soil after it had been subjected to a centrifugal force of approximately 1000 times gravity in a moisture equivalent centrifuge. The results of their work are given in Fig. 86. The inner soil surface (the surface nearest the axis of the moisture equivalent machine) is represented by the top of the figure, and the outer soil surface by the bottom of the figure. The rotation of the block of soil in the machine throws the gravitational water out through a perforated wall at the outer surface of the soil column. Hence the curve of Fig. 86 shows the distribution of the capillary moisture which took place to form an equilibrium condition with the throw-off force induced by the rotation of the machine. There is clearly a marked increase in moisture content from the inner to the outer surface, analogous to the increase in field-soil moisture content at equilibrium with increase in depth of soil.

The conclusion from the above analysis is supported by the author's field experiments on soil moisture distribution. The moisture content of the upper 12 feet of a non-cropped soil 68 days after irrigation, when corrected for variations in soil texture, showed a substantial increase with increase in depth of soil. The average moisture content in 3 different plats is shown in Fig. 87.

121. Soil Texture and Equilibrium Water Conditions. — In Fig. 88 the probable distribution of moisture in three soils of different texture at equilibrium is illustrated. For convenience, a point in the saturated surface is selected as origin, the horizontal coordinate representing percentage capillary water, and the vertical coordinate representing distance vertically above the saturated surface. Three things are suggested by Fig. 88:

- (1) That under equilibrium conditions the moisture content of a soil decreases as the distance from the surface of saturation increases.
- (2) That, at a given distance above the saturated surface as represented by h , the clay soil has a higher percentage of mois-

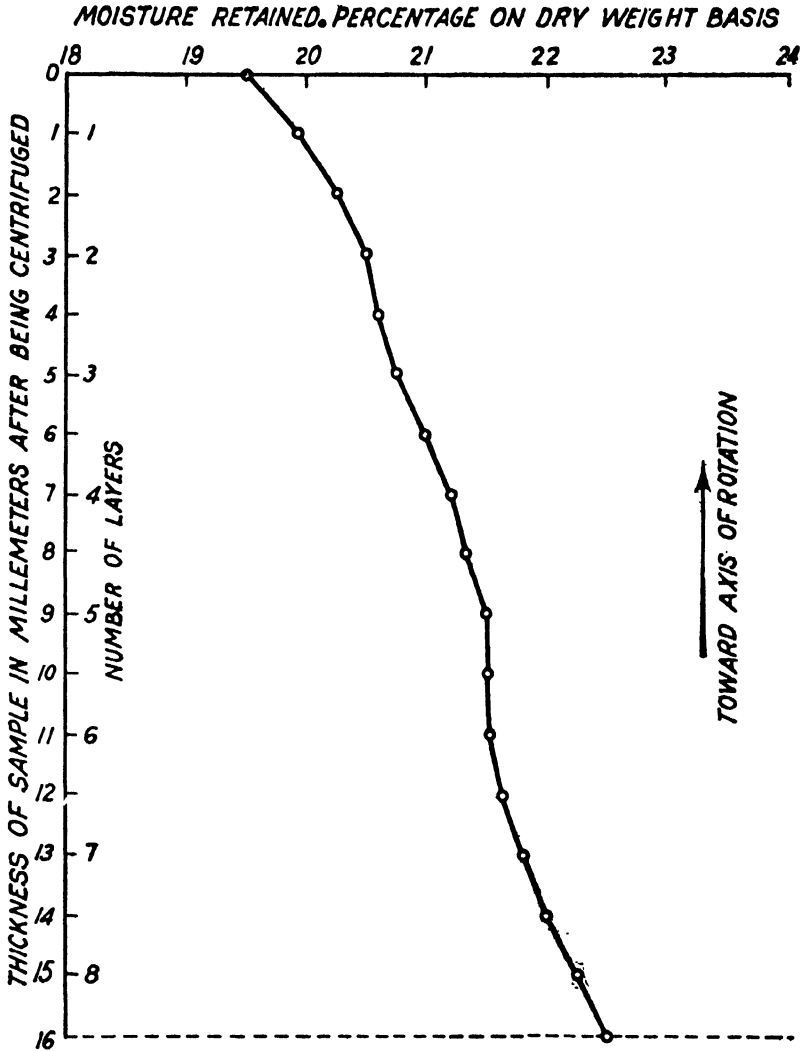

FIG. 86. — Moisture distribution in a 60-gram sample of yolo caly loam soil after being subjected to a centrifugal force of 1000 times gravity for a period of one-half hour. (Calif. Agr. Exp. Sta. Tech. Paper No. 16.)

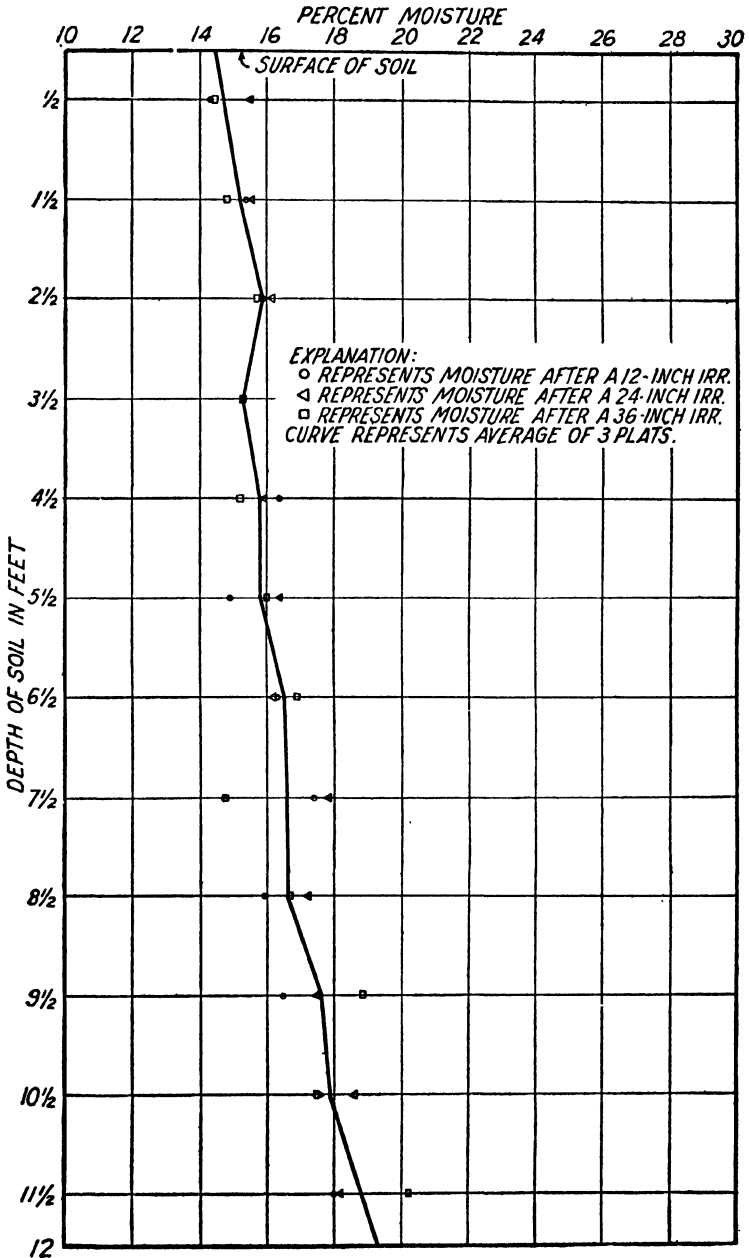

FIG. 87. — Distribution of moisture in soil 68 days after irrigation as corrected for variation in soil texture, thus showing distribution that would have occurred in a soil of uniform texture. (Calif. Agr. Exp. Sta. Hilgardia Vol. 2 No. 14.)

ture than the loam, and the loam has a higher percentage than the sand.

- (3) That any given moisture percentage, ρ , at equilibrium, will be at the highest point in the clay and the next highest in the loam, and lowest in the sand.

These facts, illustrated in Fig. 88, are based on the fundamental laws of surface tension and film pressures, as is briefly indicated in the reasoning which follows: Rewriting equation (36) in its general form, it is apparent that

$$h = 2T/\rho gr \dots \dots \dots (38)$$

In equation (36) the density of the water, ρ , was taken as unity, there being in a body of free water 1 gram of water per cubic centimeter of

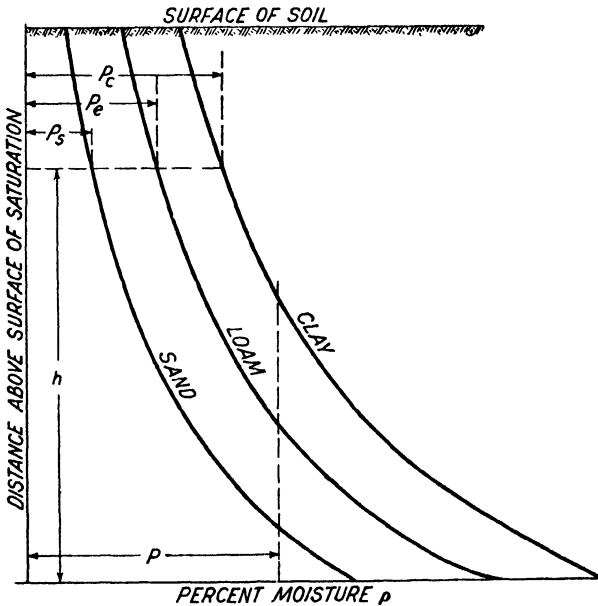

FIG. 88. — Illustrating the probable distribution of capillary water in soils of different texture under equilibrium conditions.

volume. However, in a body of moist soil there is always less than 1 gram of water per cubic centimeter of total volume. Each cubic centimeter in a body of unsaturated moist soil is partly filled with solid soil particles, partly with water in the form of soil moisture, and partly with air. The density of water in a moist soil is therefore defined as the

mass (grams) of water per unit volume (cubic centimeters) of total space, i.e., space occupied by soil, water, and air. The density thus defined is clearly a variable. It is always less than unity; and it ranges from approximately 10 per cent as a minimum to 50 per cent as a maximum in a loam soil.

In any given soil the radii of the soil pores do not change appreciably with time and may be considered as constant; also, with constant temperature the surface tension of the soil water, T , may be considered as nearly constant; and the force of gravity is constant at a particular place. It therefore follows from equation (38) that under constant compactness of the soil and under equilibrium soil moisture conditions the product

$$h\rho = \text{a constant} \dots \dots \dots (39)$$

Equation (39) shows that as h increases the mass of water per unit volume of soil, i.e. ρ , must decrease, thus supporting the first fact illustrated in Fig. 88 and stated above.

Fine-textured soils have a much larger surface area of soil particles per cubic centimeter of soil than coarse-textured soils have. A given mass of water, ρ , in a cubic centimeter of clay is therefore spread over a large surface, and the radius of the film curves between the soil particles is relatively small. In order to make the radii of the water films in the clay as large as those in a sand, larger moisture content is needed. Or, stated mathematically, in order to make h constant at equilibrium in soils of variable texture and variable radii of water films, r , the product, ρr , of equation (38) must be kept constant, and hence since r in clay soils is less than r in sandy soils, ρ must be greater. For a given moisture content (or density) $\rho = \text{a constant}$. It then follows from equation (38) that

$$hr = \text{a constant} \dots \dots \dots (40)$$

It is apparent from equation (40) that in clay soils in which r is relatively small, h must be relatively large, and that in sandy soils in which r is relatively large, h must be relatively small, thus confirming the third fact stated above.

For a given moisture content ρ in a loam soil the height at equilibrium is between that of clay and sand because the diameters of the particles and radii of moisture films are larger than in the clays and smaller than in the sands.

122. Soil Moisture Constants. — The equilibrium quantities of moisture in the soil at different conditions are known as soil moisture constants. These constants include:

- (a) hygroscopic coefficient;
- (b) permanent wilting of plants;
- (c) moisture equivalent;
- (d) field capillary moisture capacity;
- (e) complete saturation.

The percentage of moisture in the soil representing each of the soil moisture constants is usually given on the dry-weight basis. Brief definitions of each of these constants follow.

The hygroscopic coefficient is defined as the percentage of water that a soil will absorb at a given temperature in a saturated atmosphere. Recent laboratory measurements by Linford showed that a soil exposed to a saturated atmosphere in a dark, constant-temperature chamber will continue to absorb water until its moisture content is in excess of the permanent wilting percentage, and also that the equilibrium point reached under variable temperature conditions is influenced by the intensity of light. The results of analysis by Linford based on the laws of mechanics also throw doubt on the utility of the hygroscopic coefficient as a soil moisture constant.

The permanent wilting point is defined as the percentage of moisture in the soil at which plants wilt permanently, unless water is applied to the soil. Further consideration is given the wilting point in Chapter XIII.

The moisture equivalent is defined as the percentage of water retained by a small sample of soil after being subjected to a centrifugal force of 1000 times gravity for about $\frac{1}{2}$ hour. In order to be sure that moisture equivalent determinations made by different workers in various laboratories are comparable, it is essential that standard procedure be followed in determining the moisture equivalent. The work by Veihmeyer, Israelsen, and Conrad on "The Moisture Equivalent as Influenced by the Amount of Soil Used in its Determination" shows that variation in the amount of soil used, and also in other factors, causes variation in the moisture equivalent.

In well-drained soils, water moves downward at a relatively rapid rate during irrigation and for several hours after irrigation. The percentage of moisture held in such soils at any specified time (say one to three days after irrigation) is defined as the field capillary moisture capacity. As shown in Article 120 and accompanying illustrations, the field capillary moisture capacity *at equilibrium* at any depth of soil is influenced by the distance of such depth from the surface of complete saturation.

The moisture content at complete saturation represents the condition when all the soil pore space is filled with water and the soil air driven out.

The magnitude of the three constants (a) hygroscopic coefficient, (b) permanent wilting point, and (c) moisture equivalent is influenced largely by the texture of the soil, whereas the magnitude of the two constants (d) field capillary moisture capacity and (e) complete saturation is influenced by both the texture and compactness of the soil. In general, each of the soil moisture constants is relatively low in soils of coarse texture. The term soil moisture constant is therefore somewhat misleading because in reality the equilibrium amount of water in a soil at permanent wilting, for example, varies according to the fineness of the soil particles. In Fig. 89 the approximate relative magnitudes of the several soil moisture constants for a particular soil are illustrated.

The presence of a high content of organic matter in a soil influences the soil moisture constants. Most irrigated soils are relatively low in organic matter, and hence major attention is here given to the influence of the physical soil properties, i.e., texture, and structure.

123. **Application in Irrigation Practice.** — Knowledge of soil and water relations is valuable to water masters, canal riders, and irrigation company officers, all of whom have the opportunity to improve irrigation practice. Such knowledge is also of value to irrigators who desire to obtain the best possible use of the water available for their farms. If irrigation is long delayed and the soil moisture content is reduced to the permanent wilting point, the plants suffer and crop yields are reduced. Methods of determining when it is best to irrigate are considered in Chapter XIII. It is essential also that the irrigator have the best available information as to how to apply water in such amounts as will meet the needs of his particular soils and crops.

In irrigated regions, even more than in humid regions, soils are essentially reservoirs in which water is stored on a certain day at the time of irrigation to supply the needs of the crops for a number of days or weeks. If the irrigator applies more water than the soil reservoir can hold at a

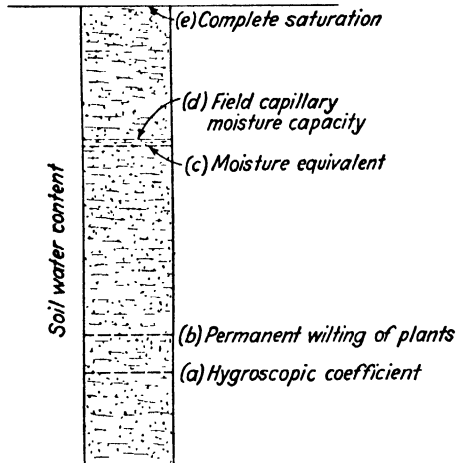

FIG. 89. — Illustrating the approximate relative magnitudes of soil moisture constants.

single irrigation, the excess is wasted. If he applies less than the soil will retain the plants may suffer for water before the next irrigation, unless water is applied more frequently than otherwise would be necessary. In the next chapter, attention is given to the storage of irrigation water in soils.

REFERENCES

- CHRISTENSEN, OSWALD. An Index of Friability of Soils, *Soil Sci.*, **29**, No. 2 : 119-135. 1930.
- GARDNER, WILLARD. Capillary Moisture-holding Capacity, *Soil Sci.*, **7**, No. 4. 1919.
- GARDNER, WILLARD. The Capillary Potential and its relation to Soil Moisture Constants, *Soil Science*, **10**, No. 5. 1920.
- KEEN, BERNARD A., A Note on the Capillary Rise of Water in Soils, *Jour. Agr. Sci.*, **9** : 396. 1919.
- LEE, CHARLES H. Water Resources of a Part of Owens Valley, California, U. S. G. S., Water Supply Paper No. 294. 1912.
- LINFORD, LEON B. Soil Moisture Phenomena in a Saturated Atmosphere, *Soil Sci.*, **29**, No. 3 : 227-236. 1930.
- LINFORD, LEON B. The Relation of Light to Soil Moisture Phenomena, *Soil Sci.*, **22**, No. 3 : 233-251. 1926.
- MCLAUGHLIN, W. W. The Capillary Distribution of Moisture in Soil Columns of Small Cross Section, U. S. D. A. Dept. Bul. 1221. 1924.
- RICHARDS, LORENZO A. The Usefulness of Capillary Potential to Soil-Moisture and Plant Investigators, *Jour. Agr. Research*, **37**, No. 12. 1928.
- RUSSELL, J. C., and BURR, W. W. Studies on the Moisture Equivalent of Soils, *Soil Sci.*, **19**, No. 4 : 251-266, Fig. 9. 1925.
- SCOFIELD, CARL S. The Effect of Absorption by Plants on the Concentration of the Soil Solution, *Jour. Agr. Research*, **35**, No. 8 : 745-756. 1927.
- VEIHMEYER, F. J., OSERKOWSKY, J., and TESTER, K. B. Some Factors Affecting the Moisture Equivalent of Soils, *Proc. and Papers of the First International Congress of Soil Sci.*, June 13-22, 1927, I : 1-23. 1927.
- VEIHMEYER, F. J., ISRAELEN, O. W., and CONRAD, J. P. The Moisture Equivalent as Influenced by the Amount of Soil Used in its Determination, *California Agr. Exp. Sta. Tech. Paper* 16 : 1-60. Figs. 1-9, pl. 1. 1924.
- WILSDON, V. H. Studies in Soil Moisture, *India Dept. Agr. Mem. Chem. Series* 6, No. 3 : 155-186, pls. 5, Figs. 6. 1921.

CHAPTER IX

STORAGE OF WATER IN SOILS

The storage of water in soils is important in humid and arid regions. That some humid-climate soils produce crops despite the elapse of many days and sometimes weeks, between periods of rainfall, is evidence of their water-storage capacity, since all growing plants require water continuously. The rate of use of water by growing crops varies from day to day and week to week, but when the soil cannot supply water to the plant, growth is at once retarded and soon prevented entirely. In irrigated regions the capacity of soils to store water for the use of growing crops is of special importance and interest. The economical interval between irrigations is greatly influenced by the storage capacity of the soil for water. Moreover, irrigated soils of relatively large water-holding capacity may produce profitable crops in places where, and at times when, the shortage of irrigation water makes it impossible to irrigate as frequently as would otherwise be desirable. Knowledge of the capacity of soils to retain irrigation water is essential to economical irrigation. Water losses which result from surface run-off can easily be detected and measured, whereas those which result from deep percolation below the root zone of crops cannot be seen and can be detected only by comparisons of the amounts of water applied in single irrigations with the storage capacities of the various soils for water.

124. Forms of Water Stored. — In irrigated regions, water is stored in the soil both in capillary and gravitational form. As a general rule, the storage of capillary moisture is of major importance; however, in localities where the late-season water supply is always low, and storage reservoirs are impracticable or economically prohibitive, storage of water in the gravitational form in the soil is sometimes advantageous. Excessive application of water for the purpose of storage may cause the ground water to rise too far and thus become injurious to crops during the early part of the season.

125. The Soil Auger. — It is highly desirable that irrigation farmers observe by inspection and sometimes by measurement the quantities of moisture in their soils. Boring or drilling deeply into the soils of arid regions is essential for the desired information concerning soil moisture conditions.

Two types of soil augers are used: one a spiral-shaped bit made from a 1½-inch carpenter's standard wood auger bit, and one a 2-inch post-hole-type auger made especially for boring into the soil.

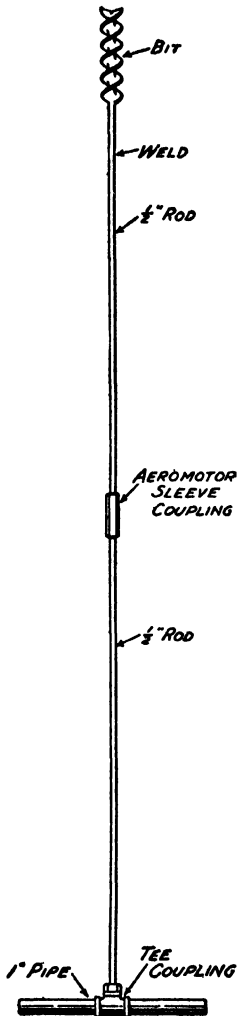

FIG. 90. — Spiral bit soil auger. (Calif. Agr. Exp. Sta. Circular 306.)

The spiral bit auger is illustrated in Fig. 90. The screw-point and the side-cutting edges of the carpenter's auger are removed in preparing the bit for soil boring. The spiral auger is light in weight, convenient to carry around, and for some soils it is preferable to the post-hole-type auger. In using it in compact soils care is necessary to avoid boring too deeply at one time and thus causing the auger to lodge in the soil. Use of the post-hole-type auger, illustrated in Fig. 91, does not involve this danger because when filled with soil it does not easily advance further into the soil.



FIG. 91. — Post-hole-type auger.

Physical properties of soils *cannot* be satisfactorily determined from inspection of the land surface. It is especially helpful to irrigation farmers to study the texture, structure, and depth of their soils by the use of a soil auger or a soil-sampling tube, in order to adjust their irrigation methods and practices according to the needs of the soils. Losses of water through deep percolation from shallow soils may be reduced by efficient application of water if the irrigator is well informed concerning the texture and depth of his soil.

Small-diameter augers of this type are used for studying the distribution of irrigation water in soil. (Courtesy: Iwan Brothers.)

126. An Improved Soil-Sampling Tube. — F. H. King, one of America's pioneer soil scientists, designed and used a steel tube for sampling field soils. During recent years the "King soil tube" has been improved by Veihmeyer and associates of the California Agricultural Experiment Station. After several years' experience in the use of different soil-sampling devices in irrigation and soil moisture studies, Veihmeyer concluded that

After several years' experience in the use of different soil-sampling devices in irrigation and soil moisture studies, Veihmeyer concluded that

the samples of soil obtained by use of the improved soil-sampling tube give more accurate and consistent results than those obtained by use of other sampling devices. In soils containing gravel it is frequently difficult, and sometimes impossible, to obtain samples by the use of a soil auger, whereas with a properly made sampling tube it is possible to cut through layers of gravel and obtain satisfactory samples.

As illustrated in Fig. 92, each tube consists of three parts: a tube of seamless steel of the desired length, a driving head, and a point. Each

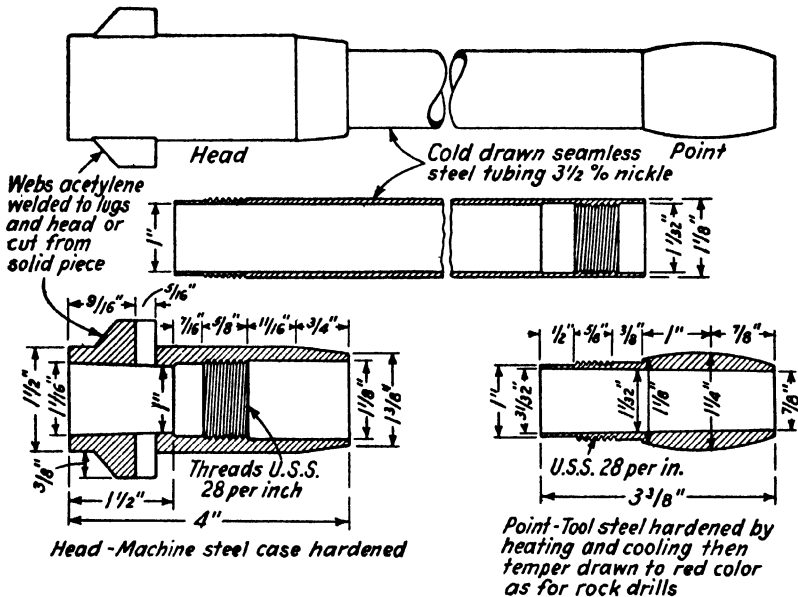

FIG. 92. — Details of soil-sampling tube. (Williams and Wilkins Company, Soil Science Vol. XXVII No. 2.)

end of the tube is threaded to facilitate attachment of the head and the point. A special hammer is used to drive the tube into the soil.

In the design of the improved tube, extraordinary precautions have been taken, as reported by Veihmeyer, to reduce the difficulties of removing the tube from the soil. Where samples need be taken to great depths, 12 to 18 feet, a "puller" made of two automobile jacks mounted on a base and connected at the top by a yoke may be used to draw the tube from the soil.

Taylor and Blaney, working in Southern California, have designed and built "an efficient soil tube jack" with which they have drawn tubes after sampling the soil to a depth of 18 feet. They have

pulled tubes wherever it was possible to drive them with a 30-pound hammer.

The improved soil-sampling tube is now widely used in California. In soil moisture studies conducted by the University it is used almost exclusively, and it is also used by a number of agricultural engineers in private practice who advise owners of orchards when to irrigate.

127. Soil Moisture Content. — In order to determine the moisture content of a field soil it is common practice to bore or drill to the desired depths with a soil auger or a soil tube, place samples of the moist soil in tin cans provided with tightly fitting covers, and then take the soil samples to a laboratory for weighing and drying. Samples of 100 or more grams of moist soil are put in an oven having a temperature of 110° C. and kept in the oven until the soil is free from moisture. The loss of weight in drying, considered equal to the weight of the water in the soil before drying, divided by the weight of the water-free soil gives the ratio of the weight of water to the weight of the soil, which multiplied by 100 is the moisture percentage on the *dry-weight basis*, represented by the symbol P_w . For example:

weight of moist soil	100 grams
weight of water-free soil	80 grams
loss of weight in drying	20 grams

Then P_w , i.e., the moisture percentage on the dry-weight basis, = $20/80 \times 100 = 25$. Measurements of soil moisture content are sometimes reported on the *wet-weight basis*; that is, in the above example, the moisture percentage on the wet-weight basis = $20/100 \times 100 = 20$. The apparent advantage of the wet-weight basis is the simplicity of computation provided 100 grams of moist soil are used. In reality, however, the wet-weight basis is irrational because the reference base for the percentage computation, i.e., the weight of the wet sample of soil, varies according to the moisture content of the soil. For very moist soils the moisture percentages computed on the wet-weight basis are especially misleading. Interpretations of the significance and influence of different quantities of water in the soil, both in relation to water storage and to plant growth, are facilitated by converting the moisture percentage on the dry-weight basis to the volume basis. The percentage on a volume basis is defined as the volume of water per unit volume of space within the body of soil. For example, if a cubic foot of space within the soil contains $\frac{1}{4}$ cubic foot of air, $\frac{1}{4}$ cubic foot of water, and $\frac{1}{2}$ cubic foot of solid soil particles, the percentage of moisture on the volume basis, represented by the symbol P_v , is 25. It is impracticable by direct means to measure the volume of water that exists in the form of soil.

moisture in a unit volume of soil. The ordinary practice of drying the soil in an oven as a means of extracting the water from it results in a loss of water in the form of vapor. It is therefore desirable to convert dry-weight basis moisture percentages, P_w , to volume percentages, P_v . Using the symbol A_s to represent the apparent specific gravity of the soil, the relation of P_v to P_w is determined as follows: By definition, when expressed as a fraction:

$$P_v = \frac{\text{volume of water in soil}}{\text{total volume occupied by the soil}}$$

and

$$P_w = \frac{\text{weight of water in soil}}{\text{weight of the dry soil}}$$

Dividing P_v by P_w , there results:

$$\frac{P_v}{P_w} = \frac{\text{volume of water in soil}}{\text{total volume occupied by the soil}} \times \frac{\text{weight of dry soil}}{\text{weight of water in soil}}$$

Assume, for example, that 1 cubic foot of soil is used to determine moisture content and that it contains 15.6 pounds of water and 80.0 pounds of dry soil. Remembering that 1 cubic foot of water weighs 62.4 pounds, it follows that:

$$\frac{P_v}{P_w} = \frac{15.6/62.4 \times 80.0}{1 \times 15.6} = \frac{80.0}{62.4} = 1.28$$

The apparent specific gravity of the soil, represented by the symbol A_s , as stated in Chapter VII, is defined as the ratio of the weight of a given volume of soil, say 1 cubic foot, to the weight of an equal volume of water. It is therefore apparent in the above example that $A_s = 80.0/62.4 = 1.28$, and hence that

$$P_v = A_s P_w \dots \dots \dots (41)$$

Based on equation (41), Table XVI gives the moisture per cents on the volume basis that are equivalent to different per cents on the dry-weight basis.*

*The technical student will probably be interested in the following analysis:

Let ρ_w = moisture (or water) density, i.e., mass of water per unit volume of space occupied by soil, air, and water (as used in Chapter VIII).

ρ_s = soil density, i.e., mass of dry soil per unit volume of space.

P_w = the mass of water per unit mass of dry soil.

The above quantities have physical dimension of length (L), mass (M), and time (T) as follows, using the subscript (w) to signify mass of water and the subscript (s) to

TABLE XVI

MOISTURE PER CENTS ON THE VOLUME BASIS, P_v , EQUIVALENT TO VARIOUS PER CENTS ON THE DRY-WEIGHT BASIS, P_w , FOR SOILS OF DIFFERENT APPARENT SPECIFIC GRAVITY, A_s , BASED ON EQUATION (41) $P_v = A_s P_w$

P_w Per Cent Moisture on Dry-Weight Basis	Apparent Specific Gravity (A_s)							
	1.1	1.2	1.3	1.4	1.5	1.6	1.7	1.8
1.0	1.10	1.20	1.30	1.40	1.50	1.60	1.70	1.80
1.2	1.32	1.44	1.56	1.68	1.80	1.92	2.04	2.16
1.4	1.54	1.68	1.82	1.96	2.10	2.24	2.38	2.52
1.6	1.76	1.92	2.08	2.24	2.40	2.56	2.72	2.88
1.8	1.98	2.16	2.34	2.52	2.70	2.88	3.06	3.24
2.0	2.20	2.40	2.60	2.80	3.00	3.20	3.40	3.60
2.2	2.42	2.64	2.86	3.08	3.30	3.52	3.74	3.96
2.4	2.64	2.88	3.12	3.36	3.60	3.84	4.08	4.32
2.6	2.86	3.12	3.38	3.64	3.90	4.16	4.42	4.68
2.8	3.08	3.36	3.64	3.92	4.20	4.48	4.76	5.04
3.0	3.30	3.60	3.90	4.20	4.50	4.80	5.10	5.40
3.2	3.52	3.84	4.16	4.48	4.80	5.12	5.44	5.76
3.4	3.74	4.08	4.42	4.76	5.10	5.44	5.78	6.12
3.6	3.96	4.32	4.68	5.04	5.40	5.76	6.12	6.48
3.8	4.18	4.56	4.94	5.32	5.70	6.08	6.46	6.84
4.0	4.40	4.80	5.20	5.60	6.00	6.40	6.80	7.20
4.2	4.62	5.04	5.46	5.88	6.30	6.72	7.14	7.56
4.4	4.84	5.28	5.72	6.16	6.60	7.04	7.48	7.92
4.6	5.06	5.52	5.98	6.44	6.90	7.36	7.82	8.28
4.8	5.28	5.76	6.24	6.72	7.20	7.68	8.16	8.64
5.0	5.50	6.00	6.50	7.00	7.50	8.00	8.50	9.00
5.2	5.72	6.24	6.76	7.28	7.80	8.32	8.84	9.36
5.4	5.94	6.48	7.02	7.56	8.10	8.64	9.18	9.72
5.6	6.16	6.72	7.28	7.84	8.40	8.96	9.52	10.08
5.8	6.38	6.96	7.54	8.12	8.70	9.28	9.86	10.44
6.0	6.60	7.20	7.80	8.40	9.00	9.60	10.20	10.80
6.2	6.82	7.44	8.06	8.68	9.30	9.92	10.54	11.16
6.4	7.04	7.68	8.32	8.96	9.60	10.24	10.88	11.52
6.6	7.26	7.92	8.58	9.24	9.90	10.56	11.22	11.88
6.8	7.48	8.16	8.84	9.52	10.20	10.88	11.56	12.24
7.0	7.70	8.40	9.10	9.80	10.50	11.20	11.90	12.60
7.2	7.92	8.64	9.36	10.08	10.80	11.52	12.24	12.96
7.4	8.14	8.88	9.62	10.36	11.10	11.84	12.58	13.32
7.6	8.36	9.12	9.88	10.64	11.40	12.16	12.92	13.68
7.8	8.58	9.36	10.14	10.92	11.70	12.48	13.26	14.04
8.0	8.80	9.60	10.40	11.20	12.00	12.80	13.60	14.40
8.2	9.02	9.84	10.66	11.48	12.30	13.12	13.94	14.76
8.4	9.24	10.08	10.92	11.76	12.60	13.44	14.28	15.12
8.6	9.46	10.32	11.18	12.04	12.90	13.76	14.62	15.48
8.8	9.68	10.56	11.44	12.32	13.20	14.08	14.96	15.84
9.0	9.90	10.80	11.70	12.60	13.50	14.40	15.30	16.20
9.2	10.12	11.04	11.96	12.88	13.80	14.72	15.64	16.56
9.4	10.34	11.28	12.22	13.16	14.10	15.04	15.98	16.92
9.6	10.56	11.52	12.48	13.44	14.40	15.36	16.32	17.28
9.8	10.78	11.76	12.74	13.72	14.70	15.68	16.66	17.64

128. Capillary Moisture Capacity. — The amount of water that a well-drained soil retains against the force of gravity at any specified time after flooding is called the field capillary moisture capacity. It is influenced largely by the texture, structure, and organic content of the soil. Recent investigations have shown that the capillary capacity *at equilibrium* is also influenced by the position of the water table. In field soils it is doubtful if equilibrium conditions ever exist between unbalanced capillary forces and the force of gravity.

There are so many variable factors, notably evaporation and absorption of water by the growing plants, that probably the moisture in irrigated soil during the growing season is always moving. However, the rates at which soil moisture moves vary widely according to the moisture content of the soil. Although the dynamic properties of soil moisture make a precise determination of field capillary moisture capacity very difficult, it is feasible to *approximate* field capillary water capacity by soil moisture determinations. Methods and procedure in making these determinations are given in Article 130, together with some typical results.

The term “specific retention” of a soil for water is also used to designate capillary field capacity. This term was proposed by Meinzer and defined as “the ratio of (1) the volume of water which, after being saturated, it (a rock or soil) will retain against the pull of gravity to (2) its own volume.” The “specific retention” may be recorded either as a percentage by volume (P_v) or a percentage by weight (P_w). It is evident from equation (41) that the specific retention on the dry-weight basis multiplied by the apparent specific gravity equals the specific retention on the volume basis.

signify the mass of soil.

$$\rho_w = \frac{M_w}{L^3} \qquad \rho_s = \frac{M_s}{L^3} \qquad P_w = \frac{M_w}{M_s}$$

dividing ρ_w by P_w , there results

$$\frac{\rho_w}{P_w} = \frac{M_w}{L^3} \times \frac{M_s}{M_w} = \frac{M_s}{L^3} = \rho_s$$

from which

$$\rho_w = P_w \rho_s \dots \dots \dots (41a)$$

The quantity P_w is of zero dimensions, being the ratio of mass to mass (and also of weight to weight as used in equation (41)), and further:

$$\rho_w = P_v \text{ of equation (41), numerically,}$$

and

$$\rho_s = A_s \text{ of equation (41) numerically, c.g.s. units.}$$

Therefore equation (41), in which each factor of zero dimensions is arrived at by illustration, is supported by the analysis above, showing that moisture density equals soil density times the moisture percentage *dry-mass* basis (and also *dry-weight* basis).

129. Basis of Soil-Moisture Storage.— Provided the capillary moisture capacity of a soil is known, it is necessary only to determine the moisture content of the soil before irrigation to approximate by difference the percentage that may be stored.

Let P'_w = the average moisture per cent on the dry-weight basis that can be stored, i.e., the per cent capillary capacity minus the moisture per cent before irrigation.

W = the dry weight in pounds of the soil to be moistened.

w = the weight in pounds of water necessary to moisten the soil.

Then
$$\frac{P'_w}{100} W = w$$

The amount of water applied in a single irrigation is usually expressed in acre-inches or acre-feet per acre, or in the equivalent unit of surface inches or surface feet. Thus if 6 acre-inches were spread uniformly over 1 acre the depth of irrigation would be 6 inches, or 0.5 foot. In practice, however, if $\frac{1}{2}$ acre-foot of water is used to irrigate an acre the result is considered a $\frac{1}{2}$ -foot irrigation, regardless of lack of uniformity in distribution of the water over the surface.

Let A = area of land irrigated in square feet.

A_s = the apparent specific gravity of the soil, i.e., the ratio of the weights of 1 cubic foot of dry soil to 62.4, which is the weight of a cubic foot of water.

d = the depth of water to be applied in feet.

D = depth in feet of the soil to be moistened.

Then the weight of soil to be moistened is

$$W = 62.4 A_s A D \text{ pounds}$$

and the weight of water necessary to add is

$$w = 62.4 d A \text{ pounds}$$

substituting for W and w these values in the above equation, there results

$$62.4 \frac{P'_w}{100} A_s A D = 62.4 d A,$$

from which

$$d = \frac{P'_w}{100} A_s D \dots \dots \dots (42)$$

In the application of equation (42), d may be computed in inches if D is also in inches. For example, assume that it is desired to add an aver-

TABLE XVII

DEPTH OF IRRIGATION WATER IN INCHES REQUIRED TO ADD VARIOUS MOISTURE PER CENTS TO ONE FOOT OF SOIL FOR SOILS HAVING DIFFERENT APPARENT

SPECIFIC GRAVITIES. BASED ON EQUATION (42) $d = \frac{P'_w A_s D}{100}$

Moisture Per Cents P'_w	Apparent Specific Gravity (A_s)							
	1.2	1.3	1.4	1.5	1.6	1.7	1.8	1.9
1.0	0.14	0.16	0.17	0.18	0.19	0.20	0.22	0.23
1.2	.17	.19	.21	.22	.23	.24	.26	.27
1.4	.20	.22	.24	.25	.27	.29	.30	.32
1.6	.23	.25	.27	.29	.31	.33	.35	.36
1.8	.26	.28	.30	.32	.34	.37	.39	.41
2.0	.29	.31	.34	.36	.38	.41	.43	.46
2.2	.32	.34	.37	.40	.42	.45	.47	.50
2.4	.34	.37	.40	.43	.46	.49	.52	.54
2.6	.37	.41	.44	.47	.50	.53	.56	.59
2.8	.40	.44	.47	.50	.54	.57	.60	.64
3.0	.43	.47	.50	.54	.58	.61	.65	.68
3.2	.46	.50	.54	.58	.61	.65	.69	.73
3.4	.49	.53	.57	.61	.65	.69	.73	.77
3.6	.52	.56	.60	.65	.69	.73	.78	.82
3.8	.55	.59	.64	.68	.73	.77	.82	.87
4.0	.58	.62	.67	.72	.77	.82	.86	.91
4.2	.60	.65	.71	.76	.81	.86	.91	.96
4.4	.63	.68	.74	.79	.84	.90	.95	1.01
4.6	.66	.72	.77	.82	.88	.94	.99	1.05
4.8	.69	.75	.81	.86	.92	.98	1.04	1.09
5.0	.72	.78	.84	.90	.96	1.02	1.08	1.14
5.2	.75	.81	.87	.94	1.00	1.06	1.12	1.19
5.4	.78	.84	.91	.97	1.04	1.10	1.16	1.23
5.6	.81	.87	.94	1.01	1.08	1.14	1.21	1.28
5.8	.83	.90	.97	1.04	1.11	1.18	1.25	1.32
6.0	.86	.93	1.01	1.08	1.15	1.22	1.30	1.37
6.2	.89	.97	1.04	1.12	1.19	1.26	1.34	1.41
6.4	.92	1.00	1.08	1.15	1.23	1.31	1.38	1.46
6.6	.95	1.03	1.11	1.19	1.27	1.35	1.43	1.50
6.8	.98	1.06	1.14	1.22	1.31	1.39	1.47	1.55
7.0	1.01	1.09	1.18	1.26	1.34	1.43	1.51	1.60
7.2	1.04	1.12	1.21	1.30	1.38	1.47	1.56	1.64
7.4	1.07	1.15	1.24	1.33	1.42	1.51	1.60	1.69
7.6	1.09	1.19	1.28	1.37	1.46	1.55	1.64	1.73
7.8	1.12	1.22	1.31	1.40	1.50	1.59	1.68	1.78
8.0	1.15	1.25	1.34	1.44	1.54	1.63	1.73	1.82
8.2	1.18	1.28	1.38	1.48	1.57	1.67	1.77	1.87
8.4	1.21	1.31	1.41	1.51	1.61	1.71	1.81	1.92
8.6	1.24	1.34	1.44	1.55	1.65	1.75	1.86	1.96
8.8	1.27	1.37	1.48	1.58	1.69	1.79	1.90	2.01
9.0	1.30	1.40	1.51	1.62	1.73	1.84	1.94	2.05
9.2	1.32	1.44	1.55	1.66	1.77	1.88	1.99	2.10
9.4	1.35	1.47	1.58	1.69	1.81	1.92	2.03	2.14
9.6	1.38	1.50	1.61	1.73	1.84	1.96	2.07	2.19
9.8	1.41	1.53	1.65	1.76	1.88	2.00	2.12	2.23

age of 5 per cent moisture to the upper 4 feet of an alfalfa tract in which the soil has an average apparent specific gravity of 1.4. Then

$$d = \frac{5}{100} \times 1.4 \times 4 = 0.28 \text{ foot} = 3.36 \text{ inches}$$

Similar problems may be solved with sufficient accuracy for practical purposes by the use of Table XVII.

130. Determinations of Field Capillary Moisture Capacity. — In attempting to measure the capillary moisture capacity of soils in the field, it is essential to give very careful attention to the following conditions:

- (a) Assure complete capillary saturation by adding an excessive amount of irrigation water.
- (b) Reduce to a minimum the surface evaporation losses immediately after irrigation.
- (c) Eliminate transpiration losses by working on non-cropped plots.
- (d) Observe carefully the *time* rates of decrease in moisture content by making moisture determinations at different times after irrigation.
- (e) Select for the study of capillary capacity a plot under which the water table is at great depth. A shallow water table may appreciably increase the capillary capacity at equilibrium.

It may be assumed that excessive percolation of water vertically downward from a plot completely flooded will assure capillary saturation of the surface soil. Average soils have a pore space of about 50 per cent. If therefore it is desired to assure complete capillary saturation of the upper 6 feet of loam soil, the necessary depth of water to apply may be computed as follows: The total voids if the soil were completely dry at the beginning would be $50/100 \times 6 = 3$ feet. Moisture determinations before flooding show an average of 2 inches of water per foot depth of soil. The remaining pore space is 4 inches per foot of soil, or 24 inches for the 6 feet. An irrigation of 24 inches would then completely fill the pore space if percolation were prevented at the 6-foot depth. This amount would seem ample to assure capillary saturation.

The surface evaporation losses immediately after flooding may be reduced to a minimum by the use of a deep straw mulch. Experiments conducted on a deep loam soil at Logan, Utah, showed that a 12-inch depth of straw mulch reduced the surface evaporation to a negligible amount.

The selection of a particular time after flooding as representing the capillary moisture capacity is very difficult. The rate of downward movement of moisture after flooding decreases from day to day, and yet it may continue for many days. In reality, the capillary capacity is the amount of moisture held after movement of moisture has ceased.

The very slow attainment of equilibrium conditions therefore necessitates in practice an arbitrary selection of a time at which approximate capillary capacity occurs. In coarse-textured sandy soil motion of water will discontinue much more quickly than in the fine-textured clay soils. The time that the observer may select after flooding may therefore vary from one to many days. If the time selected is too short and equilibrium conditions have not been attained, the observed capillary capacity will be greater than the true capillary capacity, provided evaporation and transpiration losses have been prevented. On the other hand, if the after-irrigation moisture content of crop-producing soils that have been heavily irrigated is considered as representing approximately the capillary capacity, it is probable that the rapid evaporation and transpiration losses in a few days following irrigation may reduce the moisture content to an amount less than the true capillary capacity.

The analysis of Article 120 and the distribution of water 68 days after irrigation as presented in Fig. 87 substantiate the statement that, at equilibrium, the capillary capacity of the upper few feet of soil is relatively high when the water table is high and low when the water table is low. The precise relation between the equilibrium capillary capacity and the height of the soil above the water table, numerically equal to the capillary potential, is yet to be experimentally established for different soils. In the meantime, the general statement that the equilibrium capillary capacity decreases as the distance above the water table increases seems to be warranted. Also, it appears, as indicated in Fig. 93, that the rate of decrease is highest near the water table.

131. Water-Storage Measurements. — The state agricultural experiment stations of the western United States, together with the United States Department of Agriculture, have made many measurements of the storage of water in soils.

Some of these measurements have been made in connection with the study of economical irrigation of important crops. Others have been made on non-cropped soil with a view to finding the maximum quantity of water that may be stored in a field soil by increasing the moisture content, from the minimum ordinarily found in the field, to the field capacity. The method of procedure in making field moisture capacity determinations as outlined in Article 130 may also be followed to find the amount of water that may be stored in any field soil. After having found the percentages of moisture in the soil before, and also following, irrigation, the equivalent depths of water may be computed by use of equation (42) if the apparent specific gravity is known. The depth of water found in the form of soil moisture at any time from one to three

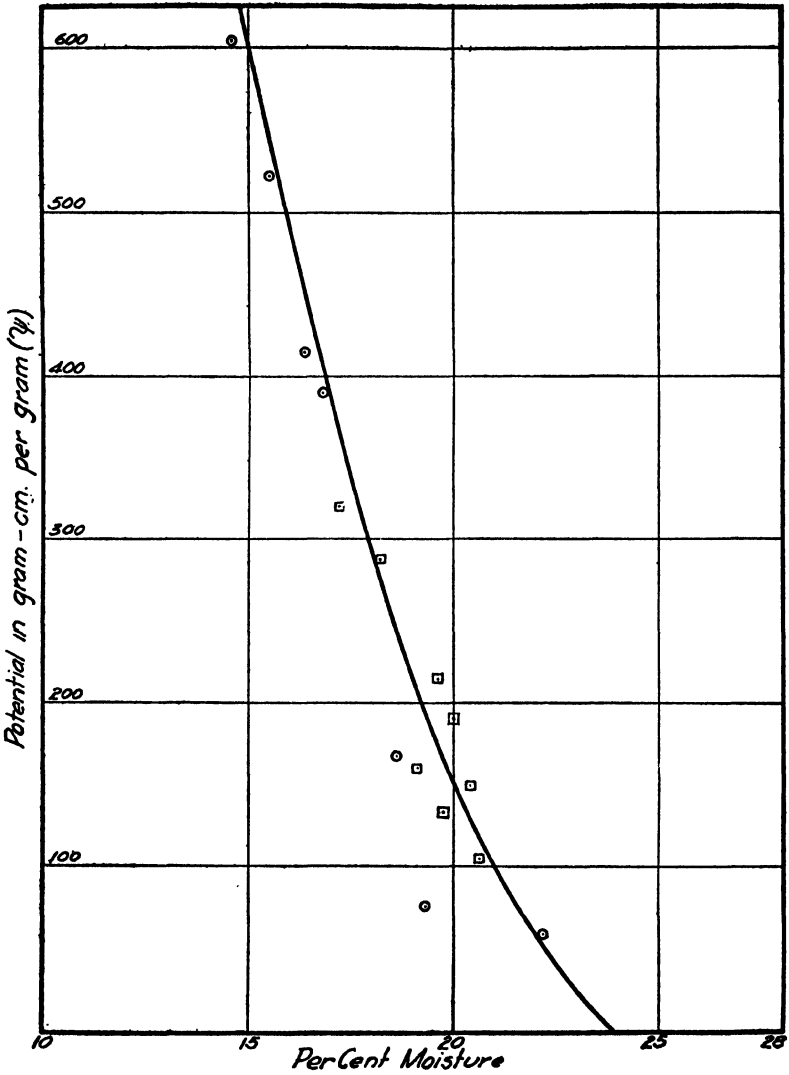

FIG. 93. — Typical laboratory measurements of the relation of capillary potential ψ to the per cent moisture. (Calif. Agr. Exp. Sta. Hilgardia Vol. 2 No. 14.)

days after irrigation, minus the depth before irrigation, gives approximately the depth that may be stored as capillary soil moisture.

In California, Utah, Oregon, and Washington, special attention has been given to a study of the storage of water in soils. The results of some of these studies are here briefly reported.

132. The California Studies. — In connection with a study of the economical duty of water for alfalfa in Sacramento Valley, California, conducted by Adams and others, from 1910 to 1915, studies were made on capacities of soils for irrigation water. In these studies, moisture determinations were made immediately before irrigation and from one to four days after irrigation. All the plots on which the moisture tests were made were producing alfalfa. The studies do not represent precise measurements of maximum field capillary capacity — rather they show the average amounts of water stored by irrigation in soils of different texture at various time periods after irrigation.

In order to interpret these and similar determinations of soil moisture in terms of depths of water applied and retained, it is necessary, as shown in Article 129, to know the apparent specific gravity of the soil, A_s . A special method of determining the apparent specific gravity of the soils in the natural field condition was devised and used on each of the farms on which the investigations were conducted. The average values of A_s for each class of soil are given in Table XVIII, which contains a summary of the average depths of water applied to each soil

TABLE XVIII

SACRAMENTO VALLEY STUDIES SHOWING FOR FOUR CLASSES OF SOIL THE NUMBER OF IRRIGATIONS; AND THE AVERAGE DEPTH OF WATER APPLIED AND RETAINED IN THE UPPER 6 FEET OF SOIL

1	2	3	4	5	6	7	8	9	10
Classes of Soil	Number of Borings	Apparent Sp. Gr. (A_s)	Average Number of Irrigations	Depth Applied, Inches	Depth Retained, Inches	Depth Retained Plus Evaporation, Inches	Per Cent Retained	Per Cent Retained Plus Evaporation	Farms in the Group
Silt loams with sandy loam subsoils.....	62	1.15	3.0	15.02	5.52	6.60	36.8	43.9	2
Silt loams.....	87	1.31	3.3	12.81	4.24	5.32	33.1	41.5	3
Clay loams.....	148	1.35	4.0	8.78	3.50	4.56	39.8	52.0	5
Clays.....	43	1.69	4.0	4.72	2.20	3.28	46.8	69.4	2

and also the depths retained in the upper 6 feet a few days after irrigation. Because of the fact that alfalfa was growing on each of the farms, estimates were made of probable evaporation and transpiration losses between the time of irrigation and moisture tests following. These

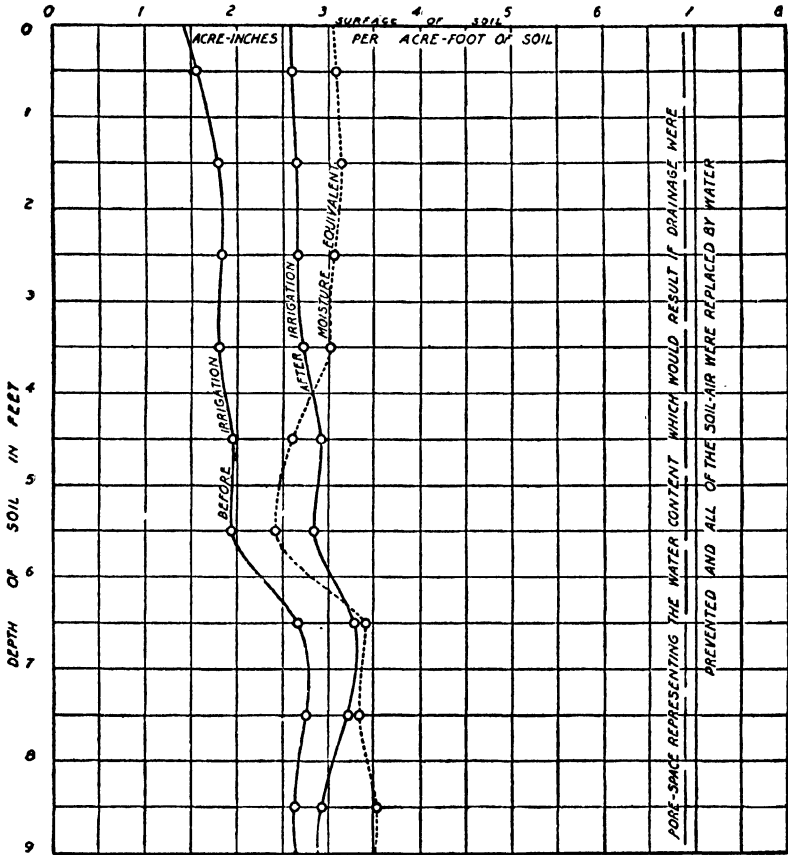

Fig. 94. — Graphs of the water content before and after irrigation, moisture equivalent, and pore space of silt-loam soils having fine sandy-loam subsoils. Each water-content curve is the average of 62 borings. (Figs. 94 to 98 are from U. S. Dept. Agr. Jour. Agr. Research Vol. XIII No. 1.)

estimated losses added to the amounts actually retained are also reported in Table XVIII.

The number of inches of water in each foot of soil both before and after irrigation are shown in Figs. 94 to 97 inclusive. In the coarser-textured soils, i.e., the fine sandy-loams and silt-loams, borings were

made to a depth of 9 feet, as shown in Figs. 94 and 95, whereas in the clay loams and clays, moisture tests were made only in the upper 6 feet of soil. Each figure contains also the moisture equivalent as determined

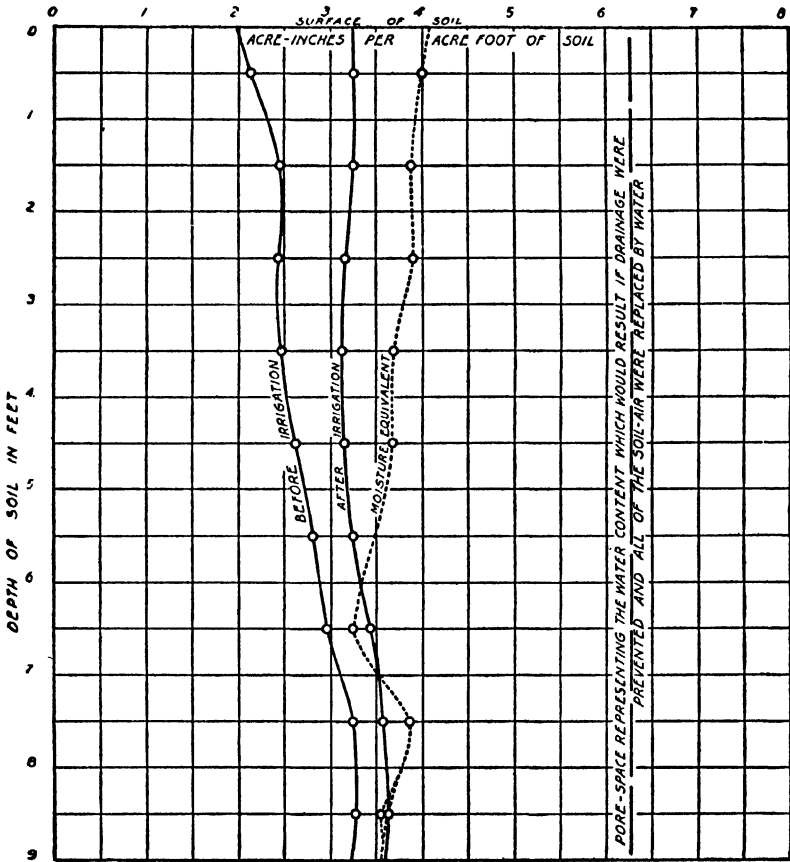

FIG. 95. — Graphs of the water content before and after irrigation, moisture equivalent, and pore space of silt-loam soils. Each water-content curve is the average of 87 borings.

by the Briggs-McLane method, and the pore space as computed from determinations of apparent and real specific gravity.

Comparisons of Figs. 94 to 97 show that the irrigation water penetrated below the 9-foot depth in the loams, below the 6-foot depth in the clay loams, and to a depth not to exceed 2 feet in the clays. The amount of air space in excess of the moisture content after irrigation is greatest

STORAGE OF WATER IN SOILS

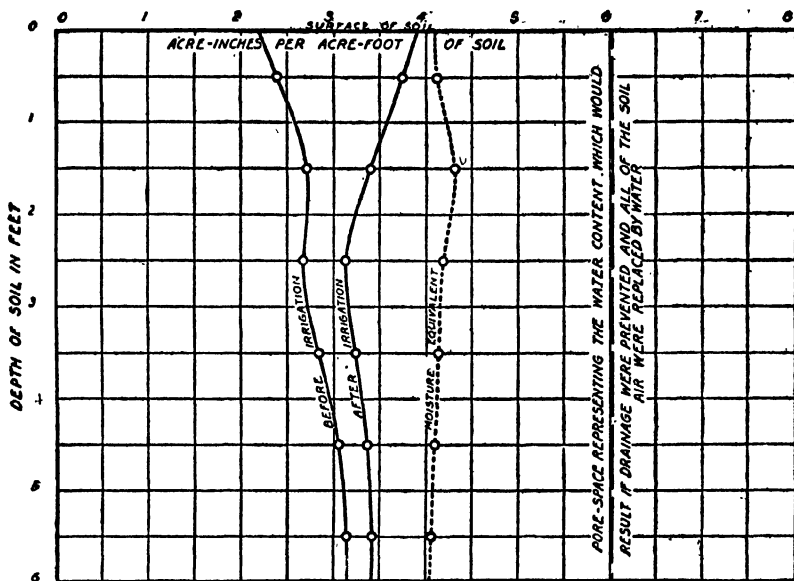

Fig. 96. — Graphs of the water content before and after irrigation, moisture equivalent, and pore space of clay-loam soils. Each water-content curve is the average of 148 borings.

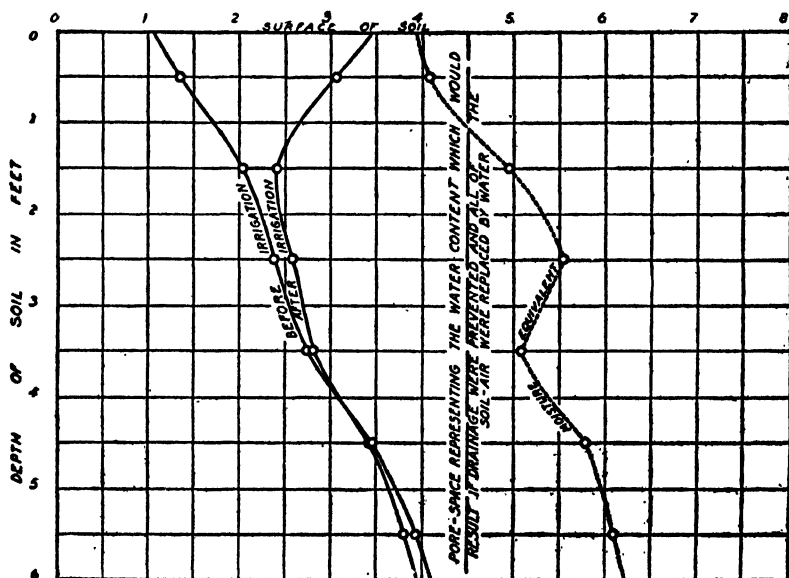

Fig. 97. — Graphs of the water content before and after irrigation, moisture equivalent, and pore space of clay soils. Each water-content curve is the average of 43 borings.

in the coarse-textured soils and smallest in the fine-textured ones. In the upper 6 feet the silt loams having fine sandy loam subsoils held an average of 2.73 inches of water per foot of soil; the silt loams 3.20 inches; the clay loams 3.49 inches. The clays were not fully moistened because of the inadequacy of penetration of the irrigation water.

The average moisture contents of each foot of soil for six experimental plots at the University Farm at Davis, California, before and after irrigation are given in Fig. 98. Each plot was irrigated differently, but the smallest depth of water applied was 6 inches in each irrigation. It appears from Fig. 98 that some water penetrated below the 12-foot depth. However, the data from 10 to 12 feet inclusive are based on only one year's studies and are therefore less precise than the data from the soil surface to 6 feet which are based on three years' work, and an average of 147 borings. The depths from 7 to 9 feet are based on two years' work. The marked increase in moisture content below the 5.5-foot depth was probably a result, in part at least, of the change in soil texture as shown by the moisture equivalent determination.

Veihmeyer and Hendrickson have recently reported a detailed study of the "moisture equivalent as a measure of the field capacity of soils," from which they conclude that the moisture equivalent is a close measure of the field capacity of fine-textured soils but not always of sandy soils. The experiments conducted by Veihmeyer and Hendrickson show that the moisture equivalent can be used to indicate the field capacity of deep, drained soils with no decided changes in texture or structure, with moisture equivalents ranging from about 30 per cent down to 12 or 14 per cent.

133. The Utah Studies. — In 1919 the Utah State Agricultural Experiment Station made a series of measurements of capillary water-holding capacity on the deep loam soils of the Greenville Experiment Farm. To remove all doubt concerning completeness of saturation and also to remove the influence of the growing crop, three rectangular basin plats were prepared to which excessive amounts of water were applied. Each plat was 38 feet long and 33 feet wide. Around these plats levees about 2 feet high were built with soil taken from outside the plats, thus the soil in the plats was left undisturbed. The plats were numbered *A*, *B*, and *C*. Samples of soil were taken to ascertain the moisture content before irrigation, after which plat *A* was given a 12-inch irrigation, plat *B* a 24-inch irrigation, and plat *C* a 36-inch irrigation.

The borings for moisture samples were made to a depth of 12 feet, and the moisture determinations were carried out in the laboratory by the usual methods, the results being recorded in per cents of the weights of the dry soil.

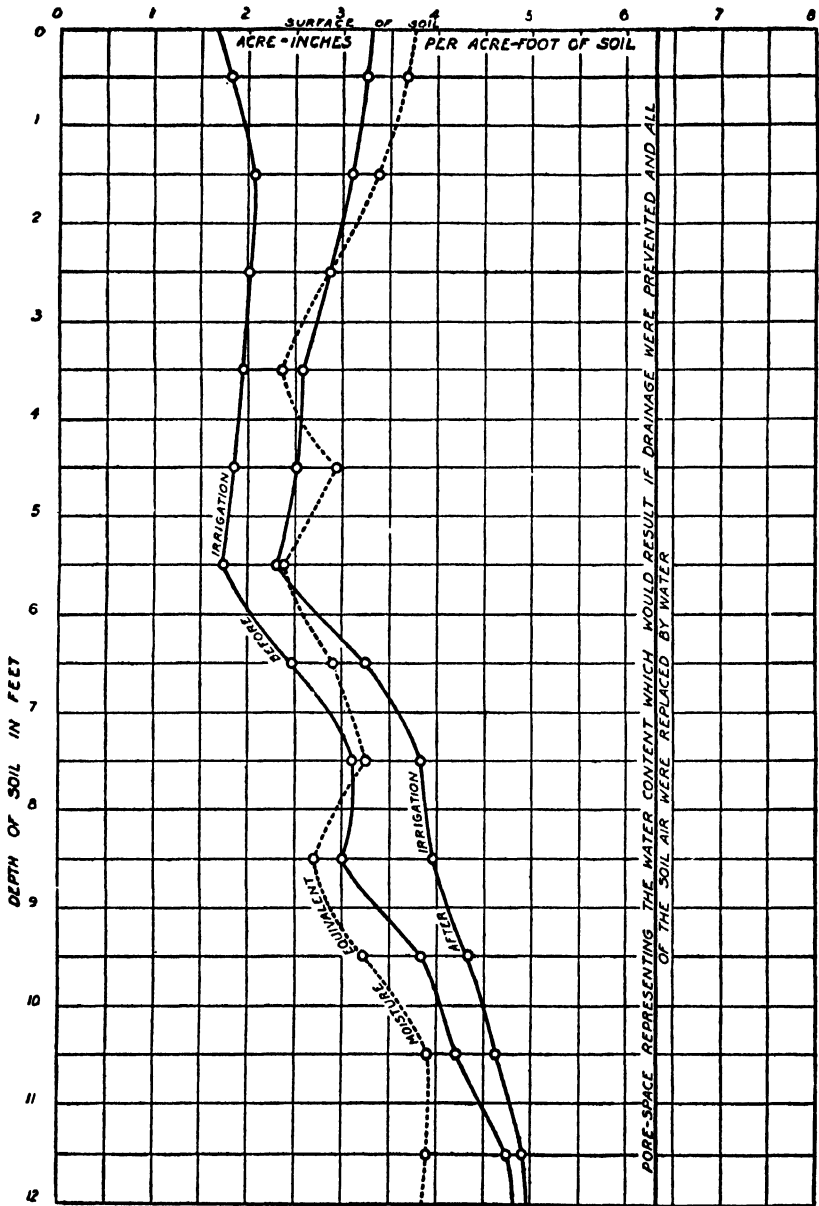

FIG. 98. — Graphs of the water content before and after irrigation, moisture equivalent, and pore space of yolo loam soils. Each water-content curve is the average of 6 plots for 1913, 1914, and 1915, and the average of 147 borings.

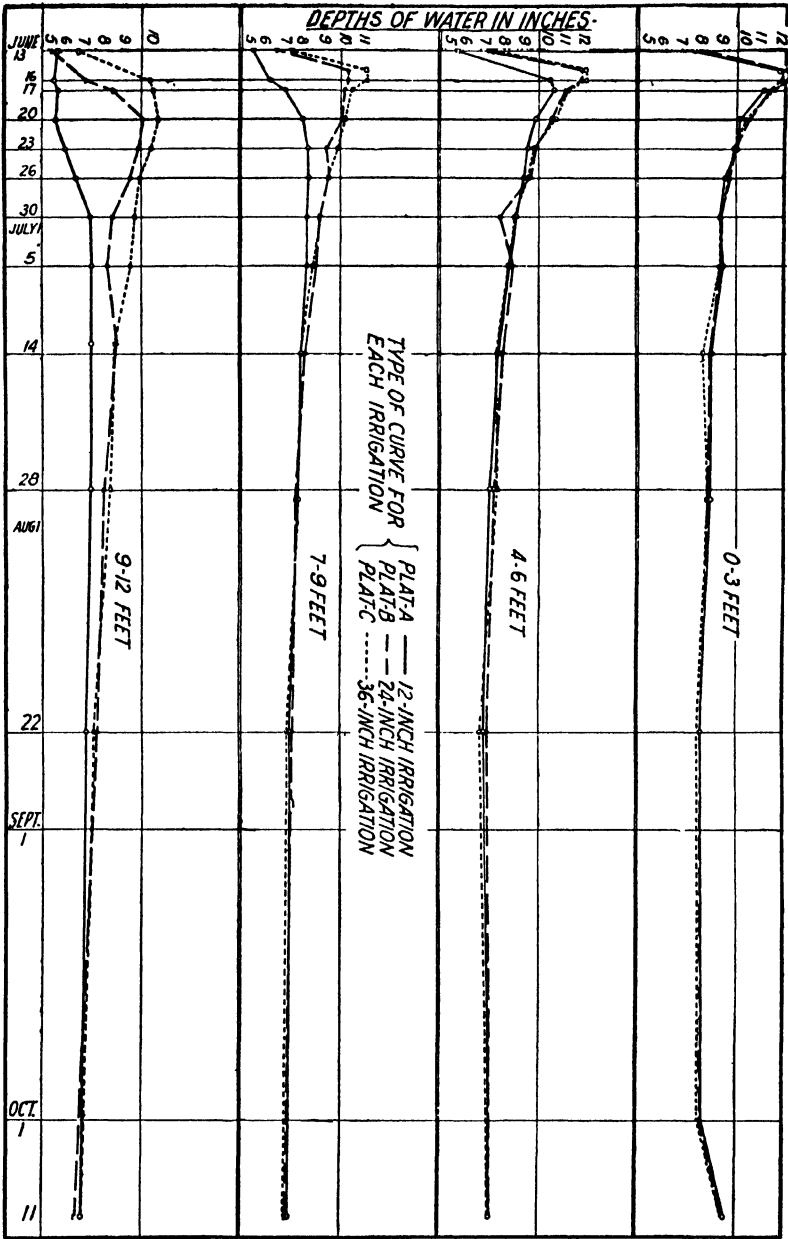

FIG. 99. — Curves comparing the time rate of change in the amounts of water contained in the same depths of soil after each of three different irrigations. Results are expressed in inches depth of water in each of the four depths of soil considered. (Figs. 99 to 102 are from Calif. Agr. Exp. Sta. Hilgardia Vol. II No. 14.)

The soil is a deep uniform loam having a water table 50 feet or more below the surface. Moisture determinations at 12 different time periods showing the decrease in capillary water after irrigation in each of the three plats, *A*, *B*, and *C*, are presented graphically in Fig. 99, in which the moisture content is plotted against time.* The data are reported in acre-inches of water per acre, for different depths of soil. Observations were made at irregular intervals from June 16 to October 11, 1919, there being 2556 determinations, of which 1476 were made in June, 468 in July, and 216 in August and September. The location of borings was systematically made, and stakes were placed in each hole as soon as the sample had been obtained and the excess disturbed soil had been replaced. On each stake the date of sampling was marked, thus avoiding duplication in the location of borings.

On June 16, immediately after the irrigation water disappeared from the surface of the soil, a heavy straw mulch from 8 to 10 inches deep was spread over the surface of each plat. To determine the loss of water through the straw, an evaporimeter pan 12 inches by 20 inches was filled with soil of about the same moisture content as that in the plat and was placed under the straw in plat *A* with its surface flush with the ground surface. From August 2 to 26 the pan lost 1294 grams of water, which is equal to 0.383 cm. depth, or 0.035 cm. a day. Measurement of the decrease in moisture content of the upper 6 feet of soil from June 16 to August 22, after deducting the water evaporated, shows a loss from plats *A*, *B*, and *C* of 0.58, 0.64, and 0.71 cm. respectively, in 24 hours. It is therefore apparent that the evaporation losses are relatively negligible, and that the major decrease in moisture content of the soil depths, 0 to 3 feet, and 4 to 6 feet, from day to day after irrigation was caused by a downward flow of capillary water. Fig. 99 shows that a perceptible decrease continued for about 15 days in the upper 6 feet of soil in all the plats, and that in plats *B* and *C* the decrease continued during the same time in the depths 7 to 9 feet. From the 10- to 12-foot depth in plats *B* and *C* the moisture increased for several days after irrigation and then decreased slowly. In the 10- to 12-foot depth of plat *A*, which was given a 12-inch irrigation, the moisture content continued to increase for nearly 20 days after irrigation. During the remaining 50 days of observation the change was not large enough to be significant. Data from the same experiments showing the distribution of the moisture at various depths of soil in each plot at different lengths of time after irrigation are presented in Figs. 100, 101, and 102. Fig. 100 shows that the 12-inch irrigation fully moistened the soil only to the $4\frac{1}{2}$ -foot depth 2 days after

* Fig. 99 is taken from *Hilgardia*, a journal of agricultural science in which some of the results of the Utah studies were published.

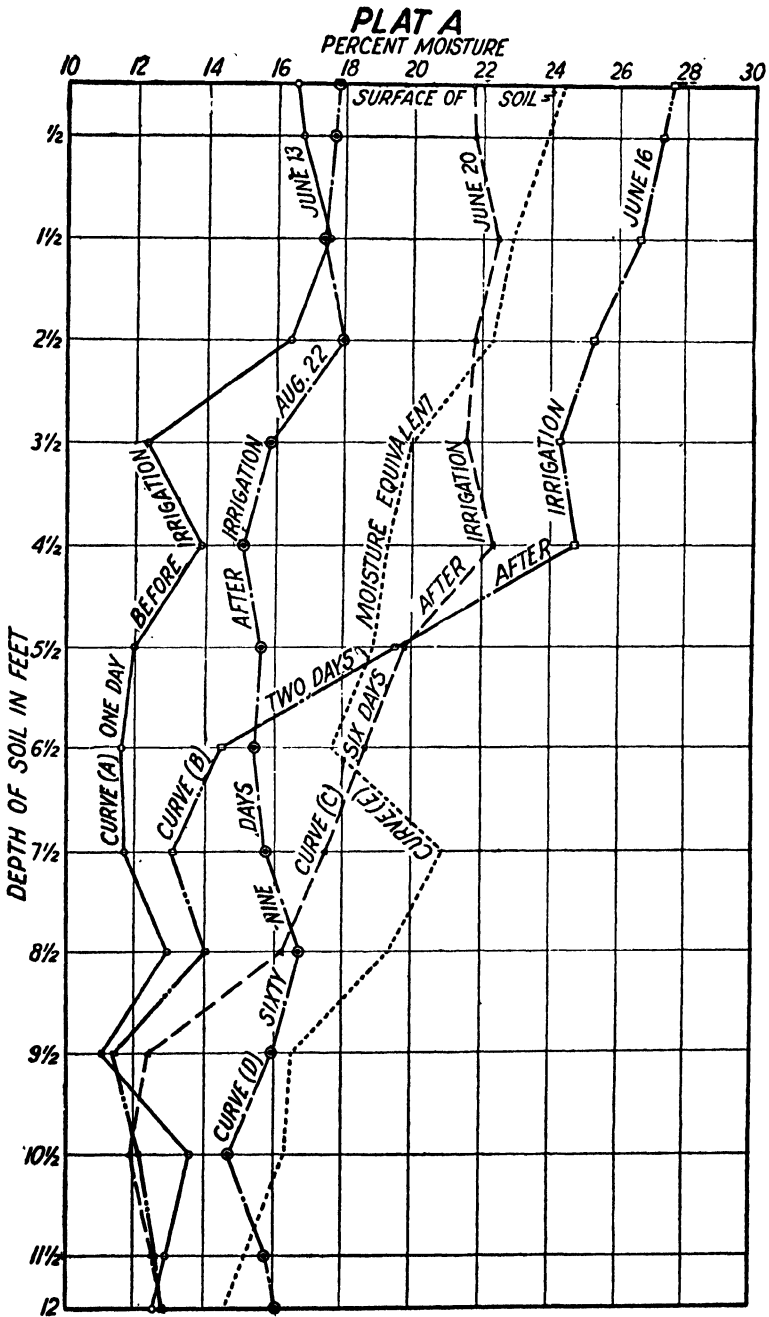

FIG. 100. — Distribution of moisture in soil at different periods after a 12-inch irrigation.

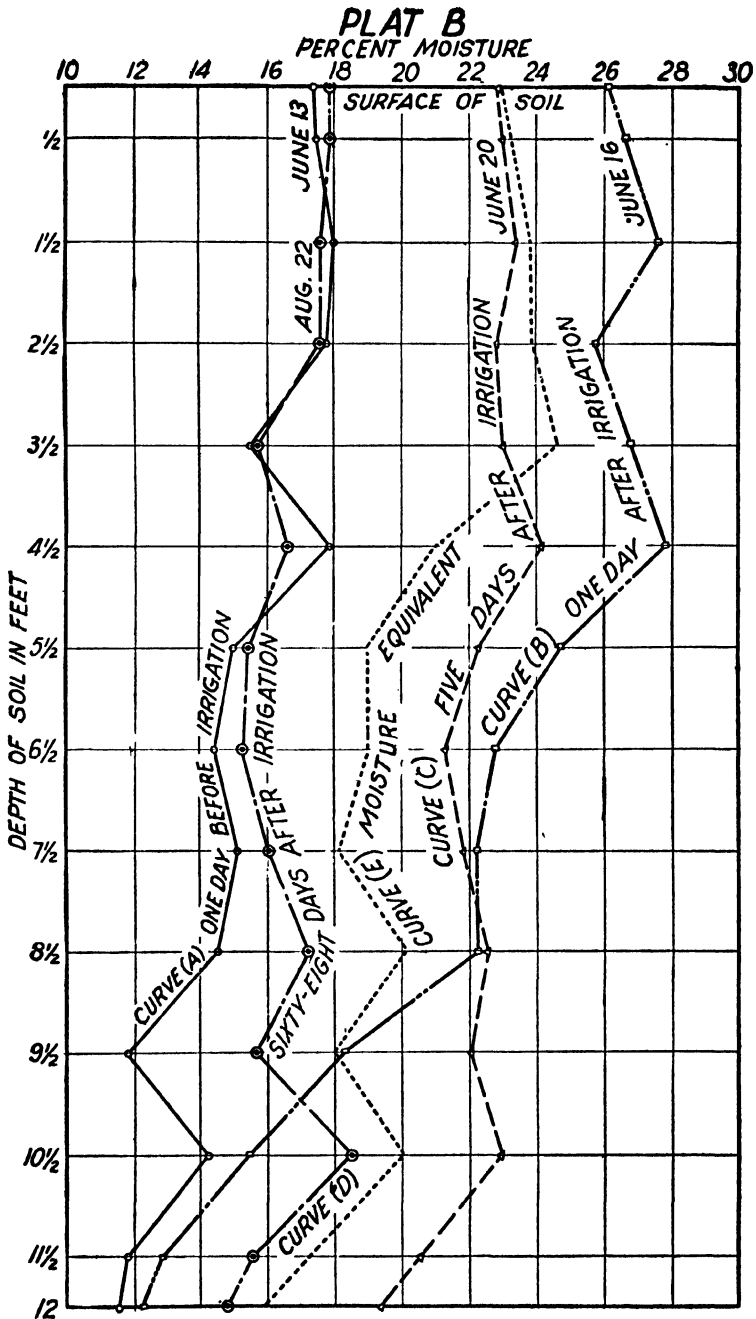

FIG. 101. — Distribution of moisture in soil at different periods after a 24-inch irrigation.

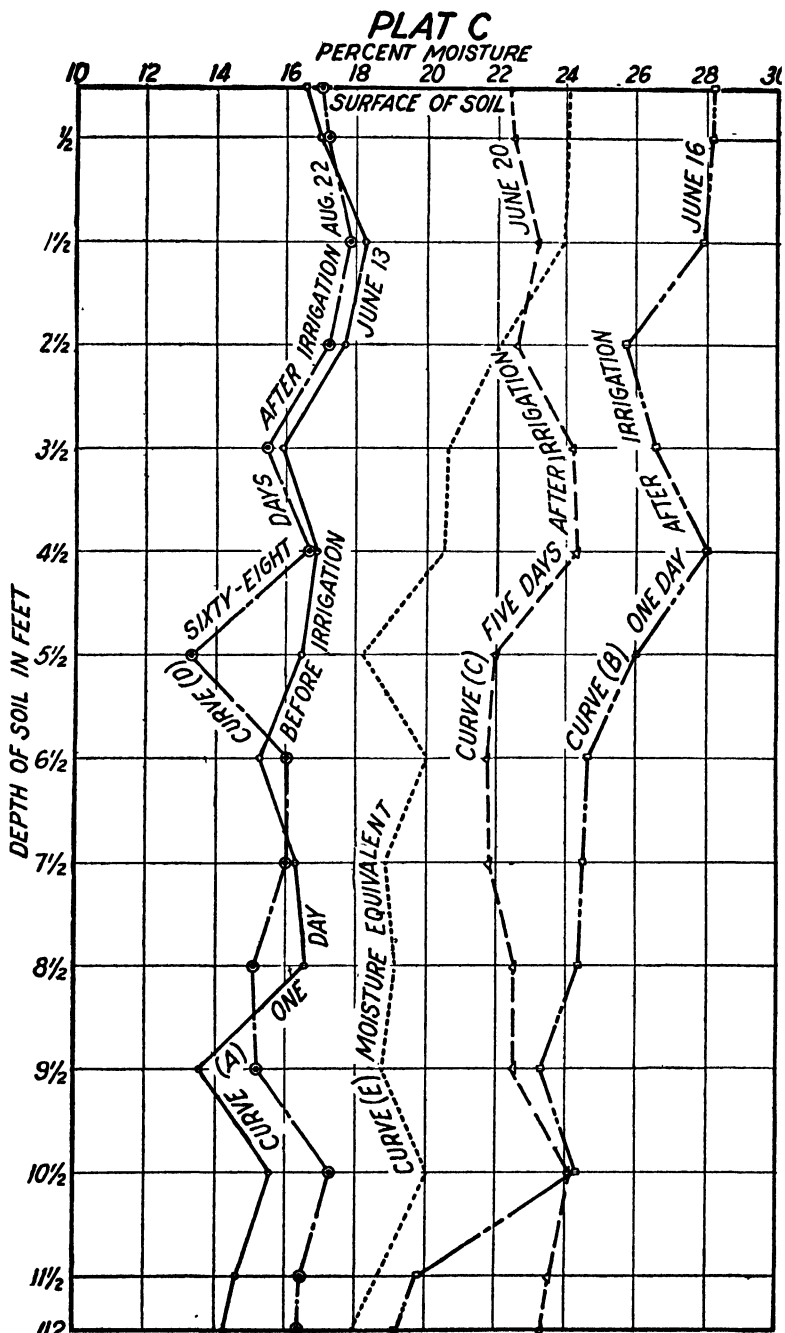

FIG. 102. — Distribution of moisture in soil at different periods after a 36-inch irrigation.

irrigation, whereas Fig. 101 shows that the 24-inch irrigation fully moistened the soil to a depth of $8\frac{1}{2}$ feet, and Fig. 102 shows that the 36-inch irrigation fully moistened the soil to a depth of $10\frac{1}{2}$ feet in 1 day after irrigation. The marked reductions of the moisture content in the upper few feet of soil of all the plats during the 4 days following the first moisture determinations is noteworthy. Likewise, it is significant that in the 67 days following the first observation the moisture content of the upper soil was reduced to approximately that before irrigation, even though the evaporation was largely prevented.

134. The Washington Studies. — The water-holding capacity of the higher bench soils of the Yakima Valley, Washington, were investigated by Scofield and Wright during the years 1924 to 1926. The depth of water in each foot of soil to a depth of 4 feet at the wilting point of alfalfa, and at 3 different periods after flooding, are reported in Fig. 103. The soil studied is classed as a sandy loam, the moisture equivalent of which is approximately 16 per cent, or 2.65 inches of water per foot of soil. For conversions of the moisture percentages to inches of water per foot of soil, the apparent specific gravity of the soil was assumed to be 1.38. It is noteworthy that the capillary capacities reported for the several depths of the Yakima Valley soils *assume* a condition of substantial equilibrium 24 hours after irrigation. However, the moisture tests at the later periods show that an appreciable amount of water moved downward into the third and fourth foot sections after the observations 1 day following irrigation. This fact would seem to support the conclusion above stated that the time period after flooding which represents the capillary field capacity is difficult of determination and really must be arbitrarily selected in measuring the capacities of soils for irrigation water.

135. Filling the Capillary Reservoir. — In Article 79 it is shown that

$$da = qt \dots \dots \dots (32)$$

By interpreting the depth, d , of equation (32) as the depth of water necessary to spread uniformly over the land surface in order to fill the capillary reservoir, or satisfy the capillary capacity, of the soil to a given depth of soil in inches, then the d of equation (42) is equivalent to the d of equation (32). It therefore follows, by comparison of the two equations (42) and (32), that

$$\frac{qt}{a} = \frac{P'_w A_s D}{100}$$

from which it is apparent that

$$t = \frac{P'_w A_s D a}{100q} \dots \dots \dots (43)$$

Provided the apparent specific gravity A_s , is known, it is possible to compute by use of equation (43) the hours required to add a given

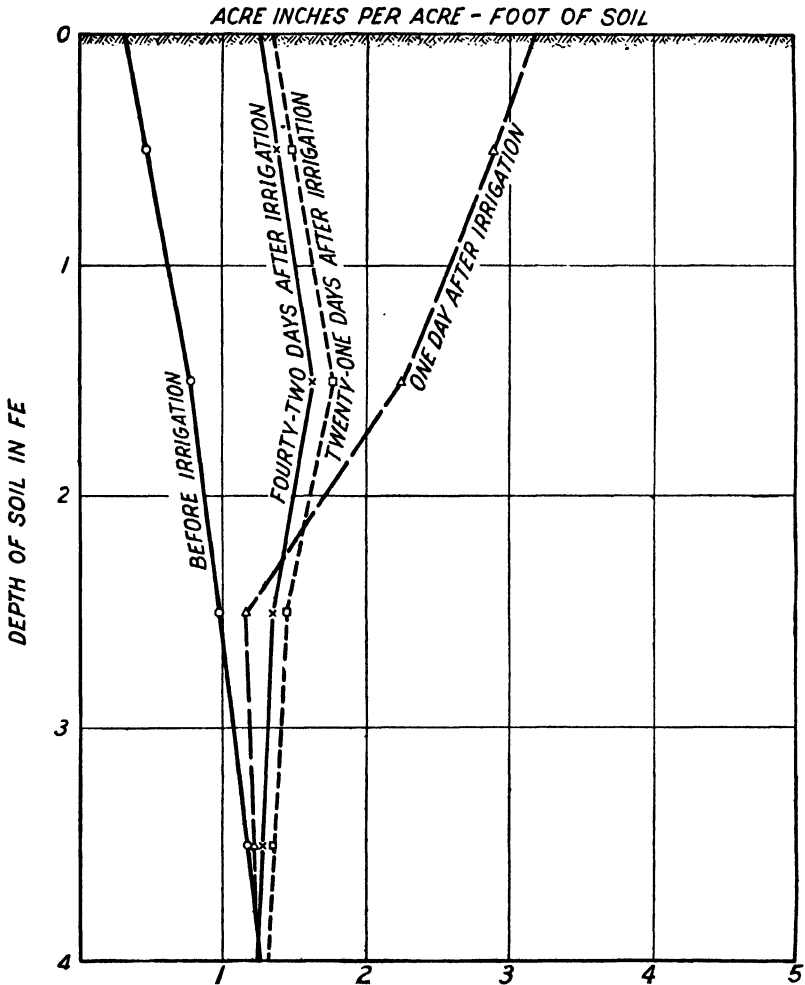

FIG. 103. — Distribution of moisture in soil before irrigation and at different periods after irrigation, Yakima, Wash. (Based on studies by Scofield and Wright, Jour. of Agr. Research Vol. XXXVII No. 2.)

moisture percentage, P'_w , to a field of given area, a , and a soil of certain depth, D , when using a stream of water of q c.f.s. (acre-inches per hour).

The student should keep in mind the fact that equation (43) is based on reasoning and is not a result of experiment. It may, for example, be limited in its application to values of P'_w , which represent complete capillary saturation of the soil minus the moisture content before irrigation. Veihmeyer and associates have found, working with some California soils, that it is impracticable to add to great depths of soil small percentages of water in the capillary form, since the full capillary capacity for water of the surface soil must be satisfied before the water moves to lower depths. Likewise, it is very difficult to spread water uniformly over the land.

Keeping these limitations in mind, however, equation (43) does have practical utility particularly because of the large amount of information available as to the maximum P'_w that soils will retain from a single irrigation. To simplify the use of equation (43), Table XIX has been prepared. It applies directly only to soils having an apparent specific gravity of $A_s = 1.4$. For soils having higher or lower values of A_s , proportional corrections must be made. Use of Table XIX is illustrated by the following example: An irrigator has at his disposal a stream of 3 c.f.s. and he desires to add 5 per cent moisture to the upper 4 feet of soil. How many hours will be required provided the water is spread uniformly and losses are neglected? Column 6 of Table XIX shows that 0.28 hour is required to supply enough water with a 3-c.f.s. stream to add 5 per cent moisture to 1 acre-foot of soil. Therefore, in 1.12 hours, enough water is applied to add 5 per cent moisture to 4 acre-feet of soil, and longer application is likely to result in deep percolation loss provided the 5 per cent satisfies the field capillary capacity or fills the capillary reservoir.

TABLE XIX

TIME IN HOURS, t , REQUIRED WITH A STREAM, q , TO ADD VARIOUS PER CENTS OF MOISTURE, P'_w , TO ONE ACRE-FOOT OF SOIL, THE APPARENT SPECIFIC GRAVITY OF WHICH IS 1.4 BASED ON EQUATION (43) $t = \frac{P'_w A_s D_a}{100 q}$

Col. No.	1	2	3	4	5	6	7	8	9	10	
Line No.	Moisture, Per Cents, P'_w	Size of Stream, q , c.f.s.									
		0.5	1.0	1.5	2.0	2.5	3.0	3.5	4.0	4.5	5.0
1	1.0	0.34	0.17	0.11	0.08	0.07	0.06	0.05	0.04	0.04	0.03
2	1.2	.40	.20	.13	.10	.08	.07	.06	.05	.04	.04
3	1.4	.47	.24	.16	.12	.09	.08	.07	.06	.05	.05
4	1.6	.54	.27	.18	.13	.11	.09	.08	.07	.06	.05
5	1.8	.60	.30	.20	.15	.12	.10	.09	.08	.07	.06
6	2.0	.67	.34	.22	.17	.13	.11	.10	.08	.07	.07
7	2.2	.74	.37	.25	.18	.15	.12	.11	.09	.08	.07
8	2.4	.81	.40	.27	.20	.16	.13	.12	.10	.09	.08
9	2.6	.87	.44	.29	.22	.17	.15	.12	.11	.10	.09
10	2.8	.94	.47	.31	.23	.19	.16	.13	.12	.10	.09
11	3.0	1.01	.50	.34	.25	.20	.17	.14	.13	.11	.10
12	3.2	1.08	.54	.36	.27	.21	.18	.15	.13	.12	.11
13	3.4	1.14	.57	.38	.29	.23	.19	.16	.14	.13	.11
14	3.6	1.21	.60	.40	.30	.24	.20	.17	.15	.13	.12
15	3.8	1.28	.64	.43	.32	.25	.21	.18	.16	.14	.13
16	4.0	1.34	.67	.45	.34	.27	.22	.19	.17	.15	.13
17	4.2	1.41	.71	.47	.35	.28	.24	.20	.18	.16	.14
18	4.4	1.48	.74	.49	.37	.29	.25	.21	.18	.16	.15
19	4.6	1.55	.77	.52	.39	.31	.26	.22	.19	.17	.15
20	4.8	1.61	.81	.54	.40	.32	.27	.23	.20	.18	.16
21	5.0	1.68	.84	.56	.42	.34	.28	.24	.21	.18	.17
22	5.2	1.75	.87	.58	.44	.35	.29	.25	.22	.19	.17
23	5.4	1.81	.90	.60	.45	.36	.30	.26	.23	.20	.18
24	5.6	1.88	.94	.63	.47	.37	.31	.27	.23	.21	.19
25	5.8	1.95	.97	.65	.49	.39	.32	.28	.24	.22	.19
26	6.0	2.02	1.01	.67	.50	.40	.34	.29	.25	.22	.20
27	6.2	2.08	1.04	.69	.52	.42	.35	.30	.26	.23	.21
28	6.4	2.15	1.08	.72	.54	.43	.36	.31	.27	.24	.22
29	6.6	2.22	1.11	.74	.55	.44	.37	.32	.28	.24	.22
30	6.8	2.29	1.15	.76	.57	.46	.38	.33	.29	.25	.23
31	7.0	2.35	1.17	.78	.59	.47	.39	.34	.29	.26	.23
32	7.2	2.42	1.21	.81	.60	.48	.40	.35	.30	.27	.24
33	7.4	2.49	1.25	.83	.62	.50	.41	.36	.31	.28	.25
34	7.6	2.56	1.28	.85	.64	.51	.42	.36	.32	.28	.26
35	7.8	2.62	1.31	.87	.65	.52	.44	.37	.33	.29	.26
36	8.0	2.69	1.35	.90	.67	.54	.45	.38	.34	.30	.27
37	8.2	2.75	1.38	.92	.69	.55	.46	.39	.34	.30	.27
38	8.4	2.82	1.42	.94	.71	.56	.47	.40	.35	.31	.28
39	8.6	2.89	1.45	.96	.72	.58	.48	.41	.36	.32	.29
40	8.8	2.96	1.48	.99	.74	.59	.49	.42	.37	.33	.30
41	9.0	3.02	1.51	1.01	.76	.60	.50	.43	.38	.33	.30
42	9.2	3.09	1.54	1.03	.77	.62	.52	.44	.38	.34	.31
43	9.4	3.16	1.58	1.05	.79	.63	.53	.45	.39	.35	.32
44	9.6	3.23	1.61	1.07	.81	.64	.54	.46	.40	.36	.32
45	9.8	3.30	1.65	1.10	.82	.66	.55	.47	.41	.36	.33

REFERENCES

- COSBY, STANLEY W. A General Purpose Soil Auger and its Use on the Farm, U. of Calif. Agr. Exp. Sta. Cir. 306. May, 1926.
- GARDNER, WILLARD. Capillary Moisture-holding Capacity, Soil Sci., **7**, No. 4 : 319-324. 1919.
- ISRAELSEN, O. W. Studies on Capacities of soils for Irrigation Water, and a New Method of Determining Volume Weight, Jour. Agr. Research, **13**, No. 1 : 1-35. 1918.
- ISRAELSEN, O. W., and WEST, FRANK L. Water-holding Capacity of Irrigated Soils, Utah Agr. Exp. Sta. Bul. 183 : 1-24, Figs. 1-7. 1922.
- ISRAELSEN, ORSON W. The Application of Hydrodynamics to Irrigation and Drainage Problems, *Hilgardia*, **2**, No. 14, Calif. Agr. Exp. Sta. 1927.
- MCLAUGHLIN, W. W. The Capillary Distribution of Moisture in Soil Columns of Small Cross Section, U. S. D. A. Bul. 1221 : 1-122, Figs. 1-7. 1924.
- SCOFIELD, CARL S., and WRIGHT, COULSEN C. The Water Relations of Yakima Valley Soil, Jour. Agr. Research, **37**, No. 2. 1928.
- TAYLOR, C. A., and BLANEY, HARRY F. An Efficient Soil Tube Jack, Soil Sci., **27**, No. 5. 1929.
- VEIHMEYER, F. J. An Improved Soil-Sampling Tube, Soil Sci., **27**, No. 2: 147-152. 1929.
- VEIHMEYER, F. J., and HENDRICKSON, A. H. The Moisture Equivalent as a Measure of The Field Capacity of Soils. Soil Sci., **32**, No. 3. 1931.

CHAPTER X

THE MOVEMENT OF WATER IN SOILS

In Chapter II it is shown that water flows in open canals in response to a component of the force of gravity per unit mass of water, and that in pipes it flows in response to gravity components and to pressure differences. In this chapter, the movement of soil water in only *one dimension* is considered. In *saturated* soils the driving forces are closely comparable to the driving forces which cause water flow in pipes; they result from the pull of gravity and from differences in hydrostatic pressure. The magnitude of these two types of driving forces in saturated soils, as in pipes, can be measured by well-established physical relations. For the measurement of the resultant driving force per unit mass which causes rectilinear movement of *capillary* water in *unsaturated* soils, physicists have used the reasoning and methods long since applied to the study of the flow of heat and of electricity. An understanding of their analyses and methods is most easily obtained in college courses in physics and in engineering, after proper preliminary mathematical preparation. However, a careful study of this chapter, it is hoped, will aid the student to obtain correct concepts concerning the rectilinear flow of water in both saturated and unsaturated soils.

In the study of the movement of water in soils, physicists have been primarily interested in capillary flow in unsaturated soils, and engineers have devoted attention especially to the flow of water in soils, sands, or rocks that are saturated. Physicists use the terms: "potentials," "potential gradients," "equipotential regions," "conductivity factors," etc., and engineers use the terms: "heads due to pressure," "heads due to position," "hydraulic grade lines — gradients — or slopes," "hydraulic permeabilities," etc. In order to read intelligently the available literature on the flow of water in soils, it is essential that the student obtain a clear understanding of the meaning of all these terms.

The importance of agricultural and engineering students early obtaining clear concepts concerning the principles that underlie the movement of water in soils arises from the fact that a satisfactory control of soil water flow is essential to economical irrigation and to the prevention of water-logging of valuable irrigated lands. In a study of these principles, the student will find it helpful to review those parts of Chapter II that deal with the conveyance of irrigation water.

136. Potentials. — Mechanical work as noted in Chapter II is defined as force times distance. To lift 1 pound of water against the force of gravity through a vertical distance of 10 feet requires 10 foot-pounds of work. In engineering it is customary to speak of a body of given weight, w (1 cubic foot of water, for example), as having different forms of energy, such as energy of position (or potential energy), velocity energy, and pressure energy. With respect to the surface of the earth, a cubic foot of water at an elevation of 100 feet has a potential energy of 6250 foot-pounds.

In the science of physics, and in modern research concerning the movement of water in soils, the term *potential* is used with a somewhat different meaning. Because of the important contributions made by physicists to the study of soil moisture movement, it is essential that students of engineering and of agriculture give careful consideration to the meaning and the usefulness of the term *potential*. As used in the science of physics, the term potential is defined as the work required to bring a unit mass against certain forces from any specified reference position to a particular point in space. The potential therefore characterizes each point in a region. In a region where there is an electrical field due to static charges each point is characterized by an electrostatic potential, measured in volts; in a heated body the thermal potential, or temperature, is used; in a gravitational region a gravitational potential may be defined.

The utility of the potential in studying the flow of soil moisture arises from the fact that the *space* rate of change of the potential is directly related to the forces causing the flow. Remembering from the above definition that the potential is the product of force per unit mass and distance, it is easy to see that the difference in the potential at two different points, divided by the distance between them, i.e., the space rate of change of potential, gives the average force per unit mass acting in the direction of the line connecting the two points. Measurements of the potential are in many cases practicable where *direct* measurements of force due to a space rate of change in potential are impracticable. In soil moisture studies a pressure and a gravitational potential are used, and these two, taken together, are considered as a total potential in terms of which the total force tending to cause a motion of the water may be expressed.

137. Units Employed. — As used in the study of soil water flow, the potential is also defined as work per unit mass, and the level free ground-water surface is selected as the plane (or the surface) of reference, i.e., the surface of zero potential. In physics the gram is a commonly used unit of mass, and the capillary potential, as defined in Article 142, is

sometimes measured in terms of gram-centimeters per gram. The *dyne*, a unit of force in physical language, is the force which will produce a change in velocity of 1 cm. per second in 1 gram of mass. Since the force of gravity gives in 1 second a change in velocity of 980 cm. per second (approximately) it is equal to 980 dynes per gram of mass. The term gram is therefore also used as a force and is equal to 980 dynes.

The foot-pound-second units are commonly used in engineering. Thus, the change in velocity of a body due to gravity is 32.2 feet per second, and the weight (or force of gravity) on a cubic foot of water is 62.5 pounds. Hence the unit of mass in the gravitational engineering system is the body that will be given a change in velocity of 1 foot per second by a 1-pound force, or 32.2 feet per second by a 32.2-pound force.

From Newton's Second Law of Motion, it follows that

$$M = W/g \dots \dots \dots (44)$$

where M = the mass of the body, W = the weight of the body, g = the acceleration due to gravity, or the force of gravity on unit mass. It is apparent from equation (44), since the change in velocity, g , due to gravity is 32.2 feet per second, that W must equal 32.2 in order to make M equal 1, or:

$$M = 32.2/32.2 = 1$$

The unit of mass in the gravitational engineering system is therefore a body that weighs 32.2 pounds,* sometimes called a *geepound*. Clearly this unit of mass is a derived unit, whereas the pound as a unit of force and the foot-per-second as acceleration are arbitrarily chosen units. Since the unit volume of water, 1 cubic foot, weighs 62.5 pounds, it has $62.5/32.2 = 1.94$ units of mass.

138. Potential Gradients. — In a region in which the magnitude of the potential changes from point to point there will be different space rates of change of the potential in different directions. There will be one direction in which the rate of change of the potential will be greater than in any other direction. The change in potential per unit length in the direction of the *greatest* rate of change is known as the *potential gradient*. For example, in considering the gravitational attraction of the earth on a unit mass, the direction of the greatest rate of change in the gravitational potential is vertical, and hence the direction of the *gravitational potential gradient* is vertical. Therefore, if in a region of moist soil each unit mass of water were acted on only by the negative gravitational potential gradient, then soil water would move vertically

* For the purposes of this discussion the variation in g due to position need not be considered.

downward.* In reality, however, the soil water at every point in a wetted soil generally has also a pressure potential, and therefore the movement of the water will be in the negative direction of the gradient of the total potential, or in other words, in the negative direction of the gradient of the sum of the gravitational and the pressure potentials. The water in a canal or in a pipe is free to move only in the direction of the canal or pipe. The force per unit mass causing flow in canals (Fig. 6) is therefore a negative component of the gravitational potential gradient. This component is *proportional* to the fall of the water surface per unit length of the canal, or to the slope of the hydraulic grade line. The force on unit mass causing flow through horizontal pipes is the negative gradient of the pressure *potential* and is proportional to the fall in pressure head per unit length of pipe through which the water flows.

139. Hydraulic and Energy Grade Lines. — In engineering literature, as shown briefly in Chapter II, the term “hydraulic grade line” is used

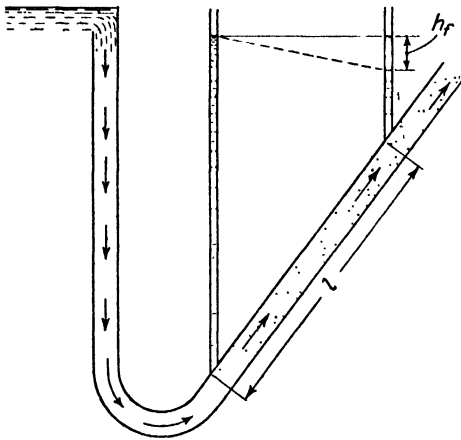

FIG. 104. — Illustrating the measurement of the hydraulic slope, h_f/l .

to designate a curve representing the heights to which water would rise in a series of vertical tubes connected to a pipe line through which water is flowing under pressure. For pipes in which the intensity of water pressure is low, the hydraulic grade line will be relatively near the pipe; and for pipes in which the pressure intensity is high the hydraulic grade line will be farther above the pipe line. The mean velocity of the water flowing in the pipe is *independent* of the *elevation* of

the hydraulic grade line, but it is *dependent* on the slope.†

Measurement of the hydraulic slope is illustrated in Fig. 104. In a

* The student should note a significant point of difference between the two quantities, (1) *potential* and (2) *potential gradient*. The potential is a quantity having *magnitude* only — it has no direction and is therefore a *scalar* quantity. The potential gradient as used herein is a quantity having *magnitude* and *direction*, and is therefore a *vector* quantity.

The direction of the potential gradient in which the potential increases is usually considered positive. Thus the force of gravity on unit mass is equal to the *negative* gradient of the gravitational potential.

† See also Article 27.

pipe, or a column of soil through which water is flowing it is the loss of head, h_f , divided by the length between the points of measurement, l , i.e., h_f/l .

It is customary among engineers to define the "energy grade line" as a line above the hydraulic grade line a distance equal to the velocity head of the flowing water. When the mean velocity of water from point to point along the pipe line is constant, as in a pipe of uniform diameter, the hydraulic and the energy grade lines are parallel. When the velocity decreases, as in a diverging pipe, the two lines come closer together; when the velocity increases, the distance between the lines increases. For very low velocities, such as commonly occur in soils, the energy grade line is practically at the same elevation as the hydraulic grade line. Because the velocity of water flow in soils is usually small, and changes in velocity negligible, only the hydraulic grade line need be considered.

The elevation of any given point on the hydraulic grade line is analogous to the potential defined in Article 136; i.e., the work required to move unit mass of water against the force of gravity from any horizontal datum line to a point on the hydraulic grade line is proportional to the elevation of this line with respect to the datum line.

The difference in energy per unit mass of water at two points in a pipe, as represented by the difference in elevation of points on the hydraulic grade line, divided by the distance along the pipe between the points at which the pressures are measured gives the magnitude of the potential gradient. The potential gradient is therefore proportional to the slope of the hydraulic grade line, or better, the hydraulic slope.*

140. Equipotential Regions.— A space in which the potential at every point is of the same magnitude is known as an equipotential region. For example, consider a block of iron having a uniform temperature. The space occupied by the iron is a region of equithermal potential, and there is no flow of heat from one part to another.

A body of still water such as a lake or a pond, undisturbed by wind and having neither inflow nor outflow, constitutes an equipotential region. On the surface of the water the gravitational potential is clearly the same everywhere because the surface is level. The pressure potential is also constant and hence the total potential is constant. Passing from the level water surface downward toward the bottom of the pond the pressure potential increases at the same rate as the gravitational potential decreases, hence the total potential, i.e., the sum of the pressure and

* The terms "energy gradient" and "hydraulic gradient" are used by some writers to designate the "slope of the energy grade line" and the "slope of the hydraulic grade line," respectively.

the gravitational potentials, is constant, and the region is an equipotential region. From the definition of the potential gradient, it is clear that there are no resultant forces in an equipotential region, i.e., the gradient of the potential in an equipotential region is zero. Because there are no resultant forces, there can be no motion, and hence an equipotential region is known as a region of *static equilibrium*.

A column of unsaturated soil in which the capillary water is in equilibrium with ground water is shown in Fig. 84. In the consideration of potentials in soils it is customary to neglect temperature differences, or to assume uniform temperatures. The soil column of Fig. 84 represents an equipotential region; that is, the sum of the gravitational potential and the pressure potential is constant through the volume occupied by the soil. Therefore, as shown in Article 120, the upward capillary force per unit mass is equal in magnitude to the sum of the force of gravity plus the downward capillary force; hence the resultant force is zero and there is no motion of water.

141. Pressure Potentials.— For pressure potentials as heretofore stated the free level water surface is selected as a reference plane, as shown in Fig. 84. Then the work required, ignoring the work done by gravity, to move unit mass of water downward *against the resultant upward water pressure*, from a point on the water surface to any point distant h_b , below the surface, is defined as the pressure potential.*

The work thus required is positive as the resultant pressure force is positive and hence the pressure potential is positive. For example, consider a mass of 1 gram of water of unit density. The resultant upward pressure on 1 cc. of water is 1 gram, and hence the work required to move the 1 gram against this resultant upward pressure from the level water surface to a point that is situated h centimeters below is h gram-centimeters. It is of interest to note that the pressure potential in a body of water at rest, using the centimeter-gram-second units, is *numerically* equal to the distance of the point below the water surface.

In the study of motion of water in saturated soils (as in pipes) in which the pressures and the pressure potentials are positive, use has long been made of the pressure potential gradient as a driving force. [See Eq. (7).] Comparatively little use has been made of pressure potentials in the study of movement of water in unsaturated soils. The capillary potential studies of recent years apply the pressure potential to

* A body of water at rest constitutes an equipotential region because in passing downward from the level water surface the gravitational potential decreases at the same rate as the pressure potential increases. Hence the force of gravity per unit mass may be considered as doing the work required to create a pressure potential in a body of water at rest.

unsaturated soils. The capillary potential is a negative pressure potential, as will be seen from the discussion of the next article.

142. The Capillary Potential. — The capillary potential is defined as the work required to move unit mass of water from the level water surface *against the capillary forces* in the soil column to any point distant h_a above the free water surface.* (See Fig. 84.) As was shown in Article 118, the capillary water is in tension and hence the capillary pressures are negative, making the capillary potential also negative. The water below the free water surface, in engineering language, is under compression.

The *equilibrium value* of the capillary potential in a soil at any given elevation above the free water surface is constant. Remembering that the capillary potential is negative, it is apparent that its equilibrium value decreases with increase in height above the water surface. That is, the capillary potential at a point 100 cm. above the free water is really a minus 100 gram-centimeters per gram, and this, in reality, is less than a minus 50 gram-centimeters per gram, which is the capillary potential 50 centimeters above the free water at equilibrium. The space rate of decrease in the capillary potential, in a soil in which the capillary water is at equilibrium with the free water, is equal to the space rate of increase in the gravitational potential. This is true because the sum of these two potentials, at equilibrium, must be constant, thus making the gradient of the sum of the potentials equal zero. If the potential gradient were not zero, there would be a resultant driving force which would cause water movement and prevent the maintenance of equilibrium conditions.

143. Moisture Content and Capillary Potential. — Although the equilibrium magnitude of the capillary potential at a given height above the free water is constant, the moisture content of the soil corresponding to a particular capillary potential is influenced by the soil texture, structure, the soil solution, and the temperature. The first two factors influence particularly the curvatures of the capillary water films, and the last two the surface tension of the liquid, and thus all influence the capillary pressures.

The recent work by Richards indicates a marked decrease in capillary potential with decrease in moisture content particularly for fine-textured soils. As shown in Fig. 105, Richards studied the relation of moisture content at equilibrium to capillary potential in four soils, namely, *A*, Bennet sand; *B*, Greenville loam; *C*, Trenton clay; *D*, Preston clay.

* It is important to note that the capillary potential does not include the work required to move the unit mass of water against the force of gravity from the level water surface to the point distant h_a above this surface.

The measurements of capillary potential reported in Fig. 105 were conducted under a constant temperature of $16.1^{\circ}\text{C}.$; the soil structure was maintained as nearly uniform as possible, and hence the data reported for each particular soil show the relation of the moisture content

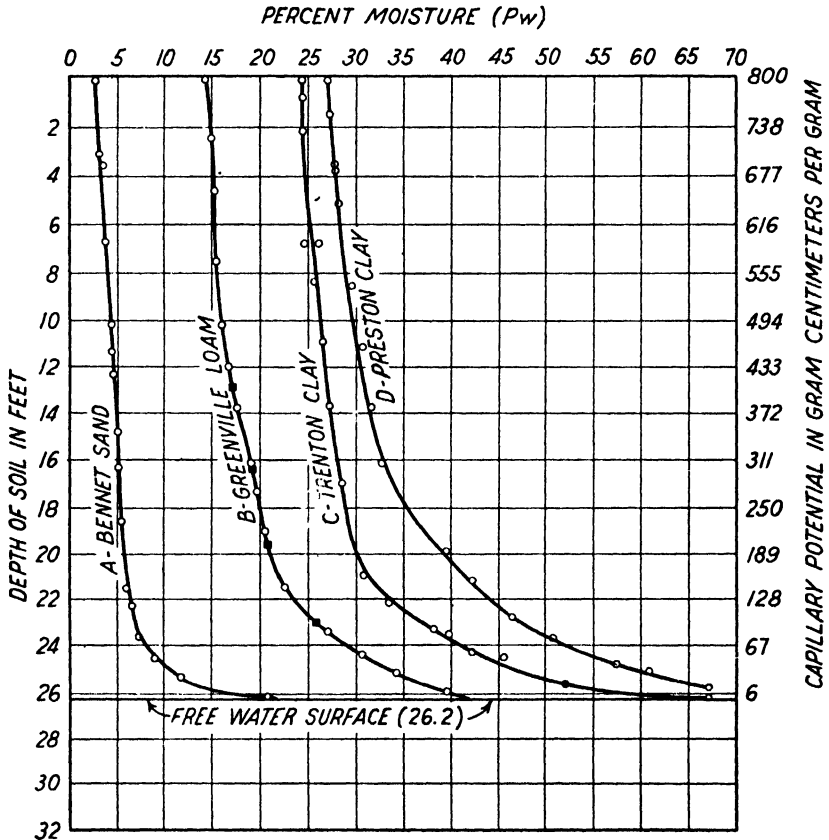

FIG. 105. — Capillary moisture capacity at equilibrium with ground water for four types of soil as determined by Richards. (Data from Jour. Agr. Research Vol. XXXVII No. 12.)

to the capillary potential. For example, in soil *D* the moisture content P_w decreased from 67 per cent to 27 per cent as the capillary potential decreased from zero to 800 gram-centimeters per gram. The soils *A*, *B*, *C*, and *D*, at equilibrium with potential of 250 gram-centimeters per gram, have moisture contents respectively of 6, 20, 28, and 36 per cent. Richards used layers of soil only $\frac{1}{2}$ inch in depth, thus facilitating the attainment of equilibrium moisture conditions in a relatively short

time — from 3 to 4 days. The irregularity of the curves for the two clay soils is interpreted as indicating that a slightly longer time for these soils would have assured a more complete approach to equilibrium.

It is very important to note that the above definitions of potentials and the potential gradients all involve *conservative forces* analogous to the driving forces considered in Chapter II relating to the conveyance of water. Thus far in the discussion of the movement of water in soils, the retarding influences of frictional forces have purposely been neglected. Clearly, however, a complete consideration of the forces which influence the movement of water in soils must include a discussion of the retarding, as well as the driving, forces. There are some essential differences in the retarding forces in saturated and unsaturated soils. In the interest of clearness it is advantageous to consider first the retarding forces which are common to saturated and unsaturated soils, and later to discuss the movement of water in saturated and unsaturated soils separately.

144. Retarding Forces. — In soils the frictional resistance is dependent on the effective size of the soil interstices and capillary channels, the pore space, the temperature of the water, and the percentage of water content. Because of the fact that there is great variability and lack of uniformity in a natural soil, it is impracticable to evaluate with precision for any particular soil the effective size of the capillary channels and of the frictional resistance. The retarding influence of the shape of the capillary channels cannot be measured and designated by a factor such as the hydraulic radius, r , which gives in part a measure of the retarding influence of the form of cross-section of canals, rivers, and pipes. In unsaturated soil there is even greater variability of frictional forces, owing to the fact that water channels through which moisture moves are influenced by the moisture content of the soil — which is variable. It is, therefore, a relatively complex problem to develop an equation that will give the velocity of water in soils analogous to equation (11) for canals and pipes. For unsaturated soils it is especially difficult. Comparatively recent research points the way toward measuring the driving force per unit mass — but the frictional factors, analogous to the n in Manning's formula, for different soils containing various amounts of capillary water and dissolved substances at different temperatures are yet to be established. To evaluate the frictional resistance due to each of the variables separately is impracticable. It seems hopeful, however, to attempt to evaluate experimentally the combined frictional resistance as a characteristic of each major type of soil at a given moisture content. In considering the conveyance of irrigation water in Chapter II, the influence of friction as a force retarding flow of water in canals and pipes

is explained. That the frictional resistance to flow of water in canals and pipes varies approximately with the square of the velocity, is pointed out. A very essential point of difference between the relation of frictional forces to velocity of flow of water in canals and pipes and to velocity of flow in soils is this:

In soils, owing to the relatively slow movement of water, the flow is said to be *stream-line* and not *turbulent*, and hence the frictional resistance varies approximately with the *first power* of the velocity rather than with the *second power*, or the square of the velocity, as in canals and pipes. This relation, stated in a somewhat different form, is known as Darcy's law. Mathematically stated for flow in soils

$$F_r = Kv \dots \dots \dots (45)$$

where F_r = the retarding frictional force on the moving water in each unit volume of soil.

v = the velocity of flow in soils.

K = a constant for a particular soil.

The driving force on the moving water in each unit volume is equal in magnitude and opposite in direction to the retarding force.

145. Velocity of Flow in Saturated Soils. — Each unit volume of a saturated soil is occupied by solid soil particles and by water. Part of the water is free to move, and part is held rather firmly around each soil particle. The pore space in soils ranges from 30 to 60 per cent of the total volume; and probably the volume of water free to move in saturated soils at significant velocities ranges from 15 to 40 per cent or more of the total volume.* In unsaturated soils the volume percentage of water that is free to move is smaller than in saturated soils.

Let P_f = the percentage of water in a saturated soil on a volume basis that is free to move, or the percentage of total soil area through which water moves in a soil. Using 1 cubic foot as the unit of volume, the units of mass of water in each unit volume which are free to move are $1.94P_f$.

In equation (9) and Fig. 8, it is shown that the resultant driving force per unit mass of water flowing at a constant velocity in a pipe is the negative gradient, in the direction of the pipe, of the sum of two potentials. The same principle applies to the flow of water in soils, in which the potentials are due to position and to water pressure, either positive

* A precise measurement of the percentage of water that is free to move is not essential to the following analysis or to the use of the final equation deduced. The concept that part of the soil water is not free to move, or that its velocity is so small as to be negligible, is introduced to aid in the analysis.

or negative, i.e., hydrostatic or capillary pressures. The rectilinear flow of water under pressure in soils is analogous to the flow in pipes. Hence the driving force per unit mass is proportional to the drop in the hydraulic grade line (h_f of equation 9) in a given length l ; and it is equal to gh_f/l , i.e., the negative gradient, in the direction of the pipe, of the sum of the two potentials above described. Therefore, since the magnitude of the driving force per *unit* mass is gh_f/l , it follows that the driving force, F_d , on the moving water in each cubic foot of saturated soil is:

$$F_d = 1.94P_f \frac{gh_f}{l} \dots \dots \dots (46)$$

Since $F_d = F_r$ (in magnitude), it follows from equations (45) and (46) that

$$v = \frac{1.94P_f}{K} \frac{gh_f}{l} \dots \dots \dots (47)$$

146. Discharge through Soils. — In Chapter II it is shown that the discharge through a canal or pipe is given by the equation

$$q = av \dots \dots \dots (12)$$

In soils part of the total cross-section area, represented in equation (12) by the symbol a , is occupied by soil particles surrounded by tiny water films. The net area at right angles to the direction of flow, through which flow occurs, is given by the product $P_f a$. Therefore the discharge through soils is given by the equation

$$q = \frac{1.94P_f^2}{K} \times \frac{gh_f a}{l} \dots \dots \dots (48)$$

For any given water content of an unsaturated soil the percentage P_f is essentially constant. Therefore the quantity $1.94P_f^2/K$ for a saturated soil, or for an unsaturated soil having a definite moisture content, may be considered a constant and represented by the symbol k . Equation (48) then takes the form

$$q = k \frac{gh_f a}{l} \dots \dots \dots (49)$$

* The following analysis of equation (49) shows that the quantity k has the *physical dimensions* of time (T).

$$q = \text{the volume per second} = L^3/T.$$

$$a = \text{area} = L^2.$$

$$g = \text{force per unit mass, or acceleration due to gravity} = ML/MT^2 = L/T^2.$$

Therefore

$$k = \frac{q l}{gh_f a} = \frac{L^3 T^2 L}{T L L L^2} = T.$$

The percentage P_f cannot be directly measured, whereas the quantity k can be measured experimentally without difficulty.

147. Water Transmission Factors for Soils. — If the quantity gh_f/l of equation (49) is equal to unity, and the area a equals unity, then it is apparent that $q = k$ (numerically). The quantity k is therefore defined as the volume of water that will flow in unit time through a soil column of unit cross-section area due to the driving force per unit mass corresponding to unit potential gradient. The magnitude of the quantity k at a particular temperature is determined largely by soil properties such as texture, structure, porosity, and water content. It is not truly a constant, although it does characterize a soil under specified conditions. It is suggested that the quantity k be designated as the *specific water conductivity*. The force of gravity per unit mass, or the acceleration due to gravity, g , of equation (49), though slightly variable, is considered constant in the solution of most practical problems. Representing the product kg in equation (49) by a new symbol k_s , it follows that:

$$q = k_s \frac{h_f a}{l} \dots \dots \dots (50)$$

The quantity k_s of equation (50) is the *transmission constant* defined by Slichter as "the quantity of water that would be transmitted in unit time through a cylinder of the soil of unit length and unit cross section under unit difference in head at the ends."

More recently the quantity k_s has been designated the *hydraulic permeability* by Meinzer and defined "as the rate of discharge of water through a unit cross-section area of the rock (or soil) at right angles to the direction of flow if the hydraulic gradient is unity."

The quantity k_s has also been designated as a "coefficient of permeability" by Meinzer and Stearns. In applying his transmission constant Slichter used the cubic foot as the unit of volume, the square foot as the unit of area, and the minute as the unit of time. For the coefficient of permeability Stearns used the gallon as the unit of volume, the square foot as the unit of area, and the day (24 hours) as the unit of time, and also specified a temperature of 60° F.

Comparison of the definition of the specific water conductivity, k , with the definition of the hydraulic permeability or the coefficient of permeability k_s (aside from numerical differences in the units of volume, time, and area selected) shows that the essential point of difference is the specification of unit *potential gradient* for k and unit *hydraulic gradient* for k_s .

The potential gradient has been used largely by physicists, particularly in the study of movement of capillary water in unsaturated soils, whereas

the hydraulic gradient (or hydraulic slope) has been used largely by engineers and geologists in the study of the movement (or flow) of ground water in saturated soils or rocks.

The potential gradient has the physical dimensions of force per unit mass (F/M), whereas the hydraulic gradient is the ratio of a length to a length and therefore has zero physical dimensions. The transmission constant, the hydraulic permeability, and the coefficient of permeability, k_s , have the physical dimensions of length divided by time, i.e., L/T .

It is apparent from the foregoing that there is as yet no general agreement in the selection of a basic conductivity, or a transmission, or a permeability factor in the study of the movement of water in soils whether saturated or unsaturated, and hence that general agreement is also lacking as to the use of a potential gradient or an hydraulic gradient,* in an equation for the flow of water in soils.

Because of the wide usage in hydraulic engineering of the cubic foot as a volume unit, the square foot as an area, and the second as a time unit, these units are used in the measurements of specific water conductivity k in the following pages. The disadvantage of small fractional values of k resulting from the use of the second as the unit of time is offset by the use of the negative exponent. For example

$$3/10,000 = 0.0003 = 3 \times 10^{-4}$$

It is customary among irrigation engineers to use one or more of several different units of volume, area, and time with the term permeability. The units cubic feet per square foot per 24 hours, acre-inches per acre per hour (or simply surface inches per hour), and cubic feet per second per acre are typical. The flow being as a rule vertically downward under the force of gravity it is assumed that the hydraulic gradient h_f/l of equation (49) is unity. In Table XX, equivalent permeabilities, using these several sets of units, are compared to specific water conductivities ranging from 3.59×10^{-9} to 1.80×10^{-5} . Table XX is explained further in Article 148.

An advantage in the use of the specific water conductivity k is that its magnitude in cubic feet per square foot per second, as used in equation

* Research engineers may develop methods and equipment for measuring *capillary pressure heads* which are proportional but not equal to the capillary potentials measured by physicists. The engineers would then use the *capillary pressure head gradient* combined with the rate of change of *head* due to change in position, as the hydraulic gradient of *unsaturated* soils, which would be *proportional* but not equal to the *potential gradient*.

TABLE XX
COMPARISONS OF PERMEABILITY OF SOIL TO WATER AS STATED IN DIFFERENT
UNITS, WITH THE SPECIFIC WATER CONDUCTIVITY

Line No.	1	2	3	4
	Permeability in			Specific Water Conductivity k
	Cu. Ft. per Sq. Ft. per 24 Hours	Surface Inches per Hour	C.f.s. Per Acre	
1	0.01	0.005	0.005	3.59×10^{-9}
2	.02	.010	.010	7.18×10^{-9}
3	.03	.015	.015	1.08×10^{-8}
4	.04	.020	.020	1.44×10^{-8}
5	.05	.025	.025	1.80×10^{-8}
6	.06	.030	.030	2.16×10^{-8}
7	.07	.035	.035	2.52×10^{-8}
8	.08	.040	.040	2.87×10^{-8}
9	.09	.045	.045	3.23×10^{-8}
10	.1	.05	.05	3.59×10^{-8}
11	.2	.10	.10	7.18×10^{-8}
12	.3	.15	.15	1.08×10^{-7}
13	.4	.20	.20	1.43×10^{-7}
14	.5	.25	.25	1.80×10^{-7}
15	.6	.30	.30	2.16×10^{-7}
16	.7	.35	.35	2.52×10^{-7}
17	.8	.40	.40	2.87×10^{-7}
18	.9	.45	.45	3.23×10^{-7}
19	1.0	.50	.50	3.59×10^{-7}
20	1.2	.60	.60	4.32×10^{-7}
21	1.4	.70	.70	5.02×10^{-7}
22	1.6	.80	.80	5.75×10^{-7}
23	1.8	.90	.90	6.46×10^{-7}
24	2.0	1.00	1.00	7.18×10^{-7}
25	2.2	1.10	1.10	7.90×10^{-7}
26	2.4	1.20	1.20	8.62×10^{-7}
27	2.6	1.30	1.30	9.34×10^{-7}
28	2.8	1.40	1.40	1.01×10^{-6}
29	3.0	1.50	1.50	1.08×10^{-6}
30	3.2	1.60	1.60	1.15×10^{-6}
31	3.4	1.70	1.70	1.22×10^{-6}
32	3.6	1.80	1.80	1.29×10^{-6}
33	3.8	1.90	1.90	1.37×10^{-6}
34	4.0	2.00	2.00	1.44×10^{-6}
35	4.5	2.25	2.25	1.62×10^{-6}
36	5.0	2.50	2.50	1.80×10^{-6}
37	6.0	3.00	3.00	2.16×10^{-6}
38	7.0	3.50	3.50	2.52×10^{-6}
39	8.0	4.00	4.00	2.87×10^{-6}
40	9.0	4.50	4.50	3.23×10^{-6}
41	10	5.00	5.00	3.59×10^{-6}
42	15	7.50	7.50	5.38×10^{-6}
43	20	10.00	10.00	7.18×10^{-6}
44	25	12.5	12.5	8.98×10^{-6}
45	30	15.0	15.0	1.08×10^{-5}
46	35	17.5	17.5	1.26×10^{-5}
47	40	20.0	20.0	1.44×10^{-5}
48	45	22.5	22.5	1.62×10^{-5}
49	50	25.0	25.0	1.80×10^{-5}

(49), does not change if the units of volume and area are changed to cubic centimeters and square centimeters respectively.*

148. Conductivity of Saturated Soils. — Extensive investigations have been conducted to determine the conductivity of water in sands and fine gravel under a condition of complete saturation. The use of sands for filters to purify city water supplies and studies of the flow of water into wells have stimulated interest in studies of the conductivity of sands and gravels. Relatively little attention as yet has been given to the study of water conductivity of soils as related to irrigation and drainage.

Slichter found that his transmission constant was proportional to the square of the effective diameter of the soil particles and also that it was greatly influenced by the pore space of the soil. Because of the impracticability of measuring effective diameter of the pores in natural soils, especially those of fine texture, it seems advisable to encourage more experimental determinations of specific water conductivity, k , or of k_s independent of an attempt to measure the diameter or the cross-section area of the pores or the water films through which flow occurs.

Table XX includes a wide range of permeabilities, i.e., from $\frac{1}{100}$ to 50 cubic feet per square foot of soil in 24 hours, the relative variation being from 1 to 5000. To illustrate the use of Table XX, the student will note, for example, that a soil having a specific water conductivity, k , of 3.59×10^{-7} as given in column 4, will transmit 1 cubic foot of water per square foot of soil surface in 24 hours under the force of gravity.

Column 2 gives the permeability in "surface" inches per hour, which is equivalent to acre-inches per acre per hour. It will be remembered from Chapter III that 1 c.f.s. is equal approximately to 1 acre-inch per hour. On the basis of this approximation, column 3 of Table XX gives the number of cubic feet per second that would be required to maintain a stream of water percolating vertically downward through 1 acre of soil having different permeabilities and specific conductivities. For example, line 24 shows that a stream of 1 c.f.s. per acre would equal 2 cubic feet per square foot per 24 hours, and that this permeability is equivalent to a specific conductivity of 7.18×10^{-7} .

The computed data of Table XX will enable the student more easily

* This fact is demonstrated by changing from cubic feet per second per square foot to cubic centimeters per second per square centimeter. For unit area and unit potential gradient, when $q = kg$,

$$k = \frac{q(\text{c.f.s. per sq. ft.})}{g(\text{feet per sec.}^2)} = \frac{(30.5)^2 q(\text{cc. per sec. per } (30.5)^2 \text{ sq. cm.)}}{30.5g(\text{cm. per sec.}^2)}$$

and therefore
$$k = \frac{q(\text{cc. per sec. per sq. cm.})}{g(\text{cm. per sec.}^2)}$$

to interpret the experimental permeability measurements reported in Table XXI. These measurements were made by the author during the years 1917 to 1923 on field soils by two methods designated in column 7 as the *cylinder* and *plat* methods. Eighteen-inch-diameter iron cylinders 20 inches long and open at both ends were driven into the soil in its natural condition. Measured amounts of water were added to the soil frequently enough to keep it well covered but to avoid a depth of water that would create much pressure. The permeability was measured by noting the rate of drop in the water surface in half-hour and longer intervals.

TABLE XXI
PERMEABILITY AND SPECIFIC WATER CONDUCTIVITY FIELD TESTS OF DIFFERENT SATURATED SOILS

Class of Soil	Location of Field	Time	Cu. Ft. per Sq. Ft. per 24 Hours	Surface Inches per Hour	C.f.s. per Acre	Specific Water Conductivity k	Method
1	2	3		4	5	6	7
Highland Sterling Sandy Loam	Hyrum, Utah	1st Hr.	4.88	2.44	2.44	1.7×10^{-6}	18-in. cylinders used
		2nd	2.92	1.46	1.46	1.0×10^{-6}	
		3rd	3.00	1.50	1.50	1.1×10^{-6}	
		4th	2.50	1.25	1.25	9.0×10^{-7}	
		5th	2.50	1.25	1.25	9.0×10^{-7}	
Medium Depth Lava Loam	Grace, Idaho		1.00	0.50	0.50	3.6×10^{-7}	Plat 25 ft. sq.
	Central Idaho		1.24	.62	.62	4.4×10^{-7}	Plat 18 ft. sq.
			0.68	.34	.34	2.4×10^{-7}	Plat 18 ft. sq.
			.76	.38	.38	2.7×10^{-7}	18-in. cylinders
		.84	.42	.42	3.0×10^{-7}	18-in. cylinders	
Deep Loam	Logan, Utah (Greenville)	<i>Plat</i>					Plats 33 ft. by 38 ft.
		A — 1st day	9.0	4.5	4.5	3.2×10^{-6}	
		B — 1st day	5.68	2.84	2.84	2.0×10^{-6}	
		2nd day	2.24	1.12	1.12	8.0×10^{-7}	
		C — 1st day	4.78	2.39	2.39	1.7×10^{-6}	
	2nd day	1.48	.74	.74	5.3×10^{-7}		
	Richfield, Utah		1.40	.70	.70	5.0×10^{-7}	18-in. cylinders

Similar measurements were made in the field plat method, the essential difference being a larger area of soil being submerged. The plats used ranged from 32 to 1254 square feet in area. As noted in Table XXI, the permeability of the sandy loam decreased by approximately

one-half in a period of 4 hours, after which it remained constant. The lava loam permeabilities represent a steady flow. The deep loam measurements at Logan on plat *A* represents only the rapid flow shortly after wetting. On plats *B* and *C* the higher permeabilities are shortly after wetting, and the lower ones represent a steady flow more than 12 hours after wetting. It is well known that clay soils transmit water slowly. However, systematic measurements of specific water conductivity of clay soils are as yet meager. Moreover, most of the measurements of water conductivity of clay soils thus far have been made under laboratory conditions. The lowest measured conductivity in a saturated soil available to the author is that reported by Gardner *et al.* for a clay soil in Cache Valley, Utah; i.e., $k = 1 \times 10^{-9}$. Working on a heavy clay taken in its natural condition from a field near Dixon, California, the author found a conductivity of 6.3×10^{-9} , which is approximately 6 times that of the Cache Valley clay as measured by Gardner.

King early found wide variation in the permeability of soils to water. Specific conductivities computed from his data show in a "fine textured black marsh soil" $k = 2.1 \times 10^{-8}$; for a clay, 4.8×10^{-8} ; a fine sand, 1.2×10^{-6} ; and a coarse sand, 9.0×10^{-6} . Gardner has found for a sand that $k = 4 \times 10^{-5}$. The ratio of the conductivity of the coarse sand used by Gardner to that of the sand used by King is 4.4.

149. Steady Capillary Water Flow. — The flow of water in unsaturated soils is designated capillary flow. A steady flow of capillary water in irrigated soils, analogous to the ordinary flow of water in canals, seldom occurs; the flow is usually changing. However, under certain conditions, such, for example, as the capillary flow vertically upward from a high water table to the soil surface, the flow approximates a steady state if continued for a sufficiently long time. Knowledge of the quantity of such flow is of great importance in irrigated regions. Steady capillary flow vertically upward may be beneficial in supplying water to plant roots; yet it may be harmful, not only because of conveying water to the land surface where it is lost through evaporation, but also by carrying large amounts of alkali to the surface and thus rendering the soil non-productive. In the discussion of this Article, conditions are assumed to exist essential to the maintenance of steady flow. However, there is much capillary flow of vast importance to agriculture that varies from day to day and hour to hour. Measurements of such unsteady flow are of comparatively less value than those of steady flow because of the variable factors involved; moreover, they are more difficult to make.

In an unsaturated field soil of substantially uniform texture and structure, the resultant driving force per unit mass of water that causes

its flow is the negative gradient of the sum of the gravitational and the capillary potentials.*

To illustrate the use of the capillary potential gradient in determining the flow of capillary water through a small pipe in a specified direction, the following cases are considered.

150. Steady Horizontal Capillary Flow.— The *horizontal* flow of capillary water in a soil within a small diameter pipe is caused by different capillary potentials at the several points in the pipe. The capillary potential differences result largely from soil moisture differences.

For example, consider the horizontal capillary flow within the impervious walls of a pipe of small diameter filled with soil, and having one end connected through a porous plug to a water reservoir as shown in Fig. 106. The elevation of the water surface is kept the same as the axis of the pipe, and consequently there is no positive water pressure in the soil. Water is supplied to the soil from the reservoir on the reader's left by flow through a porous wall. Assume the soil to be a Greenville loam of the same temperature, texture, and structure as soil *B* of Fig. 105. The moisture percentages of the soil in the pipe at points distant respectively 0, 2, 4, 6, and 8 feet from the source of water are assumed to be 40.0, 26.0, 21.0, 18.5, and 17.0. The capillary potential corresponding to a given moisture content for either of 4 different soils may be found from Fig. 105. Curve *B* shows that, at the free water surface where the capillary potential is zero, the moisture percentage is 40; also that, at the point in the soil where the capillary potentials are 100, 200, 300, and 400 gram-centimeters per gram, the moisture percentages are 26.0, 21.0, 18.5, and 17.0, respectively. The capillary potential gradient within the soil column in Fig. 106 is therefore $100/61 = 1.64$ grams per gram, or 980×1.64 dynes per gram. Remembering that there is no change in *gravitational* potential along a level pipe it follows from equation (49) that:

* Considerable advancement has been made during recent years by Gardner and by Richards in the development of methods of measuring the capillary potential. For detail concerning these methods the reader is referred to papers cited at the end of this chapter.

The symbol Φ is used by physicists to represent the sum of the potentials and $d\Phi/dr$ to represent the gradient of the sum of the potentials. The quantity of capillary water transmitted through an unsaturated soil is then given by the equation

$$q = k \frac{d\Phi}{dr} a$$

The symbols k and a are the same as those of equation (49), and the $d\Phi/dr$ is analogous to the symbols gh_f/l of equation (49). The gradient $d\Phi/dr$ may be considered as the vector sum of two parts: (1) the capillary potential gradient, and (2) the gravitational potential gradient.

$$q = k 980 \times 1.64 \text{ cc. per sec. per sq. cm.,}$$

or

$$q = k 32.2 \times 1.64 \text{ c.f.s. per sq. ft.}$$

For capillary flow the specific conductivity k is probably less than it is for flow in a saturated soil. For an illustration, the magnitude of k is taken from work by Gardner on the Greenville soil, indicating a mean of $k = 1.2 \times 10^{-8}$ for capillary flow. Substituting this value of k it is found that the

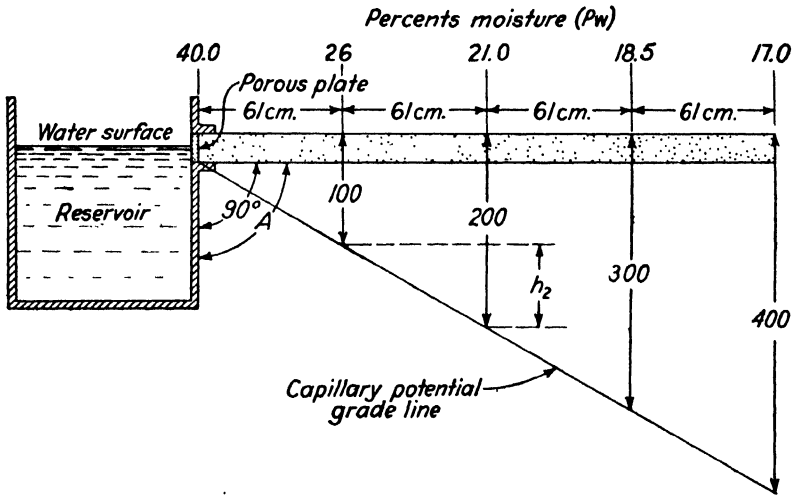

FIG. 106. — Illustrating steady flow of capillary water in a horizontal pipe of small diameter containing soil that has a moisture per cent of 40 at the left end and 17 at the right end; and a uniform capillary potential gradient of 1.64×980 dynes per gram of soil water.

soil in the horizontal pipe illustrated in Fig. 106, owing to the assumed rate of change in moisture content, would transmit a quantity of water

$$q = \frac{1.2 \times 32.2 \times 1.64}{10^8} = 6.3 \times 10^{-7} \text{ c.f.s. per sq. ft.}$$

which is equal to $6.3 \times 10^{-7} \times 8.64 \times 10^4 = 0.054$ cubic foot per square foot per 24 hours = 1.62 cubic feet per square foot per month.

151. Steady Capillary Flow through Inclined Pipes. — Flow through an inclined pipe is influenced by a change in the potential due to position of different points along the pipe and to change in the potential due to difference in moisture content of the soil. Assume, for example, that the pipe in Fig. 106 is connected to the water reservoir by means of a flexible rubber hose as illustrated in Fig. 107 so that it can be rotated

to any desired position from pointing vertically downward to vertically upward. The angle between the pipe and the reservoir may be of any value from zero, when the outlet end of the pipe is below the reservoir, to 180° , when it is above the reservoir. Assume that the capillary potential gradient remains constant for all positions of the pipe. Then the total force acting on each unit mass of soil water in the direction of the pipe line is the sum of the component of the force of gravity on unit mass in the given direction, plus the negative capillary potential gradient. Let the angle of the direction of flow with the vertical be represented by A .

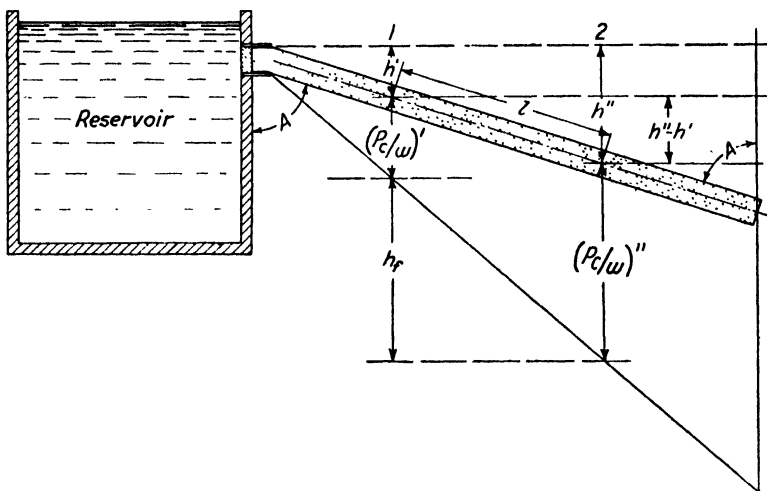

FIG. 107. — Illustrating the capillary flow of water through an inclined pipe, using engineering symbols to represent heads due to position and to capillary pressure.

Application of equation (49) to this case is illustrated by the aid of Fig. 107. Two points in the moist soil numbered 1 and 2 are separated by a distance l , and the vertical distances of the points from the horizontal plane of the water surfaces are represented by h' and h'' respectively. The capillary pressure heads are represented by $(p_c/w)'$ and $(p_c/w)''$. The sum of the heads due to position and to capillary pressure at point 1 is $(h' + p_c'/w)$, and at point 2 is $(h'' + p_c''/w)$, and the difference in these two sums is represented by h_f . The change in magnitude of total potential between the two points is equal to gh_f , and the potential gradient along the pipe is gh_f/l , which may be stated in this form:

$$g\left(\frac{h'' - h'}{l} + \frac{p_c''/w - p_c'/w}{l}\right)$$

The ratio $\frac{-h'}{l} = \cos A$, and assuming that the rate of change in

the capillary potential is the same as in the previous example, it follows from the foregoing that

$$q = 32.2k(\cos A + 1.64) \text{ c.f.s. per sq. ft.}$$

As the angle A increases from values between 0° and 90° , $\cos A$ is positive, and hence the resultant force per unit mass is greater than the negative capillary potential gradient; whereas between values of 90° and 180° for the angle A , $\cos A$ is negative and the resultant is less than the negative capillary potential gradient. For example:

$$q = 68.8k \text{ c.f.s. per sq. ft. when } A = 60^\circ$$

and

$$q = 36.7k \text{ c.f.s. per sq. ft. when } A = 120^\circ$$

152. Capillary Flow in Field Soils. — In homogeneous natural soils in the field capillary flow is always influenced by gravity. In field soils the major practical concern in a study of *steady capillary flow* is the quantity of flow vertically up or down. The importance of capillary flow vertically downward is frequently under-estimated. The student should keep clearly in mind the fact indicated in Fig. 105, namely, that at medium and high moisture percentages a substantial increase in moisture content with depth of soil is essential to the prevention of downward capillary flow. For example, in the Greenville loam, the moisture content must increase from 16 to 20 per cent in a vertical distance of 8 feet to develop a capillary potential gradient at any point equal in magnitude to the gravitational potential gradient. With the higher moisture content there must be an increase from 20 per cent to 40 per cent in an 8-foot depth to accomplish the same result. The moisture gradients and resulting capillary potential gradients within the above ranges of moisture content must exceed the examples above given in order to provide a *resultant force* vertically upward and thus cause capillary water to move vertically upward. That the above statements apply only to comparatively uniform soils, and that the influence of temperature differences and variations in soil solution are neglected, must be kept constantly in mind. Richards has recently measured the specific capillary conductivity of three soils:

A — A light sandy soil.

B — Greenville loam.

C — Preston clay.

In the sandy soil and the clay he found that the magnitude of k increased rapidly as the capillary potential was increased.*

* The capillary potential being negative, a change from a high numerical value, say 600 gram-centimeters per gram, to a lower numerical value such as 300 gram-centimeters per gram constitutes an increase in potential.

The change in k with change in capillary potential was relatively small for the Greenville loam. Richard's measurements of k for this loam soil at different capillary potentials gave results ranging from less than 2.0×10^{-9} to more than 5.5×10^{-9} . To illustrate the application of capillary conductivity measurements to a field problem, the following assumptions are used:

1. That the water table in the Greenville soil is 100 cm. below the soil surface.
2. That the temperature and compacting conditions of the field soil are not materially different from those of the laboratory.
3. That the capillary potential in the surface soil is 600 gram-centimeters per gram.
4. That the average value of the capillary conductivity is 3×10^{-9} cc. per square centimeter.

From Fig. 107 and Article 151 it is apparent that the angle A in the case here considered is 180° . And as $\cos 180^\circ = -1$, the capillary flow from the water table to the soil surface under the assumptions above stated is as follows:

$$\begin{aligned}
 q &= 3 \times 10^{-9} \times 980 (600/100 - 1) \text{ cc. per sq. cm. per sec.} \\
 &= 1.47 \times 10^{-5} \text{ cm. per sec.} \\
 &= 1.27 \text{ cm per day} \\
 &= 15 \text{ inches per month of 30 days.}
 \end{aligned}$$

Table XXII shows, on the basis of analysis, that we should expect the velocity of the capillary flow to be many times greater immediately after

TABLE XXII

SHOWING SUCCESSIVE CHANGES IN THE FORCE CAUSING CAPILLARY FLOW VERTICALLY UPWARD IN A SOIL COLUMN

Height of Capillary Water, Cm.	Capillary Potential Gradient, Grams per Gram	Resultant Upward Force per Gram of Water, Grams	Relative Velocity Based on Darcy's Law and Unit Velocity at 100-cm. Elevation
1	600	599	119.8
5	120	119	23.8
10	60	59	11.8
20	30	29	5.8
30	20	19	3.8
50	12	11	2.2
100	6	5	1.0

the soil and water are brought together than after a considerable time has elapsed. Possible variation in frictional forces are not taken into account in the computations of Table XXII. An analysis of typical results of experimental data justifies the belief that the specific conductivity of the soil is substantially constant for a short time period at least.

153. Limitations of Equations. — The engineer must use judgment and discretion in the application of the equations of this chapter to the solution of practical irrigation and drainage problems. Because of the many variations from point to point in natural soils, and because of the meager data available on the value of k , it is impossible to attain a high degree of precision in computing the discharge of water through soils. Moreover, the specific water conductivity, k , in a particular saturated soil, varies with time, provided the soil is subjected to different physical and chemical treatment. That the flow of water in soils is proportional to the gradient of the potential is well established for low potential gradients. Although further research may indicate limitations to this important law, it now appears that the most urgent experimental need is to evaluate in many soils and under various conditions the specific conductivity, k . This need is especially urgent in connection with fine-textured soils which, as a rule, have a low specific water conductivity. During the last half-century, engineers have greatly advanced the precision with which the capacities of river channels, canals, pipes, flumes, and other conduits can be estimated by experimentally evaluating the coefficient of roughness, n , of equation (11). Progress may likewise be made in the study of the movement of water in soils by centering experimental effort on the evaluation of the specific water conductivity, and on a study of its relation to important soil properties, including the moisture content of soils. Extended study of the factor, k , will increase the usefulness and decrease the limitations of the equations presented in this chapter.

REFERENCES

- BUCKINGHAM, EDGAR. Studies on the Movement of Soil Moisture, U. S. D. A. Bur. Soils, Bul. 38 : 1-61, Figs. 1-23. 1907.
- GARDNER, WILLARD. The Movement of Moisture in Soil by Capillarity, Soil Sci., 7, No. 4 : 313-316. 1919.
- GARDNER, WILLARD. A Capillary Transmission Constant and Methods of Determining it Experimentally, Soil Sci., 10, No. 2 : 103-126. 1920.
- GARDNER, WILLARD, and WIDTSOE, J. A. The Movement of Soil Moisture, Soil Sci., 11 : 215-232, Figs. 1-11. 1921.
- GARDNER, WILLARD, ISRAELSEN, O. W., and McLAUGHLIN, W. W. The Drainage of Land Overlying Artesian Basins, Soil Sci., 26, No. 1 : 33-45. 1928.

- ISRAELSEN, ORSON W. The Application of Hydrodynamics to Irrigation and Drainage Problems, *Hilgardia*, 2, No. 14. 1927.
- ISRAELSEN, O. W. Coordination of Research Concerning the Flow of Water in Soils, *Jour. Agr. Engineering*, 12, No. 12. 1931.
- MEINZER, OSCAR E. Outline of Ground Water Hydrology, U. S. G. S. Water-Supply Paper 494. 1923.
- RICHARDS, LORENZO A. The Usefulness of Capillary Potential to Soil-Moisture and Plant Investigators, *Jour. Agr. Research*, 37, No. 12 : 719-741. 1928.
- RICHARDS, L. A. Capillary Conduction of Liquids Through Porous Mediums, *Physics*, Vol. 1, No. 5. 1931.
- SLICHTER, CHARLES S. Theoretical Investigations of the Motion of Ground Water, U. S. G. S. 19th Ann. Rept. 2 : 301-380. 1898.
- STEARNS, NORAH DOWELL. Laboratory Tests on Physical Properties of Water-bearing Materials. Part F, U. S. G. S. Water-Supply Paper 596. 1927.
- TRULLINGER, R. W. Progress in the Study of Soil Hydromechanics Rpt. on the Agr. Exp. Stations, 87-96. 1927.
- WIDTSOE, JOHN A., and McLAUGHLIN, W. W. The Movement of Water in Irrigated Soils, Utah Agr. Exp. Sta. Bul. 115 : 199-268, Fig. 1, pls. 6. 1912.

CHAPTER XI

IRRIGATION AND ALKALI

Sterility and barrenness of arid region soils is a result of two major factors — drought and alkali. Although alkali lands are characteristic of arid regions, they are neither of general occurrence nor of uniform distribution. Sterility caused by drought alone has been changed to fertility by the irrigation of many arid-region areas. Reclamation of alkali areas and prevention of alkali injury on fertile areas now irrigated are problems of paramount importance.

In the western part of the United States, the San Joaquin, Sacramento, and Imperial Valleys of California; the Great Basin, including a large part of Utah and Nevada; the Colorado River watershed, comprising parts of Wyoming, Utah, Colorado, Arizona, and California; the Rio Grande River area including parts of New Mexico and Texas; also parts of the Columbia River Basin and of the great Plains area east of the Rocky Mountains, all contain significant areas of land now non-productive because of alkali.

Moreover, certain areas in Canada, Mexico, Asia, India, and Australia likewise are sterile because of alkali.

As applied to the soil, the term alkali refers to any soluble salts that make the soil solution sufficiently concentrated to injure plants, whether or not the salt has a basic chemical reaction.

154. Climate and Alkali. — Arid-region soils contain relatively large quantities of soluble salts. A heavy annual rainfall, such as occurs on the soils of humid regions, causes water to percolate through the soils and carry to the streams, rivers, and oceans, large amounts of soluble mineral substances. On the other hand, the scanty rains of arid regions do not penetrate the virgin arid soils deeply enough to cause appreciable percolation. The greatest depth of penetration of the water from natural precipitation, either the melted winter snow or the wet-season rains, is found to vary from 1 to 4 feet, depending on the amount and time of the precipitation and the nature of the soil. The lack of percolation through arid-region soils, together with the excessive evaporation of water in arid regions, gives rise to the accumulation of large quantities of soluble salts that are injurious to plant life.

155. Sources of Alkali. — All mineral soils are derived largely from the weathering of rocks. Stewart, Peterson, and Greaves have shown

that there is an intimate relation between present-day alkali accumulations and the alkali content of the rocks from which certain soils were formed. From extensive studies of the geological formations in Utah, Colorado, Arizona, Wyoming, Idaho, and Nevada, these investigators found that wherever alkali is present in very large amounts it apparently originated from materials deposited from concentrated salt waters of some ancient arid-climate sea. The Mancos shale is a typical rock in which large amounts of alkali salts occur. Soils formed directly from these alkali-bearing rocks usually contain excessive amounts of alkali.

Arid-climate soils free from excess quantities of alkali are sometimes rendered non-productive by the use of irrigation water containing excessive quantities of alkali salts. Water that comes from the melted snow and rains on mountain areas of alkali-bearing rocks sometimes contains appreciable amounts of alkali salts. Irrigation water as a source of alkali is further considered in Article 167.

156. Kinds of Alkali. — The chlorides, sulphates, carbonates, and nitrates of sodium, potassium, and magnesium, and the chlorides and nitrates of calcium, are commonly included as alkalis in the soil. The sulphates and carbonates of calcium are not sufficiently soluble to be harmful to plants. Most of these alkalis are in reality neutral salts. It is noteworthy that certain important plant food substances, notably sodium and potassium nitrates, really become harmful alkalis when they occur in the soil in excessive quantities. The sodium salts, being the most soluble, as a rule give rise to the more common alkali injury. Sodium carbonate (Na_2CO_3), sodium chloride (NaCl), and sodium sulphate (Na_2SO_4) are of special concern to irrigation agriculture. Of these the Na_2CO_3 , although a white salt, is commonly designated as "black alkali" because it decomposes the organic matter in the soil and this gives rise to a dark-colored crust on the soil surface. The Na_2CO_3 and the NaCl are especially harmful to plants.

157. Movement of Salts in Soils. — If it were possible to maintain a moisture distribution in irrigated soils such that moisture movement would be continuously downward, there would be relatively little trouble from alkali on irrigated farms. A continuous downward movement of water would gradually decrease the quantities of soluble salts in the upper few feet of soil in which plants obtain most of their moisture and food. However, in the absence of adequate under-drainage, percolating waters from either adjacent or distant lands soon fill the lower soil spaces and cause the water table to rise. During periods between irrigations a high water table favors the upward capillary flow of water to the land surface where it evaporates. The soluble salts carried by the upward-moving water cannot evaporate, and hence they are deposited on or

near the soil surface. Salts so deposited may come from soil horizons well below the surface that contain high percentages of alkali. Furthermore, the mere concentration on the surface of the salts that normally occur distributed through the upper few feet of soil may cause serious alkali injury.

In his book on "Soil Alkali," published by John Wiley & Sons, Inc., Harris says:

"The extent to which salts move with water passing through a soil has been studied by a number of investigators. In laboratory experiments, with alkali soils kept so continually moist that there was constant water movement, the author has shown that alkali, principally sodium chloride, is very readily transported from one portion of the soil to another, either upward or horizontally. The salts became very concentrated in the upper inch or two of soil where the water was allowed to evaporate. The first water percolating through alkali soil contained several times as much salts as was found later. Tulaykov found salts moved gradually and more or less completely to the surface of a column of soil 150 cm. in height supplied with water at the bottom. Hilgard as well as Puchner and others have noted a migration of salts upward and downward as the moisture changed places.

"The latter experimenter, using quartz sand, loam, and rich humus soils, found the movement to depend somewhat on the chemical and physical properties of the soils. Powdery soils allowed the salts to move more readily than crumbly soils. Kossovich reports a greater movement on a loess clayey soil than on a sandy soil and sodium chloride hastened the rise of water while sodium carbonate impeded it. It is probable that the differences both in nature of the salts and their concentration so often noticed in fields containing alkali are, in part at least, due to changes in the nature of the soils which in turn modify the rate of capillary action. In studies of the movement of moisture, Briggs and Lapham conclude that 'concentrated or saturated solutions of all salts materially diminish capillary action,' but that in dilute solutions the neutral salts had very little influence on capillary action. They found sodium carbonate to have a greater influence on capillarity than the neutral salts.

"The extent of the fluctuation of salts upward and downward under irrigation in the field has not been determined with any degree of accuracy. Hilgard considered the movement to be mostly in the top 4 feet. Considering the ease with which the salts move with the water and from observations of the movement of soluble salts with irrigation water when no alkali was present, it is very probable that the salts are frequently moved to great depths where not prevented by impervious soils or by a water-table. Investigations show that water is seldom drawn to the surface by capillary action from a depth greater than 2 or 3 feet, so that the greater part of the alkali which penetrates beyond this depth never again reappears at the surface unless the water-table rises to within a few feet of the surface. Water movement below the top 2 or 3 feet is probably caused by moisture removed by the plants or by the action of

gravity so that it is improbable that there is such movement of salts other than local diffusion and movement with the gravitational, or free, water."

158. Influence of the Water Table. — The nearer the water table is to the soil surface, the greater is the driving force tending to cause water to flow upward from the ground water to the surface. The influence of a rising water table on the upward capillary flow is analogous to the influence of making a canal grade steeper and steeper — both cause an increase in the velocity of the flowing water. A review of Chapter X will enable the student to see more clearly how the position of the water table influences the capillary potential gradient and hence the upward flow of moisture. Moreover, a high water table also decreases the resistance to capillary flow, owing to the fact that it maintains a relatively high average percentage of moisture in the soil above the water surface. As pointed out by Harris, based on the work of Headden and of Mackie, the soluble salts dissolved by downward-percolating waters are held near the surface of the body of ground water where they may readily be drawn by capillary upward flow back to the soil surface and there deposited as evaporation occurs. In speaking of the effect of the water table, Harris says:

"Headden made a rather detailed study of the effect of seasonal movement of water-tables from which he concluded that as the water fell much of the salts in the free water was retained by the soil so that the free water gradually became weaker as it sank and again increased as it rose. He found that the kind and quantity of salts in the soil solution differed markedly from those found in the free ground water or from the alkali incrustations on top of alkali soil. Certain of the soluble salts were absorbed by the soil, while others moved somewhat more freely. Calcium sulphate was the most abundant salt in the soil solution with magnesium sulphate second, while sodium sulphate formed considerable of the efflorescent matter on the surface, and the salts next the surface. Sodium chloride did not separate as readily as some of the other salts. Very little calcium sulphate left the soil to form part of the incrustation."

Irrigation farmers sometimes urge the advantages of keeping the water table within a few feet of the soil surface, because of the high crop yields obtained during the early years after it has risen from great depths. The favorable moisture supply from a water table a few feet below the soil surface does frequently cause high crop yields, but as a rule, in areas where alkali salts occur, the temporary favorable condition of the high water table is followed by serious decrease in yields, if not by complete non-productivity due to alkali concentration. The need for careful

and conservative use of water in order to delay as far as possible the time of the rise of the water table and also the need for providing artificial drainage on areas for which natural drainage is inadequate to keep the water well below the soil surface is not likely to be over-emphasized.

159. Reducing Evaporation. — The first and most important single step in reducing evaporation from irrigation soils is to keep the water table well below the land surface.

However, certain additional factors tend to favor excessive evaporation of which the following are noteworthy:

- (a) The flooding method of irrigation wetting the entire surface.
- (b) Unduly frequent irrigation, thus keeping the surface wet during a proportionately long time.
- (c) Direct exposure of the land surface to sunlight by lack of cropping.

Irrigating alkali land in furrows or corrugations is to be recommended after the soil has been flooded sufficiently to wash the excess soluble salts into the ground water and out through either natural or artificial drains. After irrigation by the furrow method, it is usually possible, without injury to the soil structure, to get onto the field with a harrow or other cultivating implement sooner than it is after irrigation by flooding. Moreover, furrow irrigation wets only from one-third to one-half the surface, whereas flooding wets the entire surface. It is essential to cultivate as soon as practicable after irrigation of furrow crops; otherwise, as found by Forbes in Arizona, the water that moves by capillary attraction from the furrows to the rows and there evaporates leaves harmful concentrations of alkali near the plants. Sub-irrigation under favorable soil formations has the advantage of avoiding direct wetting of the soil surface. This advantage, however, is usually made of negative value because sub-irrigation tends to build up and maintain a high water table, thus favoring excessive evaporation. As a rule, on all irrigated soils, it is good practice to apply enough water in a single irrigation fully to moisten the soil to the depth from which plant roots have taken the moisture previously in the soil. This depth ranges from 2 to 6 feet approximately, depending on the crop, and the texture and structure of the soil. In the management of alkali soils it is especially important fully to moisten the soil at each irrigation to the full depth that it needs additional moisture, in order to reduce the frequency of irrigation and thus reduce the amount of evaporation.

Providing an effective mulch by adding copious quantities of barnyard manure, straw, or other vegetative material does much to reduce evaporation. Manure is especially valuable in alkali land because of

benefits in addition to reducing evaporation. Retarding evaporation from alkali soils is urgently necessary. On soils slightly alkaline, it is well to maintain, in so far as practicable, a growing crop as a means of absorbing the water from the soil and of shading the soil, thus reducing evaporation.

160. Toxic Limits of Salts in the Soil. — The amounts of alkali that plants can endure vary widely. The kind of soil, the nature and age of the crop, the organic matter in the soil, the soil moisture content, the relative amounts of different salts — all these factors influence the toxicity of alkali crops. A detailed discussion of the question of toxic limits cannot be presented here. For the convenience of the student a few approximate figures on toxic limits are given. Quantities of soil alkali are usually reported as ratios of weight of alkali to the weight of dry soil. Some authors use the percentage ratio, but more commonly, because of the small fractional figures when using the percentage ratio, alkali contents are reported as parts per million. One per cent, i.e., 1 part per 100, is equivalent to 10 parts per 1000 and 10,000 parts per 1,000,000 (P.P.M.). It is rarely found that crops can thrive in the presence of 1 per cent, or 10,000 P.P.M., total alkali salts, especially if the more harmful sodium chlorides and carbonates predominate. Studying three sodium salts separately in sand, Harris found 1000 P.P.M. of NaCl or Na₂CO₃ the approximate toxic limit to wheat seedlings in sand, whereas in the same soil the wheat seedlings could endure 5000 P.P.M. Na₂SO₄. These toxic limits were greatly increased with increase in moisture content, reaching 5700 P.P.M. NaCl with 18 per cent moisture, 3300 P.P.M. Na₂CO₃ with 21 per cent moisture, and 16,000 P.P.M. Na₂SO₄ with 24 per cent of moisture.

Many experiments on toxic limits are summarized by Harris. These experiments include the growth of a large number of crops in water cultures, in sand, and in a loam soil.

161. Methods of Temporary Control. — Temporary control of alkali on irrigated land is sometimes practiced by one or more of the following methods:

- (a) Plowing alkali surface crusts deeply into the soil.
- (b) Removing surface accumulation from the soil.
- (c) Neutralizing the effects of certain salts by use of other salts or acids.

For detailed consideration of these methods the student is referred to "Soil Alkali" by Harris and to more recent literature on the topic.

162. Drainage for Permanent Relief. — Permanent reclamation of alkali land requires four essential steps, namely:

- (a) Adequate lowering of water table.
- (b) Washing excess salts out of the soil.
- (c) Assuring sufficiently rapid drainage after heavy storms and after the application of irrigation water.
- (d) Careful management of reclaimed land.

163. Adequate Lowering of Water Table. — All water-logged lands, whether or not impregnated with alkali, are improved for ordinary crops by lowering of the water table. This does not mean that the water table need be lowered only for a short time during the crop season — rather it means a permanent lowering by means under the farmer's control so that a rise of water above a given elevation in the soil for any length of time may be wholly prevented. The first step in lowering the water table is to learn the *source* of the water that caused it to rise. In isolated cases on small tracts it is sometimes possible for one farmer alone, or at most a small group of farmers, to find the water source and cut it off by construction of one or more intercept ditches. Usually, in irrigated regions, small water-logged areas are caused by water flowing to them from higher irrigated lands, above or under ground, or from canals, ponds, or reservoirs. The farmer whose holdings are located within large areas of comparatively level water-logged land cannot, as a rule, lower the water table economically by his own efforts. For such areas community action is essential to finance the necessary drainage structures and equitably to distribute the costs.

A few large open drains may suffice; open drain outlets with a network of covered tile drain lines may be required; whereas, in some localities, lowering of the water table may be accomplished effectively and economically by pumping water from the underground sources. During the last decade, extraordinary progress has been made in drainage of irrigated lands by pumping. The most notable advancement has been made by the Salt River Valley Water Users Association of Arizona, which in recent years has pumped more than 200,000 acre-feet of water annually as a means primarily of maintaining the water table low enough to prevent crop injury. The water so pumped has become a valuable asset for irrigation purposes.

164. Washing out Excess Salts. — Flooding water over the surface of alkali land is not an effective means of reducing the salt content of the soil. It is usually essential that large amounts of water be applied to alkali lands and made to percolate through the soil in order to leach away the excess salts. Coarse-textured soils of open structure as a rule have sufficiently high permeability to make leaching of excess salts a comparatively simple task after the water table has been sufficiently

lowered. Unfortunately, however, fine-textured compact soils of low permeability predominate in the low-lying water-logged areas. Consequently, permeability to water is a factor of paramount importance in the leaching of excess soluble salts from most water-logged soils. Permeability to water is influenced not only by the texture and compactness of the soil, but also by flocculation or dispersion of the soil particles. Recent studies have shown that the dispersion and consequently the permeability are greatly influenced by the use of certain chemical compounds. A very low permeability sometimes follows the leaching of alkali salts, and this decreases the productivity of the soil because of the difficulty of getting air and water to penetrate it.

165. Drainage After Storms or Irrigation. — Adequate soil permeability is essential not only to the washing out of excess salts, but also to getting rid of excess water immediately after heavy storms or irrigations. As shown in Article 148, the permeability of soils to water varies widely — much more than is recognized by the average irrigator. Table XXI gives the permeability and the specific conductivity of several soils.

166. Management of Alkali Land. — Sometimes irrigation farmers who own alkali land on which the water table has been adequately lowered, and from which the excess alkali salts have been leached, erroneously conclude that the task of reclamation has been completed. Complete reclamation is attained only when the lands are made to produce large crop yields annually. Usually the restoration of full productive capacity, or its establishment in case virgin alkali lands are under consideration, requires the utmost care in management after the drainage and leaching. Liberal applications of barnyard manure, plowing under of cover crops, avoiding of plowing or of other farm operations when the soil is too wet, extraordinary care in irrigation to avoid overcharging of drains or pumps and consequent rising of the water table, but still applying enough water to assure adequate penetration into heavy soils, keeping drains open and in good repair, prevention of excessive evaporation — these and other less important precautions are urgently essential to the management of alkali land in order to assure permanent relief from water-logging and excess alkali salts.

167. Alkali Water for Irrigation. — It is important to the student of irrigation that ultimately all the available water in the arid regions of the world will be used by man. Use of water for domestic purposes is of first importance, and next in importance is the use for irrigation. Proper quality of water is essential to satisfactory use for either of the above purposes. Already nearly 200 million acres of the world's land are being irrigated. Naturally the intensity of demand for water is now greater in some irrigated sections than in others, but in only a very few

of the arid regions of the world is the total water supply, when fully stored and controlled, large enough fully to irrigate all the arable land. In some sections, notably the Sevier River area in Utah, and parts of California, all the available water is now used. The so-called saturation point of irrigation expansion has now been reached.

As the saturation point in irrigation expansion is approached, the urge to use alkali water is naturally increased. However, excessive amounts of alkali in the irrigation water result only in fatality to crops and financial losses to water users. On the other hand, certain small amounts of alkali in water are not only harmless, but actually stimulate crop growth under some conditions. It is therefore obvious that a study of the safe limits of alkali in irrigation water, and of the conditions under which alkali water may best be used for irrigation, is essential to complete and intelligent utilization of arid-region agricultural resources.

168. Danger Limits of Alkali in Water. — It is impossible to say with precision what amount of alkali in irrigation water constitutes the danger limit. Some soil on which alkali water is used contains relatively large amounts of alkali before irrigation is begun — others are comparatively free at the outset. If all the alkali in the irrigation water were held in the upper few feet of irrigated soil it would be a simple matter to compute the amount of alkali added to the soil with each acre-foot of irrigation water and consequently the number of acre-feet that would bring the soil alkali content up to the toxic limits given in Article 160. However, under proper drainage conditions, the amounts of alkali absorbed by the soil are small in proportion to the total amounts applied in the water, especially if enough water is used to assure percolation through the soil and into the drainage water. Other variable factors, such as the kinds of crops grown, the amount and distribution of the rainfall, also influence the danger limit of alkali in irrigation water. The following observations of upper stage limits of alkali in water as summarized by Harris in his book "Soil Alkali" should therefore be interpreted as applicable to the conditions under which the observations were made rather than as general guides that apply with precision to all conditions.

"Hilgard states that although 685 parts per million (40 grains per gallon) of the common alkali salts should be the limit under most conditions, the *nature of the salts* will modify the limits considerably. As little as 342 parts per million of sodium carbonate has in some instances caused serious injury in three or four years, while as much as 2739 parts per million of the less toxic salts would not be harmful. From his work in California, Mackie states that where the salts are principally bicarbonate and chloride of sodium, irrigation water containing more than 600 to 700 parts per million of salt should not be applied except to

porous, well-drained soils. Guthrie considers 500 parts per million of sodium carbonate as a tolerable quantity of this salt even when as much as 150 parts per million of sodium chloride are also present.

“Where the salts are more of the sodium-sulphate type, larger quantities are permissible. Forbes states that with good drainage 1000 parts per million of salts in irrigation water is an objectionable but permissible degree of salinity for the soils of the Salt River, Arizona. In the Pecos Valley 2500 parts per million to 3000 parts per million of salts were considered the danger zone where about 50 per cent of the salts in the water were of sodium — mostly sodium chloride and sodium sulphate. Good drainage in the upper part of the valley makes possible the use of water of higher salinity than is possible in lower parts of valleys where the soil is heavier and likely to contain more alkali. Land, after being irrigated five years with water containing 3900 parts per million of salts, was abandoned because of the accumulation of alkali and seepage water.

“Experiments in Wyoming show that where only small quantities of water are added, practically all of the salts in the water are retained by the soil. Large quantities of water applied weekly or semi-weekly kept the salts moving downward continually. Means states that the Arabs in the Desert of Sahara raise good crops of dates, deciduous fruits, and garden vegetables when irrigated with water containing as high as 8000 parts per million of total salts, 50 per cent of which in some cases was sodium chloride. Such alkalinity, however, would not be permissible except with very resistant crops on light, sandy, or well-drained soils and where great care is given to keep the water from evaporating and concentrating the salts at the surface.

“Without special attention to drainage, a California soil irrigated with water containing 766 parts per million sodium chloride, 327 parts per million sodium carbonate, and 315 parts per million sulphates was proving injurious to an orchard after three years. Impervious clay soils might be injured with water too weak in alkali to have any noticeable effect on well-drained ones, because of the cumulative effect.

“Even in a soil with good drainage in Arizona, it was found that when water containing over 1000 parts per million of salts, two-thirds of which was sodium chloride, was applied, 50 to 60 per cent of the salts added in the water were retained by the soil or at least never appeared in the seepage water of the district. Soils flooded by sea water for 6 to 8 hours were found to contain 2000 parts per million of sodium chloride in the surface soil where unflooded land contained only 100 parts per million. However, in a drainage experiment on the Swan Tract, Utah, an alkali soil containing less than 3000 parts per million of salts in the upper 4 feet of soil, when flooded with water containing about 1500 parts per million of salts yielded drainage water containing over 11,000 parts per million of salts. The applications of water were large, sometimes as much as 16 inches being applied at one time, which makes a great difference in the retention of the salts by the soil. Hawaiian experiments with water containing 2000 parts per million of salts show that on a moderately porous soil there was very little accumulation of salt provided occasional heavy irrigation was given. Washing the salts out

of the soil occasionally with the relatively pure winter and spring waters has proved very beneficial to some alkali districts.

“In semi-arid sections, the salt content of irrigation water may be much higher than in the arid without causing trouble because the amount of water necessary to supplement the rainfall is smaller and the larger precipitation washes the salts out of the soil much more readily.”

169. Origin of Alkali in Water. — Alkali in irrigation water that is obtained from gravity canals originates in one or more of three sources, namely:

- (a) In the natural drainage water yielded by watersheds that contain large amounts of alkali in the soils and rocks; or
- (b) In the conveyance of rivers or canals through soil or rock formations that are highly impregnated with alkali; or
- (c) In the diversion of canals from the lower reaches of streams and rivers that receive large quantities of seepage and return flow from irrigated lands.

The amounts of alkali in natural drainage water near the stream sources are usually so small as to be of little concern. However, the Malad River in southern Idaho and northern Utah, a small stream, contains so large an amount of soluble salts that the use of its waters for irrigation early proved seriously harmful to trees and general farm crops. In the Uintah Basin, Utah, irrigation water that was almost entirely free from

TABLE XXIII

INCREASE IN THE SALT CONTENT OF THE WATER IN TYPICAL WESTERN RIVERS DUE TO SEEPAGE AND RETURN FLOW OF WATER FROM IRRIGATED LANDS, AS SUMMARIZED BY HARRIS

River	State	Salt Content P.P.M.		Increase P.P.M.	Distance in miles	Increase per Mile P.P.M.
		Upper	Lower			
Jordan	Colorado	110	1178	1068	20	53.4
	Utah	890	1970	1080	14	77.0
Sevier	Utah	205	831	626	60	10.4
Sevier	Utah	205	1316	1111	150	7.4
Pecos	New Mexico	760	2020	1260	30	42.0
Pecos	New Mexico	760	5000	4240	180	24.1
Arkansas	Colorado	trace	2200	2200	120	18.3

alkali at the diversion works absorbed excessive amounts of alkali as it was conveyed through canals constructed in beds of Mancos shale.

By far the greater and more dangerous source of alkali in irrigation water is from seepage and return flow. This fact is illustrated by a study of the alkali content of water at different points along rivers that traverse irrigated lands and receive return waters. Table XXIII reporting some determinations of total alkali salts in five western rivers at points separated from 14 up to 180 miles shows appreciable increases in alkali from the higher to the lower points. It will be noted that the maximum increase per mile, 77.0 P.P.M., occurred in the Jordan River, Utah, and the minimum in the Sevier River, also in Utah. It is apparent from these records that owners of irrigation projects that divert water from the lower reaches of streams that receive seepage and return flow from alkali lands should know the alkali content of the water used and if necessary take special precautions to avoid injury to crops and soils from this source of alkali.

The salt content of irrigation water in the several streams of the West varies appreciably from one part of the irrigation season to another, as is shown by the data of Table XXIV.

TABLE XXIV

SEASONAL VARIATION OF TOTAL SALT CONTENT OF TYPICAL WESTERN RIVERS.
AMOUNTS OF SALTS EXPRESSED AS PARTS PER MILLION OF WATER (P.P.M.)

Salt River, Arizona	P P.M.	Gila River, Arizona	P.P.M.	Sevier River, Utah	P.P.M.
Aug. 1-Sept. 1, '99.....	724	Nov. 28, '99-Jan. 18, 1900 . . .	1168	July 29	958
Sept. 2-Sept. 9, '99.....	1100	Feb. 1-Mar. 7, 1900	1136	Aug. 12.	1104
Sept. 10-Oct. 9, '99.	1142	Aug. 1-Aug. 14, 1900.	541	Aug. 24.	1268
Oct. 10-17, '99.....	952	Aug. 15-Aug. 28, 1900.....	925	Sept. 18.....	1190
Oct. 18-Dec. 30, '99.....	1026	Sept. 1-Sept. 28, 1900	471	Sept. 21.....	1426
Feb. 17-May 30, 1900.....	1089	Sept. 29-Nov. 5, 1900.	1085	Oct. 5	1406
June 1-Aug. 4, 1900.....	1391			Oct. 19.....	1436
				Nov. 9.	1376

REFERENCES

- BLOODGOOD, DEAN W. Drainage in the Mesilla Valley of New Mexico, New Mexico Agr. Exp. Sta. Bul. 129. 1921.
- BOTKIN, C. W. A Study of Alkali and Plant Food Under Irrigation and Drainage, New Mexico Agr. Exp. Sta. Bul. 136 (technical). 1923.
- BURGESS, P. S. Alkali Soil Studies and Methods of Reclamation, Arizona Agr. Exp. Sta. Bul. 123. 1928.
- DE'SIGMOND, DR. ALEXUIS A. J. Hungarian Alkali Soils and Methods of Their Reclamation, California Agr. Exp. Sta. Special Publication. 1927.

- GARDNER, WILLARD, and HARRIS, EVAN. Effect of Replaceable Sodium on the Physical Character of Alkali Soils, Reprint, Utah Academy of Sciences Proceedings. 1930.
- HARRIS, FRANKLIN STEWART. Soil Alkali — Its Origin, Nature and Treatment, John Wiley & Sons, Inc. 1920.
- JOHNSTON, W. W., and POWERS, W. L. A Progress Report of Alkali Land Reclamation Investigations in Eastern Oregon, Oregon Agr. Exp. Sta. Bul. 210. 1924.
- KELLEY, W. P., and THOMAS, E. E. Reclamation of the Fresno Type of Black Alkali Soil, California Exp. Sta. Bul. 455. 1928.

CHAPTER XII

TRANSPIRATION AND EVAPORATION

Water is essential to all life processes, both in animals and in plants. In the production of farm crops, *efficient* use of water by the crops is everywhere important. The humid-climate farmer depends on the water stored in his soil and on the crop season rainfall as sources of water for his crops. Not infrequently his production is limited because of insufficient water during critical periods. Of even greater importance is the efficient use of water in arid regions, where, under dry farming, water is available in relatively small amounts at best, and under irrigation its efficient use is vital to the fullest utilization of the available arable lands.

This chapter is devoted primarily to a consideration of the efficient use of water by individual plants. In agriculture under irrigation the plant is but one of several consumers of water. Others are: the crop as a whole, including the use by the sun and the wind; the irrigator; and the irrigation company that conveys water. The efficiency with which the various consumers use water ultimately determines the combined efficiency in its use and influences greatly the economy of arid-region agriculture. The terms efficiency and economy have specific meanings; they are not synonymous. The definitions in the following sections clarify the points of difference.

170. Transpiration Defined. — During the growing period of a crop there is a continuous movement of water from the soil into the roots, up the stems, and out of the leaves of the plants. This important process is known as plant transpiration. The stream of water thus moving acts as a carrier of essential plant food substances from the soil to the various parts of the plant. The velocity of the water flowing through the plant varies ordinarily from 1 to 6 feet per hour; but, under conditions of unusually high temperature, dry atmosphere, and wind, the velocity of the stream may be greatly increased. The process of transpiration is vitally essential to plant life. A very small proportion of the water absorbed by the roots is retained in the plant, but to the irrigation farmer the velocity of water flow through the plant and the amount of water that annually evaporates from the leaf surfaces are of special importance. If the quantity of water that flows through the

plant and is evaporated at the leaves is greater than the quantity absorbed by the roots, wilting occurs and the normal growth of the plant is impeded. On the other hand, if the conditions are such as to favor or stimulate excessive transpiration without also conveying substantial amounts of plant food substances into the plant and also favoring rapid manufacture of food in the plant leaves, the available water is not used efficiently. That plant growth is not necessarily proportional to transpiration is of fundamental importance to arid-region agriculture.

171. Transpiration Ratio. — The ratio of the weight of water that is absorbed by, conveyed through, and transpired from the plant, to the weight of dry matter produced by the plant is defined as the *transpiration ratio*. The water which evaporates from the soil in which the plant grows is not included in the transpiration ratio. Dry matter is that part of the plant which remains when all the water has been driven from the plant by heat. In determining the weight of dry matter it is customary to use only those parts of the plants which are harvested. For example, the roots and the vines of potatoes, the leaves of sugar beets, the roots of grain plants such as wheat, oats, barley, rye, and the roots of forage crops are excluded. There are, of course, exceptions to this general rule. In some investigations the entire plant — roots, stems, leaves, seed and all — is used. Unless otherwise stated, it will be understood in this chapter that only the plant parts ordinarily harvested are included. Unfortunately, some reports of transpiration ratio studies are not specific as to the parts of plant used in arriving at the weight of dry matter. In the study of transpiration ratio of grains, for example, it is desirable to report the ratio for grain alone since the straw has relatively small value. To make transpiration ratio comparisons reliable it is clearly essential that the basis of computations be fully given. Transpiration ratios as a rule are determined by growing plants in large tanks or cylinders filled with soil. In some experiments the tanks are weighed at frequent intervals to determine the amount of water transpired; in others an artificial water table is kept at a given elevation and the water transpired is measured indirectly by measuring the amount necessary to maintain the water table at a constant elevation. Some experimenters have devised special means of preventing evaporation losses; others have estimated evaporation losses from the tanks in various ways and deducted the estimated evaporation losses from total losses to arrive at the amounts transpired. All experimenters using tanks have prevented deep percolation losses. The transpiration ratio ranges from less than 200 to more than 1000 pounds of water for each pound of dry matter produced. Some results of transpiration

ratio measurements by different investigators are presented in Table XXV.

TABLE XXV
TYPICAL RESULTS OF TRANSPIRATION RATIO MEASUREMENTS

Crops	Investigators and Locations			
	Briggs and Shantz, Colorado	Leather, India	Thom and Holtz, Washington	Widtsoe, Utah
<i>Forage:</i>				
Alfalfa.....	1068	446
Clover.....	709	484
Rape.....	441
<i>Grains:</i>				
Barley.....	539	468	320
Corn.....	369	337	249	386
Oats.....	614	469	352
Rye.....	824
Wheat.....	507	554	432	546
<i>Root Crops:</i>				
Potatoes.....	448	167
Sugar beets.....	377	262	497
Onions.....	235
<i>Miscellaneous:</i>				
Peas.....	800	563	420	843
Sorghum.....	240

172. Variability and Usefulness.— The transpiration ratio is influenced by many variables, such as the soil, the climate, and the amount of water in the soil; and it is therefore naturally a variable quantity. There is no such thing as a definite constant transpiration ratio for any plant. Nevertheless, the transpiration ratio is a valuable measure of the relative efficiencies with which plants use water under different treatments. Because of the changed soil conditions, the small volume of soil in tanks, the more definitely controlled moisture conditions, and the variability in exposure of the plant itself to the air, sunshine, and heat, it is doubtful if transpiration ratios determined in tanks can be relied on as precise measures of the transpiration ratio of the same plants under field conditions. Yet the transpiration ratio, as measured in tanks, is a valuable basis for *approximations* of the water requirements of field crops in so far as these requirements are influenced by plant activi-

ties. However, of even greater value are the general rules or laws concerning the relative efficiency of the use of water by plants, now apparently well established by the transpiration ratio experiments thus far conducted. These several laws are stated in the following articles together with the bearing of some of the more extensive transpiration studies on each law. First, however, to show more clearly how the results of transpiration ratio studies give relative plant efficiencies in the use of water, the expression "transpiration efficiency" is defined and its relation to the transpiration ratio considered.

173. Transpiration Efficiency. — In the use of electrical power to drive motors, or the use of motors to drive pumps or other mechanical devices, as noted in Chapter IV, it is both possible and practical to define efficiency with reference to a definite standard of attainment. For example, if an electrical motor that is consuming 10 electrical horse power is delivering to its shaft 9 mechanical horse power, the motor delivers nine-tenths of the power it consumes and therefore has an efficiency of 90 per cent. The above example is typical of mechanical or physical efficiency, which is defined as the ratio of power output to power input. In the growth of plants it is clear that a different reference base is necessary with which to define transpiration efficiency. The input to the plant includes energy from the sun, oxygen and carbon from the air, mineral plant food and water from the soil. The special interest of arid-region agriculturists is to attain those conditions of sunshine, air, and soil that will give the maximum production of plant dry matter per unit quantity of water transpired. The transpiration efficiency, which is a biological rather than a physical concept, is here defined as the ratio of the plant dry matter produced (the output) to the water transpired (the input). The transpiration efficiency in per cent is therefore expressed mathematically as

$$E_t = 100y_d/T \dots \dots \dots (51)$$

in which

- E_t = transpiration efficiency in per cent.
- y_d = the weight of dry matter plant yield.
- T = the weight of water transpired.

The transpiration ratio is an inverse measure of transpiration efficiency. When the transpiration ratio is 100 the transpiration efficiency is 1 per cent; and when it is 1000 the transpiration efficiency is $\frac{1}{10}$ per cent. The transpiration efficiency as a general rule lies between the limits of $\frac{1}{2}$ and $\frac{1}{10}$ per cent. It may be lower — it is seldom if ever higher in arid regions. The numerical relation between transpiration

TABLE XXVI

RELATION OF TRANSPIRATION RATIOS, TRANSPIRATION EFFICIENCIES, PLANT DRY MATTER PRODUCED PER UNIT VOLUME OF WATER, AND UNIT VOLUMES OF WATER TRANSPIRED PER TON OF PLANT DRY MATTER

Transpiration Ratio	Transpiration Efficiency Per Cent	Plant Dry Matter Produced per Unit Volume of Water Transpired Tons per Acre-inch	Water Transpired in Production of Plant Dry Matter Acre-inches per Ton
100	1.00	1.135	0.88
200	0.50	0.568	1.76
300	0.33	0.380	2.63
400	0.25	0.284	3.52
500	0.20	0.227	4.41
600	0.17	0.189	5.29
700	0.14	0.162	6.18
800	0.12	0.142	7.05
900	0.11	0.126	7.94
1000	0.10	0.113	8.85
1100	0.090	0.103	9.70
1200	0.083	0.094	10.62
1300	0.077	0.087	11.50
1400	0.071	0.081	12.35
1500	0.067	0.076	13.15
1600	0.062	0.071	14.10
1700	0.059	0.067	14.90
1800	0.055	0.063	15.86
1900	0.052	0.060	16.70
2000	0.050	0.057	17.55

ratios and efficiencies over a wide range of variation is given in columns 1 and 2 of Table XXVI. The number of tons of dry matter produced per acre-inch of water transpired, corresponding to different transpiration efficiencies, is given in column 3, and the acre-inches of water transpired per ton of dry matter are given in column 4.*

* At this point it may be difficult for the student to see clearly the purpose in proposing the new concept of the transpiration efficiency. The discussions in Chapter XIV of the consumptive use efficiency, and in Chapter XVIII of farm irrigation efficiency and water conveyance and distribution efficiency, and finally, the consideration of the meaning and magnitudes of these several efficiencies combined clarify the purpose.

174. Factors Influencing Transpiration Efficiency. — Two classes of factors are known to influence transpiration efficiency, namely: (1) climatic factors, including temperature, atmospheric humidity, wind intensity and frequency, and rainfall; and (2) available plant food and the moisture content of the soil, together with the nature and the vigor of the plant produced.

The first class of factors is largely beyond the control of man. Regardless of climatic conditions, plants must be grown where fertile soils and water are available, even though, as is now well understood, the transpiration efficiency is relatively low in arid regions. For details concerning the influence of climatic and other non-controllable factors on E_t , the student is referred particularly to the work of Briggs and Shantz, and Thom and Holtz. Results of experiments concerning the influence of the important controllable factors are given in the following sections.

175. Available Plant Food. — An abundance of readily available plant food increases the transpiration efficiency. Widtsoe found that the application of small amounts of commercial fertilizers to moderately fertile soils increased the transpiration efficiency from 0.157 to 0.422 per cent. On a poorly productive sand the transpiration efficiency was increased from 0.100 to 0.218 by addition of fertilizers, and on a poor clay from 0.076 to 0.225. The transpiration efficiency was not changed by adding fertilizers to Utah soils of a high productive capacity. Working in India, Leather found as an average of many tests that the transpiration efficiency for unmanured soils was 0.128, and for manured soils it was 0.175. Bouyoucus, working in Minnesota, and Thom and Holtz in the state of Washington, have confirmed the general result that readily available plant food increases transpiration efficiency. In Nebraska, Kiesselbach found that an application of sheep manure to an infertile soil increased the transpiration efficiency to a much more marked extent than when applied to a fertile soil.

It is important in this connection to note that an increase in transpiration efficiency is not necessarily indicative of a decrease in the quantity of water needed per acre of crop. Indeed, the reverse condition probably follows. Fertile soils support more rapid and luxuriant growth of crops than infertile soils and thus actively require more water per acre even though the transpiration efficiency is relatively high.

176. Soil Moisture Content. — In 1913, Briggs and Shantz reviewed the results of a large number of transpiration experiments to ascertain the influence of the soil moisture content on the transpiration ratio. In general, the results showed an increase in transpiration ratio, or a decrease in transpiration efficiency, as the soil moisture content approached either extreme. However, these investigators pointed out

certain indirect factors that might have influenced the experimental results and concluded that the direct influence of the soil moisture content on the transpiration (ratio) efficiency could not be established without further study.

Kiesselbach found in Nebraska, as a result of work from 1912 to 1914, that reduction of soil moisture below the optimum slightly increased the transpiration efficiency, and that an increase in soil moisture above the optimum decreased the efficiency. However, in both cases the extreme soil moisture conditions were accompanied by a substantial decrease in stalk yield.

Thom and Holtz, as reported in 1917, conclude that "the percentage of capillary saturation of the soil in which plants are grown is not an important factor in the water requirement (transpiration efficiency) of plants, provided the percentage of moisture is maintained considerably above the wilting point."

These investigators conclude further that "any condition which disturbs the normal life processes, be it soil, atmospheric, or pathological, increases the water requirement to just such a degree as it depresses the normal functionings of the plant."

Widtsoe concluded that within the limits of practical irrigation, the transpiration ratio increases (or the transpiration efficiency decreases) as the quantity of water added to the soil increases.

The present status of research concerning the influence of soil moisture on transpiration efficiency seems to justify fully the conclusion that irrigation farmers may well guard against long-time duration of either extreme in moisture content. By the very nature of irrigation farming, irrigation soils must be relatively wet shortly after irrigation and relatively dry shortly before irrigation. Certain variations in moisture content are inevitable, but long-time durations of either extreme in moisture content can usually be avoided.

177. The Nature of the Plant. — There seem to be well-established differences in the transpiration efficiencies of different plants. These differences, however, as reported by Briggs and Shantz, are sometimes unavoidably influenced by differences in (1) method of experiment, (2) the amount of plant food available, (3) the period when the crop was grown, and other experimental difficulties. Under dry farming practice, especially where the annual rainfall is very low, it is desirable to select plants very carefully on the basis of transpiration efficiency; but under irrigation practice where there are so many additional conditions influencing the irrigation efficiency, as shown in Chapter XVIII, the selection of plants on the basis of transpiration efficiency is relatively impracticable.

178. Vigor of the Plant. — It is a general rule, to which there are but few exceptions, that profits in the production of farm crops and the growth of farm animals are most likely assured by vigorous growth of crops and large yields and also vigorous growth of animals and early maturity. Widtsoe has well stressed the importance of vigor of the plant in irrigation farming in the following language:

“Whenever the seasons, the nature of the soil, the available plant-food, the treatment of the soil, the factors above discussed, favor vigorous plant-growth, they also tend to diminish the quantity of water required for the production of one pound of dry matter. That is, so far as these factors are concerned, as the plant becomes more and more thrifty the smaller becomes the transpiration ratio.”*

The more vigorous a plant becomes, the more efficiently it can use the water available.

179. Evaporation. — Where irrigation water is applied by the flooding methods and the entire soil surface is wetted, large amounts of water are lost by direct evaporation from the soil during the first few days after irrigation. The term *direct evaporation* signifies the water which is evaporated from the soil without passing through the roots, stems, and leaves of the plants. Some authorities speak of transpiration as evaporation from the plant leaves. This interpretation of transpiration has some justification; however, not all the evaporation from leaf surfaces results from transpiration. After light showers during the growing season, the water lost by direct evaporation from the leaf surfaces and from the ground surface serves little, if any, useful purpose. Similarly, the water lost by direct evaporation from the ground surface after irrigation serves no useful purpose. It should therefore be reduced as much as possible by practical means.

180. Reducing Evaporation. — Many experiments have been conducted both in humid regions and in arid regions concerning the effect of cultivation on direct evaporation of water from soils. There are now rather decided differences in opinion among research workers concerning the influences of cultivation on evaporation.

Several of the outstanding American pioneer irrigation research workers, notably King of Wisconsin, Fortier of the United States Department of Agriculture, and Widtsoe of Utah, found that evaporation could be greatly decreased by the formation of an earth mulch through cultivation. The early belief that the upward flow of capillary water was very great and that a blanket of cultivated dry soil would check it, has been widely accepted and commonly taught.

* Principles of Irrigation Practice, by Widtsoe. The Macmillan Co.

In 1917, Call and Sewell pointed out the fact that many of the experiments that show saving of water through cultivation were conducted on field soils having a shallow water table, or with soil columns in a laboratory where the soil was either saturated at the outset or kept in contact with free water. Harris and Turpin, Alway and McDole, Willard and Humbert, and McLaughlin have conducted experiments on moisture movement under conditions quite independent of free water or of a water table, and have found a relatively slight movement vertically upward. Later Veihmeyer conducted extensive and detailed studies on the influence of cultivation on evaporation losses from soils not in con-

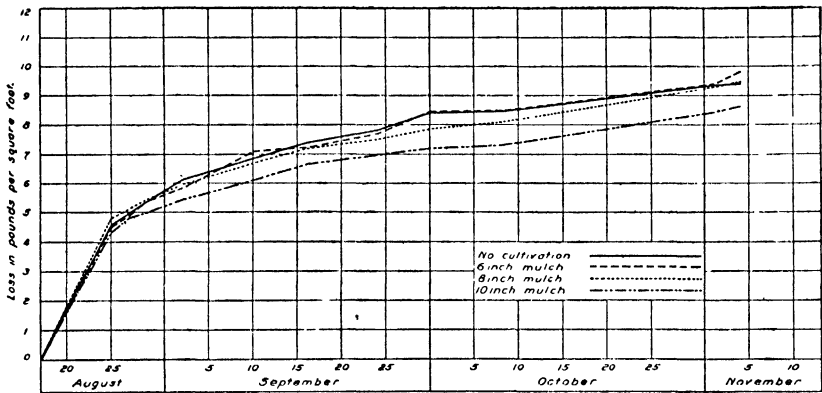

FIG. 108. — Loss of water by evaporation directly from the surface of bare soils in tanks at Mountain View. (Calif. Agr. Exp. Sta. Hilgardia Vol. II No. 6, 1921.)

tact with free water. Evaporation losses from tanks treated in four different ways are presented in Fig. 108, which shows that the losses from tanks not cultivated and from those cultivated to a depth of 6 inches are practically identical. The 8-inch depth cultivation shows slight decreases, and the 10-inch depth cultivation slightly greater decreases.

Based on these experiments and other similar ones, Veihmeyer concluded that cultivation did not influence the losses of moisture by evaporation from the bare surfaces of the soils in the tanks and in the field plots under observation.

Shaw studied the influence of the soil mulch in the laboratory and concluded that:

“The soil mulch can reduce the loss of soil moisture only when the water table, perched or permanent, is within capillary rise of the surface.”

The recent studies, mentioned very briefly above, seem to throw considerable doubt on the advantages of soil mulches for conserving water

through reduction of evaporation losses from soils that are not excessively wet or in contact with a water table at a shallow depth.

Broad general conclusions concerning the influence of cultivation on direct evaporation losses from soils may be misleading. The large number of variable factors involved — notably the differences in distances to free water sources, in original moisture content of unsaturated soils, and in texture, structure, and specific water conductivity — make it hazardous to generalize.

So far as the author is aware, none of the experiments concerning the effect of cultivation and of mulches on the flow of water vertically upward through the soil have been accompanied by measurements of potential gradients or of specific water conductivity of the soils.

In the case of soils far removed from a water table or similar source of water supply, movement from moist deep soils up to dry shallow soils gradually decreases the magnitude of the potential gradient, thus decreasing the rate of flow. Furthermore, in all probability the specific conductivity also decreases as the soils become drier. It is possible that future experimenters on this problem will measure the potentials at different points and thus be able to evaluate the specific water conductivity under different conditions.

181. Vegetative Mulches. — Where water is very costly, direct evaporation is sometimes reduced to a minimum by covering the land with a deep layer of straw, or other inexpensive similar material. This method of reducing direct evaporation losses is conveniently used in orchards that are irrigated by the basin method. It is limited in application both because of the lack of available material with which to form vegetative mulches and the cost of providing mulches of this kind. However, vegetative mulches are effective in greatly reducing evaporation. They have also the advantages of adding organic matter to the soil.

182. Evapo-Transpiration Ratio. — If it were possible to produce crops under irrigation without sustaining any loss of water from the soil surface by direct evaporation, smaller quantities of irrigation water would be needed. However, in general irrigation practice some loss of water by evaporation is inevitable, and hence the practical measure of effective use of water, after it has been stored in the soil, is the ratio of the sum of the weights of water transpired by plants and directly evaporated from the soil, to the weights of dry plant substance produced. This ratio has been designated by Widtsoe as the *evapo-transpiration ratio*. It is apparent that as the seasonal direct evaporation is decreased the magnitude of the evapo-transpiration ratio approaches that of the transpiration ratio. Widtsoe found evapo-transpiration ratios ranging under normal conditions from 250 to 1000. A new expression

which has recently come into rather wide usage in irrigation regions, namely, the consumptive use of water, though not identical in meaning with the evapo-transpiration ratio, is closely related to it. The consumptive use of water in irrigation is considered in Chapter XIV.

REFERENCES

- ALWAY, F. J., and MCDOLE, G. R. Relation of Movement of Water in a Soil to its Hygroscopicity and Initial Moistness, *Jour. Agr. Res.*, **10** : 391-428. 1917.
- BRIGGS, L. J., and SHANTZ, H. L. The Water Requirements of Plants, U. S. D. A., Bur. Plant Ind. Buls. 284 and 285. 1913.
- BRIGGS, L. J., JENSEN, C. A., and McLANE, J. W. The Mulched-basin System of Irrigated Citrus Culture and its Bearing on the Control of Mottle-leaf, U. S. D. A. Dept. Bul. 499. 1917.
- CALL, L. E., and SEWELL, M. C. The Soil Mulch, *Jour. Am. Soc. Agron.*, **9** : 49-61. 1917.
- CONRAD, J. P., and VEIHMEYER, F. J. Root Development and Soil Moisture, *Hilgardia*, **4** : 113-134. May, 1929.
- HARRIS, F. S., and TURPIN, H. W. Movement and Distribution of Moisture in Soil, *Jour. Agr. Res.*, **10** : 113-153. 1917.
- HARRIS, F. S., and YAO, H. H. Effectiveness of Mulches in Preserving Soil Moisture, *Jour. Agr. Res.*, **23**, No. 9 : 727-742, Figs. 5. 1923.
- KIESSELBACH, T. A. Transpiration as a Factor in Crop Production, *Nebraska Agr. Exp. Sta. Research Bul. No. 6*. 1916.
- KING, F. H. Soil Management, Orange Judd Co., New York, 1-303. 1914.
- MCCALL, M. A. The Soil Mulch in the Absorption and Retention of Moisture, *Jour. Agr. Res.*, **30**, No. 9 : 819-831. 1925.
- McLAUGHLIN, W. W. Capillary Movement of Soil Moisture, U. S. D. A. Bul. 835 : 1-69. 1920.
- RICHARDSON, A. E. V. Trans. Ratio of Wheat at Different Stages of Growth, *Australian Assoc. Adv. Sci. Rpt.* 17. 1924.
- SHAW, CHAS. F. When the Soil Mulch Conserves Moisture, *Jour. Am. Soc. Agron.*, **21**, No. 12. 1929.
- SMITH, ALFRED. Effect of Mulches on Soil Temperatures During the Warmest Week in July, 1925, *Hilgardia*, **2**, No. 10 : 385-397. 1927.
- THOM, C. C., and HOLTZ, H. F. Factors Influencing the Water Requirements of Plants, *Wash. Agr. Exp. Sta. Bul.* 116. 1917.
- VEIHMEYER, FRANK J. Some Factors Affecting the Irrigation Requirements of Deciduous Orchards, *Hilgardia*, **2**, No. 6. 1927.
- WIDTSOE, J. A. The Production of Dry Matter with Different Quantities of Irrigation Water, *Utah Agr. Exp. Sta. Bul.* 116. 1916.

CHAPTER XIII

TIME OF IRRIGATION

Two major considerations influence the time of irrigation, namely: (a) the water needs of the crops; and (b) the availability of water with which to irrigate. The water needs of the crop are of paramount importance in determining the time of irrigation during the crop-growing season on irrigation projects which obtain their water supplies from storage reservoirs or from other dependable sources of water that are free from wide fluctuations. Many irrigation farmers, however, obtain water from streams that fluctuate widely during the season. Some irrigated areas have a deficient water supply during the irrigation season, but an abundance of water during the late autumn or winter and early spring. Irrigation farmers cannot therefore always apply water when the crop is most in need of it; sometimes, to save the water, they must apply it even though the crop does not need it. Both crop needs and available water supply must be considered in a discussion of the proper time to irrigate.

183. Crop Needs. — Growing crops use water continuously. The rate of use of water by crops varies with the kind of crop grown, age of the crop, the temperature, the atmospheric conditions — all variable factors. It is obviously impracticable to supply water by irrigation at the same rate each day as it is used by crops. Therefore, it is essential in irrigation farming to use the soil as a storage reservoir for water. At each irrigation a quantity of water sufficient to supply the needs of the crop for a period varying from a few days to several weeks is stored in the soil in the form of capillary water.

As explained in Chapter IX, the capacity of fine-textured soils to retain water in general exceeds the capacity of coarse-textured soils. The depth of soil likewise greatly influences its capacity for water. Clearly, therefore, in order to keep a crop abundantly supplied with water at all times during its growth, coarse-textured, shallow soils must be irrigated more frequently than fine-textured, deep soils. How frequently the water should be applied to soils of different properties in order best to supply the crop needs is a question of unusual interest and also of real practical significance. The factor of major importance in arriving at the desirable frequency and time of irrigation is the water need of the crop.

184. Limiting Soil Moisture Conditions. — The growth of most of the crops produced under irrigation farming is stimulated by moderate quantities of soil moisture and retarded by excessive or deficient amounts. A certain quantity of air in the soil is essential to satisfactory crop growth; hence, excessive flooding and filling the soil pore spaces with water, thus driving out the air, inhibits proper functioning of the plants even though it supplies an abundance of available water. On the other hand, soils having deficient amounts of water hold it so tenaciously that plants must expend extra energy to obtain it; and slight further decrease in the water supply decreases the moisture content until the rate of absorption is not high enough to maintain turgidity, and permanent wilting follows. At some soil moisture content between these two extreme moisture conditions it has been thought that plants grow most rapidly; this content has been designated the *optimum* moisture percentage.

Extending our knowledge of these two limiting soil moisture conditions, i.e., the permanent wilting percentage and the optimum percentage, has been the objective of considerable research in recent years. Because of the wide variations in the physical properties of different soils it is easy to understand that the moisture percentage in a clay soil at permanent wilting of a plant may be several times the moisture percentage in a sandy soil when the same plant wilts permanently. A question that is not so easily understood is this: In a particular soil do all plants wilt at about the same moisture percentage? In other words, is there a critical moisture percentage (or narrow zone of moisture content) at which potatoes, beets, alfalfa, grains, and all other standard crops wilt in spite of variations in sunshine, wind, atmospheric humidity, and so on? Extended investigations by Briggs and Shantz led to the conclusion that nearly all plants wilt at substantially the same moisture percentage in a particular soil. More recently, Powers observed in Oregon a variation in the wilting point from 16 per cent moisture for clover to 17.5 per cent for potatoes and 20.3 per cent for sugar beets, all in the same soil. Powers concluded that the wilting point of different crops varies more than has formerly been supposed, particularly in fine-textured soils. Despite some limitations to the conclusion reached by Briggs and Shantz, for the purposes of this chapter it is satisfactory to assume that the wilting moisture percentage for all plants in a given soil is substantially the same.

Of equal interest and importance is the so-called optimum moisture percentage. As the moisture percentages increase above the wilting point (or zone), does the growth rate of crops increase appreciably until the optimum is reached and then decrease until the field capillary water capacity is reached; or is the growth rate substantially the same within

a wide range of moisture content from a point slightly above wilting to the field capillary water capacity?

The probable influence of variation in moisture percentage on the rate of growth of plants, based on the results of recent research, is illustrated in Fig. 109. The heavy-line curve of Fig. 109 represents roughly the change in rate of growth of crops as the moisture percentage of the soil increases from the wilting content to the saturation content. It has been thought that the maximum growth rate of plants occurs at rather definite moisture percentages. Recent investigations by the California Agricultural Experiment Station substantiate the belief that these processes occur within certain zones of moisture percentage. Hendrickson and Veihmeyer found that the rates of growth of peaches were not decreased by change in moisture content until it was reduced

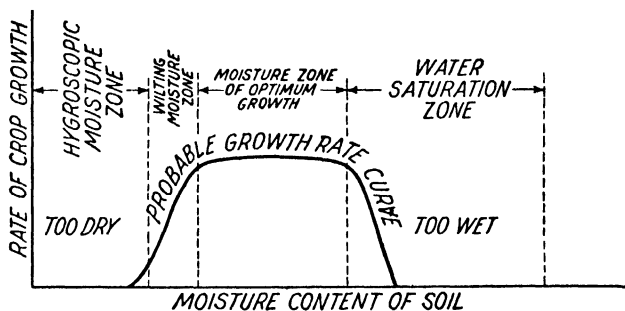

Fig. 109. — Illustrating the probable growth rate of crops as influenced by different amounts of moisture in the soil.

to about the permanent wilting percentage. Further information substantiating the findings of Hendrickson and Veihmeyer is presented in Article 188 in connection with a discussion of the wilting point of plants.

185. Water Need Indicators.— The need for irrigation water is commonly determined by two major indicators, namely, the appearance of the growing crop and the amount of available water in the soil.

186. Appearance of Crop.— A light green color in alfalfa is generally indicative of adequate moisture and satisfactory growth, whereas a dark green color indicates lack of adequate moisture. Among the root crops, sugar beets indicate need for water by temporary wilting, particularly during the warmest part of the day. Grain crops also indicate need for water by temporary wilting. In the production of fruit crops, as a rule, it is impractical to detect the need of water by the appearance of the leaves of the trees. Serious retardation in growth rate sometimes occurs

before the leaves indicate clearly a need for water. It is therefore more essential to base the time of irrigation of orchards on observations of the moisture content of the soil. Indeed, to a lesser degree, the use of any crop as an indicator of the need for irrigation water is open to the same objection that applies to its use in fruit production. Crop growth should not be retarded by lack of available soil moisture; and the practice of withholding irrigation until the crop definitely shows a need for water is very likely to retard the growth rate of the crop.

187. Available Water in Soil. — It is well known that only part of the water in soils is available to plants. As a general rule, it is essential to maintain readily available water in the soil as long as it is desired to have crops make satisfactory growth. The water that is held by a soil after permanent wilting of plants is designated as unavailable water. In coarse-textured soils the quantity of unavailable water is quite low, from 1 to 3 per cent of the weight of dry soil, whereas in a very fine-textured soil it is sometimes as high as 20 per cent. Briggs and Shantz found that the wide variations in the amount of unavailable water to a particular plant in different kinds of soil made the slight variations, due to the different capacities of plants to absorb water, quite insignificant. For the purposes of using the soil moisture content as an index of when irrigation is necessary, the variations in amounts of unavailable water are of major importance.

188. Wilting Moisture Percentage. — The moisture percentage held by the soil after permanent wilting of plants is known as the wilting point, or the wilting coefficient. Briggs and Shantz found a fairly definite relation between the moisture equivalent of all soils and the wilting coefficient. More recent investigations by Veihmeyer and Hendrickson indicate rather wide departures from the Briggs and Shantz finding that the wilting coefficient is equal to the ratio of the moisture equivalent to the number 1.84. In order to make effective use of the moisture content of a soil as guide to proper time to irrigate, it is clearly essential to know approximately the wilting point of the soil considered. Computations of wilting points from moisture equivalent determinations are only approximate guides, and should be used with caution and replaced by direct determinations of wilting points where possible. Veihmeyer and Hendrickson found variations in the ratio of moisture equivalent to the wilting point ranging from 1.73 to 3.82. They reached the conclusion that the ratio 1.84 recommended by Briggs and Shantz may not be used for all soils, "because it seems that plants are able to reduce the moisture content of different soils to different degrees of dryness before the stage of permanent wilting is reached." Wilting under *field conditions* probably occurs within a certain restricted zone or range of moisture content,

rather than at a precise moisture percentage. Knowledge of what is the upper limit of the wilting zone for a particular soil is of major practical importance in irrigation. Hendrickson and Veihmeyer are authority for the statement that plants do obtain some water from the soil below the permanent wilting percentage but that the rate at which they can obtain it is not high enough to enable the plant to remain turgid. It therefore follows that the water below the permanent wilting percentage is not readily available.

189. Growth Rate for Moisture above the Wilting Zone. — Recent studies of soil moisture and plant relations seem to warrant the conclusion that the growth rate of plants is not reduced by lack of water so long as the soil moisture content is above the wilting zone. This conclusion is contrary to the belief that the maximum rate of growth occurs at the so-called optimum moisture content and that it decreases for moisture percentages either higher or lower.

The field experimental work of Hendrickson and Veihmeyer with peaches in San Joaquin Valley, California, led them to conclude that the "permanent wilting percentage is a critical soil moisture content," and "that trees either *have* readily available moisture or *have not*."

Studies by Shull concerning the variation of the force by which water is held by the soil as the moisture content varies support the conclusions reached by Hendrickson and Veihmeyer. At moisture contents above the

wilting point, Shull found that a large change in water content causes but a slight change in the magnitude with which the water is held by the soil. At moisture contents below the wilting point, however, a slight change in the moisture content very greatly changes the force with which the water is held. Shull's findings are confirmed by the work of Thomas on aqueous vapor pressure of soils. In a study of plant and soil relations at and below the wilting percentage Magistad and Breazeale confirm the results of the work by Shull and Thomas. Fig. 110 shows relatively little decrease in suction force as the moisture content increases from the

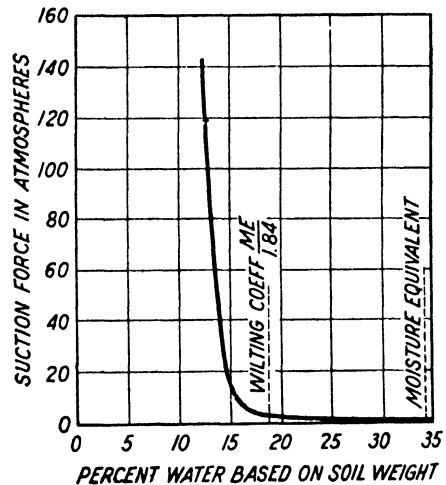

Fig. 110. — Showing force with which water is held in a silty clay loam with varying moisture per cents. (Ariz. Agr. Exp. Sta. Tech. Bul. 25.)

wilting point, about 19 per cent, to the moisture equivalent, about 34 per cent. It therefore seems reasonable to believe that the growth rate of crops, so far as it may be influenced by moisture content of the soil, would not change appreciably as the moisture equivalent which represents approximately the field capillary water capacity.

As yet, experimental data reporting the moisture percentages of different field soils at permanent wilting are comparatively meager. Some approximations and some fairly definite determinations are given in the next article.

190. Moisture Needs of Different Soils. — Working on the sandy loam of the New Mexico Station farm, Tinsley found, according to Thompson and Barrows, that plants do not suffer when the average moisture content of the upper 6 feet of soil falls to 7 per cent. The changes in moisture content during a period of 10 days after irrigation in the first, third, and fifth foot-sections of two plots studied by these investigators are presented in Figs. 111 and 112. Both plots produced alfalfa, the crop in plot 24 (Fig. 111) was not cultivated; that in plot 30 (Fig. 112) was cultivated. Both plots were given 3-inch irrigations; the average seasonal depth on plot 24 during the years 1916-18 inclusive (in which moisture determinations were made) was 47 inches and on plot 30 it was 42 inches. Both figures show maximum changes of moisture content in the surface foot, and in both plots the moisture content in the third and fifth foot-sections continued to rise for several days after irrigation. It is of interest to note that the moisture content in the cultivated plot, first and third foot-sections remained well above the 7 per cent minimum during the period of observation.

Powers found it best to irrigate potatoes when the moisture content of a rather heavy gray silt loam of western Oregon dropped to 20 per cent. Widtsoe concluded that a moisture percentage of 12 to 13 indicates that irrigation of the deep loam soils of the Utah Station is desirable, although he found no injury from wilting when the average moisture content of the upper 8 feet of soil dropped to 10 per cent. Moisture equivalent percentages are not reported for the New Mexico and Oregon soils. The moisture equivalent of the Utah soil on which Widtsoe worked is approximately 22 per cent, from which the computed wilting coefficient is 12 per cent.

Adams and others in 1914 found that alfalfa grown under favorable conditions on the Wigno field near Los Molinos in the Sacramento Valley, California, produced nearly 7 tons of alfalfa per acre, even though the moisture percentage dropped to the wilting point in the surface foot of soil, as determined from the moisture equivalent, before each irrigation of the season. The moisture percentage in each foot-section of soil

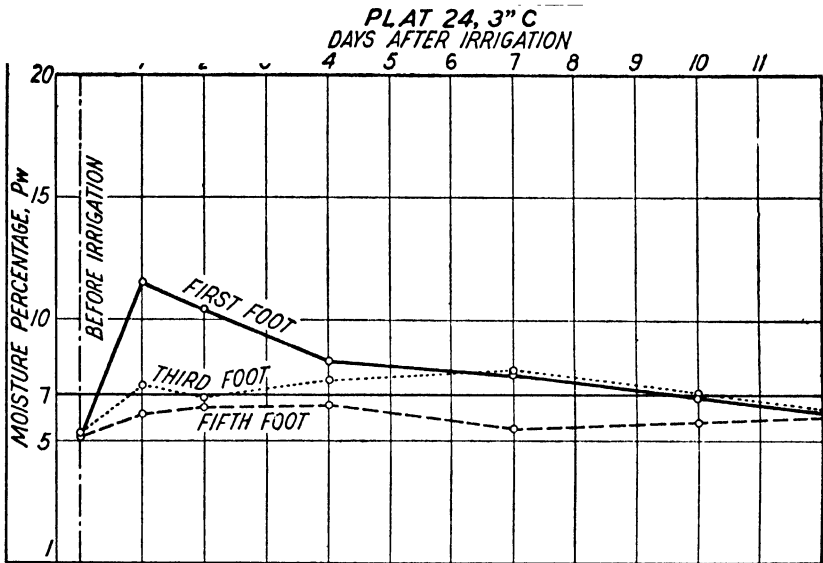

FIG. 111. — Showing increase in moisture per cents due to irrigation and decreases during the first 10 days after irrigation. (From data in New Mex. Agr. Exp. Sta. Bul. 123.)

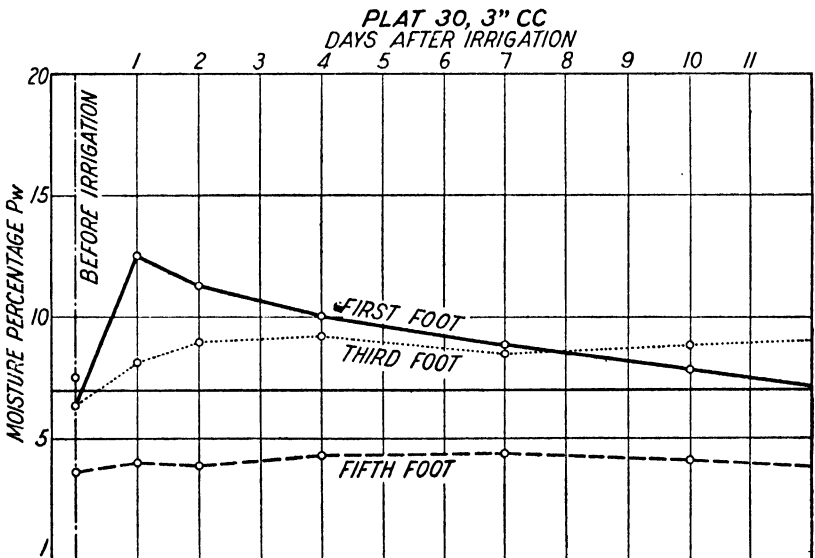
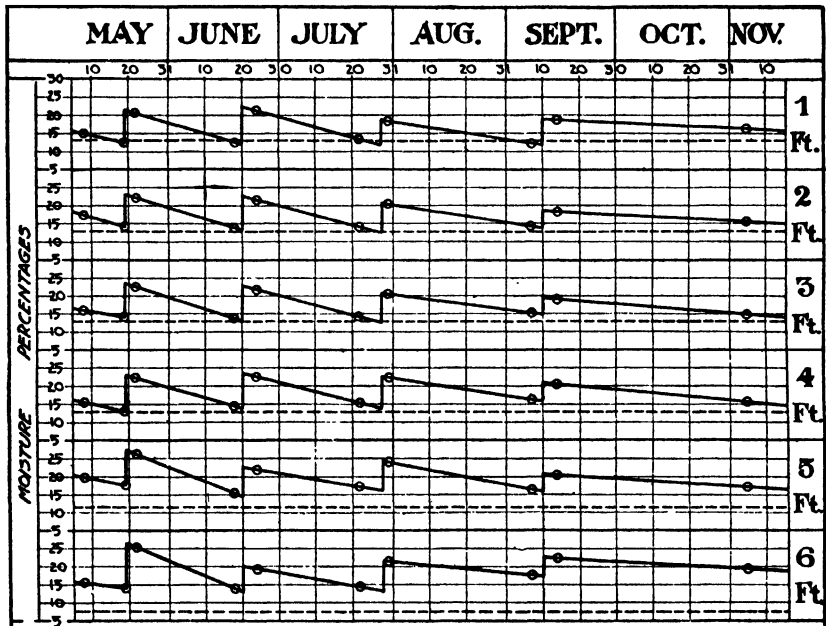

FIG. 112. — Showing increase in moisture per cents due to irrigation on cultivated alfalfa plot and decreases during the first 10 days after irrigation. (From data in New Mex. Agr. Exp. Sta. Bul. 123.)

is shown in Fig. 113 at 10 different periods during the crop-growing season.

Recent cooperative investigations by the Divisions of Pomology and Irrigation Investigations and Practice of the University of California, reported by Hendrickson and Veihmeyer, indicate that although there is a "remarkable constancy of the residual moisture content for a given



IRREGULAR SOLID LINE — REPRESENTS MOISTURE PERCENTAGE
 STRAIGHT BROKEN LINE — REPRESENTS WILTING POINT (WILTING COEFFICIENT)
 VERTICAL LINES REPRESENT INCREASES IN MOISTURE PERCENTAGES DUE TO IRRIGATION
 O REPRESENTS PERCENTAGE OF MOISTURE AT DATE OF SAMPLING

FIG. 113. — Showing seasonal variation in soil moisture per cents. Wigno alfalfa field, Los Molinos, 1914. (Calif. State Dept. of Engineering Bul. No. 3.)

soil when permanent wilting is attained, a common factor to evaluate the amount of water which remains in soils at permanent wilting cannot be used."

The seasonal moisture percentage variations of the soils of different experimental plats under various irrigation treatments are presented in Fig. 114.

The average amounts of water applied in each of the 4 treatments, or groups of treatments, represented in Fig. 114, were as follows:

Treatments *A* and *F* received the greatest quantities of water, an average of 25.3 acre-inches per acre during each of the last 5 years; treatment *D* received the next largest amount, an average annual application of 19.8 acre-inches per acre; and treatment *B* received less

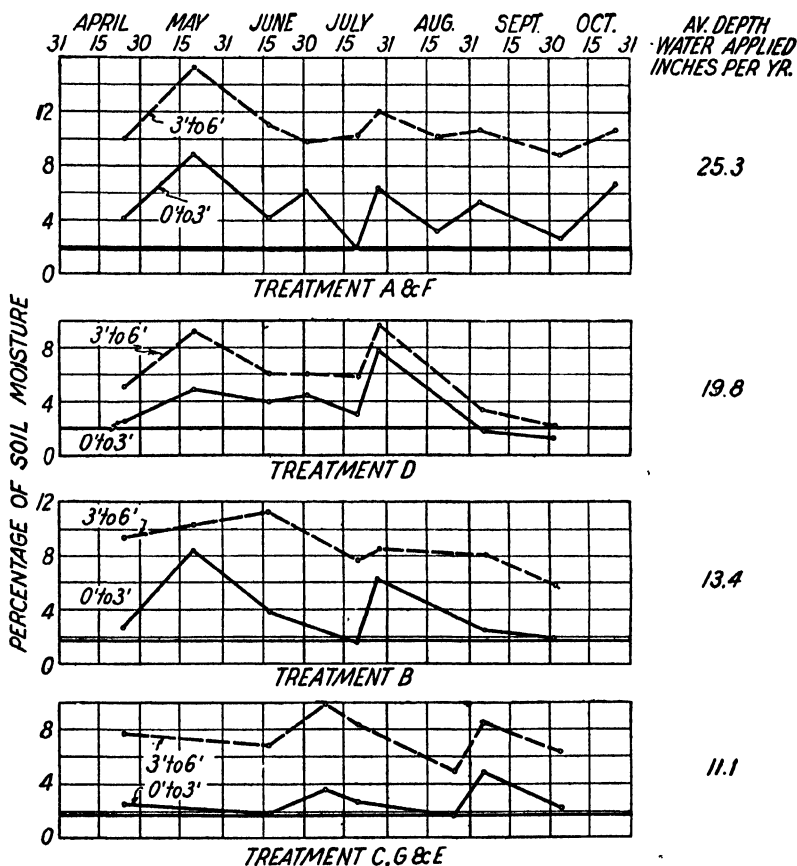

FIG. 114. — Moisture contents of soil in orchard treatments at Delhi, 1924. The permanent wilting percentage of the 0 to 3-foot depth is indicated by the heavy horizontal lines. (Calif. Agr. Exp. Sta. Bul. 479.)

water than *D*, or 13.4 acre-inches per acre; and treatment *C*, *G*, and *E* received only approximately one-half the amount applied on *A* and *F*, or 11.1 acre-inches per acre each year.

The soil of the Delhi experimental farm, observations on which Fig. 114 represents, is classified as an Oakley fine-sand. The student

should note the relatively low moisture content of the upper 3 feet of soil at permanent wilting represented in Fig. 114 by the heavy horizontal line. It is of interest also to note in Fig. 114 the relatively high average seasonal moisture content maintained by the larger applications of irrigation water. The wide range in variation of moisture content at the time irrigation water is needed to supply readily available moisture, as reported above, stresses the influence of soils in their different capacities to withhold water from plants. Clearly, it is important to know the permanent wilting percentage of each soil in order to use the moisture content as an index of the time when irrigation water should be applied to maintain a supply of readily available water in the soil.

191. Stage of Crop Growth. — The degree of control of soil moisture conditions within the reach of the irrigation farmer makes possible special attainments in crop production. For example, withholding irrigation water from alfalfa after the first cutting in the mountain states stimulates the production of seed in the second growth provided the soil moisture content does not decrease so far as to prevent growth. The advantages and disadvantages of irrigating certain crops during particular stages of growth are considered briefly in Chapter XIX.

192. Seasonal Use of Water by Different Crops. — It is practicable for irrigators to select their crops, to some extent, on the basis of time at which water will be available from natural streams. In many valleys having no storage reservoirs, the greater amounts of water are available early during the season. From the beginning of the crop-growing season until late in June or early July the streams are fed by the melting of snow banks and drifts in the mountains, and the water supply is much larger than it is later during the summer. Under such conditions, alfalfa, wheat, and oats may well be produced, as each of these crops requires large amounts of water in May and June. Likewise, canning peas may be matured before the water shortage begins. Alfalfa continues to grow throughout the late summer months provided water is available with which to irrigate it. If not, the alfalfa remains dormant without sustaining permanent injury, and growth begins again when water is applied, either late during the growing season or early the following spring season. Sugar beets, potatoes, and corn use very little water early in the season, but during the late summer months, particularly late July, August, and early September, these crops need an abundance of water. Unless late-season water is assured, it is inadvisable to attempt to grow sugar beets and potatoes. The time periods at which the more important crops of Cache Valley, Utah, use water, and also the rates of use at different periods, have been well illustrated by Harris, as shown in Fig. 115.

193. Available Water Supply for Irrigation. — Irrigation during the dormant, or non-growing season, in many localities in the West, is an economical means of storing water for future use. Also, during the growing season farmers sometimes apply water in copious quantities immediately after heavy rains which increase the flow in rivers and creeks, and thus make available for short periods of time rather large quantities of water for irrigation. So far as it is economically feasible, it is probably desirable to build surface reservoirs both large and small in which to store water that becomes available from sudden torrential rains, or that is available only during the fall, winter, or spring, when it must be stored, used, or lost. It is probably a general rule, subject, of course, to some exceptions, that water which is used in irrigation at times when not really needed by crops is used less efficiently than it would be were it possible to apply it to the soil when most needed. However, in many localities storage of water in surface reservoirs is impracticable because of high costs and lack of suitable natural facilities.

In such localities it is advantageous to use the soil as a storage reservoir and to apply water whenever it is available as a means of storing it for future use. Bench or table lands should, as a rule, be irrigated sparingly, particularly lands which are underlain by coarse-textured sands and gravels, provided the objective is to store water only in the capillary form. Some areas can be greatly benefited by applying amounts of water during the dormant season sufficient to saturate the subsoil gravels and cause the water table to rise to an elevation near the land surface. Unless it is feasible to pump the ground water to the surface during the irrigation season, excessive amounts of water applied during the dormant season may cause appreciable damage by water-logging the soil.

194. Fall Irrigation. — The application of water following the harvest season is known as fall irrigation. The need for fall irrigation of lands that are used to produce annual crops, such, for example, as grains, potatoes, sugar beets, beans, and peas, is determined largely by the pre-

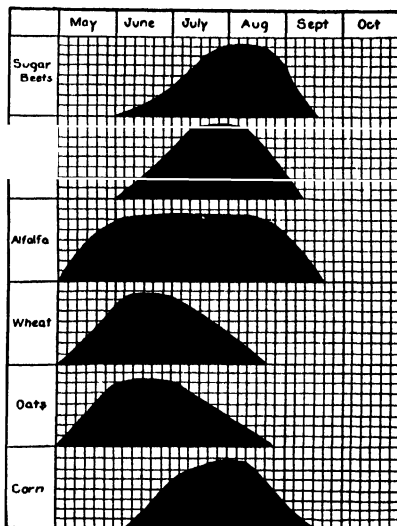

FIG. 115. — Representing the seasonal use of water by various crops in Cache Valley, Utah. (Utah Agr. Exp. Sta. Bul. 173.)

precipitation. In localities that normally have enough fall and winter precipitation to raise the moisture content of the soil to field capacity to the full depth of the root zone after a crop has been harvested, there is little, if any, direct advantage in fall irrigation, except during years of abnormally low precipitation. In the West these localities are relatively few in number, and the area they include is comparatively small. There are many places in which the fall and winter precipitation is insufficient to moisten the soil fully. In most of these localities the streams yield water during the fall months that flows past the lands and is wasted unless applied to the land. Fall irrigation under such conditions is a very good means of saving water and of placing the land in condition for favorable germination of seeds and early growth of crops during the following season.

Alfalfa grown on well-drained soils may well be irrigated in the fall, and fall irrigation of meadow forage crops and of pasture lands is usually desirable if, without irrigation, the soils become very dry. In the practice of irrigation during the fall, winter, or early spring it is important to guard against the use of excessive amounts of water. As shown in Chapter IX, there are definite limitations to the capacity of any soil to retain water. In the Rocky Mountain states some irrigators, during the fall, permit water to run on their lands many days and sometimes weeks. This practice is injurious both to the land irrigated and to the lower-lying areas to which much of the excess irrigation water ultimately seeps.

The methods of water distribution considered in Chapter V will aid the irrigator in the practice of fall irrigation. He may use, also, the facts stated in equation (32) and in Chapter IX as guides against the application of an excessive depth of water.

195. Winter Irrigation. — At the higher elevations and in the colder parts of irrigated regions, winter irrigation is of little if any practical importance. The frozen soils absorb water very slowly, if at all, and it is difficult to spread water over the fields effectively. Furthermore, some crops are injured by winter irrigation in cold climates.

In the milder climates, however, winter irrigation may be practiced advantageously as a means of saving water that would otherwise be lost. Forage and pasture crops use relatively small amounts of water during the winter months. The irrigation of orchards during the dormant season is considered in Chapter XXII.

196. Early Spring Irrigation. — Extensive areas of land in the arid regions need irrigation during the early spring months in order to supply the moisture essential to satisfactory germination and early growth of annual crops. As a general rule, arid-region streams have ample sup-

plies of water to meet the needs for early spring irrigation. Even in cases where the discharge of the streams at high mountain elevations, is held in storage reservoirs, enough water is available from the rains and melting snows on lower elevations to supply all the needs for early spring irrigation. It is probable that the value of early spring irrigation as a means of saving water by storing it in the soil is not yet fully realized. Irrigators are frequently misled by the fact that the spring rains moisten the soil to a depth of 9 to 15 inches. They consider the soil "wet enough" when, in fact, there are 3 to 5 feet of dry soil below the moist surface soil.

Proper use of the soil auger or of the soil tube described in Articles 125 and 126 will enable the irrigator to decide intelligently the needs of his soil for early spring irrigation. Although it is highly desirable to save water by applying it to inadequately moistened soils, it is quite undesirable to irrigate soils early in the spring that are already moistened to field capacity.

Fully moistened soils in which the water table is at a shallow depth may be injured rather than benefited by early spring irrigation. Under such conditions it is better to permit the waste of water in natural streams than to apply it to the soil.

Irrigation companies sometimes delay unduly the time when water is made available to landowners for spring irrigation. Some companies turn water into their canals just as soon as the snow and ice disappear, and keep it in long enough for each landowner to give all the land one good irrigation, after which the water is turned out while the canals and ditches are cleaned and made ready for the regular irrigation season's use.

REFERENCES

- ADAMS, FRANK, *et al.* Inves. of the Economic Duty of Water for Alfalfa in Sacramento Valley, California, Dept. of Engineering Bul. No. 3. 1917.
- BACHELOR, L. D. Irrigation of Peaches, Utah Agr. Exp. Sta. Bul. 142. 1916.
- BRIGGS, L. J., and SHANTZ, H. L. The Wilting Coefficient for Different Plants and its Indirect Determination, U. S. D. A., Bur. Plant Ind. Bul. 230. 1912.
- HARRIS, F. S. The Duty of Water in Cache Valley, Utah. Utah Agr. Exp. Sta. Bul. 173. 1920.
- HENDRICKSON, A. H., and VEIHMEYER, F. J. Irrigation Experiments with Peaches in California, California Agr. Exp. Sta. Bul. 479. 1929.
- MAGISTAD, O. C., and BREAZEALE, J. F. Plant and Soil Relations At and Below the Wilting Percentage, University of Arizona Agr. Exp. Sta. Technical Bul. 25. 1929.
- POWERS, W. L. Field Moisture Capacity and Wilting Point of Soils, Soil Sci., 14, No. 2. 1922.
- SHULL, CHARLES ALBERT. Measurement of the Surface Forces in Soils, Bot. Gazette, 62 : 1-31. 1916.

- THOMAS, MOYER D. Aqueous Vapor Pressure of Soils, *Soil Sci.*, **11**, No. 6. 1921.
- THOMAS, M. D. Aqueous Vapor Pressure of Soils, *Soil Sci.*, **17** : 1-18; **25** : 409-418. 1928.
- THOMPSON, C. A., and BARROWS, E. L. Soil Moisture Movement in Relation to Growth of Alfalfa, *New Mexico Agr. Exp. Sta. Bul.* 123. 1920.
- VEIHMEYER, F. J., and HENDRICKSON, A. H. Soil Moisture at Permanent Wilting of Plants, *Plant Physiology*, **3** : 355-357. 1928.
- VEIHMEYER, F. J., and HENDRICKSON, A. H. The Relation of Soil Moisture to Cultivation and Plant Growth, *Proc. First Int. Cong. Soil Sci.*, **3**. 1927.

CHAPTER XIV

CONSUMPTIVE USE OF WATER IN IRRIGATION*

The rapid growth of American irrigation during the first quarter of the twentieth century has developed a keen public interest in a study of the disposal of irrigation water. The pioneers in irrigation had little opportunity fully to ascertain what became of the water which they applied to their lands. That they lost some water by surface run-off was obvious; that some water was absorbed by the crops they grew was likewise apparent; but that large quantities of water percolated deeply into the dry soil was to them merely speculation, if, indeed, such losses were suspected at all. However, the gradual rise of water tables, with resulting enlargement of natural springs and the development of new springs and the seepage return to flood-water channels, to small creeks, and, finally, to rivers, gave increasing evidence concerning the magnitude of losses of water through deep percolation. Moreover, it was found through experience that much less water need be applied to the farms to produce profitable crops than was formerly believed necessary, and the areas of land successfully irrigated by the water from a given stream were greatly increased without any apparent increase in the water supply. Obviously, such increase in area of irrigated land could not continue without limit, some water being actually consumed by the growing crops.

197. Definitions and Analysis. — Gross duty of water, headgate diversions, and net duty are familiar terms concerning water uses, but “consumptive use” is a term of recent origin, and should not be confused with the net duty on land and other terms used in discussions of duty of water.

Some engineers have restricted the term consumptive use to “valley consumption,” or net depletion of river flow, whereas others have used it to include water from all sources, or total water consumption,

* From the year 1924 to 1927 the Duty of Water Committee of the Irrigation Division of the American Society of Civil Engineers devoted special attention to the “Consumptive Use of Water in Irrigation.” Most of the material in this chapter is taken directly from the report of the Committee first published in Proceedings, April, 1928, and later published in the Transactions of the Society, Vol. 94 (1930), paper No. 1760. The author gratefully acknowledges his indebtedness to the members of the Committee, and to the Society for permission to use this material.

irrespective of whether it is from river water, rainfall, carry-over soil moisture, or absorption from ground water. It is believed that the use of the definitions given in this chapter will avoid confusion in the study of consumptive use of water in irrigation.

To add convenience and brevity to the definitions and analysis of consumptive use, mathematical symbols are employed and mathematical methods are followed, despite the fact that the equations are of a comparatively simple form.

Symbols Used. — The meaning of each of the more important symbols is fully given subsequently. For convenience of reference, the naming of these symbols is briefly as follows:

Let

U = consumptive use.

U_f = farm consumptive use.

Q_h = quantity of available heat, in day-degrees, during crop year.

e = evaporation from water surfaces.

m = mean seasonal soil moisture content.

s = the soil with all its influencing factors, notably potash, phosphorus, lime, humus, and nitrifying power.

c = the kind of crop.

y = the yield of crop.

D_f = deep percolation losses from the farm.

H_f = the total quantity of water supplied the farm.

R_f = surface run-off from the farm.

198. Consumptive Use in a Basic Sense. — The consumptive use, U , is defined as the quantity of water, in acre-feet per cropped acre per year, absorbed by the crop and transpired or used directly in the building of plant tissue, together with that evaporated from the crop-producing land.*

The direct source of "consumed" water is the water in the soil in any form that crops can absorb it. The indirect sources of consumed water are those parts of the precipitation and of irrigation water which are stored in the soil in such depths and for such time as to permit direct absorption by crop roots, together with such water as may be obtained

* The consumptive use, as here defined, is not rigorously a correct application of the term, "consumptive," since the water which passes out of the crop leaves is not truly consumed. It is merely converted by the plant and the energy of the sun from the liquid to the gaseous phase. However, for the purposes of this analysis, water vapor in the atmosphere is considered beyond direct recovery by practical means, and hence the conversion of liquid water into water vapor is considered herein as consumptive use.

by the crop roots from the ground water after such water is raised to the plant root zone by capillary action. The consumptive use as herein defined is, therefore, equal to the total *evapo-transpiration* plus the water used in the building of plant tissue.

It is natural to inquire concerning the factors which determine the magnitude of U . A statement of the major influencing factors is made in the following equation:

$$U = \text{a function of } (Q_h, e, m, s, c, y)^* \dots \dots (52)$$

It is apparent that most of the factors which influence the magnitude of U are themselves variable. The number of variables may be reduced somewhat under specified conditions; for example, if the soil of a farm is liberally supplied with organic matter and all the essential plant-food elements, so that the yield of a particular crop will be limited by the quantity of heat available and not by lack of moisture or of plant food, it is possible to eliminate the last four factors in equation (52) and write:

$$U = \text{a function of } (Q_h, e) \dots \dots (52a)$$

In the light of the foregoing statements, it is unreasonable to expect that a precise experimental determination of U will give a definite magnitude that can always be considered rigorously correct. Dependable approximations of the magnitude of U are, however, both essential and possible.

Knowledge concerning the magnitude of U is dependent on further analysis. Does U indicate consumptive use per acre on a particular farm? It seems reasonable to assume that the public may expect the individual irrigator to account for all the water which goes onto his farm. With respect to a particular farm, the water applied is disposed of by consumptive use, plus surface run-off, plus losses from the farm by deep percolation.

199. Farm Consumptive Use. — Let D_f = deep percolation farm loss, in acre-feet per cropped acre per crop year. This loss usually cannot be measured with precision by direct means. Then, by definition, as used here

$$U_f = U + D_f \dots \dots (53)$$

It is important to distinguish between U_f and a related quantity, H_f , which is defined as follows:

* Plant diseases and insect pests may reduce crop yield, y , without proportionately reducing consumptive use, U . Likewise, inefficient farm practices may change the relation between U and y .

Let H_f^* = the sum of:

- (a) the quantity of irrigation water delivered at the farm, plus
- (b) the water taken from moisture stored in the capillary form, plus
- (c) the crop-season rainfall, plus
- (d) the amount absorbed from the gravitational ground water —
all in terms of acre-feet per cropped acre per crop year.

Let R_f = surface run-off from a farm, in acre-feet per cropped acre per crop year. Then, by equating the sum of the irrigation water delivered to the farm, plus rainfall and draft on the soil moisture, plus the quantity of water absorbed from the ground water, H_f , to farm consumptive use, U_f , plus farm run-off, R_f , there results:

$$U_f = H_f - R_f \dots \dots \dots (54)$$

Equation (54) gives an indirect means of arriving at the farm consumptive use.

200. Common Difficulties. — Some of the more common difficulties in measuring consumptive use, together with notes concerning its variability, are briefly given, after which some actual measurements are reported. The factors which cause variability in U at a particular place have been given in equation (52). It is obvious that the factors in the right-hand member of equation (52) vary greatly from place to place. Based on elaborate experiments in Nebraska, Kiesselbach concluded that "there is no such thing as a definite water requirement which is constant for any kind of crop"; and, similarly, there is no definite consumptive use. The quantity D_f in equation (53) depends on:

- (a) The quantity of irrigation water applied in each irrigation.
- (b) The uniformity of distribution.
- (c) The frequency of irrigation.
- (d) The length of land irrigated in a single run and the size of stream used.
- (e) The texture of the soil and subsoil.
- (f) The depth to the water table.
- (g) The dryness of soil between the water table and the zone of root action, provided the water table is very deep.
- (h) The kind of crop and depth of root zone, and
- (i) The specific water conductivity of the soil and other less important factors.

* In the discussion in Chapter XV concerning sources of water supplied to crops grown in experimental irrigation work the quantities which constitute H_f as above given, i.e., (a), (b), (c), and (d), are designated by the symbols w , m , r , and g , respectively.

In many localities, D_f was large during the early years of irrigation, but is now relatively small because: (1) the dry desert soil to great depths has been fully moistened through the years of irrigation; (2) the land is better prepared for applying water; and (3) general improvement in irrigation methods has been made.

Provided the farm considered has a deep uniform soil and deep water table, the elements of supply may be measured with fair precision, but on gravelly or greatly variable soils the draft on soil moisture cannot be effectively measured. The rainfall may vary greatly from point to point; and it is, therefore, essential carefully to estimate percentage inaccuracy in the elements of supply which may result from rainfall variation, if the rainfall factor is comparatively large. In some localities a still greater source of error is the inflowing ground water from neighboring high land, measurements of which are sometimes impracticable.

That the dependability of measurement of the consumptive use rests on a complete analysis of all these factors is not likely to be over-emphasized. Moreover, reports of consumptive use should not be given great weight, unless they are accompanied by complete and detailed descriptions of the conditions under which they were made. Doubtless, in some localities, the relative magnitude of the inaccessible inflow and outflow below the ground surface is so great as to make computations of consumptive use of little value. On the contrary, the need for economic utilization of water from all sources, and the urgency of being able to predict with a fair degree of accuracy the areas that may be adequately served by a given water supply, seem fully to justify extraordinary efforts toward increasing the possibility of obtaining reliable measurements of consumptive use under specified conditions.

201. Experimental Measurements. — The literature on use of water is voluminous. The federal Department of Agriculture, through its Bureaus of Agricultural Engineering and of Plant Industry; the Department of the Interior, through the Bureau of Reclamation and the Geological Survey; the state agricultural experiment stations; the state engineers' offices; and some private agencies are annually contributing substantial amounts of time and energy to a study of the use of water in irrigation. In Canada, also, very careful study is being made of the use of irrigation water by public and private agencies. Some of the experiments thus conducted give a fair basis for determinations of the consumptive use, U , and of the farm consumptive use, U_f . Many studies have been conducted without measuring the water obtained from capillary soil moisture, and, indeed, some experimenters have failed to report the crop-year rainfall. Consequently, reference is here made only to those experiments which

seem most directly to contribute toward a determination of consumptive use both in its basic sense, U , and in its modified meaning for the farm.

202. Consumptive Use, U , as Determined from Tank or Pot Experiments. — Most of the evapo-transpiration studies have been conducted in tanks or potometers. Kiesselbach found that the limitation of the amount of soil used, because of the small capacity of the potometer, may be a great source of error in pot experiments. It seriously affects not only the transpiration relationships, but the entire development of the plant.

Other difficulties in determination of consumptive use by means of potometers are:

- (a) Obtaining the same atmospheric environmental conditions around pots as exist in ordinary cropped land.
- (b) Obtaining the same number of plants per unit area of land as occur under field conditions.
- (c) Getting the soil into tanks in the same physical conditions as exist in the field, thus permitting the same aeration and water movement.

The influence of these factors on the consumptive use is great enough to render the pot method of determining such use of limited value. In some localities, however, where the water table is near the land surface, the pot method of determining consumptive use is probably more reliable than the field plot method.

203. Consumptive Use as Determined on Field Experimental Plots. — Direct measurements of consumptive use in field plots are believed to be more dependable than measurements with pots or tanks. In order to permit measurements in the field, it is clearly necessary to use land in which the water table is at a considerable distance below the surface, because when working with small field plots it is usually impracticable to measure the quantity of water absorbed by the crop from the ground water. It is also necessary that the irrigation water be applied in small units not to exceed a depth of 5 inches in a single irrigation on ordinary soils. Even a smaller quantity often results in percolation beyond the depth of feeding roots in coarse-textured soils. Either very large unit applications of water at ordinary time intervals, or excessively frequent irrigations resulting in the maintenance of a high moisture content, causes an appreciable downward movement of moisture in the gravitational or capillary form, and thus gives apparent values for the consumptive use higher than the true values. It is impracticable, by direct means, to measure the amount of such downward movement, and

hence an attempt to measure the consumptive use, U , under these conditions may give, in reality, the farm consumptive use. When the deep percolation equals zero, the farm consumptive use equals the consumptive use; therefore, it follows that the consumptive use equals the supply less the surface run-off. In most of the field determinations the run-off has been either carefully measured or reduced to zero by the proper preparation of the experimental plots. The supply factors, in general, have not been measured with precision even on plots where the great depth of the water table has precluded the possibility of the crop receiving any ground water. This is due to the fact that precise measurements of the quantity of water taken from capillary soil moisture storage is practicable only in comparatively homogeneous soils free from gravel, and that even under the most favorable soil conditions dependable tests of soil moisture add greatly to the cost of measuring the water supplied to a plot. There is, however, a growing need for more thorough studies in which the consumptive use will be fully determined for different conditions. In some field plot studies the consumptive use has been either determined or closely approximated, and of these the following are typical.

204. Widtsøe's Utah Work. — Widtsøe pioneered the measurement of consumptive use in field plots at the Utah Agricultural Experiment Station, beginning in 1902. His work was done on land having a water table about 75 feet below the surface; and hence, it is reasonably safe to conclude that the crops obtained no ground water and that the crop-season rainfall, the draft on stored capillary soil moisture, and the irrigation water, furnished all the water to which the crops had access. There was no run-off from the experimental plots used by Widtsøe: $R_f = 0$. The deep percolation losses, D_f , were not measured. If these losses are assumed to be negligible, then $U = H_f$, that is, the sum of the quantities a , b , and c , of H_f as used in equation (54). Widtsøe measured these sources of water for 14 crops during the 10-year period, 1902–11 inclusive. Results for the 7 crops on which most of the work was done are given here. The crop-season rainfall used by Widtsøe was 0.42 foot, and the seasonal draft on capillary moisture in the upper 8 feet of soil varied from 0.10 foot for corn to 0.83 foot for alfalfa. Quantities of irrigation water were applied, varying from 0.42 foot to 5.00 feet, and wide variations in crop yields were obtained. The yields obtained by Widtsøe have been plotted against the total water used, and, as a basis for arriving at the consumptive use, those yields were selected which appear to be most profitable. With nearly every crop, the yield increased rapidly to a certain point with increase of total water used, and then either decreased with further increase in water or increased

very slowly, and at this "break in the curve," the value of U was taken. The results are given in Table XXVII.

TABLE XXVII

CONSUMPTIVE USE AS DETERMINED ON FIELD PLOTS BY WIDTSOE AT THE UTAH AGRICULTURAL EXPERIMENT STATION, IN CACHE VALLEY, UTAH

Crop	Number of Single Trials	Yield, in Bushels, or Tons per Acre*	Consumptive use, in Acre-feet per Acre
Sugar beets.	152	21 3	2 5
Potatoes.	124	267 0	2.2
Alfalfa	49	4.7	3.3
Corn.	81	99 2	2.5
Wheat.	142	45 7	2.4
Oats.	29	80.7	2.5

* Yields are given in tons per acre for sugar beets and alfalfa and bushels per acre for the remainder of the crops.

Widtsoe's work indicates the importance of yield in determining the consumptive use. It is also important to keep in mind the fact that deep percolation losses from the plots on which Widtsoe worked would result in observed magnitudes of U higher than the true ones. It is far more probable that the given values of U are too high rather than too low.

205. Snelson's Alberta Work. — Working on field plots in Brooks, Alberta, Canada, Snelson used moderate quantities of water in single applications and made careful measurements of soil moisture to a depth of 6 feet at the beginning and the end of the growing season. Under his methods percolation loss in all probability was very small, if not zero, and hence it seems safe to assume that U is equal to U_f . If percolation losses were zero, then according to Snelson's experiments with wheat on the more fertile soil the consumptive use varied from 0.85 foot to 1.82 feet as the crop yield varied from 10 to 50 bushels per acre. For oats on the more fertile plots the consumptive use ranged from 0.72 foot to 1.75 feet as the yield varied from 40 to 135 bushels per acre. Barley required a consumptive use from 1.25 to 1.60 for yields ranging from 40 to 51 bushels per acre, and for alfalfa the use varied from 1.00 to 2.62 feet for yields ranging from 1.0 to 5.7 tons per acre.

206. Powers' Oregon Work. — Powers has made many field plot measurements of consumptive use in Oregon. Experimenting with alfalfa in the Willamette Valley during 1911, using moderate irrigation, he found values from 1.4 to 2.0 feet, accompanying yields of 4.1 to 5.2

tons per acre. The consumptive use for clover was approximately the same as that for alfalfa. Moisture determinations were made to a depth of 6 feet at the outset in the Willamette Valley work, but as most of the borings showed a water penetration to only 4 feet, the later borings were not made below this depth except in connection with a few very heavy irrigations. Powers was convinced that there was "practically no loss by percolation" apparently because dry soil was frequently encountered in the lower depths and also because these lower depths in many instances gained in moisture content during the period following one irrigation and preceding the next. It is doubtful whether this is conclusive, since the increase in the lower depths may have been caused by a movement of capillary water downward from the moist surface to the drier sections below. If such were the case, some percolation probably occurred, and Powers' measurements would represent U_f instead of U . If, on the other hand, the moisture did rise in significant quantities from below the zone of soil sampling, then the value of the consumptive use as measured by Powers is too small, as there was an unmeasured source of water. The depth of the water table is not reported.

207. Utah Work by Harris. — Further field plot work at the Utah Agricultural Experiment Station by Harris and associates from 1911 to 1919 gives additional information concerning consumptive use. The results of this work, together with the work done by Widtsoe, have been reported in detail in Station Bulletins which were published as the work progressed. Finally, in one paper Harris brought together the results of 17 years' work. This Bulletin contains six charts, each representing a different crop, which show the relation between the yield and the quantity of water applied. Two curves are plotted on each chart, the actual average yields for the different irrigations being shown by dotted lines, and the average found by weighting the results according to the number of tests are shown by heavy lines. Harris did not report the seasonal draft of each crop on the soil moisture. For purposes of comparison, this has been assumed to be the same as that found by Widtsoe. Moreover, to make the results still further comparable, the depths of water applied, according to the heavy lines of the charts prepared by Harris, have been selected corresponding to the respective crop yields used in connection with Widtsoe's data, that is, for 21.3 tons of sugar beets, 267.0 bushels of potatoes, etc. On these bases, Table XXVIII has been prepared.

These values show fair agreement with those obtained from Widtsoe's work, except for the alfalfa and oats. According to Fig. 5 of Utah Station Bulletin 173, a yield of alfalfa of 4.3 tons per acre would require the same consumptive use as found by Widtsoe for 4.7 tons, namely, 3.3

TABLE XXVIII

CONSUMPTIVE USE APPROXIMATIONS BASED ON THE FIELD PLOT WORK OF WIDTSCOE AND HARRIS AT THE UTAH AGRICULTURAL EXPERIMENT STATION

Crops	Yield, in Tons or Bushels per Acre	Depth of Water Applied, in Feet	Depth of Soil Moisture and Rainfall Used, in Feet	Consumptive Use, in Acre-feet per Acre
Sugar beets.....	21.3	1.50	0.86	2.4
Potatoes.....	207.0	1.67	0.52	2.2
Alfalfa.....	4.7	3.33	1.25	4.6
Corn.....	99.2	1.67	0.52	2.2
Wheat.....	45.7	1.33	1.15	2.5
Oats.....	80.7	2.33	0.81	3.1

feet. The maximum yield of oats according to the 17 years' work reported by Harris is slightly less than the 80.7 bushels per acre used in Widtscoe's work. A yield of 74 bushels per acre, according to the curves by Harris, would have been produced by a consumptive use of 2.5 feet, the quantity required to produce 80.7 bushels in Widtscoe's work.

TABLE XXIX

FARM CONSUMPTIVE USE (U_f) AS MEASURED ON FIELD PLOTS IN THE SNAKE RIVER VALLEY, IDAHO, BY LEWIS

Crop	U_f on Plots of High Production	U_f on Plots of Average Production
Wheat.....	1.78	1.18
Oats.....	1.84	1.45
Barley.....	1.68	1.58
Peas.....	1.66	1.36
Beans.....	1.20	1.20
Corn.....	0.96	1.29
Potatoes.....	1.63	1.60
Clover.....	2.14	1.54
Alfalfa.....	2.89	2.55
Mean, if crops are given equal weights.	1.75	1.53

208. Lewis' Idaho Work. — Lewis measured the quantity of water used by nine important crops in the Snake River Valley, near Twin Falls, Idaho. He divided his observations into two groups: (1) those

on the better plots that produced high yields; and (2) those on which average yields were produced. His data are summarized in Table XXIX.

It will be noted that in the better plots the seven grain crops and also the potatoes consumed less than 2 acre-feet per acre. The alfalfa consumed the largest quantity and the clover the next largest, the average for all the crops being 1.75 feet on the better plots and 1.53 feet on the average plots. It is probable that these magnitudes represent the farm consumptive use, U_f , for the Twin Falls area more nearly than the consumptive use, U , since the experimental conditions very likely permitted some deep percolation.

209. Hemphill's Colorado Work. — Working in the Cache la Poudre Valley, Colorado, during 1916 and 1917, Hemphill measured the water applied to twenty-five farms. The run-off, R_f , is not given for each farm, but the average, R_f , was 6 per cent of the quantity applied. Deducting 6 per cent of the quantity for maximum crops to arrive at the quantity of irrigation water held on each farm and adding arbitrarily an allowance of 0.3 foot for moisture absorbed from the stored winter precipitation, and adding further 0.92 foot for rainfall from April 1 to September 30, there results the farm consumptive use as given in Table XXX.

TABLE XXX

FARM CONSUMPTIVE USE AS DETERMINED BY HEMPHILL IN CACHE LA POUDE VALLEY, COLORADO

Crops	Maximum Yield, in Tons, or Bushels per Acre	Farm Consumptive Use for Maximum Yield per Acre	Average Yield, in Tons, or Bushels per Acre	Farm Consumptive Use for Average Yield per Acre, U_f
Sugar beets.....	15.1	3.6	12.6	3.0
Potatoes.....	390.0	4.2	230.1	3.3
Alfalfa.....	4.0	5.8	2.8	3.7
Barley.....	60.0	3.4	40.7	2.3
Wheat.....	45.0	3.1	27.7	2.1
Oats.....	80.0	3.6	48.1	1.4

How closely the farm consumptive use, as given in Table XXX, approaches the consumptive use, is conjectural, as the magnitude of the percolation losses is not known and as it is subject to greater variation in actual farm irrigation than in field plot experiments heretofore reported.

Investigations of the net duty of water in Sevier Valley, Utah, by Israelsen and Winsor during the 7-year period 1914 to 1920, give some information concerning farm consumptive use. In these experiments the quantities of water found necessary to deliver to the farm for sugar beets, potatoes, and alfalfa, excluding farm run-off, R_f , were 2.5, 2.0, and 2.8 acre-feet per acre, respectively. The crop-season rainfall was 0.3 foot, and assuming a draft on the soil moisture of 0.3 foot, the farm consumptive use, U_f , was as follows: Sugar beets, 3.1, potatoes, 2.6, and alfalfa, 3.4 acre-feet per acre.

210. Consumptive Use Efficiency. — Remembering that, by definition, the consumptive use of water in irrigation includes the water that is *transpired* by the crop and *evaporated* from the crop-producing land, it is obvious that, the lower the evaporation losses from a given amount of water stored in the soil, the greater will be the amount of water transpired by the crop. For a given transpiration efficiency, low evaporation tends toward efficient consumption of water and high evaporation losses tend toward inefficient consumption. The consumptive use efficiency is defined as the ratio of the amount of irrigation water transpired by the crop during the growing season to the amount of irrigation water stored in the soil which is ultimately either transpired or lost through evaporation.

Let E_u = the consumptive use efficiency.

W_t = the irrigation water transpired by the crop.

W_s = the irrigation water stored in the soil.

Then by definition

$$E_u = W_t/W_s \quad \dots \dots \dots (55)$$

The consumptive use efficiency as above defined is clearly a *physical* concept. It is therefore vitally different from the transpiration efficiency, as defined in Chapter XII, which is a *biological* concept. In Chapter XVIII, concepts of efficiency in the application of irrigation water to the farm and in its conveyance and delivery are introduced. Finally, efficiency in the entire procedure of getting water from rivers and other natural sources through the diversion canals, laterals, and farm ditches, and into the soil in a form readily available to plants, is defined as irrigation efficiency, and its relation to efficiency in the several irrigation processes is illustrated by examples.

Consumptive use efficiency, as above defined, approaches 100 per cent as a maximum when evaporation is prevented and all the irrigation water stored in the soil is transpired by plants. Transpiration efficiency, on the contrary, being a biological concept, involving growth processes, does not permit of a precise designation of a maximum value.

REFERENCES

- HARDING, S. T., *et al.* Consumptive Use of Water in Irrigation, *Trans. Am. Soc. C. E.*, **94**, Paper 1760. 1930. (A Report of the Duty of Water Committee.)
See also discussions and references in Paper 1760, some of which follow:
- HARRIS, F. S. The Duty of Water in Cache Valley, Utah, *Utah Agr. Exp. Sta. Bul.* 173. 1920.
- HEMPHILL, ROBERT G. Irrigation in Northern Colorado, *U. S. D. A. Bul.* 1026. 1922.
- ISRAELSEN, ORSON W., and WINSOR, LUTHER M. Duty of Water in Sevier Valley, Utah, *Utah Agr. Exp. Sta. Bul.* 182. 1922.
- KIESSELBACH, T. A. Transpiration as a Factor in Crop Production, *Nebraska Agr. Exp. Sta. Research Bul.* 6. 1916.
- LEWIS, M. R. Experiments on the Proper Time and Amount of Irrigation, *Twin Falls Exp. Sta.* 1914, 1915, and 1916. *U. S. D. A.* cooperating with *Twin Falls County Commrs., Twin Falls Canal Co., and Twin Falls Commercial Club* 1919. (Unpublished reports.)
- POWERS, W. L. Irrigation and Soil Moisture Investigations in Western Oregon, *Oregon Agr. Exp. Sta. Bul.* 140. 1914.
- SNELSON, W. H. Irrigation Practice and Water Requirements for Crops in Alberta, Canada, *Reclamation Service, Irrigation Series, Bul.* 6. 1922.

CHAPTER XV

RELATION OF CROP YIELD TO WATER CONSUMED

Reliable information of the relation between water used and crop produced is a paramount need in arid regions. Efficient use of water in irrigation rests fundamentally on the extent of available information concerning this very important relation and on the application of such information in irrigation practice. Naturally the relation between water used and crop produced is influenced by many variable factors, such as climate, kind of crop, and properties of soil. Without the guide of scientific experimental evidence, the pioneers in American irrigation learned two vitally important truths concerning the relation of water used to crops produced, namely: that when no water was used no crop was produced, and that when an adequate amount of water was used an abundant crop production was assured. Added to these broad general truths there are now available the results of a third of a century of experimental work on the problem. This chapter describes briefly the research agencies and aims to summarize the methods and to present typical results of this very interesting experimental work.

211. Research Agencies. — Studies of water used and crops produced have been conducted largely by public agencies. The United States Department of Agriculture and the state agricultural experiment stations have contributed greatly to the information now available. The first outstanding investigations of crop yields and water used were conducted by the Utah Agricultural Experiment Station in cooperation with the Federal Irrigation Investigations, now the Bureau of Agricultural Engineering. More recently, most of the agricultural experiment stations of the western states have also given serious consideration to the problem.

212. Research Methods. — The common method of studying the relation of water used to crop produced is to apply each year different amounts of irrigation water to field plots growing various crops, and to measure the crop yield. Large tanks also have been used for studies of this kind, but only the results of field plot experiments are considered in this chapter. That the tank measurements have value in the study of factors influencing the efficiency of plant transpiration has been pointed out in Chapter XII, in which the sources of error in using the

results of tank work to represent quantitatively the water needs under field conditions were also stated. In the field plot experiments there are also sources of error that cannot be fully controlled, nor can the influence of these sources of error be precisely evaluated. However, the same perplexing conditions that confront the experimenter who uses field plots also confront the water user on the farm. Indeed, the irrigator, as a rule, has additional sources of error to consider.

213. Sources of Water Used.— Field crops in arid regions obtain the water they use largely, but not wholly, from irrigation. Supplemental sources of water supply are: crop season rainfall; water stored in the soil during the dormant season from rains or irrigation in the form of capillary soil moisture; and, in cases of lands having a shallow water table, the water absorbed by soils and crops from the gravitational soil water. Very frequent reference is made in the pages that follow to the quantities of water obtained by crops each season from each of these sources; and, therefore, for convenience and to add clearness to the discussion, the amounts of water in surface feet (acre-feet per acre) annually used by a crop from each source, and also the total amount used and the amount lost through deep percolation, are represented by symbols as given below:

Let U = the total amount of water consumed by each crop, including transpiration and evaporation from the soil.

w = the amount provided by irrigation, i.e., the amount applied each season less the surface run-off.

r = the crop-season rainfall.

m = the amount of water absorbed from stored capillary moisture.

g = the amount of water absorbed from gravitational ground water.

D_f = the water lost from the plot during the crop-growing season by deep percolation.

Neglecting capillary *lateral* inflow or outflow, it is apparent, since all the water available to the crop is either consumptively used or lost through deep percolation, that

$$U + D_f = w + r + m + g \quad (56)$$

214. Magnitudes and Measurements.— Some experimental field plots, such as those of the Greenville Farm of the Utah Agricultural Experiment Station, are on well-drained deep soils in which the water table is 60 or more feet below the surface. With such plots, the quantity g is doubtless negligible if not zero. For plots on similar deep well-drained soils in areas having negligible rainfall during the crop-growing

season, such for example as the Sacramento Valley and other parts of California, the quantity r is zero. Under these conditions

$$U + D_f = w + m \dots \dots \dots (56a)$$

In conducting field plot experiments it is possible as a rule to select plots under which the ground-water table is so low that the amount of water absorbed from ground-water sources, g , will be either negligible or zero. This is important because it is difficult, if not impracticable, to make reliable measurements of g . In relatively uniform soils, the quantity m can be measured with fair precision by making moisture determinations to a sufficient depth at the beginning and end of the crop-growing season. An important element in evaluating m is the determination of the apparent specific gravity, A_s , of the soil in its natural position, and to the proper depth. With the apparent specific gravity, A_s , known, the moisture percentage, P_w , can easily be converted to the equivalent depth of water, d , by use of the reasoning of Chapter IX. The quantity m is the amount of capillary water in the soil at the beginning of the season, minus the amount at the end of the crop-growing season, measured in feet. It is, as a rule, a positive quantity, but in case of heavy rains or irrigation near the end of the season it may be negative. The quantity w is measured by means of any standard water-measuring method. The method best suited to the conditions of water delivery should be selected. Standard methods of measuring the crop-season rainfall are used. The arbitrary element in attempting to evaluate the influence of the rainfall, r , on crop yield lies in the fact that many small rains give rise to much larger evaporation losses than does the same amount of water falling in one heavy rain. For this reason, some experimenters disregard small crop-season rains as being negligible. In any event, however, the crop-seasonal rain, r , is consumptively used unless lost by surface run-off or deep percolation. The relative magnitudes of the quantities w , r , m , and g vary from place to place in the arid regions. For example, in southern California w may be equal to or greater than $5m$ and r be zero, whereas in parts of Canada r is sometimes greater than $w + m$. The quantity g is influenced largely by the depth of the water table and the depth of crop roots.

215. Deep Percolation.—The greatest source of uncertainty, and, in some field plot experiments at least, the greatest source of error in the measurement of the amounts of water used, is the deep percolation loss D_f . As yet there is no well-developed method of measuring D_f in connection with field plot tests. Heavy irrigations doubtless contribute to large values of D_f , whereas moderate seasonal quantities of irrigation water in small single irrigations reduce these losses. It is very difficult

to avoid excessive deep percolation losses in irrigating shallow sandy and gravelly soils of loose structure, even when small plots are used. Doubtless in the irrigation of soils of medium texture and permeability the greater rates of loss through deep percolation occur shortly after irrigations or heavy rainfall when the soils are nearly, if not completely, saturated and the specific water conductivity of the soil is near its maximum. It is important to remember, however, that low rates of loss through downward flow in unsaturated soils, if continued throughout the season, may amount to excessive losses. As shown in Chapter IX, the deep percolation loss from the upper 6 feet of Greenville soil continues to be significant long after irrigation of plots which were fully wetted.

Although, in most of the field plot experiments here reported, D_f has not been measured, the results are believed to be of real value in illustrating a relation of basic importance between the amount of water consumed and the yield of crop. The experimental results also afford a basis for estimating net water requirements under conditions typified by the experiments.

216. Review of Experimental Work. — The results of reliable field plot studies of the relation of crop yield, y , to water consumed, U , form in part a very important basis for determining intelligently the net quantity of irrigation water that is most economical for a particular crop under specified costs and crop prices. Because of the fact that water is the *limiting factor* in arid-region crop production it is especially important that irrigators in arid regions be fully informed concerning its efficient and economical use. It is not meant to convey the impression that knowledge of the crop-yield-consumptive-use relation alone will supply all the information essential to economical use of water; rather such knowledge forms the foundation on which intelligent use of additional essential information rests. In the following pages a brief review is made of the results of typical experiments in some of the western states. A few of the experiments reported have been conducted only during one, two, or three seasons and under marked limitations of funds. Therefore, not all the quantities in equation (56) have been measured. Indeed, the rule has been, in the drier regions particularly, to neglect the quantities r , m , g , and D_f of equation (56), which results in the implication that $U = w$. On the other hand, some experimenters have recognized the fact that one or more of the quantities r , m , g , and D_f influence the crop yield, but as these quantities are controlled by natural conditions, some of which are difficult to measure, they have really investigated the relation of crop yield to the quantity w rather than to the quantity U . To make the results of field plot irrigation studies more nearly comparable, wherever conducted, it is desirable to

measure all sources of water, or at least to endeavor to make and report dependable estimates of amounts obtained from all sources. Measurement of the water received by the crop from all sources not only makes the results of field plot experiments in arid regions more nearly comparable, but also gives at least an approximation of the relation of crop yields to water consumed in semi-arid or humid regions.

217. Symbols and Curves. — For convenience in referring to crop yield, the symbol y is used in general to represent yield. The units in which y is measured are specified on the figure for each crop according

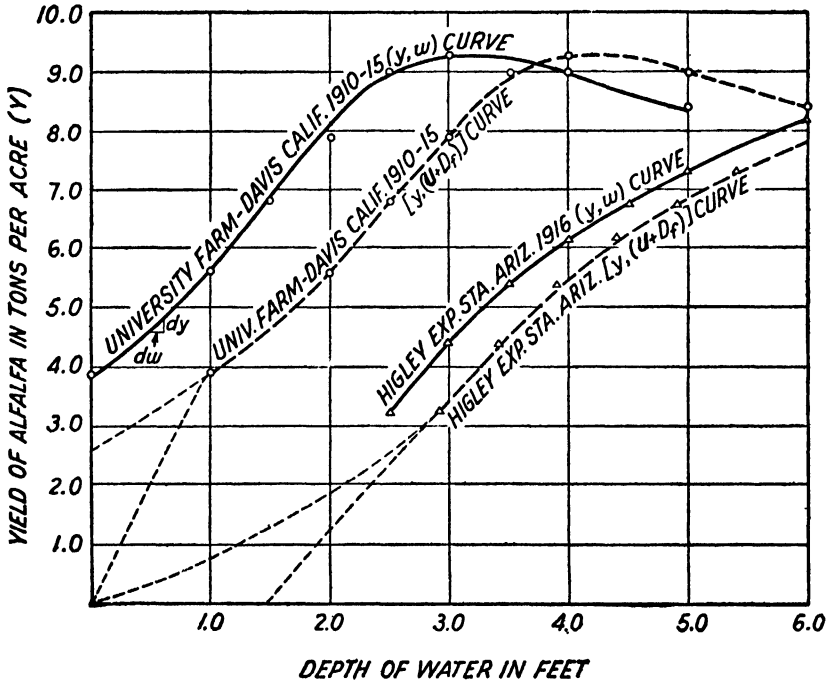

FIG. 116. — Yield-water curves for alfalfa at Davis, California and Higley, Arizona.

to common usage. Using the symbol y to represent yield, a general relation may be stated, namely:

$$y = \text{a function of } U \dots \dots \dots (57)$$

Equation (57) asserts that crop yield is influenced by, or depends in part on, the amount of water used, or in other words that the crop yield is in some way related to the water consumed. The experimental results reviewed in this chapter show what this relation of y to U is under the soil and climatic conditions of the several experiments. The relation is

most easily understood by presenting the results of the experiments in the form of graphs. The crop yields are represented by distances along the vertical, or Y axis, and the amounts of water consumptively used are represented by distances to the right along the horizontal, or X axis. Because it is not always possible from the available records to make reliable estimates of the quantity U , whereas the quantity w is always reported, many of the curves presented represent crop yields produced

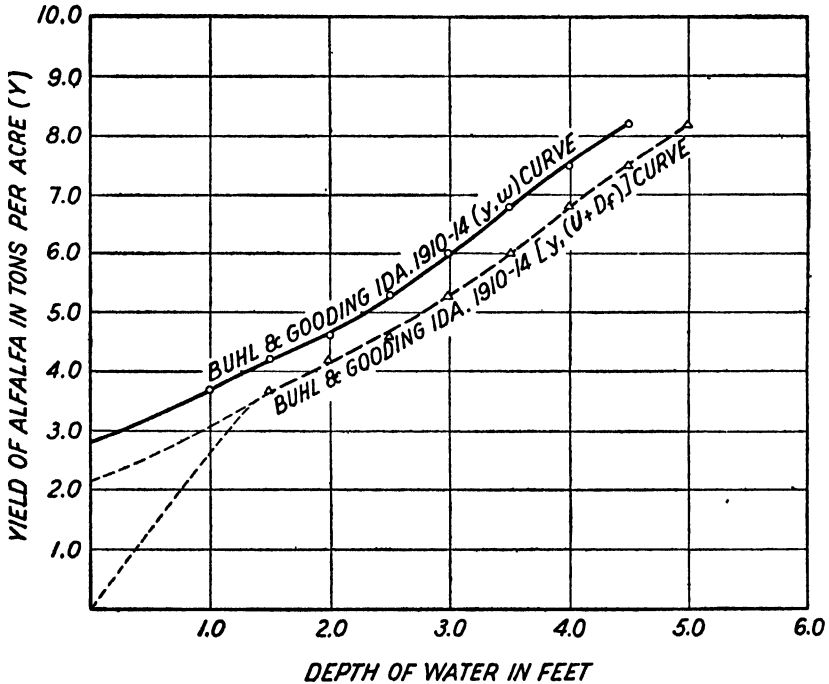

FIG. 117. — Yield-water curves for alfalfa at Buhl, Idaho.

with different amounts of irrigation water, w . These curves are designated (y, w) curves. Under soil and climatic conditions like those on the University Farm at Davis, California, and the Greenville Experiment Farm at Logan, Utah, where the annual rainfall is 17 inches, approximately, appreciable yields of alfalfa and of wheat are obtained without irrigation water. The (y, w) curves of these crops therefore intersect the Y axis above the origin, or zero point. If for a particular experiment $g = 0$, but m and D_f are not known, whereas w and r are reported, then the curve representing the experimental results is designated $[y, (w + r)]$ curve. On the other hand, if all the quantities $w, r,$

m , and g are known and there is good reason to assume that $D_f = 0$, then the curve is designated as a (y, U) curve.

The major purpose in presenting the results of typical experiments as represented by Figs. 116 to 126 is to show the trend of yield-water relations, thus making clear the basic principle involved without attempting

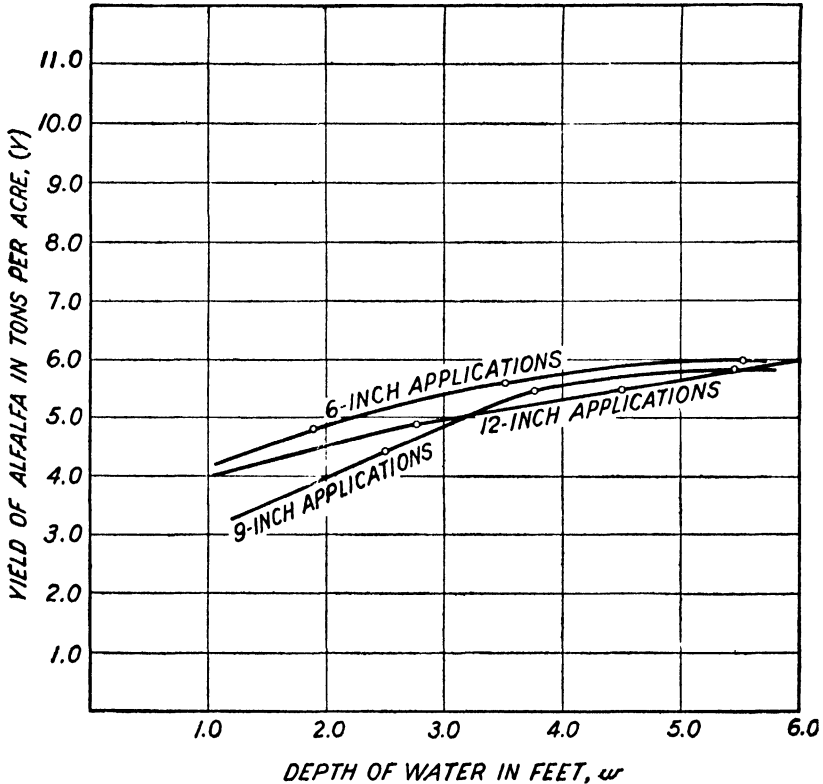

FIG. 118. -- Yield-water curves for alfalfa at Reno, Nevada.

fully to review all the experimental data now available. Basic crops such as alfalfa, wheat, potatoes, and sugar beets are considered.

218. Alfalfa Experiments. — The relations of alfalfa crop yield to water used, as determined in field plot measurements in Arizona, California, Idaho, Nevada, New Mexico, and Utah, are presented in Figs. 116 to 120. The horizontal axis of each figure represents depth of water annually, in feet. Where only irrigation water is considered the curve is designated a (y, w) curve, as heretofore stated. There have been no attempts to measure the quantity g in the studies reported. The quan-

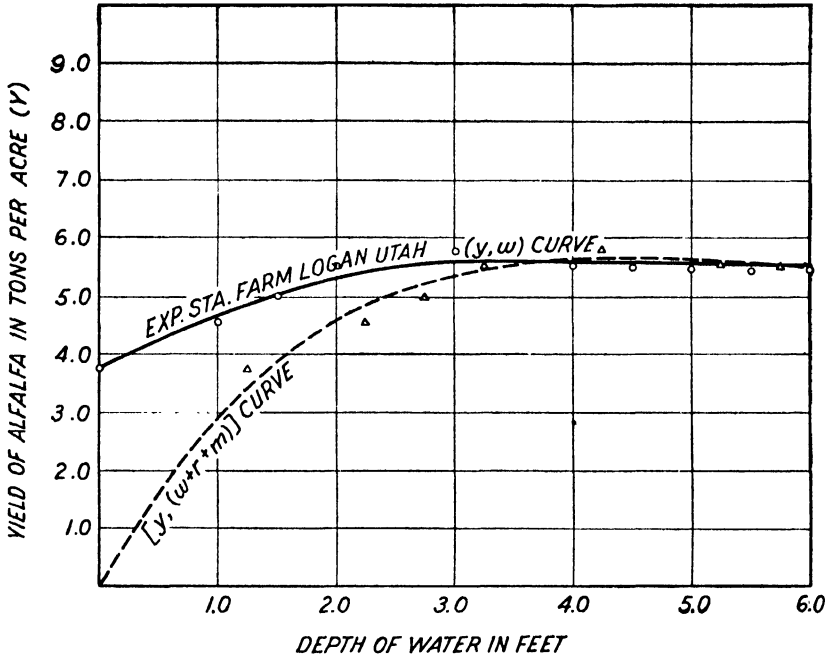

FIG. 119. — Yield-water curves for alfalfa at Logan, Utah.

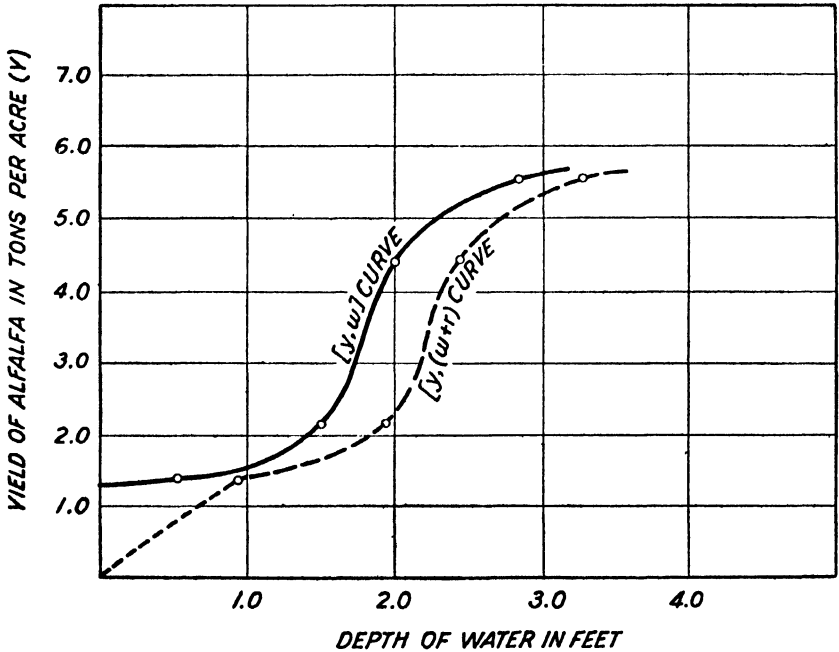

FIG. 120. — Yield-water curves for alfalfa at Richfield, Utah.

tity D_f is merely estimated as large or small in connection with each particular case.

Details with reference to soil conditions, precipitation, depth to water table, size of plots, and maximum crop yields are summarized in Table XXXI.

TABLE XXXI

SOIL CONDITIONS, PRECIPITATION, DEPTH TO WATER TABLE, ETC., AT EACH OF THE SEVERAL AGRICULTURAL EXPERIMENT STATIONS WHERE STUDIES ON THE RELATION OF ALFALFA YIELD TO WATER CONSUMED WERE CONDUCTED

State and City	Class of Soil	Depth of Water Table, Feet	Approximate Average Annual Precipitation, Inches	Length of Exp., Years	Maximum Yield, Tons	Area of Plots, Acres
Higley, Ariz...	Maricopa sandy loam	Over 100	6	1	8.2	0.01
Davis, Calif....	Yolo loam	20-30	17	6	9.2	0.28
Idaho.....	Medium clay loam	9	5	8.2
Nevada.....	Shallow loam, gravel, sand subsoil	5	6.0	0.15
Logan, Utah...	Greenville loam	60-80	17	28	5.8	0.04
Richfield, Utah	Redfield fine sandy loam	50-70	8	2	5.5	0.58

Fig. 116 shows a relatively large consumptive use of water for production of alfalfa at Higley, Arizona, as compared to the consumptive use at Davis, California. For example, considering irrigation water alone, w , in order to produce a 6-ton crop at Higley 3.9 feet of water were used as compared to 1.2 feet at Davis. The water table at Higley is 100 feet deep or more, and hence it is very probable that the quantity g of equation (56) is negligible or zero. Measurements of the sum of m and r for several crops and in many trials at the Utah Station shows that $m + r$ averages about 60 per cent of the annual rainfall. Estimating $m + r$ for Higley and other stations where these quantities have not been measured it is apparent, from equation (56), if $g = 0$, that

$$U + D_f = w + 0.6R$$

where R = the annual rainfall. Proceeding on this basis, the broken-

line curve for Higley was plotted. If the quantity $D_f = 0$, then probably the broken-line curve passes through the origin, for when $U = 0$ it is certain that $y = 0$, because there can be no crop yield without use of some water. However, the quantity y may equal zero when U is greater than zero because there may be, and usually is, some water lost from the surface of an experimental plot by evaporation even though no crop is produced. It is by no means certain that $D_f = 0$ for the Higley experiments. Fig. 116 shows by extending the broken-line Higley curve to the horizontal axis the sum of $U + D_f$ would equal 1.5 feet when $y = 0$. Since it is very improbable that y would be zero if $U = 1.5$ feet, it follows that D_f was probably a significant quantity, or in other words, that an appreciably large amount of water was lost from the Higley plots through deep percolation.

Extending the broken-line Davis curve to the Y axis indicates that when the sum $U + D_f = 0$, the alfalfa yield was approximately 2.5 tons per acre. But it will be remembered that the $[y, (U + D_f)]$ curve for alfalfa at Davis was made on the basis of the assumption that the quantity $g = 0$. It is obvious that U could not equal zero when $y = 2.5$ tons, because crops cannot grow without consuming water. Therefore, since the sum $U + D_f = 0$ when $y = 2.5$ tons, and since U must be greater than zero, it is apparent for the check plot on which $w = 0$ that

$$U = m + r + (g - D_f) > 0^*$$

At Davis, California, $r = 0$, as a rule, and m is greater than zero. Therefore, since $m + (g - D_f) > 0$, it follows that the crop on the check plot for which $w = 0$ probably received some water from ground-water sources. If D_f were zero then g may equal zero and still satisfy the above relation, meaning in this case that the water stored in the soil from the winter rains was the only source of supply to produce 2.5 tons of alfalfa.

The speculations of the foregoing paragraph indicate some of the difficulties in interpreting experimental observations of the relation of crop yield to water consumed and stress the importance of measuring the water obtained from all possible sources.

Deep percolation is probably a greater source of loss than is ordinarily recognized, but in experimental plots it is of course probable that the plots on which w is large sustain the greater percolation losses.

Complete saturation of the soil pore space is not essential to cause appreciable percolation losses. For example, consider an ideal soil of uniform texture and structure having a capillary moisture content and

* The symbol $>$ means "is greater than."

distribution such that there is no *unbalanced* capillary force. The net downward force would then be 32.2 pounds per *unit mass* (foot-pound-second units), and the downward flow, as given by Table XX would be 0.3 cubic foot per square foot per 24 hours for a soil having a specific water conductivity of 1.08×10^{-7} . If such a soil moisture condition were maintained during one-half the time of a 4-month irrigation season the total downward flow of capillary water, i.e., D_f , would be equal to $60 \times .03 = 1.8$ cubic feet per square foot. However, the specific water conductivity probably decreases with decrease in moisture content, and it is therefore probable that deep layers of fine-textured *dry* soils under experimental plots may form an effective temporary barrier to excessive deep percolation losses of water in the capillary form.

The foregoing statements of possible conditions regarding ground-water contributions and deep percolation losses at Davis, California, are given for the purpose of indicating the problems which confront those who conduct experiments on consumptive use-yield relations. Though admittedly conjectural as to the proper interpretation of experiments already completed, such analysis may be helpful to those who plan new experiments to be conducted on field plots.

Comparisons of Figs. 116 to 120 show that in only one case an excessive amount of water actually caused a decrease in alfalfa yield. At Davis, California, the yield for $w = 5$ feet is almost 1 ton less per acre than it is for $w = 3$ feet. All the other alfalfa experiments reported, except those at Logan, Utah, show a continuous increase in y as w is increased. It is important to note, however, that the greater *rate* of increase in yield with increase in water usually occurs in the region of smaller quantities of water. For example, at Davis, California, an increase in w from 1.0 foot to 1.5 feet caused an increase in y of 1.2 tons, whereas increasing w from 2.5 to 3.0 feet increased y only slightly more than 0.2 ton. The *rate* of change of y with w is designated by the ratio dy/dw , as indicated on the University Farm (y, w) curve of Fig. 116. This ratio dy/dw is designated the slope of the curve at any point on the curve. On the (y, w) curve of Fig. 116 for the Davis experiments, for values of w greater than 3 feet, y decreases, and hence the slope of the (y, w) curve is negative. The slope of the (y, w) curve of Fig. 119 representing the alfalfa experimental work at Logan, Utah, is relatively small even for small values of w , and for values of w in excess of 2.5 feet $dy/dw = 0$, approximately, meaning that further increase in w gives substantially no change in the yield of alfalfa. The rate of increase dy/dw in the Sevier Valley, Utah, as shown on Fig. 120, is quite high between values of w from 1.5 to 2.0 feet, but dy/dw becomes smaller for values of w over 2 feet, and the form of the curve suggests that it

would have been zero at a w not greatly in excess of the maximum w actually used.

219. Using Experimental Results. — Students of irrigation problems early learn that making proper use of results of experimental data is a desired goal difficult of attainment. Some dependable conclusions are easily reached in examination of a (y, w) curve like the one representing the results of the Davis experiments. For example, it is obvious that under the conditions of the Davis experiments amounts of water in excess of 3 feet are detrimental to the crop and are wastefully used. However, to ascertain the w that will assure the most economical use of water is a more difficult task. Different cost factors and also differences in crop values influence this essential determination. A general solution of the problem showing how to determine the most economical w was developed by Harry S. Clyde while working under the direction of Dr. Willard Gardner and the author. This solution is considered in Chapter XVIII. The utility of the solution referred to rests on the establishment experimentally of reliable (y, w) curves for many crops on different soils in various irrigated regions, and on having available complete and dependable cost data and crop prices. Therefore, before studying thoroughly the general method of interpreting or using experimental results of yield-water curves the student will probably be interested in examining the results of experiments with some important grain and root crops.

220. Grain Crops. — Results of field plot experiments on the relation of water used to yield of wheat, oats, and corn at Logan, Utah, and wheat at Gooding, Idaho, are presented in Figs. 121 to 124 inclusive. Each (y, w) curve shows a measurable decrease in y when w is very large. Fig. 121 reports 28 years of experimental work on the relation of y to w and y to $(w + r + m)$ for wheat production on the Greenville Farm at Logan, Utah. It shows that an average of approximately 35 bushels of wheat per acre can be produced without irrigation. The curve shows very little advantage, if any, in using a w in excess of 1 foot, a slight decrease in y for w over 2 feet, and up to 4.5 feet. Remembering that, for Greenville soil, the quantity $g = 0$, and assuming that on the wheat plots which received very small amounts of water $D_f = 0$, it follows from equation (56) that $U = w + r + m$. For wheat $r + m = 1.15$ feet, as stated in Chapter XIV. On this basis, the broken-line curve of Fig. 121 is constructed. As heretofore shown, the (y, U) curve must either pass through the origin or intersect the X axis to the right of the origin.

Fig. 122 presents the $[y, (w + r)]$ curve for spring wheat at Gooding, Idaho. Definite knowledge as to m and g at Gooding is not available.

Figs. 123 and 124 present the results of extended experiments concerning the influence of water on the yield of oats and corn near Logan, Utah,

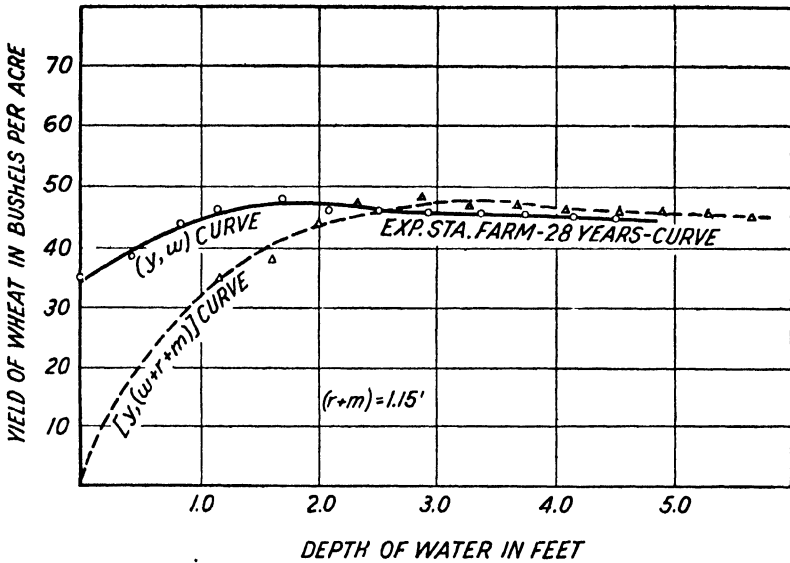

FIG. 121. — Yield-water curves for wheat at Logan, Utah.

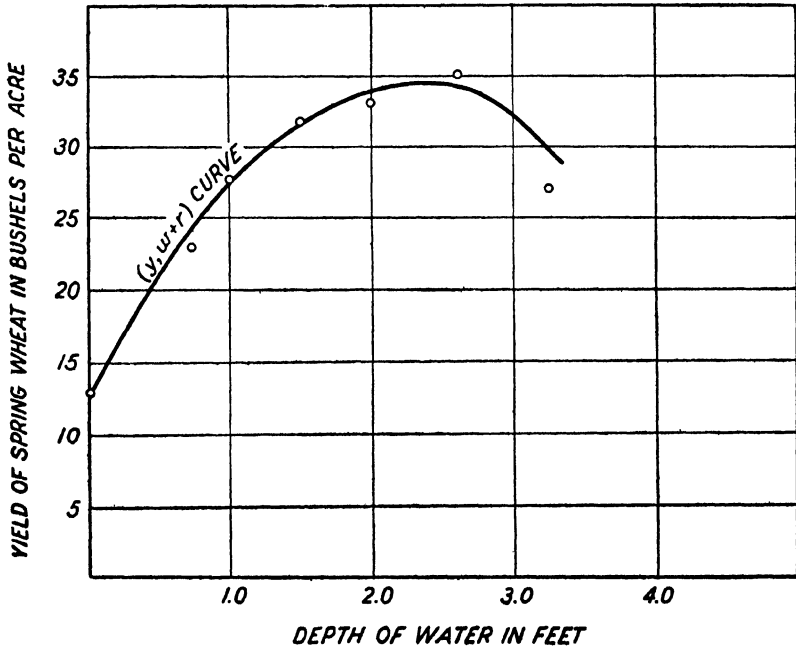

FIG. 122. — Yield-water curve for spring wheat at Gooding, Idaho.

on the Greenville Farm. Both figures show a marked decline in the yield for excessive amounts of water.

Fig. 123 shows that dy/dw is negligible for values of w in excess of 2 feet for oats, and Fig. 124 shows a similar condition for corn with values of w greater than 1.5 feet.

221. Root Crops. — Figs. 125 and 126 present the results of 28 years' work with potatoes and sugar beets, respectively. That potatoes are

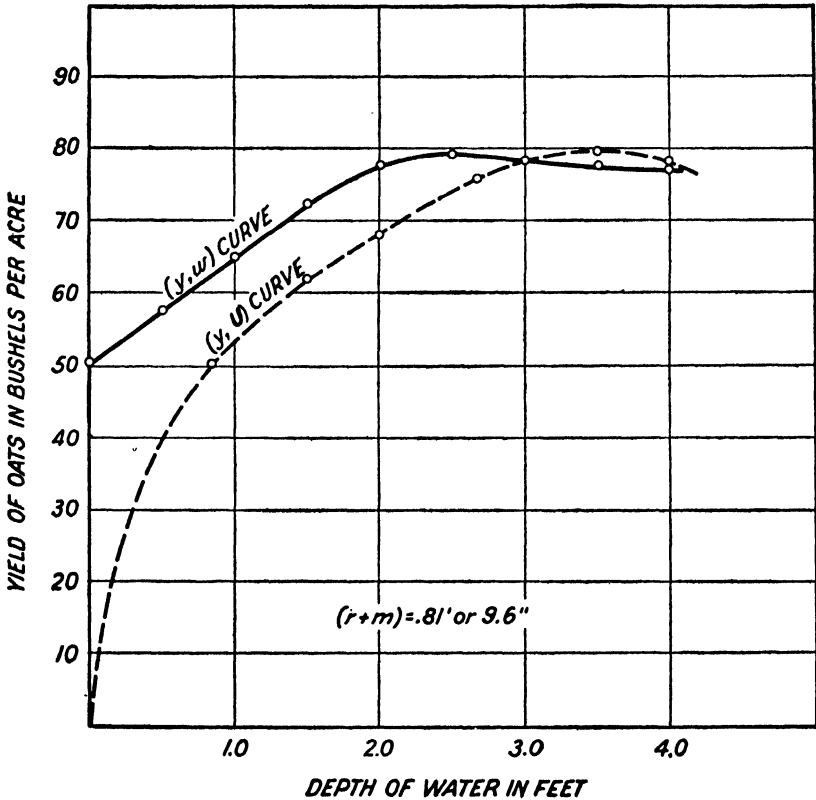

FIG. 123. — Yield-water curves for oats at Logan, Utah.

very sensitive to irrigation is apparent from Fig. 125, which shows a steep (y, w) curve, or large values of dy/dw for both deficient and excessive amounts of water. For amounts of w over 2.5 feet, dy/dw is very small; it is zero at $w = 3.0$ feet and negative for w in excess of 3 feet. Fig. 126 shows that dy/dw is very small for w over 2 feet, zero at 2.5 feet, and negative beyond.

222. **Diminishing Returns.** — The curves presented in this chapter are to be considered as typical of a general relation between crop yield and water used. No attempt is made to present all the available experimental results bearing on the problem. A complete report of all the results is impracticable because of the large space such a report would

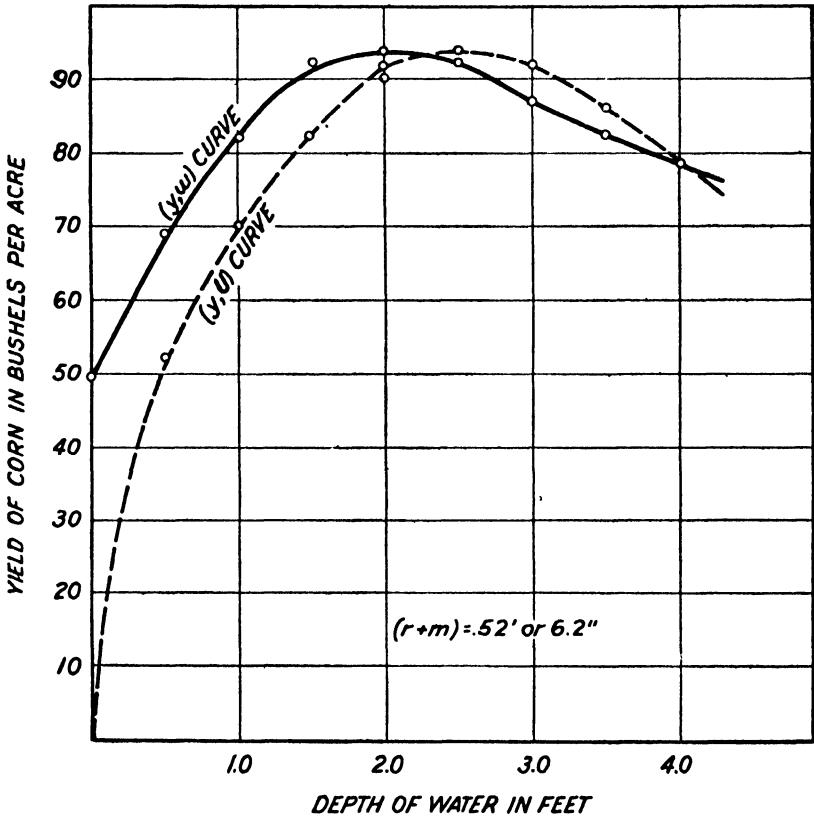

FIG. 124. — Yield-water curves for corn at Logan, Utah.

require. Moreover, reporting all available data is not essential to the purposes of this chapter. Suffice it to say that a large body of experimental data supports the general conclusion that, for most of the important crops produced under irrigation, the law of diminishing returns applies when the quantities w and U are increased beyond a certain minimum which is essential to the maturity of any crop. The application of this law is illustrated by measuring the slope of the curve at any point on the curve, whether it be a (y, w) or a (y, U) curve. Naturally,

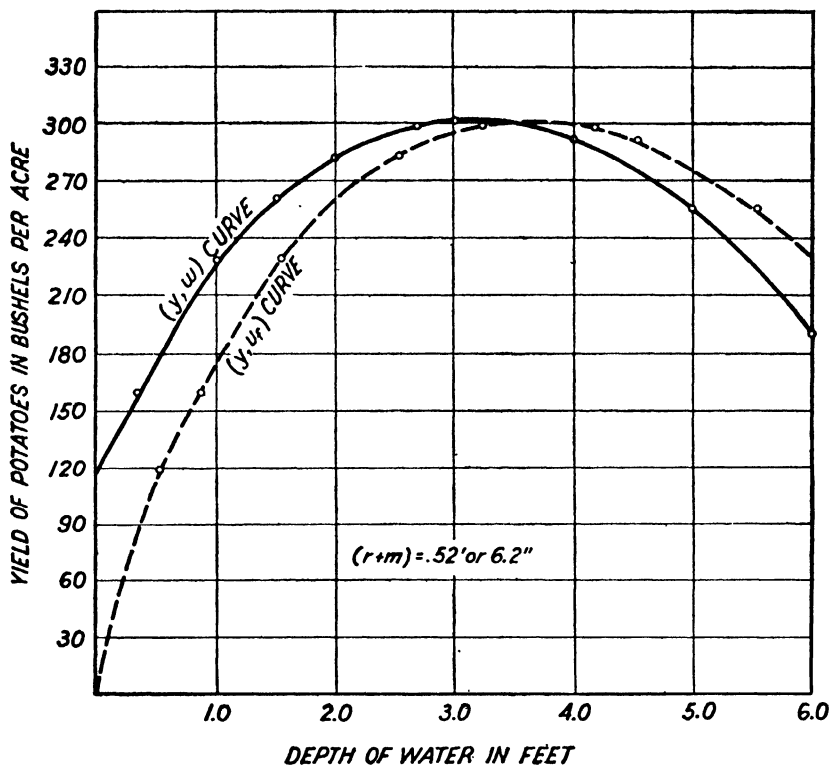

FIG. 125. — Yield-water curves for potatoes at Logan, Utah.

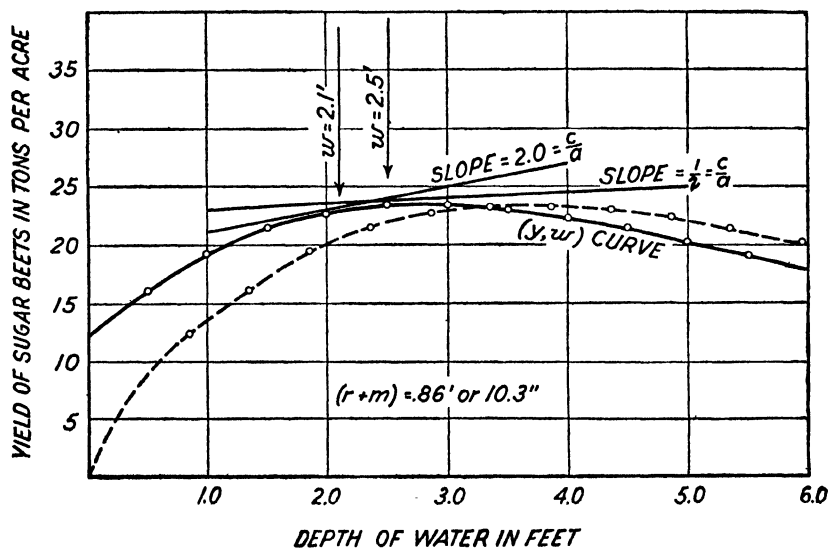

FIG. 126. — Yield-water curves for sugar beets at Logan, Utah together with the slope of the (y, w) curve at points where $w = 2.1$ feet and 2.5 feet. (279)

a sound interpretation of the (y, w) curve is of particular significance because, under proper conditions of storage of water, man has complete control of w , no control of r , and only partial control of D_f , m , and g . The region of the (y, w) curve immediately to the left of the point of maximum crop yield is of special importance. If water costs are very low and crop values comparatively high, it may be most economical to apply the w that gives the maximum yield. On the contrary, high water costs and low crop values tend to make lesser amounts of water more economical. The basis and procedure essential to a reliable interpretation of the (y, w) curve are further considered in Chapter XVIII.

REFERENCES

- ADAMS, FRANK, ROBERTSON, RALPH D., BECKETT, SAMUEL H., HUTCHINS, WELLS A., and ISRAEISEN, O. W. Investigations of the Economical Duty of Water for Alfalfa in Sacramento Valley, California, State of Calif. Dept. of Eng. 1917.
- BLOODGOOD, DEAN W., and CURRY, ALBERT S. Net Requirements of Crops for Irrigation Water in the Mesilla Valley, New Mexico, N. M. Agr. Exp. Sta. Bul. 149. 1925.
- CLYDE, HARRY S., GARDNER, WILLARD, and ISRAEISEN, O. W. The Economical Use of Irrigation Water Based on Tests, Eng. News-Record, 91, No. 14 : 548. 1923.
- FORTIER, SAMUEL. Irrigation Requirements of the Arable Lands of the Great Basin, U. S. D. A. Dept. Bul. 1340. 1925.
- HARRIS, F. S., and PITTMAN, D. W. The Irrigation of Alfalfa, Utah Agr. Exp. Sta. Bul. 180. 1921.
- ISRAEISEN, O. W., and WINSOR, LUTHER M. The Net Duty of Water in Sevier Valley, Utah Agr. Exp. Sta. Bul. 182. 1922.
- KNIGHT, C. S. Irrigation of Alfalfa in Nevada, University of Nevada Agr. Exp. Sta. Bul. 93. 1918.
- MARR, JAMES C. The Use and Duty of Water in the Salt River Valley, University of Arizona Agr. Exp. Sta. Bul. 120. 1927.
- SNELSON, W. H. Irrigation Practice and Water Requirements for Crops in Alberta. Dept. of the Interior, Canada, Irrigation Series Bul. 6. 1922.
- WELCH, J. S. Experiments with Legume Crops Under Irrigation, University of Idaho Agr. Exp. Sta. Bul. 94. 1917.
- WIDTSON, JOHN A. The Production of Dry Matter With Different Quantities of Irrigation Water, Utah Agr. Exp. Sta. Bul. 166. 1912.



PLATE V. — Irrigated long staple cotton, Rio Grande Project, New Mexico — Texas.
(Courtesy: U. S. Bureau of Reclamation.)



PLATE VI. — Elwood Mead, D.Eng., Commissioner, United States Bureau of Reclamation. Eminent Irrigation Authority.

CHAPTER XVI

SOCIAL AND ADMINISTRATIVE ASPECTS OF IRRIGATION*

Some national governmental agencies throughout the world have been active in construction of irrigation projects and in management of the enterprises after construction was completed. The work of the English government in cooperation with the Indian government in India and with other governmental agencies in Egypt and in Australia is especially noteworthy. Discussion of irrigation organization and administration here is confined to the types of irrigation enterprises in the arid regions of the United States. There are, broadly speaking, two types, namely, private and public. Private enterprises include individual projects, and mutual and commercial company organizations. The public enterprises naturally fall into two rather distinct classes, namely:

- (1) Those in which public laws prescribe procedure and public agencies participate in the organization and management of the enterprise without assuming any direct financial responsibility, herein designated as quasi-public; and
- (2) Those organized under public laws, administered by public agencies, and financed with public funds, here designated as public irrigation enterprises.

Projects constructed under the Federal Desert Land Act and the Carey Act, together with those under the several state irrigation district acts, are considered quasi-public; and those financed by public agencies, whether city, state, or federal, are considered as public projects.

223. Individual Enterprises. — Comparatively few irrigation projects are built and operated by individuals working alone. Small streams closely adjacent to arable land in isolated sections favor individual effort in irrigation. Also, where ground water is available for pumping, or where other water sources may be best developed by small pumping plants, individuals build and operate their own irrigation projects. The advantages claimed for individual enterprises are that they permit the farmer to irrigate at any time he desires, so that he can regulate his own

* Parts of this chapter are taken from a chapter on Irrigation Organization and Administration prepared by the author for the Agricultural Engineering Handbook to be published by the McGraw-Hill Book Company.

practices, and that he is independent of the assessments, rules, regulations, and irrigation practices of his neighbors.

Individual irrigation activity is usually more expensive than the combined activity of groups who need irrigation water, and, moreover, it is rigorously restricted by nature since it is quite impossible, as a rule, for the farmer to build the storage works, diversion weirs, and canals necessary to provide water for lands which are at great distances from the sources of water supply.

224. Mutual Associations. — Beyond the capacity of the individual to develop, there are water resources and arable lands which can be brought together by small groups of individuals forming voluntarily an association for the purpose of constructing and operating an irrigation system. The perpetuity of the unincorporated mutual association, sometimes designated as a mutual company, rests largely on the fairness and congeniality of each member, because the association provides no means of legally enforcing the payments of dues or of enforcing contributions in other ways to the expenses of maintenance, betterments, renewals, and operation or expansion of the project. In general, the major asset of the association is the labor of its members. Its activities are limited to small projects which require no difficult construction and but little capital.

225. The Mutual Irrigation Company. — A corporate* body of irrigators, voluntarily organized for the purpose of supplying water to its stockholders, is known as a mutual company. It is a non-profit organization for the delivery of water at cost to its members only. It obtains its revenues by stock assessments, and its dividends consist of water delivered in proportion to the stock owned by each irrigator. It enforces payment of assessments by the sale of stock if necessary. The stockholders delegate the responsibility of management to a board of directors, from three to seven or more, elected by ballot. Each stockholder has as many votes as he owns shares of stock. The tenure of office of directors, fixed by the articles of incorporation, ranges from one to three or more years. The directors elect one of their members as president and appoint a secretary, treasurer, and water master, any of whom may or may not be directors. The functions of secretary and treasurer are common to these offices in all corporations; the function of the water master is unique to irrigation companies. In the small irrigation companies the water master has charge of the project operation and maintenance including the distribution of water to stockholders. The water master on many projects, with the aid of crude check gates,

* Incorporation, though usually advisable, is not essential to the creation of a mutual company. In this article only corporate mutual companies are considered.

take-out gates, and diversion structures, is expected to distribute equitably a valuable commodity to numerous claimants. The average irrigator cannot measure water, and hence it is easy for him to feel that he is receiving less than the amount to which he is entitled and that some favored stockholder is getting too much. The result is that the water master, during the months of low stream flow, and particularly during the "dry" years, is a target for considerable unjust criticism.

The larger mutual companies sometimes employ an engineer-manager who is given the responsibility of water distribution, and to whom the water masters, one for each of several districts, are instructed to report. Though required to conform to state corporation laws, the mutual company has wide flexibility. It is especially suited to maintenance and operation of irrigation projects and is the "dominant type of operating organization in Colorado, Utah, and Southern California (aside from Colorado River areas); is prominent in portions of Montana, Wyoming, Idaho, and Oregon, and one phase is widespread in New Mexico."*

Mutual companies are as a rule exempt from general taxation so long as they are used for the service of their own members only. Some states relieve mutual irrigation companies from the payment of the license tax assessed against corporations.

226. Commercial Companies. — The irrigation enterprise which supplies water for compensation to irrigators who have no direct financial interest in the irrigation works, or who hold an equity which has not yet ripened into actual ownership and control, is designated a commercial irrigation company. Some commercial companies furnish water on an annual rental basis; others sell the prospective irrigator a water right and in addition charge an annual rental; and some sell a water right which carries with it a perpetual interest in the irrigation system. Commercial enterprises of the latter type ultimately become mutual companies in which the irrigation works are owned and operated by the irrigators. Service rates of companies furnishing water on an annual rental basis are generally subject to public regulation as a result of dedication of the water to public use. The annual rentals charged by companies which sell water rights are not subject to public regulation if the contracts for sale of rights and charging of rentals are held to be private contracts.

Large sums of money have been lost by investors in commercial irrigation projects, owing chiefly to the failure to "tie" the water to the land, *faulty colonization methods, inadequacy of private contract operation charges, and inability of users under public utility irrigation enterprises to pay adequate rates.* Securities of commercial companies are not, as a

* Hutchins, Wells A., Mutual Irrigation Companies, U. S. D. A. Bul. 82. 1929.

rule, popular in the financial markets, and the position of this form of organization in irrigation development is less influential than that of other types of enterprises. *The most important practical problems connected with these companies today are involved in the public regulation of their rates and service.*

Hutchins has recently given special consideration to a study of commercial irrigation companies. His conclusions as to present usefulness of commercial companies as a means of best serving the interests of water users are given below:

“ During an agricultural depression water users may be individually better off under a utility than under a community organization, if they can convince the rate-fixing commission that existing charges are higher than the lands can stand. Reduced rates, however, will probably mean poorer service. Aside from this doubtful advantage, the water user ordinarily has little reason to prefer the public utility to the district or mutual company from the standpoint of operating the system serving him or improving its facilities, provided he chooses the directors of his community enterprise wisely and is willing to spend the money necessary to hire an able executive. With equal managerial ability and authority, an irrigation district can be operated more economically than a utility, because of its power to spread charges over all irrigable areas and for other reasons, . . . and is therefore more desirable from the rate-payer's standpoint. District and mutual company charges, furthermore, include amortization of the cost of construction, rather than a perpetual profit to outsiders on capital invested. District bond markets have been active at certain periods during the present century, whereas money for commercial enterprises has been increasingly difficult to obtain. Consequently the possibility of financing needed storage, extension, and improvement work through district bond issues has been a most important inducement to water users to buy commercial systems serving them, districts being preferred to mutual companies primarily because of their better bond markets. In view of these conditions, the trend from commercial to district ownership of irrigation works has been marked, especially during the past 12 to 15 years; and with the district's superiority for operation and supplemental development purposes established, there is no apparent reason why the trend should not continue.”

227. Desert Land Act. — To encourage the irrigation of the public arid lands, Congress in 1877 provided that any citizen over 21 years of age may obtain title to 640 acres of desert land upon providing for its irrigation and paying a nominal fee. In 1891 the area was restricted to 320 acres. Entry men are required to pay 25 cents an acre at the time of filing, and to make an expenditure of not less than \$1.00 an acre during each of the first three years. A period of four years, with a possible extension of three years, is allowed in which to complete the require-

ments of the Land Office. The act is operative in all the irrigation states but Kansas, Nebraska, and Oklahoma. The only residence requirement is that the applicant must reside in the state. The act has been very popular.

228. The Carey Act. — To avoid the repetition of irrigation project failures which occurred in private irrigation development during the years 1880 to 1893, Congress, in 1894, passed the Carey Act, named for Senator Joseph M. Carey of Wyoming. By the Carey Act, the Secretary of the Interior, with the approval of the President, was authorized to grant each state having desert lands an area not exceeding 1,000,000 acres of such lands "as the state may cause to be irrigated, reclaimed, occupied, and not less than twenty acres of each one hundred and sixty-acre tract cultivated by actual settlers, within ten years after the passage of this act." In 1896 Congress authorized the state to create liens to cover construction costs and provide that patent should issue to the state when a water supply was available, without regard to settlement or cultivation, but that the United States should in no way be liable for such a lien.

In 1901 the 10-year period was made to "run from the date of approval by the Secretary of the Interior of the State's Application for the segregation of such lands," and the Secretary was authorized to grant an extension, not exceeding five years.

Twelve states, by exacting the necessary legislation, have accepted the provisions of the Carey Act, and reclamation under its provision has been accomplished in Colorado, Idaho, Montana, Oregon, and Wyoming, the act having been followed most extensively in Idaho and Wyoming. The Carey Act proceedings for the state have been entrusted to a special board that receives the application from the contractor who initiates the project. The requests to the Secretary of the Interior for segregation are made by the board, which also announces the price to be paid to the state for the land and to the contractor for a perpetual water right. Upon payment of a sufficient part of the water-right charges to the contractor, the management of Carey Act projects usually passes to the irrigators, and the development company is succeeded by a mutual irrigation company.

229. Irrigation Districts. — An irrigation district is a quasi-public corporation for providing water for lands within its boundaries.

The fundamental attributes to an irrigation district are authoritatively given by Hutchins* as follows:

* Hutchins, Wells A., *Irrigation Districts, Their Organization, Operation and Financing*, U. S. D. A., Technical Bul. 254. 1931.

" It is a public corporation, a political subdivision of a State with defined geographical boundaries. It is created under authority of the State legislature through designated public officials or courts at the instance and with the consent of a designated fraction of the landowners or of the citizens, as the case may be, of the particular territory involved. Being public and political, the formation of a district is not dependent upon the consent of all persons concerned, but may be brought about against the wishes of the minority. In this respect the district differs fundamentally from the voluntary mutual company and the commercial irrigation company.

" It is a cooperative undertaking, a self-governing institution, managed and operated by the landowners or citizens within the district. Supervision by State officials is provided for to the extent of seeing that the laws are enforced, and in most States is extended in greater or less degree over organization, plans and estimates prior to bond issues, and construction of works.

" It may issue bonds for the construction or acquisition of irrigation works, which bonds are payable from the proceeds of assessments levied upon the land.

" Hence, it has the taxing power. Each assessment becomes a lien upon the land. While the ultimate source of revenue, therefore, is the assessment, an additional source frequently provided for is the toll charged for water.

" Other revenue may in some cases be obtained from the sale or rental of water or power to lands or persons outside the district.

" Finally, the purpose of the irrigation district is to obtain a water supply and to distribute the water for the irrigation of lands within the district. Additional authority is granted irrigation districts, almost without exception, to provide for drainage. In some States districts may also develop electric power. These additional powers, however, are subsidiary and are intended to make more effective the principal function of the organization, which is to provide irrigation water."

Approximately five-eighths of the irrigation districts created in the West are classed as successful, and three-eighths are inoperative. Hutchins' excellent recent summary (1931) of reasons for failure or success of irrigation districts is of value not only to those who are interested in irrigation districts but to all students of irrigation, and is therefore given below:

REASONS FOR SUCCESS OR FAILURE

" The successful irrigation districts are those in which, in addition to securing and distributing water effectively, annual income is derived from the soil year after year in amounts sufficient to pay interest and maintenance and operation charges promptly and to retire the principal of the bonds at maturity. If such conditions obtain, the project is said to be economically feasible. The experience of irrigation districts has shown that economic feasibility depends upon (1) productivity of soil; (2) sufficiency and stability of water supply; (3) soundness of

construction and adequacy of service of irrigation and drainage works; (4) settlement of the land by farmers of character, ability, and means; (5) availability and capacity of markets; (6) reasonableness of capital and operating charges; and (7) allowance for a wide margin of safety, or permissible cost, above the charge determined upon as reasonable, which the lands must be able to bear if the project is to be considered feasible.

"The sixth and seventh elements together depend directly upon the five preceding ones and become the final measure of economic feasibility. Changes in the physical and economic conditions involved in the other elements necessarily affect the annual charges in greater or less degree, either by way of increasing or decreasing the absolute costs or by changing the relative capacity of district lands to bear the fixed costs. Hence, a given annual charge may be reasonable at one time under a certain combination of conditions yet may prove unreasonably high at another time under entirely different conditions. There is no formula by which economic feasibility may be unalterably determined. Nevertheless, soil, agronomic, and engineering determinations may be carried to a satisfactory degree of refinement, and the need for a proposed development may be judged on the basis of physical and economic conditions and trends evident at the time the project charges are under consideration, with a wide margin of safety to allow for unfavorable changes not then foreseen. Experience of the 10 years following the World War shows all too clearly the necessity for laying more stress upon this seventh fundamental.

"Types of agriculture may and do change. It appears that certain new districts capitalized on the basis of high-value crops would have been better off if their financing had been based altogether upon the probable returns from lower-value crops of proven adaptability. That done, the prospective ultimate establishment of a type of agriculture promising greater profits would tend to a sounder development and thereby enhance the security for the district's bonds.

FAILURE

"Past causes of failure of irrigation districts may be reduced to the following general classes:

(a) "Some of the earliest districts met disaster or at least years of obstruction because of the inclusion of too much land belonging to persons opposed to district organization. This cause of failure, while still to be reckoned with, is not so pronounced as it was some years ago.

(b) "Inclusion of large areas of land incapable of bearing their share of the burden of taxation has resulted in considerable trouble. It is the area that is actually irrigable and capable of producing satisfactory crops that in the last analysis is responsible for the district debts. This is true from the standpoint of bondholders in any event, and also from the standpoint of assessment payers in the large number of States which provide for general liability of all lands for payment of obligations. So-called "shoestring" and "spotted" development, resulting in disproportionate maintenance and operating expenses, has likewise been unfavorable to success.

" Before public lands were made liable to inclusion within irrigation districts, some districts which had placed too great dependence upon the involuntary incorporation of such areas found themselves embarrassed by the lack of revenue therefrom.

(c) " Inclusion of more land than could be adequately irrigated with the available water supply has been a fruitful source of trouble to districts. Remedying such a situation necessarily involves a higher acreage cost than anticipated, either by securing additional supplies of water for the entire area or by eliminating portions of the district and concentrating all the water and all the cost on the remaining portions. In some cases this has not been fatal, but the wide margin allowed in other cases between the early productive value of the land and the cost of the irrigation system has been sufficient to cause failure.

(d) " A condition frequently found in irrigation districts promoted for profit has been the unduly large difference between the actual cost of construction and the price the settlers had to pay. For example, a system costing, say \$50 per acre, has sometimes been sold to or built for the settlers for \$75 per acre, the difference of \$25 per acre, or one-third of the bond issue, constituting promotion profits. Legislative attempts to prevent overcapitalization by providing that bonds should not be disposed of for less than 90 or 95, or even par, did not hinder promoters from placing excessive valuations upon the works and trading them for district bonds at what purported to be a legal figure. The difficulty with such an overcapitalized district was that the additional charge of \$25 per acre sometimes represented the difference between success and failure.

(e) " Unwise location of irrigation works, faulty design and construction, poor choice of materials, disaster to irrigation works, and unduly heavy maintenance and operation charges have been responsible for some of the troubles of irrigation districts.

(f) " Settlement of sufficient land to provide revenue for district requirements is vital to the success of any irrigation district. Irrigation enterprises of all types are dependent for eventual success upon the same thing; but the method of financing an irrigation district through the disposal of bonds makes the rapid settlement of land especially important for the district is dependent upon its own efforts for money to operate the system and must in addition provide for interest payments on bonds. Capitalization of interest on the bond issue eases but does not wholly relieve the situation. It is essential that the districts become self-supporting quickly. Coupled with such necessity is the need for having the right kind of settlers from the standpoint of integrity, industry, adaptability, and financial resources. Lack of adequate land occupation by capable and well-equipped settlers or of a workable colonization plan has been a source of trouble in a number of districts and has prevented the financing of others."

SUCCESS

" Some district enterprises in which the security for the bonded indebtedness remained to be created have attained success because they have combined the features necessary to rapid development of the land

and production of income. . . But the proportion of districts of this type that have proved successful from all standpoints is small in comparison with the proportion of successful districts in which at least a fair amount of the security existed at the time of organization. Supplemental development of itself does not insure adequacy of the security, as is evident from the numerous cases in which districts formed to take over and extend existing systems have added impossible burdens to lands already in a fair state of cultivation. Nor is the value of the lands at any particular time a safe measure of the security, inasmuch as land values change and their earning capacity varies with the demand for farm products to which they are adapted. While construction of entirely new irrigation works does not necessarily imply a speculative district enterprise, yet the status of districts formed for the several classes of irrigation development . . . indicates clearly that districts formed primarily for supplemental development have more generally attained their ends. Furthermore, the class of districts formed for extensions, betterments, and other supplemental purposes has provided relatively many more cases of perfect records in payment of bond obligations than have the groups organized for new construction. Supplemental development implies some prior development through which values have been created and irrigation works constructed and put into operation, together with a certain amount of income already accruing from irrigation. As the irrigation district is dependent upon revenue, it has followed that conditions making possible immediate and adequate revenue have gone far toward insuring financial success. Supplemental development naturally has more often embraced such conditions.

“As a general rule, therefore, the successful districts have been those formed for purchase and operation by the landowners of constructed systems which were “going concerns” for extension of existing systems to cover adjacent unirrigated lands where the cost of extension has not been so far out of proportion to the original cost as to cast an unduly heavy burden on the entire project, for improvement of existing systems, for providing needed additional amounts of water for already irrigated lands, for contracting with the United States on Federal reclamation projects for payment of construction and operation costs and for eventual operation, and for building new irrigation systems in sections already productive under dry-farming methods where development of irrigated farms has followed rapidly or where the cost of irrigation has been kept within the earning capacity of tracts partly irrigated and partly dry farmed. In any event, the irrigation districts that have kept up their payments of interest and principal have been those older districts with low capital and operating charges and those more recent ones that have had substantial reserves to tide them over the postwar depression.”

The achievements, the difficulties, the financing, and the pertinent legislative features of the several states are summarized by Hutchins as follows:

“Throughout the 44 years of its history the irrigation district has occupied an increasingly important place in western irrigation affairs.

In many sections of the West the district is now the dominant type of irrigation organization. At the end of 1928, 801 irrigation districts had been formed, of which 407 were then operating, 10 under construction, 82 in preliminary stages, and 302 inactive. The 499 active districts included 10,311,098 irrigable acres, of which 6,908,277 acres were in operating districts. Approximately 4,060,600 acres in operating districts received water in 1928 from district-operated systems.

"The district movement has encountered many vicissitudes. On the one hand, it has been exploited for the gain of individuals and has been used both honestly and dishonestly for the furtherance of developments which subsequently proved to be unsound. On the other hand, it has led in whole or in part to the establishment of many important agricultural communities and to the improvement of many others. . . .

Irrigation-district bonds aggregating \$224,843,197 had been sold to the end of 1928. Of this amount 71 per cent were then in good standing; that is, all payments of principal and interest so far due had been made in full. This percentage is the same as it was at the end of 1921 for bonds sold to that time. During the 18 months from January 1, 1929 to June 30, 1930, the development of fresh defaults has reduced this percentage to 67 or less. . . .

"The revenue of an irrigation district depends so largely upon the costs and returns of the landowners' individual business that it can not remain wholly unaffected by unfavorable economic conditions. Experience has shown the necessity for more extensive determinations of economic feasibility prior to district financing, and particularly for the inclusion in the cost estimates of a decidedly larger safety factor than was thought necessary 10 years ago. Maintenance of district bond integrity requires a full and frank recognition of this necessity. The only apparent alternative is the calling upon public or private investors to share in the cost of development. Public subsidy for irrigation is a controversial matter. The private investor in bonds for income purposes should obviously not be expected to incur a cost which experience shows to be in a large measure avoidable.

"The bonding feature has been and still is susceptible of abuse. Supervision by State officials over the organization and financing of districts has been of material influence in reducing the abuses. Such supervision may be made even more effective by amplifying the authority of the State officials and making adequate appropriations, particularly for determinations of economic feasibility.

"Certification of bonds by the State has been authorized by law in 10 States. In three States the certification laws have been repealed as a result of severe criticism of weak features. Certification is of little importance in district financing in several States, but it is very important and has strong backing in several others. . . .

"Several States have invested State funds in irrigation-district securities. Washington, Oregon, and Wyoming have done this with a view of aiding district development. The first two States have suffered extensive losses through such programs, while all irrigation district bonds bought by the State of Wyoming are in good standing.

"Many districts have had close relations with the Bureau of Reclama-

tion of the United States Department of the Interior. The bureau has financed the construction of various districts. The total indebtedness of irrigation districts to the United States provided by completed and uncompleted construction contracts not covered by bonds has amounted to \$139,268,669 of which \$17,119,220 had been paid by June 30, 1929, leaving \$122,149,449 then outstanding.

“Qualifications of voters at district elections in most States, particularly in elections to create indebtedness, include property qualifications.

“District assessments for cost of construction or acquisition of works are based in some States upon the value of the land, are uniform upon all lands in others, are apportioned according to the benefits in still others, and according to water allotment in one State. The ad valorem and benefit methods afford the greater flexibility in levying assessments. Assessments for cost of operation are sometimes levied on a basis different from that of construction assessments and may usually be supplemented or superseded by tolls for water.

“Distribution of water is pro rata to all lands in some States, according to beneficial use in others, and according to the value of the land as provided by several statutes. Distribution according to land values is not followed by all districts in States which provide for it, owing to possible inequities resulting from such requirement.”

The States of Utah, California, Nebraska, Washington, Oregon and Wyoming have promoted irrigation district development either through the purchase of district bonds, or the advance of interest on bonds.

230. Public Irrigation Agencies. — In the early days of Utah irrigation development it was customary for the municipal governments to own and operate irrigation projects. The four major cities of the state all owned and operated the irrigation systems at the expense of the general public so long as they were primarily agricultural communities. When the industrial and commercial activities of the cities became dominant, the control of the irrigation systems gradually passed to the irrigators under the organization of mutual companies. Utah has also used state funds to construct irrigation works.

Extensive use of public funds for irrigation construction began in 1902, when Congress provided that 95 per cent of the proceeds from the sale of public lands in the western states should constitute a revolving reclamation fund.

231. United States Reclamation Projects. — The enactment of the Reclamation law in 1902 was noteworthy in first providing direct use of federal funds without interest for construction of large irrigation projects.

The salient features of projects constructed by the United States under the Reclamation laws are:

- (a) The settler has the use of public non-interest-bearing money and a period of 20 or more years in which to repay construction costs.

- (b) Public lands for which the development of a water supply was so costly as to be in general unattractive to private capital were included in many federal projects.
- (c) Until a substantial part of the construction charges are paid, the project is under complete control of the Federal Bureau of Reclamation.
- (d) Annual payments of construction charges and annual operation and maintenance costs are fixed by the Bureau and paid by the settler to its representatives.

The essentials of success, as on irrigation districts, have proved to be productive land, sufficient water, reasonable construction costs, and adequate land settlement.

The Bureau of Reclamation has made an outstanding contribution in the design and building of engineering structures of large magnitude. A quarter-century of activity has resulted in the completion of structures as tabulated below.

CONSTRUCTION RESULTS. BUREAU OF RECLAMATION
To June, 1930

Storage and diversion dams	105
Reservoir capacity (acre-feet)	12,970,528
Canals, ditches, and drains (miles)	16,990
Tunnels	124
Length (feet)	176,700
Canal structures	161,469
Bridges	11,864
Length (feet)	282,600
Culverts	14,675
Length (feet)	567,807
Pipe (linear feet)	4,279,249
Flumes	5,260
Length (feet)	871,304
Power plants	37
Power developed (horsepower)	189,348
Telephone lines (miles)	4,010
Transmission lines (miles)	3,204
Excavation (cubic yards)	292,105,859

The construction achievements of the Bureau of Reclamation give some idea of the engineering problems of modern irrigation development.

Ultimately all federal irrigation projects will be owned and operated by the irrigators as some now are. Either a mutual irrigation company or an irrigation district is created by the irrigators when they assume control; and through this organization they conduct their affairs with the government.

232. Elements of Water Laws. — Two basic doctrines, antagonistic to each other, are recognized in western water law.

The doctrine of appropriation asserts that all water rights are based on use; that use creates the right, and that disuse destroys or forfeits it. Beneficial use is declared "the basis, the measure, and the limit of the right."

According to the common-law doctrine of riparian rights, each owner along a stream is entitled to have the water flow in its natural channel undiminished in quantity and unpolluted in quality. A modified rule of the riparian doctrine was fixed by the California Supreme Court in the case of *Lux vs. Haggin*, in which the court held that the riparian right was a part and parcel of the land, neither created by use nor destroyed or suspended by disuse. The court said:

"The right in each extends to the natural and usual flow of all the water, unless where the quantity has been diminished as a consequence of the reasonable application of it by other riparian owners for purposes hereafter to be mentioned.

"By our law the riparian proprietors are entitled to a reasonable use of the waters of the stream for the purpose of irrigation. What is such reasonable use is a question of fact, and depends upon the circumstances appearing in each particular case."

The riparian-right doctrine has been abrogated in Utah and each of the six adjoining states and also in Montana, whereas the nine additional western states have recognized both the riparian doctrine, as modified by California, and the doctrine of appropriation. However, there is at present a marked tendency toward narrowing and restricting the conditions under which the riparian-right doctrine may apply in these states. Noteworthy court decisions modifying the application of this doctrine have recently been made in Oregon, Washington, and Texas.

233. Legislation Concerning Water Rights. — The goal of water-right legislation is to provide a means by which the public may assure every holder of a water right the complete, and peaceful enjoyment of such right, and thereby reduce water-right litigation to a minimum, and eliminate unnecessary litigation. To accomplish these purposes it is necessary, since state control of water rights is a well-recognized practice, that each state have complete, dependable records of all existing rights. In most of the states many water rights became vested through use of water in advance of the provision of definite procedure for acquiring water rights. It is therefore essential that water-right legislation provide for:

- (a) Adjudicating rights which have become vested. These may or may not have been recorded under early laws, which

provided for posting and filing notices, but not for state supervision.

- (b) Supervising and recording the acquisition of new rights.
- (c) Distributing the waters of the state to those who are entitled to their use.

234. Adjudication of Rights. — To determine or adjudicate rights to water which have become vested through use, it is essential to collect considerable field data concerning actual amounts of available water for many years during each month of the irrigation season, the net areas of land irrigated and the types of soil, and water requirement of the different crops on the various soils, as well as date of priority. These data may be collected by each of the several water-right claimants; but, as a rule, such procedure is uneconomical and unsatisfactory because of the large number of claimants, and the tendency to collect only those data that support the requests of claimants, with the result that the evidence presented to the courts is conflicting and bewildering, rather than helpful toward making a fair and equitable adjudication. Some states have therefore authorized the state engineer, or a special water-right board, to collect and analyze the necessary physical data which, with a proposed adjudication, are presented to the district court for its approval, either as presented or as modified by its order. Initiation of proceedings may be by the state authorities upon request of interested claimants or it may be in the court by the water-right claimants and then transferred to the state engineer or board. Some states as yet have left the responsibility of water-right adjudication entirely to the courts.

235. Acquisition of Rights. — Although water rights in some states may become vested through use, there are so many advantages to the prospective appropriator in following the procedure prescribed by the state laws that practically all rights are now initiated and perfected in accordance with these laws. The common elements in the procedure to acquire a right to water briefly are:

- (a) Formal application to state engineer specifying quantity of water desired, nature and place of proposed use, point of diversion, time of use, etc.
- (b) Publication of application in a newspaper having circulation in the area concerned.
- (c) Approval of application by state engineer authorizing applicant to proceed.
- (d) Construction of works and use of water by applicant as proposed in application.

- (e) Filing with state engineer a formal proof of completion of works and of application of water to a beneficial use.
- (f) Verification of proof by the state engineer and issuance of a certificate of appropriation.

If the applicant meets the requirements of the law and the regulations of the state engineer, his right dates back to the date of his application, even though several years are required to complete the appropriation.

236. Distribution of Water. — Although complete adjudications of old vested water rights and careful public supervision of the acquisition of new rights are essential to the peaceful enjoyment of such rights, these conditions are not sufficient. It is necessary also that the several states distribute the water to those entitled to its use. In general, the responsibility of distribution is delegated by law to the state engineer or a similar officer, who appoints a water commissioner as his representative on each of the major stream systems to distribute the water. In some localities the courts have control of water distribution and appoint the water commissioner. The water commissioner is given police power so that he may enforce his distribution of the stream, except as restricted by court order. The commissioner must be fully conversant with the nature, extent, and priorities of all water rights, well informed concerning water measurement and irrigation practice, and fully capable of pleasantly receiving vigorous adverse criticism, whether or not it is justified. On many western streams both direct flow and storage rights are involved. Although ostensibly the tasks of the commissioner are fully defined by the records of existing rights, in reality he must make many important decisions because of the great variability in available water from day to day. A competent commissioner of good judgment greatly increases the economy and efficiency with which the water under his supervision is used, reduces waste to a minimum, maintains a reasonable degree of satisfaction among irrigation company officers, and makes valuable public records of water distributed to the irrigation companies.

REFERENCES

- HUTCHINS, WELLS A. Irrigation Districts, Their Organization, Operation, and Financing, U. S. D. A. Technical Bul. 254. 1931.
- HUTCHINS, WELLS A. Mutual Irrigation Companies in Utah, Utah Agr. Exp. Sta. Bul. 199. 1927.
- HUTCHINS, WELLS A. Summary of Irrigation-District Statutes of Western States, U. S. D. A. Miscel. Pub. 103. 1931.
- HUTCHINS, WELLS A. Commercial Irrigation Companies, U. S. D. A. Technical Bul. 177. 1930.

296 SOCIAL AND ADMINISTRATIVE ASPECTS OF IRRIGATION

- HUTCHINS, WELLS A. *Delivery of Irrigation Water*, U. S. D. A. Technical Bul. 47. 1928.
- TEELE, R. P. *Land Reclamation Policies in the United States*, U. S. D. A. Dept. Bul. 1257. 1924.
- THOMAS, GEORGE. *The Development of Institutions Under Irrigation*, The Macmillan Co. 1920.
- WEEKS, DAVID, and WEST, CHARLES H. *The Problem of Securing Closer Relationship Between Agricultural Development and Irrigation Construction, California* Agr. Exp. Sta. Bul. 435. 1927.

General references, such as the reports of the state engineers of the western states, state irrigation laws, federal irrigation laws, etc.

CHAPTER XVII

AMOUNTS OF WATER USED IN IRRIGATION

In many of the irrigated valleys of the West, and indeed throughout most of the arid regions of other countries, the quantity of water available for irrigation purposes is insufficient to cover the arable lands that really need water to make them productive. The quantity of water used in irrigation is therefore a matter of vital concern to arid-region society. The much-heralded financial difficulties, which have in recent years given serious concern to a relatively small number of American irrigation projects, both public and private, have been caused in part by the fact that insufficient quantities of water have been available during years of low precipitation to produce crops economically on all the project lands. Simultaneously with a water-supply deficiency on the newer irrigation projects, it is claimed in good faith by intelligent men that the owners of older irrigated lands on the same river systems are using quantities far in excess of actual needs. A decrease in the quantity of water used on the lands to which water was first applied in the earlier years provides additional water with which to irrigate the newer lands. Consequently, with increasing population, and available labor, there is a continuous economic urge (shared by only part of the people) to spread the water over a greater and greater area of land. This chapter considers the quantities of water used on some typical projects. Commonly adopted ways of expressing quantities used, together with factors that influence the amounts used, are also considered. In the following chapter, an attempt is made to show what constitutes economical use, and to show by analysis and example how to approximate from the (y, w) curve the economical quantities of water to use.

237. The Duty of Water. — The expression “duty of water” is defined as the ratio of the amount of water used to the area of land irrigated. When a large amount of water is applied to a small area of land the “duty” is said to be *low*; and conversely, when a small amount of water is applied to a large area of land the “duty” is said to be *high*. The expression “duty of water” is really misleading; it is frequently erroneously used; to the uninitiated it implies an obligation on the part of the water. Altogether, it is a misnomer and should be discarded. Alexander has shown that the term “duty of water” is in reality a relic of early irrigation terminology.

In the following pages, which really concern the topics ordinarily treated under the heading "duty of water," the expression "amounts of water used" is employed to represent the volume of water used per unit area of land.

238. Units Employed to Represent Use. — Fundamentally, the units employed to express the amounts of irrigation water used are the same — that is, a volume of water per unit of time, applied to unit area of land. Numerically, however, two sets of units are employed, each of which is represented in the form of a ratio below:

$$(a) \frac{\text{Cubic feet per second}}{\text{on a given number of acres}}$$

and

$$(b) \frac{\text{Acre-feet (or acre-inches) per season}}{\text{on 1 acre}}$$

In the first usage, (a), the numerator of the ratio (or fraction) ordinarily is taken as unity and is therefore constant, whereas the denominator is a variable, the magnitude of which is determined by the use made of the water. Thus if 1 c.f.s. is made to serve 80 acres, the use is described as 1 c.f.s. per 80 acres. Sometimes this order of expression is inverted and the use designated as 80 acres per c.f.s.

In the second usage, (b), the numerator is the variable and the denominator is constant. Thus, if 3 acre-feet are applied in a season to 1 acre the use is described as 3 acre-feet per acre per season, which is equivalent to the mean seasonal depth in feet. The term "season" is understood to include from 1 to 8 or more months, depending on the locality considered. Under the second usage it is sometimes convenient to specify a time period less than the season — say a week, or two weeks.

Using the approximate equality of 1 c.f.s. being equivalent to 1 acre-inch per hour, or $\frac{1}{12}$ acre-foot per hour, it is convenient to apply equation (32) to convert from one expression of use ratio to the other. Since by custom the size of stream, q , is 1 c.f.s., we may write the numerical equality

$$da = 1 \times t$$

but $12D = d$, where $D =$ mean depth of water in feet. Selecting a 30-day month and letting $M =$ the number of months considered, it follows that $t = 24 \times 30 \times M$ hours, and that

$$D = \frac{24 \times 30 \times M}{12a} = \frac{60M}{a} \dots \dots \dots (58)$$

Table XXXII, based on equation (58), gives the mean depth of water in feet provided by 1 c.f.s. when applied continuously to any area from 10 to 100 acres for periods from 1 to 8 months.

TABLE XXXII

FOR CONVERTING USE RATIO FROM ONE CUBIC FOOT PER SECOND ON A CERTAIN AREA TO MEAN DEPTH IN FEET IN TIME PERIODS FROM ONE TO EIGHT 30-DAY MONTHS.

FROM THE EQUATION $D = 60 M/a$

Area in Acres, <i>a</i>	Depth in Feet for Monthly Periods of							
	1	2	3	4	5	6	7	8
10	6.00	12.00	18.00	24.00
20	3.00	6.00	9.00	12.00	15.00	18.00	21.00	24.00
30	2.00	4.00	6.00	8.00	10.00	12.00	14.00	16.00
40	1.50	3.00	4.50	6.00	7.50	9.00	10.50	12.00
50	1.20	2.40	3.60	4.80	6.00	7.20	8.40	9.60
60	1.00	2.00	3.00	4.00	5.00	6.00	7.00	8.00
70	.86	1.72	2.57	3.43	4.28	5.14	6.00	6.85
80	.75	1.50	2.25	3.00	3.75	4.50	5.25	6.00
90	.67	1.34	2.00	2.67	3.33	4.00	4.78	5.35
100	.60	1.20	1.80	2.40	3.00	3.60	4.20	4.80

239. Points of Measurement. — Irrigation water is commonly measured at three points, namely:

- (a) The point of diversion from the source of supply, usually a river.
- (b) The point of diversion of large laterals from main canals.
- (c) The point of delivery to the irrigator.

To specify each of these points of measurement it is becoming customary to designate the use as:

- (a) *Gross use*, when measured at the point of diversion.
- (b) *Lateral use*, when measured at the heads of laterals.
- (c) *Net use*, when measured at the point of delivery to the irrigator.

Where the source of water is a lake, a pond, or a body of ground water made available by a small pumping plant located on, or near, the irrigated farm, there is only one point of measurement, and this gives a basis for determining the *net use*.

240. Kinds of Use. — It is urged by some conservative men that Americans have used their natural resources wastefully, even lavishly. The early users of the forests are said to have given but little attention to public economy or to conservation of small trees. Likewise, the early mining and oil activities are termed as "exploitation" of public resources rather than conservative use. Similarly the earlier uses of western land

and water resources were possibly relatively lavish and wasteful. It is apparent that the kind of use of these and other limited natural resources is influenced by the intensity of population, the relative abundance of the resource, and the far-sightedness and wisdom of public-spirited men, as well as the intelligence and fair-mindedness of the user.

Today the use of water for irrigation in the West varies between wide limits — from grossly lavish and wasteful to highly economical. It is indeed difficult to specify precisely what constitutes economical use — the influencing factors are so numerous and so variable. Moreover, a use ratio that may be economical in a sparsely settled, high mountain valley may be wasteful in a densely settled area near world seaport markets. The problem of determining intelligently what constitutes economical use of water in irrigation should have the serious consideration of arid-region communities. This problem is considered in the following chapter, the present chapter being restricted to an examination of the factors that influence the use ratio and a report of some records of use.

241. Influencing Factors. — The amounts of water used in irrigation are influenced by three noteworthy classes of factors, each of which includes many specific factors. The general classes of factors are:

- (a) Biological and chemical.
- (b) Physical.
- (c) Administrative.

The influence of each of these three factors is considered in this chapter, that of the economical factors in Chapter XVIII. In the interest of clearness of presentation the factors which influence the amounts of water used are considered first in relation to *net use* and later in relation to *gross use*.

242. Biological and Chemical Factors. — It seems to be well established that the occurrence of certain plant diseases can be retarded, if not fully prevented, by careful control of the amounts of irrigation water used. For example, sugar beets that are given a sufficient amount of water early in the season to stimulate and support rapid growth are less susceptible to the ravages of the white fly than are beets which are retarded in their growth, either by a deficient or an excess amount of water. The occurrence of plant chlorosis is sometimes, though not always, attributable to the use of improper amounts of water in irrigation. Recent observations seem to justify the conclusion that potato and alfalfa diseases also are stimulated with excessive amounts of water and checked when proper quantities are used.

Among the more important chemical factors that influence amounts of water used are (2) the readily available soluble plant food nutrients in the soil, (b) the chemical composition of the irrigation water, and (c) the kinds and amounts of alkali salts in the soil. An abundance of readily available plant food compounds in the soil favors efficient use of water and heavy crop production. Excessive amounts of alkali salts in *irrigation water* sometimes necessitate relatively liberal use of water as a means of assuring adequate conveyance of the harmful soluble alkali salts through the soil and away in the drainage water. Similarly an excess of alkali salts *in the soil* may require copious quantities of irrigation water to leach the excess salts from the soil, thus preventing the occurrence of a high concentration of alkali soil solution and the concentration of the alkali salts on the land surface by continuous evaporation.

243. Physical Factors. — The physical factors which exert the greatest influence on the amount of water used in irrigation are:

- (a) Climatic factors such as rain, winds, and heat.
- (b) Soil properties, notably texture, permeability, and depth.
- (c) Land preparation, and conveyance and delivery losses.

244. Climatic Factors. — That the amount of water needed by crops during a season is almost directly proportional to the amount of heat available during the season has been pointed out in Chapter XIV. The length of the growing season and the temperature, therefore, are significant factors influencing the amount and distribution of water used annually. The relative humidity, the frequency and velocity of the winds, together with the amount and distribution of rainfall, influence amounts of irrigation water used.

It is not difficult to see that the amount of water needed for alfalfa each season in the arid Southwest, which has long seasons, dry atmosphere, low rainfall, and heavy alfalfa yields, is appreciably larger than the amount needed in the northwestern states and in western Canada, where the seasons are short, the atmosphere relatively moist, the precipitation heavy, and the average alfalfa yields much smaller than in the Southwest. Despite the importance of the climatic factors in influencing the amounts of water used in irrigation, they can be modified by man but little, if any. It is man's responsibility rather to become acquainted with their influence and adjust his irrigation practice so as to harmonize it with climatic conditions.

245. Soil Properties. — The nature of arid-climate soil properties and their influence on the capacities of soil to hold irrigation water, and on the movement of water in soils, are considered in Chapters VII to X. The smoothness of the land surface influences the amount of water used.

Rough, irregular surfaces are difficult to irrigate; and, as a rule, where an attempt is made to water land of rough topography, large amounts of water are lost by surface run-off and by deep percolation from the lower or depressed areas to which excessive amounts of water are given during the attempt adequately to irrigate the higher parts of the field. It is especially difficult to apply water uniformly by the ordinary field flooding or the border flooding methods if the surface of the land is not smooth. The use of comparatively deep furrows in the irrigation of such land enables the irrigator to approach more nearly a uniform distribution of water and to reduce the water losses during irrigation. Some irregular lands, provided the surface slopes are not too steep, may be irrigated fairly well by adoption of the basin flooding method, or by the use of special distribution devices such as slip-joint pipe or canvas hose. Great variability in the texture, permeability, and depth of soils tends to cause the use of excessive amounts of water; uniformity in these properties favors efficient application of water and conservative use. The irrigation farmer should make frequent use of the soil auger or the soil tube in order to become fully acquainted with the physical soil properties on his farm. He cannot appreciably change texture and depth, but he can modify his practice to suit the needs of his soils. Shallow soils should be irrigated frequently, small amounts of water being applied at each irrigation, whereas deep soils should be irrigated less frequently but receive larger unit applications of water.

246. Land Preparation. — The advantages that accrue from proper preparation of land toward efficient use of water in irrigation are far greater than are commonly realized. As these advantages are presented in Chapter V, suffice it here to say that at best it is a difficult task uniformly to spread water over the land surface, and that every endeavor consistent with good husbandry and economy should be made to minimize the losses. The careful irrigator realizes that in the irrigation methods most used it is necessary so to control the water that a sufficient amount enters the soil at the same time that the flooding sheet, or the furrow stream, flows over the land. The necessary coordination of size of stream used, width of land covered (whether in flooding or in furrows), and length of run of the water, with the permeability of the soil to water, requires intelligent preparation of the land for irrigation and painstaking care in the application of the water. It is likewise important that the irrigation company deliver water to the irrigator in streams that are suited to the soil conditions, the crops grown, and the methods of irrigation employed.

247. Net and Gross Use Factors. — The factors thus far considered as influencing the net use of water concern the irrigation farmer directly.

In the control of these factors the farmer has a first-hand opportunity to contribute to the public economy by careful use of water. The factors that most influence the gross use of water concern directly those groups of men who have, through organized agencies, the responsibility of storage, diversion, conveyance, and distribution of water. Of the agencies that perform these functions in irrigation some are private corporations, such as mutual irrigation companies; some are quasi-public corporations, such as irrigation districts; and some are public corporations such as cities, states, and the Federal Government. The agencies that distribute water exert a very great influence on the gross use. By analogy to the commercial distribution of the many ordinary commodities that society uses, it may be said that irrigation water passes through the hands of two distributors, namely, the wholesaler and the retailer, before it reaches the irrigation farmer who is the consumer. The state or public agencies that distribute the available public waters from rivers and other natural sources to the companies entitled to use the water are analogous to the wholesale distributors in industry; the irrigation corporations, private and public, that store, divert, convey, and distribute the water to the irrigators are analogous to the retail distributors in industry. The distributors, both retailers and wholesalers, influence the gross use of water by their physical methods of handling the water and by their administrative practices.

248. Conveyance Losses. — It is impracticable to deliver to the irrigator all the water taken from a river system into a canal. Under the most favorable conditions some water is lost in conveyance through leaky canal structures and by seepage and evaporation, the evaporation losses usually being relatively small. Canals built through porous upland soils sometimes sustain heavy seepage losses — even as much as one-half the water taken into the canal. Where excessive losses occur by seepage through natural materials it is usually advantageous to reduce the losses by lining the canal with concrete or other less expensive material. Seepage losses are seldom, if ever, uniform along the entire length of a canal — rather they are excessive along stretches where the canal passes through gravel and sand that are highly permeable to water. Lining the canal where it passes through such material is sometimes very helpful.

249. Delivery Losses. — Most of the larger irrigation systems have spillways and wasteways that carry back to the river channels part of the water diverted. Spillways are designed and built to protect canals when the quantity of water in the river and the canal is suddenly increased by storms or by other means.

Wasteways emptying into natural drainage channels and finally back

to the river systems are used to carry away part or all of the canal water during periods of low demand for irrigation water and during periods of repairs of canal banks or structures. It is possible on only a very few of the larger irrigation systems to deliver to the farmers all the water that is diverted after deducting conveyance losses.

There are, however, very few records of delivery losses separate from conveyance losses — usually both together are reported. It is customary to consider the difference between the amounts of water diverted and the amount delivered to the irrigators as being “conveyance and delivery losses.” Thus it is found that from 23 per cent to 72 per cent is lost in conveyance and distribution. (See Article 251 and Table XXXIII.)

250. Administrative Practices. — The administrative practices of irrigation companies and other types of irrigation agencies, both private and public, exert a potent influence on the amounts of water used in irrigation — both net and gross.

Delivery of water to irrigators in continuous-flow small streams generally encourages wasteful use; the rotation or “turn” method of delivery encourages careful use; and the delivery on demand, i.e., when the irrigator requests the water, stimulates the irrigator to use water even more carefully.

Many mutual irrigation companies deliver water to irrigators in turns on the basis of the number of shares of stock owned by each. The system is somewhat inflexible, with the result that the irrigator takes water at times when he really does not need it. If his annual stock assessment were decreased by his taking the water only at times of real need, he would no doubt use less water. In addition to a specified fixed charge per acre or per share of stock which entitles the water user to a moderate amount of water, some companies make a further charge based on the additional amount of water per season that the irrigator uses on his own request. This practice stimulates the irrigator to use water sparingly and to avoid preventable losses, and it is therefore to be encouraged.

Public agencies, notably state engineers, state water boards, and court commissioners, analogous to industrial wholesale distributors, may appreciably influence the gross use of water. It is the function of such administrative officers to distribute water according to water rights that have been established by appropriation under state law, by court decree, or by other similar processes. The public field officer who distributes water, usually an engineer-commissioner, has *in theory* a task that is fully defined by decree, and hence one that requires but little exercise of judgment and discretion. *In fact*, however, owing to the non-flexibility of most water-right decrees, and the great variability of avail-

TABLE XXXIII
AVERAGE USE OF WATER ON FEDERAL IRRIGATION PROJECTS

Detailed Data in Table	Project	Irrigated Area, in Acres	Area Com-manded by Con-structed Canal System, in Acres	Miles of Canals and Laterals Operated	Miles of Canals and Laterals Lined or Enclosed	Predomi-nating Character of Soils	Delivered (Charged) to Farms, in Hundredths of Acre-feet per Acre ¹⁰						
							Jan.	Feb.	March	April	May	June	July
1	Belle Fourche.....	45,164	74,569	547	58	Heavy	0.04	0.06	0.09	0.16	0.07	0.25	0.40
2	Boise.....	145,616	163,667	1064	37	Light	0.73	0.78	0.89
3	Carlsbad.....	22,535	25,000	45	11	Medium	0.06	0.09	0.14	0.29	0.28	0.37
4	Grand Valley ²	10,139	29,000	180	7	Heavy	0.69	0.78	0.81
5	Huntley.....	19,406	32,540	232	43	Very light	0.31	1.23	1.30	1.51
6	King Hill ³	6,480	16,890	96	2	Medium	0.01	0.01	0.07	0.41	0.35
7	Klamath.....	43,325	52,396	240	2	Heavy	0.07	0.30	0.30	0.51
8	Lower Yellowstone.....	17,540	48,272	202	0.01	0.11	0.22	0.22	0.21
9	Milk River.....	16,793	63,480	275
10	Modoc-South Side.....	44,945	48,880	275	Medium	0.03	0.03	0.41	0.56	0.66
11	Newlands Division.....	38,808	65,277	319	Medium	0.03	0.12	0.58	0.53	0.64
12	North Platte.....	107,694	161,870	1154	Medium	0.37	0.42	0.41	0.67
13	Okanogan ⁴	5,260	7,300	168	39	Light	0.54	0.57	0.68
14	Orland ⁵	14,554	20,600	135	89	Light	0.01	0.02	0.11	0.27	0.54	0.57	0.63
15	Rio Grande ⁶	96,847	126,300	485	10	Medium	0.04	0.18	0.41	0.47	0.49	0.43
16	Shoshone.....	7,993	20,063	166	Heavy	0.02	0.29	0.56	0.63
17	Frannie Division ⁷	32,390	42,000	279	4	Medium	0.05	0.30	0.57	0.71
18	Sun River.....	7,650	13,002	99	Heavy	0.16	0.45	0.52
19	Fort Shaw Division.....	6,867	41,877	190	Medium	0.08	0.35	0.65
20	Umattilla ⁸	10,970	24,587	173	157	Light	0.02	0.53	0.98	0.96	1.07
21	Uncompahgre.....	61,178	95,202	470	11	Medium	0.39	1.11	1.18	1.21
22	Yakima.....	91,726	102,464	602	125	Medium	0.33	0.59	0.57	0.62
23	Sunnyside Division.....	32,000	37,607	335	86	Light	0.01	0.09	0.51	0.50	0.53
24	Tieton Division.....	51,950	64,865	336	Medium	0.06	0.15	0.35	0.30	0.25	0.38	0.47

¹ 1924 and 1926 omitted from average on account of water shortages.
² Umattilla and Grand Valley data cover years, 1916-25.
³ King Hill data cover years, 1921-27.
⁴ Okanogan data average for 1921, 1923, and 1925, on account of shortages in all other years since 1917.
⁵ Orland data omit years of heavy water shortage, 1918, 1920, and 1924.
⁶ Rio Grande data cover years, 1919-26.
⁷ Shoshone-Frannie Division data cover years, 1922-26.
⁸ Losses on water conveyed through Garland Division Main Canals for Frannie Division included in Garland Division losses, 1919 to 1926, inclusive.
⁹ Data are for years, 1917 to 1926, inclusive, except as noted.

TABLE XXXIII.—Continued

Detailed Data in Table	Project	Delivered (Charged) to Farms, in Hundredths of Acre-feet per Acre ^a					Total	Precipitation, in Growing Season, in Feet	Water Delivered This Growing Season, in Feet	Precipitation, in Growing Season, in Feet	Project, in Feet	Mean Temperature in Degrees Fahrenheit, in Growing Season, in	Percentage of Area in Different Crops				Percentage of Total Divisions		
		Aug.	Sept.	Oct.	Nov.	Dec.							Hay, and Pasture	Small Grain	Narrow Crops	Trees	Canal and Lateral Losses	Waste	Delivered to Farms
1	Belle Fourche.....	0.35	0.15	1.22	0.86	2.08	0.48	2800	65	62	22	16	33	15	52
2	Boise.....	0.71	0.39	0.04	3.60	0.38	3.98	0.43	2500	62	53	31	13	3	25	2	70
3	Carlsbad.....	0.44	0.20	0.06	0.02	2.36	0.86	3.32	0.09	3100	66	33	4	63	48	6	46
4	Grand Valleys.....	0.61	0.35	0.19	0.04	3.61	0.48	5.09	0.27	4700	65	36	34	33	7	43	22	35
5	Huntley.....	0.37	0.11	1.39	0.33	0.62	0.37	3750	64	72	11	6	30	52	52
6	King Hill.....	0.36	0.07	0.20	0.01	1.70	0.38	1.61	0.68	4100	60	44	21	3	39	9	52
7	Klamath.....	0.30	0.11	1.24	0.71	2.05	0.33	1900	64	45	21	35	44	21	35
8	Milk Pt., Ellsworth.....	0.32	0.11	1.24	0.71	2.05	0.33	1900	64	45	21	35	44	21	35
9	Milk Pt., Ellsworth.....	0.07	0.02	0.01	0.65	0.91	1.56	0.18	2300	58	73	22	5	36	19	45
10	Minidoka-South Side Pumping Division.....	0.56	0.27	0.02	2.54	0.53	3.07	0.32	4900	59	50	28	22	39	3	58
11	Newlands.....	0.46	0.28	0.06	0.02	2.88	0.25	3.13	0.15	4000	59	85	11	4	41	14	45
12	North Platte.....	0.65	0.38	2.33	0.81	3.04	0.47	4100	66	36	26	38	43	8	49
13	Okangozan.....	0.68	0.45	2.60	0.42	3.02	0.51	1000	63	9	3	88	29	71	71
14	Orland.....	0.57	0.40	0.04	0.01	3.17	0.37	3.55	1.02	250	70	53	5	19	23	27	9	64
15	Rio Grande ^b	0.42	0.30	0.10	0.03	0.02	2.89	0.60	3.49	0.06	3700	66	37	8	53	2	32	39	29
16	Shoshone.....	0.46	0.19	0.04	2.19	0.39	2.58	0.11	4150	60	72	17	11	42	21	37
17	Frannie Division ^c , Garland Division ^d , Sun River.....	0.50	0.21	0.03	0.01	2.38	0.33	2.71	0.09	4400	59	59	28	13	38	7	56
18	Fort Shaw Division.....	0.36	0.04	0.01	1.54	0.60	0.14	0.33	3700	58	75	20	5	36	26	38
19	Greenfields Division ^e	0.36	0.41	0.08	1.62	0.35	5.37	0.40	470	60	83	75	2	31	22	47
20	Umatilla.....	0.36	0.41	0.08	1.62	0.35	5.37	0.40	470	60	83	75	2	31	22	47
21	Yacompagne.....	0.92	0.63	0.32	5.76	0.56	6.31	0.26	5500	61	47	25	3	32	18	50
22	Sunnyside Division.....	0.60	0.39	0.18	3.29	0.21	2.67	0.27	800	63	57	7	21	15	23	7	70
23	Tyson Division.....	0.53	0.35	3.01	0.16	3.60	0.44	1500	62	44	12	11	33	24	2	74
24	Yuma.....	0.43	0.28	0.19	0.08	0.07	3.01	0.33	3.34	0.33	120	72	39	3	58	14	2	28

^a 1924 and 1926 omitted from average on account of water shortages.
^b Umatilla and Grand Valley data cover years, 1916-25.
^c King Hill data cover years, 1921-25.
^d Okangozan data average for 1921, 1923, and 1925, on account of shortages in all other years since 1917.
^e On Umatilla data, see note on page 297 for shortage, 1916, 1920, and 1924.
^f Rio Grande data cover years, 1919-26.
^g Frannie Division data cover years, 1922-26.
^h Shoshone-Frannie Division data cover years, 1922-26.
ⁱ Losses on water conveyed through Garland Division Main Canals for Frannie Division included in Garland Division losses.
^j 1919 to 1926, inclusive.
^k Data are for years, 1917 to 1926, inclusive, except as noted.

able water supply from day to day, caused by variations in climate and other natural factors, the commissioner has a great opportunity to stimulate careful use of water and to avoid waste by making a distribution based on thorough and intimate knowledge of probable stream-flow variations, and of the irrigation needs from day to day throughout his territory. The powers of discretion of the water commissioner rest on the fundamental principle of beneficial use as "the basis, the measure, and the limit" of water rights under the doctrine of appropriation.

251. Records of Water Used. — Long-time records of the amounts of water used in irrigation are of great public value. However, there are available comparatively few reliable records of use. To illustrate the wide variations in actual use in different places and on different projects, Table XXXIII is presented.

The data of this table prepared by Debler are not intended to show the amounts of water needed.

The data are especially valuable in showing the amounts of water delivered to irrigators on 24 of the United States Bureau of Reclamation projects. The table includes a record of the area irrigated by each project, the lengths of canals, types of soils, monthly and seasonal water deliveries, and other valuable data. It will be noted that the seasonal deliveries range from less than 1 foot to approximately 7 feet. It is probable that as the years advance the percentage of the total diversions now lost in the canals and through waste channels will decrease and the percentage of diversions delivered to farms will increase.

REFERENCES

- ALEXANDER, W. P. "Duty of Water" — A Relic of Early Irrigation Terminology, *The Hawaiian Planters' Record*, **32**, No. 1 : 122-130. 1928.
- DEBLER, E. B. Use of Water on Federal Irrigation Projects. *Trans. Am. Soc. C. E.*, **94**, Paper No. 1755. 1930. (See also Accompanying Discussions.)
- FORTIER, SAMUEL. Irrigation Requirements of the Arable Lands of the Great Basin, U. S. D. A. Dept. Bul. 1340. 1925.
- HARDING, S. T., *et al.* Determination of the Duty of Water in Water Right Adjudications, *Trans. Am. Soc. C. E.*, **90**, Paper No. 1074. 1927.
- MCBRIDE, BRICE. Unpublished Reports of the Sevier River Water Commissioner, Office of the State Engineer, Utah.
- See also the References of Chapter I.

CHAPTER XVIII

EFFICIENCY AND ECONOMY IN IRRIGATION

The word efficiency as here used is essentially a physical concept. In hydraulic and mechanical engineering efficiency represents a ratio of *output* to *input* of either energy or of power. Hydraulic motors and pumps in comparatively recent years have been wonderfully improved in design, construction, and operation with the result that their efficiencies have been increased to a degree almost beyond the expectations of the most optimistic engineers. As yet the measurement of irrigation efficiencies is comparatively new, probably because of the difficulties encountered in making such measurements. The importance of efficient use of water in irrigation was urged by Brigham Young in talking to the "Mormon" colonists on June 8, 1856, as follows:

"In regard to irrigation, I will venture to say that one-half of the water is wasted; instead of being applied where and when it is needed, it runs here and there, perhaps one-half reaches the drooping plants. If people would take a little more pains in preparing ditches, gates, and embankments for economically conducting water where it is most needed, it would be a very great advantage to them."

The need for increasing efficiencies in irrigation justifies careful consideration of the factors that influence them, even though some of them are not easily measured. A high irrigation efficiency increases the probability that water will be economically used, although it does not insure economical use. The economical use of water is a function of the water costs, the crop yields, and crop values; irrigation efficiencies as here defined involve neither water costs nor crop yields. In this chapter, water application efficiency, conveyance and delivery efficiency, and irrigation efficiency are defined and their relations to each other are considered. The discussion of irrigation efficiency is followed by a consideration of economical use of water in irrigation.

252. Water Application Efficiency.—In preceding chapters the transpiration efficiency, E_t , and the consumptive use efficiency, E_u , were defined and illustrated. It was pointed out that the transpiration efficiency involves the process of plant growth, thus making it essentially a biological concept. The water application efficiency, like the consumptive use efficiency, is a physical concept. It is defined as the ratio of the

amount of water that is stored by the irrigator in the soil root zone and ultimately consumed (transpired or evaporated, or both) to the amount of water delivered at the farm.

Let E_a = water application efficiency.

W_f = irrigation water delivered to the farm.

W_s = irrigation water stored in the root zone of soil of the farm.

Then by definition

$$E_a = W_s/W_f \dots \dots \dots (59)$$

Common sources of loss of irrigation water from the farm during application are represented thus

R_f = surface run-off from the farm.

D_f = deep percolation from the farm soil.

Neglecting the evaporation losses during the time of the application of the water and immediately after, it is apparent that

$$W_f = W_s + R_f + D_f \dots \dots \dots (60)$$

Therefore

$$E_a = \frac{W_f - (R_f + D_f)}{W_f} \dots \dots \dots (61)$$

The water application efficiency, E_a , varies widely, depending on many variable factors. Irregular land surfaces, shallow soils underlain by gravels of high permeability, small irrigation streams, non-attendance of water during irrigation, long irrigation runs, excessive single applications — all these factors contribute to a large D_f and a small E_a . On the other hand, use of excessively large heads, improper preparation of land, compact impervious soils, large slope of land surface, and non-attendance contribute to a large R_f and a small E_a .

It is somewhat conjectural to estimate the magnitude of E_a , but probably it is not extravagant to say that in some localities it is as low as 20 per cent, and that under comparatively favorable conditions it is seldom greater than 75 per cent. There is, in general, undoubtedly great opportunity to increase E_a at costs well within economical limits.

253. Water Conveyance and Delivery Efficiency. — It is impracticable, as a rule, to convey irrigation water from its source in rivers to the irrigated farms without sustaining certain losses through leaky irrigation gates, through seepage, spillways, wasteways, and evaporation.

Let

E_c = the water conveyance and delivery efficiency.

W_r = the water diverted from the river into the irrigation canal.

ΣW_f = the sum of the amounts of water delivered to the farms under the canal.

Then, by definition:

$$E_c = \frac{\sum W_f}{W_r} \dots \dots \dots (62)$$

That is, the water conveyance and delivery efficiency, E_c , is defined as the ratio of the sum of the amounts of water delivered to all the farms to the quantity diverted from the river or other water source.

There are also at times unavoidable losses from canals and ditches because conditions arise that make it difficult to get irrigators to take all the water available in a canal system. These losses are designated as delivery losses. Early measurements by the United States Department of Agriculture show conveyance and delivery efficiencies, E_c , ranging from 30 to 85 per cent with an average of approximately 60 per cent. More recent measurements by the United States Bureau of Reclamation on twenty-four of its projects show a range of E_c from 28 to 77 per cent, with a mean of 50 per cent. (See Table XXXIII.)

It is, of course, true that the conveyance and delivery losses of one canal system in many valleys seep back to the river and are later diverted by other canals lower on the river system, so that the low values of E_c are in reality less serious than they sometimes appear to be. Despite these recoveries of waste water for lower lands, in some localities, it is important, as a general rule, that conveyance and delivery losses be reduced to a reasonable minimum, thereby increasing E_c .

254. Irrigation Efficiency. — The desired attainment, or the goal in diverting water from natural sources for irrigation purposes, is to produce the maximum crop possible consistent with economic conditions. As a general rule, reduction of wastes, and consequent increase in effective use of all natural resources, including irrigation water, result in *economical* use, provided the costs of reducing wastes are not excessive. Irrigation practice can be made more efficient than it is at present by reducing the losses of water in conveyance, delivery, run-off, deep percolation, and evaporation. With a given quantity of water diverted from a river, W_r , the larger the proportion that is stored in the soil of the irrigated farms and there held until absorbed by plants and transpired from them, the larger will be the total crop yield. The expression irrigation efficiency is here defined as the ratio of the water *transpired* by the crops of an irrigation farm or project to the water diverted from a river or other natural water source into the farm or project canal or canals.

Let E_i = irrigation efficiency.

W_i = the *irrigation water transpired* by the crops of an irrigation farm or project during their growth period.

W_r = the water *diverted* from a river or other natural sources into the farm or project canals during the same period of time.

Then $E_i = W_i/W_r$ (63)

It is apparent that the irrigation efficiency, E_i , is influenced by the conveyance and delivery efficiency E_c , the application efficiency E_a , and the consumptive use efficiency E_u . When any or all of the quantities E_c , E_a , and E_u are increased, then E_i is also increased. It is almost self-evident that, in most irrigated regions of the West, the irrigation efficiency may be substantially increased to the economic advantage of the communities concerned. Because of the many sources of loss of irrigation water between the time and place it is diverted from rivers, and the time and place where it is stored in the soil as capillary water readily available to plant roots, the irrigation efficiency on most projects is rather low, probably less than one-third as a rule.

Suppose, as an example of comparatively good irrigation practice, that 40 per cent of the water diverted is lost in conveyance and delivery; 30 per cent of the water delivered to the farms is lost as surface run-off and deep percolation; 20 per cent of the water stored in the soil is lost by evaporation; then it follows that:

$$\begin{aligned} W_f &= 0.6W_r, \\ W_s &= 0.7W_f = 0.42W_r, \\ W_t &= 0.8W_s = 0.34W_r, \end{aligned}$$

and

$$E_i = W_t/W_r = 0.34$$

As an example of rather poor irrigation practice, consider that 60 per cent of the water diverted is lost in conveyance and delivery; 50 per cent of the water delivered is lost as surface run-off and deep percolation; 40 per cent of the water stored in the soil is lost by evaporation, then:

$$\begin{aligned} W_f &= 0.4W_r, \\ W_s &= 0.5W_f = 0.2W_r, \end{aligned}$$

and

$$W_t = 0.6W_s = 0.12W_r,$$

and

$$E_i = W_t/W_r = 0.12$$

So far as the author is aware, there are no records of careful measurements of E_i for large irrigation projects. There are available, however, a sufficient number of measurements of E_c and E_a to suggest that the values of E_i given above represent approximately the lower and upper limits. If these estimates be even approximately correct, indicating

that only one-tenth to one-third of the water diverted for irrigation is actually transpired by growing crops, it is apparent that the serious consideration should be given to increasing irrigation efficiency.

There is, to be sure, wide variability in the several efficiencies here defined depending on the conditions of irrigation. For example, when water is obtained at high cost by pumping and conveyed short distances through concrete or other pipe lines to irrigate high-priced crops such as citrus fruits, then E_c is high, from 85 to 95 per cent. Also, where an irrigator owns a pumping plant and obtains water from ground-water sources or from rivers, ponds, or canals by pumping directly onto his land, E_c approaches closely 100 per cent. Similar examples could be given to illustrate high values of E_i and E_u , but the conditions which influence these efficiencies as considered in the following articles concerning economy in irrigation will serve to clarify the principles of major importance.

255. Economical Use of Water in Irrigation. — The expression “economical use,” as applied to the use of natural resources such as water, means a use that will give the user the maximum profits. If, for example, an electric power plant is operating at a low efficiency and yet returning to its owners an annual net income of 8 per cent on its capital investment, it may be considered a profitable business. However, if by increasing the efficiency the net earnings on the plant could be without doubt increased to 10 per cent annually, then the low efficiency operation is clearly uneconomical. As a rule, a high efficiency in the use of water, whether for generation of power or in irrigation, results in an economical use; but efficient use does not necessarily insure economical use. There are three processes in irrigation, in each of which economical use of water by the person making the use influences the economy of use from the viewpoint of the public as well as from that of the individual. These processes are the water conveyance and delivery, the application to the farm, and the consumptive use of water. Efficiencies in each of these processes have been defined heretofore. The following Articles are concerned with economical use of water in each process. In each case, economy of use is considered first with respect to the individual (or corporate) user and later with respect to the public, since, in the last analysis, the public or the state is the owner of all water resources, the individual ownership being essentially an ownership of *right* to use under conditions satisfactory to the state.

256. Economical Conveyance and Delivery of Water. — When irrigation companies are permitted to divert from the public water sources all the water they choose, they have no incentive to attain a high efficiency, E_c . Excessive conveyance and delivery losses are of little

direct concern to the irrigation company so long as it can provide its water users a quantity of water sufficient at all times for their needs. Companies whose lands are so situated that thorough natural drainage of excessive conveyance losses is assured, and who feel that there is little or no possibility of having to pay damages for contributing to the water-logging of low-lying lands owned by others, do not as a rule make heavy expenditures to decrease conveyance losses. For example, if a company knows it could increase E_c from 60 per cent to 80 per cent by lining its main canal with concrete and thus decrease conveyance losses by 20,000 acre-feet (the company diverting 100,000 acre-feet annually), the company would probably line the canal, provided it really needed additional water and provided further that the 20,000 acre-feet of water was clearly worth more each year than the annual interest on the cost of lining the canal plus the annual maintenance cost of keeping the concrete in good condition and of providing for replacements. Thus the incentive of economical returns for expenditures toward increasing conveyance efficiency is the major motivating force stimulating individuals or companies to make such expenditures.

However, the public interests in efficient conveyance and distribution of water have, to some extent, stimulated increase in E_c . The courts have restricted total diversions of water to conform to reasonable conveyance and delivery practice, as well as to reasonable use of water on the land.

257. Economical Application. — Whereas conveyance and delivery of water in general are handled by some form of corporate enterprise, application and consumptive use are controlled almost entirely by individual irrigators. Naturally, therefore, the values of E_a and E_u vary widely on any large irrigation project, because of the differences in skill of the irrigators, the care used in distributing water, and the preparation of different farms for irrigation. Improved preparation of land and increase in expenditure of labor in applying water tend to increase E_a . Increasing E_a may or may not increase the profits of the irrigator. If an abundance of water is available to him at a total acre cost which is not influenced by the amount of water he uses on each acre, he may fully moisten his soil during each irrigation at a low cost per acre and yet permit excessive losses of water both in surface runoff and in deep percolation. These losses result in low application efficiency but may not cause uneconomical application. On the other hand, if the irrigator is required to pay for each acre-foot of water he uses, then a low efficiency in application is likely to result in uneconomical application. Therefore, from the viewpoint of the irrigator, if added expenditures in preparation of land and in the labor cost of efficient

application of water increase his profits by decreasing his water losses, then such expenditures are desirable; otherwise they should not be made. Unfortunately, the kind of application which is most economical to the irrigator is not always most economical to the public. Administrative organizations that convey and distribute water to the irrigators can do much toward increasing application efficiency by basing water charges on the quantity of water used, thus providing an incentive which will make the most efficient application of water approach more nearly the most economical application.

258. Economical Consumptive Use.— Many variable factors influence the economy with which irrigation water is consumptively used. These factors may be grouped and summarized as follows:

1. The factors which influence the biological processes that determine transpiration efficiency, E_i , and their economical control.
2. The factors which influence consumptive use efficiency.
3. The ratio of the total water supply to the arable land within economical reach of the water and the costs of storing, conveying, and delivering water to the farms.
4. The annual rental or interest cost of the irrigated land, together with the costs of cultivation, irrigation, crop harvesting, and land taxes.

The resultant influence of all these factors is most easily understood by making an analysis of the yield-water curve for a given crop in a particular locality. In some favored semi-arid localities the crop yields produced by the natural rainfall are relatively large and the average increase in yield by addition of irrigation water is so small that irrigation does not increase the farmer's profits and hence consumptive use of only the water supplied by natural precipitation is most economical. However, these cases are relatively few and therefore unimportant. Determination of what constitutes the economical quantity of irrigation water on the basis of well-established yield-water relations in localities where irrigation is really essential to crop production is therefore very important. A mathematical analysis of the problem by Clyde, Gardner and Israelsen is both interesting and fruitful. To the student who understands the elementary applications of the differential calculus, the analysis which follows in Articles 259 and 260 will be clear. Other readers may be interested in the results of the analysis without following the procedure in detail. Two cases are considered:

- (a) Where plenty of water is available to the irrigation farmer at a given price per acre-foot; and
- (b) Where the total water supply is inadequate to irrigate all the land.

259. Plenty of Water at a Given Cost. — In many irrigated regions the total water supply is sufficient to irrigate all the arable land provided the flood water is stored until needed for irrigation. In such regions or localities it is important to know whether the quantity of irrigation water, w , which will produce the maximum crop yield per acre is the most economical quantity to use, or if a smaller quantity would bring a greater profit per acre. In other words, how much irrigation water should be consumptively used to secure the maximum profit per acre of land?

- Let a = the price per ton of the crop on the farm.
- b = the cost per acre annually of plowing, seeding, fertilizing, tilling, taxes, rental value, and other costs which are proportional to acreage.
- c = annual cost of water per acre-foot, which includes the interest on money invested in water rights or shares of water stock, the maintenance charges, and the application of the water.*
- i = the net profit per ton.
- w = the number of acre-feet of irrigation water consumptively used. †
- y = the crop yield in tons.

The total cost of irrigation water consumed per acre annually equals the product cw . The net profit per ton, i , equals the price per ton, a , less the cost per ton, i.e., less the ratio of the sum of acre costs to the crop yield. In mathematical language,

$$i = a - \frac{cw + b}{y} \dots \dots \dots (64)$$

Multiplying equation (64) by y it is apparent that

$$iy = ay - cw - b \dots \dots \dots (65)$$

The first derivative of the product, iy , with respect to w is the slope of a curve (not shown here) representing the net profit per acre, and the point on this curve where the slope is zero gives the w that will return the greatest net profit. Differentiating equation (65) with respect to w ,

* It is realized that c as here defined is not rigorously constant. A more accurate analysis, considering c as a variable, is presented in the original paper but is not here included.

† It is here assumed that the deep percolation losses, D_f , are negligible from the plots on which the (y, w) curve have been determined, and hence that the irrigation water, w , applied to the plots has been consumptively used. Surface run-off from experimental plots, as a rule, is fully prevented.

there results

$$\frac{d(iy)}{dw} = a \frac{dy}{dw} - c$$

and for maximum profits

$$a \frac{dy}{dw} - c = 0, \quad \text{or} \quad \frac{dy}{dw} = \frac{c}{a} \dots \dots \dots (66)$$

Equation (66) gives the slope of the (y, w) curve at the depth of water w which will yield the maximum profit per acre. It is apparent that the ratio c/a determines the economic w .

To illustrate the use of equation (66) for determining the economical w , reference is made to Fig. 126 giving the (y, w) curve for sugar beets in Cache Valley, Utah. Assume that the cost of water annually, c , is \$3.00 per acre-foot, and the average price received for beets on the farm is \$6.00 a ton. The slope of the (y, w) curve c/a is then 0.5 at the point which represents the most economical w for sugar beets. Examination of Fig. 126 shows that the straight line having a slope of $\frac{1}{2}$ is tangent to the (y, w) curve at the point where $w = 2.5$ feet. Therefore when water costs are \$3.00 an acre-foot and beets are worth \$6.00 a ton on the farm, the most economical w is 2.5 feet, approximately. As a further illustration assume that water is obtained at a much higher cost, say \$8.00 an acre-foot, and that beets are worth only \$4.00 a ton on the farm. Then $c/a = 2.0$, and the straight line having a slope of 2.0 is tangent to the (y, w) curve at the point where $w = 2.1$ feet, approximately.

The above examples are given for the purpose of illustrating the method of analysis rather than for indicating specifically the economical depth of water for beets in Cache Valley, Utah.

260. The Water Supply Inadequate for All the Arable Land. — In the arid regions of the world some valleys are of such vast extent and are situated so far from watersheds having abundant precipitation that large areas of arable land will remain unirrigated even after all the available water is economically used. In such areas it is desirable to use the water supply so as to obtain the maximum profit for the entire area. It is probable that, under conditions of limited total available water supply, a lesser w will give more economical returns than the w required where plenty of water is available at a given price. To consider this case, in addition to the symbols used in Article 259,

let A = the area of land to be irrigated in acres, which may be less than the entire area of arable land.

N = the total number of acre-feet of water annually available.

P = the total profits for the entire area in dollars.

iy = the profit per acre in dollars.

It is evident that

$$N = Aw, \text{ and } P = Aiy,$$

from which, by eliminating A , it follows that

$$P = \frac{Niy}{w} \dots \dots \dots (67)$$

Differentiating P with respect to w in equation (67) there results

$$\frac{dP}{dw} = \frac{N}{w} \left[\frac{d(iy)}{dw} - \frac{iy}{w} \right] \dots \dots \dots (68)$$

At the peak of the total profits curve (not shown here), i.e., the point at which the total profits are a maximum, the derivative $dP/dw = 0$. Therefore, the right-hand member of equation (68) is equal to zero at the point of maximum profits, from which it is clear that, for maximum profits:

$$\frac{d(iy)}{dw} = \frac{iy}{w} \dots \dots \dots (69)$$

Equation (69) gives the slope $d(iy)/dw$ of the (iy, w) curve, or the profits-per-acre curve, at the w giving the maximum profits for the total area, but it is essential to know the slope of the (y, w) curve, i.e., dy/dw , at the same value of w . To solve for dy/dw it is necessary to differentiate the product, iy , of equation (69); differentiate equation (64) with respect to w , and thus get the value of di/dw ; and substitute the values of i and di/dw in the expanded equation (69). By this procedure it is found that

$$\frac{dy}{dw} = \frac{y - b/a}{w} \dots \dots \dots (70)$$

It is noteworthy that the quantity c does not appear in equation (70). This shows that the cost of the water per acre-foot does not influence the

* The student who has a working knowledge of differential calculus will probably be interested in the detailed procedure of obtaining equation (70) given herewith: Differentiating the left-hand member of (69)

$$\frac{d(iy)}{dw} = i \frac{dy}{dw} + y \frac{di}{dw} = \frac{iy}{w} \dots \dots \dots (a)$$

From equation (64)

$$i = \alpha - \frac{cw + b}{y}$$

and differentiating with respect to w , there results

$$\frac{di}{dw} = - \left[\frac{cy - (cw + b)dy/dw}{y^2} \right] \dots \dots \dots (b)$$

Substituting the above values of i and of di/dw in equation (a), and simplifying, there results

$$\frac{dy}{dw} = \frac{y - b/a}{w} \dots \dots \dots (c)$$

amount of water that should be consumed by each acre to bring the maximum profit for the entire area. However, if the most economical amount of water is used on each acre, then, as the cost of water increases, the total profits decrease, and *vice versa*. To illustrate the application of equation (70), the (y, w) curve for wheat in the Snake River Valley,

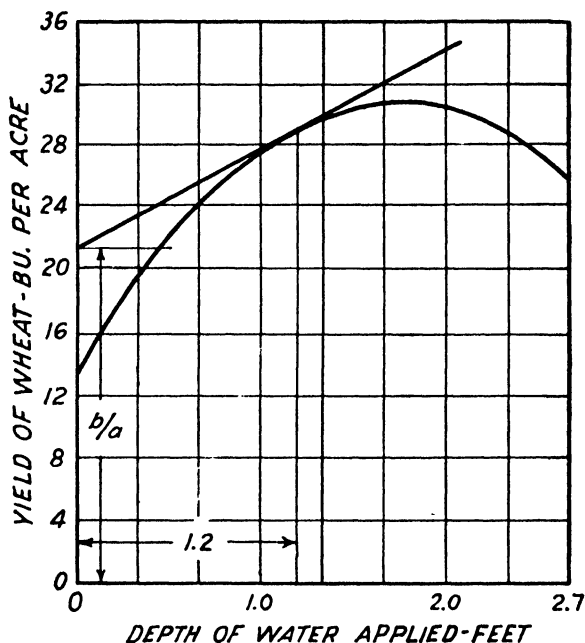

FIG. 127. — The (y, w) curve for wheat in the Snake River Valley, Idaho. (Engineering News-Record, Vol. 91.)

Idaho, is selected and given in Fig. 127. Assume that the costs for producing wheat are approximately as given below:

ESTIMATED COSTS OF PRODUCING ONE ACRE OF WHEAT IN SNAKE RIVER VALLEY,
IDAHO, CLASSIFIED AS b COSTS

Use of land or rental value	\$ 7.00
Taxes and insurance	0.50
Man labor	5.00
Horse labor	2.50
Seed and seed treatment	2.07
Binder twine	0.30
Interest and depreciation on machinery	1.20
Cost of threshing	1.25
Overhead, including minor items	1.30
<i>Total (b costs)</i>	<u>21.12</u>

Considering wheat at \$1.00 a bushel, then $b/a = 2112/100 = 21.12$. Marking this distance as indicated by the distance b/a and the vertical line in Fig. 127 and drawing a tangent to the (y, w) curve shows an economical w of 1.2 feet. Further, suppose that the cost of production remains constant but the price of wheat drops to \$0.68 a bushel. Then $b/a = 31$ and the economical w is equal approximately to the w that will give the maximum yield. This means that, when the price of wheat is low, the cost of production remaining constant, the maximum total profit will be obtained by irrigating a smaller area of land with the given water supply than when the price is high. Equation (70), like others of its kind, must be used intelligently, keeping its limitations in mind. To illustrate, if the ratio b/a is greater than y when a normal amount of irrigation water is used, the equation may be misleading. The limitations of equation (70) are further considered in the original article referred to at the end of this chapter.

261. Applications to Irrigation Practice. — The corporate enterprise and group of irrigators having the responsibility of economical use of water in the irrigation of a particular project are of necessity concerned with economical water conveyance, economical application, and economical consumptive use. In actual practice of irrigation in most of the arid states, the lack of economy in conveyance and in application of water seems to be so apparent as to suggest that the possible refinements in attainment of economical consumptive use as pointed out in Articles 259 and 260 constitute as yet a somewhat Utopian irrigation ideal. However, the improvement of irrigation practices with a view toward the attainment of economical use of water in every phase of irrigation activity is a matter of vital concern to arid-region communities, and should therefore be fully understood and vigorously encouraged by agricultural leaders and by engineers. It is well known that economy in the use of natural resources, including water, is influenced by local customs, laws, and decisions of courts. Therefore, the first essential in the application to irrigation practice of the results of sound analysis and experiment is the creation and maintenance of a well-defined public opinion that protests against wastefulness and encourages economical use of water. Substantial progress has heretofore been made toward the desired goal by creating, and following, the doctrine of "Beneficial Use" as the "basis, the measure, and the limit" of rights to use water. Although the doctrine of "Beneficial Use" served well in the earlier stages of its conception more than a half-century ago, it is now inadequate as a statement of the major objective in the use of water. It should be supplanted by the more appropriate and serviceable concept of "Economical Use" of water as the basic requisite to the most com-

plete utilization of agricultural resources of the West. A serious obstacle to the attainment of the most economical use of all water supplies is the fact that conflicts arise as to the relation of the interests of the individual irrigator and the interests of the entire community.

262. Individual vs. Community Economical Use.— According to the analysis of Article 259, in localities where plenty of water is available at a given price, each irrigator, if properly informed, will strive to use the amount of water, and only the amount, that will yield him the maximum profits. And since, in these favored localities, there is plenty of water for all the arable land, it is at once apparent that economical use by each individual in the community will assure economical use by the community as a whole.

However, as a matter of fact, this ideal situation seldom if ever fully exists in a community that is dependent on irrigation. Priorities of water rights and court decrees granting certain quantities to each of the many claimants on a river system exert a profound influence on the amounts of water actually used and on the degree of economy with which it is used.

REFERENCES

- CLYDE, HARRY S., GARDNER, WILLARD, and ISRAELSEN, O. W. The Economical Use of Irrigation Water Based on Tests, *Eng. News-Record*, **91**, No. 14 : 548. 1923.
- ISRAELSEN, ORSON W., and WINSOR, LUTHER M. The Net Duty of Water in Sevier Valley, Utah Agr. Exp. Sta. Bul. No. 182. 1927. (See especially pp. 16-18.)
- SMITH, G. E. P. Use and Waste of Irrigation Water, Arizona Agr. Exp. Sta. Bul. 88. 1919.

CHAPTER XIX

IRRIGATION OF CEREALS

Irrigation practices are determined largely by three conditions, namely: the climate of the locality, the soils under cultivation, and the crops grown. In the previous pages, attention has been given to the influence of climate and of soils on irrigation practices. The amounts of water properly applied in a single irrigation, the size of stream used, the length and width of land covered with a given stream, and the frequency of irrigation — all these factors are influenced largely by the soil con-

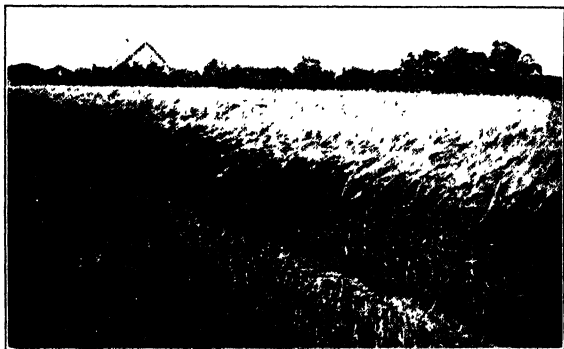

FIG. 128. — Irrigated barley (Utah Agr. Exp. Sta. Bul. 178).

ditions, but they are influenced also to some extent by the crops grown. The methods of irrigation selected, whether by flooding, in furrows, or corrugations, or by the spray system, are based largely but not wholly on the crop produced. Soil conditions usually predominate in the selection of the sub-irrigation method.

The cereal crops considered in this chapter include wheat, oats, barley, rye, and corn — the major cereals grown in the West. In several of the arid-region states these crops are grown both under dry-farming methods and on irrigated land. The higher lands of some of the irrigated valleys of the West which are above the irrigation canals produce large and profitable yields of wheat, barley, and rye without irrigation, under an average annual rainfall of 15 to 20 inches. The shallow gravelly or coarse sandy soils are unsuited to dry farming. In the more arid

parts, with a few notable exceptions, the cereal crops are produced largely under irrigation. An excellent crop of barley grown on irrigated land is shown in Fig. 128.

263. Methods of Irrigating Cereals. — The cereals are irrigated most extensively by the wild flooding, border-strip flooding, corrugation, and furrow methods. The check or basin method of flooding is also used to some extent on porous soils that are very nearly level.

Grain crops are rarely grown continuously from year to year on any one tract of irrigated land; rather they form a part of a general crop rotation. On new irrigation projects, grains sometimes form the major crop, but experience has amply demonstrated the desirability of producing forage and other crops as soon as the new lands can be properly prepared for them. The method of irrigation selected in the production of small grains is influenced by the methods used for other crops in the rotation period. For example, if the land has been carefully prepared for irrigation of alfalfa by the border-strip method, grains are irrigated by the same method. Likewise, if it is customary to irrigate the alfalfa by the corrugation method, the farmer may well use the same method for irrigating his grain.

The relative scarcity of water supply is also a factor in determining the method selected to irrigate grains. Where water is somewhat plentiful, especially during the early part of the season when grains are irrigated, the wild flooding method predominates. On the other hand, where the water supply is relatively limited and more expensive, grains are irrigated by the corrugation method or by the border method.

264. Time of Irrigating Cereals. — The grain crops are relatively early-maturing crops. It is a common experience in the inter-mountain states that the grains can be matured by the irrigation water applied in May and June, the months of flood discharges of the streams. On the shallow soils having but a small capacity to retain water some irrigation of cereals is essential late in April and also in July. In the higher valleys where the crop-growing season is very late, the cereals are irrigated largely in July and August. Fig. 115 shows that wheat and oats grown in Cache Valley, Utah, need comparatively little irrigation water after the early part of July.

In localities where the winter and spring precipitation is very low it is essential to irrigate the soil thoroughly before seeding the grain crop in order to supply enough soil moisture to assure satisfactory growth during the early stages of the plants when the shoots are delicate. Most soils in which cereals are growing bake somewhat and form cracks after the first irrigation, particularly when not shaded. Baking and cracking of the soil as a rule are injurious to the young cereal plants. Moreover, it

is rather difficult to avoid harmful soil erosion when water is applied to cereals before the plants are large enough to add stability to the soil. The young tender plants are easily killed by a slight amount of soil erosion that may leave no permanent detrimental effect on the land.

Experiments by Harris at the Utah Station show definite advantages in irrigating cereals at certain stages of their growth. The conditions of the experiments are given below.

265. Time for Wheat. — Harris irrigated the wheat plant in four stages as follows:

1. The stage when *fine leaves have developed* and the plants are 6 to 8 inches high.
2. The *early boot* stage when the plants were just swelling preparatory to heading.
3. The *bloom* stage when most of the plants were in bloom.
4. The *dough* stage when most of the plants were in the *dough*.

A 5-inch irrigation was used as a standard at each of these several stages. The soils of the experimental farm are deep loams of comparatively uni-

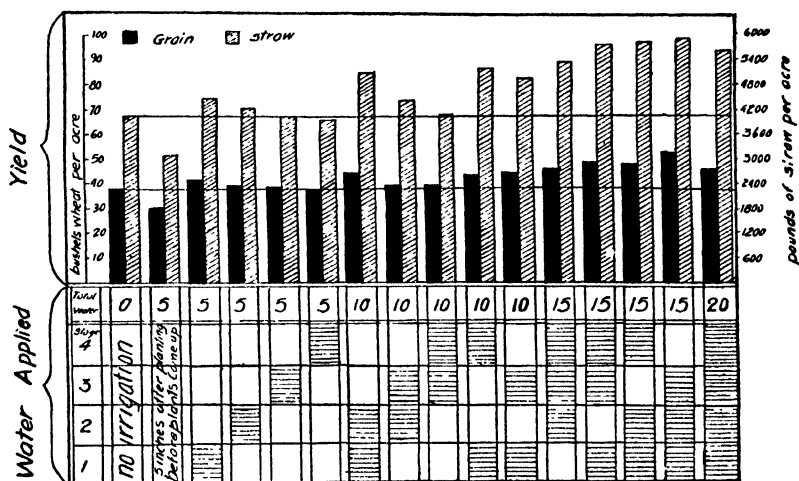

FIG. 129. — Yield of wheat grain and straw on plots receiving various quantities of irrigation water at different stages. (Utah Agr. Exp. Sta. Bul. 146.)

form texture, retentive of moisture, and highly productive when properly managed. The results of four years' work, 1912 to 1916, are presented in Fig. 129. In the lower half, the shaded areas show the stages at which water was applied, and the upper half shows in black columns the yield of grain and in shaded columns the yields of straw. The numbers from the reader's left to right show the total amounts of irrigation water given to

each crop. It is noteworthy that the plot which received no irrigation water produced approximately 38 bushels of grain with the moisture stored in the soil from the winter snow together with the water received from rainfall during the crop-growing season. The mean total annual precipitation during the 4-year period was 17.8 inches. The disadvantage of applying one 5-inch irrigation before the plants came up is apparent from the fact that the plot so irrigated produced less than any

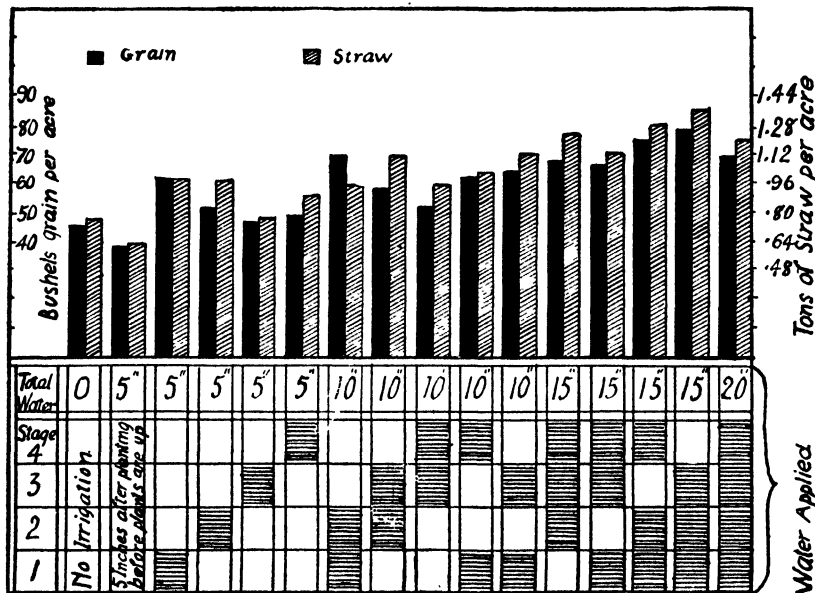

FIG. 130. — Yield of oat grain and straw on plots receiving various quantities of irrigation water at different stages. (Utah Agr. Exp. Sta. Bul. 167.)

of the plots which were given a 5-inch irrigation in each of the four stages above described and also less than the plot that received no irrigation water. Further, the figure shows quite clearly the advantages of irrigation during the earlier stages for the 5-inch, the 10-inch, and the 15-inch total seasonal applications. It is also significant that the 15 inches of water applied on each of the first three stages produced more wheat than 20 inches when applied in four 5-inch irrigations.

266. Time for Oats. — Three years' experimental work, 1916 to 1918, at the Utah Station on the irrigation of oats are reported in Fig. 130. The stages of irrigation are the same as above stated for the wheat crop. The average annual precipitation for the period was 18.1 inches. Careful inspection of Fig. 130 also reveals the importance of irrigation during the early stages, as in the wheat crop.

267. Time for Barley. — During the three years, 1919 to 1921, Harris and Pittman conducted experiments on the irrigation of barley at the Utah Station similar to the experiments above reported for wheat and oats. The average precipitation during the period was 17.2 inches. Results of the barley irrigation experiments are shown in Fig. 131. It will be noted that the irrigations during the early stages produced the higher yields. The results are similar to those for wheat and oats.

The necessity of maintaining always a moisture supply adequate for the needs of growing crops was pointed out in Chapter XIII. Soil

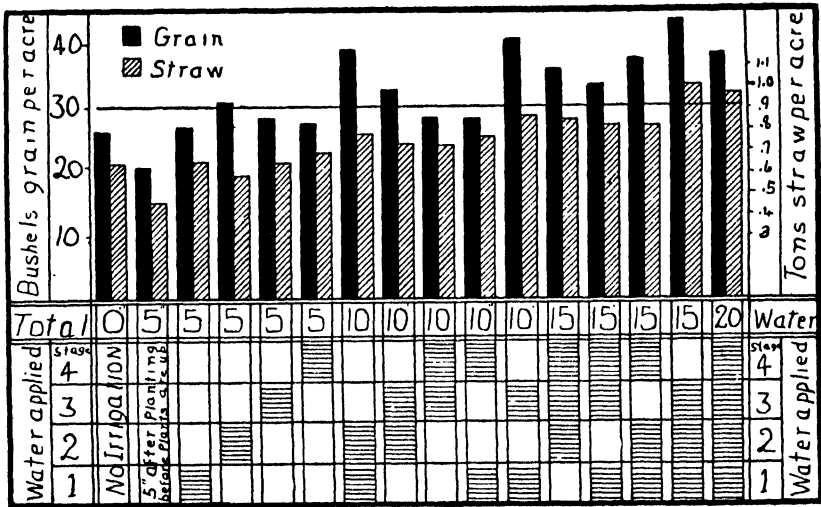

FIG. 131. — Yield of barley grain and straw on plots receiving various quantities of irrigation water at different stages. (Utah Agr. Exp. Sta. Bul. 178.)

moisture determinations were not made in connection with the Utah experiments on the irrigation of wheat, oats, and barley above reported. Whether or not the mean moisture percentage of the soil in the plots that produced low yields dropped to a point near or below the wilting coefficient is therefore not definitely known. The variable factors of climate and soils are so numerous and indeed so variable that caution in the application of the results of experiments on a particular soil in one locality to other soils in the same locality or in different localities is urgently necessary.

After several years of study of the production of grains at the Aberdeen substation, Idaho, Aicher makes the following statement concerning the time to irrigate:

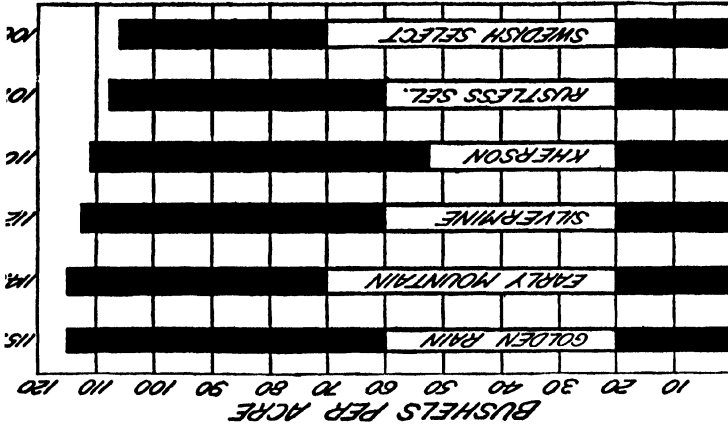

Fig. 133. — Average yields of the leading varieties of oats — Aberdeen substation 1913 to 1918 inclusive. (U. S. Dept. Agr. Farmers' Bul. 1103.)



Fig. 132. — Average yields of the highest yielding varieties of spring wheat — Aberdeen substation 1913 to 1918 inclusive. (U. S. Dept. Agr. Farmers' Bul. 1103.)

“Grain should be irrigated when the crop needs water, regardless of the stage of growth of the grain. Set rules for the irrigation of any crop are misleading, and any attempt to follow them rigidly often results disastrously. Seasons vary, and the time to irrigate a crop varies considerably with the season. Summer rains often are misleading, unless they exceed a half inch. Every year they are indirectly responsible for considerable loss in the irrigated sections. In southern Idaho, where the average precipitation during the growing season is 4.27 inches, it is a mistake to take the average shower too seriously. The immediate surface moisture is of little value in crop production, and unless the ground is moist to a considerable depth, the crop should be irrigated, regardless of the little moisture from small rains.”

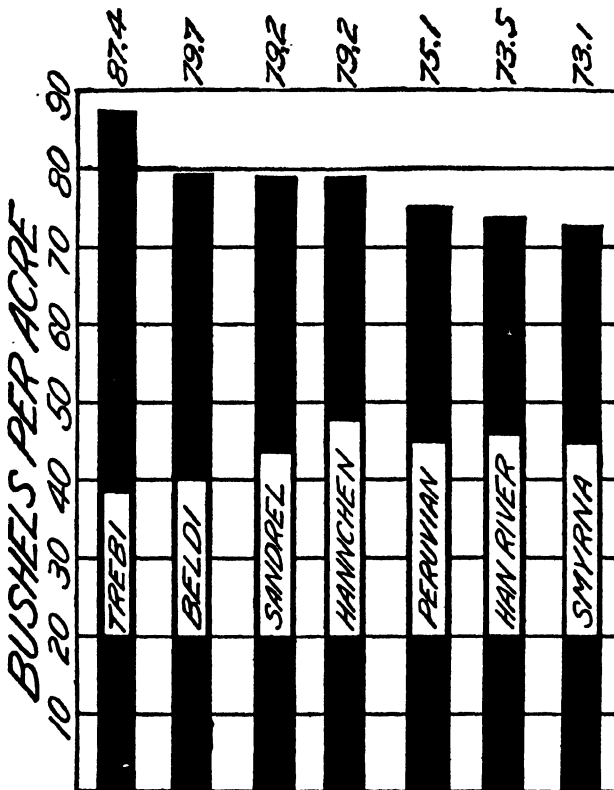

FIG. 134. — Average yields of the leading barley varieties — Aberdeen substation 1913 to 1918 inclusive. (U. S. Dept. Agr. Farmers' Bul. 1103.)

The yields of different varieties of wheat, oats, and barley obtained in the Snake River Valley, Idaho, by Aicher are presented in Figs. 132, 133, and 134.

268. Computation of Water Requirements of Grains.— That the amount of water evaporated and transpired by all crops to produce 1 pound of dry matter varies widely has been found by many investigators, as heretofore stated. There is no such thing as a precise evapo-transpiration ratio applicable under all variable natural conditions. However, for the purpose of illustration it is assumed that, in order to produce 1 pound of wheat, free from water, 1200 pounds of water are evaporated and transpired. Then if 100 pounds of wheat as taken from the thresher contains 94.35 pounds of dry wheat and 5.65 of water, the wheat has 6 per cent moisture on the dry-weight basis. Therefore to produce 1 pound of marketable wheat (water included) would require 1132 pounds of water evaporated from the soil and transpired through the wheat plants. A 40-bushel crop of wheat would require

$$\frac{40 \times 60 \times 1132}{227,000} = 12.0 \text{ inches (nearly)}$$

If it be assumed that the water application efficiency of E_a (of Chapter XVIII) is 70 per cent, then from equation (59) it is apparent that

$$W_f = \frac{12.00}{0.70} = 17.1 \text{ inches}$$

which means that for an evapo-transpiration ratio of 1200 and an irrigation application efficiency of 70 per cent, approximately 17 acre-inches of water per acre must be delivered to the farmer in order to enable him to produce 40 bushels of wheat per acre, provided the water received from the natural precipitation is negligible. If 5 inches of the necessary 12 inches were stored in the soil by natural precipitation, then the irrigator would need to receive at his farm 10 inches, of which he may store in the soil 70 per cent or 7 inches.

In most of the western states the growing season of the small grains is short as compared to the length of season during which temperature conditions favor plant growth. Although the evapo-transpiration ratio of the grains may be practically the same as it is for alfalfa, the shorter season and early maturity of the grains give them a lesser net seasonal water requirement than alfalfa. Many experiments of value concerning the water requirements of grains have been conducted by the State Agricultural College experiment stations and by the United States Department of Agriculture. Some of the results showing actual water requirements are presented in the following pages.

269. Water Requirements of Wheat.— The data presented in Fig. 129 indicate that 15 inches of water applied in three 5-inch irrigations to

the deep retentive soils of the Greenville Experiment Farm produced more wheat than 20 inches in four 5-inch applications.

Based on experiments from 1909 to 1916 on the irrigation of spring wheat grown on the medium clay loam soil of the Gooding Substation, Idaho, Welch concluded that 15 inches net was a sufficient amount of water for spring wheats and approximately 8 inches enough for winter wheats. The average annual rainfall at the Gooding Station during the period of experiment was 9.2 inches, of which 2.9 came during the crop-growing season, April 1 to August 31.

Working in Reno, Nevada, during the years 1914 to 1918, inclusive, Knight and Hardman obtained the highest yield of wheat with 28 inches of water. The soil of the Station Farm is described as varying from a sandy loam to a clay loam having an average depth of 4 feet below which there is a coarse sand and gravel. It is noteworthy also that the average annual rainfall during the 5-year period was less than 8 inches, and that during the crop-growing season the rainfall was negligible.

In the Salt River Valley, Arizona, Marr studied the water needs of wheat by measuring the quantities used on some 15 farms under ordinary practice. The soil of 7 farms is classed as sandy loam, of 1 as loam, and of 7 as clay loam. The annual precipitation is very low. During the period of the observations it ranged from 4.5 to slightly more than 9 inches. Marr considers it doubtful if attention should be given at all to the precipitation in studying the water needs of crops. He concludes that 17 to 22 inches of water are sufficient to mature wheat and similar crops in the Salt River Valley.

In the Mesilla Valley, New Mexico, climatic conditions are somewhat similar to those of Salt River Valley, Arizona. The average annual precipitation is 8.6 inches, of which an average of 5.8 falls during the summer season. The summer rains come in small showers, the average being 0.3 inch in 24 hours. The evaporation following rains is so rapid, and the depth of penetration of rains into the soil is so shallow, that Bloodgood and Curry conclude that the influence of natural precipitation during the crop-growing season is negligible as a source of water for crops. Based on a study of wheat production on 28 farms that received depths of water ranging from 7 to 25 inches they concluded that "fields receiving about 19 inches of water per season, applied in approximately 4-inch applications with an irrigation season of 150 days, gave the most satisfactory results as to yield per acre."

Fortier and Young have made a careful study of the "irrigation requirements" and the "water requirements" of the arid and semi-arid lands of the Southwest, from which they conclude that the water requirement of wheat — which includes irrigation water, stored soil moisture

used, and seasonal rainfall, ranges from 17.5 inches as the lowest general average to 27 inches as the highest general average.

270. Water Requirements of Oats. — The amount of water needed to produce oats economically differs but little from the amount needed for wheat. Harris and Pittman found that excellent yields of oats could be produced at the Utah Station with only 15 inches of irrigation water when applied at the proper time. For conditions like those of the Gooding Station, Idaho, Welch recommends about 21 inches of water for oats. Beckett and Huberty report that in the Sacramento Valley, California, during years of average or high rainfall, oats like wheat can be profitably produced without irrigation, whereas during years of very low rainfall two average irrigations will bring profitable returns through increased yield of oats. Under favorable soil conditions in the intermountain states, where the annual precipitation is 18 inches or more, oats may be produced without irrigation. However, oats is considered a valuable nurse crop and is widely grown on irrigated land as part of the crop rotation.

That remarkably high yields of oats may be obtained on irrigated land has been amply demonstrated at the Aberdeen Substation, Idaho, as reported by Aicher. Fig. 133 shows that by proper selection of varieties and by good management the irrigation farmer in the Snake River Valley under soil conditions similar to those at Aberdeen may produce from 100 to 110 bushels of oats per acre. Aicher asserts that from three to four irrigations should be sufficient during seasons of average rainfall.

271. Water Requirements of Barley. — Like wheat and oats, barley requires but moderate amounts of irrigation water. As shown in Fig. 131, Harris and Pittman found that only 10 inches of irrigation water at the Utah Station when applied during the early stages of growth produced 40 bushels per acre, whereas 15 inches applied in three irrigations, one irrigation in each of the first three stages, produced approximately 42 bushels, which was nearly 4 bushels more than was produced by 20 inches of irrigation water. For Snake River Valley conditions similar to those at Gooding, Welch recommends 18 inches for spring barleys.

Fig. 134 shows that barley, like oats, yields abundantly on irrigated land in southern Idaho, the averages ranging from 73.1 bushels per acre for the Smyrna variety to 87.4 bushels per acre for the Trebi variety.

272. Rye. — Of the 4 small grains — wheat, oats, barley, and rye — it is probable that rye requires the least water for adequate productiveness. Indeed, rye is seldom grown under irrigation because it is sensitive to excessive irrigation and because it yields so well under dry-farming conditions.

273. Corn. — In the western states the corn crop is growing gradually in importance with the expansion of the dairy industry. Although the production of large and economical yields of alfalfa for dairy feed make the production of corn silage less urgent than it otherwise would be, yet many leading dairymen consider corn silage an essential supplement to alfalfa. Corn grain may be produced on deep soils that are retentive of moisture with but very small amounts of water such as are supplied by natural precipitation. For silage production, however, irrigation is usually essential.

Widtsoe early found that maximum corn yields of nearly 100 bushels of grain per acre were produced at the central Utah Station with only 25 inches of irrigation water. His experiments also gave excellent yields with only 10 to 15 inches of water, and he concludes that under favorable soil conditions and in a climate such as prevails in Cache Valley, Utah, 12 to 15 inches of water are very satisfactory for corn.

Pittman and Stewart show that under the conditions of the Utah Central Experiment Station Farm corn increases rapidly in yield with increase in irrigation water up to about 20 inches; that the yields change but little as the water is increased to 30 inches, above which the yields tend to decrease. With an adequate supply of water on fertile soils the corn crop will yield from 60 to 80 bushels of grain per acre, or from 17 to 20 or more tons of silage.

REFERENCES

- AICHER, L. C. Growing Irrigated Grain in Southern Idaho, U. S. D. A. Farmers' Bul. 1103. 1920.
- BLOODGOOD, DEAN W., and CURRY, ALBERT S. Net Requirements of Crops for Irrigation Water in the Mesilla Valley, New Mexico, New Mexico Agr. Exp. Sta. Bul. 149. 1925.
- BECKETT, S. H., and HUBERTY, M. R. Irrigation Investigations with Field Crops at Davis and at Delhi, California, 1909-1925, California Agr. Exp. Sta. Bul. 450. 1928.
- FORTIER, SAMUEL. Irrigation Requirements of the Arable Lands of the Great Basin, U. S. D. A. Dept. Bul. 1340. 1925.
- FORTIER, SAMUEL, and YOUNG, ARTHUR A. Irrigation Requirements of the Arid and Semi-arid Lands of the Southwest, U. S. D. A. Tech. Bul. 185. 1930.
- HARRIS, F. S. The Irrigation of Wheat, Utah Agr. Col. Exp. Sta. Bul. 146. 1916.
- HARRIS, F. S., and PITTMAN, D. W. The Irrigation of Oats, Utah Agr. Exp. Sta. Bul. 167. 1919.
- HARRIS, F. S., and PITTMAN, D. W. The Irrigation of Barley, Utah Agr. Exp. Sta. Bul. 178. 1922.
- HUMBERT, E. P. Wheat Growing Under Irrigation, New Mexico Agr. Exp. Sta. Bul. 84. 1912.

Note: This bulletin is of a general nature: (a) Suggests no irrigation before seeding if water is plentiful. (b) Suggests that irrigation water be applied before seeding if water is scarce. (c) No data on amount of water needed.

- JONES, J. S., CLOVER, C. E., and FISHBURN, H. P. Irrigation and the Protein Content of Wheat, Idaho Agr. Exp. Sta. Bul. 109. 1918.
- KNIGHT, C. S., and HARDMAN, GEORGE. Irrigation of Field Crops in Nevada, Nevada Agr. Exp. Sta. Bul. 96. 1919.
- MARR, JAMES C. The Use and Duty of Water in Salt River Valley (Arizona), University of Arizona Agr. Exp. Sta. Bul. 120. 1927.
- PITTMAN, D. W., and STEWART, GEORGE. Twenty-eight Years of Irrigation Experiments Near Logan, Utah, Utah Agr. Exp. Sta. Bul. 219. 1930.
- WELCH, J. S. Experiments with Small Grains Under Irrigation, Idaho Agr. Exp. Sta. Bul. 93. 1917.

CHAPTER XX

IRRIGATION OF ALFALFA

A surprisingly small percentage of the total land area of the western states is irrigated or irrigable. Large areas are suited only to grazing purposes and therefore the livestock industry is of basic importance to western land utilization and hence to western prosperity. The production of forage crops to feed great numbers of beef and dairy stock, together with horses and mules and also sheep, during the winters where they are very severe, is of paramount interest in the West. Alfalfa is the most widely grown and the most hardy of the forage crops. It grows luxuriantly under the soil and climatic conditions of the arid regions provided it has an adequate water supply. In many localities during the late season of each year alfalfa retains its capacity for growth though dormant during the dry periods. It has wide adaptability, for both altitude differences and temperature fluctuations. During the long crop-growing seasons of the states of Arizona, California, and New Mexico, it produces from 6 to 8 cuttings per year with a total tonnage of 8 to 10 tons per acre, whereas in the higher valleys of the mountain states, in which the growing seasons are very short, only 1 or 2 cuttings are produced with yields of 1 to 3 tons per acre. It is produced satisfactorily as a major forage crop at elevations below the sea level and also at elevations nearly 8000 feet above the sea.

Fortier is authority for the statement that more than two-thirds of the acreage devoted to alfalfa in the United States is found in the 17 western states.

274. Methods of Irrigating Alfalfa. — Soil conditions influence the selection of method of irrigation of alfalfa to a really greater extent. Being a relatively thrifty and hardy plant, alfalfa can be satisfactorily irrigated by any one of several different methods. The methods most commonly practiced are flooding from field ditches, border flooding, and check or basin flooding. In localities where water supplies are very limited and where land surfaces are not suitable to border flooding or basin flooding, alfalfa is irrigated by the corrugation method. In alfalfa-seed-producing sections the corrugation method is especially advantageous because it permits of more thorough cultivation for control of insect pests.

Temporary submergence of alfalfa lands that are irrigated by the flooding methods is not harmful, but extended duration of submergence for many hours proves very harmful at times. High temperatures and reflection of the sun's rays from water surface to young alfalfa plants is injurious, and therefore long periods of submergence during the warmer parts of the season especially should be avoided. On comparatively level soils of low permeability irrigators sometimes keep the land submerged as a means of forcing the water to penetrate the soil. In growing alfalfa on soils that take up water very slowly it is probably better practice to irrigate more frequently and apply small depths of water at each irrigation. Effort should also be made to increase the permeability of such soils so far as practicable so that they may be adequately moistened without keeping the land submerged very long. For these impervious soils the furrow or corrugation method is advantageous. Very small streams may be kept in the furrows for relatively long periods and thus increase penetration of water into the soil without endangering the plants, and also without wetting and puddling the entire soil surface.

Alfalfa and hay lands permit, as a rule, the use of larger streams than can be handled for grains or root crops. In Utah the size of stream ranges from 2 to 5 c.f.s. with extremes of 1 to 7 or 8 c.f.s. Lands that are properly prepared for irrigation by the border or the check methods may permit the use of larger streams without erosion. In the Salt River Valley, Arizona, it is a common practice to use streams of 5 to 10 c.f.s. in irrigating alfalfa by the border-strip method. Even larger heads are used for alfalfa irrigation in parts of the Sacramento and San Joaquin valleys of California. The basin method for the irrigation of alfalfa is used to some extent where the land slope is not excessive. Small basins used for experimental studies of alfalfa irrigation are illustrated in Fig. 135. When properly irrigated, alfalfa yields abundantly. Fig. 136 illustrates an alfalfa field on which the hay is about ready to be hauled.

275. Alfalfa Root Distribution.— Alfalfa is generally known as a plant that sends its roots deeply into the soil. Beckett and Huberty conclude from a study of the distribution of alfalfa roots at Davis and at Delhi, California, that the irrigation treatment has no significant influence on root distribution. The results of their studies on 6 different plots are presented in Fig. 137. They found that, in spite of deep rooting of alfalfa in soils of open structure, one-third or more of the total weight of the roots in the upper 6 feet of soil is found in the upper 6 inches. Water is absorbed from the soil by plants largely through the tiny root hairs, which are most difficult to find in making a field study of root distribution. Furthermore, the weight of the roots through which water



FIG. 135. — Plots of irrigated alfalfa showing the dike for holding all the water on the plot. There is a space of 7 feet between the cropped plot areas. (Utah Agr. Exp. Sta. Bul. 219.)



FIG. 136. — Alfalfa should be put in small cocks while it is still green. This saves most of the leaves and helps to develop *aroma*. (Utah Agr. Exp. Sta. Circular 45.)

IRRIGATION OF ALFALFA

Irrigations per season						
Twelve 2½ inch		Eight 3½ inch		Six 5 inch		
Per cent	Soil type	Per cent	Soil type	Per cent	Soil type	
Roots		Roots		Roots	Soil type	
6	33.0	Fine Sandy loam	42.3	Fine Sandy loam	37.2	Fine Sandy loam
12	14.2	" "	15.2	" "	15.9	" "
18	11.9	" "	10.1	" "	12.6	" "
24	8.5	" "	8.1	" "	6.8	" "
30	7.5	" "	5.3	" "	6.9	" "
36	6.3	" "	4.8	" "	4.8	" "
42	4.8	" "	3.9	" "	4.4	" "
48	3.9	" "	2.3	Fine Sandy loam & Fine Sand	3.0	" "
54	3.1	" "	2.5	Fine Sand	2.6	" "
60	2.7	Fine Sandy loam & Fine Sand	2.2	" "	2.3	" "
66	2.4	" "	1.8	" "	1.8	" "
72	1.6	Fine Sand	1.5	Gravel	1.7	Fine Sandy loam and Gravel

Irrigations per season						
Four 7½ inch		Three 10 inch		Two 15 inch		
Per cent	Soil type	Per cent	Soil type	Per cent	Soil type	
Roots		Roots		Roots	Soil type	
6	33.2	Fine Sandy loam	34.0	Fine Sandy loam	35.7	Fine Sandy loam
12	14.6	" "	13.5	" "	15.6	" "
18	11.2	" "	10.3	" "	11.8	" "
24	8.2	" "	8.6	" "	8.2	" "
30	7.0	" "	6.2	" "	5.0	" "
36	5.4	Fine sandy loam and fine sand	6.0	" "	4.3	" "
42	4.8	" "	4.1	" "	3.6	" "
48	3.9	Fine sand	3.0	" "	4.4	Fine sandy loam and fine sand
54	3.3	" "	3.1	" "	3.1	Fine sand and gravel
60	3.3	" "	2.4	Fine sandy loam and fine sandy	3.3	Fine sand
66	2.5	Fine sand and gravel	1.8	Fine sandy loam sand and gravel	2.8	" "
72	2.6	" "	2.0	Gravel	2.2	Fine sand and gravel

FIG. 137. — Diagram showing root distribution of alfalfa under varying irrigation treatments at University Farm, Davis. Note that the root distribution has apparently not been affected by variation in irrigation treatments. (Calif. Agr. Exp. Sta. Bul. 450.)

is absorbed is relatively small. It is therefore significant that 1.5 to 2.6 per cent by weight of the total roots in the upper 6 feet of soil were found in the $\frac{1}{2}$ foot section immediately above the 6-foot depth. Aeration and essential bacterial activity occur at relatively great depths in arid-region soils. Although it is probable that alfalfa plants obtain their major water supply and nutrients in the upper few feet of soil, it is noteworthy that in well-drained soils some roots penetrate to great depths where changes of moisture content of the soil occur very slowly and indeed where the total extent of variation of moisture is small. Fortier properly points out that the roots of alfalfa grown in soils having a shallow water table are largely concentrated on the surface. Fig. 138 illustrates a case in which a water table at 3 feet caused a growth of more than 97 per cent of the roots in the upper 2 feet of soil. This condition of root distribution aids in understanding the apparent paradox that poorly drained alfalfa soils are first to permit serious damage to the plants through drought. The hot summer days and dry atmosphere cause rapid loss of water from the surface soil by transpiration and evaporation, the water table lowers, and the shallow soil zone in which roots are distributed has not enough stored water to meet the needs of the plants, with the result that drought damage is early noticeable.

Depth in feet	ROOTS	SOIL TYPE
	per cent	
0	51.10	Sand
1	46.56	
2	2.04	
3	.30	

FIG. 138. — Distribution of alfalfa roots with a water table 3 feet below ground surface.

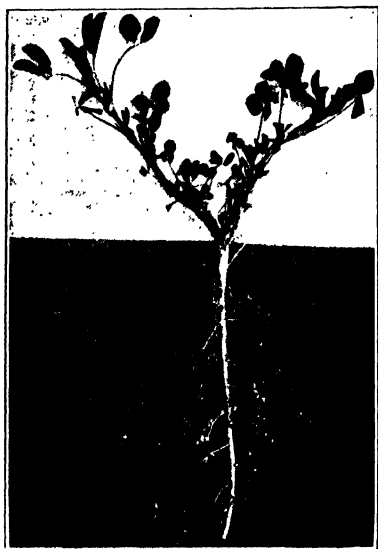

FIG. 139. — It is the nodules borne on the small roots of alfalfa that enable it to take nitrogen from the air. A nodule is a colony of bacteria. (Utah Agr. Exp. Sta. Circular 45.)

the needs of the plants if irrigation is long delayed. The root distribution of a typical alfalfa plant is illustrated in Fig. 139.

276. Time to Irrigate Alfalfa. — The amount of growth of alfalfa each day in a given soil is influenced largely by two factors, namely:

and indeed where the total extent of variation of moisture is small. Fortier properly points out that the roots of alfalfa grown in soils having a shallow water table are largely concentrated on the surface. Fig. 138 illustrates a case in which a water table at 3 feet caused a growth of more than 97 per cent of the roots in the upper 2 feet of soil. This condition of root distribution aids in understanding the apparent paradox that poorly drained alfalfa soils are first to permit serious damage to the plants through drought. The hot summer days and dry atmosphere cause rapid loss of water from the surface soil by transpiration and evaporation, the water table lowers, and the shallow soil zone in which roots are distributed has not enough stored water to meet the needs of the plants, with the result that drought damage is early noticeable. This condition is especially likely to occur on heavy soils of low water conductivity which cannot transmit water fast enough, even from ground water at shallow depths, to supply

(a) the available heat and (b) the adequacy of the available water supply. Man cannot influence the quantity of heat available — it is determined by the natural conditions in the locality. However, in irrigation farming, man can provide an adequate quantity of available soil moisture to assure the maximum rate of growth that the available heat and other conditions will permit. Excessive irrigation during the early season in the colder climates is believed to retard growth by cooling the soil. In Cache Valley, Utah, for example, soils that have high retentive capacity for the water provided by the melting of winter snow and by the spring rains seldom yield an increase in alfalfa from irrigation before the first cutting is half grown.

By careful observation, skillful alfalfa growers can detect from the appearance of the leaves of the growing alfalfa the approximate time that irrigation water is needed. A dark green color is usually considered as evidence of need for water. Temporary wilting also is warning that the supply of soil moisture is near exhaustion. In practice, however, in Utah and other states in which water is delivered largely by the rotation method, the irrigator must determine shortly before each water turn whether to irrigate at the next turn, possibly within a day or two, or wait the coming of the second water turn, possibly 10 to 15 days later. In such cases, inspection of the appearance of the crop may show no immediate need for water, whereas appreciable retardation of growth may occur by waiting till the second water turn arrives. Boring into the soil to a depth of 5 or 6 feet with a soil auger or a soil tube and examining the moisture condition of the soil is a very helpful aid to judgment in determining the time to irrigate. The author has examined the soil of many alfalfa fields, in which inspection of the plants and also of the surface few inches of soil showed no immediate need for water, and found the soil surprisingly dry at a depth of 2 to 3 feet and on down to 6 feet. Soil moisture conditions of this kind in alfalfa fields are positive indicators of need for irrigation at the earliest possible opportunity. There should be no dry soil within reach of the ordinary soil auger or soil tube, 6 to 8 feet, during the alfalfa-growing season.

277. Frequency of Irrigating Alfalfa. — Because of the many variable influencing factors there can be no definite frequency period of irrigation of alfalfa applicable to all conditions. The factors of major influence are the texture and depth of the soil; the temperature, atmospheric humidity and winds; and the crop-season rainfall.

Powers reports that on the sandy soils of the Umatilla Station, Oregon, it has been found best to irrigate every two weeks, whereas on the sandy loam soils of the Deschutes Valley on which two or three alfalfa cuttings

are secured, two irrigations per cutting are best; and on the heavy soils of Corvallis one irrigation per cutting is adequate.

On some of the shallow coarse-textured soils of Utah, irrigation every 10 days during the warmer part of the season is common; and light irrigations once each week are not exceptional on very gravelly shallow soils. Many of the alfalfa tracts on the deep loam soils of Utah produce abundantly when given one irrigation about one week before cutting the first crop, one shortly after harvesting the first crop, one before cutting the second crop, and one about two weeks after cutting the second crop.

278. Irrigation Requirements of Alfalfa. — As compared to most of the crops grown under irrigation, alfalfa requires relatively large amounts of irrigation water. This is not because alfalfa uses water at a low efficiency but rather because of the large annual tonnage production. The grain crops mature in a rather definite time period ranging from 90 to 110 days, whereas alfalfa grows continuously as long as the mean temperatures are well above the minimum growing temperature, and so long as there is no injury through freezing of the plants. It naturally follows that, the longer the growing season, the greater the irrigation requirement for alfalfa and the greater the tonnage produced. In the West, the growing season for alfalfa ranges from less than 100 days annually in some of the very high northern valleys to more than 300 days in some of the low valleys of Arizona and California. The annual yield of alfalfa, although greatly influenced by soil productivity, varies from less than 3 tons per acre to more than 10 tons, according to climatic conditions and length of growing season. The foregoing general statement of the amount of irrigation water needed for alfalfa is verified by the findings of experimenters in different states which are briefly summarized below.

279. Experimental Study of Irrigation Water Alfalfa Needs. — Working in the Salt River Valley, Arizona, Marr found that alfalfa yields increased with increase of irrigation water up to a total seasonal depth of 84 inches, but 48 inches is considered a safe quantity to use annually. By comparing his Arizona observations with similar studies in California and Idaho, Marr concluded that because of different climatic conditions a larger amount of irrigation water is required per ton of alfalfa in Arizona than in either of the other states. This relation is clearly shown in Fig. 116.

Adams, Beckett, Huberty, and others of the Division of Irrigation Investigation and Practice have made painstaking and extensive studies of the irrigation requirements of alfalfa in California. At the University Farm, at Davis, in the Sacramento Valley, they found a maximum alfalfa yield with 36 inches of irrigation water, annually, as shown in

Fig. 116 of Chapter XV, whereas at Delhi in the San Joaquin Valley 42 inches produced a maximum yield. It is concluded that the most economical amount of irrigation water for alfalfa at Davis ranges from 30 to 36 inches, whereas at Delhi it varies from 36 to 42 inches. The results of their work at Davis from 1910 to 1915 are presented in Fig. 140, and of their work at Delhi from 1922 to 1924 in Fig. 141.

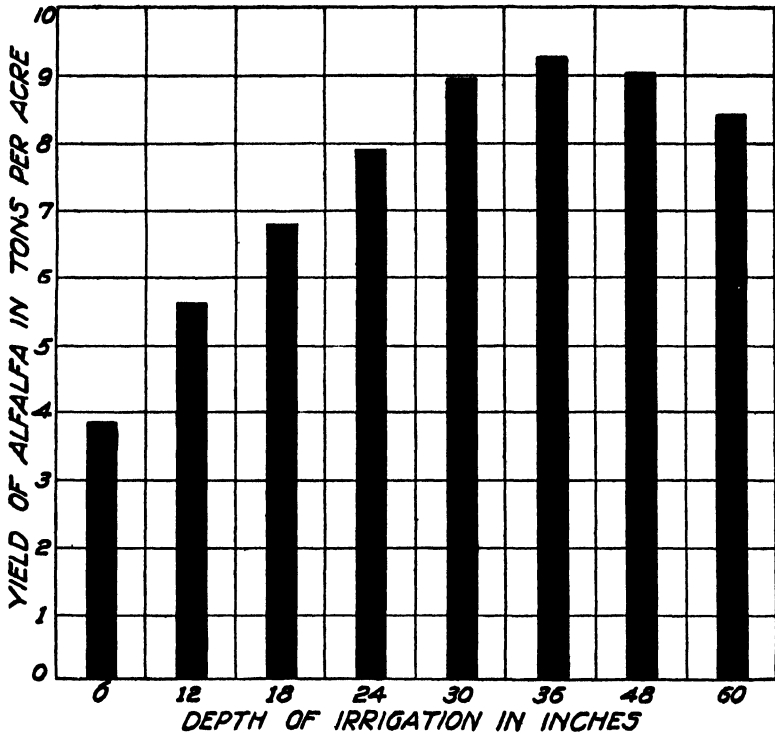

FIG. 140. — Diagram showing results of alfalfa duty-of-water experiments at University Farm, Davis, California, 1910-1915. Under the conditions present, the most economical yields were obtained with annual applications of 30 to 36 inches. (Calif. Agr. Exp. Sta. Bul. 450.)

Working on the lava soils of the Gooding Experiment Station in Idaho, Welch concluded that a seasonal use of irrigation water up to 33 inches may be justified by the increase of alfalfa produced.

Knight and Hardman, after a 4-year study of the irrigation requirements of alfalfa on the comparatively shallow sandy loam and clay loam soils of the Nevada Station at Reno, concluded that 42 inches of irrigation water was most economical for alfalfa.

In New Mexico, Bloodgood and Curry found that, as a result of measurements of water actually used on 85 farms in ordinary practice, about 50 inches during the season gave the best results. Thus the New Mexico findings in the Mesilla Valley, and the Arizona finding in the Salt River Valley, are closely comparable. Both are based on studies of use of water in crop production on a large scale, whereas the California, Idaho,

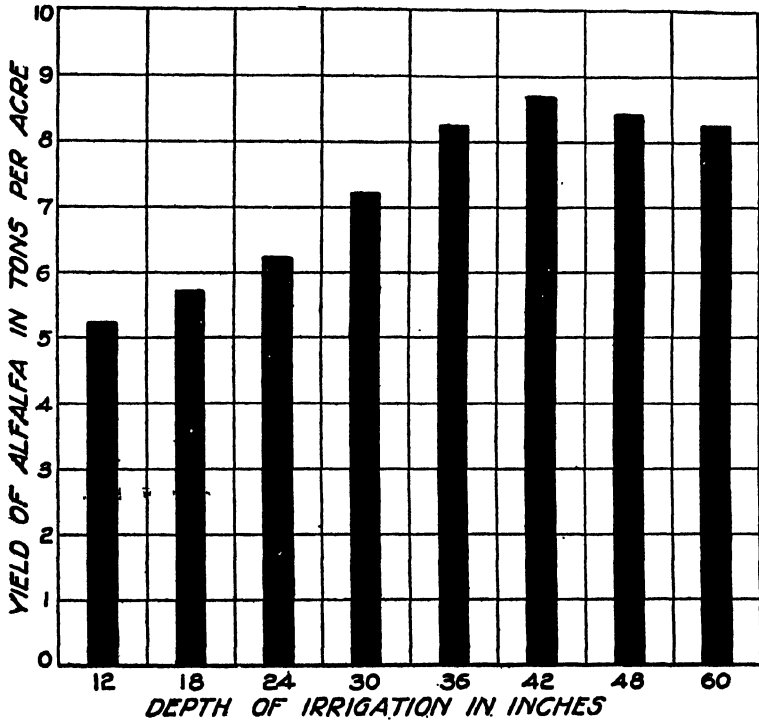

FIG. 141. — Diagram showing results of alfalfa duty-of-water experiments at Delhi, California, 1922-1924. Under the conditions present, the most economical yields were obtained with annual applications of 36 to 42 inches. (Calif. Agr. Exp. Sta. Bul. 450.)

and Nevada data above quoted were obtained from comparatively small experimental plots on which irrigation water was probably more carefully controlled and more uniformly distributed.

As a result of 43 trials on alfalfa farms in eastern Oregon, Powers found that 25 inches of irrigation water gave the maximum yield of approximately 4.5 tons per acre.

Twenty-eight years' study of alfalfa yields with different amounts of irrigation water applied to the deep well-drained loam soils of the

Utah Experiment Station, as reported by Pittman and Stewart, show that alfalfa yields increase with increase in irrigation water up to about 25 inches, beyond which point the rate of increase is very small. Excessive amounts of water, 100 inches or more per season, were applied to some of the experimental plots without causing a decrease in yield of alfalfa. The great depth of the soil and the excellent natural drainage apparently account for the fact that excessive amounts of water have thus far caused no reduction in crop yields. Most of the other crops studied at the Utah Station sustained a reduction in yield as a result of excessive irrigation, and some of them sustained a very marked reduction.

It is important to remember that the irrigation requirements as here reported do not include rainfall or soil moisture.

280. Clover Crops under Irrigation. — As yet there has been relatively little systematic experimental work on the irrigation of clover. Practical experience has demonstrated the adaptation of several different varieties of clover to the conditions of irrigation. In the Snake River Valley, Idaho, clover is produced extensively under irrigation both for pasture and for hay. Large amounts of clover seed also are produced under irrigation.

Under the same climatic and soil conditions as for alfalfa, the clover crops thrive best with more frequent irrigation than alfalfa requires.

Small amounts of water at each irrigation will meet the needs of the clover crops so that during the growing season they require no more water than alfalfa, and probably a little less.

281. Grasses under Irrigation. — Timothy, orchard grass, brome grass, and other hay-making grasses thrive in irrigated regions. Timothy and the native grasses live in spite of excessive irrigation and frequent submergence with water, but moderate quantities are doubtless best suited to their needs. In many of the valleys of the West the low-lying land areas are relatively wet on account of seepage from higher lands and inadequate natural drainage. Such lands produce one cutting for hay annually — the yield ranging from 1.0 to 1.5 tons per acre, after which a good growth of fall pasture is produced. These lands are as a rule excessively wet during the early spring and late fall, and hence are not suitable to the growth of alfalfa. When effective artificial drainage is provided for lands which ordinarily grow only timothy and native grasses, they produce alfalfa abundantly and return to their owners larger profits than are obtained from the grasses. Powers and Johnston have made a careful study of the improvement and irrigation requirements of wild meadow and hay land in Oregon, in which they found it possible to produce on reclaimed tule land a yield of clover and timothy

of $3\frac{1}{2}$ tons per acre, which is more than 3 times the average yield of wild hay.

In Utah, Oregon, and other western states there are large areas of grass lands that may be made to yield much higher returns through drainage, followed by planting clovers or alfalfa and then careful and moderate irrigation.

REFERENCES

References 1, 2, 3, etc., of Chapter XIX, and also the following:

- ADAMS, FRANK, *et al.* Investigations of the Economical Duty of Water for Alfalfa in Sacramento Valley, California, State of California Dept. of Eng. Bul. No. 3. 1917.
- BECKETT, S. H., and HUBERTY, M. R. Irrigation Investigations with Field Crops at Davis and at Delhi, California, 1909-25, California Agr. Exp. Sta. Bul. 450. 1928.
- BECKETT, S. H., and ROBERTSON, R. D. The Economical Irrigation of Alfalfa in Sacramento Valley, California Agr. Exp. Sta. Bul. 280. 1917.
- FORTIER, SAMUEL. Irrigation Requirements of the Arable Lands of the Great Basin, U. S. D. A. Dept. Bul. 1340. 1925.
- FORTIER, SAMUEL. Irrigation Practices in Growing Alfalfa, U. S. D. A. Farmers' Bul. 1630. 1930.
- HARRIS, F. S., and PITTMAN, D. W. The Irrigation of Alfalfa, Utah Agr. Exp. Sta. Bul. 180. 1921.
- ISRAELSEN, ORSON W., and WINSOR, LUTHER M. The Net Duty of Water in Sevier Valley (Utah), Utah Agr. Exp. Sta. Bul. 182. 1922.
- KNIGHT, C. S. Irrigation of Alfalfa in Nevada, Nevada Agr. Exp. Sta. Bul. 93. 1918.
- MCNEELY, L. R., and KOBLE, GEO. W. Soil Physics and Soil Moisture in Relation to First Year's Growth of Alfalfa, New Mexico Agr. Exp. Sta. Bul. 93. 1915.
- PACKARD, W. E. Irrigation of Alfalfa in Imperial Valley, California Agr. Exp. Sta. Bul. 284. 1917.
- POWERS, W. L., and JOHNSTON, W. W. The Improvement and Irrigation Requirements of Wild Meadow and Tule Land, Oregon Agr. Exp. Sta. Bul. 167. 1920.
- POWERS, W. L., and JOHNSTON, W. W. Irrigation of Alfalfa, Oregon Agr. Exp. Sta. Bul. 189. 1922.
- STEWART, GEORGE. Alfalfa Production Under Irrigation, Utah Agr. Exp. Sta. Circular 45. 1921.
- THOMPSON, C. A., and BARROWS, E. L. Soil Moisture Movement in Relation to Growth of Alfalfa, New Mexico Agr. Exp. Sta. Bul. 123. 1920.
- WELCH, J. S. Experiments with Legume Crops under Irrigation, Idaho Agr. Exp. Sta. Bul. 94. 1917.



PLATE VII. — Irrigating potatoes, King Hill Project, Idaho. (Courtesy: U. S. Bureau of Reclamation.)



PLATE VIII. — Irrigated sugar beets — Minidoka Project, Idaho. (Courtesy: U. S. Bureau of Reclamation.)

CHAPTER XXI

IRRIGATION OF SUGAR BEETS AND POTATOES

The production of sugar beets and potatoes under irrigation is well established in the arid regions of the West. Both sugar beets and potatoes require rotation with other farm crops from year to year in order best to control insect pests and plant diseases. In the states of Colorado, Idaho, and Utah, these crops are of special importance, being well suited to climatic conditions and to market requirements. Because of the relatively large labor demands and other expenses in preparing soil for sugar beets or potatoes it is essential to give careful consideration to irrigation in order to obtain profitable crops.

The importance of irrigation of sugar beets and potatoes warrants more consideration than can be given in this volume. It is the aim of this chapter to point out a few of the factors which must be carefully considered in order to attain success in the irrigation of sugar beets and potatoes.

282. Sugar Beets. — Careless practices in irrigation are almost certain sources of financial loss to sugar-beet growers. Beets are much more sensitive to extremes in soil moisture conditions than are alfalfa and other forage crops. Moreover, improper or careless handling of water on beet land, especially early in the season, causes soil erosion, puddling, cracking, baking, etc., all of which are seriously detrimental to beet production.

The urgent need of using painstaking care, and of following intelligent, approved practices, in the irrigation of sugar beets is fully recognized by most sugar company officials, with the result that active educational campaigns are conducted by sugar companies among beet growers as a means of attaining efficient and satisfactory irrigation.

283. Methods of Irrigating Sugar Beets. — In the major sugar-beet-growing sections it is almost the universal practice to irrigate beets by the furrow or corrugation method as illustrated in Fig. 142. Fine-textured loam and clay loam soils are best suited to the growing of sugar beets, and when irrigated by flooding these soils crack and bake around the young plants and retard their growth. Serious injury sometimes results also from contact between water and young beets. Even when the leaves are fairly large, sun scald caused by water surrounding the

beets is frequently very injurious. Flooding sugar beets is so rarely practiced that little more need be said about it, except to urge that it is seldom satisfactory and should be fully replaced by the furrow method.

The ever-present problem before the sugar-beet irrigator is to distribute water over the field as nearly uniformly as possible in order to avoid waste of water and crop injury due to over-irrigation on one part of his land, and insufficient depth of penetration of moisture on another part.

Smoothness of land surface, moderate lengths of furrows, care in making furrows, and proper control of the amounts of water entering the furrows from the head ditch — all these contribute to the attainment of



FIG. 142. — An example of excellent irrigation. Note the absence of flooding and the uniform distribution of water in the furrow. (Courtesy: Amalgamated Sugar Company.)

uniform distribution of irrigation water. Smoothing and leveling of the surface must be accomplished before seeding the crop. Careful plowing, harrowing, and dragging are always essential even on land that has long been cultivated. On new land, some scraping from high places into depressions is essential to satisfactory irrigation of beets. The selection of proper length of furrow is greatly influenced by the soil. The furrows on open, porous soil should seldom exceed 330 feet, or 20 rods, whereas on the loams and clays it is quite customary to use furrows 660 feet in length. To assure reasonable uniformity of distribution of water the irrigator must pay particular attention to regulating the size of stream that flows into each furrow. Streams that are too large cause breaking of the furrows and consequent accumulations of the

streams from many furrows into one very large stream that damages the soil by erosion and injures the beets. It is impracticable to set precise limits as to the proper size of stream for each furrow, but in general, the stream in each furrow varies from $\frac{1}{2}$ to $\frac{3}{4}$ c.f.s. Thus a stream of 1 c.f.s. is made to flow into 25 to 50 furrows at one time. Many Utah and Idaho beet growers regulate the amount of water flow-



FIG. 143. — Furrow irrigation of sugar beets in the Sevier Valley, Utah, showing the use of only one furrow for two rows of beets when the beets are small. (Utah Photo Materials Company.)

ing into each furrow entirely by making frequent adjustments in small V-shaped earth outlet ditches through the bank of the head ditch. Some irrigators place small bunches of grass in the outlet ditches to prevent high velocities and soil erosion. Sometimes one outlet from the head ditch is made to supply from 4 to 8 furrows by subdividing the stream below the head ditch outlet as illustrated in Fig. 143. More uniform distribution of water may be attained, and the labor of attendance somewhat decreased, by using small cylindrical metal outlet pipes having a diameter of 1 inch to 2 inches and lengths of 18 to 30 inches. Outlet pipes of this kind are especially desirable where irrigation water

is limited and costly. The major objection to their use is that they become damaged during times of cultivating the beet fields.

The most general practice is to space the rows uniformly about 20 inches apart and to make furrows between each 2 rows. For the first irrigation, in which a relatively small amount of water is used, it is quite customary to run the water in alternate furrows as illustrated in Fig. 143. For the second irrigation the water is run through the set of alternate furrows that were left dry during the first irrigation. During the periods between the later applications the beets use relatively large



Fig. 144. — Irrigation of sugar beets by the use of *differently spaced rows*, thus making one furrow irrigate two rows of beets. (Courtesy: Amalgamated Sugar Company — the "Sugar Beet" July, 1931.)

amounts of water, and farmers moisten the soil more fully by running the water in all the furrows.

A comparatively new practice that appears to be growing in favor is to plant the beets in rows differently spaced. For example, the distance between 2 rows may be but 16 inches, whereas the distance between the next 2 is 24 inches. Furrows for irrigation are then made only in the 24-inch open space, thus leaving 40 inches from center to center of the irrigation furrow. Under favorable soil conditions this method is satisfactory and doubtless is saving of water. Heavy compact soils in which capillary movement of water is very slow are not well suited to differently spaced alternate-row irrigation practice. Fig. 144 illustrates rows of sugar beets differently spaced.

284. Time to Irrigate Beets. — In time of irrigation, beets differ from the small grains in the fact that they require relatively large amounts of late-season water. July, August, and September are the months of maximum irrigation needs of beets in the Great Basin beet-growing areas. Because the natural discharge of many streams decreases markedly late in June or early in July, it is essential to provide late-season water for beets by storage or pumping.

In the earlier years of beet growing in Utah, the belief was rather widely entertained that the first irrigation of each season should be delayed until the beets showed definite wilting and consequent urgent need for water. It was thought the "struggle for water" thus imposed on the beet stimulated deep rooting and that beets of greater length than would be developed by early irrigation would result. A more recent, and apparently a more rational, basic guiding principle as to time of irrigation of beets is that large yields are most easily produced by providing all conditions, soil moisture included, favorable to a continuous growth of the plants from germination to maturity, at the maximum rate that the temperature conditions will support. The deep loam and clay loam soils in parts of the Rocky Mountain States sugar-beet areas are well supplied with moisture after normal winter snowfall and spring rains. Sugar beets use water at a low rate during the early part of their growth in May and June. The moisture stored from natural precipitation is usually sufficient during these months to support the maximum possible rate of growth. Beets therefore need relatively late-season irrigation water. In valleys in which both irrigated grains and sugar beets are grown, the major irrigation needs of the grain crops are completed before the heavier demands for water by the sugar beets occur.

285. Irrigation and Cultivation. — A few days after each irrigation of sugar beets during the early season when the leaves of the beets are small, the land is cultivated to prevent excessive evaporation and also to improve soil aeration. Evaporation as a rule is most rapid while the surface soil is wettest immediately following irrigation. It is therefore considered good practice to cultivate the beet land as soon as practicable without injury to the soil by puddling it or breaking down the favorable soil structure.

286. Irrigation Requirements of Beets. — The seasonal amount of irrigation water required for profitable production of sugar beets is probably slightly greater than the amount required for the small grains but appreciably less than that required for alfalfa, especially in climates where the growing season is very long.

Results of ten years' study of the irrigation requirements of sugar

beets as reported by Harris and Pittman in 1923 are shown in Fig. 145. The half of the figure on the reader's left shows that a maximum yield of more than 20 tons an acre was produced with ten 2½-inch irrigations applied weekly. It is noteworthy, however, that ten 1-inch irrigations produced practically the same yield of beets as ten 2½-inch irrigations, whereas ten 5-inch irrigations produced a smaller tonnage than either of the lesser depths of water.

In 1930, Pittman and Stewart conclude from examination of all the irrigation requirement studies with sugar beets at the Utah Station,

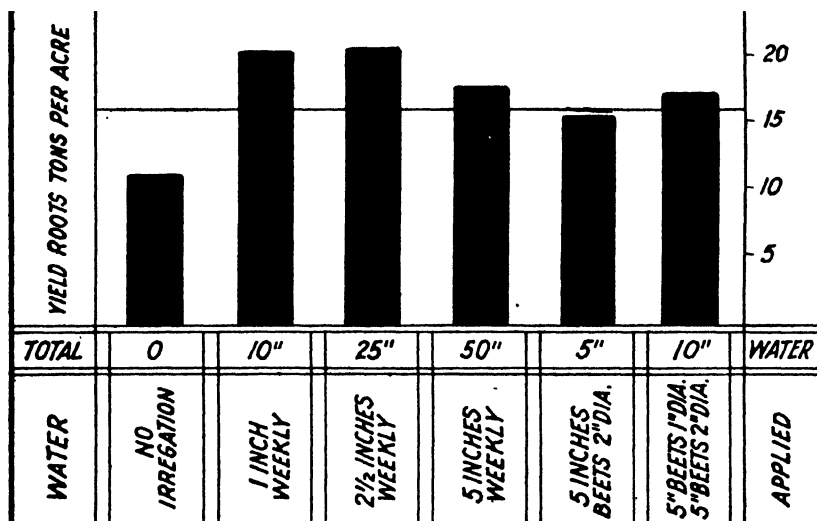

FIG. 145. — Yield of sugar beets on plots receiving different irrigation treatments. Average of 10 years. (Utah Agr. Exp. Sta. Bul. 186.)

including the work reported in 1923 by Harris and Pittman, that sugar-beet yields increase rapidly with increase in water applied up to 15 or 20 inches. In a few cases the yields increased with increase in water up to 25 inches or more. In general, however, sugar-beet yields decreased rather markedly as the depth of irrigation water was increased beyond 20 inches. In nearly every case, 10 inches of irrigation water produced higher yields than were obtained with 50 inches.

Results of studies of the net irrigation requirements of sugar beets in the Sevier Valley, Utah, by Israelsen and Winsor, from 1917 to 1920, are reported in Fig. 146. The annual precipitation in the Sevier Valley at Richfield is only one-half approximately of the rainfall in Cache Valley at Logan where the sugar-beet irrigation requirements were studied by

Harris, Pittman, and Stewart. In Sevier Valley it is both essential and customary to irrigate sugar-beet fields early in the springtime before planting the crop. The depths of water applied during each year of the experimental work, represented by the solid black bars in the lower part

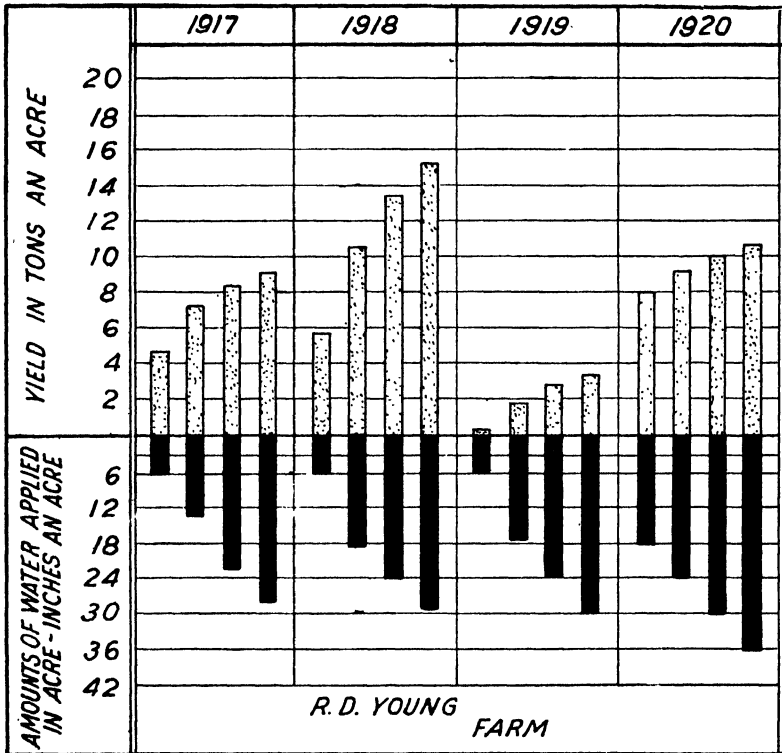

FIG. 146. — Yields of sugar beets in Sevier Valley, Utah, with various amounts of irrigation water. (Utah Agr. Exp. Sta. Bul. 182.)

of Fig. 146, include a 6-inch irrigation before planting. The number of irrigations after seeding and depths of water which it was aimed to apply in each irrigation are given in tabular form below:

1917	1918 and 1919	1920
(a) None	None	Three 4-inch
(b) Three 4-inch	Four 3-inch	Four 4.5-inch
(c) Three 6-inch	Four 4.5-inch	Four 6-inch
(d) Three 8-inch	Four 6.0-inch	Five 6-inch

The depths of water applied represent the net depths after surface runoff losses have been deducted. Because of the impracticability of holding all the water on the plots, the net seasonal depths *actually* used differ slightly from the depths which it was aimed to supply as reported above.

Knight and Hardman working in Nevada found comparatively small differences in sugar-beet yields as the depth of irrigation water was increased from 12 to 18 and finally to 24 inches. The maximum yield was obtained with 18 inches.

287. Potatoes. — The soils in many valleys of the West are well suited to production of potatoes. When properly irrigated and kept free from diseases and insect pests potato production is a profitable means of obtaining ready cash to meet the annual needs of the irrigation farmer.

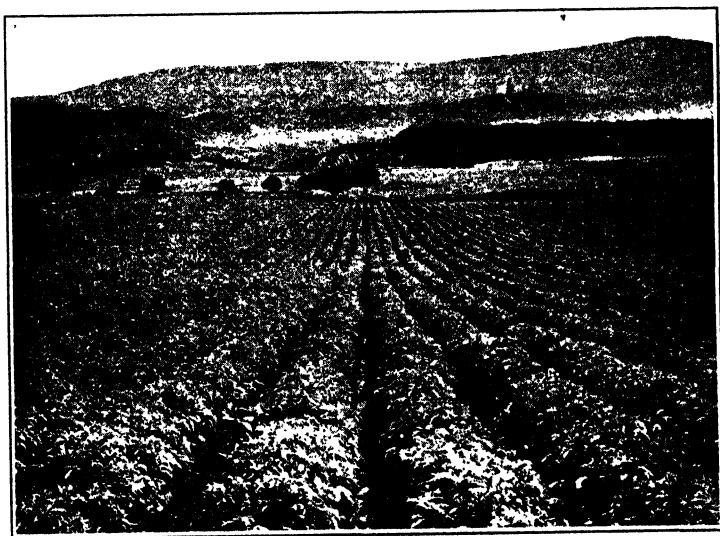

FIG. 147. — Irrigated potatoes in Colorado. (Colo. Agr. Exp. Sta. Bul. 314.)

Each year many carloads of this bulky product of the irrigated farms of arid regions are rolled long distances to the larger markets. Although freight charges during years of high potato production and low prices absorb substantial percentages of the gross returns, farmers in favored potato-producing sections, like parts of Cache Valley, Utah, and the Snake River Valley, Idaho, claim that average net returns on potatoes over a period of years compare very favorably with the returns on other irrigated crops. Already considerable attention is being given to perfection of processes for concentrating the food products in potatoes as a

means of reducing shipping tonnage per acre of product and thus eliminating the high freight costs. Potatoes thrive under widely different climatic conditions, but they are sensitive to excessive heat. Loose open loams and sandy loams are better suited to potato growing than the heavier compact clay soils.

288. Methods of Irrigating Potatoes. — Reasonable care in smoothing and leveling potato land is essential to satisfactory irrigation. Except under very favorable natural soil conditions that permit of sub-irrigation, potatoes are always irrigated by the furrow method. It is especially important to avoid direct contact of water with plants, and hence deep furrows are best suited to potato irrigation. The use of deep furrows

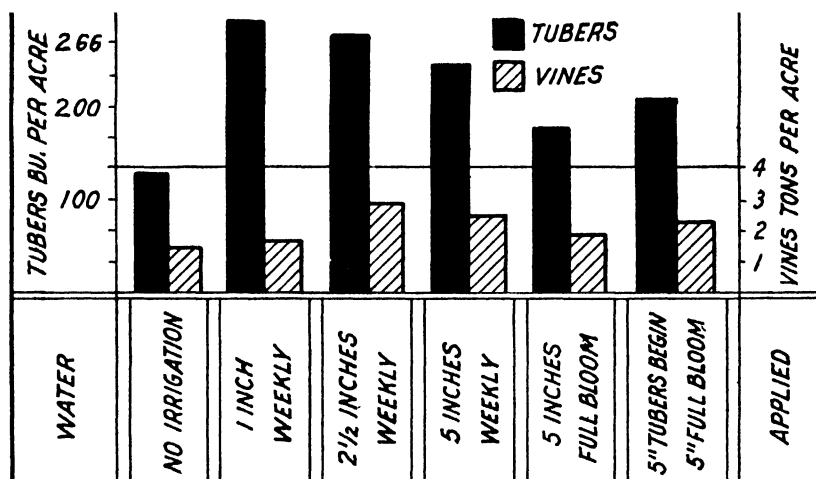

FIG. 148. — Yield of potatoes and vines on plots receiving various irrigation treatments. Average of 10 years, 1912–21. (Utah Agr. Exp. Sta. Bul. 187.)

makes it possible to irrigate potatoes satisfactorily on land that is not smooth enough to permit proper irrigation of sugar beets. Complete saturation of the soil around the potato vines followed by baking and cracking is seriously detrimental to potato production. It is desirable to have the furrows from 10 to 12 inches deep in most soils, thus eliminating the risk of submerging the vines or of excess water around the tubers. Under favorable topographic and soil conditions potato furrows may be longer than beet furrows. Probably 1320 feet is a maximum profitable length, and as a rule 660 feet is preferable. Shorter furrows are necessary in very porous soils. Fig. 147 illustrates a field of irrigated potatoes in Colorado.

289. Time to Irrigate Potatoes. — In the growing of potatoes, as in growing sugar beets, the basic guide in time to irrigate is the moisture content of the soil. At the outset before the potatoes are planted it is highly important that the soil be well supplied with moisture in order to germinate the potato crop and give it a good start before the first irrigation after planting. In localities in which the winter season precipitation is too small to fill the soil to its capillary moisture capacity,

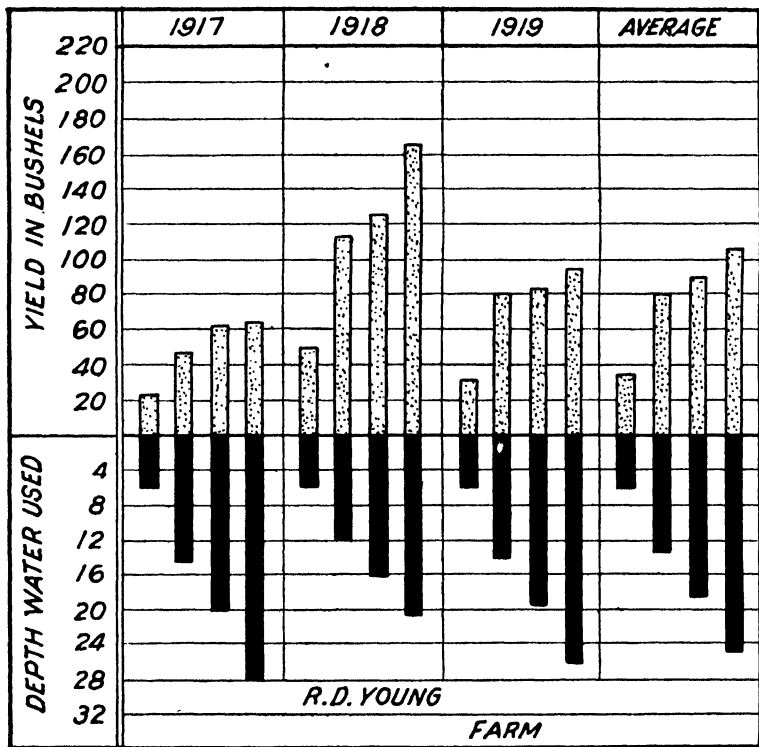

FIG. 149. — Yields of potatoes in Sevier Valley, Utah, with various amounts of irrigation water. (Utah Agr. Exp. Sta. Bul. 182.)

irrigation water should be applied before planting but never immediately after planting.

290. Irrigation Requirements of Potatoes. — The amount of irrigation water required during the season for potatoes differs but little from the amount required for sugar beets under the same soil and climatic conditions.

Experiments by Harris and Pittman at the Utah Station show a decided advantage in small irrigations at frequent intervals. Fig. 148

gives the average results of 10 years' study showing a maximum yield with 1 inch weekly for 10 weeks. A total of 25 inches of water in ten 2.5-inch irrigations produced 266 bushels per acre, or almost as much as was produced with the ten 1-inch irrigations. Fifty inches of water applied in ten 5-inch irrigations caused a marked decline in yield, and 10 inches applied in two 5-inch irrigations produced much less than 10 inches applied in ten 1-inch irrigations.

Based on the results of some 28 years of study of the irrigation needs of potatoes on the Utah Central experiment farm, Pittman and Stewart conclude that the yield of potatoes increases with increase of irrigation water up to about 15 inches depth per season, and that depths of water in excess of 20 inches usually cause a decrease in yield. In a very few cases, larger depths of water, although accompanied by large potato yields, seemed to be directly responsible for poor quality of potatoes.

Results of a 3-year study of the irrigation needs of potatoes in the Sevier Valley, Utah, by Israelsen and Winsor are presented in Fig. 149. As heretofore stated, it is essential to irrigate before seeding annual crops because of the very low winter precipitation. Except in 1918, the total acre yields were rather low. It is noteworthy, however, that during each year the greatest depth of irrigation water produced the greatest yield of potatoes.

291. Irrigation of Other Root Crops. — Mangel-wurzels, carrots, onions, turnips, beets for table use, and other miscellaneous root crops are grown successfully under irrigation, although the area of irrigated land devoted to these crops is relatively small. It is the general practice to irrigate all the root crops by the furrow method, except under special soil conditions which make sub-irrigation feasible. The necessary frequency of irrigation depends, as for sugar beets and potatoes, very largely on the texture, structure, and depth of the soil. The seasonal depths of irrigation water needed are substantially the same as the depths needed for sugar beets, although onions and carrots seem to thrive in comparatively moist soil.

REFERENCES

References 1, 2, 3, etc., of Chapter XIX, and the following:

- HARRIS, F. S., and PITTMAN, D. W. Irrigation Experiments with Sugar Beets, Utah Agr. Exp. Sta. Bul. 186. 1923.
- HARRIS, F. S., and PITTMAN, D. W. Irrigation Experiments with Potatoes, Utah Agr. Exp. Sta. Bul. 187. 1923.
- ISRAELSEN, ORSON W., and WINSOR, LUTHER M. The Net Duty of Water in Sevier Valley (Utah), Utah Agr. Exp. Sta. Bul. 182. 1922.
- SANDSTEN, E. P. Potato Growing in Colorado, Colorado Agr. Exp. Sta. Bul. 314. 1927.

CHAPTER XXII

IRRIGATION OF ORCHARDS

The irrigation of orchards is of extraordinary interest because of the beauty as well as the utility and the relatively high value of orchard products. Production of fruits requires large acre investments in both capital and labor, and consequently special attention may well be given to irrigation — a practice of basic importance in most of the arid-region fruit-growing sections. Fruit growing has reached a high state of development in certain regions in the West, notably in parts of California where water supplies are seriously limited and water costs are high. Under these conditions it is economically feasible to reduce water losses to a minimum and to attain high efficiencies in the use of irrigation water. This chapter considers briefly the methods of orchard irrigation, the time of irrigating orchards, and the amount of water required by apple, peach, and citrus trees under certain soil and climatic conditions, as found by field experiments.

292. Methods of Irrigating Orchards. — Orchards are irrigated largely by the furrow method. The basin method is used to some extent, but the area irrigated by the basin method is relatively small. In deciding on the method to be used in the irrigation of orchards, it is highly important to keep in mind that the nature of the soil and the topographic conditions influence the method of irrigation for orchards quite as much as, if not even more than, for irrigation of grains, forage crops, or root crops. Extreme conditions of soil permeability which result from great variability in soil texture and structure from point to point in the orchard make uniform distribution of water by the furrow method very difficult. For such conditions the basin method described in Article 299 may be better suited than the furrow method. The cost and the degree of scarcity of water also influence the selection of method — there is no general rule applicable to all cases. A few orchards are irrigated by the spray method, as illustrated in Fig. 150.

293. The Furrow Method. — An excellent illustration of orchard irrigation by the furrow method is presented in Fig. 151, representing a California cherry orchard. There are 7 furrows between each 2 rows of trees, thus making it easy to moisten all the soil in which the tree roots are distributed. Other illustrations of the furrow method are considered

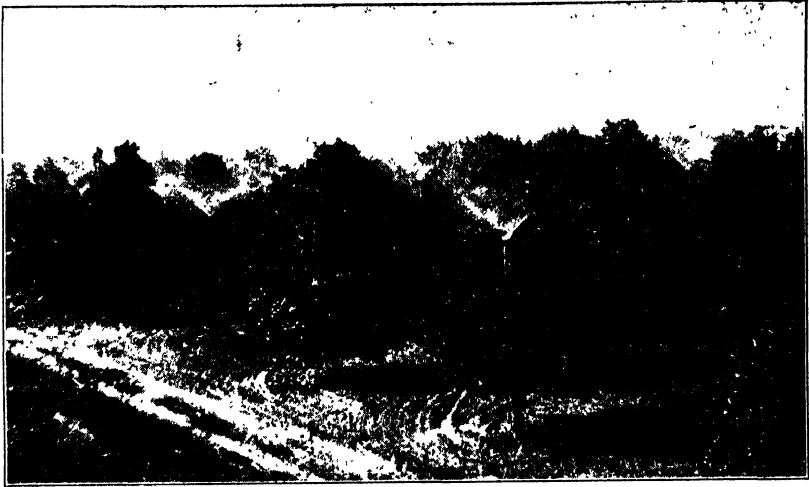

FIG. 150. — Permanent orchard-spray irrigation system in operation. (Courtesy: Division of Irrigation Investigations and Practice, University of California.)



FIG. 151. — Furrow irrigation of cherry orchard. (Courtesy: Division of Irrigation Investigations and Practice, University of California.)

in connection with later articles concerning the several factors in the furrow method. The important factors to be decided in the use of the furrow method for orchard irrigation are:

- (a) Length of furrows.
- (b) Spacing and depth of furrows.
- (c) Slope of furrows and size of stream in each.
- (d) Method of conveying and delivering water to the furrows.
- (e) How to make the furrows.

294. Length of Furrows. — For soils of comparatively uniform texture and structure and satisfactory depths, say 5 feet or more, it is considered good practice to use furrows as long as 600 feet. Shallow soils and soils of high permeability and low water-holding capacity, and especially soils of variable depth and structure, require much shorter furrows to facilitate uniform water distribution. Short furrows require extra labor in attendance of water, and where water is not too costly, longer furrows may be justified in spite of variability in soil and relatively larger losses of water through deep percolation. Deep soils of high water-holding capacity and uniform permeability permit the use of comparatively long furrows. In a study of the irrigation of citrus groves in southern California, on comparatively heavy loam soils, Thomas found that furrows greater than 300 feet in length were undesirable. Excessive moistening of the soil near the heads of furrows 800 feet or more in length decreased the efficiency in application of water and decreased the productivity of the trees.

295. Spacing and Depth of Furrows. — In addition to being influenced by soil conditions, spacing of furrows is influenced by the age of orchard trees. Climatic conditions also tend to influence spacing of furrows. The spacing should always be such that all the soil in which the tree roots may be active should be adequately supplied with readily available soil moisture. With a plentiful water supply, the irrigator may aim to moisten all the soil even in young orchards, by using 5, or even more furrows between the tree rows, as illustrated in Fig. 151. On the other hand, where water is very costly, tree growers frequently obtain satisfactory growth of young trees by using only 2 furrows — 1 on each side of the tree row. On the shallow gravelly soils of the Brigham City peach-growing area of Utah some mature peach orchards have but 1 furrow on each side of the tree row. A much better practice, however, in producing orchards, is to use 2 or 3 furrows on each side of the tree. In mature orchards it is important that the entire root zone of soil below the first few inches on the surface be adequately supplied with readily available soil moisture. Especially in the coarse-textured shallow soils, downward movement of soil water is much more rapid than lateral move-



FIG. 152. — Irrigation of peaches near Brigham City, Utah. (Utah Agr. Exp. Sta. Bul. 142.)



FIG. 153. — Furrow irrigation of prune orchard in California using three furrows. (Photo by Author.)

ment, and therefore great distances between furrows make it impossible to moisten all the soil. Fig. 152 illustrates the use of 2 furrows on each side of the tree row, i.e., 4 furrows between each 2 rows of trees. The tree rows shown in Fig. 152 are spaced 16 feet apart and the furrows are 3 feet and 5 feet from each row, thus leaving a space of 6 feet between the 2 furrows that are 5 feet from the trees. In this case 1 additional furrow midway between the tree rows is considered desirable.

There seems to be a common misconception among some intermountain fruit growers that furrows must be made very close to the trunks of the trees in matured orchards. Reasonably close proximity (1 to 2 feet) of furrow to tree in newly planted orchards is doubtless advisable in most soils, but such close proximity in mature orchards, especially apple orchards, is quite unnecessary. Some mature orchards of medium texture and structure in the surface soil and heavy compact subsoils are well irrigated with only 3 furrows between the rows of trees, as shown in Fig. 153. Obviously the number of furrows between the tree rows is influenced also by the spacing of the trees. For tree rows such as shown in Fig. 153 spaced 24 feet apart, the furrows are spaced 8 feet approximately, thus making the furrows nearest the tree rows within 4 feet of the rows of trees.

In many apple orchards it is impracticable to make furrows closer than 6 feet, except by special methods or the use of extension implements. The spreading trees prevent the use of closer furrowing with the ordinary horse-drawn implements. If such orchards are grown in fine-textured, compact soils, it may be advisable to make 2 curved furrows nearest the trees, as illustrated in Fig. 154. Large areas of "dry spots" or large volumes of unirrigated soil result from too great distances between furrows. These unirrigated portions of the soil are not conducive to maximum production and should be kept at a reasonable minimum. Although it is clearly impossible to specify in one general rule the spacing of furrows that will best accomplish the desired moistening of the soil for all cases, it is possible and advisable for the orchard irrigator to trace the distribution of the moisture in the soil after irrigation by use of a soil auger or a soil tube in order to obtain the information essential to intelligent spacing of his furrows. The wisdom of this practice has long been recognized by leading investigators of soil-moisture problems as related to orchard irrigation. The practice of tracing the depth of penetration of irrigation water and the distribution of water in the soil after irrigation is illustrated in Fig. 155.

Penetration of water into orchard soils, especially of the heavier types, is greatly facilitated by the use of deep furrows. It is usually advisable to make furrows from 6 to 8 inches in depth if the orchard soil has a low

permeability to water. Furrows of more than average depth are illustrated in Fig. 156, which shows 4 furrows equally spaced between the rows of a California peach orchard. In making deep furrows it is essential to exercise caution against undue injury to tree roots. Cutting of many roots in the surface soil may make deep furrowing disadvantageous.

296. Slopes of Furrows. — Wide variation in slope of furrows is possible for irrigation of orchards provided the size of the stream in each furrow is properly regulated. Some side-hill lands in California, Oregon, and Utah, having a grade as great as 20 feet per 100 feet — so great as to render frequent plowing, tilling, and harvesting of ordinary farm

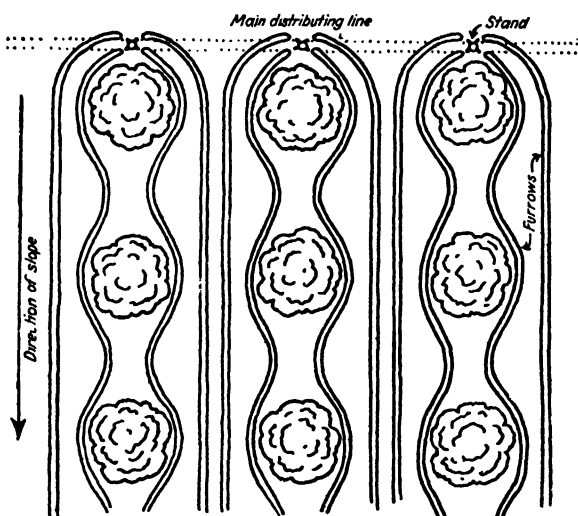

FIG. 154. — Combination of straight and curved furrows near Exeter, Tulare County. (Calif. Agr. Exp. Sta. Bul. 253.)

crops unattractive — are planted to orchards. Some of these side-hill orchards are irrigated by running the furrows down the steepest slope. Excessive soil erosion is avoided by using a very small stream in each furrow, 1/50 c.f.s., or even less. The later and better practice is to plant the trees along contour grades as illustrated in Fig. 157. This type of planting permits the distribution of water in furrows having slopes desired by the orchardist.

Huberty and Brown group the contour orchard layouts into three general types, namely:

1. Uniform spacing of trees along a grade contour without regard to alignment.



FIG. 155. — Tracing the penetration of irrigation water in the soil, Santa Clara Valley, California. (Photo by Author.)



FIG. 156. — Furrow irrigation of peach orchard near Fresno. (Courtesy: Division of Irrigation Investigations and Practice, University of California.)



FIG. 157. — Many orchards in California are planted on hillsides where the frost hazard is low and land is less expensive. Irrigation on steep, irregular slopes is most effective when the water is distributed by contour furrows, and the tree rows are planted along the contour grades. (Calif. Agr. Extension Service Circular 16.)

2. Uneven spacing of trees along a grade contour with straight cross rows.
3. Trees planted on varying grades with straight cross rows.

These authors give valuable detailed information concerning water distribution systems, grades of contour rows, methods of layout, contour planting costs, and irrigation practices for side-hill lands.

On very high-priced land in localities where water is scarce, side-hill lands are sometimes terraced before planting orchards, as illustrated in Fig. 158. Terracing enables the irrigator to apply water more uniformly and to reduce water losses. Where terraces are used for side-hill land, or on comparatively level land where the slopes of furrows may be



FIG. 158. — Sidehill terraced for orchard irrigation by the furrow method. (U. S. Dept. Agr. Farmers' Bul. 882.)

selected to suit the wishes of the orchard owner, a range in slope from 0.4 to 1.0 foot or more per 100 feet is considered good practice. Fig. 159 shows how the slope of furrows may be controlled on side-hill land by planting the rows of a vineyard in somewhat curved lines approximately parallel to the contour lines.

297. Method of Conveying and Delivering Water. — In the mountain states, water is brought to many orchards in ordinary earth ditches, and distributed to the furrows through cuts in earth ditch banks. This method is inexpensive in first preparation but requires much labor in irrigation and is usually wasteful of water. Some irrigators use wooden flumes, as shown in Fig. 152; others use concrete flumes, as shown in



FIG. 159. — Contour irrigation of a vineyard, University Farm, Davis. (Courtesy: Division of Irrigation Investigations and Practice, University of California.)



FIG. 160. — Concrete head-flume in hillside orchard near Porterville, Tulare County, California. (Calif. Agr. Exp. Sta. Bul. 253.)

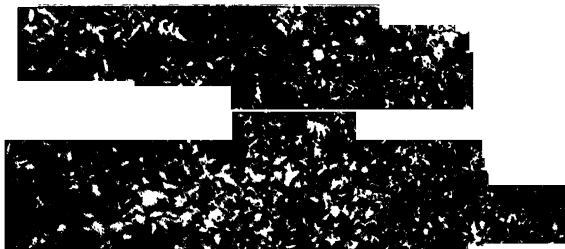

FIG. 161. — Delivery of water from concrete stand pipes. (Calif. Agr. Exp. Sta. Bul. 253.)

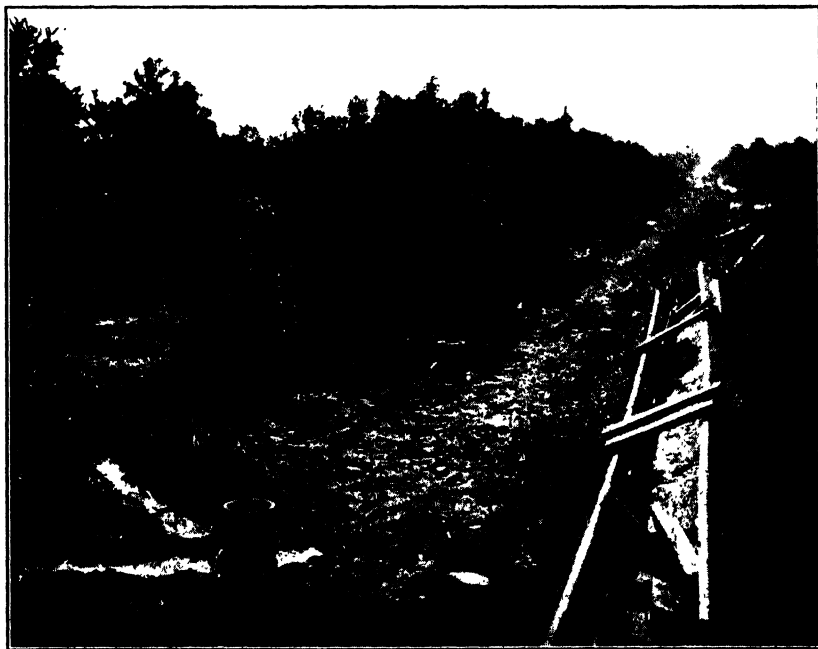

FIG. 162. — Discarded lumber head-flume replaced by concrete pipe and stand system. (U. S. Dept. Agr. Farmers' Bul. 882.)

Fig. 160. In the more important orchard-growing districts wooden and concrete flumes are being largely replaced by underground pipe distribution systems as shown in Figs. 161 and 162. Substantial savings both in labor and in water are effected by using underground concrete pipe. Fig. 163 illustrates the design of concrete pipe. On the reader's right, the 16-inch diameter pressure well permits the irrigator to insert the iron cut-off gate, thus causing the water to rise in the stand pipe on the left, flow through the open valve, and out of the stand pipe through the four 2-inch openings. The small galvanized-iron gates at the entrance to the 2-inch outlet pipes permit convenient regulation of the stream flowing into each furrow. Some irrigators permit the water

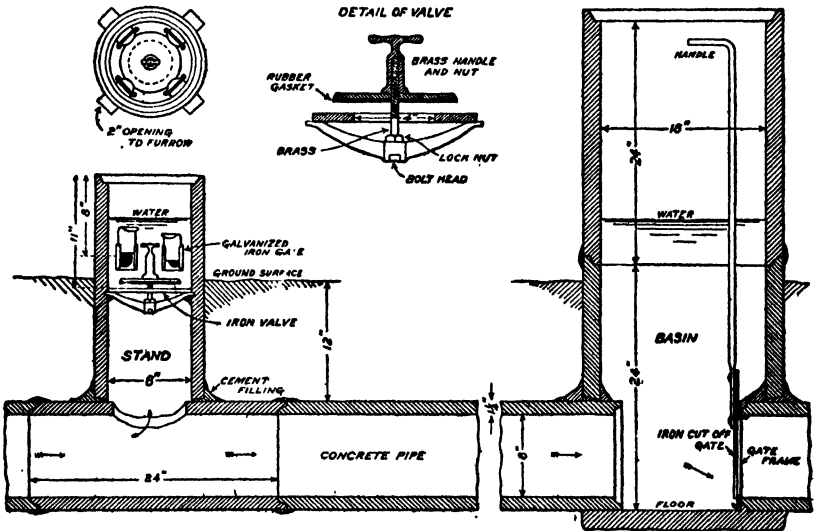

Fig. 163. — Design for concrete pipe and stand system for orchard irrigation. (U. S. Dept. Agr. Farmers' Bul. 882.)

to flow from the 2-inch galvanized-iron pipes directly into the furrows, as illustrated in Fig. 162. Others use small, galvanized-iron troughs to convey the water from the stand pipe to the furrows as illustrated in Fig. 164, which represents practice in a walnut orchard in California. Fig. 165 shows a row of the stand pipes in the California walnut orchard after the irrigation has been completed, and the soil has been cultivated after irrigation. The six galvanized-iron troughs in the foreground of Fig. 165 show the position of these troughs during irrigation. All the other troughs are placed on each stand pipe in such manner as to permit cultivation close to the row of stand pipes.



FIG. 164. — Irrigation of a walnut orchard in California, by the furrow method. Water is conveyed through an underground pipe and delivered from the vertical concrete pipe to small metal flumes. (Photo by Author.)

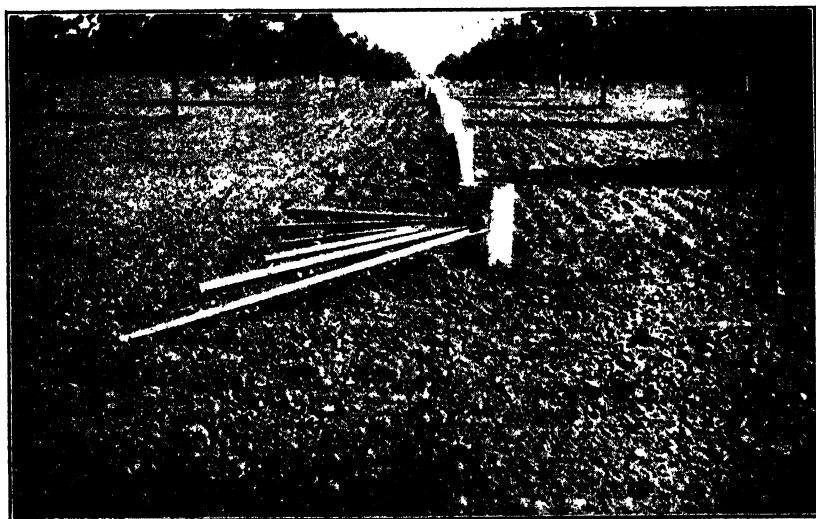

FIG. 165. — California walnut orchard after irrigation and cultivation. The 6 metal flumes in the foreground represent the position during irrigation. Others represent position between irrigations. (Photo by Author.)



FIG. 166. — Making furrows in an orchard. (U. S. Dept. Agr. Farmers' Bul. 882.)



FIG. 167. — "Checking back" to avoid waste in irrigation, North Pomona, California. (U. S. Dept. Agr. Office File.)

298. Making the Furrows. — Shallow furrows can be made by use of one of the corrugation implements described in Chapter VI. However, except in very coarse-textured soils, shallow furrows or corrugations are not well suited to the needs of orchards. Shovel plows of medium size in process of furrow making are illustrated in Fig. 166. Larger plows and deeper furrows than the ones here illustrated are suited to orchards on very compact, fine-textured soils of low permeability to water. The making of comparatively deep furrows is also advantageous where it is necessary to “check the water back” as illustrated in Fig. 167 in order to avoid waste at the lower ends of the furrows. Spacing between furrows can be varied to some extent by adjusting the position of the plows. The disadvantages of deep furrowing are stated in Article 295.

299. Basin Method. — The basin method, as the name implies, consists of building levees midway between each tree row in both directions

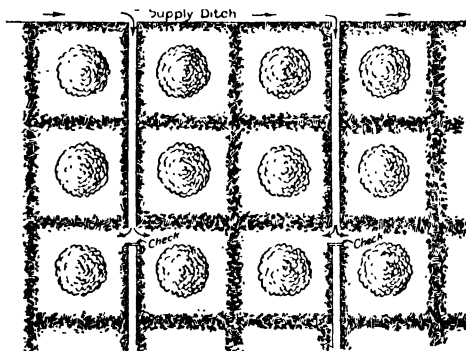

Fig. 168. — Basin method of irrigation. (U. S. Dept. Agr. Farmers' Bul. 404.)

so as to form a basin around each tree. A ditch is built in alternate levees, as illustrated in Fig. 168, in which to convey water to each pair of adjoining basins. Fig. 169 illustrates the basin method during the time of applying irrigation water to an apricot orchard in the Santa Clara Valley, California. Although the levees or ridges are made by power-drawn implements, considerable hand work is required to close up gaps at the intersections of the levees. Also in applying water to the basins a large amount of hand shovel work is required to open and close the ditch banks. For most soils the basin method is probably less preferable than the furrow method. Moreover, many of the orchards in the mountain states produce alfalfa, clover, and other crops between the trees, which makes the use of the basin method undesirable. In some localities the basin method is extensively used even on comparatively level lands having soils of fairly uniform texture. A modified form of



FIG. 169. — Basin method of irrigation of apricots, Santa Clara Valley. (Courtesy: Division of Irrigation Investigations and Practice, University of California.)



FIG. 170. — The modified basin method of contour irrigation. (Calif. Ext. Service Circular 16.)

the basin method is now used in contour irrigation of side-hill land, as indicated in Fig. 170.

300. Time to Irrigate Orchards. — The proper time to irrigate the different fruit trees is a mooted question but nevertheless a question of great importance. Some authorities assert that fruit color, size, and yield are influenced by the time of irrigation and likewise that the growth rate of trees is similarly so influenced. A unique feature in the study of the proper time of irrigation of orchards is that most trees extract some water from the soil continuously during summer and winter. Lands on which grains, sugar beets, and potatoes are grown are sometimes irrigated during the late fall, after the harvest, or early spring, almost wholly for the purpose of storing water that otherwise would go to waste. In very dry climates, irrigation before seeding or planting *annual crops* is essential to satisfactory germination. However, dormant-season irrigation of orchards may be essential to protection of the trees, and of equal importance, dormant-season irrigation also is practiced for the purpose of storing water in the soil to avoid its being lost. Thus the problems connected with the proper time of irrigation naturally fall into two classes — those pertaining to irrigation during the growing season and those which concern irrigation during the dormant season. These problems are somewhat interdependent because irrigation practice during the growing season usually influences the needs during the dormant season, and conversely, the irrigation practices during the dormant season may influence the needs during the growing season.

301. Irrigation During the Growing Season. — Trees should have moisture readily available at all times during the growing season. In localities of comparatively heavy summer rainfall, caution should be exercised to avoid excessive moisture in the heavy compact soils on which orchard fruits are grown. On the coarse-textured, porous, sandy and gravelly soils in which ground water occurs only at great depths, there is but little if any danger of excessive moisture from ordinary irrigation practice. However, the coarse-textured soils have very small water-holding capacity, and hence frequent irrigations, especially during mid-season and later, are urgently necessary to maintain readily available water for the use of the trees.

Experimenting on the irrigation of Elberta peaches in gravelly loam soil near Brigham City, Utah, in 1913 and 1914, Batchelor found that very large amounts of water applied during June and July with no later irrigations completely failed to produce marketable fruit. On the other hand, moderate amounts applied in 8 irrigations from the middle of July to the middle of September produced very satisfactory yields of fruit.

Taylor and Downing, in experiments in the irrigation of apple orchards on fine sandy loam and sandy soils in Idaho, also found that the trees used larger quantities of water during mid-season and later than early in the season, and hence that irrigation during late July, August, and early September are of vital importance to satisfactory yields.

Recent outstanding investigations of orchard irrigation by the University of California, Division of Irrigation Investigations and Practice, seem to warrant the general statements that irrigation of orchards during the growing season should be based primarily on soil-moisture conditions. It was found that the so-called optimum soil-moisture percentage is in

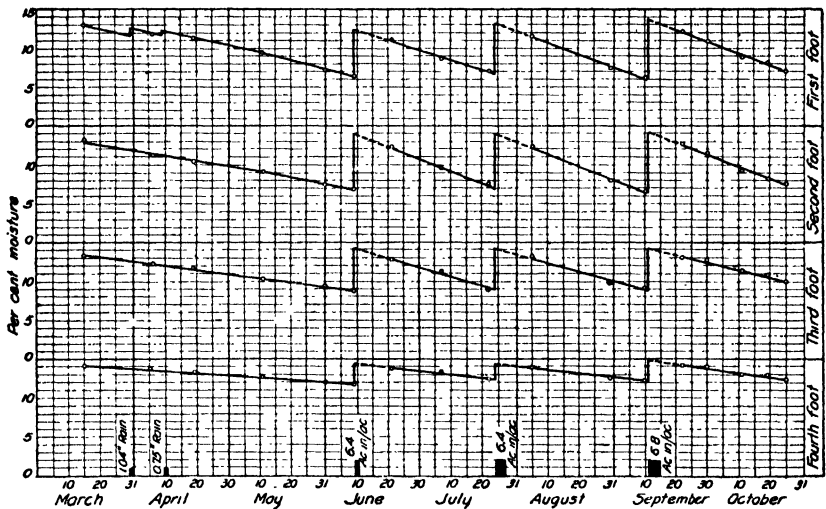

FIG. 171. — Seasonal variation in moisture content, Wilkins plot, 1927. (Calif. Agr. Exp. Sta. Bul. 489.)

reality a zone of moisture content ranging from an amount slightly above the point of permanent wilting to an amount equal to the capillary field capacity. In other words, the growth rate of trees and of fruit, so far as influenced by the moisture conditions, was found to be substantially constant regardless of change in moisture content so long as there was an adequate supply of readily available moisture. The number of irrigations per season and their frequency is therefore determined by the conditions that influence the maintenance of readily available moisture. To illustrate, Beckett, Blaney, and Taylor found that a crop of lemons consumed 14.7 acre-inches per acre from April 1 to October 31. During May the trees used less than 1.4 inches as compared to more than 2.5 inches during each of the months July, August, and September. The

necessary amount of irrigation water was supplied in 3 irrigations; two 6.4-inch applications and one 6.8-inch application as recorded in Fig. 171. The data of Fig. 171 show remarkable uniformity in the rate of use of soil moisture between irrigations. The fact that straight-line curves so nearly fit all the measured moisture percentages shows that the rate of use when the moisture percentage was approaching the lowest limit reached was substantially the same as shortly after irrigation when it was near the capillary field capacity. Based on the experimental observations reported in Fig. 171 and on many similar ones, Beckett, Blaney, and Taylor conclude that "As long as the soil moisture is above the wilting point, the moisture content has no measurable effect on the rate of moisture extraction; that is, moisture is as readily available when the moisture content is one-third or two-thirds of the way between field capacity and the wilting point as it is in the thoroughly moistened soil after irrigation."

After very thorough studies of the irrigation of peaches in the San Joaquin Valley, California, Hendrickson and Veihmeyer conclude as follows:

"The addition of irrigation water during the dormant season to Muir peach trees at Delhi produced no increase, either in growth of trees or in yield of fruit.

"Winter irrigation of Muir peach trees at Delhi did not postpone the date when the first spring irrigation was necessary.

"Maintenance of soil moisture continuously above the permanent wilting percentage at Delhi resulted in production of the largest trees.

"Deficiency of readily available moisture for comparatively brief periods resulted in a decrease in growth of the trees at Delhi, but not a significant decrease in yield.

"Deficiency of readily available moisture for long periods during the growing season markedly reduced the yields of Muir peaches.

"The rates of growth of peaches were not affected until the soil moisture was reduced to about the permanent wilting percentage.

"Application of water to the soil just prior to picking did not result in rapid increase in size of the fruit.

"The peaches from plots deficient in readily available moisture in general, contained a slightly higher percentage of sugar and a lower percentage of water than the fruit from the continuously moist plots, when calculated on a fresh weight basis. Results in 1928 indicated that if sugar determinations were calculated on a dry weight basis, these results would be reversed.

"Irrigation just before picking did not increase the water content of the fruit above that not irrigated in this way.

"A deficiency of readily available soil moisture during the pit-hardening period seriously affects the subsequent size of the fruit.

"Extreme differences in soil moisture content did not affect the drying ratio of Muir peaches when dried commercially.

" No differences in the keeping quality between the peaches from the wet plots and those from the dry plots were observed during the usual interval between picking and canning.

" No evidence of winter injury to peach trees following fall irrigation was obtained.

" Under conditions similar to those existing in the various experimental plots reported in this paper, a safe interval between irrigations during the hottest part of the summer would be three weeks at Delhi, three to four weeks in Stanislaus County, and five to six weeks in Sutter County.*

" The data presented in this paper show that the permanent wilting percentage is a critical soil-moisture content, and lead to the conclusion that trees either have readily available moisture or have not."

The present status of research on orchard irrigation during the growing season, briefly summarized, supports the statement made at the outset, namely, that for trees, soil moisture should be readily available

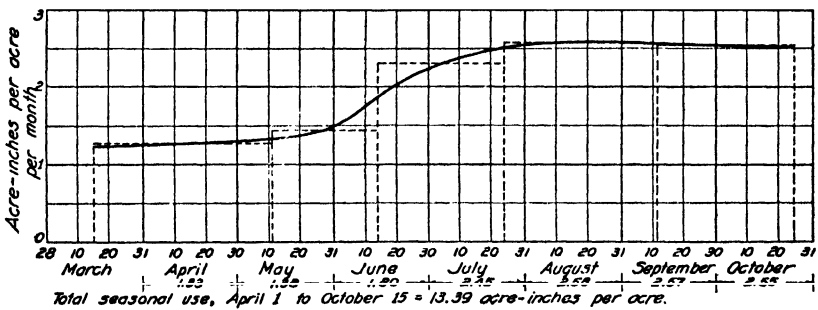

FIG. 172. — Seasonal use of water in acre-inches per acre per month, Wilkins plot, 1927. (Calif. Agr. Exp. Sta. Bul. 489.)

continuously. The necessary frequency of irrigation to maintain readily available moisture at all times depends on the water-storage capacity of the orchard soils, the amount of water actually stored at each irrigation, and the rate of use by the orchards. To assure the trees readily available moisture, water should be applied before the wilting point is reached. Fig. 172 shows an appreciable increase in rate of use by lemons from June 1 to late in July, as measured by Beckett and others, and that during August, September, and October the rate of use was approximately 2.5 inches per month. To supply this rate of use only 3 irrigations were needed, one June 10, one July 25, and one September 11.

302. Dormant-Season Irrigation. — That water may be saved and waste prevented by storing it in orchard soils by means of dormant-

* The soils at Delhi are of a light, sandy character; those in Sutter County usually heavier.

season irrigation in some localities is well established. Where orchard soils are irrigated for the purpose of storing, and thus saving, water, great care should be exercised to avoid over-irrigation and consequent excessive losses of water and of readily soluble plant-food nutrients through deep percolation. Information heretofore presented in this volume concerning the capacities of soils to absorb and retain irrigation water, and the relation of these capacities to the size of irrigation stream used and the hours the stream is applied to 1 acre of land, will guide the orchard irrigator in avoiding excessive application of water during dormant seasons. Usually the fact that water is rather abundant during the dormant season encourages carelessness in its application to the soil.

Dormant-season irrigation is probably not without danger. In orchard areas having very cold winters, caution should be exercised to apply water to orchards only after the trees are fully dormant. Otherwise, dormant-season irrigation may cause late growth which would lead to forms of winter injury associated with immaturity. This need to assure dormancy of the trees before late fall irrigation is considered especially important with vigorous, growing young trees.

Taylor and Downing working in Idaho found that orchard soils lost approximately 2 per cent of moisture during the dormant season despite 5 inches of precipitation. The soils that contained the largest amounts of moisture in the fall in general lost the larger amounts of soil moisture during the dormant season.

Based on the actual water needs of trees and cover crop, rather than the practice of irrigating during the dormant season to save water, Beckett, Blaney, and Taylor found that dormant-season irrigation in southern California during years of low precipitation is really necessary. At Escondido in a period of 25 years there were 6 years in which 2 winter irrigations were needed, 8 years in which 1 irrigation was needed, and 11 years in which no winter irrigation was necessary. Similar needs were found for the Fallbrook area in an analysis of a 45-year climatic record.

There is danger in permitting trees to go into the dormant season with a very low moisture supply in the soil. After a study of winter injury in Utah peach orchards, Abell reached the following conclusion:

“Lack of adequate irrigation in an orchard was apparently the single most important, predisposing factor for death of trees. In a young peach orchard which received no irrigation in 1924, most of the trees died. . . . An irrigated orchard across the road recovered.

“An orchard of peach and apricot trees on sandy soil received insufficient irrigation during the summer of 1924. Trees at the lower ends

of the rows received no irrigation after July 25. The upper part of the orchard was irrigated twice after that date. The trees which were inadequately irrigated did not recover, whereas those which received the later irrigations recovered fairly well; only an occasional tree and branch wilted the following summer."

303. Irrigation Water Requirements. — When grown without intercropping, and when kept free from weeds, orchards require less irrigation water than alfalfa, under the same climatic and soil conditions. The differences between the amounts of water needed for the small grains and for orchard trees in the inter-mountain states are relatively small, but the orchards as a rule require late-season irrigation, whereas the grains may be matured by early-season irrigation. The result is that grains and orchards "compete" for water only during a short time near the middle of the crop-growing season, or in other words, the orchards may be irrigated largely after the grains are matured. On the other hand, sugar beets and potatoes require water at about the same time as it is needed by orchards. Under the same climatic and soil conditions, beets and potatoes probably need slightly larger amounts of irrigation water than orchards do.

304. Apples. — Lewis, Kraus, and Rees in 1912 reported extensive experiments on the irrigation water requirements of orchards in the Rogue River Valley, Oregon, where the mean annual precipitation is approximately 29 inches. During the growing season, June 1 to September 30, the average rainfall is 2.6 inches. These investigators found that the irrigation water requirements for apples range from 1000 to 3500 gallons per tree per season, depending on the type of soil. The usual spacing of trees being 25 by 25 feet makes 1000 gallons per tree equivalent to 2.56 acre-inches per acre; hence 3500 gallons per tree is equivalent to nearly 9 acre-inches per acre. The consumptive use of water by the trees was not determined.

Taylor and Downing found large amounts of irrigation water required for Jonathan and Winesap apple orchards in the Snake River Valley, Idaho, but the requirements were increased by the growth of a cover crop of clover. On a fine sandy loam soil near Twin Falls 28.5 acre-inches per acre, which maintained an average moisture content of 19 per cent, resulted in the maximum yield and in the highest percentage of extra fancy and fancy fruit. On a sandy soil of 2 to 3 feet in depth underlain by a sand of great depth near Payette, Idaho, these investigators found approximately 3 feet in depth annually to give the largest fruit yields. The Payette soil also produced a cover crop of clover.

305. Peaches. — In a study of the irrigation needs of Elberta peaches on the gravelly loam soils near Brigham City, Utah, during the year

1913, Batchelor found that 10 inches of water was insufficient to produce a satisfactory crop. Twenty-four inches of irrigation water produced over 50 per cent more marketable fruit than was produced with 10 inches. Substantially the same amount of marketable fruit was produced by 47 inches of irrigation water as by 24 inches. The crop-season rainfall during 1913 was over 3 inches, which is more than 4 times the normal crop-season rainfall.

The 4 experimental plots that were given an average of 10 inches of water in 1913 were given 12 inches in 1914. One of the plots was irrigated 4 times, one 6 times, one 7 times, and one 8 times. None of the plots that received only 12 inches of irrigation water produced any marketable fruit in 1913. Plots that were given 31 inches of water produced almost as large yields of marketable fruit as those which were given 62 inches.

The gravelly nature of the soils on which Batchelor conducted the experiments on the irrigation of peaches precluded the possibility of the use of a soil auger, and hence the consumptive use of water by the peach trees was not determined. It was noted, however, that small irrigations frequently applied in nearly every case gave better results than the same seasonal depth of water applied less frequently in larger amounts at each irrigation. It is therefore probable, although definite proof is lacking, that the soils sustained comparatively heavy deep percolation losses, and hence that the amounts of water consumptively used was appreciably less than the amounts applied to the plots.

306. Citrus Groves. — From extensive experiments conducted in 1926 and 1927, Beckett, Blaney, and Taylor conclude that citrus groves in northern San Diego County, California, including cover crops, require from 8 to 12 inches of water during the winter season. As pointed out in Article 302, the winter needs of these crops are satisfied by the rainfall during years of normal precipitation.

The net seasonal summer irrigation requirements of mature citrus groves, according to these investigators, range from 15 to 18 inches, provided the water application efficiency is approximately 60 per cent. For trees 6 to 8 years old having 40 per cent to 50 per cent of their probable ultimate size, 6 to 8 inches of irrigation water are considered sufficient. Sandy loam soils predominated, in the San Diego County experiments, there being but one farm of 9 acres on which the soil is classed as a loam. The moisture equivalent of the sandy loam soils ranges from 10.5 to 15.1 per cent by dry weight. The moisture equivalent of the loam soil is 18.0 per cent.

REFERENCES

- ABELL, T. H. Some Observations on Winter Injury in Utah Peach Orchards, Utah Agr. Exp. Sta. Bul. 202. 1927.
- BATCHELOR, L. D. Irrigation of Peaches. Utah Agr. Exp. Sta. Bul. 142. 1916.
- BALLANTYNE, A. B. Fruit Variety Tests on the Southern Utah Experiment Farm, Utah Agr. Exp. Sta. Bul. 124. 1913.
- BECKETT, S. H., BLANEY, HARRY F., and TAYLOR, COLIN A. Irrigation Water Requirement Studies of Citrus and Avocado Trees in San Diego County, California, 1926 and 1927, Bul. 489, California Agr. Exp. Sta. April, 1930.
- FORTIER, SAMUEL. Irrigation of Orchards, U. S. D. A. Farmers' Bul. 882.
- HENDRICKSON, A. H., and VEIHMEYER, F. J. Irrigation Experiments with Peaches in California, II. Canning Quality of Irrigated Peaches, by P. F. Nichols, Bul. 479, California Exp. Sta. November, 1929.
- HUBERTY, M. R., and BROWN, J. B. Irrigation of Orchards by Contour Furrows, Circular 16, California Agr. Ext. Service. April, 1928.
- LEWIS, C. I., KRAUS, E. J., and REES, R. W. Orchard Irrigation Studies in the Rogue River Valley, Oregon Agr. Exp. Sta. Bul. 113. 1912.
- ROBERTSON, RALPH D., and NELSON, J. W. Irrigation and Soil Conditions in the Sierra Nevada Foothills, California, California Agr. Exp. Sta. Bul. 253. May, 1915.
- TAYLOR, E. P., and DOWNING, C. J. Experiments in the Irrigation of Apple Orchards, University of Idaho Agr. Exp. Sta. Bul. 99. May, 1917.
- THOMAS, EDWARD E. Studies on the Irrigation of Citrus Groves, California Agr. Exp. Sta. Bul. 341. March, 1922.
- VEIHMEYER, F. J., and HENDRICKSON, A. H. Essentials of Irrigation and Cultivation of Orchards, California Agr. Ext. Service Circ. 50. 1930.

CHAPTER XXIII

IRRIGATION IN HUMID CLIMATES

Irrigation is fundamentally a practice of artificially supplementing the natural precipitation. The percentage of the cultivated land of the United States on which irrigation is *essential* to crop production is very small. However, even under humid climates where crops are ordinarily grown without irrigation, the rainfall does not come regularly enough from season to season, and from week to week during the season, to assure the most profitable crop yields. The soils of humid regions, generally speaking, are rather shallow and, therefore, capable of storing relatively small amounts of water for the use of plants. When long periods occur between rains, crop growth in humid regions is retarded. In order to avoid the losses due to decreased crop yields from occasional drought, and also to assure continuous and rapid growth of valuable truck and orchard crops, humid-climate farmers are becoming more and more interested in irrigation.

307. Irrigation Supplementary to Rainfall. — The ultimate source of water for all natural vegetation on the earth is the precipitation in the form of rain and snow. Yet, because of the great variability in precipitation from place to place, vast areas of the earth's surface are almost wholly sterile from lack of water. Other areas produce vegetation only during the wet seasons and lie sterile for weeks and months each year when plants could grow if water were available. Still other areas produce crop growth continuously during warm weather in years when the rainfall is high, and lie sterile and barren for many days in years of low precipitation. And so irrigation is an artificial means of providing the soil moisture essential to the production of plant growth in places and at times of deficient rainfall. The extent of irrigation essential thus to supplement the rainfall is clearly dependent on natural variations. For example, in San Diego County, California, as pointed out in Chapter XXII, 2 winter irrigations were needed for citrus groves including cover crops during 6 years out of 25. In parts of Utah, winter irrigation of orchards is never essential, but summer irrigation is always needed; and in parts of Oregon, orchards on heavy soils in some seasons will not benefit from irrigation. In reality, therefore, the boundary between arid and humid climates as related to irrigation needs is decidedly indistinct. It is doubtless true that, in many countries of the world in

which farmers ordinarily depend wholly on natural precipitation, as a source of water in crop production, yields could be increased, in many places during some years, by supplementing the available soil moisture with irrigation water. There can be no general rule as to the economic advisability of this practice of supplementing the available moisture through irrigation.

308. Deficiencies in Rainfall. — It has been truly said that one of the most interesting things in nature is its variation — its changes from time to time and place to place. There is no uniformity in nature, and so with the rainfall; it is continuously changing from year to year and month to month. These changes are of vital concern to agriculture, in both the East and the West. The average numbers of rainless periods of duration of 1 or more weeks during the crop-growing season in 7 mid-western humid-climate states are shown in Table XXXIV,* which shows for example that in Michigan during the 10-year period 1917 to 1926 there were on the average 7 periods each year from 1 to 2 weeks in duration in which there was no rainfall. In Iowa there were 8 such periods; in Wisconsin, Minnesota, Illinois, and Indiana, 6; and in Ohio, 5. A rainless period of 2 to 3 weeks' duration occurred on the average twice each year in Minnesota and once in each of the other states. Rainless periods of 3 weeks or more are comparatively rare.

Similar data compiled by Williams and presented also by Widtsoe show that in the 10-year period 1899 to 1909 there were many more times when for 15 days or longer the rainfall was 1 inch or less. At Ames, Iowa, there were 23 such periods; at Oshkosh, Wisconsin, 27; at Vineland, New Jersey, 46; at Columbia, South Carolina, 62; and at Selina, Alabama, 60. Considering that after a 15-day period of rainfall of only 1 inch or less irrigation was really necessary, Widtsoe indicates that during the 10-year period the number of days when irrigation was required ranged from 190 at Ames, Iowa, to 724 at Selina, Alabama.

309. Does Irrigation Pay? — Farmers in southern California, Arizona, New Mexico, and southern Utah seldom if ever ask the question, "Does irrigation pay?" They do, however, properly study the promise of profits in the growing of the different crops, but since in these places most crops must be irrigated in order to produce, or even to live, the question "Does irrigation pay?" has no significance with them.

Many Montana farmers seriously doubt that it pays to irrigate be-

* The author gratefully acknowledges his indebtedness to Professor H. B. Roe for the use of the data of Table XXXIV which have not heretofore been published.

After the above acknowledgment was written, the data of Table XXXIV were presented in an unpublished report by the Committee on Irrigation of the Am. Soc. Agr. Engineers.

TABLE XXXIV

AVERAGE NUMBER, TO THE NEAREST UNIT, OF RAINLESS PERIODS OF DURATION OF ONE OR MORE WEEKS FOR MIDWESTERN STATES FOR TEN-YEAR PERIOD

Data prepared by H. B. Roe

State	Duration, Weeks	1917	1918	1919	1920	1921	1922	1923	1924	1925	1926	Av.
Michigan	1-2	5	7	4	10	3	9	9	6	7	10	7
	2-3	2	2	1	1	2	1	1	1	0	1	1
	3+	0	0	0	0	0	0	0	0	0	0	0
Wisconsin	1-2	2	6	4	8	7	10	8	6	4	8	6
	2-3	2	2	1	1	0	0	1	0	2	1	1
	3-4	0	0	0	0	0	0	0	0	0	1	0
	4+	0	0	0	0	0	0	0	0	1	0	0
Minnesota	1-2	4	5	5	8	5	6	5	3	7	9	6
	2-3	2	1	1	1	1	2	3	1	2	1	2
	3+	0	0	0	0	0	0	0	0	0	0	0
Iowa	1-2	7	6	4	9	7	12	8	7	8	12	8
	2-3	1	2	1	0	0	0	1	1	2	1	1
	3+	0	0	0	0	0	0	0	0	0	0	0
Illinois	1-2	6	7	3	5	3	8	6	5	7	5	6
	2-3	0	1	1	1	1	0	0	0	1	1	1
	3-4	0	0	0	1	0	1	0	1	0	1	0
	4+	0	0	0	0	0	0	0	0	0	0	0
Indiana	1-2	8	5	2	7	4	7	9	6	6	6	6
	2-3	1	3	1	0	1	0	0	1	0	2	1
	3-4	0	0	0	0	0	1	0	0	0	0	0
	4+	0	0	0	0	0	0	0	0	0	0	0
Ohio	1-2	5	6	5	4	5	6	7	5	6	5	5
	2-3	1	0	0	1	0	1	1	0	0	1	1
	3-4	0	0	0	0	0	0	0	0	0	0	0
	4+	0	0	0	0	0	0	0	1	0	0	0
Average of 7 states	1-2	5	6	4	7	5	8	7	5	6	8	6
	2-3	1	2	1	1	0	1	1	1	1	1	1
	3+	0	0	0	0	0	0	0	0	0	0	0

The stations considered in preparing the above table are as follows: Michigan — Ludington, Saginaw, and Kalamazoo; Wisconsin — Spooner, Wausau, and Madison; Minnesota — Bemidji, Duluth, Minneapolis, and Albert Lea; Iowa — Charles City, Ames, and Clariton; Illinois — Kankakee, Springfield, and Cairo; Indiana — Ft. Wayne, Indianapolis and Vincennes; and Ohio — Akron, Columbus, and Cincinnati.

cause they can produce reasonably good yields of crops during some years without irrigation, and consequently farms under large irrigation systems that could be supplied with water are operated without irrigation. Similar examples may be cited for many other arid-region localities where some crops may be grown without irrigation and in which the economic advisability of irrigation is not clearly and fully established. That farmers in humid climates can assure themselves large and dependable crop yields, in so far as influenced by readily available soil moisture, by providing irrigation systems and dependable, adequate water supplies is now well established. But the fact just stated does not prove that the farmers' profits will thus be increased — they may or they may not be. Consequently the humid-climate farmer is fundamentally concerned with the question, "Does irrigation pay?"

310. Crops Irrigated in Humid Climates. — In general, irrigation in humid climates thus far is most widely practiced for the growing of small-fruit and truck crops, which bring high returns per acre and which therefore justify relatively high investments for irrigation systems. These crops as a rule are given some irrigation water every year after the irrigation systems are once prepared. Strawberries especially respond well to irrigation during the fruiting season.

Next in importance from the viewpoint of gross acre returns come the orchards of humid regions. Orchard soils may not need irrigation every year as the small-fruit and truck farms do, but the decreases in yields during relatively dry years in some humid-climate states fully justify the investments necessary to provide irrigation systems. In Virginia, for example, where the average annual precipitation is 41.6 inches, or $3\frac{1}{2}$ inches per month for the 30-year period, 1900 to 1929, there were 10 years in which the average monthly precipitation in July, August, and September was only 2 inches per month. According to Professor Charles E. Seitz, Virginia orchards need for maximum production approximately 6 inches per month during these important months.

311. Results of Experiments on Irrigation. — During a period of one-third of a century a number of experiments have been conducted in different humid-climate areas in the United States, and elsewhere, concerning the influence of irrigation on crop yields.

In New Jersey, blackberries, raspberries, currants, gooseberries, and other small fruits have been found to respond very well to irrigation during seasons of low and irregular rainfall. Also in Connecticut, strawberries were early found to produce larger yields when supplied with irrigation water. Similar results were obtained by King in Wisconsin in a study of irrigation of potatoes, cabbage, corn, clover, strawberries, and some small grains. Early irrigation experiments in South

Dakota gave marked increases in yields of several crops. In the Hawaiian Islands, under an annual rainfall of nearly 50 inches, irrigation of sugar cane has been found to increase the yield.

From irrigation experiments in Michigan by the overhead spray method Loree found that the yield of onions was increased 233 per cent, beets 86, carrots 66, lettuce 60, and early cabbage approximately 100 per cent. It was also apparent from these experiments that the quality of crops was improved, and that more intensive cropping was possible with less cultivation than was required without irrigation.

312. Extent of Irrigation in Eastern States. — It is estimated by a committee of the American Society of Agricultural Engineers that in the 7 mid-western states listed in Table XXXIV there are now (1931) approximately 6000 acres receiving supplemental irrigation. The same authorities also estimate that supplemental irrigation might profitably be provided for an additional 145,000 acres in these 7 states for the purpose of carrying various special crops through rainless periods at critical times, such as periods of maximum growth and periods of maturing of crops; and also as a means of insurance against untimely frosts. Estimates have also been made for the following 8 states as a group: Delaware, Pennsylvania, New York, Maryland, New Jersey, Connecticut, Massachusetts, and Rhode Island. It is believed that an area of approximately 5000 acres now receive irrigation in these states and that an additional area of more than 10,000 acres would be benefited by irrigation. Other humid-climate areas in which supplemental irrigation is now practiced to some extent and in which it will probably be increased are eastern Nebraska, Kansas, Oklahoma, and Texas, parts of Montana and Idaho, and western Washington, Oregon, and northwestern California.

313. Sources of Water for Irrigation. — In the humid regions of the United States, irrigation water is obtained largely from four sources, namely: (a) underground water supplies; (b) streams, rivers, ponds, and lakes; (c) city water systems; and (d) city sewage systems. Farm pumping plants are used to obtain water from wells and also to a large extent to obtain water from ponds and lakes. Excluding the relatively small amount of water obtained from sewage systems, it is estimated for the mid-western states that about 60 per cent of the irrigation water is obtained from surface supplies. In humid regions large water-storage reservoirs are built to supply the culinary and industrial water needs of great cities, but there are no such reservoirs for irrigation purposes; nor are there any great irrigation diversion weirs or canals.

314. Methods of Irrigation in the Eastern States. — Several methods of applying irrigation water to soils are described in Chapter V. In the

humid regions of the United States the spray method is used to a considerable extent. For small fruits, such as strawberries, and for truck crops which bring large financial returns per acre, the spray method is quite satisfactory. However, the cost of spray irrigation for orchards or field crops, particularly those that are grown in rows and that can be easily irrigated by the furrow method, may be so great as to be unprofitable, whereas the costs of furrow irrigation may be fully justified by the increase in, and insurance of, crop yields. Fig. 173 illustrates the furrow method of irrigation which was used in some experimental work



FIG. 173. — Experimental irrigation plots at Iowa Agricultural Experiment Station. (Courtesy: Ia. Agri. Exp. Sta.)

on the Iowa State College Farm conducted under the direction of Professor Davidson. In irrigating asparagus, for example, the furrow method is extensively used. The flooding method is rarely used except for special crops such as rice. It is probable that the furrow and flooding methods will be extended as they are better understood. For peat soils such as occur in certain areas near the Great Lakes, the sub-irrigation method is likely to be used to advantage.

315. Amounts of Water Needed. — The amount of irrigation water needed in humid regions for any given crop depends more on the frequency of rains and the monthly depth of rainfall during the crop-growing season than it does on the annual rainfall. The amount of

irrigation water needed in humid regions therefore varies from season to season according to the crop-season rainfall. Humid-climate soils are relatively of less depth than arid-climate soils, and hence, in soils of the same texture and structure, in humid regions, smaller amounts of water are stored in the form of soil moisture from the dormant-season rainfall for use during the growing season. And likewise the amount of water that may be stored in the soil from a heavy rain during the crop season in humid regions is less than the amount that may be stored in the deeper soils of the arid regions from a single irrigation. Remembering that in arid-region soils the approximate average increase in moisture content from a single irrigation is 6 per cent of the weight of the dry soil, and that, if the irrigated soil is appreciably moist before irrigation, the increase in P_w is much less than 6 per cent, it is possible to estimate the depth of penetration of moisture from a light spray irrigation. For example, if the moisture content is increased 4 per cent by a 0.5-inch spray irrigation, it follows from equation (42) that the depth of soil moistened is 9.6 inches provided the apparent specific gravity (A_s) of the soil is 1.3. It is therefore apparent that, when it is desired to moisten only a few inches of soil, a fraction of an inch depth of water will suffice. Mitchell and Staebner advise that a spray irrigation system should be large enough and the water supply adequate to deliver at least 1 inch depth of water per week. According to Williams, depths not exceeding $\frac{1}{4}$ inch per application are considered sufficient for moistening seed beds and for young vegetables. For strawberries and young orchards $\frac{1}{2}$ to 1 inch per irrigation is considered ample. For the seasonal needs, Williams believes that truckers in humid regions do not use more than 6 inches and that in many seasons 4 inches will adequately supplement the rainfall.

It is important to note that the above estimates are made in connection with the spray method of distribution, which permits the application of smaller depths of water per irrigation than the other methods. On many western lands it is very difficult to apply less than 1.5 to 2.0 inches in a single irrigation by either the furrow or the flooding method.

As a result of a rather extensive study of the water needs for orchards in Virginia (yet unpublished), Professor Seitz has found many orchardists who have amply demonstrated the financial attractiveness of irrigation of orchards. Some of the better Virginia orchards in the lighter soils need as much as 3 to 4 inches per month during July to September, the months of maximum water needs. In general, the amounts of water needed in humid regions are much less than in arid regions.

316. The Use of Sewage Water. — In the older civilized countries the use of sewage water in irrigation is becoming increasingly important.

Not only does this use make it possible to cultivate some lands that otherwise would lie idle, but also it furthers the saving for society of large quantities of valuable plant-food substances.

Widtsoe called attention to the fact that sewage water has been used in many countries for generations past with very satisfactory results. The feeling entertained by some persons that the use of sewage water for irrigation is likely to endanger the health of those who use the products of lands that are so irrigated seems to have no basis of fact. For many decades the products of sewage farms have been used by man.

317. The Future of Humid-Region Irrigation. — Irrigation in humid regions is likely to expand as its possibilities and advantages are more widely understood. The methods of spray irrigation seem to be more attractive to eastern farmers than the methods of surface application by flooding and by running the water in furrows, methods widely used in the arid-region states. However, the spray methods are relatively expensive, and their high costs may tend to retard or prevent irrigation expansion in humid regions under some soil and crop conditions that are well suited to the less expensive surface irrigation methods. Staebner has shown that the surface methods of furrow irrigation and of flooding which are so extensively used in the West may be adapted to eastern conditions without difficulty. It is probable that a wider dissemination of information as to the feasibility and the methods of irrigation on humid-climate farms by the ordinary surface methods will lead to gradual expansion of irrigation in humid regions.

In any event, efficient methods of irrigation in humid regions are essential to the attainment of economical results. Especially where irrigation water is obtained by pumping against high lifts the farmer cannot afford to lose large amounts of water either by surface run-off or by deep percolation. The former losses are easily detected by inspection — the latter can be detected only by a study of the depths of soil that need moistening and the amounts of water that may be retained in the soil from a single irrigation, and by regulating the depths of water applied in each irrigation accordingly. The spray methods enable the irrigator to apply water efficiently. For the irrigation of crops that yield high returns per acre, such as truck and berry crops, the spray methods of irrigation also will be more widely used as the advantages of irrigation are better understood. It is sometimes advantageous to provide water for furrow irrigation of part of a farm and for spray irrigation of other parts by installing only one pumping plant. A typical plan prepared by Williams for an 80-acre farm is presented in Fig. 174, suggesting that spray irrigation be provided for the intensive truck plats and the strawberries, whereas the general truck crops, bush berries, and orchard be

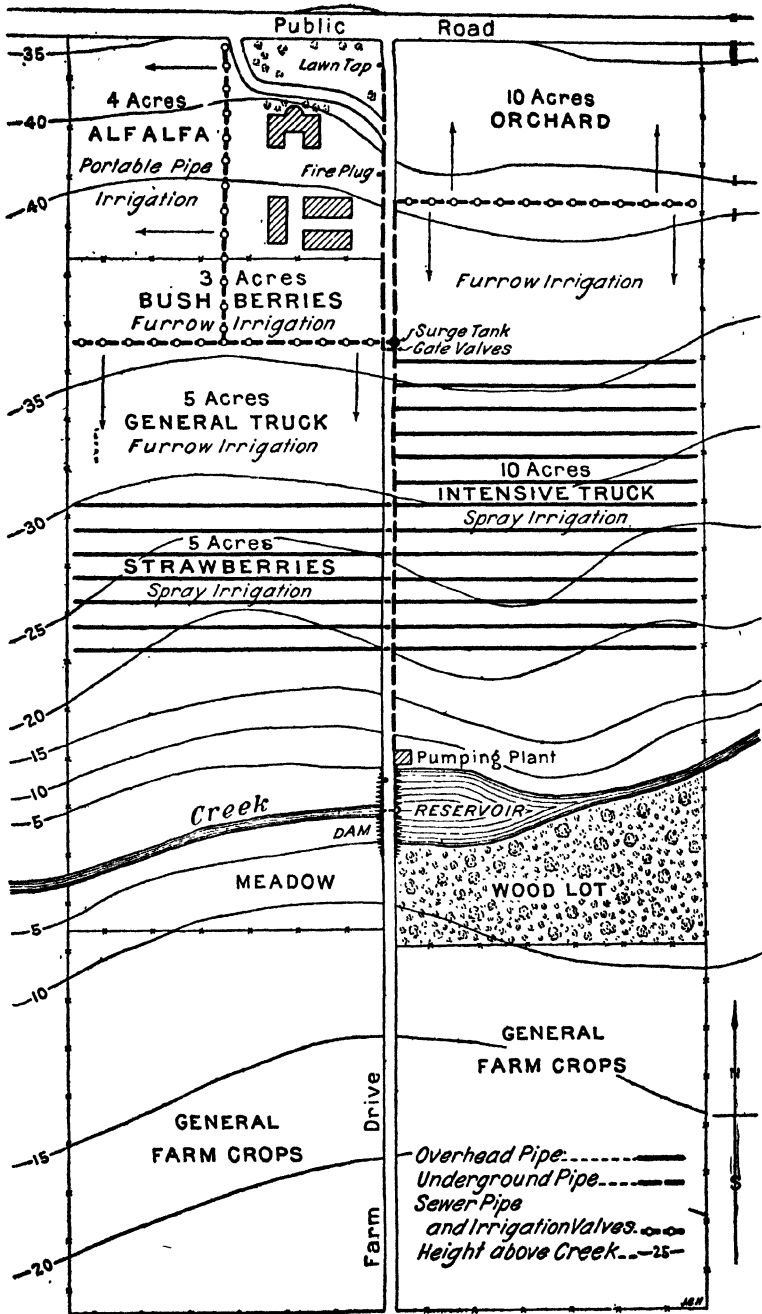

FIG. 174. — Typical 80-acre farm in humid regions, showing development of water supply by reservoir and a combination of spray and surface methods of irrigation and from one pumping plant (U. S. Dept. Agr. Bul. 495.) (387)

irrigated with the furrow method. The typical humid-farm irrigation plan presented in Fig. 174 properly provides different methods of irrigation for different purposes. The expansion of humid-climate irrigation under plants especially adapted to the crop needs, the soil and topographic conditions, and the sources and cost of available water will tend to encourage irrigation as a means of avoiding the uncertainties and the losses due to long periods of drought.

REFERENCES

- DAVIDSON, J. B. Summary of Six Years' Experimentation in Sewage Irrigation, Iowa Agr. Exp. Sta. (Unpublished Report.)
- KAY, A. O. Brief Discussion of Subsurface, Surface, and Overhead Irrigation in Florida, Univ. Exp. Bul. 24, pp. 45-48. 1920.
- LEWIS, M. R., *et al.* Areas Needing Supplemental Irrigation and the Benefits to be Expected Therefrom, Rept. Com. on Irrig. Am. Soc. Agr. Eng. 1931. (Unpublished.)
- LOREE, R. E. Mich. State Quarterly, Bul. 4, pp. 55-56. 1921.
- SEITZ, CHAS. E. Outlook for Irrigation in Virginia Orchards. 1930. (Unpublished MSS supplied by its author.)
- STAEBNER, F. E. Surface Irrigation in the Eastern States, U. S. D. A. Farmers' Bul. 1635. 1930.
- See also References to Chapter V.

CHAPTER XXIV

THE PROBLEMS OF IRRIGATION

The problems of irrigation briefly sketched in this chapter include particularly those which concern groups of society and which must be solved by group action. These problems are therefore of a public or quasi-public nature. The economic welfare of the 11 western states rests in part on the maintenance and perpetuation of high productivity in their irrigated lands. Also, as population increases, the public welfare is influenced by the completeness and the economy with which the water supplies of the West are used. Obviously, some water is needed for culinary and industrial uses in cities — the amount so needed increases with the growth and industrial development of western cities. The growing use of electricity for lighting, heating, and industrial purposes gives the public a genuine interest in the building of more water-power electric plants, and these may, if properly located, advance irrigation expansion; or they may, if located at points low on the streams, greatly retard or permanently prevent the use of the water for irrigation.

Interest in irrigation farming is growing in many countries. Old irrigation projects are being improved and new projects are being contemplated in the Americas, Africa, Australia, Asia, European countries, and in India. It therefore seems fitting that the student of irrigation, after having given thought to its principles and practices, make a reconnaissance of its problems and its possibilities. To some extent, at least, the public problems of irrigation are common to all irrigated countries.

318. Classes of Irrigated Land. — There is great variability in the several classes of irrigated land with respect to irrigation needs. Western arable lands may be grouped into three classes based on the status of irrigation, namely: (1) lands that are fully supplied with irrigation water nearly every year, regardless of minor fluctuations in precipitation and in stream flow; (2) lands that are only partially supplied with water for irrigation during years of average precipitation and that sustain serious water shortages during years of low precipitation; and (3) lands that yet lie idle awaiting the availability of irrigation water, and also lands that are still being used for dry-farming purposes at relatively small profits.

319. Lands Fully Irrigated. — In Utah, Colorado, California, and other western states, where the pioneer irrigation settlers first practiced irrigation, the best lands naturally were settled and irrigated first, provided they were conveniently accessible to the streams from which water could easily be diverted. Reservoirs were not built by the pioneer irrigators. They had only their labor together with primitive tools and equipment with which to construct diversion dams, canals, and ditches, and they accomplished these tasks well, sometimes under great hardships and physical privations. They had no capital with which to build the modern structures essential to the complete control and utilization of the waters of any one river system. Furthermore, their numbers were few, and they did not early need all the water of a stream system as it is now needed in the more populous sections of the West. Clearly, therefore, they obtained only the natural stream flow for their water supply. The pioneer irrigators in many of the western states early established prior rights to the use of the natural late-season stream flows — rights which are highly respected and fully protected under the doctrine of priority of appropriation and beneficial use. The basic requisite for perpetuity of these early-established water rights is continuity of use of the water for beneficial irrigation purposes. The Utah public has such high regard for the water rights thus established by the pioneers that permission is granted by law to transfer water rights to different lands in case the lands first irrigated are needed for purposes other than agriculture (that is, for residence or industrial purposes), or in case the early lands for any reason become unfitted for continued cultivation under irrigation.

Some irrigated lands have become partially non-productive from excessive irrigation, seepage from higher land, rise of the water table, concentration of alkali salts, and other less obvious causes. Still other irrigated lands have become wholly non-productive for the same reasons, in spite of the fact that modern irrigation in America is yet less than a century old. Some writers have interpreted these facts as convincing evidence that agriculture based on irrigation is destined to disintegration, decline, and ultimate decay and abandonment. These writers, in order to support their contentions, cite some cases of antiquity where great civilizations fed by the products of irrigated farms have gradually declined and finally disappeared.

However, many irrigation authorities in western America and elsewhere believe that agriculture under intelligent irrigation practice is fundamentally sound and that it may be made permanent. The conditions of perpetuation of soil fertility under irrigation in some respects are common to the conditions essential to permanence of soil fertility

in humid climates — in other respects they are unique to irrigation practice. The conditions, both in humid climates and in arid regions, which, in common, are essential to permanence of soil fertility are fully explained by agronomists and soil scientists — they include especially intelligent crop rotation, maintenance of favorable soil tilth, and reasonable additions of fertilizers, either mineral or organic or both.

One of the problems of irrigation of first importance on the early-settled irrigated lands, which enjoy full water rights under early priorities of appropriation, is the maintenance and perpetuation of soil productivity. This problem will of course ultimately apply to all irrigated lands, but it is now of special importance to the lands that have been irrigated longest and which have full water rights.

In addition to the conditions essential to the maintenance of soil productivity under humid-climate farming, the conditions of permanence which are particularly applicable to agriculture under irrigation include also moderate irrigation, based on knowledge of soil and water relations and soil and plant relations, uniform distribution of water on the land to avoid excess water losses by deep percolation and also to avoid leaching of plant food substances and assurance of adequate drainage of the water which is unavoidably lost. Drainage may be provided either by natural or by artificial means.

Where these conditions of soil fertility are maintained, and accompanied by the enjoyment of a dependable right to an adequate quantity of water, controlled, and conveyed to the farm at the request of its owner, irrigation farming is really attractive. In this connection Dr. Elwood Mead, Commissioner of Reclamation, is quoted as having recently said; "It is a privilege to live on an irrigated farm."

320. Lands Partially Irrigated. — Men who work toward the perpetuation and advancement of irrigation in the West are vitally concerned with the provision of additional supplies of water for lands now inadequately supplied, and hence only partially irrigated. The paramount need for construction of irrigation storage works in some of the states of the West is to supply late-season water for lands that now have sufficient water only during the months of April, May, and part of June while stream discharges are high, owing to the melting of mountain snows. In many western valleys the lands that are only partially irrigated lie around the valley rims near the mountains and above the lands that are fully supplied with water. Therefore these lands, being the highest that are irrigated, receive no water by seepage from other lands. It is moreover rather a general rule that the higher lands have relatively coarse-textured soils of shallow depth. In some cases they are also comparatively irregular in topography and consequently

difficult to irrigate uniformly. It is a commonly accepted belief, justified by practical experience, that these lands require relatively large amounts of water for irrigation. In all probability their consumptive use water needs are but little if any greater than those of lower, fully irrigated lands, but the water application efficiency is undoubtedly lower. The result is that substantial amounts of water from the higher, partially irrigated lands, either by surface or underground flow, reach the lower, fully irrigated lands through unmeasured channels. In some cases these additions are welcomed by the lower canals and land owners — they increase the effective water supplies and make complete irrigation easier. In other cases when the amounts of seepage water are excessive they prove harmful to the lower lands and make artificial drainage necessary.

Irrigation communities are therefore confronted not only with the problem of building large storage reservoirs to hold back the flood waters for late-season supplemental supplies to lands now partially irrigated, but also with the problem of attaining the highest practical efficiency in the application of these supplemental water supplies in order to protect the high lands from excessive leaching and the low lands from excessive seepage water.

Owners of the lower, fully irrigated lands sometimes oppose the efforts of the owners of the higher, partially irrigated lands to supplement their late-season water supplies, on the grounds that any increase in water for the higher lands is sure to cause excessive seepage to the lower land with resultant water-logging of the soil. Owners of high lands who desire to supplement their water supplies point out the fact that late-season water shortages cause many irrigators to apply excessive amounts of water to their farms in the early season, with the hope of lessening the crop losses due to late-season inadequate supplies. They argue further that water losses from the higher lands by deep percolation are greater from a few excessive irrigations early during the season than from a larger number of irrigations of moderate amounts applied when needed throughout the season. Reconciliation of these diverse viewpoints and interests is one of the problems the solution of which is essential to complete irrigation of appreciably large areas of land now only partially supplied with water.

321. Lands Not Yet Irrigated. — The area of land that will ultimately be irrigated in the western United States is not yet precisely determined. It is variously estimated from 30 million up to 50 million acres. It is probably not extravagant to assume roughly that the present (1931) area will ultimately be doubled. How many generations will pass before all the West's potential water supply is controlled and used in irrigation is almost wholly a matter of conjecture. It is certain, how-

ever, that, as the national population continues to increase, the need for complete utilization of the water supplies of the West for irrigation, power, and domestic purposes also will increase. In the process of irrigation advancement, large and costly dams have already been built. Great reservoirs have been formed by the building of dams, and canals of tremendous length have been constructed. But the future will probably bring still larger, more expensive, and, indeed, more magnificent irrigation structures.

If it were possible to spread all the water annually yielded by all the streams of the West uniformly over all the arable land that needs irrigation, then the problem of complete utilization of the water would be easily solved. But this is certainly economically prohibitive if not physically impossible. For example, the waters of the Sevier River in central Utah are now fully used in irrigation. A decade has passed since the Sevier River reservoirs were all so completely filled that it was necessary to allow any water to go to waste into Sevier Lake. Yet there are extensive areas of arable land within easy reach of the Sevier River that probably will never be irrigated because the river water supply is inadequate. Logan River and its tributaries annually discharge a large volume of unused water into the Bear River, most of which goes into Great Salt Lake, but it is impracticable to use this surplus Logan River water to relieve the water shortages on the Sevier River lands because of the prohibitive cost of constructing a reservoir in which to store the Logan River flood water and a canal more than 200 miles in length to convey the water to the Sevier River lands.

The Sevier River is typical of many other western rivers, the total annual water yield of which is too small to permit the irrigation of all the arable lands to which canals may be economically constructed. The Bear River, like the Snake and the Columbia Rivers, is typical of those that yield more water each year than will be required for irrigation for a very long time.

322. Further Water Supplies. — In order to obtain the additional water supplies needed for supplemental irrigation of lands now partially irrigated, and also to complete irrigation of lands not yet irrigated, hundreds, if not thousands, of additional storage reservoirs must yet be constructed. Intricate engineering problems concerning the suitability of reservoir sites, the safety of foundations for dams, and the strength, durability, and economy of dams must be solved before the necessary reservoirs are made available.

The problem of determining the total annual water yield of river systems and the amount of the water that already is properly claimed for irrigation, power, culinary, and other purposes, requires years of

painstaking study by competent engineers. River yields vary widely from year to year. Those who appropriate the flood discharges to fill storage reservoirs assume great responsibility in estimating the amounts of water that may be stored. The more nearly the total river yield is appropriated and used beneficially, the greater the risk to the new builder of storage works who must of necessity depend on the water yield of the highest discharges, or in the engineer's language, the "peak of the hydrograph." Yet these risks are inevitable to the final and complete utilization of the water supplies of arid regions.

Further water supplies may be obtained by using subsurface gravel formations or ground-water basins as storage reservoirs. The use of such reservoirs as yet is only well begun compared to the possibilities. However, in parts of California the use of subsurface reservoirs is highly developed. It is estimated that as much as 80 per cent of the total water supply in certain sections of southern California is pumped from ground-water storage basins. Very large amounts of water are also pumped from the ground-water supplies of the Salt River Valley, Arizona, thus supplementing the water supplied by the surface reservoirs and also lowering the elevation of the water table and hence affording drainage of lands formerly water-logged. There is a common misconception among some farmers that the water supplies of underground reservoirs are unlimited and hence inexhaustible. The measurements of capacities of underground reservoirs is indeed more difficult than similar measurements of surface reservoirs. However, the really important consideration is to determine the safe annual water yield of such reservoirs that may be pumped out of them without excessively high lifts.

The determination of potential, as well as perfected, rights to the waters of underground reservoirs is a legal problem of real complexity that must be solved before complete utilization of such reservoirs can be made to increase irrigation water supplies.

323. Trans-Watershed Diversions. — An interesting means of increasing irrigation water supplies in localities of scarcity is the construction of tunnels through mountains in order to permit the diversion of water from one watershed to another. Already large amounts of water that originate in one watershed are conveyed through tunnels to other watersheds in which the need for irrigation water is greater. For example, the Bureau of Reclamation Gunnison Tunnel in western Colorado conveys nearly 1000 c.f.s. from the Gunnison River to the Uncompahgre River and delivers annually approximately $\frac{1}{4}$ million acre-feet of water for irrigation purposes. The tunnel is nearly 6 miles long and is more than 2000 feet below the summit of the mountain separating the two streams. In Utah the Strawberry Tunnel also built by the Bureau of

Reclamation conveys water from the Colorado River watershed into the Spanish Fork River, which runs into the more arid Great Basin area. This tunnel is 3.6 miles long and brings to the Provo area approximately 85,000 acre-feet of water annually. Other trans-watershed diversions have been made, some are now under contemplation, and still more must be made to utilize completely all the water supplies of the West.

324. Water Exchanges. — In some localities it is economically feasible to store flood waters for irrigation needs in naturally favorable reservoir sites closely adjacent to irrigated lands, at elevations below the partially irrigated and unirrigated lands, but above the fully irrigated lands. Reservoir sites in the mountains above the lands that need supplemental or complete water supplies, though available, are restricted in capacity, and the building of dams is economically prohibitive. In order to solve the problem of complete utilization of available flood waters in cases of this kind, it is essential, and indeed advantageous, to divert the natural flows of the mountain streams, which formerly supplied the low lands, at higher elevations and convey them to the higher lands. The needs of the low lands which enjoy full water rights may then be supplied by diversions from the storage reservoirs. Such a practice obviously requires water exchanges. The owners of the prior water rights for the low-lying lands must be fully protected in their rights, and adequately assured that the stored flood waters delivered to them will equal in amount the direct stream diversions to which they would be entitled under all conditions of stream flow. That such water exchanges are feasible and satisfactory when fully understood is well demonstrated by successful exchanges made on many western projects, notably by those in the State of Colorado east of the Rocky Mountains in the Fort Collins-Greeley area. That water exchanges are basically essential to the complete utilization of water resources in irrigation is recognized by many irrigation authorities. Authorization of water exchanges by the owners of prior rights to water for fully irrigated lands requires assurance of continuous and reliable deliveries of water from proposed new water sources, whether surface or underground reservoirs, with the reservation of authority again to receive the waters from the original source in case the new source fails to deliver water at any time. In addition to these legal assurances of continuity of enjoyment of early water rights, the owners of such rights must clearly see the necessity of water exchanges as a means of completely using all the water supply and of thus providing the greatest good to the greatest number.

325. Irrigation and Hydroelectric Power. — Already on many river systems great dams serve the combined purpose of storing water for irrigation, and equalizing the natural stream flow for generating hydro-

electric power. The advancement of American civilization is in no small measure due to its having removed much of the physical drudgery of human labor by using energy from natural sources such as coal, oil, and waterfalls to do the work of man. It is highly desirable that the rivers of the West should be made to generate power by construction of large hydroelectric plants wherever economically feasible, provided these power plants are located high enough on the river systems to permit the later use of the water for irrigation purposes. One of the perplexing problems that will confront the people who have the responsibility of completing the utilization of all the water supply of the various western rivers for irrigation will be acquiring water rights which have become vested for purposes of power generation at points on the rivers so low that the water cannot be diverted for irrigation purposes after it has gone through the hydraulic turbines to generate power.

It is therefore essential to the complete utilization of the West's water supply in irrigation that the granting of water rights by the public for purposes of power generation either be restricted to points high enough on the streams to permit diversion and use of the water for irrigation after it has left the power plants, or that at some future time the power rights at low points on the streams be purchased in order to make irrigation possible.

326. Irrigation and City Water Supplies. — The water yields of western watersheds are needed not only for irrigation and generation of power, but also to supply the culinary and industrial demands of rapidly growing western cities. Already vigorous and long-continued conflicts have occurred between some of the larger western cities and land owners who consider their irrigation water rights infringed by the cities gradually but positively reaching out to different water sources to increase their water supplies for growing populations. It is almost a self-evident truth that a city cannot grow beyond its capacity to supply adequately and dependably the water needs of its inhabitants. However, as these city water needs increase, it is usually possible for the city concerned to pay relatively high prices for the water it needs, and consequently the city is a successful water competitor with the irrigated farm. This does not mean that the growing city confiscates the farmer's water right — it does mean, however, that waters that have been used for many years for irrigation are taken by the cities and the irrigation needs of the farms are supplied from other sources which furnish water not suited to culinary uses, or that the irrigated lands are purchased by the cities in cases where adequate substitution of water supplies cannot be provided. The future of irrigation is therefore closely related in many localities to the increasing water needs of western cities.

327. Coordinated Uses of Water. — The prosperity of arid regions is intimately connected with the economy and completeness of use of their water resources. It is therefore desirable to coordinate irrigation, power, and city water supply uses so far as possible. One of the most interesting and also the most difficult problems confronting irrigation engineers and other persons interested in the use of the waters of western streams is to coordinate the several uses to the best advantage of all the people concerned. It is good practice to study in detail, long before complete use of the waters of a stream system is needed, the possibilities of coordinating the several uses of water so as to reduce to a minimum the actual wastes of water and of potential power. Comprehensive studies of some of the larger stream systems have already been made. The river systems thus far studied include the Columbia, the Rio Grande, the Humboldt, the Platte, the Sacramento-San Joaquin, and the Colorado Rivers. It is not the purpose of this chapter fully to describe the nature of coordination studies, but merely to call attention to the fact that complete utilization of water demands coordination, and that investigations of power, irrigation, and domestic uses and possible future needs of the waters of many of the smaller streams are also quite essential to ultimate economy in the use of all the water of these streams.

A large part of the water used in irrigation, if conservatively applied to the land, is consumed in transpiration and evaporation. The use of water in irrigation thus differs fundamentally from use for power generation, culinary, and other purposes in which very little, if any, water is consumed.

328. The Unfinished Task. — To complete the task of irrigation advancement it is necessary to store, control, and convey all the available water supplies of the West to arable lands and there to use these water supplies efficiently in the production of crops under irrigation. The unfinished irrigation task is a monumental one. To complete it will require not only more, and probably larger, dams, canals, diversion weirs, tunnels, spillways, siphons, drops and chutes, than have yet been built, but also clear vision on the part of many men — great leaders are needed to guide the completion of the task. Many conflicting interests must be satisfied, vested rights must be protected, public interests must precede private gains, physical and social forces of large magnitude must be fully understood and effectively controlled and utilized.

And, finally, a complete understanding of the interrelations of soils and water and of plants and soil moisture, and of the influence of these relations on irrigation practice, is essential to the reduction of water losses, to the prevention of waste of water and of plant food, and to the perpetuation of a permanently profitable agriculture based on irrigation.

The task of designing and building the large irrigation structures essential to store, divert, and convey the waters to arable lands is primarily that of the civil engineer, whereas the problems of bettering the practices of applying water to the irrigated soils in order economically to attain high efficiencies in its use is fundamentally the responsibility of the agricultural engineer. However, the problems of irrigation in an arid region are not to be solved by engineers alone — they require also the wisdom of great statesmen, legislators, attorneys, economists, sociologists, and learned men in the several branches of agricultural science. That successful irrigation advancement demands a high type of cooperative effort was forcefully stated by Dr. Widtsoe as follows:

“ The nature of irrigation is such as to bring into close social relationship the people living under the same canal. A common interest binds them together. If the canal breaks or water is misused, the danger is for all. In the distribution of the water in the hot summer months when the flow is small and the need great, the neighbor and his rights loom large, and men must gird themselves with the golden rule. The intensive culture, which must prevail under irrigation, makes possible close settlements, often with the village as a center. Out of the desert, as the canals are dug, will come great results of successful experiments in intimate rural life; and out of the communities reared under irrigation will come men who, confident that it is best, can unflinchingly consider their neighbors' interests with their own; and who, therefore, can assume leadership in the advancing of a civilization based upon order and equal rights.”*

* From “Principles of Irrigation Practice,” Widtsoe. By permission of The Macmillan Company, publishers.

APPENDIX

PROBLEMS AND QUESTIONS

CHAPTER II

1. Consider a farm irrigation ditch in a loam soil having the following dimensions:
- (a) Bottom width, 2.00 ft.
 - (b) Total depth, 1.75 ft.
 - (c) Side slopes of 1 horizontal to 1 vertical.
 - (d) Depth of water 1.00 ft.

Find the following properties:

- (a) Cross-section area of stream. *Ans.:* (a) 3.0 sq. ft.
- (b) Wetted perimeter. (b) 4.82 ft.
- (c) Hydraulic radius of stream. (c) 0.62 ft.

2. If the bottom of the ditch described in problem 1 has a uniform slope of 5.28 ft. per mile (1 ft. in 1000 ft.), and if the bottom and sides are kept smooth and free from weeds, what will be the mean velocity of flow and the discharge? *Hint:* Use $n = 0.02$.

$$\begin{aligned} \text{Ans.: } v &= 1.7 \text{ ft. per sec.} \\ q &= 5.1 \text{ c.f.s.} \end{aligned}$$

3. If the canal described in problem 1 were permitted to grow weeds on the sides and bottom, what would be the velocity and discharge? *Hint:* Use $n = 0.04$.

$$\begin{aligned} \text{Ans.: } v &= 0.85 \text{ ft. per sec.} \\ q &= 2.55 \text{ c.f.s.} \end{aligned}$$

4. For a canal of the same dimensions built in earth on a slope of 10.56 ft. per mile (2.00 ft. per 1000 ft.), determine the velocity and discharge.

$$\begin{aligned} \text{Ans.: } v &= 2.41. \\ q &= 7.23. \end{aligned}$$

5. How do you account for the fact that the velocity and the discharge are not doubled when the slope is doubled?

6. For a concrete-lined ditch in good condition having the same dimensions and slope as the ditch in problem 4, determine the velocity and the discharge. *Hint:* Use $n = 0.014$.

$$\begin{aligned} \text{Ans.: } v &= 3.45 \text{ ft. per sec.} \\ q &= 10.35 \text{ c.f.s.} \end{aligned}$$

7. If the concrete-lined ditch were built shallow and wide so that its hydraulic radius were only 0.3 ft., what would be its velocity and discharge?

$$\begin{aligned} \text{Ans.: } v &= 2.13 \text{ ft. per sec.} \\ q &= 6.39 \text{ c.f.s.} \end{aligned}$$

8. If the water were conveyed through a good 2-ft. diameter wood stave pipe running full, and if the vertical drop in the water surface were 5.28 ft. in the $\frac{1}{2}$ mile, what would be the velocity and the discharge? Neglect losses at entrance and outlet.

$$\begin{aligned} \text{Ans.: } v &= 3.80 \text{ ft. per sec.} \\ q &= 11.92 \text{ c.f.s.} \end{aligned}$$

9. Is gravity a balanced force?

10. Can a balanced force do work?

11. Define: (a) turbulent flow; (b) stream-line flow; (c) critical velocity.

12. Using equations (11) and (12), show that a square covered box flowing 0.95 full carries more water than the same box flowing full. Explain.
13. Given a canal with 1 : 1 side slopes and cross-section area of 112 sq. ft. Find the most economical dimensions. *Ans.: $b = 6.48$ ft. $d = 7.32$ ft.*

CHAPTER III

1. (a) Find the theoretical velocity in feet per second of a jet of water flowing out of a square orifice in a large tank if the center of the orifice is 2 ft. below the water surface.
- (b) If the orifice opening considered in problem 1(a) is $\frac{1}{2}$ ft. by $\frac{1}{2}$ ft., what is the theoretical discharge in c.f.s.?
- (c) What are the probable maximum and the probable minimum actual discharges in c.f.s.? *Ans.: (a) $v = 11.33$; (b) $q = 2.84$ c.f.s.; (c) $q = 2.27, 1.7$ c.f.s.*
2. (a) In measuring the water that flows through a submerged orifice, is it necessary to know the vertical distance from the upstream water surface to the center of the orifice? Explain.
- (b) Find the discharge in c.f.s. through a rectangular standard submerged orifice 18 in. long (horizontal dimension) by 8 in. deep (vertical dimension) if the upstream surface is 7 in. vertically above the downstream water surface. *Hint: All dimensions must be converted to feet. First use the appropriate equation and check your result by use of a table.*
3. (a) In using weirs with which to measure water is it essential to make direct measurement of the velocity of the water as it flows through the weir notch? Explain.
- (b) By using the appropriate equation compute the c.f.s. over a rectangular weir having suppressed end contractions if the weir crest is 24 in. long and the water surface at a point 8 ft. upstream from the weir is $5\frac{1}{2}$ in. vertically above the weir crest. Check your result by use of a weir table.
- (c) If the weir described in problem 3(b) has complete end contractions, would the discharge be more or less than your computed result? How much?
4. For the same length of weir crest and depth of water over crest as in problem 3(b) compute the discharge over a trapezoidal weir. Check your result with a table.
5. For a right-angle triangular notch weir, what is the discharge when the depth of water vertically above the apex of the weir notch is 0.6 ft. at a point 5 ft. upstream from the weir?
6. Show that doubling the effective head causing discharge through a submerged orifice increases the discharge approximately 41 per cent.
7. Show that doubling the head over a rectangular or a trapezoidal weir makes the discharge 2.8 times greater.
8. Show that doubling the head over a triangular notch weir increases the discharge by 5.66 times. Does the percentage increase in discharge caused by doubling the head vary as the size of the notch increases from 60° to 100° ? Explain.
9. State the basic discharge equation that is used in connection with current meter measurements. Explain briefly the rating curve.
10. Give briefly the conditions that should be provided to make a satisfactory division of an irrigation stream into different unequal parts:
- (a) When the stream carries sand and fine gravel and is not measured.
- (b) When the water is clear and is measured over a weir.
11. Describe an end contraction; a bottom contraction.
12. Why should the water move slowly as it approaches a weir or an orifice?

13. (a) In what terms is potential energy of water per unit mass expressed in the c.g.s. system of units? (b) in the f. lb. s. system?

14. Why do the cups on a current meter revolve when placed in a stream?

15. Compute the head for which the discharge over a 1-ft. rectangular weir having complete end contractions is the same as that for a 90° triangular notch.

Ans.: 1.054.

16. Compute the pressure in pounds per square inch necessary to cause a flow of 1 Utah miner's inch through a 1 sq. in. opening. Assume a coefficient of discharge.

Ans.: 0.156 lb. (approximately).

CHAPTER IV

1. An irrigator desires to lift a stream of 500 g.p.m. a vertical height of 40 ft. If he purchases an electric motor of 91 per cent efficiency and a pump of 62 per cent efficiency, how many kilowatts of electricity will his electric motor use while pumping? How many horse power? *Ans.*: (a) KW = 6.68; (b) HP = 8.96.

2. With the same height of lift and the same efficiencies as given in problem 1, how many kilowatts would a motor require in order to deliver a stream that would supply enough water in 30 hours to cover a 10-acre tract to a depth of 6 in.?

Ans.: KW = 12.1; HP = 16.25.

3. A common net water requirement for orchard irrigation is approximately 1½ acre-feet per acre. If a pumping plant (motor and pump) operates at an efficiency of 57 per cent, how many kilowatt hours energy will be required to lift water 30 ft. for each acre? *Ans.*: 81 KW.H.

4. A typical irrigation contract for electric power provides for charges as follows:

(a) Demand charge of \$2.00 per month per horse power of motor capacity, which includes 30 KWH per motor HP.

(b) Energy charges: 50 KWH per motor H.P. at 6¢; 250 KWH per motor H.P. at 4¢; 750 KWH per motor H.P. at 2¢; balance of month use at 1¢.

If a farmer uses a 10-HP motor, compute the monthly charge and the total kilowatt hours energy consumed under each of the following conditions:

(a) Five 12-hour days' operation.

(b) Ten 24-hour days' operation.

(c) Twenty 24-hour days' operation.

(d) Continuous operation.

5. In problem 4 compute the cost per kilowatt hour under each of the 4 conditions of pump operation: *Ans.*: (a) 6¢; (b) 2.93¢; (c) 1.97¢; (d) 1.64¢.

6. Under the conditions of fuel consumption outlined in Article 62 give your first, second, and third choice of fuel as based only on cost at the following unit prices: gasoline 10¢ per gallon; crude oil \$1.40 per barrel; coal \$4.00 a ton; and electricity 1.5¢ per KW. *Ans.*: 1. Electricity. 2. Gasoline. 3. Coal. 4. Crude oil.

7. Would it be advisable to use the centrifugal pump whose characteristics are shown in Fig. 34 where it is desired that 1600 g.p.m. be pumped against a head of 42 ft.? What is the efficiency? Why is a high efficiency desirable? What horse power would be used?

CHAPTER V

1. A fruit grower is entitled to a stream of 80 Utah miner's inches for orchard irrigation. How many hours will it take him to apply 5 acre-inches per acre to an 8-acre orchard?

2. A pump owned by H has a capacity of 1100 gal. per minute. If he spends 40 hours in irrigating a 10-acre field of alfalfa when the pump is discharging 75 per cent of its capacity, how many acre-inches per acre does he apply?

3. In case you desired to apply $\frac{1}{2}$ acre-foot per acre to a 45-acre alfalfa field in a period of 30 hours, what quantity of flow would you need? Give answer in (1) second-feet, (2) Utah miner's inches, (3) gallons per minute.

4. How many acres can be irrigated to a depth of 8 in. with a stream of 1350 gal. per min. in a period of 19 hours?

5. In order to apply an irrigation of 9.5 acre-inches per acre per 24-hour day to a 60-acre rice field, what depth in feet would you require: (a) over a trapezoidal weir having a crest of 2 ft. in length, and (b) over a rectangular weir having the same length of crest?

6. How many hours will be required to apply 4 acre-inches per acre to a 25-acre potato tract using a stream received through a standard submerged orifice which is 18 in. in length, 8 in. wide, and has a coefficient of discharge of 0.61, and an effective depth of water (h) of $\frac{3}{4}$ ft. causing the discharge?

7. How long will it take for a 3.5 c.f.s. stream to furnish 6 acre-inches per acre net to a 20-acre field if 10 per cent of the total is lost as surface run-off? What is the average size of the run-off stream, if it is running half the time?

8. Consider an alfalfa tract prepared for irrigation by the border-strip method. Assume that the soil is a loam having a permeability to water of 2 ft. per 24-hour day (i.e., if 1 acre were covered with water for 24 hours it would absorb 2 acre-feet). The border strips have a mean width of 66 feet (4 rods) and a length of 660 feet. If the irrigator turns a stream of 0.5 c.f.s. into each strip, how far will the water advance before it is all absorbed by the soil? *Hint:* 160 sq. rods = 1 acre. *Ans.:* 20 rods.

9. If a stream of 1.5 c.f.s. be applied to a border strip $16\frac{1}{2}$ ft. wide (1 rod), how many hours will be required for the water to reach each of the following distances from the head of the strip: 660, 1320, 1980, and 2640 ft.? Make necessary assumptions. Plot the curve showing time as ordinate and area as the abscissa.

Ans.: .55 hrs.; 1.22 hrs.; 2.08 hrs.; 3.3 hrs.

10. In problem 9 compute the average depth of water applied to the border strip during the time the water reaches each distance given.

Ans.: $d = 3.28$ in.; 3.65 in.; 4.16 in.; 5.1 in.

11. What are the essential points of difference between the border and check methods of irrigation?

12. What is a contour? Contour interval? How would you determine the slope of land from a contour map? Illustrate with an example.

13. Upon what physical principle does equation (29) depend?

14. How would you make a field determination of y and p to be used in equation (31)?

15. How would you explain the fact that when $q = pA$; in equation (31), the time becomes infinite?

CHAPTER VI

1. (a) If the head producing flow through a submerged take-out is 0.68 ft. and it is increased 41 per cent, how much is q increased? (b) How much would the discharge increase over a rectangular weir with a corresponding increase in head?

Ans.: $q_1 = 0.843q_2$; $q_1 = 0.597q_2$.

2. (a) What are the essential points of difference between corrugations and fur-

rows used for irrigation? (b) For a particular crop, do the soil properties influence the selection of furrows rather than corrugations?

3. (a) What are the major functions of diversion structures? (b) What forces are permanent diversion structures required to resist? (c) Are the dimensions of farm diversion structures, i.e., lengths, depths, and widths, influenced by the soils in which they are built? Explain.

4. (a) In selection of a permanent farm conveyance structure, give the conditions which would influence your choice between a flume, ditch, surface pipe, and underground pipe. Determine the size of a rectangular flume to convey a stream of 2 c.f.s. if the slope of the land on which it is to be built is 1 ft. per 1000 ft. Assume that the inside bottom width should equal twice the water depth.

5. (a) Why is it necessary to have a larger bottom width and depth to convey a given quantity of water through an earth ditch than through a concrete flume of the same slope? (b) If you were going to build an 8-in. pipe on a slope of 2 ft. per mile and you wanted to get the largest possible quantity of water through it, neglecting differences in cost, what kind of pipe would you select? Why?

6. (a) What major objectives should influence the irrigator's selection of irrigation water distribution structures? (b) Does the cost of water influence the selection of a distribution structure? (c) Do the soil properties influence the selection of distribution structures? Explain briefly.

7. A man has 4 horses of the following weights: 1000 lbs., 1400 lbs., and 2 of 1200 lbs. each. How could they be hitched onto a Fresno scraper to level and smooth the land so that each horse would pull proportionately to its weight?

CHAPTER VII

1. What are some of the chief agencies that influence soil-forming processes?
2. What is the chief source of the mineral compounds in soils?
3. Is it practicable for the irrigation farmer greatly to modify the texture of his soil? Why?
4. What kind of soil structure is best suited to irrigation and crop production? Give ways by which the farmer can maintain a favorable structure in his soil.
5. Distinguish between the real specific gravity and the apparent specific gravity of a soil. Is it possible for the apparent specific gravity to be equal to or larger than the real specific gravity? Explain.
6. What substances occupy the pore space of a soil? Is the percentage pore space of a field soil influenced by its water content?
7. Why is the permeability of an irrigated soil of importance in irrigation practice.
8. For a soil of given texture and structure will a 4-ft. depth of soil hold twice as much irrigation water as one of 2-ft. depth? Assume that the water table is 30 ft. or more below the land surface. Give reasons for your answers.

CHAPTER VIII

1. Why does water rise in vertical columns of soil that have their lower ends immersed in water?
2. In a silt loam soil having particles of average diameter equal to 1/1000 in., what is the probable maximum height in centimeters to which the water will rise in a vertical column of soil?
3. How does the probable maximum height of rise vary with the diameter of soil particles?

4. Consider two vertical columns of soil, one a loam and one a clay, both having their lower ends in water. After having stood long enough to attain capillary equilibrium, which will have the larger moisture percentage in any horizontal plane below the maximum height of rise in the loam soil? Why?

5. Consider 3 soil columns, a clay, a loam, and a sand. After having attained capillary equilibrium, what are the probable relative heights of water in each column of the points of equal moisture content?

6. Do plants wilt permanently at about the same moisture content in all soils? Why?

7. How is the moisture equivalent of a soil influenced by the texture? Why?

8. Are irrigated soils that are naturally well drained ever completely saturated? Explain.

9. Does the capillary saturation of a field soil of given texture and structure change as the plane or surface of complete saturation rises and falls? Why?

CHAPTER IX

1. An irrigator having a flow of 150 Utah miner's inches desires to add enough water to a 10-acre orchard to increase the soil moisture content of his soil 5 per cent to a depth of 6 ft. The dry soil weighs 85 lbs. per cu. ft. Find hours required to apply the amount needed.

2. Find the c.f.s. to raise the moisture content of a sandy loam soil from 12 per cent to 18 per cent on a 22-acre tract in 33 hours. Assume dry soil weighs 80 lbs. per cu. ft. and depth of soil is 7 ft.

3. Prove that $P_v = P_w \times A_s$.

4. Prove that $d = P_w A_s D$.

5. To how many acres of land will a 5 c.f.s. stream add 6 per cent moisture, dry-weight basis, to the upper 5 ft. of soil in 17 hours? Assume soil of an average weight.

6. (a) If 100 grams of moist soil weighs 92 grams when oven dried, find P_w .

(b) If this is a loam soil weighing 80 lbs. per cu. ft., oven dried, how many pounds of moisture were present per cubic foot of soil?

7. What depth of water in inches was retained by the soil from a 6-in. irrigation as shown by the following moisture tests before irrigation and 24 hours after? Soil is sandy loam weighing 106 lbs. per cu. ft. when oven dried.

Depth of Soil in Feet	Per Cent of Moisture before Irrigation	Per Cent of Moisture 24 Hours after Irrigation
1	4.89	10.08
2	5.61	8.50
3	5.35	9.35
4	4.26	7.94
5	5.19	7.64

8. Soil moisture determinations from 20 borings in a homogeneous loam soil of a 10-acre orchard indicated an average P_w of 13.2 per cent. The maximum field capillary capacity of the upper 6 ft. of soil 3 days after irrigation is 18.5 per cent, and $A_s = 1.36$. Allowing 15 per cent of the net amount of water applied in a single

irrigation for unavoidable losses, what depth of water should the irrigator apply in order to store the maximum amount the upper 6 ft. of soil will hold 3 days after irrigation?

9. If the soil of the farm described in problem 8 has a mean pore space of 53 per cent, how many surface inches of water would be required to fill all the pore space in the upper 6 ft. of soil after the capillary capacity of 18.5 (P_w) per cent is fully satisfied? *Hint:* Pore space is on the volume basis and $P_v = P_w A_s$.

10. How large a stream would be required to fill all the pore space in the upper 6 ft. of the soil above described on the 10-acre farm in a period of 60 hours? Neglect the water losses that may occur over the boundaries of the tract.

11. Why is knowledge of the capacity of soils to store water of importance in irrigation practice?

12. If an irrigation farmer knows the depth of his soil, the capacity of each foot of soil for water, and the moisture content of the soil before irrigation, show how he can use this knowledge to determine the approximate loss by seepage after an excessively large single irrigation.

CHAPTER X

1. Consider a vertical soil column of 1 sq. ft. cross-section area and 4 ft. long. If 5 cu. ft. of water percolate through the column in 36 hours from a supply pipe which permits the water to flow on to the soil just fast enough to keep the soil surface covered, what is the specific water conductivity?

2. Measurement of the specific water conductivity of a 50-ft. stratum of clay soil overlying a water-bearing gravel shows that $k = 2 \times 10^{-9}$. If the pressure head in the gravel is equal to 75 ft. of water (measured at the lower surface of the clay) and 50 ft. of water at the soil surface, with respect to the same datum, it is apparent that water is flowing vertically upward through the clay. Compute the flow through a block of clay 50 ft. thick and 640 acres in area.

3. A contour map of water pressures overlying an artesian basin, shows an average fall in pressures of 30 ft. per mile. Assume a mean thickness of water-bearing gravel of 26 ft., and that $k = 5 \times 10^{-8}$, and compute the underground flow through a section of gravel 1000 ft. long at right angles to the direction of flow.

4. Assume that a certain 40-acre tract of land is irrigated frequently and given enough water to keep the soil practically saturated below the 6-ft. depth, but that the water table is 100 ft. deep. If the average $k = 3.0 \times 10^{-7}$, compute the number of acre-feet of water that flows vertically downward to the water table each month.

5. Under an 80-acre fallow tract of comparatively level sandy land the water table is kept at an elevation of 3 ft. The magnitude of k for the unsaturated soil above the water table is 9×10^{-8} . If the capillary potential in the surface soil is 225.4 ft.-lbs. per unit mass of water (geepound), compute the loss of water by upward capillary flow in cubic feet per square foot per month.

6. If in problem 5, the capillary potential were 96.6 lbs. per unit mass (geepound), would capillary flow occur? If yes, would the direction of flow be up or down?

7. Is the flow of water through soils classed as "turbulent" or "stream-line" flow?

8. Considering the flow of water in canals and pipes, explain the relation of frictional forces to velocity. If the velocity of flow in canals and pipes is doubled, what is the increase in the frictional force?

9. For flow of water in soils, explain the relation of frictional forces to velocity. How do you account for the difference between the relation of frictional forces to

velocity in canals or pipes from the relation of these factors in the flow of water through soils?

10. Consider an imaginary soil column of unit cross-section area at right angles to the direction of flow of water, and state whether or not it is practicable to measure accurately the net cross-section area of the channels through which flow occurs:

- (a) For a saturated soil.
- (b) For an unsaturated soil.

Give reasons for your answer.

CHAPTER XI

1. Explain why humid region soils do not contain excessive amounts of alkali.

2. Provided one-half of the 831 p.p.m. of alkali salts in lower Sevier River irrigation water were deposited in the upper 3 ft. of soil each year, how many years would it take to add 0.5 per cent total salts to the soil provided 2 ft. of water are applied to the soil each year? Assume $A_s = 1.40$. *Ans.*: 25.35 yrs.

3. Is sodium carbonate a black salt? What is black alkali? What salts give rise to the occurrence of black alkali?

4. A drain tile main outlet from a 1000-acre tract discharges an average of 1 c.f.s. during each of the 12 months of the year. If the average alkali content of the drainage water is 1200 p.p.m., the irrigation water applied to the tract is practically free from alkali, and the mean depth of drains is 6 ft., what is the annual reduction in alkali content of the soil in terms of the percentage of the weight of the dry soil?

Ans.: 0.0102%.

5. Explain fully why lowering of the water table is helpful toward the prevention of alkali accumulations on the surface of the soil.

6. In addition to lowering of the water table give other means of preventing, or at least decreasing, the accumulations of alkali on the surface of the soil.

7. Under what conditions, if any, is it advisable to use, for irrigation purposes, water that contains appreciable quantities of alkali salts? What precautions are necessary to minimize the danger of using alkali irrigation water?

8. Are the texture and the structure of soils related to the alkali problem? If so, explain.

CHAPTER XII

1. If the transpiration ratio of alfalfa is 850, and field-cured alfalfa contains 8 per cent water, how many acre-inches of water are transpired in order to produce a 4.5-ton crop of alfalfa per acre? *Ans.*: 31 in.

2. What are the more important factors which increase the transpiration ratio and decrease transpiration efficiency?

3. Is it possible to determine precisely the depth of irrigation water needed annually on the basis of experimental determinations of the transpiration efficiency? Explain.

4. What is the essential difference between the term efficiency as applied to pumps in Chapter IV and as herein used with respect to transpiration?

5. Consider a sugar-beet field in which moisture tests in the upper 5 ft. of soil at the beginning of the season show respectively 5.6, 4.7, 3.8, 2.2, and 0 percentages of moisture greater than at the end of the season. The crop-season rainfall was 2 in., and a depth of 16 in. of irrigation water was applied. The average apparent specific gravity of the soil is 1.35, the average yield of sugar beets 17 tons per acre, of which

18 per cent is dry matter. Assume that there was no deep percolation water loss and compute the evapo-transpiration ratio.

6. In problem 5 assume that the seasonal water loss by direct evaporation was 4 in. depth and compute the transpiration efficiency and the transpiration ratio.

7. Under what conditions, if any, is the magnitude of the evapo-transpiration ratio less than the transpiration ratio? Equal to it? Greater than it?

8. Under what conditions, if any, might the making of a soil mulch by cultivation fail to conserve water?

CHAPTER XIII

1. A farmer owning "bench" land in which the sandy loam soil averages about 4 ft. deep and is underlain by gravel and coarse sand to a depth of 30 ft. or more discovered in March by borings with a soil auger that the light winter precipitation had penetrated the soil only to a depth of 6 in. He at once applied a 5-c.f.s. stream of flood water to his 20-acre tract and kept the stream well spread out on the land for a period of four 24-hour days in order to give the soil a good soaking. Find approximately what percentage of the water applied was lost by deep percolations. There was no surface run-off. *Ans.:* 65.6 to 78.5%.

2. What are the major purposes of irrigating soils during the non-growing or dormant season?

3. Is the growth rate of crops seriously retarded as soon as the moisture content falls below the so-called optimum moisture percentage? Explain.

4. Explain why clay soils retain larger amounts of unavailable water than sandy soils do.

5. Under what conditions, if any, is it justifiable to divert water from partly-filled storage reservoirs during the non-growing or dormant season for irrigation purposes?

CHAPTER XIV

1. What is the distinction between the evapo-transpiration ratio as defined in Chapter XII and the consumptive use in its basic sense as defined herein?

2. Are studies concerning the consumptive use of water in irrigation likely to increase in importance as time advances? Why?

3. Under what conditions, if any, might the farm consumptive use, U_f , appear to be less than the real consumptive use, U ?

4. Given: a 40-acre farm, of which 95 per cent is cultivated:

(a) Irrigation water delivered = 76 acre-feet.

(b) Average of 3 per cent soil moisture, dry-weight basis, absorbed from upper 5 ft. of soil in which $A_s = 1.4$.

(c) Crop year rainfall = 5 in.

(d) Depth of ground-water table = 80 ft.

(e) Surface run-off from farm equals zero.

Find the farm consumptive use, U_f .

5. Is the consumptive use efficiency as here defined related to the transpiration efficiency? If so, how?

6. In Chapter IV it is shown that pump efficiencies are always appreciably lower than 100 per cent. Is it possible for the consumptive use efficiency to equal 100 per cent? to exceed 100 per cent?

7. What do you consider the most difficult factors to control in determining the consumptive use, U , by experiment on field plots?

8. Find a graph showing the average mean daily temperature in your locality and compute the seasonal heat available to alfalfa in day-degrees. Specify assumptions you consider necessary to this computation.

CHAPTER XV

1. (a) Construct a (y, U) curve based on the following data:

y tons	U feet	y tons	U feet
0.0	0.0	5.8	2.5
2.0	0.5	6.2	3.0
3.7	1.0	5.9	3.5
4.6	1.5	5.7	4.0
5.4	2.0	5.4	4.5
		5.0	5.0

(b) Determine graphically the slope of your (y, U) curve at each $\frac{1}{2}$ -ft. interval of U from 0 to 5.0 ft. inclusive.

2. The data of problem 1(a) were based on the assumption that $D_f = 0$ and therefore that $U_f = U$, but a careful study of the moisture distribution in the field soil gives reason to believe that $D_f = 0.8$ ft. Plot the true (y, U) curve on the sheet used in problem 1, considering $D_f = 0.8$ ft.

3. If, in the measurement of U in problem 1, it was found that $m = 0$ and $g = 0.6$ ft., considering $D_f = 0$, plot the $[y, (w + r)]$ curve using the data of problem 1.

4. Give your understanding of the law of diminishing returns.

5. Under what conditions, if any, is the quantity of water, U , that produces the maximum crop yield, y , the most economical quantity?

6. What is the major source of uncertainty in the measuring of the total amount of water consumed by plants in field plot experiments?

CHAPTER XVI

1. Give the essential differences between quasi-public and public irrigation organizations.

2. Give the essential differences between mutual associations and mutual irrigation corporations. Can a mutual irrigation corporation sell the land owned by its delinquent stockholders in order to collect payments of irrigation assessments?

3. Why has the commercial irrigation corporation been less influential than the mutual irrigation corporation?

4. Does the Federal Government advance funds with which to build irrigation works on Carey Act projects?

5. Can an irrigation district sell the land owned by its delinquent members in order to collect payments of irrigation assessments?

6. What form of public irrigation enterprise preceded the creation of the United States Reclamation projects?

7. In western water law, what are the distinguishing features between the doctrine of appropriation and the riparian-rights doctrine?

8. What basic elements are essential to completeness of legislation concerning water rights?

9. Give briefly the important procedure in the adjudication of water rights.

10. What are the several elements requisite to the acquirement of new water rights?

CHAPTER XVII

1. (a) If an irrigation company that supplies water to a tract of 32,000 acres net irrigated area diverts 350 c.f.s. from a river, and sustains a conveyance loss of 1 per cent of the water entering each 1-mile section within that mile section in its 30-mile main canal, what is the use ratio in acres per c.f.s. measured at the heads of laterals?

(b) Assuming a loss in the laterals through conveyance and unavoidable waste of 40 c.f.s., compute the net use ratio in acres per c.f.s.

2. For the same conditions as in problem 1, compute the net use ratio in acre-inches per acre, for a 4-month, a 5-month, and a 6-month irrigation season.

3. Is it possible for the net use ratio in acres per c.f.s. to be less than, or equal to, the gross use ratio? Explain.

4. When measured in acre-feet (or acre-inches) per season per acre, under what conditions, if any, can the net use ratio be greater than, or equal to, the gross use ratio? Explain.

5. Does the preparation of land for irrigation influence the consumptive use of water as defined in a basic sense and represented by the symbol U of Chapter XIV? Does it influence U_f , i.e., the farm consumptive use? Explain.

6. How can irrigation farmers increase the gross use ratio, as measured in acres per c.f.s. without also increasing net use ratio?

7. Indicate and explain whether the administrative practices in your community encourage carefulness or carelessness in the use of irrigation water.

8. Is it practicable for the state to specify by law the proper use ratio for each irrigation company within its borders? Why?

CHAPTER XVIII

1. The soil of a certain irrigated farm is a clay loam of comparatively uniform texture to a depth of 6 ft., below which there is a coarse gravel to a great depth. Moisture determinations before irrigation and again 24 hours after irrigation show an average of 4.5 acre-inches per acre irrigation water stored in the soil from an irrigation in which the irrigator used a stream of 3 c.f.s. continuously for 24 hours on a 10-acre tract of alfalfa. Neglecting consumptive use between completion of irrigation and the taking of samples for moisture determinations, what was the water application efficiency, E_a ? *Ans.*: 62.5%.

2. The average apparent specific gravity of the soil of the tract considered in problem 1 is 1.3. Provided the mean increase in moisture content to a depth of 6 ft. equals 5.35 per cent, what is the application efficiency? *Ans.*: $E_a = 69.5\%$.

3. For a 40-acre tract, the run-off, R_f , during a period of irrigation of 3 days, 24 hours each, maintained continuously a depth of 0.44 ft. over a right-angled V-notch weir. If 240 acre-inches were applied to the farm and 180 acre-inches stored in the soil root zone, approximately what percentage of the water applied was lost through deep percolation? *Ans.*: 15.4%.

4. Consider an irrigation project on which 35 per cent of the water diverted is lost in conveyance and delivery, 25 per cent of the water delivered is lost as surface run-off and deep percolation, and 30 per cent of the water stored in the soil is lost by evaporation, and compute the irrigation efficiency, E_i . *Ans.*: 34.2%.

5. Under what conditions, if any, does the reduction of conveyance and delivery losses in an irrigation project increase the economy of conveyance and water delivery?

6. (a) Give three major conditions that tend to make irrigation farmers satisfied with a low water application efficiency.

(b) Give three major conditions that tend to stimulate irrigators to attain a high water application efficiency.

7. In a locality where the irrigation farmer can obtain plenty of irrigation water at a given price per acre, is the economical consumptive use dependent on the annual acre cost of rental, taxes, plowing, seeding, and fertilizing? Explain.

8. Enumerate the conditions, in order of their importance, which you consider most essential to the attainment of community economical use of irrigation water.

INDEX

A

- Abell, T. H., 375, 378
Aberdeen Substation, Idaho, 326, 327, 330
Acceleration due to gravity, 39
Acquisition of water rights, 294
Acre-inch, definition of, 36
-inches, applied in single irrigation, 168
-feet, applied in single irrigation, 168
-foot, defined, 36
Adams, Frank, 63, 123, 173, 242, 249, 280, 339, 343
Adjudication of water rights, 294
Administrative practices, 304
Africa, irrigated area in, 2
Agricultural Engineers, American Society of, 383
 responsibility of, 6, 398
Agricultural phases of irrigation, 6
Aicher, L. C., 325, 327, 330, 331
Alexander, W. P., 297, 307
Alfalfa, cuttings influenced by length of season, 333
 experiments on water needs, 270, 339
 fall irrigation of, 248
 frequency of irrigation of, 338
 growing season for, 339
 irrigation requirements of, 339
 lands, submergence of, 334
 methods of irrigation, 333
 root distribution of, 334, 336, 337
 time to irrigate, 337
 water needed influenced by climate, 301
Alkali, 146
 in irrigation water, amounts of, 221, 301
 in water, danger limits of, 221
 kinds of, 214
 lands, irrigating in furrows, 217
 manure valuable, 217
 methods of temporary control of, 218
 movement of in soils, 214
Alkali salts, accumulation of, 8
 soils, retarding evaporation from, 218
 source of, 213, 214
 water for irrigation, 220
Alway, F. J., 234, 236
Apparent specific gravity, 141
Apples, water requirements of, 376
Application of water, economical, 313
 time rate of, 105
Archimedean Screw, 72, 73
Arid regions, prosperity of, 397
Asia, irrigated area in, 2
Associations, mutual irrigation, 282
Auger, soil, 161, 162
 proper use of, 249, 359, 377
- ### B
- Baker, Donald M., 12, 33
Ballantyne, A. B., 378
Bark, Don, 104, 105, 106
Barley, irrigation, time for, 325
 water requirements of, 330
Barrows, E. L., 242, 250, 343
Basin method of irrigation, 369
Batchelor, L. D., 249, 371, 377, 378
Bear River, pumping from, 87
 surplus water, 393
Beckett, S. H., 280, 331, 334, 339, 343, 372, 374, 375, 377, 378
Beneficial use of water, 293, 319, 390
Bennion, V. R., v
Bixby, F. L., 94
Blaney, Harry F., 163, 188, 372, 375, 377, 378
Bloodgood, Dean W., 224, 280, 329, 331, 341
Borders, implements for making of, 127
Botkin, C. W., 224
Bouyoucus, G. J., 231
Box, concrete division, 63
Breazeale, J. F., 241, 249
Briggs, L. J., 228, 231, 232, 236, 238, 240, 249

- Briggs-McLane moisture equivalent, 175
 Brown, J. B., 360, 378
 Buckingham, Edgar, 211
 Buckman, Harry O., 146, 148
 Burgess, P. S., 224
 Burr, W. W., 160
- C
- Cache Valley, Utah, 331, 338, 349
 California studies, 173
 Call, L. E., 234, 236
 Canals, concrete-lined, 32
 earth, 31
 force causing flow in, 21, 192
 irrigation, in the West, 130
 measuring the discharge of, 58
 Capillary flow, 209
 in field soils, 209
 steady and variable, 205
 steady horizontal, 206
 vertically downward, 209
 Capillary force, 151
 moisture, distribution of, 152
 phenomena, 147
 potentials, 195
 and moisture content, 195, 206
 Carey Act, 285
 Cereals, crops considered, 321
 methods and time of irrigation of, 322
 Channel, irrigation conveyance, 31
 Checks, contour, rectangular, 107
 Chezy, equation proposed by, 30
 Christensen, Oswald, 160
 Cipolletti weir, 42
 discharge table, 43
 Citrus groves in California, 357, 377
 irrigation of, 357
 Climate and alkali, 213
 irrigation, 6
 Climate, importance to formation of
 soils, 140
 Clover, C. E., 332
 Clover crop under irrigation, 342
 Clyde, George D., v, 16, 50, 63
 Clyde, Harry S., 275, 280, 314, 320
 Code, W. E., 84, 94
 Coe, F. M., v
 Coefficient, hygroscopic, 158, 159
 Commerce, Bureau of, 2
 Commercial companies, 283
 Commissioners, water, 295
 Community, the irrigation, 9
 pioneer, 130
 Companies, mutual irrigation, 304
 Company, purpose of power, 83
 Conductivity, specific water, 144, 200-
 205, 235
 Cone, V. M., 63
 Conkling, Harold, 12, 35
 Conrad, J. P., 153, 158, 160, 236
 Consumptive use, defined, 252
 dependability of measurement of, 255
 economical, 314
 efficiency, 262
 farm, 253
 of water in irrigation, symbols used,
 252
 on field experimental plots, 256
 under specific conditions, measure-
 ments of, 255
 Conveyance, losses, 303
 excessive, 312
 Corn, water needs of, 331
 Cooperative effort, importance of, 4
 Corrugations (*see* Furrows)
 Corrugators, drag and roller types, 127
 Corvallis, Oregon, alfalfa irrigation at,
 339
 Cosby, Stanley W., 187
 Costs, irrigation, payments of by com-
 munity, 9
 irrigation pumping, 84
 of various irrigation methods, 118
 Covering different areas with water,
 experiments on time, 104
 time analysis, 102
 Crops, and water used, 278
 appearance of and irrigation needs, 239
 furrow, 111
 furrow-irrigated, 99
 growth, stage of, 246
 irrigated in humid climates, 382
 irrigation of other, 354
 production in arid-region, water as
 limiting factor of, 267
 root, 239, 277
 truck, berry, 386
 yield, influence of, 268
 Cultivator, beet, 127

Current-meter readings, 58

Curry, Albert S., 280, 329, 331, 341

Curve, draw-down, 91

D

Dams, 393

 earth, temporary, 136

 portable, 136

Davidson, J. B., v, 384, 388

Davis, California, 272, 273, 274, 334, 339

Debler, E. B., 307

Dechutes Valley, Oregon, 338

Deep percolation losses, 227, 253, 258,
265, 266

Delhi, California, 334, 340, 341

Delivery losses, 303, 309, 312

Demand charge, 83

Desert Land Act, 284

De'Sigmond, Alexis, A. J., 224

Dethridge meter, 60

Devices, for lifting water, 65

 measuring and recording, 59

 self-registering, 60

Diminishing returns, 278

Discharges, measurement of widely
 varying, 55

 through soils, 199

Ditches, distribution, 97

Ditch, earth supply, 112

Diversion structures, hydraulic prin-
 ciples of, 135

Division box, 62

Doctrine of appropriation, 293

Dormant-season irrigation, 374, 375

Downing, C. J., 372, 376, 375, 378

Drag, 125

 V-shaped, 127, 129

Drainage, after storms or irrigation, 220

 for permanent relief, 218

 how provided, 391

 natural, 114

Draw-down curve, 91, 92

Draw down in pumping, 370

Drops and chutes, 32

Drought and alkali, 213

Dry matter, 227

Dry-weight basis of moisture per cents,
 164

Dyne, defined, 191

E

Earth's surface, sterile areas of, 379

Economical application, 313

 consumptive use, 314

 conveyance and delivery, 312

 use of water in irrigation, 312

Edlefsen, N. E., v

Efficiencies, conveyance and delivery,
 309

 examples of, 311

 high, 75, 312

 irrigation, 310, 311

 low, 75

 pumping plant, 65

 transpiration, factors influencing, 231

 water application, 308, 313

Egin Bench, Idaho, 114

Energy, expenditure of, 27

 grade lines, 27, 192

Engineer, responsibilities of agricultural,
 6, 298

Engineering phases of irrigation, 5

Engineer-manager, 283

Equations, discharge of canals, 30

 discharge of weirs (*see* Weirs)

 limitations of, 211

 velocity, 30

Equilibrium, attainment of, 171

 static, 194

Equipotential regions, 193

Equivalents, convenient, 63

Erosion, soil, in irrigation of cereals, 323

Etcheverry, B. A., 12, 35, 82, 94

Europe, irrigated area in, 2

Evaporation, direct, 233

 influences of cultivation on, 233

 losses, reduction of, 110

 reducing of, 217, 233

Evapo-transpiration ratio, 235

Ewing, Paul A., 94

Experimental results, using of, 275

 work, review of, 267

Exploitation of public resources, 299

F

Factors, biological and chemical, 300

 climatic, 6, 301

 net and gross use, 302

 physical, 301

- Farm irrigation, 130
 structures, for water control, 126
 Farmer, the irrigation, 8, 9
 Farming, irrigation, 338
 Field capillary moisture capacity, 170
 Film, pressure of, 148, 149
 pressure, applied to soil moisture, 150
 Financial failures, 8
 Fishburn, H. P., 332
 Flashboards, 135
 Flooding, basin method of, 108
 border-strip, 97, 109
 check method, 107
 from field ditches, 96
 primitive and modern, 95
 wild, 96, 109
 Flow, commonly used units for rate of, 36
 Flumes, 32
 in orchard growing districts, 366
 Parshall, 57
 Venturi, 57
 wood or concrete, 112
 Foot-pound-second units, 191
 Forbes, R. H., 217
 Force as related to work, 190
 Force, capillary, unbalanced, 274
 conservative, 197
 driving, per unit mass, 92, 197, 198
 frictional, 26, 27, 37, 197, 198
 retarding, 26, 33, 197
 Fort Collins-Greeley area, 395
 Fortier, Samuel, Plate III, 12, 104, 123,
 233, 280, 307, 329, 331, 333, 337,
 343, 378
 Fresno scraper, 126, 127
 Fruit growing in the West, 355
 Fuel, for pumping, kinds and cost of, 82
 Furrows, deep, implements for making
 of, 127
 important factors of, 355, 357, 384
 length of, 110, 345, 357
 making the, 369
 method, advantages of, 110
 number of between the tree rows, 356,
 359
 shallow, 127, 369 (corrugations)
 slopes of in California, Oregon, Utah,
 360
 spacing and depth of, 111, 345, 357
 water distribution to, 112
- G**
- Gage heights, 59
 Gardner, Willard, v, 160, 187, 205, 207,
 211, 225, 275, 280, 314, 320
 Gate, check defined, 133
 Geepound defined, 191
 Gooding Substation, Idaho, 329, 330, 340
 Grade lines, energy and hydraulic, 27,
 192
 Gradient, energy, 193
 hydraulic, 193, 200, 201
 moisture, 209
 potential, 191, 192, 200, 201
 Grain crops, 275
 Grains, water requirements of, 328
 Gravitational potential, 190, 193
 Gravity, force of, 21, 65, 144, 189
 Grasses, under irrigation, 342
 Greaves, J. E., 213
 Gross use of water, 300
 Ground waters, 87, 88
 Growing season, irrigation during the,
 371
- H**
- Harding, S. T., 94, 263, 307
 Hardman, George, 329, 332, 340, 351
 Harrows, use of good, 126
 Harris, Evan, 225
 Harris, F. S., 146, 215, 216, 218, 221, 223,
 225, 234, 235, 236, 249, 263, 280,
 323, 331, 343, 349, 350, 353, 354
 Hawaiian Islands, 383
 Headden, W. P., 216
 Headgate, 133
 Hemphill, Robert G., 261, 263
 Hendrickson, A. H., 177, 239, 240, 241,
 244, 249, 250, 273, 378
 Higley, Arizona, production of alfalfa,
 272, 273
 Hilgard, E. W., 146
 Hill, L. K., v
 Hoff, E. J., 59
 Holtz, H. F., 231, 232, 236
 Horse power, 66
 water, 69
 Horse-power-hour, 66
 1 brake, 82
 Horse-power requirements, 91

Huber, H. F., 123
 Huberty, M. R., 123, 234, 330, 331, 334,
 339, 343, 360, 378
 Humbert, E. P., 331
 Humid climates, irrigation practice in,
 140
 Humid-farm irrigation plans, 388
 Hutchins, Wells A., v, 280, 284, 285,
 286, 289, 295, 296
 Hydraulic grade line, 27, 192
 gradient, 201
 permeability, 200
 Hygroscopic coefficient, 158, 159

I

Implements, farm irrigation, 125, 132
 Individual vs. community economical
 use, 320
 enterprises, 281
 Insect pests, control of, by cultivation,
 333
 Institutions, community, 10
 Inter-molecular forces, 147
 Iowa State College Farm, 384
 Israelsen, O. W., 63, 146, 153, 158, 160,
 187, 211, 212, 262, 263, 280, 314,
 320, 343, 354
 Irrigable area, per cent non-productive, 4
 Irrigated lands, classes of, 389
 Irrigation, activity, individual, 282
 agencies, public, 291
 commercial company, 283
 communities, problems of, 392
 schools of, 10
 company, mutual, 282
 defined, 1
 districts, 285
 during the dormant season, 247
 early spring, 248
 efficiency, 310, 311
 efficient use of, 6
 extent of, 2
 fall, need for, 247
 in humid climates, 140, 379
 mean depth of, 105
 methods of for grains, 321
 orchard, 111, 130, 248
 phases of, 5
 practice, application in, 159, 319

Irrigation practices determined, 321
 problems, 389, 399
 processes in, 312
 public interests in, 10, 389
 requirements, 329, 376
 results of excessive, 390
 social phases of, 10
 structures, designing and building of,
 398
 supplementary to rainfall, 379
 time of, 237
 water, disposal in, 251
 wild flooding, methods of, 138
 winter, 248

J

Jennings, D. S., v
 Jensen, C. A., 236
 Johnston, C. N., 69, 80, 94
 Johnston, C. T., 72, 94
 Johnston, W. W., 225, 342, 343
 Jones, J. S., 332

K

Kay, A. O., 388
 Keen, Bernard A., 150, 160
 Kelley, W. P., 225
 Kiesselbach, T. A., 231, 232, 236, 256,
 263
 King, F. H., 233, 236, 382
 King, Horace W., 35, 63, 66
 Knight, C. S., 280, 329, 332, 340, 343, 351
 Koblé, Geo. W., 343
 Kraus, E. J., 376, 378
 Kutter, 30

L

Land, meadow and hay, irrigation re-
 quirements of, 342
 not yet irrigated, 392
 partially irrigated, 291
 preparation of, 302
 Lands, arable, water supply inadequate
 for, 316
 fully irrigated, 390
 not yet irrigated, 392
 partially irrigated, 391

- Laws, elements of water, 293
 Leather, J. W., 231
 Lee, Charles H., 150, 160
 Levees, 113
 constructing along contours, 107
 Lewis, C. I., 376, 378
 Lewis, M. R., 260, 263, 388
 Lifts, pumping, 69
 Linford, Leon B., 158, 160
 Livestock industry and alfalfa, 333
 Logan River, 16, 18, 393
 Lorie, R. E., 383, 388
 Losses of moisture by evaporation, 234
 Losses, conveyance, 303
 delivery, 303, 310
 run-off, 109
 Lux vs. Haggin, 293
 Lyman, Richard, R., 55, 63
 Lyman water register, 60
 Lyon, T. Littleton, 146, 148
- M
- Mackie, W. W., 216
 Magistad, O. C., 241, 249
 Magnitudes and measurements, 265, 266
 Manning equation, 30, 33, 197
 Marr, James C., 123, 280, 329, 332, 339
 McBride, Brice, 307
 McCall, M. A., 236
 McDole, G. R., 234, 236
 McGee, W. G., 150
 McLane, J. W., 236
 McLaughlin, W. W., 152, 153, 160, 187,
 211, 212, 234, 236
 McNeely, L. R., 343
 Mead, Elwood, Plate VI, 12, 391
 Measurement, experimental, 255
 of irrigation water, 36
 points of, 299
 tank, 264
 units of water, 36
 weir, 49
 Measuring rule, Clausen-Pierce, 55
 Mechanical work, defined, 27
 Meinzer, Oscar E., 200, 212
 Mesilla Valley, New Mexico, 329, 341
 Meter, current, 57
 Meters, different kinds of, 60
 Michigan, irrigation experiments in, 383
- Milligan, C. H., v
 Miner's inch, definition of, 36
 Miskin scraper, 126, 127
 Mitchell, Geo. A., 115, 123, 385
 Moisture capacity, capillary, 167
 field capillary, 158
 Moisture content, 158, 164, 195
 of different soils, 174-178, 377
 of each foot of soil, 174, 176, 177, 181,
 183
 optimum, 241
 Moisture, above the wilting zone,
 growth rate for, 239, 241
 equivalent, definition of, 158
 losses of by evaporation, 234
 need for different soils, 242
 optimum, 238
 percentage, 241
 wilting, 158, 240
 Mulches, vegetative, 235
 Murdock, H. E., 88
- N
- Nature of irrigation agriculture, 2
 Nelson, J. W., 378
 Nevada Station, Reno, 340
 New Jersey, 382
 New Mexico, 341
 North America, irrigated area in, 2
- O
- Oats, time for irrigation of, 324
 water requirements of, 330
 Oceania, irrigated area in, 2
 Orchard, apple, Idaho, irrigation of, 372
 apricot in Santa Clara Valley, Cali-
 fornia, 369
 in the Roque River Valley, Oregon,
 376
 irrigation investigations in California,
 372
 irrigation of, 355
 Oregon, 379
 peach in California, 360
 soils in Idaho, 375
 soils, penetration of water into, 359
 time for irrigation of, 371

- Orchard, Virginia, 382
 walnut in California, 366
 winter irrigation of, 379
- Organizations, administrative, 314
- Orifice, discharge through, 38
 properties of, 46
 submerged, 46
 velocity of flow through, 36, 37
- Oserkowsky, J., 160
- P
- Packard, W. E., 343
- Parker, Philip A. Morley, 102, 123
- Parshall Flume, 57
- Parshall, Ralph L., 63, 64
- Peaches, irrigation of, 371, 376
 orchards, Utah, 375
 rate of growth of, 239
- Percolation (*see* Deep percolation losses)
- Permeability, 100, 144
 coefficient of, 200
 defined, 201, 202
 hydraulics, 200
 measurement of, 204
- Peterson, W., 213
- Pioneer practices of irrigation, 3, 4, 390
- Pipe, concrete, underground, 112
 flow in, 24
 inclined, capillary flow in, 207
 level, flow in, 21
 or culverts, submerged, 136
 portable, slip-joint, 138, 139
 system for spray irrigation, 115, 116,
 118
- Pittman, D. W., 325, 330, 331, 332, 342,
 343, 349, 350, 353, 354, 380
- Plant, soil relations to, 241
 chlorosis, occurrence of, 300
 food, available, 231
 compounds, 145
 growth, functions of soil moisture in,
 147
 maximum rate of, 239
- Plant, the nature of, 232
 transpiration, 226
 vigor of the, 233
- Plow, kinds of, 130
 shovel, 369
- Ponding, avoiding of, 109
- Pore space, 142, 143
 computed, 175
- Potatoes, 351
 irrigation requirements of, 353
 methods of irrigation of, 352
 on the Utah Central Experiment Farm,
 354
 time for irrigation, 353
- Potential gradient, 191, 201, 235
 studies, capillary, 194
- Potential, space rate of change of, 190
- Potentials, 190
 capillary, 195
 measurements of, 196
 equilibrium value of, 195
 gradient, proportional to hydraulic
 slope, 193
 gravitational, 191
 gravitational and capillary, sum of, 206
 pressure, 194
- Power, irrigation and hydroelectric, 395
 requirements and pumping plant
 efficiencies, 65 (*see also* Horse
 power)
- Powers, W. L., 94, 225, 238, 242, 249,
 263, 338, 341, 342
- Pressure differences, flow in a level pipe,
 21
 measurements of, 22
- Pressure head differences, 24, 25
 in feet, 38
- Pressure-intensity differences, 37
- Primitive irrigation, pumping methods,
 71
- Problems, colonization, 10
 and questions, 399
- Profits, increase in per acre, farmer's
 annual, 119
- Projects, irrigation, construction of,
 281
 newer American irrigation, 8
 reclamation, United States, 291
- Pump, axial-flow type, 81
 capacities, 91
 characteristics, 75
 deep-well, 79
 direct flow, 81
 efficiency defined, 66
 priming the, 77
- Pumps, centrifugal, 75

Pumps, centrifugal, horizontal-shaft, 77
 deep-well turbine, 79
 plunger, 81
 screw-type, 80, 81
 types of, 75
 volute and turbine, 75
 Pumping cost, irrigation, 84
 from wells, 88
 Pumping, irrigation, 65
 extent from ground-water supplies, 88
 water supplies for, 87
 lifts, 69
 machinery, 74
 methods, modern irrigation, 74
 primitive irrigation, 71
 Pumping-plant efficiencies, 65, 66, 69, 70

Q

Questions and problems, 399

R

Radius, hydraulic, 27
 Rainfall, deficiencies in, 380
 low of arid regions, result, 145
 Rating curves and tables, 59
 Real specific gravity, 141
 Reclamation, Bureau of, construction
 achievements, 292
 Records of water used, 307
 Rees, R. W., 376, 378
 Reliance meter, 60
 Research agencies and methods, 264
 Reservoirs, capillary, filling the, 184
 storage, 394
 storage of water in, 246
 surface, 247
 Richards, Lorenzo A., v, 160, 195, 196,
 210, 212
 Richardson, A. E. V., 236
 Riparian rights, common-law doctrine of,
 293
 River system, water yield of, 5, 394
 Robertson, R. D., 280, 343, 278
 Root distribution, 334, 336, 337
 Run-off losses, 109
 Russell, J. C., 160
 Rye, 330

S

Sacramento Valley, California, 102, 173,
 330
 Sakiyeh pumping device, 72
 Salt River Valley, Arizona, 334, 339, 341,
 394
 Salts, excess, washing out of, 219
 high permeability of, 219
 in the soil, toxic limit of, 218
 movement of, 214
 soluble, excess, 146
 San Diego County, California, 379
 Sandsten, E. P., 354
 Scientists, plant, 6
 Schools, leadership in the, 18
 Schwalen, Harold C., 91, 94
 Scobey, Fred C., 28, 30, 35
 Scofield, Carl S., 160, 184, 187
 Screw, Archimedean, 72, 73
 Seasons, growing, dormant, 371
 Seitz, Charles E., 382, 385, 388
 Sewage water, use of, 385
 Sewell, M. C., 234, 236
 Sevier Valley, Utah, 274, 354
 waters of, 393
 Shaduf, primitive pumping device, 71
 Shantz, H. L., 228, 231, 232, 236, 238,
 240, 249
 Shaw, Chas. F., 234, 236
 Shull, Charles Albert, 241, 249
 Siphons, inverted, 33
 Slichter, Charles S., 200, 203, 212
 Slope, surface, 108
 Smith, Alfred, 236
 Smith, G. E. P., 94, 320
 Snake River Valley, Idaho, 318, 327, 342
 Snelson, W. H., 258, 263, 280
 Soil, air in the, 238
 alkali, 221
 and water relations, knowledge of, 159
 apparent specific gravity of, 141
 as a storage reservoir for water, 237
 conditions at experiment stations, 272
 conditions, influence of, 333
 and sub-irrigation, 321
 erosion, 323
 extracting water from, 166
 fertility, permanence of, 390
 -forming minerals, 141

- Soil-forming process, 140**
 limiting, 238
 -moisture conditions and orchard irrigation, 372
 storage, basis of, 168
 moisture constants, 157
 from irrigation essential to plant growth, 379
 particles, size of, influence on crop production, 140, 141
 productivity, maintenance of, 8
 maintenance and perpetuation, 391
 properties, 301
 real specific gravity of, 141
 -sampling tube, 162, 163
 texture and equilibrium water conditions, 153
 tube jack, an efficient, 163
 water, classes and availability of, 147
Soils and irrigation, 7
Soils, arid-region, 7, 140
 arid, mineral plant food elements of, 146
 capacity of, for irrigation water, 161, 173
 depth of, 145
 discharge of water through, 199
 essentially reservoirs, 159
 field moisture capacity of and moisture equivalent, 177
 field, capillary flow in, 209
 fine-textured, capacity to retain water, 237
 heavy, 107, 110
 ordinary, 110
 peat, 384
 physical properties of below surface, 162
 pore space in, 198
 porous, 107
 potential in, consideration of, 194
 saturated, 189
 conductivity of, (*see* Specific water conductivity)
 velocity of flow in, 198
 storage of water in, 161
 unsaturated, capillary flow in, 189
 well-drained, water movement in, 158
South America, irrigated area in, 2
South Dakota, 382, 383
Southwest, arid, 301
Sources of irrigation water, 13
Specific gravity, real, 141
 apparent, 141, 142, 173
Specific water conductivity, 144, 200-205, 235
Specific retention, 167
Spray irrigation, 115-119, 123, 284
Staebner, F. E., 115, 123, 124, 385, 386, 388
Stearns, Norah Dowell, 200, 212
Stream-line, flow in soils, 198
Steward, W. G., 63
Stewart, George, 331, 332, 343, 349, 350, 354
Stewart, R., 213
Storage basins, groundwater, 394
 of water in soils, 161, 173
Strawberry tunnel, 394
Stream, division of, 60, 62
 flowing, discharge measurements of, 31
 fluctuating, 108
Structures, water-conveyance, 136, 138
 distribution, 139
 tabulated list of farm irrigation, 133
Sub-irrigation, 114
 artificial, 114, 115, 118
 natural, 113
Sugar beets, 344
 and potatoes under irrigation, production of, 344
 at Utah Station, 349
 flooding of, 345
 growing sections, 127
 in Cache Valley, Utah, 316
 in Sevier Valley, Utah, 349
 irrigation and cultivation of, 348
 irrigation requirements of, 348
 methods of irrigation of, 344
 time to irrigate, 348
 yield in Nevada, 351
Supplies, water, irrigation and city, 296
Surface tension, 148
Symbols, partial list, vii, viii
Symbols and curves, 268
- T
- Tables, for discharge of weirs, (*see* Weir)**
Taylor, C. A., 163, 188, 372, 377, 378

Taylor, E. P., 372, 375, 376, 378
 Teele, R. P., 12, 296
 Tester, K. B., 160
 Thom, C. C., 231, 232, 236
 Thomas, E. E., 225, 357, 378
 Thomas, George, 12, 296
 Thomas, M. D., 241, 249, 250
 Thompson, C. A., 242, 250, 343
 Time and depth requirements, 102, 106
 Time rate of application, 105
 Tinsley, J. D., 242
 Transpiration, defined, 226
 efficiency, 229, 232
 factors influencing the, 231
 measurements, results of, 227
 ratio, 227, 228, 232
 Trans-watershed diversions, 394
 Tree roots, injury of in making deep furrows, 360
 Truck, and berry crops, spray irrigation of, 115
 Trullinger, R. W., 212
 Tunnels, 32
 Turpin, H. W., 234, 236

U

Umatilla Station, Oregon, 338
 Uncompahgre River, tunnel to, 394
 Unfinished Task, 397
 Unit area, pressure on, 22
 Units employed in soil water flow, 190
 to represent use of water, 298
 Unit mass, driving force due to pressure differences on, 22, 24
 Units, power, 65
 United States, status of irrigation in, 4
 Use, kinds of, 293, 299, 390
 Utah Experiment Station, 330, 331, 342, 353

V

Veihmeyer, F. J., 153, 158, 160, 162, 163, 177, 187, 188, 234, 236, 239, 240, 241, 244, 249, 250, 378
 Velocity equations, 30
 Venturi Meter, 60
 Virginia, study of water needs for orchards in, 385
 Volume weight of the soil, 141

W

Wadsworth, H. A., 64, 124
 Water, amounts of used, 267, 297, 298
 application efficiency, 308, 392
 applied, relation between the yield and quantity of, 259
 available for irrigation, insufficient, 297
 -bearing materials, 92
 capillary, 237
 commissioner, responsibility and power of, 59, 295
 comparisons of cost of, 87
 conditions, equilibrium, 150
 conductivity, (see Specific water conductivity)
 constant velocity of, 26
 consumptive use of, 236
 conveyance and delivery of, 309, 312, 363
 coordinated use of, 397
 depth of applied to a given area, 109
 distribution of, 109, 248, 295
 division of, 60-62
 duty of, 297
 economical use of, 36, 300, 308, 312, 319
 essential to life processes, 226
 exchanges, 395
 flow, forces which cause, 21
 flow of in saturated soils, 189
 flow through the plant, velocity of, 226
 ground, 87, 88, 119
 how applied to lands, 95
 hygroscopic, 147
 in irrigation, consumptive use of, 252
 in soil, available, 240
 irrigation, 123
 irrigation, uniform distribution of, 345
 irrigation and city, 396
 laws, elements of, 293
 legislation concerning, 293
 -logging, 113, 114
 losses during irrigation, reduction of, 302 (see also Deep percolation)
 mains, municipal, 119
 master, functions of, 282
 measurement in field plot experiments, 268

- Water**, units of measurement, 36
 movement of in unsaturated soils, 189
 needed, amounts in humid regions, 384
 need indicators, 239
 per unit volume, mass of, 157
 pressure, intensity of, 21, 36
 priorities, 320
 quantities used on some projects, 297
 register, Lyman, 60
 relative efficiencies of use of by plants, 229
 responsibilities of delegated by law, 295
 right, perpetual, 285
 -right claimants, 294
 rights, adjudication of, 294, 394
 seasonal use of by different crops, 246
 source of in humid regions, 383
 stored, forms of, 161
 -storage measurements, 171
 study of the movement of, 211
 supplies, further, 393
 supply for irrigation, available, 247
 supply, scarcity of, 322
 table, adequate lowering of, 219
 influence of, 216
 time rate of application, 100
 transmission factors for soils, 200
 unavailable, 240
 used, source of, 265
 use of by public and private agencies, 255
 use and crop production, relation between, 264
 use of for irrigation in the West, 300
 used in irrigation, quantity of, 297
 used, relation to yield of wheat, 275
 weight of in a given weight of soil, 142
 weight of per unit volume, 24
 yield of river systems, determining total annual, 393
- Watersheds**, water yields of, 396
- Weeks**, David, 296
- Weir**, 39
 box and pond, 49
 Cipolletti, 42
- Wier**, Cipolletti, discharge table, 43
 crest, measurement of head or depth on, 52
 discharge over submerged, 55
 gage, 52
 Lyman discharge table, 56
 measurements, 49
 pond, open, 50, 52
 rectangular, discharge table, 41
 rectangular, without end contractions, 55
 rule, Clausen-Pierce, 55
 size of best adapted to different streams, 50
 table of dimensions, 51
 table of per cent error, 53
 trapezoidal, 42, 62
 triangular, 42
 discharge table, 45
- Weir**, Walter W., 94
- Weirs**, advantages and disadvantages of, 48
 discharge of, 39, 48
 having suppressed end contractions, 41
 portable, 53, 54
 properties of, 46
 without end contractions, 53
- Welch**, J. S., 280, 329, 330, 332, 340, 343
- Wells**, 88
 battery of, 92
 churn method, 88
 developing of, 92
 drilled irrigation, 90
 drilling mechanical method of, 88
 pumping from, 88
 rotary, 88
 water yield of, 91
- West**, Charles H., 296
- West**, Frank L., 187
- Wheat**, water requirements of, 328, 329
 time for, 323
- Widtsoe**, John A., Plate I, 12, 211, 212, 231, 232, 233, 235, 236, 242, 257, 280, 331, 380, 386, 398
- Willard**, R. E., 234
- Williams**, Milo B., 119, 123, 124, 380, 385, 386
- Wilsdon**, V. H., 160
- Wilting** coefficient or point, 158, 159, 238, 240

Winsor, L. M., v, 262, 263, 280, 320, 343,
349, 354

Work per unit mass, 190 (*see also* Po-
tential)

World, area irrigated in, 2

Wright Coulsen C., 184, 185, 187

Y

Yakima Valley, Washington, water
capacity of soils in, 184

Yao, H. H., 236

Young, Arthur A., 329, 331

Young, Brigham, 308

•

