

CENTRAL LIBRARY

**Birla Institute of Technology & Science
PILANI (Rajasthan)**

Call No. 575.1
S417H

Accession No. 32506

Acc. No.....

ISSUE LABEL

Not later than the latest date stamped below.

--	--	--

McGRAW-HILL PUBLICATIONS IN THE
ZOOLOGICAL SCIENCES
A. FRANKLIN SHULL, CONSULTING EDITOR

HEREDITY

SELECTED TITLES FROM
McGRAW-HILL PUBLICATIONS IN THE
ZOOLOGICAL SCIENCES

A. Franklin Shull, CONSULTING EDITOR

- Baitsell* · HUMAN BIOLOGY
Breland · MANUAL OF COMPARATIVE ANATOMY
Burlingame · HEREDITY AND SOCIAL PROBLEMS
Chapman · ANIMAL ECOLOGY
Clausen · ENTOMOPHAGOUS INSECTS
Frost · GENERAL ENTOMOLOGY
Goldschmidt · PHYSIOLOGICAL GENETICS
Haupt · FUNDAMENTALS OF BIOLOGY
Hyman · THE INVERTEBRATES: PROTOZOA THROUGH CTENOPHORA
Johannsen and Butt · EMBRYOLOGY OF INSECTS AND MYRIAPODS
Leach · FUNCTIONAL ANATOMY OF THE MAMMAL
Mitchell · GENERAL PHYSIOLOGY
Mitchell and Taylor · LABORATORY MANUAL OF GENERAL PHYSIOLOGY
Pearse · ANIMAL ECOLOGY
Rogers · TEXTBOOK OF COMPARATIVE PHYSIOLOGY
LABORATORY OUTLINES IN COMPARATIVE PHYSIOLOGY
Shull · EVOLUTION
HEREDITY
Shull, LaRue, and Ruthven · PRINCIPLES OF ANIMAL BIOLOGY
LABORATORY DIRECTIONS IN PRINCIPLES OF ANIMAL BIOLOGY
Snodgrass · PRINCIPLES OF INSECT MORPHOLOGY
Storer · GENERAL ZOOLOGY
LABORATORY MANUAL FOR GENERAL ZOOLOGY
Van Cleave · INVERTEBRATE ZOOLOGY
Welch · LIMNOLOGY
Wolcott · ANIMAL BIOLOGY
Wolcott and Powell · LABORATORY GUIDE IN ANIMAL BIOLOGY
-

There are also the related series of McGraw-Hill Publications in the Botanical Sciences, of which Edmund W. Sinnott is Consulting Editor, and in the Agricultural Sciences, of which Leon J. Cole is Consulting Editor.

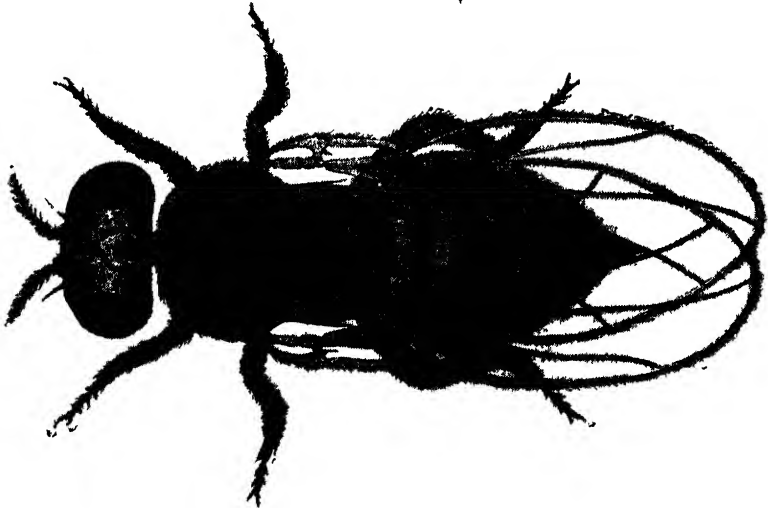
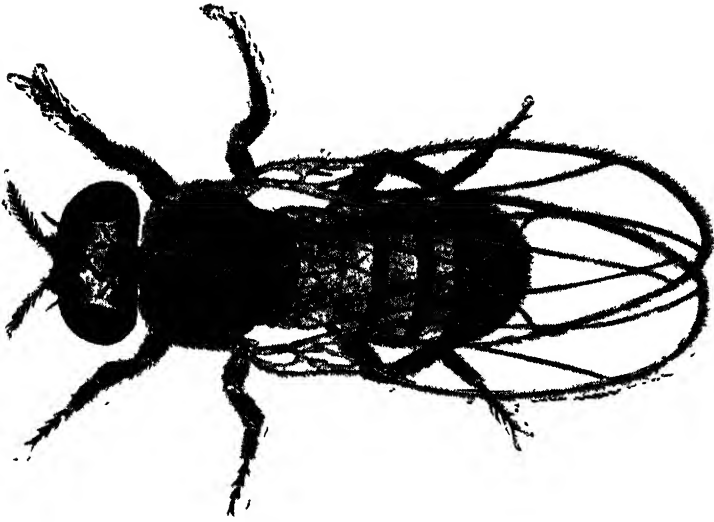

FRONTISPIECE.—The vingar fly, *Drosophila melanogaster*, female (below) and male. This species of fly has developed hundreds of new modifications affecting eyes, wings, legs, body color, spines and physiological characters. For this reason, and because the generations pass rapidly and the flies can be easily reared in large numbers on food that can be furnished the year round, it has been extensively bred in laboratories by students of heredity. More has been learned concerning heredity from this one species since 1910 than had been learned from all sources before that time.

HEREDITY

BY A. FRANKLIN SHULL
Professor of Zoology in the University of Michigan

FOURTH EDITION
SECOND IMPRESSION

McGRAW-HILL BOOK COMPANY, INC.
NEW YORK AND LONDON
1948

HEREDITY

COPYRIGHT, 1926, 1931, 1938, 1948, BY THE
MCGRAW-HILL BOOK COMPANY, INC.

PRINTED IN THE UNITED STATES OF AMERICA

*All rights reserved. This book, or
parts thereof, may not be reproduced
in any form without permission of
the publishers*

PREFACE TO THE FOURTH EDITION

Among the recent advances that make necessary the revision of books on genetics, the most striking is the group of discoveries, by Beadle and others, concerning the biochemical effects of gene mutation. These startling results bring to a climax a long series of studies by various workers. So unified now is the concept of gene action that the discussion of it is segregated in a new chapter. Of the new facts of human heredity, the most important are those relating to the Rh factor in the blood. Discovered only in 1940, and existing in a number of different forms, this substance is not yet fully understood, but it opens up new possibilities of practical applications more extensive than any afforded by the previously known red-cell antigens. This new knowledge is used in several connections, theoretical and practical, in the present edition. In the chapter devoted to practical applications past achievements have been allowed to sink into the background in favor of new developments. It is felt that these practical applications are of greater interest when they involve current discoveries.

In certain allied fields where human heredity is involved at least implicitly, new treatments are regularly in order. Discussions that are continually getting out of date are those on population problems and immigration. With each new census, after time is allowed for digestion of the new numerical data, supporting illustrations have to be modified even if general conclusions are still valid. Accordingly, the chapter devoted to population has been almost completely rewritten. Revisions of discussions of immigration do not await censuses, but respond to depression and war. The position of the United States as a desirable—or possible—place to which to migrate has fluctuated so extensively that the analysis of this process has had to be largely recast.

Other alterations, introduced as aids in teaching, look to simplification. The number of examples used to illustrate a phenomenon has often been reduced. Few of the phenomena included in earlier editions have been omitted; those which are discontinued mostly relate to phenomena not yet specifically shown to occur in man, since it is still held that those who use this book are more interested in human

applications than in any other feature of heredity. These changes have resulted in a moderate shortening of the book.

In the problems, which now are placed at the ends of the chapters to which they relate, a different approach has been adopted. Part of the questions are designed to be thought-provoking, others are inquisitorial. Teachers who prefer the one type to the other can easily sort them out.

A. FRANKLIN SHULL

ANN ARBOR, MICH.
January, 1948

CONTENTS

PREFACE TO THE FOURTH EDITION.	vii
Chapter 1. Rise of Modern Genetics	1
2. Cells and Their Origin.	11
3. Origin of New Individuals.	19
4. Mechanism of Heredity.	33
5. Simple Heredity	43
6. Dominance	51
7. Backcross and Testcross.	59
8. Sex-Linkage	64
9. Multiple Alleles	75
10. Lethal Characters.	83
11. Two or More Independent Pairs of Genes	92
12. Interactions of Genes.	107
13. Modification by Environment	123
14. Linkage.	131
15. Proof that Genes are in Chromosomes.	145
16. Nature and Action of Genes.	151
17. Non-Mendelian Inheritance	160
18. Determination and Development of Sex.	166
19. Heredity and Evolution.	179
20. Inheritance of Human Structural Characters.	191
21. Human Heredity: Physiological Characters	205
22. Inheritance of Mental Characters.	217
23. Applied Genetics.	226
24. Eugenics	241
25. The Population Problem.	254
26. Race and Immigration	270
APPENDIX Quantitative Characters.	285
LIST OF VISUAL AIDS.	299
INDEX	301

CHAPTER 1

RISE OF MODERN GENETICS

The ancient civilizations of Babylon and Assyria, several thousand years before the Christian era, had brought horses and cattle measurably near their modern state of advancement. Grains were cultivated by the Egyptians at least as early as 4000 B.C., for grains of barley have been found in the wrappings and cases of mummies of that time; and wheat, rice, soybeans, flax, and cotton have never, even in remotest records, been referred to as wild plants—they have been cultivated during all that time. Fifty centuries ago, rice was being grown by the Chinese, and their ancient writings show that some varieties were regarded as better than others.

It is difficult to imagine that these steps could have been taken without involving some ideas of heredity. In the Greek period, Hippocrates, the father of medicine, called attention to the recurrence of blue eyes, baldness, epilepsy, and other disorders at different points in a line of descent.

How these traits were then supposed to be transmitted is obscure. Acquired characters, that is, those which develop in the lifetime of an individual through use and disuse or environmental action, and independently of anything in the ancestry, were regularly thought to be inherited. Things that a mother saw or experienced were believed to influence the nature of her children, though even if this were true it could hardly be called heredity. Reproduction was early considered a very generalized process, such that animals of very different kinds (tigers and dogs, for example) could breed together. There are indications that the progeny of unlike animals were regarded as a merger of the qualities of their parents. Out of this merger, the contrasted features could scarcely be expected ever to be restored as such in subsequent generations. Yet, no peculiarity of any ancestor could be entirely ruled out as a possible character in some descendant. Any horse that had a white ancestor had supposedly some chance of being whitish. Hybrids were expected to be intermediate, as they often were, and intermediacy of some degree was anticipated in all the descendants. These are the features of what has been called blending

inheritance, and even in the eighteenth century heredity was in general thought to be of the blending sort.

Particulate Inheritance.—It was a notable advance, therefore, when breeders began to study, not the totality of hybrids, but their separate characters. Kölreuter (Fig. 1) was one of the first to take this step, and he is regarded by some as the first scientific hybridizer. He described the several features of the hybrids and compared them with those of their parents. As this gradually came to be the practice

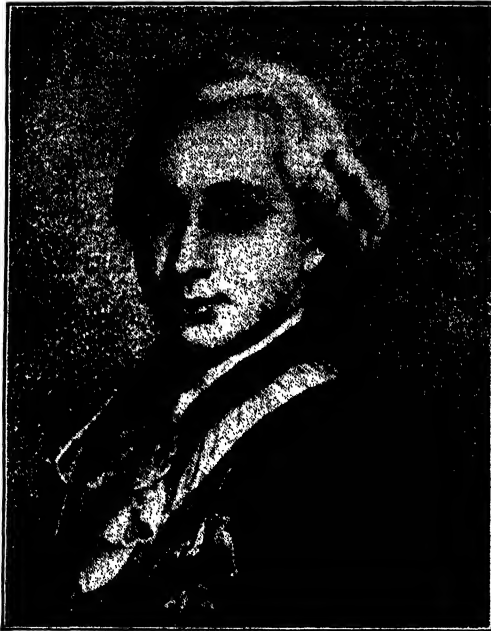

FIG. 1.—Joseph Gottlieb Kölreuter (1733–1806), leading early hybridist. (*Journal of Heredity*.)

of breeders in general, it was observed that hybrids were not always intermediates, but that certain single characters might be fully restored. At the same time it was found that hybrids of generations later than the first were not all alike; some showed one character, others another character. The ear of corn in Fig. 2, in which the separate grains, not the ear or the plant, are the individuals, showed the result of this sorting out of two contrasted colors. This illustration had been published nearly two centuries before Kölreuter, and had not been interpreted as a sorting out of hereditary characters; but it illustrated the accumulation of facts which require this explanation.

What was being gradually learned was that in heredity the units are not the individuals, but their characters. This became particularly clear when several contrasts of characters were observed simultaneously, for the individuals represented different combinations of the characters. Thus was arising the concept of heredity as a *particulate* phenomenon. This word refers to the independence of the characters and of whatever represented them in the organisms, since these, like particles, could be shuffled and recombined. Heredity of a particulate type is in sharp contrast to heredity of the merging sort, with its perpetually intermediate hybrids.

Gregor Mendel.—Though many hybridists described the various combinations of characters in succeeding generations, they neglected to report complete statistics of them, so that explanations of the causes were not easily arrived at. They did not say precisely how many individuals of a hybrid generation showed one character, how many the contrasted character. Gregor Mendel, an Austrian monk who read the descriptions of their experiments, pointed out their lack of analysis, and he indicated that no real understanding of the phenomena could be gained until such complete numerical data were furnished. When two or more character contrasts were studied at one time, it was necessary to know the precise number of individuals exhibiting each combination of characters in each generation. Not finding these facts in any of the published descriptions of crosses, Mendel decided to do some intensive experimentation himself. After due consideration of the species used by others and after some preliminary trials of his own to determine what would best furnish the necessary information, he elected to work with garden peas.

The Famous Pea Experiments.—Garden varieties of peas already in existence furnished many different characters ready to use. Stems were tall and dwarf in different varieties; seeds were green or yellow, also round or wrinkled; pods were inflated or constricted between the



FIG. 2.—Variation among progeny illustrated in corn in 1588, to be attributed either to segregation or to mixed paternity. (From Zirkle, *The Beginnings of Plant Hybridization*, University of Pennsylvania Press.)

seeds; seed coats were either colored or colorless; the pods green or yellow; and the flowers were either distributed along the stem or they were located at the tips. Plants differing in only one of these respects were crossed in the simpler experiments, but more characters were simultaneously used later. When two pure varieties were crossed, all their offspring were alike; and if the varieties had differed in just one character, the hybrids were usually just like one of the parent types. Thus, if yellow-seeded peas were crossed with green-seeded ones, the hybrids were all yellow-seeded. When, however, these yellow hybrids were self-fertilized, their offspring were of the two original kinds, some yellow, some green; and out of very large numbers (over 800 in this particular cross) almost exactly $\frac{3}{4}$ were of one kind (yellow), $\frac{1}{4}$ of the other (green). Crosses involving the other characters yielded numerically the same results—the first-generation hybrids all alike and like one of the parents, the second generation of two kinds in the ratio of about 3:1.

When plants differing in two characters were crossed, their hybrids again were all alike and might be like one parent in both respects, or like one in one character and like the other in the other character, depending on how the two qualities were combined in the parents. When these double hybrids were self-fertilized, the next generation was of different kinds; this time there were four kinds, and again they bore a definite numerical relation to one another. What this ratio was may well be left to a later chapter, but it was essentially the same ratio in every experiment in which the original parents differed in two respects.

To explain the numerically similar results obtained with respect to all the different characters, Mendel postulated heredity units, upon whose nature he wisely did not speculate, but which he was content merely to symbolize with letters, *A* and *a*. Two of these units related to any given character were present in each plant, but, before they were transmitted, they separated (segregated) so that only one went to any one offspring. In the offspring one such unit entered with the female contribution and one with the male, but which type of unit came with each one was determined at random. It was this segregation of the heredity units and their random recombination which led so regularly to the ratio of 3:1 among the offspring in the second hybrid generation or to the more complex but equally regular ratios if two or more pairs of characters were involved.

Story of Mendel's Life.—Descendant of a long line of gardeners, Johann Mendel (Fig. 3) was born in 1822. In school, the short,

stocky lad stood at the head of his class, marked "eminent" in progress and "very good" in all the branches of study—but in the religious lectures merely "good." Despite the latter slight deficiency, he was recommended to an Augustinian monastery at Brunn, in what was then Austria, now Czechoslovakia, in 1843, and was accepted. There he assumed the monastic appellation Gregor, by which he was thereafter known. The monastery was a center of learning, and, when the modest, not particularly reverent, Gregor proved to be temperamentally unsuited to priestly duties, he was shunted to the educational program. Though he had avoided the natural history course, in his



FIG. 3.—Gregor Mendel, from portrait in Moravian Mortgage Bank. (*From Illis, Life of Mendel.*)

early school work, in favor of physics, Mendel was always interested in natural phenomena and was at different times a sunspot observer, a weather-bureau operator, a mouse breeder, a microscopist with flower parts the objects of study, an apiarist even to the extent of crossing different varieties of bees—all in addition to the famous work in plant hybridization. It was to botany that his chief energies were devoted in the monastery school, and, though he twice failed in an important examination in that and other subjects at the University of Vienna because he had been merely self-taught, he nevertheless managed to make valuable contributions to it in later life.

Soon after the publication of his monograph on the pea experiments, events began to shape themselves in opposition to his continued scientific work. For one thing, the now rotund, short-winded pro-

fessor was no longer able to scour the countryside without limit on botanizing trips. Moreover, so respected was he by all concerned that in 1868 he was chosen prelate to head the monastery. Thereafter he became more and more immersed in administrative work and gave less and less to his plant crosses. He also had an unfortunate controversy, extending over a number of years, with the state on the question of taxing monasteries. During this dispute he became somewhat estranged from some of his colleagues, who thought that yielding a principle might have relieved the institution of some of its financial difficulties. Mendel maintained his position of defiance, however, until his death in 1884. His declining years were thus rendered bitter as well as unproductive.

Neglect of Mendel's Work.—Since evolution had become a burning question through the publication of Darwin's "Origin of Species" in 1859, and since heredity is an important element of the evolution process, it might be supposed that Mendel's pea experiments would be promptly seized upon by naturalists and used to the full. That was not their fate, however; instead they were completely ignored for a third of a century. Darwin himself never heard of Mendel's work. The only biologist who is known to have been acquainted with it at the time was the botanist Nägeli. A number of lengthy letters passed between Nägeli and Mendel concerning the pea crosses, but the former seemed not greatly impressed, and commented that the experiments, "far from being finished, are only beginning." The only references to Mendel's experiments in the three decades following were one by Hoffman in 1869, and another in a paper by Focke in 1881, in the latter of which it is stated that his work was much like that of his predecessors but that "Mendel believed he had found constant numerical ratios among the types produced by hybridization." It was not until 1900 that his paper was resurrected, and others had discovered the same principle of segregation and recombination.

Various explanations have been offered for this 34-year neglect of Mendel. The suggestion that the Proceedings of the Brünn Natural History Society was an obscure publication is scarcely valid. Iltis, in his "Life of Mendel," holds that the conciseness of Mendel's paper was against it; readers could hardly convince themselves that anything so small could really be of much value. A third view is merely that the time was not ripe, that the biological world had not yet been brought up to the point where work of the precise and mathematical-looking sort done by Mendel appeared promising. The general interest of naturalists in evolution and natural selection following the publication

of Darwin's "Origin of Species" was doubtless part and parcel of this unripeness of the times for experiments in heredity. Finally, it has been suggested that Mendel might have won recognition for his idea if he had advertised it; and the reason why he did not advertise it was that he feared it was not of general application. There was some reason for such fear; for, after getting well along with the peas, Mendel had also tried hybridizing the hawkweeds, *Hieracium*, and these plants gave very erratic numerical results. Biologists know now that *Hieracium* is to some extent parthenogenetic, so that what Mendel regarded as hybrids were not really such. This would account for the irregularity. Mendel knew nothing of this parthenogenesis, and was at a loss for an explanation. The suggestion made is that Mendel himself did not believe he had hit upon a general law; hence, he did not drive for its recognition. His innate modesty would have helped him reach such a decision.

The Rediscovery of Segregation and Discovery of Mendel.—The work of Mendel was not discovered until biologists were ready to rediscover his law independently. The incentive to renewed study of heredity came from knowledge of variation. Crossing is of significance only if individuals differing in some respect are mated. Studies of variation, notably those conducted by Bateson and De Vries, revealed individual differences which could be so used. Consequently, in the 1890's the attack on the heredity problem was renewed. De Vries, of Holland, found new variations arising in the evening primrose but used also many other kinds of plants in crosses. Correns, in Germany, used corn, peas, beans, lilies, and stocks. In Austria, von Tschermak worked on peas. There were others, but these three are mentioned particularly because of the curious coincidence that they reached the publication stage almost simultaneously, that they arrived at the Mendelian law independently, and that in their search through the literature they all independently discovered Mendel's old paper.

De Vries was the first to publish, in March, 1900. He had learned of Mendel's paper from a list in Bailey's "Plant Breeding," the citation there having been taken from Focke's paper of 1881. Correns, having finished enough experiments to reach conclusions, quickly published them (May, 1900) when he saw the paper of De Vries. Only a few weeks later was the publication of von Tschermak. Correns and von Tschermak had both found Mendel's paper from the reference to it by Focke. All three of these botanists had been led to adopt the principle of segregation of heredity units and the random recombination of these units to explain their own new results. They were of course not a little

surprised to find that similar results and a similar conclusion had been on record since 1866.

Modern Genetics.—The success of these plant hybridizers stimulated great interest, and biologists everywhere began to test the new-old hypothesis in a variety of plants and animals. The law of segregation received, from these tests, fairly general support. With this additional backing, interest in it rapidly grew. Biologists in other fields viewed the flourishing parvenu "genetics" a bit skeptically, and some of them declared it could not be what it was being pictured; the scheme was too simple. And so it was. It was not long before it was found that the system of Mendel had to be modified.

One of the earliest changes was necessitated by the discovery that in some animals, though one parent transmitted the segregated heredity units to all their offspring, the other parent handed on certain units only to half their offspring, and this half were all of one sex. In some species it was the male, in others the female, that possessed this limited capacity of transmission.

Another change was required when it was found that certain characters were not sorted out with entire freedom, but that some of them tended to hang together. Correns had observed this in his work prior to 1900, and others found it later. Consequently, a mechanism whereby the heredity units could be bound together, not too unerringly, in the cells had to be found. Fortunately a mechanism, the chromosomes, which would do this was plainly at hand.

A third modification was needed when it was found that two parents visibly differing in only one respect might produce, two or more generations later, more than two kinds of descendants. A single difference was splitting up into several differences. It had to be supposed in these instances that two or more pairs of heredity units were cooperating, in the original parents, to produce one visible effect, while due to the shuffling that took place in later generations they entered into situations where each unit operated singly or at least with other groups.

Thus the scheme grew and developed. Yet through all these changes the essential Mendelian feature remained—the segregation and recombination of the units of heredity. These units have been located in the chromosomes of cells, and it has been found that they have a very specific arrangement there. Chromosomes have been broken, and the break carries with it a corresponding change in the heredity of certain characters. Chromosomes have been lost or added, and some character or other is modified to suit. So many such peculiar situations have been found or produced and the inherited character so

closely connected with a minute intracellular change, that it is now possible to look in a microscope at the cells of certain organisms and point almost exactly to the spot where something lies that is responsible for an eye color, a wing shape, or the number of joints in a leg.

Important Objects of Study.—Though most organisms whose heredity has been studied agree fundamentally with the above plan, some have yielded more particulars than others. The most fruitful of all objects of such study has been the vinegar fly *Drosophila*. Hundreds of changes that could be used in making crosses have arisen, or been discovered, in this fly since 1910. Under the leadership of T. H. Morgan, a group of investigators has pushed knowledge of the heredity of this fly far beyond anything that would have been dreamed of as possible. Corn has been used by a large group of cooperating and independent workers, and its genetics is only moderately less well known than that of *Drosophila*. The evening primrose *Oenothera*, De Vries's source of plant changes, has a rather specialized scheme of heredity, which has been intensively studied by a large corps of botanists on both sides of the Atlantic.

Among the higher animals, only those which are not too expensive to rear can be used for large-scale studies. These are mice, rats, guinea pigs, and rabbits. Mammals have yielded fewer details than have plants or the simpler animals, but they have the advantage of standing nearer to man, and thus perhaps of indicating more closely the trend of human problems of heredity than does *Drosophila*, corn, or *Oenothera*.

Human Heredity.—Inheritance in man has not been overlooked, but it cannot be used advantageously to discover the details of the heredity mechanism. What is known of man's heredity is therefore mostly an application of what has been discovered more plainly and earlier in other organisms. The first important student of human heredity was Sir Francis Galton, working in the last third of the nineteenth century while Mendel's paper lay unnoticed, hence without the example of complete individual analysis furnished by the pea experiments. Galton thought of heredity quantitatively, and one of his chief principles was the "law of regression," which states that children deviate from the mean of the population less than their parents deviate from the same mean. Such information would be of use to an insurance company, if the inherited character had anything to do with longevity, or to anyone actuarially interested for any other reason, but it did not help to understand the heredity of individuals.

With the coming of Mendelism, the statistical method of studying

heredity gradually gave way to the individual method used in other organisms. Human characters, large numbers of them, have been traced through family histories. Though most of them are still somewhat less than clear, and many of them are really obscure, they bid fair to fall into the same scheme as the inherited qualities of other organisms. No fact of human heredity is yet known which contradicts that scheme in any particular, and many such facts plainly support it.

Practical Applications.—Practical applications of knowledge of inheritance in man are being attempted. The eugenics movement dates from the work of Galton, and strong organizations in several European and American countries have furthered it. Such work in America centers largely in the Eugenics Record Office on Long Island, and in the Eugenics Research Association. The success of the whole movement depends first on accumulating a much larger fund of information concerning human heredity and second on a consummate wisdom in its use.

Much more advanced is the application of laws of heredity to such economic ends as the improvement of domestic animals and farm crops. The work in this field constitutes a sizable industry, largely under Federal and state management, for the benefit not only of agriculture but of all who use its products.

PROBLEMS

1. Why would particulate inheritance provide for more sharply defined variation of a species than would blending inheritance?
2. Why would a cultivated plant be likely to meet Mendel's requirements for experiments better than a wild species would?
3. Why would a parthenogenetic species, not known to be such, mislead a geneticist who used it in attempted crosses?
4. With what new advance in knowledge would you say modern genetics began?
5. What are the characteristics of an animal or plant species that would make it good material for the study of heredity?

CHAPTER 2

CELLS AND THEIR ORIGIN

In his search for the physical basis of heredity the geneticist must look far deeper than ordinary anatomy. Organs and tissues are of little service, except occasionally in throwing light on the mechanics of development. The cells of which these grosser structures are composed are the largest units with which genetics must usually deal. Even the cells are too large and inclusive to be of prime significance in most problems of heredity; it is their minute components that are most revealing. Some of these components are readily visible with a microscope, but the most important ones are near or beyond the limits of visibility even with such optical aid.

Cells are everywhere. Plants are composed of them throughout roots, stem, leaves, flowers, and fruit. Every tissue of animals is built of cells, and every activity is traceable to them. Muscle, bone, skin, glands, all are cellular. Blood, though largely liquid, contains hosts of cells that determine some of the most important properties of the circulating medium. Coordination of the many activities of an animal depends upon conduction of impulses by cells in the nerves, and mental processes depend upon brain cells. Even such dead structures as hair and nails are made of cells that were once alive. All development from seed or egg involves cells, and every stage, young or old, of plant or animal, is composed of these structural units.

Whatever inherited quality is under scrutiny, cells have made it what it is. And no matter what phase of hereditary transmission is examined, cells are found to be guiding and effecting it.

The Nature of Cells.—These cells are composed of a material known as protoplasm, nearly colorless, of a jellylike consistency, and comprising a mixture of proteins, carbohydrates, lipids, salts, and water. Of the several classes of organic compounds named, the proteins are most important in heredity. The proteins are built up of one or more of the 25 amino acids, in various proportions and arrangements. Because of this chemical structure, proteins are very complicated; they may be and are, therefore, of very many different kinds. Moreover, in their chemical relations proteins are very specific, that is, they do

certain things with great precision and other things not at all. These two properties of proteins, their great specificity and their complexity of structure, are what make them so significant in living things. Because of them organisms can be of an enormous number of different kinds and can maintain these different kinds with a high degree of persistence.

Somewhere in the midst of the protoplasm of a cell is almost always a *nucleus* (Fig. 4), the important component of which is a quantity of scattered protein material of a variety of kinds, collectively called the *chromatin*. The nucleus also contains a liquid, in which the chromatin

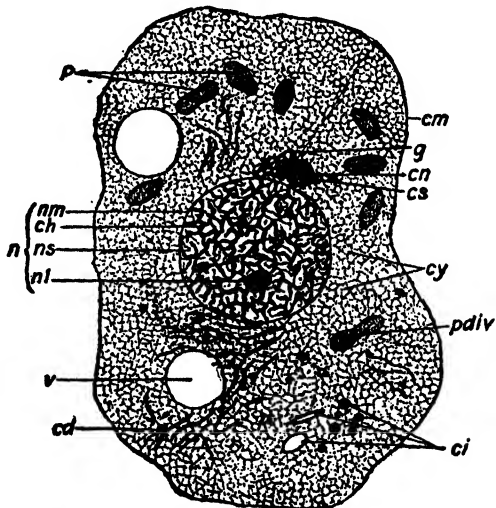

FIG. 4.—A generalized cell. *cd*, mitochondria; *ch*, chromatin; *ci*, lifeless inclusions; *cm*, cell membrane; *cn*, centriole; *cs*, centrosphere; *cy*, cytoplasm; *g*, Golgi apparatus; *n*, nucleus; *nl*, nucleolus; *nm*, nuclear membrane; *ns*, nuclear sap; *p*, plastids; *pdiv*, plastid dividing; *v*, vacuole.

floats; there is often another body called the *nucleolus* in this fluid; and the whole is marked off from the protoplasm outside by a thin membrane whose tension tends to keep the nucleus round.

In the outer protoplasm, called *cytoplasm*, are usually other structures. Frequently, especially in plants, there are *plastids*, colored green as in leaves, red or yellow as in some fruits and flowers, of other colors or colorless in various other situations. Many cells also contain *vacuoles*, droplets of enclosed liquids, having various uses or being merely incidental. There are probably always, also, rodlike, threadlike, or granular bodies of mainly lipid composition, known as *mitochondria* or *chondriosomes*. Finally, in many cells there are lifeless

objects, either produced by the cells themselves, such as starch grains or fat particles, or taken in from the outside and having no real part in the activities of the cells.

Of the cell structures mentioned, the chromatin of the nucleus is by far the most important in heredity. Reasons for this conclusion and details concerning the relations of the chromatin to genetic processes are presented in many places in later chapters. Of the cell contents outside the nucleus, the plastids have an important relation to the heredity of color in plants, on a basis very different from that of the chromatin. Some biologists have also suggested that mitochondria have a function in heredity, but there is little to indicate any specific connection of this sort.

The cells of a multicellular organism operate in a partnership. No cell works by itself. Every cell is influenced by others around it or even at a distance from it. In embryonic development a great deal depends on how the cells are placed relative to one another. A chain of events leads normally to a certain end result, but, if any part of the mass of cells is artificially misplaced, the succeeding changes may be profoundly modified. Place a section of the early nervous system anywhere else than in the middle of the back, and a double monster may result. The growth of bones responds to pressure such as is exerted by adjoining bones; their internal structure is gradually braced against that pressure. Mental qualities whose variations are inherited depend largely, not on individual brain cells, but on how those cells are joined to one another. Probably nowhere in multicellular animals does anything of importance depend solely on the nature of individual cells, but it does depend in part upon interrelations among cells.

Germ and Somatic Cells.—In the many-celled animals there are two classes of cells, fundamentally different from each other in their relation to heredity. The somatic or body cells are directly responsible for the actual manifestation of inherited characters but have nothing to do with transmission of them except in primitive types of reproduction. The germ cells, on the contrary, have everything to do with transmission from generation to generation in the higher forms of reproduction but are not at all directly responsible for the expression of most of the characters inherited.

The two kinds of cells are connected in animals in a very important unilateral genetic way. The germ cells of animals give rise in every generation to somatic cells, as well as to more germ cells. But the somatic cells do not produce germ cells, or do so only very rarely, in

animals. The germ cells thus constitute a reserve out of which the genetic continuity of the germ cells and the repetition of the production of bodies in each generation are maintained. This sharp distinction between the two classes of cells has very important consequences in the theory of heredity.

Production of New Cells.—New cells are produced only out of old ones, by division. This process contains the key to two groups of facts that are very significant in heredity. First, it shows why all the cells of a multicellular organism must be expected to be genetically

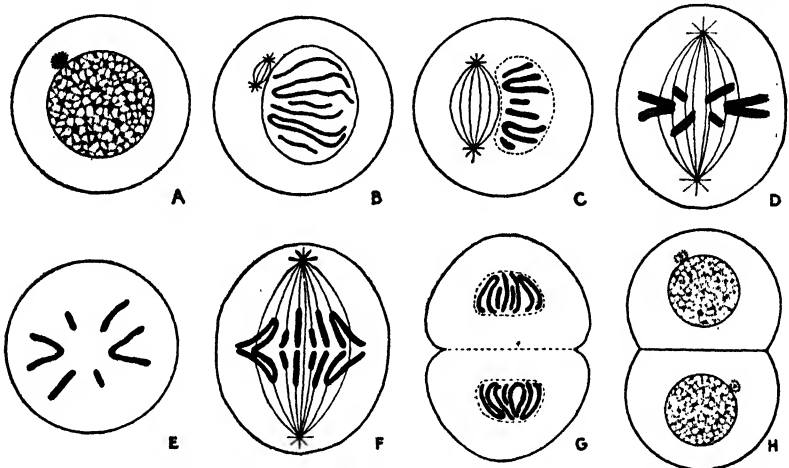

FIG. 5.—Cell division. *A*, cell not dividing, ordinary nucleus with divided centriole at its upper left; *B*, chromatin of nucleus resolved into chromosomes, spindle forming at left; *C*, nuclear membrane dissolving, spindle enlarged; *D*, duplication of chromosomes, now located on middle of spindle; *E*, same stage as *D*, but viewed from end of spindle so duplication of chromosomes is not seen; *F*, duplicated chromosomes moving or being drawn to opposite ends of the spindle; *G*, chromosomes beginning to form nuclei, cell body beginning to divide; *H*, two cells completely reconstructed.

alike, at least in their beginnings. Second, it discloses some features of the constitution of cells which even the closest examination of them at other times does not reveal—features which bear very directly on the operations of heredity.

The general procedure in the production of new cells in animals is as follows. The chromatin in the nucleus, which at other times appears scattered, becomes assembled into several strands or ropes of various lengths, which are called *chromosomes* (Fig. 5, *B*). Outside the nucleus there is formed a spindle-shaped figure with a star at each end. This spindle lies beside the nucleus, whose surrounding membrane now is dissolved away, allowing the chromosomes to move over into the midst of the fibers of the spindle (Fig. 5, *C*).

About this time each chromosome is seen to be double (*D*), that is, each chromosome has produced a new chromosome which is an exact replica of itself. These identical chromosomes are then drawn apart, as if being pulled apart by some of the fibers of the spindle (*F*). One of the two similar chromosomes produced by each duplication process goes to each end of the spindle, so that two groups of chromosomes, identical with one another and with the original chromosomes, are placed at opposite poles of the cell (*G*).

Here each group becomes surrounded by a new nuclear membrane, the chromosomes become diffuse again, and the body of the cell becomes furrowed, then completely divided, between the new nuclei (*H*). Two new cells have replaced the old one.

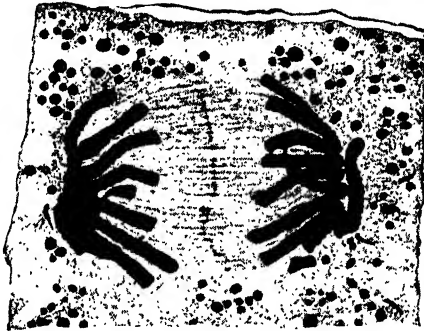

FIG. 6.—Formation of dividing wall in plant cell. (From W. Robyns, in Seifriz, *Protoplasm.*)

Duplication of plant cells usually differs from that just described in an unimportant respect. In the division of the cell body between the new nuclei, there is no furrow from the outside. Instead, a row of pellets is deposited across the middle of the cell (Fig. 6). These knots, as they grow, merge and form a wall that separates the two new cells.

Pattern in the Chromosomes.—To grasp the importance of cell division, one must know the minute architecture of the chromosomes. Fortunately, this finer construction may be observed in favorable types of cells and is to be inferred in others that do not reveal their organization so directly.

Each chromosome is made up of a chain of minute bodies (the *chromomeres*) strung like beads on a fine thread or imbedded like boulders in a very slender stream. Some of these beads can be seen when the chromosomes are long and exceedingly slender threads, as they are when the first condensation of the chromatin takes place preparatory

to cell division. The chromosomes are greatly extended then, and the nodules are relatively far apart, so that they are separately visible. The visible beads on these strings are of many different sizes (Fig. 7), and there are sound reasons for believing that many others, probably also of different sizes, are too small to be seen. Presumably, also, they have different chemical compositions, which is more important. Though some of these little pellets may be just like others in the same chromosome, they have been proved to be in the main different from one another.

These motley particles have a definite arrangement in their respective chromosomes. To make the portrayal concrete, picture the first one at the end of a chromosome as a large one, followed by several of

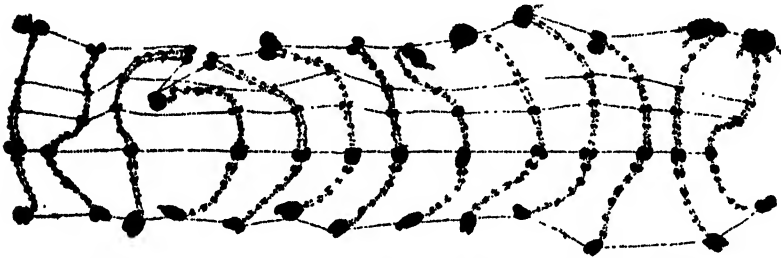

FIG. 7.—Pattern of chromomeres of different sizes in one of the chromosomes of a grasshopper. The chromosomes are in pairs, from 13 different individuals. The horizontal dotted lines pass through homologous chromomeres. (Modified from *Wenrich*.)

minute but different sizes and then by one of medium volume. After this there are several small ones, two large ones in close succession, a few small ones, then a medium and several small ones, again a medium and a large one, and so on. An actual pattern, somewhat different from the hypothetical one just described, is shown in Fig. 7. While there may be only several dozen visible chromomeres in a given chromosome, their total number, including those too small to see, must usually amount to hundreds. All of them, there is good reason to assume, have as definite a pattern of arrangement as do those which can be seen.

Now, every cell of an organism has in it a chromosome of the same design. Particle by particle, from one end of the chromosome to the other, the same order of sizes is followed in one chromosome of every cell. Indeed, there are usually two chromosomes having this same pattern in every cell of the same individual. Moreover, this same arrangement of particles is found, with minor modifications, in every individual of the same species. In Fig. 7, each pair of chromosomes

shown came from a different cell, even from a different individual. The similarity of their patterns is indicated by the dotted lines passing through corresponding nodules.

Individuality of Chromosomes.—All the other chromosomes in the cells are different from these two. Two of them are alike in their pattern of beads, but different from all the rest. Two more are alike in pattern, but it is a different pattern from that of any other two chromosomes. In this manner, each chromosome is twin to another. Each chromosome is like one other, but different from the remaining ones.

The chromosomes thus possess an individuality, which, however, is shared between twins. They could very well be named, just as people are named. All the chromosomes having a given pattern of their constituent chromomeres might be called A, whether in one cell or another, and no matter in what individual of the species. A chromosome of another pattern could be designated B, wherever it occurred, in different cells or different individuals. A third pattern might be called C, and so on. Thus, the chromosomes of a cell, of an individual, or of a species, would consist of two A's, two B's, two C's, and so forth.

It is possible that some of the minute globules that are strung along chromosome A may be identical with some in chromosomes B or C. Indeed, from a consideration of the way in which chromosomes have evolved, it is to be expected that there are some such repetitions. That is not, however, an important fact for the present. Since a given particle in one position has been shown to have an effect different from that of the same particle in another position, the chromosomes may be regarded as wholly different except as between twin chromosomes.

The two chromosomes that are alike are called homologous chromosomes from the fact that they must have evolved from the same source. Two A's are homologous with one another, even if they come from different individuals; two B's are homologous; and so on.

Significance of Cell Division.—The importance of the method by which a cell divides should now be apparent. When the chromosomes are doubled, each nodule which the chromosomes contain is duplicated. Since the nodules are of different sizes and different chemical compositions from end to end of each chromosome, only a duplication of each pellet would effect a genuine duplication of the chromosome. Furthermore, since the chromosomes in each cell differ among themselves (except homologous chromosomes), any other method than the one actually employed, of duplicating each chromosome and carrying one of the resulting two daughter chromosomes to each of the new cells at each division, would yield two dissimilar cells instead of two alike.

The value of this duplication, part by part, in maintaining a combination of living structures which is successful—which had to be successful in order to survive—can hardly be overestimated. An scheme of cell division that freely permitted one cell to be different from the other cell arising at the same division would lead to wasteful chaos. Insofar as this regularity is maintained, every cell in a multicellular organism ought to have the same constitution as every other cell in the same individual. That is, muscle, nerve, bone, gland, and blood cells should be genetically alike. Whether they do maintain this similarity indefinitely has been debated, but cell division appears not to be an agency by which they might become different.

This is not to say that irregularities never creep into cell division. Occasionally, after a chromosome has become duplicated, both of its daughter chromosomes go to the same cell, while the other cell lacks a chromosome of that identical constitution. Such failure of chromosome duplicates to go to different cells is called *nondisjunction*; certain special genetic phenomena are dependent upon it.

Division of Plastids.—Since some of the inherited characters of plants, such as variegation of leaves, are due to the plastids, it is worth while to point out that these structures are autonomous in their multiplication. That is, their increase in numbers is not in any way dependent on the duplication of chromosomes and has no necessary connection with the process of cell division. Plastids multiply by simply dividing in two, in a manner analogous to vegetative or asexual reproduction of simple organisms, described in the next chapter. This division results in two identical plastids each time, but the rest of the cell is in no way involved. Plastids may go on dividing when the cell as a whole, including its chromosomes, is not dividing; and plastids do not have to divide when the cell divides. At cell division, some of the plastids are located in one daughter cell, some in the other. If the plastids are of two or more kinds, there is consequently no assurance that the two cells produced by cell division will be equivalent with respect to them. In this feature they differ from the chromosomes.

PROBLEMS

6. What feature of chromosomes makes it important that, in cell division, they be divided lengthwise rather than crosswise?
7. Would you expect the two cells produced by division of one to be identical with respect to their plastids? Why?
8. What would be the danger of frequent occurrence of nondisjunction?
9. What do you understand by "individuality of chromosomes"? What would make them possess individuality? What circumstance would cause them to lack individuality?

CHAPTER 3

ORIGIN OF NEW INDIVIDUALS

Since heredity involves continuity between generations, the manner in which new individuals are produced exercises a fundamental influence upon the nature of transmission. Some forms of reproduction tend to preserve, unchanged and alike, all individuals belonging to a given line of descent. Other forms contribute materially to the variability of the species, that is, to the differences among individuals, even among those closely related. The proneness to constancy or the tendency to change is the chief feature of a mode of reproduction that concerns the student of heredity; all other elements of the process are minor.

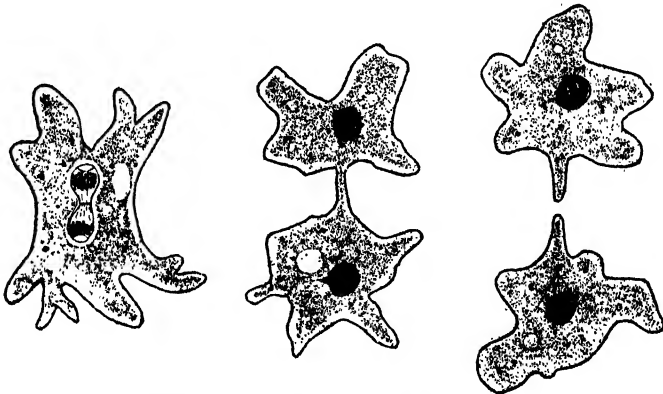

FIG. 8.—Fission, or asexual reproduction, in *Amoeba*. The chromosomes shown in the first figure suggest that the division is a qualitatively equal one.

Asexual or Vegetative Reproduction.—Any form of reproduction in which a considerable fraction of the parent goes over into each of the offspring offers an excellent opportunity for the individuals of both generations to be similar. *Fission*, or the nearly equal division of the parent, is employed by many of the unicellular organisms. In *Amoeba* (Fig. 8) the cell simply divides into two. The nucleus of *Amoeba* is resolved into minute bodies that may be likened to chromosomes. If these bodies are duplicated during fission, then the two *amoebae* produced should be as much alike as are the two cells resulting

from cell division in multicellular organisms. In *Paramecium*, there are two nuclei, a large one and a small one. In fission, the small nucleus forms minute chromosomelike objects, but the large one does not (Fig. 9). However, the large nucleus is not very important in this connection since it periodically disintegrates and is replaced by pieces of the small one. Consequently, in the long run, fission in *Paramecium* is of a type that appears to provide equality of the two cells produced.

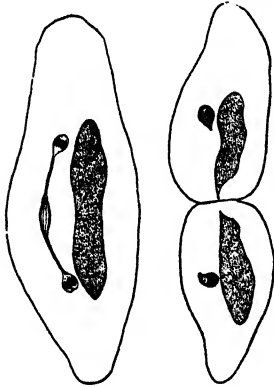

FIG. 9.—Fission in *Paramecium*. Only the small nucleus has any long-term importance in reproduction. Its chromosomes indicate that the division is probably a qualitatively equal one.

When the division of the parent is very unequal, reproduction is usually called *budding*. This name is particularly appropriate when a small portion of the parent must first be protruded before it is pinched off. *Hydra* commonly reproduces in this way. The body wall of this animal consists of two layers of cells, and when a new individual is to be produced this wall is simply elevated

like a hollow haycock. The protrusion is extended (Fig. 10), develops subsidiary protrusions for tentacles, opens a mouth among the bases

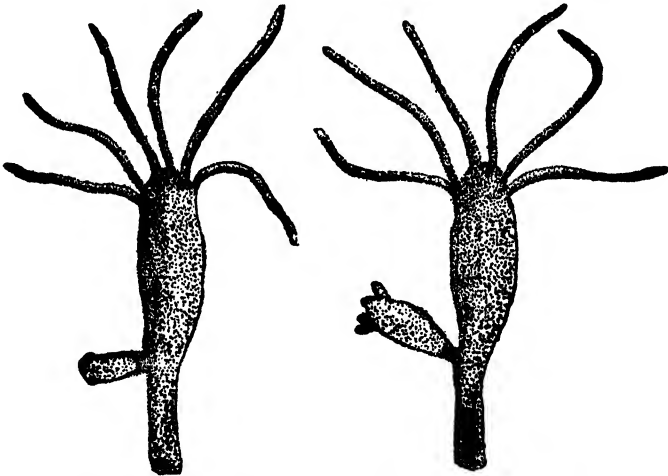

FIG. 10.—Asexual reproduction in *Hydra*; two successive stages of budding.

of the tentacles, and then is pinched off. Since the cells which enter into the bud have been produced by the duplicating method of cell

division described in the preceding chapter, they are presumably like all other cells in the body. Consequently, the offspring would be expected to be identical with the parent.

In some forms of asexual reproduction, small groups of cells (variously called *gemmules* or *statoblasts*) are separated off from the body. In some organisms single cells are thus set aside for reproduction. These cells are generally called *spores*. Whether these types of reproduction conduce to similarity among individuals depends on the nature of the divisions by which the reproductive cells are produced. Gemmules and statoblasts give every sign of leading to stability; some kinds of spores are likewise genetically equivalent to the plant which produces them.

Variability and Asexual Reproduction.—Though it is usually expected that no difference between parents and offspring will arise in asexual reproduction, that expectation is based chiefly on the fact that vegetative reproduction stems originally from what seems to be ordinary cell division, and such division appears to result in equal cells. What other evidence is there relating to this anticipated stability? Certain unicellular organisms have been bred for many generations and watched for changes. Very few have occurred. In some such investigations no modification whatever has been detected. In a few studies, new types of individuals have occasionally arisen.

Do these occasional modifications indicate that, after all, asexual reproduction is not the conservative process it seems to be? Probably not. So far as the qualities of the organisms are determined by their chromatin, the changes are presumably of the nature of mutations, which constitute the basis of much of evolution. These mutations do not depend on the type of reproduction. They are changes that would occur in some individuals whether they reproduced or not. In other words, reproduction is not causing them.

If any differences were displayed in the cytoplasm, in structural or physiological units that multiply autonomously and maintain their characteristics independently of influence of the chromatin, an irregular segregation of these should take place, and dissimilar lines should arise, in asexual reproduction. Aside from plastids (page 12), there is little evidence of the existence of such autonomous units, and differences dependent on other things have usually proved temporary.

Biparental Reproduction in Higher Animals.—In typical sexual reproduction two parents are involved. These parents are differentiated in the higher animals into sexes which are structurally different, not only with respect to the reproductive organs but in other ways

as well. Both sexes in the higher animals produce germ cells. In the females these germ cells are relatively large and passive, and are called *eggs*. In the males the germ cells are very small and actively motile, and are called *spermatozoa* (or sperm). Typical germ cells are shown in Fig. 11, at very different magnifications.

Egg and spermatozoon are in some manner brought together, and they merge into a single cell, cytoplasm with cytoplasm, nucleus with nucleus. This union is known as *fertilization* (Fig. 12).

From the fertilized egg, by a series of cell divisions and changes of shape, a new individual is produced.

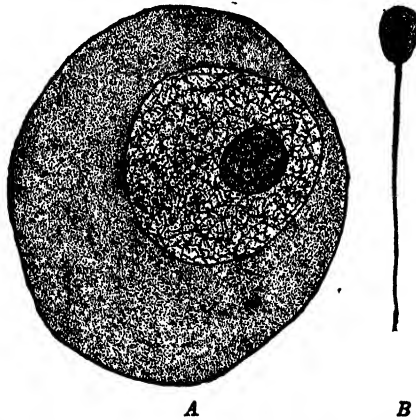

FIG. 11.—Typical germ cells. A, egg of starfish magnified $\times 500$; B, spermatozoon of rabbit magnified $\times 4000$.

What Is an Egg?—Since in some forms of asexual reproduction the new individual starts from a single cell, a spore, it is important to know the distinguishing marks of germ cells in sexual reproduction. The spermatozoa would never be mistaken, for they have a peculiar form not imitated by any other kind of cell, though that is not their real distinction. The eggs, however, have a shape that many other cells take. Hence, concerning them the question may often arise whether they are eggs, and if so, what makes them such.

The crucial feature of both egg and sperm in animals is that the cell has undergone a process known as *meiosis* or *maturation*. In typical meiosis the cell experiences two rapidly succeeding divisions. The two cells produced at each division are very unequal in size in the case of eggs, one being very small. Maturation of an egg is represented along with fertilization in Fig. 12. In A of that figure, one of the two divisions has taken place, the small cell being shown at the top. In B,

both divisions have been completed, and there are two small cells at the top.

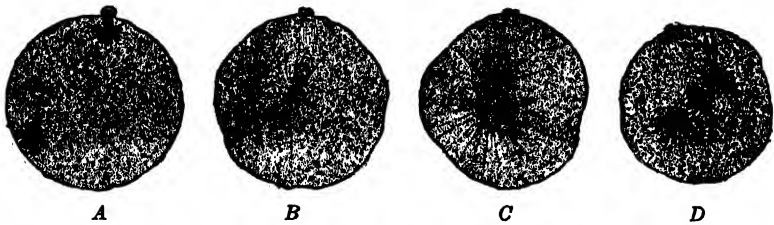

FIG. 12.—Fertilization of an egg. *A*, entrance of spermatozoon at lower left; *B*, the egg nucleus and sperm nucleus approach one another; *C*, the two nuclei are side by side; *D*, the nuclei have merged, and their chromatin is being resolved into chromosomes preparatory to the first division of the fertilized egg. The figures also represent meiosis or maturation; at the top are the two small cells produced in the two meiotic divisions.

In the course of these meiotic divisions the number of chromosomes is reduced to half. The final egg or spermatozoon has only one chromosome from each set of chromosome twins. This is an exceedingly

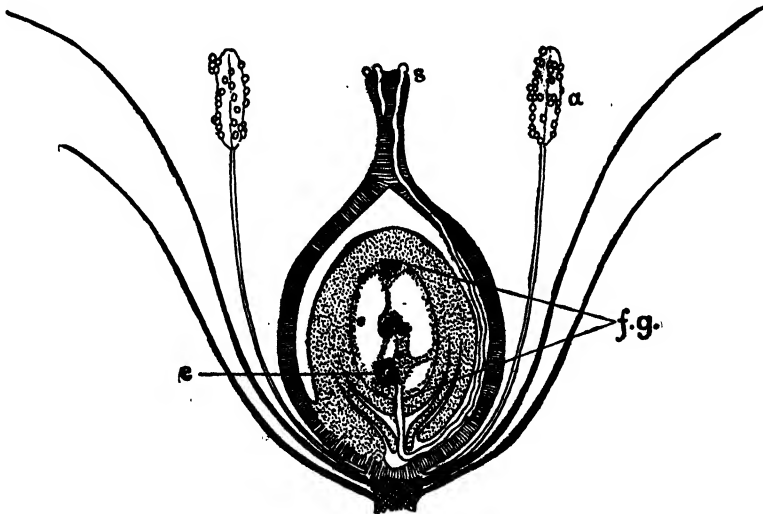

FIG. 13.—Diagrammatic section through a flower; *a*, anther; *e*, egg; *f.g.*, embryo sac; *s*, stigma. The white channel down from the stigma is a pollen tube. One male nucleus is the dark body at the right of the egg; the other male nucleus is at the right of two other nuclei in the middle of the embryo sac. (From Sinnott and Dunn, *Principles of Genetics*.)

important feature of a true germ cell. How the chromosome number comes to be thus reduced is described more fully in a later chapter.

Biparental Reproduction in Higher Plants.—In flowering plants the male and female germ cells are often produced on the same plant, com-

monly in the same flower. Such a flower is diagrammatically represented in Fig. 13. The egg is one of eight cells forming an ellipsoidal mass (the embryo sac, *f.g.*), each cell of which has only the reduced number of chromosomes. That is, what corresponds to meiosis occurs early, and the reduced cell then divides until eight cells are formed, one of them being the egg (*e*).

The male cells in flowering plants are produced in the anthers (*a*). The entire pollen grain is composed of cells which have the reduced number of chromosomes. Two of these reduced cells are male cells. To function in reproduction, the pollen must fall on the stigma (*s*) of some flower and develop a tube (Fig. 14) down through the stigma,

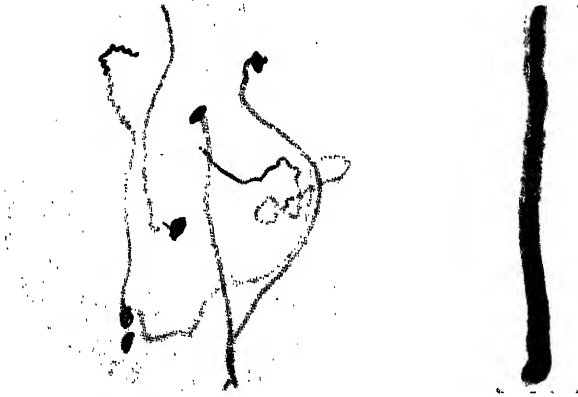

FIG. 14.—Growth of pollen tubes. Left, pollen germination on artificial medium. Right, tip of one pollen tube, with tube nucleus (lightly shaded) followed by the two male nuclei. (Courtesy of General Biological Supply House.)

style, and other tissues until it reaches the egg. The two male cells pass down this tube, usually near its growing tip. One of them fertilizes the egg, and from the combined cell an embryo develops. The other male cell unites with usually two other cells near the egg (in the middle of the embryo sac), and the triple product forms the endosperm or nutritive part of the seed. These two fertilizations are in progress in Fig. 13. When the seed germinates, the embryo feeds on the endosperm until it can begin to secure its nutrition from the air and soil.

Biparental Reproduction in Protozoa.—With this outline of sexual reproduction in the more complex animals and plants in mind, it will be possible to understand the corresponding processes in unicellular organisms more readily. Paramecium must suffice as an example of sexual reproduction in the protozoa; most of these simple animals

probably employ this method along with the asexual one already described.

The really sexual part of this reproduction consists of *conjugation*, in which two paramecia come together side by side (Fig. 15). These two individuals are alike, that is, they are not distinguishable as male and female. Of the internal events, only those concerning the small nucleus are of importance. This nucleus divides several times, part of the process resembling the two divisions which constitute meiosis in higher animals, including a degeneration of some of the nuclei until only two of them are left. The two surviving nuclei are slightly different (Fig. 15), and one may be regarded as male, the other as female. The male nucleus of each individual creeps through the now nearly fluid walls of the animals into the other individual and there fuses with the female nucleus.

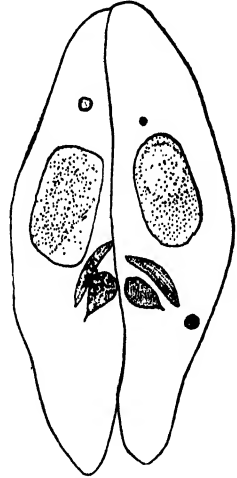

FIG. 15.—Conjugation in *Paramecium*. The spindle-shaped (male) small nucleus just below the middle of each individual migrates into the other animal and fuses with the pear-shaped (female) small nucleus there. From the combination nucleus the nuclei of subsequent generations are derived.

By the repeated division of this combination nucleus and the division of the body as a whole, offspring are produced which descend from both of the conjugating paramecia.

Variation in Relation to Sexual Reproduction.—As was indicated earlier in this chapter, typical sexual reproduction leads to differences among the offspring and differences between them and their parents. This is true wherever such reproduction occurs, whether in complex animals, flowering plants, protozoa, or any other organisms.

The reason for this variability lies in the events of meiosis. The germ cells when mature have only half of the chromosomes of the individual that produces the germ cells. In making up this half group of chromosomes, one member is drawn from each of the pairs of homologous chromosomes. Now, if the paired chromosomes were identical in their composition, the reduction in the number of chromosomes by this very regular selective method would not result in variability. All germ cells of one individual would be alike. But the chromosomes need not be identical. In animals they are very seldom entirely alike, and in plants they are often different in some respect. Homologous chromosomes are similar but not usually identical.

Under these circumstances, drawing one chromosome of each pair for inclusion in a germ cell gives room for much variation in the various cells. The nature of a germ cell depends on which of the two chromosomes it has received from each pair. Differences among the germ cells lead to differences among the offspring and to differences between offspring and parent.

Parthenogenesis.—In some animals and plants an egg may develop into a new individual without having first been fertilized by a spermatozoon. Such development is known as *parthenogenesis*. Several

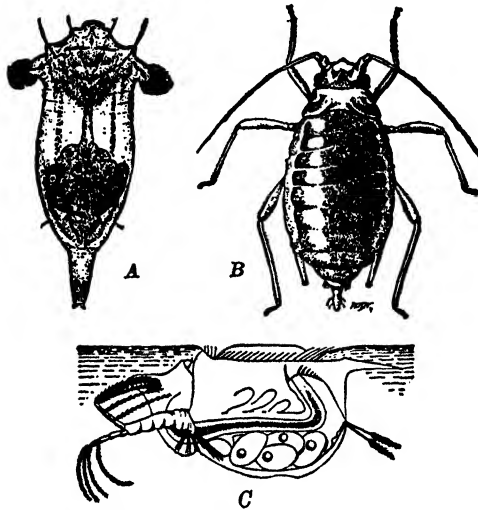

FIG. 16.—Parthenogenetic animals. *A*, a rotifer; *B*, an aphid or plant louse; *C*, a crustacean, suspended from the surface film of water, and showing several parthenogenetic eggs in the brood chamber below. (*A* from Herring, *Canadian Arctic Expedition*; *B* from Webster, *U. S. Department of Agriculture*; *C* after Storch in Schulze's *Biologie der Tiere Deutschlands*.)

groups of animals employ this method as their principal mode of reproduction (Fig. 16), and in some species it is the only method known. Offspring produced in this way have only one parent, as do offspring produced asexually, so that many decades ago, when the nature of the process was not understood, animals now known to be parthenogenetic were said to reproduce asexually. However, the parent which reproduces parthenogenetically has a structure similar to that of typical females in related species, and the cell which develops into a new individual has undergone a process similar to if not identical with typical maturation. Consequently, the parent is regarded as a female, her reproductive cell as an egg, and the mode of reproduction as sexual even though uniparental.

Variation in Relation to Parthenogenesis.—Whether parthenogenesis results in different kinds of offspring from the same parent depends on the type of maturation that the egg has experienced. If the maturation is typical, in that it involves two cell divisions and the number of chromosomes is reduced to half, the eggs should be of various

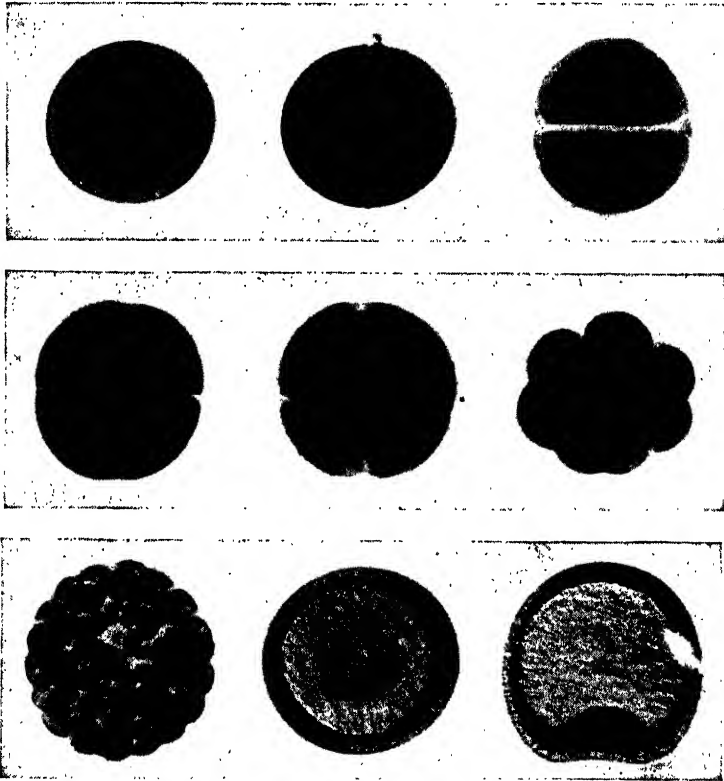

FIG. 17.—Development of the starfish. First figure, immature and unfertilized but fully grown egg (primary oöcyte); second, maturation stage, showing polar body; next five, successive cleavage stages; eighth, blastula; ninth, beginning of gastrulation. (Courtesy of General Biological Supply House.)

kinds, and the individuals produced from them should differ among themselves, much as in biparental reproduction. The eggs of the honeybee, ants, wasps, and many other similar insects undergo this typical maturation and display the expected variability.

In some other animals, including all those in Fig. 16, however, the egg is produced as a result of only one maturation division, and the chromosomes are not reduced. There is no choice, therefore, among

the chromosomes when the egg is constituted. Each egg receives a duplicate sample of every chromosome that the female herself possesses. The offspring derived from such an egg is genetically identical with the parent, and consequently identical with all other offspring of the same parent. Breeding tests in such parthenogenetic species have generally shown that the individuals of one strain are all alike. Heredity in animals of this latter parthenogenetic type is largely ignored in this book, since man and most of his economic animals and plants reproduce by the typical sexual method, which entails variability.

Development of New Individuals.—When an egg is fertilized, the production of a new individual has just begun. The fertilized egg divides into two cells, these two by simultaneous divisions into four, and so on by repeated divisions until hundreds of cells are produced (Fig. 17). The details of this cleavage vary in different species, depending on the amount of stored food the egg contains, on how closely the cells cling to one another, and on other things. Always, however, it leads to the formation of a hollow ball of cells, the *blastula* (Fig. 17).

The single layer of cells around the hollow of the blastula then becomes a double layer, typically by an indentation of the cells on one side. In many of the simpler animals this inturning is like that in Fig. 18, *A*, the result being a two-layered structure (*B*). The outer layer is the *ectoderm*, the inner one the *endoderm*, the whole structure the *gastrula*. Another layer of cells is soon formed between these two.

Organ Formation.—From each of these layers certain organs or tissues are typically formed. Nearly always there is a folding or protrusion of the layer, either inward or outward, usually a branching of the fold or pouch, and an infiltration of cells from one of the other layers among the branches. With great regularity the development of an organ occurs at the same spot, and in the same manner, in all individuals. The liver of a vertebrate animal starts as a protrusion of the wall of the digestive tract just behind the stomach, the nervous system as a pair of ridges over the back, and the ears as pits sunk in from the outside in the head region. All these organs are inherited, and somehow the course of development is guided in a rather fixed way from beginning to end. The complexity of the changes in the embryo indicates a rather elaborate system of controls.

The feature of all this process that is of most concern to the student of heredity is what may be called organic determination. What causes one part of an organism to become one thing, another part something else? Ultimately, the heredity units or *genes* must be responsible,

since one egg becomes a starfish, another a snail, in the same sea water. There is, however, a long interval between the egg and those characters, mostly in the adult, whose differences in different individuals reveal differences in the heredity units. What happens in this interval, to lead so faithfully to a given end result? Only a few parts of the answer to this question are known.

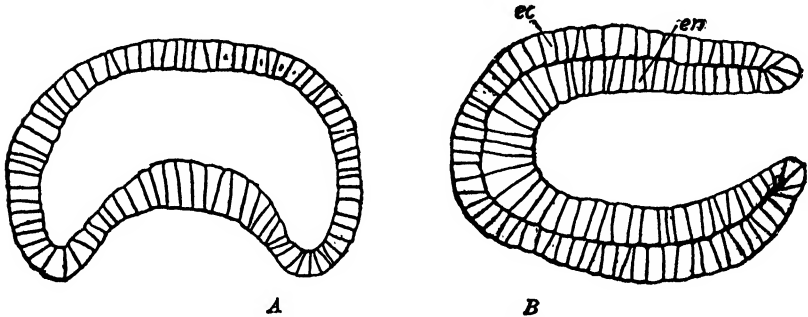

FIG. 18.—Gastrulation in amphioxus; two stages, early (A) and late (B). *ec*, ectoderm; *en*, endoderm.

Cytoplasmic Influence.—Cleavage of the egg follows a pattern that is frequently different in different species. The spindles of the dividing cells take certain positions in the cells so that the two cells resulting from the division have a fixed spatial relation to one another. It is possible, in such early blastulas, to say which cells were produced by one division, even when the division has not been observed. Lines of cell descent have been mapped in a number of such organisms.

When two species having different patterns of cleavage are crossed, the fertilized egg follows the pattern which it would have followed had it been fertilized by a sperm of the same species. That is, the type of cleavage is determined by the cytoplasm, practically all of which comes from the mother. This one-sided influence is lost before the hybrid begins to produce eggs, one generation later, for by that time the cytoplasm has been modified under the influence of the genes from both parents.

Symmetry.—Among higher animals the body usually possesses a bilateral symmetry, in that one half of it is a mirror reflection of the other. What determines the position of the plane between these halves? The egg often is spherical and has at the outset no observable symmetry to which the future body could be related. In some frogs, the plane of symmetry usually coincides with the first cleavage plane, that is, the plane between the first two cells derived from the egg. This

plane passes through the two so-called poles of the egg, and in some frogs through the point of entrance of the spermatozoon which fertilizes it. In many other animals, however, there is no known relation of symmetry to cleavage.

Organizers.—The exactitude of cell division, with its duplication of the genes in the chromosomes, leads to the assumption that all the cells of an individual are genetically alike. Why, then, do some of them produce a nervous system, some a gill, some a heart, etc.? In general, it appears that the position of the cells in the whole embryo has an important influence on their fate. If their position is changed, their destiny may be altered. For example, if two patches of cells in the ectoderm of a salamander embryo, one from an area which would normally form part of the gills, the other from the place where a nervous system develops, are removed and each is inserted in the place of the other, the cells which would ordinarily become gill tissue become nervous system, and those which would naturally be nervous system become gill. Something about the place occupied by the cells helps decide what they shall be.

The nervous system is caused to develop by the cells of the mesoderm beneath. If some of these mesoderm cells are taken out and inserted beneath the ectoderm at some place along the side of the body, an extra nervous system develops in the ectoderm over them. This influence of the mesoderm is exerted by some substance which the mesoderm cells contain. The mesoderm cells did not always possess this substance; they must have developed it, perhaps under the influence of some other cells, at an earlier stage. The substances that exert such influences have been called *organizers*. It is likely that much of embryonic development depends on them for guidance.

Time of Determination.—It is clear, from the account of organizers just given, that the fate of different parts of an individual is fixed at different times. There is perhaps not just one time at which an organ or tissue has its destiny settled, since in the chain of events leading up to its formation one agent may modify it at an early stage, another agent at a later stage. Nevertheless, taking into account the influences that are normally exerted, some organs pass the stage at which modification is possible earlier than other organs pass that point. That is, some structures are "determined" earlier than others. In moths, for example, the reproductive system is determined early, the antennae late.

When the influences that bear on development, be they external ones like temperature or internal ones like the organizers, change at a

particular time of development, they are able to influence those structures whose nature has not yet been fixed, but they are too late to modify those parts which have been determined before that time. Thus the mere time at which something happens has an important consequence in directing the course of development. This time of occurrence of an event depends, in turn, on the rate of development of something leading up to it. Rates of development may be different at different stages, and the same agency (temperature, for example) may modify the rates of development of different organs unequally. This unequal effect on rates of development is no doubt one of the mechanisms by which environment influences embryogeny.

Autonomy in Development.—To what extent cells in an embryo or other immature individual develop under the guidance of something which they themselves contain (their genes, for example) and how much they are influenced by other cells around them, or by body fluids whose nature may be determined by many parts of the organism, has been one of the fundamental problems of embryology. In vertebrate animals there is a great deal of mutual influence of part upon part, through the agency of chemical substances which are carried about by the blood or which diffuse from cell to cell. In insects, on the contrary, there is usually a considerable degree of autonomy; that is, cells or groups of cells become what the genes in them determine. The vinegar fly *Drosophila* illustrates this feature admirably. If the rudiment of an eye which would be brown in the adult is introduced into a larva whose eyes are to be red, the transplanted eye still becomes brown. Twenty other eye colors are similarly autonomous. Two exceptions are the colors cinnabar and vermilion; eyes scheduled to develop these colors are modified if transplanted into wild-type larvae whose eyes become red.

Genetic Identity of All Cells in Individuals.—Although as suggested earlier the manner in which cells divide leads one to conclude that all cells in one individual contain identical genes, and most biologists have so concluded, there remains a possibility that some mutation of genes occurs as a part of embryonic development. One competent geneticist has pointed out a situation in which such developmental mutation would provide a simple explanation of observed phenomena. Wright has suggested that certain spotted color patterns in mammals are due to the change or mutation of pigment genes at definite places in the body, after a regular scheme and in response to some physiological gradient.

Gradients are known in development, a very widespread one being

the anteroposterior graduation of time or rate of development. In many animals development starts earlier at the anterior end than at levels farther back. The embryo of a vertebrate animal produces its first muscle segments well forward, while new segments are added successively behind them. A crayfish embryo develops its front appendages earlier than its posterior ones; and, at any given stage until their development is complete, the front ones are more advanced than the posterior ones. Some other gradients are known, and they are probably quite common. Even if such gradients do not induce mutation, they may exert an influence of a nongenetic sort on development, which would be on a par with organizers in general.

Convergence of Genetics and Embryology.—The preceding sections probably contain as much as can profitably be said concerning developmental determination in advance of a full presentation of the mechanism of heredity. The examples used will serve to illustrate the types of problems with which the embryologist is confronted. It should be evident that the experimental embryologist, with transplantation as a tool, and the geneticist, using now the same method but with a more minutely analyzed background of comparison, are converging upon the answer to the same question: What makes organisms what they are?

PROBLEMS

10. Under what circumstances does a parent disappear when it reproduces?
11. In animals, how does the parental contribution to its offspring in asexual reproduction compare in size with the corresponding contribution in sexual reproduction? Make the same comparison for plants, insofar as you know their cycles.
12. Why are not two conjugating paramecia referred to as male and female?
13. What do you suppose is the nature of the influence exerted by organizers in development?
14. If variable temperature were shown to produce irregularity of development in some animal, how could you explain that result?
15. In what sense are the aims of geneticists and embryologists identical?
16. Experiments show that in general fathers contribute as much to their offspring as mothers do. What conclusion could you draw from this fact regarding the "heredity substance"?

CHAPTER 4

MECHANISM OF HEREDITY

Heredity is governed by a considerable number of minute bodies, the *genes*. These bodies are probably protein substances, and may be either single molecules or small groups of them. They are contained in the chromosomes, being placed in a single row from end to end of these structures. Though two or more identical genes may occur in the same chromosome, the genes of one chromosome are mostly different from one another.

Identity of the Genes.—Most of the things just said concerning genes were earlier said of the nodules or chromomeres of which the chromosomes are in part composed. To what extent the genes may be identified with the chromomeres is uncertain. Some cytologists, working with cells in which the chromomeres are small and very numerous, have not hesitated to assume that the visible knots are the genes. In most cells, however, there are not enough of the little pellets to permit this assumption. In the vinegar fly *Drosophila*, which has furnished more of our knowledge of heredity than any other organism, calculations of several sorts indicate the total number of genes to be from 1800 to 14,000 in a mature germ cell. Probably other organisms of similar complexity have comparable numbers of them. In very few animals or plants, however, can anything like even 1800 chromomeres be detected in the chromosomes of a mature egg or spermatozoon. Whether the chromomeres are aggregates of genes or whether only a few of the genes are visible and hosts of others are beyond the limits of visibility cannot now be stated.

In one tissue of *Drosophila*, however, the chromosomes are greatly enlarged, and in these it is possible that the genes are actually being seen. That tissue is the salivary gland. It has long been known that the chromatin of the salivary-gland cells of flies is in the form of heavy cords marked by crossbands. These ropelike strands were in appearance like great rolls of pennies. Partly spread out, they are shown in Fig. 19. It was hoped that the disks might give some clue to the organization and individuality of the chromatin, and Painter (1933, 1934) found this to be true to a very remarkable degree. With a little

stretching the salivary-gland chromosomes are from 100 to 150 times as long as the corresponding chromosomes in germ cells. They are likewise thicker, though this dimension is much less exaggerated. Some of the thickness appears to be due to a multiplication of the chromosomes, for each so-called chromosome shows signs of being composed of numerous strands closely joined to one another.

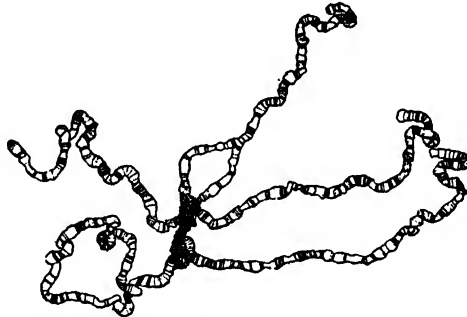

FIG. 19.—Salivary-gland chromosomes of *Drosophila*. Entire group of chromosomes attached to geneless granular material in the center. (Modified from Painter, *Journal of Heredity*.)

The disks that give the appearance of crossbands are very different in size and shape (Fig. 20). Some are heavy, some light, with all sizes between; some appear to be continuous unbroken disks, others are divided into separate segments; some are solid, others hollow like very thin flasks. These identifiable disks are distributed along the chromosome according to a very definite pattern, and this pattern is the same,



FIG. 20.—Correspondence of gene pattern in homologous chromosomes. Portion of so-called second chromosomes of *Drosophila*, joined together at left, separate at right. The two patterns are identical.

for the corresponding chromosomes, in every cell of the gland. It is accordingly possible, when only a part of a chromosome is seen, to say to which chromosome it belongs and where in the length of that chromosome it is placed.

The differences between these disks, and the definite pattern of their arrangement, are suggestive of the differences among genes and the pattern of their arrangement in chromosomes, as discovered not by observation but from breeding experiments. The correspondence

between disks and genes in these two respects raised the question whether the disks may not be the genes. The answer to that question is now being sought. By X rays or by accident, the chromosomes can be broken and parts misplaced or omitted, and it is found that the mode of inheritance of certain characters is at the same time changed. To keep a safe record of such changes, the map of the chromosome group as a whole has been arbitrarily divided into a hundred sections, and each of these into six subsections. In each subsection there are usually several bands. By noting what inherited characters have been affected by a given break of the chromosome, and particularly the various breakages which affect the same character, it has been possible to say that the gene for forked bristle, for example, is in the band 15 F 1—that is, the fifteenth section, sixth subsection, first band. Nothing as yet forbids the assumption that the visible disks are, or contain, the genes, and that assumption may well be provisionally made.

Genes in Homologous Chromosomes.—As has already been stated (page 16), the chromosomes of a cell are of two similar sets. Each chromosome is matched by another one very much like it, that is, the chromosomes are twins. One chromosome of each pair came from the mother, the other from the father.

The similarity of these chromosomes extends to their genes. Similar genes, arranged in identical pattern, mark the homologous (page 17) chromosomes. This similarity can readily be seen in the salivary gland of *Drosophila*. Unlike those of most cells, the similar chromosomes of this gland are united side by side. There *appears* to be in each cell only one chromosome of a kind, instead of two, but that is only because the like chromosomes are joined. In this uniting, the corresponding bands (genes?), being placed in the same order and the same distance apart, lie opposite one another. Now, so great is the similarity of the disks in the two chromosomes that each pair of disks makes a single unbroken band crossing both chromosomes. Only occasionally do the chromosomes fail to join firmly at some places in their length (Fig. 20), but at these places the similarity of the bands at the same level is still plainly visible.

In other types of cells, it can often only be inferred that similar genes occupy the corresponding loci of the homologous chromosomes. In Fig. 7 there are similar chromomeres at the same levels, but what relation these nodules bear to genes is uncertain. Nevertheless, there is a great body of evidence of an experimental sort, some of which is presented in later chapters, from which the location of genes may be ascertained. The order of the genes and their distances from one

another may thus be learned; that is, maps of the chromosomes can be made, and hundreds of genes have been assigned their proper places in the chromosomes of *Drosophila*. Now, since the two homologous chromosomes of any pair can be traced separately in different lines of descent, it is possible to show that the chromosome maps of both the homologues are identical. And so, even if the genes cannot be observed, it may still be known that two twin chromosomes have similar genes placed at the same levels in their length, and that if these chromosomes were placed side by side as in the salivary glands similar genes would be opposite one another.

Early Stages of Maturation in Animals.—Just such an apposition of the chromosomes side by side actually occurs in the germ cells of animals as they start the long process known as *maturation* or *meiosis*. Prior to the beginning of meiosis, the reproductive cells, *spermatogonia* in the male, *oögonia* in the female, multiply by repeated cell divisions of the ordinary duplicating type. When the animal reaches a given

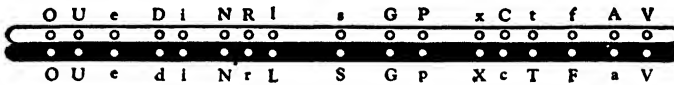

FIG. 21.—Diagram of two homologous chromosomes, maternal and paternal, showing that similar genes are placed at the same level in the length of the chromosomes.

stage, some of these cells cease to divide by ordinary division. These cells are now *primary spermatocytes* and *primary oöcytes*, in the respective sexes. It is in these cells that the pairing of the chromosomes referred to above takes place. The homologous chromosomes, maternal and paternal, come together side by side in pairs. Though the genes cannot be recognized in them, genetic experiments clearly show that in this pairing the homologous genes are placed side by side (Fig. 21) throughout the length of the chromosomes. Whether it is mutual attraction of homologous genes that brings the chromosomes together is uncertain.

While the chromosomes are pairing, the cells containing them grow in size—the primary spermatocytes moderately, the primary oöcytes enormously as a rule. The upper four rows of cells in Fig. 22 represent, first, the multiplication of the cells, and then their growth and the pairing of the chromosomes.

The Divisions in Meiosis.—The rest of maturation consists largely of two successive cell divisions, one following close upon the other. In one of these divisions the chromosomes are duplicated as in ordinary cell divisions; in the other division they are not duplicated, but some

go to one cell, some to the other. The division in which the chromosomes are merely separated into two groups is known as the *reduction* division because the number of chromosomes per cell is thereby reduced to half. The division in which the chromosomes are duplicated

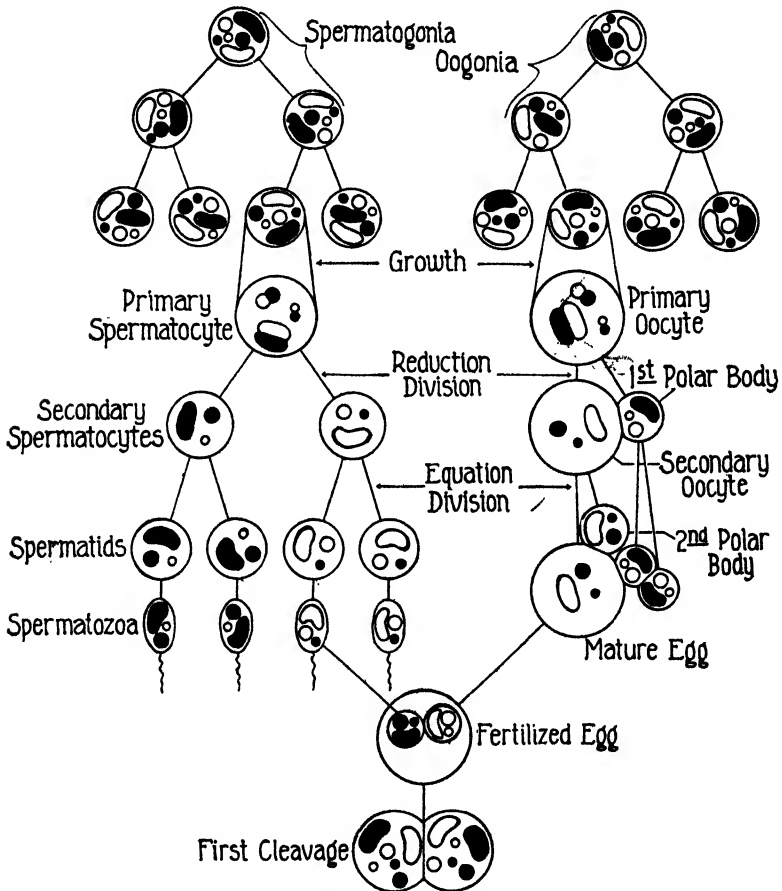

FIG. 22.—Diagram of maturation or meiosis of germ cells in animals. The process begins with the third row of cells. Maternal chromosomes white, paternal black. All chromosomes in the fertilized egg received from the mature egg are thereafter maternal, and those received from the spermatozoon are thereafter paternal, regardless of what they were in the mature germ cells.

is called the *equation* division, referring to the equality of the cells produced. Ordinary cell division elsewhere is likewise equational.

Which of these types of division occurs first is immaterial except in relation to very special genetic problems. Reduction very commonly

occurs in the first division, but there is no set rule; and by a breakage of the chromosomes and recombination of their pieces, reduction may occur in the first division in part of the length of the chromosomes, but in the second division in the remainder of the same chromosomes.

Reduction Division.—The diagram in Fig. 22 represents reduction as occurring first. The homologous chromosomes, having previously paired, now part company, one going to one cell, the other to the other cell. In this separation, the homologous genes are likewise separated. Just as the daughter cells get only one chromosome of each pair, so do they get only one gene of each pair. The total number of chromosomes in each daughter cell is just half the number in the cell from which they are derived. This reduced number is called the *haploid* number, as contrasted with the original or *diploid* number.

The several pairs of chromosomes are independent of one another in this separation, that is, the paternal members of two pairs may go to the same cell, or to different cells, in the reduction division. To which of the two cells a given chromosome goes is mostly a random matter. Consequently, various combinations of maternal and paternal chromosomes are found in the different cells resulting from the reduction division. In some such cells all the chromosomes are paternal, in some all are maternal, and in others there are all conceivable combinations of maternal and paternal. Since each chromosome contains certain genes, the germ cells therefore contain all sorts of combinations of genes.

In the male (Fig. 22, left), the first meiotic division produces two equal cells, both functional, which are known as *secondary spermatocytes*. In the female the division is very unequal, one daughter cell being very large (*secondary oöcyte*), the other very small (*polar body*). Only the large cell in the female is functional; the polar body gradually disintegrates and disappears.

Equation Division.—Each cell produced by the first maturation division, with the exception usually of the polar body, immediately prepares to divide again. If the first division was reductional for any cell or any pair of chromosomes, this one is equational. The chromosomes are duplicated, and two cells genetically identical with one another and with the parent cell are produced by each division.

These cells in the male are equal, and are called *spermatids*. From one primary spermatocyte come four spermatids. If the reduction division occurred first, two of the spermatids are identical and the other two identical but different from the first two. In the female the division is again very unequal, the large cell being the *mature egg*,

the small one another polar body. To distinguish the polar bodies produced by the two divisions, they are called *first* and *second*, respectively. In a few animals, the first polar body, though nonfunctional, divides equationally as does the secondary oöcyte. This kind of animal, though unusual, is represented in Fig. 22 in order to complete the comparison of meiosis in the female with that in the male. From one primary oöcyte are derived, in such an animal, four cells; but only one of the four, the egg, ever functions further.

The spermatids change shape to produce the mature *spermatozoa*, and maturation is finished.

Summary of Meiosis.—The features of meiosis which are of greatest significance in heredity are the following: (1) the pairing of the homologous maternal and paternal chromosomes; (2) the separation of these paired chromosomes and their passage to different cells in the reduction division; (3) the consequent separation of the genes of each pair to different germ cells; (4) the independence of the several pairs of chromosomes in this separation; (5) the resultant assembling of various combinations of maternal and paternal chromosomes in the different mature germ cells; (6) the variety of combinations of genes thus produced in the different germ cells; and (7) the reduction of the number of chromosomes in the mature germ cells to half that found in the reproductive cells before maturation. Each of these features has important consequences to which attention must be called in later chapters.

Fertilization.—In most animals employing sexual reproduction, an egg must be fertilized before it can develop into a new individual. In this process a spermatozoon enters the egg either after the maturation is completed or at some earlier time during the maturation process. Eventually the nucleus of the spermatozoon approaches that of the egg until they are side by side. As the fertilized egg prepares for cleavage, the membranes of the two nuclei dissolve away, leaving the chromosomes of both parents free to enter the spindle of the dividing cell.

The designations maternal and paternal as applied to the chromosomes frequently change at this point. When an egg is fertilized, a new individual is started. The chromosomes in the fertilized egg must therefore be labeled with reference to the parents which contributed to it. In Fig. 22, though the egg is represented as containing one maternal and two paternal chromosomes, these are all maternal in the fertilized egg and are so represented in the illustration. The chromosomes in the spermatozoon are two maternal and one paternal; but in

the fertilized egg they are all paternal. The descendants of these chromosomes retain their new designations throughout the new individual, including its mature germ cell; but, in the long run, half of the chromosomes will change names again when these germ cells participate in fertilization and the formation of new individuals in the next generation.

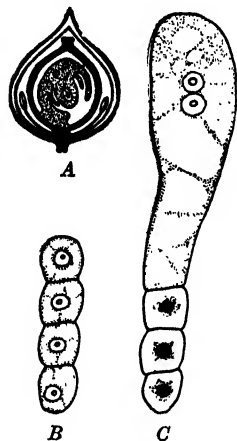

FIG. 23.—Time of reduction in a flowering plant. *A*, bud; dotted ovule at center contains single reproductive cell, which is diploid. *B*, single cell has divided into four, which are haploid. *C*, upper one of these four growing and dividing to produce embryo sac, other three degenerating. (*A* from Sinnott, *Botany: Principles and Problems*.)

compared with only one division, or none at all, after reduction in animals.

Reduction is similarly early for the male cells of plants. The cells of the last diploid generation in the anthers divide into four cells which are haploid. Reduction appears to occur usually in the first of the two divisions which produce these four cells. Each of the four haploid cells then proceeds to form a pollen grain, by dividing into two cells, both haploid, only one of which has a reproductive function. As the pollen grain germinates and grows down the style of the female parts of a flower (Fig. 13), the reproductive nucleus, which lags behind the nonreproductive one (Fig. 24), divides into two. One of these two fertilizes the egg, the other unites with two nuclei near the egg to form the endosperm nucleus, as explained before (page 24). In the male

Reduction in Flowering Plants.—The change from the diploid to the haploid chromosome number occurs somewhat earlier in flowering plants than in animals. In the bud shown in Fig. 23, the dotted portion in the middle consists of the ovule, including the future seed coats. In the midst of the ovule is a single cell from which the egg is later derived. This cell is diploid; but, when it is twice divided to form a row of four cells (Fig. 23, *B*), each of these cells is haploid. Reduction has taken place in one of the two divisions, and the available evidence indicates that it is usually the first division.

Three of these four haploid cells degenerate (Fig. 23, *C*), while the fourth divides three times to form the eight cells of the embryo sac (Fig. 13, *f.g.*). All of these eight cells are haploid. One of them is the egg, as was earlier indicated (page 24). There is thus a series of three or four cell divisions following reduction before the egg is finally formed, as

cells, therefore, there are two or three divisions between reduction and the final completion of the reproductive nuclei.

Reduction in Mosses.—In some of the lower plants, such as ferns, mosses, and liverworts, there is a much longer interval between reduction and the production of germ cells. The moss cycle will serve to illustrate. A moss spore (Fig. 25, *a*), falling to the moist soil, germinates to produce a branching chain of cells. From some of these cells a moss plant, called the *gametophyte* (*b*), develops. At the top of the

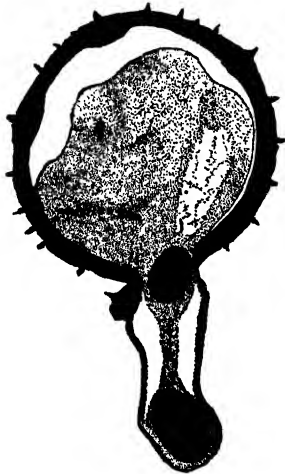

FIG. 24.

FIG. 24.—Pollen grain, germinating. The pollen-tube nucleus is at the tip of the growing tube. Behind it is the generative nucleus, which later divides into two. (From Sinnott, *Botany: Principles and Problems*.)

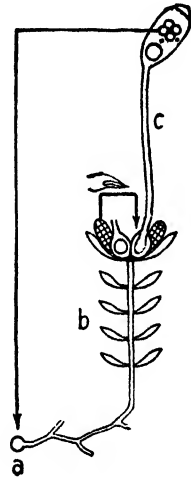

FIG. 25.

FIG. 25.—Diagram of life cycle of a moss. *a*, spore; *b*, gametophyte, or moss plant; *c*, sporophyte. The spore and gametophyte have half as many chromosomes per cell as does the sporophyte. (After Bělai in *Handbuch der Vererbungswissenschaft*.)

gametophyte the germ cells, male and female, are produced. All the cells so far mentioned, from spore to germ cells, are haploid.

The egg is then fertilized, and from the fertilized egg develops a club-shaped structure, called the *sporophyte* (*c*). This structure is diploid, as was the fertilized egg from which it came. But when the sporophyte produces spores, to repeat the cycle, these spores are haploid again. One of the last two divisions by which the spores are produced is a reduction division. Not until the moss plant (gametophyte) is mature, however, are germ cells again produced. In the mosses, therefore, many thousands of haploid cells are produced after reduction and before the germ cells are formed.

Reductional Nondisjunction.—As an exceptional occurrence, separation of a maternal chromosome from its paternal homologue may not take place. Both chromosomes then go to one cell, while the other cell receives no chromosome of that pair. This nondisjunction is comparable to that of two duplicate chromosomes in ordinary cell division (page 18); but since maternal and paternal chromosomes may not be exactly alike, the consequences of reductional nondisjunction are somewhat different.

PROBLEMS

17. How would a series of overlapping breaks in the chromosomes of *Drosophila* locate a given gene in a certain band of the salivary-gland chromosomes?
18. If the spermatids produced by an animal contain 24 chromosomes, what is the haploid number of chromosomes? The diploid number? When does reduction occur if the secondary spermatocytes contain 24?
19. With how many of the other chromosomes in a primary oöcyte does a given chromosome have any chance of pairing in maturation?
20. The maternal chromosomes in a male animal are likewise maternal in his children. True, or false?
21. Of 22 chromosomes in a mature egg, what is the maximum number which may be maternal?
22. Compare the length of the haploid phase of the cycle of a moss with that of the haploid phase in animals.
23. How many eggs are produced from 17 primary oöcytes? How many spermatozoa from 17 primary spermatocytes?
24. Under what circumstances would a second polar body contain exactly the same kinds of genes, and the same number of them, as the first polar body?
25. Which of these kinds of cells may occasionally contain only maternal chromosomes: mature egg, muscle cell, secondary spermatocyte, first polar body, primary oöcyte, spermatid, a haploid cell, a diploid cell?
26. What disadvantages would a species suffer if its sexual reproduction were not accompanied by reduction division?
27. If the leaf cells of a plant contain 22 chromosomes, how many chromosomes are in the endosperm nuclei of the seed?
28. What would you need to know to compute the fraction of the germ cells of an animal that would contain only maternal chromosomes? How would you make the computation when that information is furnished?
29. What are the differences, and the similarities, between eggs and spermatozoa in their maturation?

CHAPTER 5

SIMPLE HEREDITY

The relation of genes to chromosomes was gradually discovered while knowledge of chromosomes accumulated. Knowledge of chromosomes and understanding of heredity advanced together. Sometimes a new discovery regarding chromosomes suggested a new feature of inheritance that was later confirmed. More often some result of a breeding experiment, demonstrating a new relation in heredity, indicated a novel aspect of chromosomes that was then found to be real. The latter order has been the common one with respect to the finer details of the genetic mechanism. Most of what is known regarding the order of genes in the chromosomes, their distances apart, and the accurate side-by-side pairing of the genes as the chromosomes pair in meiosis was merely inferred from the manner in which characters were inherited in crosses. Such observational confirmation of these details of architecture as is found in the salivary-gland chromosomes of *Drosophila* came very late—long after the general scheme of gene arrangement had been thoroughly established.

Hybridization the Source of Knowledge of Heredity.—The mechanism of heredity has been described in terms which may have seemed to imply that the details of chromosome structure could be seen. It is only in such remarkable cells as those of the salivary glands of flies, however, that many details are actually visible; and even in these giant chromosomes the real meaning of the elements must be determined from crosses between different kinds of individuals. Crosses are effected between individuals differing in some character or characters, the offspring in one or more succeeding generations are found to display certain qualities or combinations of qualities in certain numbers of individuals, and then a logical scheme is devised to account for the observed results. When large numbers of crosses lead to the same scheme, differing in details which are comprehensible but agreeing in the fundamental plan, that scheme stands demonstrated as the mechanism of heredity.

Simplest Monohybrids.—The simplest sort of experiment is one in which two organisms differing in just one respect are crossed and in

which the genes contained in any individual can be known, once the scheme is understood, from a mere visual inspection of that individual. The garden flower known as the snapdragon furnishes an example of this simple sort in the red, ivory, and pink colors of its flowers.

A red-flowered snapdragon breeds true, that is, if it is self-fertilized, its offspring are all red-flowered. Ivory-flowered plants likewise breed

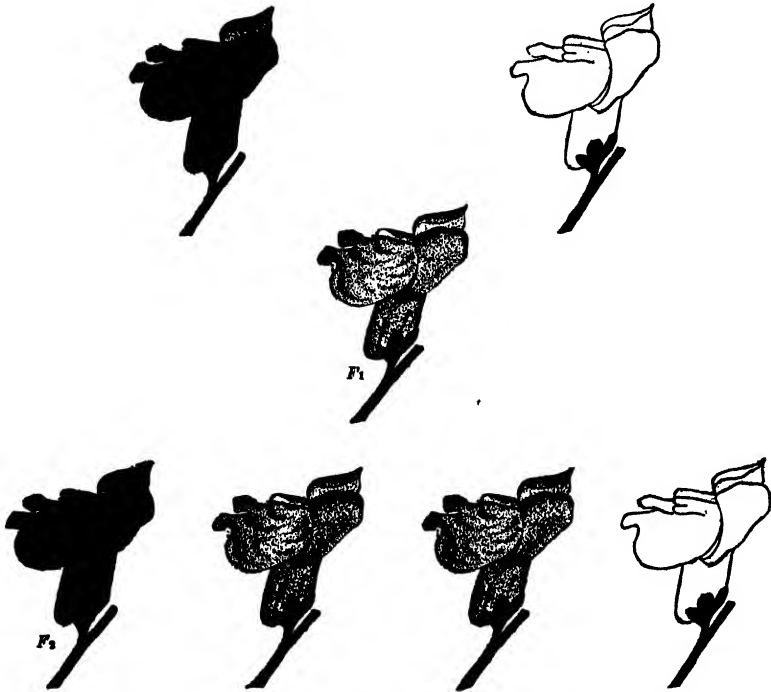

FIG. 26.—Cross between a red snapdragon (represented dark) and an ivory snapdragon (shown white). The offspring (F_1) are intermediate in color, that is, pink. The F_2 generation produced by self-pollinating a pink F_1 flower consists of red, pink, and ivory flowers in the ratio indicated by the illustrations.

true. Now, when these two types are crossed, seeds are produced which develop into offspring with pink flowers (Fig. 26). The color is intermediate between the colors of the parents, and all the offspring are alike in this respect. These pink plants are known as the F_1 generation, abbreviated from *first filial*.

Now, if a pink-flowered plant of the F_1 generation is self-fertilized or if two pink ones are crossed, the seeds thus produced give rise to an F_2 (*second filial*) generation which consists of three kinds of plants.

About $\frac{1}{4}$ of the F_2 plants have red flowers, about $\frac{1}{2}$ of them are pink, and $\frac{1}{4}$ are ivory (Fig. 26).

By self-fertilizing any of the F_2 plants an F_3 generation is obtained; but the nature of the F_3 plants depends on which of the three types of F_2 plants was self-pollinated to produce them. A red-flowered plant yields F_3 that are all red; an ivory F_2 produces only ivory; while a pink F_2 gives three kinds of offspring in F_3 , $\frac{1}{4}$ red, $\frac{1}{2}$ pink, $\frac{1}{4}$ ivory.

Explanation of Color Inheritance in Snapdragons.—The very regular numerical results just described have a simple explanation in the random distribution and recombination of the chromosomes and genes. The red and the ivory plants differ with respect to the genes of only one pair; all other pairs of genes are alike in the two plants. These color genes, it must be assumed, are in the homologous chromosomes of one pair in the two plants (Fig. 27). The differentiating genes in the ivory plant may be symbolized by the letter *i*, those in the red plant by *I*.

At some time prior to the formation of the germ cells, as explained in the preceding chapter, the reduction division separates the chromosomes of the pair that contains *I* or *i*, so that each cell has only one of these chromosomes. The eggs of the red-flowered plant all contain the gene *I*, the pollen grains of the ivory plant all contain the gene *i*. When the egg is fertilized by one of the generative nuclei of the pollen, the seed containing the fertilized egg produces a plant having in each cell one chromosome with *I* and the other chromosome of this pair with *i*. The combined action of *I* and *i*, along with the many other genes in the plant, causes the flowers to be pink.

When the F_1 pink-flowered plants produce their germ cells, two kinds of eggs and two kinds of pollen are formed. Sometimes the reduction division in the female cells occurs in such a way that the surviving upper one of the four cells (Fig. 23, *C*) contains the maternal chromosome and its gene *I*, and from this cell is developed the embryo sac, including an egg. In other instances the reduction division carries the paternal chromosome and its gene *i* to the surviving upper cell, which then proceeds to produce an embryo sac containing an egg. Since the reduction division is just as likely to carry the one chromosome as the other to this surviving upper cell, the two kinds of eggs *I* and *i* should be about equally numerous.

The male reproductive cells in the anthers behave in essentially the same way as do the female cells, except that all cells survive. After the reduction division, there is one cell containing the maternal chromosome with *I*, another cell containing the paternal chromosome with

i. The descendants of these cells produce pollen, which therefore is of two kinds, *I* and *i*, each kind exactly as abundant as the other. Figure 27 shows the two kinds of eggs and two kinds of pollen.

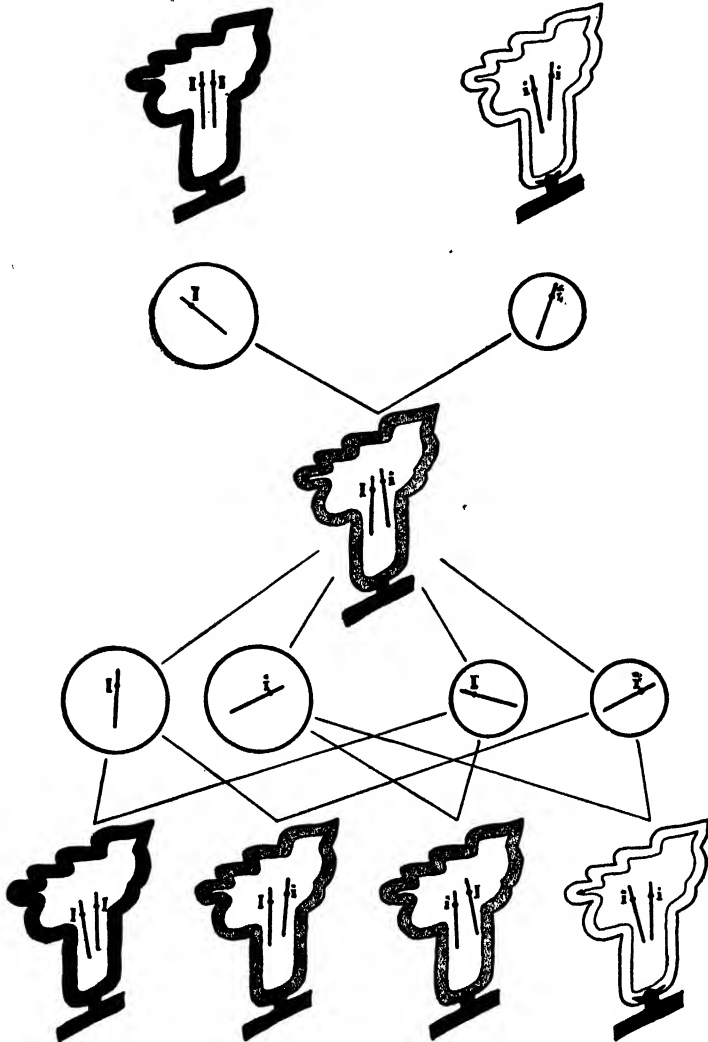

FIG. 27.—Diagram representing inheritance of color in snapdragons. Black border, red flowers; dotted border, pink; white border, ivory. Large circles, eggs; smaller circles, pollen cells. Heavy lines, chromosomes; dots in the chromosomes, genes. *I*, gene for red; *i*, gene for ivory.

Both kinds of pollen fall on the stigma, and their tubes grow down through the style and reach the two kinds of eggs at random. Four

combinations are possible, and, since they are effected at random, they should be equally numerous. These four combinations II , Ii , iI , and ii are shown at the bottom of Fig. 27. They produce red, pink, and ivory plants. Since the combinations Ii and iI are in effect identical, the pink-flowered plants are twice as numerous as either the red or the ivory.

Terminology.—To refer to the several kinds of individuals involved in the crosses described, with respect to their combinations of genes, certain terms are useful. Any organism in which the two genes of a given pair are alike (II or ii) is called a *homozygote*. One whose genes of any pair are different (Ii) is said to be a *heterozygote*. The terms come from the word *zygote*, which means the combination produced by the union of two cells to form one cell in reproduction. A fertilized egg is thus a *zygote*. By an extension of meaning, individual animals or plants which have developed from fertilized eggs are also called *zygotes*, when it is desired to distinguish them from their germ cells, which are called *gametes*. *Zygotes* are diploid with respect to their chromosomes and have two genes of each pair, *gametes* are haploid and have but one gene of each pair.

Two other useful words relate to the distinction between the genes an organism possesses and its visible appearance or other qualities. The aggregate of genes in an animal or plant, or the group of genes under consideration, is called its genetic composition, or *genotype*, sometimes simply its heredity formula. Its observable qualities are, by contrast, called its *phenotype*. The phenotype of the F_1 snapdragons in the foregoing experiment is pink; their genotype is Ii .

Distinctive Feature of Simplest Heredity.—The simplest operations of heredity must concern only one pair of differentiating genes. The additional feature of the snapdragon contrasts which makes them particularly simple is that there is only one genotype for each phenotype. The pink-flowered plants are always of the genotype Ii , the red ones always II , and the ivory ones always ii . The genotype may be recognized by merely observing the quality of the individual. In many characters this is not true, as will be seen in the next chapter, for organisms of the same phenotype often have different genotypes.

Other Examples.—A considerable number of other plants, and of animals, show this unequivocal correspondence between genotype and phenotype. In the weed shepherd's-purse one variety has in the young or rosette stage a leaf whose main expanse is at the tip (Fig. 28, left). In another variety the blade of the leaf is broadly lobed (right). The hybrid produced when they are crossed has a leaf with irregular but

rather narrow lobes (center). The leaves in various positions on the plant have different forms, but nearly every one in the heterozygote is unlike the corresponding leaf of either homozygote.

Roan color in Shorthorn cattle (Fig. 29) is an equally good example. This pattern consists of hairs of two colors, white and red, irregularly interspersed among one another. There may be patches of considerable size which are mostly red, other areas mostly white; but often there are only a few hairs of the same color together. The roan pattern appears only in heterozygotes. White Shorthorns are homozygous (ww), red

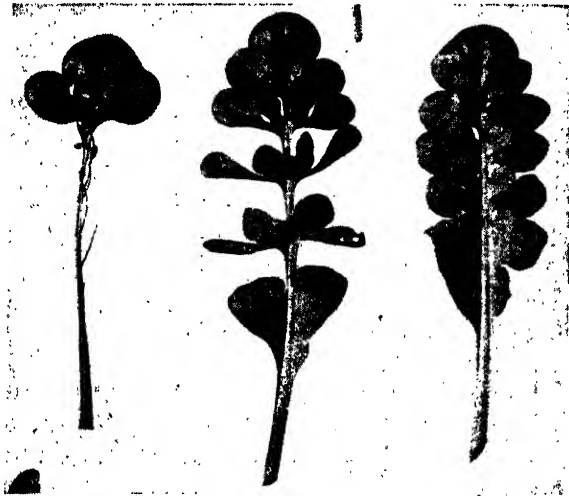

FIG. 28.—Distinguishable heterozygote in shepherd's-purse. Rosette leaves of parents left and right, their hybrid between. (Photograph by Professor G. H. Shull.)

Shorthorns are likewise homozygous (WW). Their hybrid (Ww) is roan.

Distinguishable Heterozygotes in Man.—In man, while it is probably rather common for heterozygotes to be different from both homozygotes, not many simple examples are available. So many human characters are noticeably affected by several pairs of genes that the differentiating effect of a single pair is obscured. In the absence of controlled breeding experiments, such as are possible with other animals and with plants, it is difficult to isolate the consequences of a single pair of genes. Yet there are many indications that in the interactions of several pairs the effect of Aa is often different from that of either AA or aa .

Not yet thoroughly established as a simple example of distinguishable heterozygote is the condition known as brachyphalangy, in which

one segment of each finger or toe is reduced, that is, in heterozygotes. Very few people homozygous for this character are known, but the consequence of homozygosis seems to be considerable abnormality of the skeleton as a whole. This character is discussed again among lethal characters in Chap. 10.

A possible additional example of a human character in which each genotype is recognizable from its phenotype is the absence of the lateral incisor teeth in a family described by Keeler and Short. This character recurred in each generation, presumably mostly in hetero-

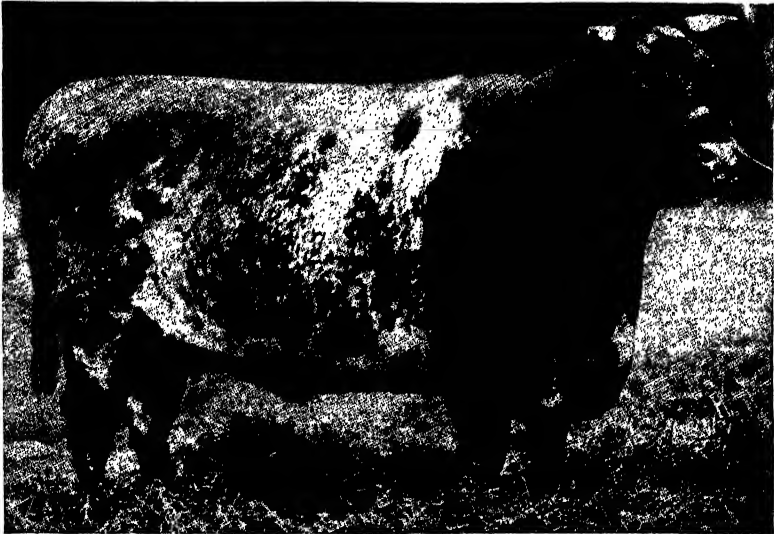

FIG. 29.—A roan Shorthorn cow. The coat consists of red hairs and white hairs interspersed, a condition found only in animals heterozygous for red and white. There are also blue roans, which are heterozygous for black and white. (From McPhee and Wright, in *Journal of Heredity*.)

zygotes, since usually only one parent of a family lacked the incisors. When, however, both parents lacked the two lateral teeth, their child lacked five teeth. This child could have been a homozygote, and the fact that the character was more marked in it suggests that being homozygous accentuated the abnormality. If homozygotes regularly have this heightened expression of the character, as compared with heterozygotes, this is another instance of recognition of the genotype from the phenotype.

Certain substances in human blood are inherited in a way which, while different from that described in this chapter, nevertheless enables one to distinguish a heterozygote from both corresponding homo-

zygotes. The substances are known as *agglutinogens* and are located in the red cells of the blood. Two of these substances are alternative to one another in the sense that only one of them can be represented in any gamete. They are named A and B. A person homozygous for A develops only A, and one homozygous for B has only B; but a person heterozygous for the two possesses both of them. The presence of either or both can be detected by laboratory tests. There is also another pair of agglutinogens named M and N, and their mode of inheritance is identical with that of A and B, in that one homozygote possesses M, the other homozygote has N, while the heterozygote has both M and N. In neither of these pairs of agglutinogens is the heterozygote intermediate between the two homozygotes, as pink snapdragons are; it has instead a combination of the qualities of the homozygotes, and thus is readily recognizable. These agglutinogens are part of a somewhat more complicated system that is described further in Chap. 9.

PROBLEMS

30. Can a herd of roan cattle be made to breed true? Why?
31. If the two kinds of eggs produced by a heterozygous female were not quite equally numerous, what events could explain the inequality?
32. If the two kinds of spermatozoa produced by a heterozygous male were not precisely equal in number, what could explain the disparity?
33. If a florist wishes to guarantee that the seeds he sells will produce only pink snapdragons, how should he obtain the seed?
34. If plant *Cc* is self-pollinated and produces 60 seeds, how many of these should yield plants having the same genotype as the parent?
35. If a man having both agglutinogens A and B in his red cells marries a woman who likewise has both of them, what portion of their family should have only agglutininogen A?
36. Does segregation of genes occur in homozygotes, or only in heterozygotes?
37. Could the owner of a herd of white Shorthorn cattle, by borrowing a roan bull, establish a herd of red Shorthorns? How would he proceed?
38. Blue Andalusian fowls are heterozygous for black and splashed-white genes. Would it be possible to establish a pure black flock by starting with a pair of blue Andalusians? By starting with a white and a blue Andalusian of opposite sex? Describe the procedure in either case.

CHAPTER 6

DOMINANCE

When each phenotype can have only one genotype, breeding experiments are simple. If it is desired to cross two individuals possessing certain genes, such individuals can always be selected merely from their appearance. Many characters, however, do not reveal the genotype of the animal or plant exhibiting them. Some individuals may be either heterozygotes or homozygotes, and, to discover which one they are, it is necessary to obtain offspring from them, or to know their parentage.

Black and Brown Mice.—A familiar example of this uncertainty of the genotype is furnished by the black color of mice, as contrasted with brown coat. Black mice may be homozygous, or they may be heterozygous for brown and black. If a stock of mice has been inbred for some time and only black animals have been produced, these mice are assuredly homozygous. But a black mouse obtained from an unknown source may be heterozygous. Brown mice, on the contrary, are always homozygous for brown.

These relations of brown and black are ascertained from a cross like that shown in Fig. 30. If a black mouse, known to be homozygous from long inbreeding of its ancestors, is crossed with a brown mouse, sure to be homozygous without knowledge of its ancestry, all their offspring (F_1 generation) are black and indistinguishable from the black parent. This result is described by saying that black coat is *dominant*, brown *recessive*. When these black F_1 animals are interbred, the F_2 generation obtained from them consists of some black and some brown animals, the blacks being about three times as numerous as the browns.

Inheritance of Color in Mice.—The two kinds of mice differ only in one pair of genes, which are located in a pair of homologous chromosomes. The differentiating genes of the brown animals may be symbolized by the letter *b*, those of the black mice by *B*. The original black parent in this cross had two chromosomes containing *B* in each cell; but the reduction division left only one of these chromosomes, hence only one gene *B* in each of its mature eggs (Fig. 31). The brown

mouse had two chromosomes containing b , but the reduction division resulted in spermatozoa having only one chromosome of this pair and only one gene b .

The fertilized eggs must therefore have had one chromosome with B , the other with b . These fertilized eggs developed into black mice. Why Bb , along with the other genes of the animal, should produce as black a mouse as BB does is unknown. For some reason a single B , even in the presence of b , produces as much black pigment (at least so far as the eye can see) as do two B 's. This capacity of B , even when b is present, to produce as great a visible effect as BB is what constitutes

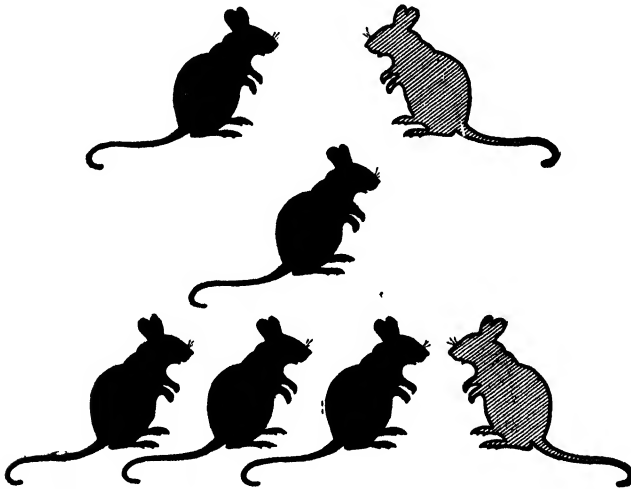

FIG. 30.—Inheritance of color in mice. Black figures, black mice; shaded figures, brown. The F_1 generation is black, the F_2 black and brown in the ratio of 3:1.

its dominance. If I in snapdragons had this capacity, the F_1 plants would have red flowers instead of pink.

The black F_1 mice produce two kinds of germ cells. In the reduction division in a female the chromosome containing b may pass to the polar body, yielding an egg with B ; or the chromosome with B may go to the polar body, producing an egg with b . Since the pair of chromosomes is placed on the reduction spindle at random, one kind of egg should be about as abundant as the other. In the male, each reduction division yields one cell with B and one with b ; hence, there are two kinds of spermatozoa, equally numerous.

The two kinds of eggs are fertilized by the two kinds of spermatozoa at random. Consequently the four combinations should be about equally frequent. Fertilized eggs of genotype BB and those containing

Bb all produce black mice. Only those possessing the genotype *bb* yield brown animals. The F_2 generation thus consists of approximately three-fourths black and one-fourth brown mice.

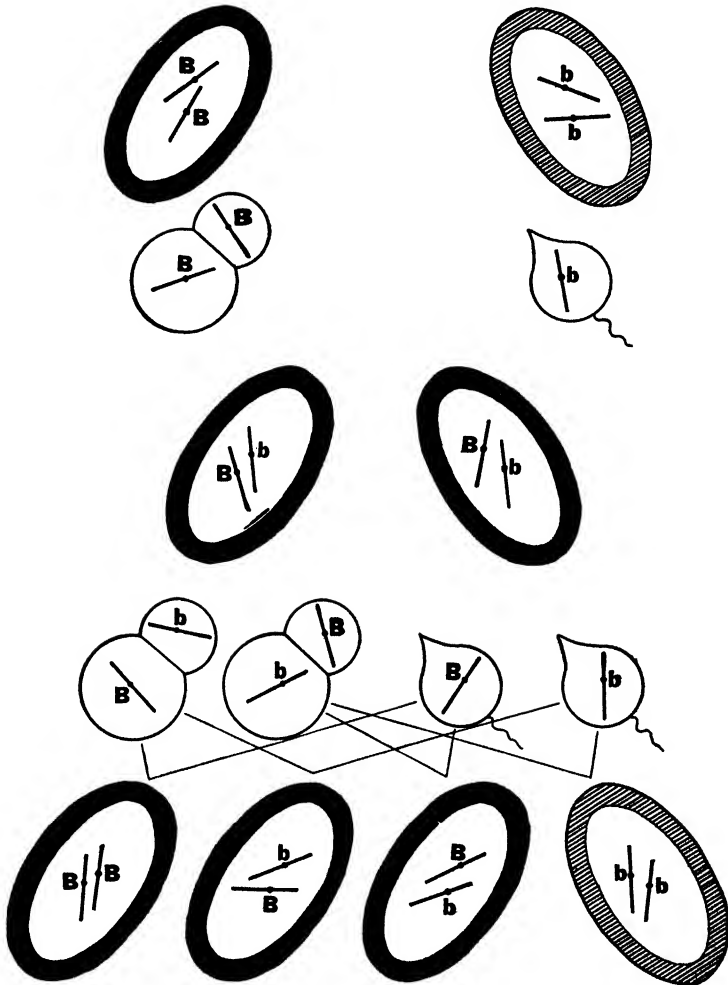

FIG. 31.—Diagram explaining the inheritance of color in mice. Black-bordered ellipses, black mice; shaded figures, brown mice. Eggs and spermatozoa are distinguished by their shapes. Straight lines in the cells or animals are chromosomes. *B*, gene for black; *b*, gene for brown.

Uncertainties in F_3 .—When an F_2 generation is bred from these F_2 animals, the uncertainties due to dominance appear. While the brown mice are known to be *bb*, there is no way to tell whether a black one is

BB or *Bb*. A mating of two F_2 brown animals yields only brown offspring; but two black individuals from F_2 may yield only black offspring (if at least one of the parents is *BB*), or they may produce both blacks and browns (if both parents are *Bb*). In the latter contingency the black and brown offspring are in the ratio of about 3:1, as in the F_2 generation. Other types of matings involving the F_2 mice are possible, but every time a black member of this generation is used there is doubt concerning the genotypes of the prospective offspring, for the black parent may be either *BB* or *Bb*.

Choice of Symbols of Genes.—In symbolizing genes by means of letters geneticists have adopted a convention involving novelty and dominance. An initial letter is ordinarily used, unless it has been preempted for some other pair of genes. Of the two characters that are contrasted, the newer one, in the history of the race, suggests the symbol. In snapdragons the letters *Ii* were chosen in the belief that ivory flowers are a more recent development in the evolution of these plants than are red flowers. For color in cattle the letters *Ww* were selected on the supposition that red cattle have existed longer than white ones. In mice the letters *Bb* come from brown, rather than black, since brown is presumably the newer character.

In the above examples the relative ages of the two characters are not directly known. In breeding experiments the new character sometimes arises by mutation, under observation, and then there is no uncertainty in the application of the convention. When the red eye of the vinegar fly *Drosophila*, much used in genetic studies, mutated in one individual to a vermilion eye, the symbols of the genes were *Vv*. When the body color of one of these flies mutated to yellow (from gray), the symbols chosen for the genes were *Yy*.

If one of the contrasted characters is dominant over the other, the capital letter is used for the dominant gene and the small one for the recessive. In the color of mice *B* accordingly designates black, *b* stands for brown. Vermilion eye in *Drosophila*, being recessive, is symbolized by *v*, the wild-type red eye by *V*. When neither character of a contrasted pair is dominant over the other, the allocation of the capital and small letters is optional. There is no particular reason why *I* should represent red color in snapdragons; it might quite as logically denote ivory.

Recognizing Dominance in Human Pedigrees.—When heredity is being studied in laboratory animals which are inexpensive to rear, it is usually possible to make the first cross with animals which are known to be homozygous for their respective characters. If the F_1 generation

is of the same phenotype as one of the parents, the character it exhibits is dominant, and the character of the unlike parent is recessive.

In human heredity it is not so simple to ascertain which character is dominant. It is impossible to inbreed stocks for several generations to insure that all individuals are homozygous at the outset. More-

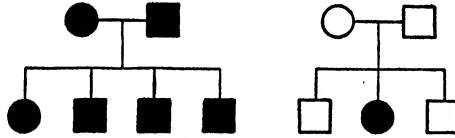

FIG. 32.—Family histories revealing the mode of inheritance of brown and blue eyes in man. Circles are females, squares males. Black symbols, blue-eyed; white symbols, brown-eyed. Blue is shown to be recessive, brown dominant.

over, the “experiments” themselves are not carried out at the will of some breeder; one has to take the information that is available in accessible family histories. In addition, families are small, so that a group of brothers and sisters who should theoretically divide in the ratio of 3:1 between two phenotypes may easily not include the minor-

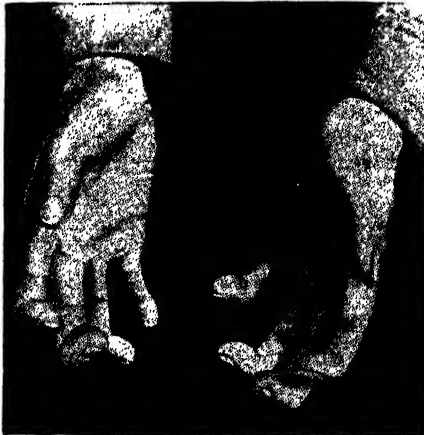

FIG. 33.—Symphalangy, or stiff fingers, due to fusion of the bones at some of the joints. The fingers are not usually shortened appreciably. (From Hefner in *Journal of Heredity*.)

ity class at all. It is necessary, therefore, to judge the heredity of a given character from many family histories, in which the parents are likely to have different genotypes. How are dominance and recessiveness best judged under these circumstances?

The easiest judgment is derived from families in which the parents are alike, and the children are numerous enough to include both classes if two classes are to be expected. Examples will best illustrate the

principle. In family histories, females are represented by circles, males by squares. Lines connecting the symbols readily indicate the family relationships. The symbols are usually blackened for individuals who exhibit some unusual character, such as extra fingers, and left white for the "normal" individuals. When the contrasted characters are both common in people in general, either one may be blackened. In any case, a key to the figure must explain the symbols.

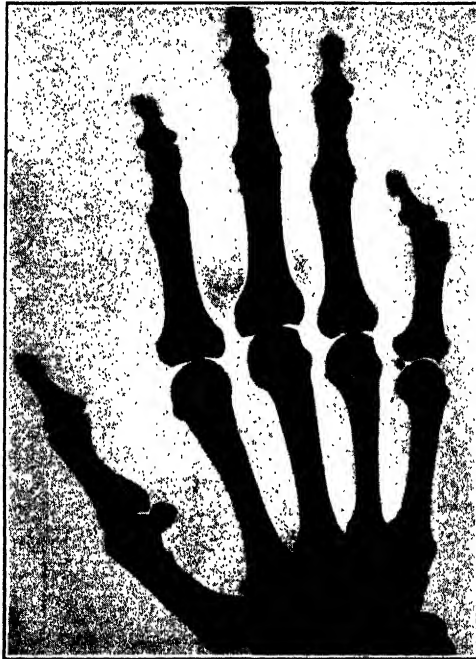

FIG. 34.—X-ray photograph of the right hand shown in Fig. 33. The bones at the first joint beyond the knuckle are fused in each finger. (From Hefner in *Journal of Heredity*.)

By means of such symbols the inheritance of brown and blue eye is represented in Fig. 32, in which the blue-eyed members of the family are represented by black. In both families the two parents are alike. In the family at the left, both parents are blue-eyed, and all the children are blue-eyed. While a single family of this sort would hardly suffice to indicate the mode of inheritance of blue eyes, if many such families are found, they would show that blue eye is recessive. When both parents exhibit the recessive character, all their children must show it.

The best single test for dominance and recessiveness is shown at the right in Fig. 32. Here the parents are both brown-eyed, and one of

their children is blue-eyed. In such a family, the parents must exhibit the dominant character (they are heterozygotes), and the child that differs from them possesses the recessive character.

A very common method of discovering whether a character is dominant is to note whether it occurs in every generation in the direct line of descent, or whether it skips a generation now and then. This test is here applied to symphalangy in a known family history. In this character the fingers are stiffened by the fusion of the segments of bone at the joints. The hands in Fig. 33 have the basal two phalanges of each finger thus joined to form a long segment. That there were two bones in such a segment, but that they were united in growth, is indicated by the X-ray photograph of one of these hands in Fig. 34.

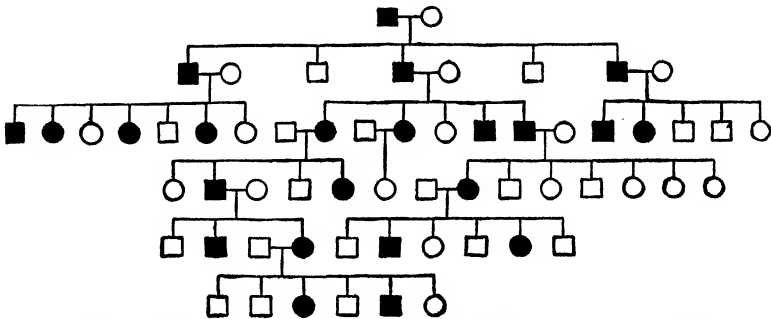

FIG. 35.—Family history of symphalangy. The character is shown to be dominant.

A family history in which many members are symphalangic is given in Fig. 35. The record has been abbreviated by including the marriages of only some of the symphalangic persons. It will be noted that in each family in which there are one or more stiff-fingered children, one of the parents is likewise symphalangic. Since this is true in every instance, the direct line of descent includes one affected person in every generation. This is in general the mark of a dominant character, for wherever one child shows a dominant character at least one of its parents must also show it. It would be possible for a recessive character to appear in each of several successive generations in the direct line, provided that the persons marrying into the family are either recessives or heterozygotes; but every-generation appearance could not be universal for a recessive character. Occurring in every one of even a few successive generations would be very unlikely for an uncommon character, for then the persons marrying into the family could seldom be even heterozygous. Contrasted with the occurrence of a dominant

character in every generation, a recessive character is regularly absent from some generations in the direct line.

All these criteria of dominance and recessiveness are based on the assumption that inheritance is simple, unmodified by the action of other genes. As will appear in later chapters, many characters are noticeably affected by more than one pair of genes; and even dominance may be modified by other genes.

PROBLEMS

39. In what respect is heredity that involves dominance less simple than heredity in which dominance is lacking?

40. Explain why, in simple human traits, it is easiest to discover which of two contrasted characters is dominant from a family in which two like parents have one or more children different from them.

41. If in a human pedigree covering several generations a strictly recessive character does not skip a generation, what assumption must be made regarding the persons from other lines who marry into the family?

42. If a heterozygote is phenotypically different from both corresponding homozygotes, it exhibits a dominant character. True, or false?

43. If a plant, on self-pollination, produces 36 offspring like itself, and a much smaller number different, how many of the 36 should breed true if self-pollinated?

44. If a very common red-flowered plant is crossed with a comparatively rare pink variety, and they yield only red offspring, what symbol would you choose for the gene for red color?

45. Two rose-combed fowls, A and B, bred together, produce only rose-combed offspring. Fowl B, mated with C which is also rose-combed, produces some rose-combed and some single-combed offspring. Assuming rose to be dominant over single and using *R* and *r* to symbolize the genes, the genotype of fowl A is _____, that of B is _____, and that of C is _____.

46. If in a large number of human families, whenever the two parents are alike all their children are like them, even though a contrasted character is fairly common in the general population, what would you conclude regarding the mode of inheritance of the character?

47. Some breeds of fowls, to be registered, must have only rose combs. In some flocks an occasional single-combed fowl is produced. How should the owner proceed to eliminate the single-comb gene from his flock?

48. Which would be the easier to establish, a true-breeding flock of rose-combed fowls or a true-breeding flock of splashed-white fowls? Why?

CHAPTER 7

BACKCROSS AND TESTCROSS

In the preceding chapters the illustrative crosses have been described as passing to an F_2 generation after the F_1 . This is a very common type of experiment. When a new character has just sprung into existence or has first been discovered, the new type can only be crossed with the "normal" or unmutated form; and to mate together their heterozygous offspring is the quickest way to get a stock of individuals showing the new character. If neither of the characters involved in the cross is new, the F_2 generation is still a very advantageous one, because there is no need to secure virgin females from the F_1 generation in order to produce it. The male and female members of the F_1 generation are together from the first, and any random matings made in advance are precisely those which the breeder would make if he chose to control them. Hence, from F_1 to F_2 is usually the easiest course.

An F_2 generation is not as a rule, however, the most instructive one. If the experimenter's object is to discover how the characters are inherited, and he has stocks of individuals exhibiting them on hand, or if the mode of inheritance is already known and he wishes only to know the genotype of certain doubtful individuals, other crosses are much more useful.

Backcross.—A common procedure in experiments is to make what is called a backcross, that is, a mating of an F_1 individual with one of its parents or with an individual having the same genotype as one of the parents. The backcross may be made to either parent, as shown in Fig. 36. The contrasted characters in this illustration are (1) the smooth coat of guinea pigs, in which the hairs on the back and sides of the body all slope in the same general direction, backwards, and (2) rough coat, in which there are whorls of hair radiating like spokes of wheels at several places on the body, causing elevated tufts where hairs of opposite slopes meet. As the central animal (F_1) in the figure shows, rough coat is dominant; smooth is recessive.

This heterozygous F_1 may then be mated with either of the parent types. Both matings are backcrosses. If the F_1 animal is mated with a smooth one (left, in the figure), two kinds of offspring, rough and

smooth in about equal numbers, are produced. If the F_1 is mated to a rough animal (right), homozygous like the rough parent, all the backcross offspring are rough, although, as is indicated below, they are of two genotypes about equally numerous.

Explanation of Backcross.—The explanation of the results of the two backcrosses is shown in Fig. 37. The general purport of the chart will be understood from the scheme used in earlier figures. On the left, the backcross results in two types of offspring, rough and smooth, in equal numbers. The backcross on the right yields only rough offspring, but they are of two genotypes, RR and Rr , equally numerous.

The 1:1 ratio, whether of phenotypes or genotypes, is characteristic of the backcross. The two classes are equally abundant because the

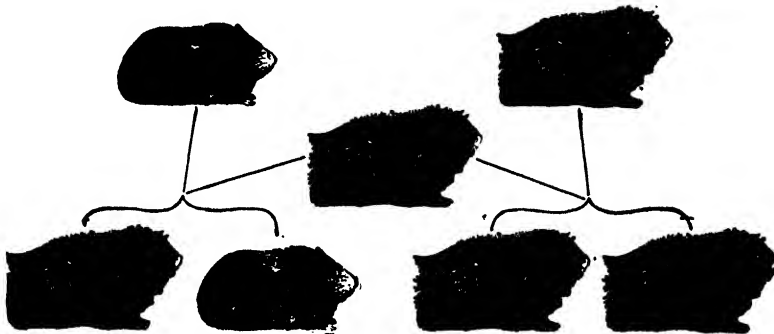

FIG. 36.—Backcrosses, illustrated by inheritance of smooth and rough coats in guinea pigs. Rough coat is dominant. Backcross to recessive parental type (left) yields two phenotypes, but to dominant parental type (right) only one phenotype.

two kinds of eggs (or spermatozoa) produced by the F_1 animal are equally numerous. The ratio of offspring is directly dependent on the ratio of germ cells produced by the heterozygous parent.

Of the two possible backcrosses, only one is usually made. That one is between the F_1 and the recessive parent type. This cross yields two kinds of offspring visibly different, that is, two phenotypes. The other backcross yields only one phenotype, and there is no way to tell which individuals are heterozygous, which homozygous. The backcross to the recessive is thus the more informative of the two.

Testcross.—The essential feature of this more usual backcross is that it is a mating between a heterozygote and a recessive homozygote. As to phenotypes, it is a mating of a dominant individual with a recessive one. Now, a dominant-recessive mating is often made in ignorance of the genotype of the dominant individual. Indeed, such a cross is frequently made for the purpose of discovering whether the dominant

individual is heterozygous or homozygous. If the offspring from such a mating are part dominant, part recessive, the dominant-appearing parent is heterozygous; if the offspring all show the dominant character, the dominant parent is homozygous.

The mating of a phenotypically dominant organism to a corresponding recessive is accordingly known as a *testcross*. The testcross is

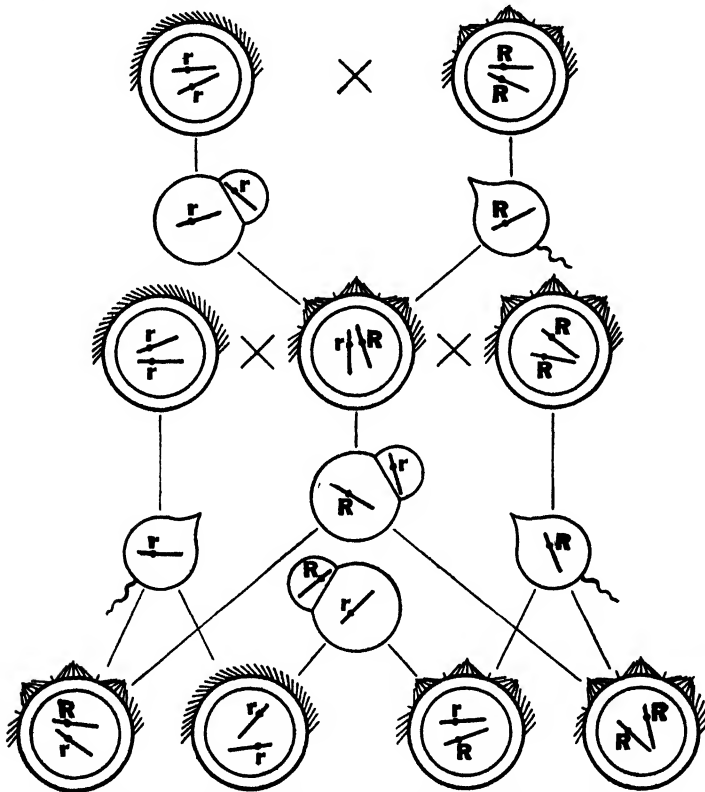

FIG. 37.—Diagram illustrating inheritance of smooth and rough coat as in Fig. 36. Uniform slope of lines at periphery of circles indicates smooth, variable slope rough coat. *R*, gene for rough coat; *r*, gene for smooth coat.

more valuable when several pairs of genes are simultaneously studied, because the same labor yields more information. It is particularly useful when some of the pairs of genes are in the same pair of chromosomes. These are topics for later chapters.

Judging Human Genotypes.—The principle of the testcross is used repeatedly in determining the genotypes of certain people, even though these people have not been deliberately crossed to a recessive type. To

make such a test, the mode of inheritance of the character in question must already be known. If it be supposed that feeble-mindedness is a simple recessive character, an assumption that is not quite justified but is nearly correct for certain types of the defect, it is often possible to say that a given individual, who is mentally normal, is heterozygous for the deficiency. This can be done for one individual in the family history shown in Fig. 38. To identify the various members of a pedigree, it is customary to designate the successive generations by Roman numerals, I, II, III, and then give the members of each generation Arabic numerals from left to right. The man II-2, who married a feeble-minded woman, is shown to be heterozygous because his son by that marriage, III-2, is feeble-minded. When this man remarried, this time a normal woman (II-3), the children in his second family have one

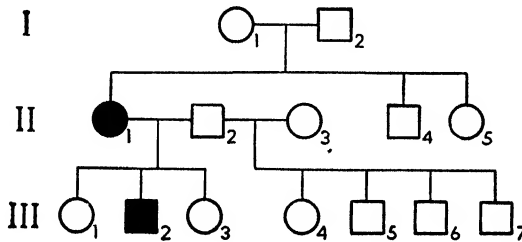

FIG. 38.—Pedigree of feeble-mindedness in an actual family, to illustrate method of determining genotype of a phenotypically dominant individual.

chance in two of being heterozygous. This is a probability which any one proposing to marry into the family ought to know, and the testcross involved in the marriage of II-1 and II-2 reveals it. Incidentally, the pedigree also shows that I-1 and I-2 were both heterozygous, but it is not a testcross which furnishes the evidence.

Backcross without Dominance.—For the sake of completeness, crosses between organisms heterozygous or homozygous for characters which lack dominance should be mentioned, though such matings need never be made to test the genotype of any individual. If a yellow four-o'clock is crossed with a white one, the offspring are pale yellow (Fig. 39), showing that neither color is dominant. If a pale yellow F_1 plant is pollinated by a deep yellow (hence homozygous) one as on the left of the figure, half their offspring should be deep yellow, half pale yellow (heterozygous). The other backcross, of F_1 to white (right of figure), yields two kinds of offspring, half pale yellow and half white. Each backcross thus results in two phenotypes among the offspring.

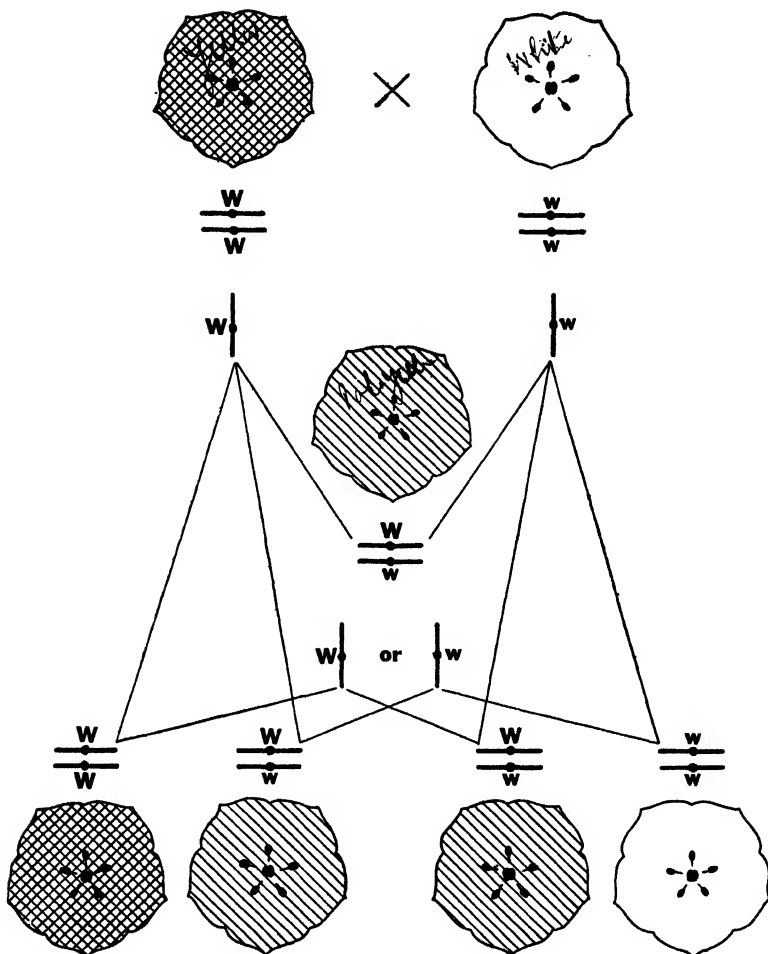

FIG. 39.—Inheritance of yellow and white color in a backcross in four-o'clocks. Cross-hatched flowers, yellow; single oblique shading, pale yellow; unshaded, white; W , gene for yellow color; w , gene for no yellow (white).

PROBLEMS

49. If a backcross results in only one distinguishable class of offspring, the parents of these offspring were phenotypically alike. True, or false?
50. A family consisting of 63 red and 59 white offspring probably came from a mating of $W_ \times _$
51. With what would you mate a black mouse to ascertain whether it is heterozygous for brown? What kind of offspring would show it to be homozygous?
52. A rough-coated guinea pig mated with a smooth one yielded 4 rough and 3 smooth offspring. Using Rr for the symbols, give the genotypes of the parents.
53. What is the argument that the woman II-3 in Fig. 38 is homozygous?

CHAPTER 8

SEX-LINKAGE

The characters whose heredity has been so far described bear no particular relation to sex. It made no difference which parent introduced which character. The two *reciprocal crosses* (crosses involving the same characters but with the sexes interchanged in the two) would yield identical results.

This equality or indifference of the sexes in these crosses springs from the fact that *each* sex has two chromosomes containing the genes for the characters in question. These chromosomes separate in the reduction division in essentially the same way in both sexes, producing two equally numerous kinds of eggs or of spermatozoa, and the eggs and spermatozoa unite at random. Under these circumstances the sexes must behave in the same fashion in transmission.

Chromosomes and Sex.—Although most of the chromosomes in animals and plants are equally represented in the two sexes, the members of one pair frequently differ. In man each sex has 48 chromosomes. Of these, 46 (23 pairs) are essentially alike in both sexes. The twenty-fourth pair in the female consists of two similar chromosomes; but in the male, one chromosome of this pair is like those of the female, while the other is much smaller (Fig. 40). The two chromosomes of this pair in the female and the similar one in the male are known as X chromosomes, while the smaller one in the male is called a Y chromosome. The X and Y chromosomes are known as *heterosomes*, the other 46 as *autosomes*.

The mammals in general are like man in this respect, the females having two X chromosomes, the male an X and a Y, and both sexes being alike in their autosomes. Or the male may have an X but lack the Y. Most insects are like mammals in this respect, though it is a little more common in them to drop the Y chromosome altogether, so that females are XX, males simply X. Some fishes are also like the mammals in their heterosomes.

In some other animals a similar situation exists, except that the sexes are reversed. These other animals are the moths, caddis flies, birds, and some fishes. In them it is the male that has two similar

heterosomes, the female two unlike ones. To indicate this reversal of the heterosome relation between the sexes, some geneticists have called the heterosomes of these several groups Z and W, respectively. The male has the constitution ZZ, the female ZW. Sometimes the W chromosome is missing, and the female has simply Z.

In all these organisms it should be made clear that sex depends on the chromosome outfit. A fly is a female primarily because it contains two X chromosomes in each cell, or a male because it has only one X

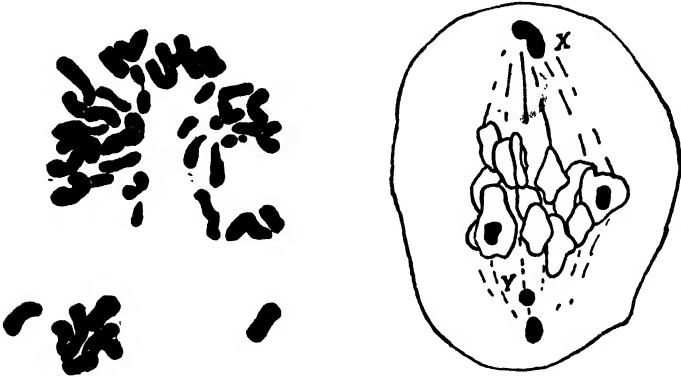

FIG. 40.—The chromosomes in man. At left, those of a dividing spermatogonium, 48 in number. At right, side view of spermatocyte at reduction division; X and Y chromosomes, unequal in size, have gone ahead of most of the other chromosomes to the ends of the spindle. (From Painter in *Journal of Experimental Zoology*.)

(with or without a Y). A moth is a male because it has two Z chromosomes, or a female because it has only one Z (perhaps with a W).

Heterosomes and Germ Cells.—These pairs of heterosomes behave in maturation essentially as do the autosomes. The X chromosomes of a female or the Z chromosomes of a male come together in a pair, and in reduction go to different germ cells, which therefore contain but one such chromosome. The X and Y in a male fly or mammal or the Z and W in a female bird or moth may not pair, since they have few genes in common and likeness of genes seems to be the reason for pairing; but they do go to different germ cells. Hence, the spermatozoa of a mammal are of two kinds, half of them containing an X chromosome, half of them a Y (or no heterosome at all in species in which Y has been lost). The eggs of a bird are of two kinds, about half of them containing a Z chromosome, half of them a W (or perhaps no heterosome of any kind).

Genes in the Heterosomes.—From these relations of the heterosomes it is clear that, if they contain genes, the characters produced

by those genes will be inherited in a special fashion. In the mammals and most insects, females will have two genes of each kind found in an X chromosome, and will transmit such genes in every egg; but males will have only one gene of each such kind unless the Y chromosome contains similar genes, and will transmit them in but one class of their spermatozoa.

These peculiarities in transmission have made it possible to discover genes located in the heterosomes. Literally hundreds of genes for various ordinary characters have been proved to exist in X chromosomes, only a few in the Y. The same peculiarities exist in Z and W chromosomes; many genes are known for the Z chromosomes, few for W.

Sex-linked Characters.—Characters produced by genes in the X or Z chromosomes are called *sex-linked* characters. A typical example is

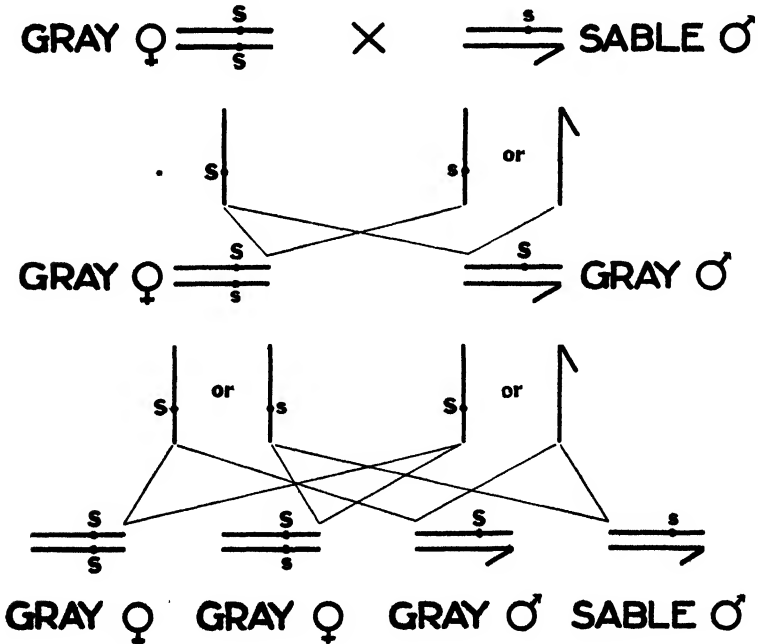

FIG. 41.—Sex-linked inheritance in *Drosophila*. Mating of gray female and sable male. Chromosomes indicated by heavy lines, genes by dots in them. X chromosomes straight, Y chromosomes bent at end. Horizontal chromosomes are those in the diploid cells of flies; vertical chromosomes are in germ cells. *S*, gene for gray; *s*, gene for sable.

that of sable, a black body color, in the vinegar fly *Drosophila*. If a wild-type female whose body color is gray is crossed with a sable male, all the F₁ generation is gray in both sexes (Fig. 41). When the F₁ males and females are mated together, the F₂ generation consists of

gray and sable approximately in the ratio of 3:1. The sable class, however, includes only males. This latter fact, that the recessive members of F_2 are all of one sex, is what indicates that sable is sex-linked and that its gene is in the X chromosome.

This result is explained by the chart in Fig. 41. The heavy straight lines represent the X chromosomes. The Y chromosome is shown bent back at one end, since it is actually J-shaped in this fly. The letter *s* represents the gene for sable, *S* its wild-type alternate (gray). As this mating was made, the female is *SS*, for she has two X chromosomes. The male is *s*, for he has only one X chromosome; the Y chromosome has no gene homologous with *S*, or at least none that is dominant over *s*. The Y chromosome can therefore be regarded as "empty" of genes in this particular cross.

The X chromosomes are separated by the reduction division, so that each egg receives one, with its gene *S*. The eggs are represented merely by the X chromosome set vertically. In the male, the X and Y are separated at the reduction division, so that two kinds of spermatozoa are produced. Half the spermatozoa contain the X chromosome—hence the gene *s*; half of them contain the Y with no pertinent gene.

Fertilization of the eggs by the two kinds of spermatozoa yields two combinations in F_1 . One of these is XX as to chromosomes and *Ss* as to color genes; it yields gray females. The other combination is XY as to chromosomes, merely *S* in genotype; it produces gray males. The F_1 generation is thus all gray in both sexes.

The F_1 females, being heterozygous, produce two kinds of eggs, and the males, as always in sex-linked characters, produce two kinds of spermatozoa, one with the X chromosome, the other with the Y. The X-bearing spermatozoa in this instance carry the gray gene *S*. Four combinations in F_2 result from the two kinds of eggs and two kinds of spermatozoa. They are shown in the bottom line of Fig. 41, where their phenotypes are also indicated. The last class in that row consists of sable males—males because they have but one X chromosome, sable because there is nothing in the Y chromosome to dominate over the gene *s* in the X. Thus a recessive character develops even when only one gene for it is present, because there is no dominant gene to prevent it from appearing.

The Reciprocal Cross.—The preceding experiment started with a dominant (gray) female and a recessive (sable) male. Earlier signs of sex-linkage are exhibited by the reciprocal cross, sable female by gray male. The offspring of this cross are not all of one color, but the females are gray and the males sable (Fig. 42), and the F_2 generation,

instead of showing a 3:1 ratio, consists of gray and sable in about the ratio 1:1. The two sexes in F₂ are, however, equally represented in the two color classes.

The chart in Fig. 42 explains why these results are obtained. The males in F₁, receiving their single X chromosomes from their mothers, obtain along with them the gene *s*. Hence, since nothing in the Y chromosome is dominant over *s*, these males are sable. In the F₂ gen-

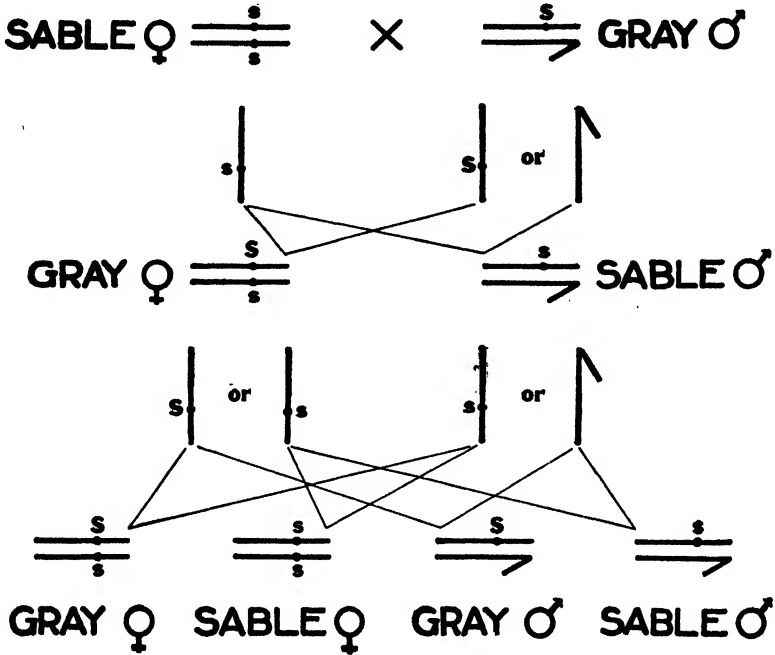

FIG. 42.—Sex-linked cross, reciprocal to that in Fig. 41. The recessive character is introduced with the female, the dominant with the male. Signs of sex-linkage are observed as early as the F₁ generation.

eration, one of the XX combinations is *ss* as to genes, and sable females appear, a class not included in the F₂ of Fig. 41.

Color Blindness in Man.—Several characters in man are known to be sex-linked. One of them is color blindness, particularly the inability to distinguish reds from greens. Since extensive experiments to determine the mode of inheritance of human characters cannot be performed, it will be valuable practice in the interpretation of family histories to consider how the sex-linked status is assigned to color blindness.

First, the defect is much more common in men than in women. There are about ten color-blind men for every color-blind woman.

This fact by itself is enough to create the presumption that the character is sex-linked. The reason for this is that a male need receive the gene for such a character from only one parent (his mother) in order to show it, whereas a female, to exhibit a recessive sex-linked character, must receive the gene from both parents.

Second, although women do not often show color blindness, they transmit it as readily as men do. Men transmit the character through

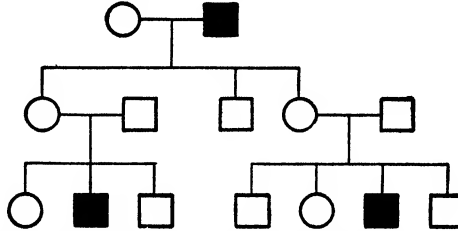

FIG. 43.—Pedigree of color blindness in man, showing that women, though not themselves color-blind, transmit the defect from their fathers to some of their sons.

their daughters, who do not exhibit it, to half of the sons of those daughters. This skipping of the females and reappearance in some of the males of the next generation is illustrated in the family history of Fig. 43. The two color-blind males of the last generation owe their color blindness to that of their grandfather, though their mothers are phenotypically normal. This is the behavior of sex-linked characters in species having XY or XO males.

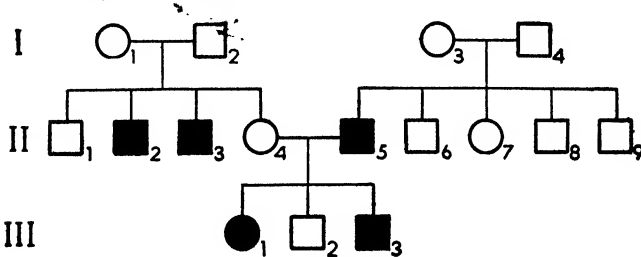

FIG. 44.—Pedigree of color blindness, including the rare occurrence of the character in both father and son. The reason is a heterozygous mother.

Finally, color blindness rarely occurs in both father and son. A sex-linked character should not appear in both father and son unless the mother also possesses the gene, since males (XY or XO) inherit such characters only from their mothers. In human families a marriage of a color-blind man to a heterozygous woman is rather uncommon, but it does occur. The family history in Fig. 44 includes an example of such a marriage, and, as a result, III-3 is one of the few color-blind men who

have a color-blind father. The reason for his color blindness is not his father's color blindness but his mother's heterozygosis. That the mother (II-4) is heterozygous is further shown by her color-blind daughter, III-1. It must be inferred, incidentally, that I-1 and I-3 are likewise heterozygous.

Sex-linkage through Z Chromosome.—For an example of sex-linked characters in species whose males are ZZ and females ZW, the ornamental fish *Platypoecilus* may be used. The inheritance of a black body color proves that in this species the female is ZW, the male ZZ. The result of a cross between gray and black is shown in Fig. 45.

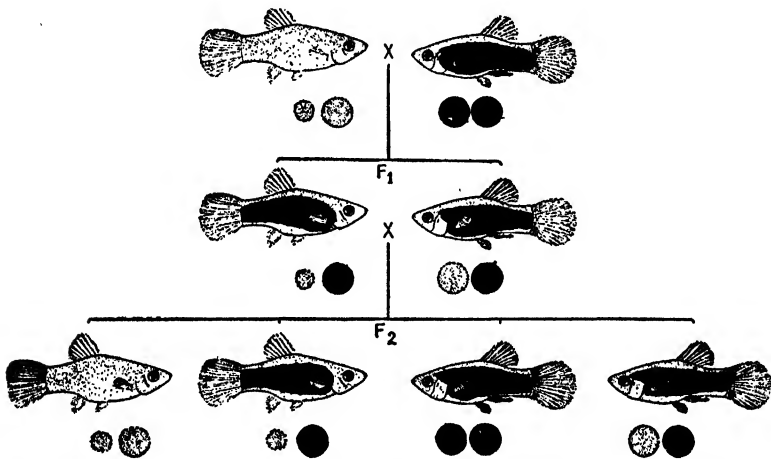

FIG. 45.—Sex-linked inheritance in a ZZ-ZW species, the fish *Platypoecilus*. Gray female is crossed with black male. Circles below fishes are chromosomes, large ones Z, small ones W. Black chromosomes contain the gene for black, dotted chromosomes the gene for gray. (Modified from Gordon in *The Aquarium*.)

The sexes may be recognized by their lower fins, the posterior lower one of the male being somewhat fingerlike and lying up near the body, while in the female the corresponding fin is a blade projecting down into the water like other fins. In Fig. 45 the female parent is on the left, the male on the right.

The circles beneath the fishes represent the pertinent pair of chromosomes. It is assumed that the W chromosome is smaller than the Z, and the female is shown as WZ, the male ZZ. A black chromosome indicates that it contains the gene for black color; only the Z chromosomes are distinguished in this way, since the W chromosome contains no detectable gene related to this body color. The male parent is homozygous for black, whereas the female has the gray gene

in her Z (larger) chromosome. The male produces but one kind of spermatozoon (not separately shown in the figure); but the female produces two kinds of eggs, one with the Z chromosome and gray gene, the other with the W chromosome with no gene.

From these germ cells arise two combinations in F_1 , which are the two sexes. Since the Z chromosome of the female (left) and each of the Z's of the male (right) contain the gene for black color and since this gene is dominant over gray, all members of F_1 are black, both sexes alike.

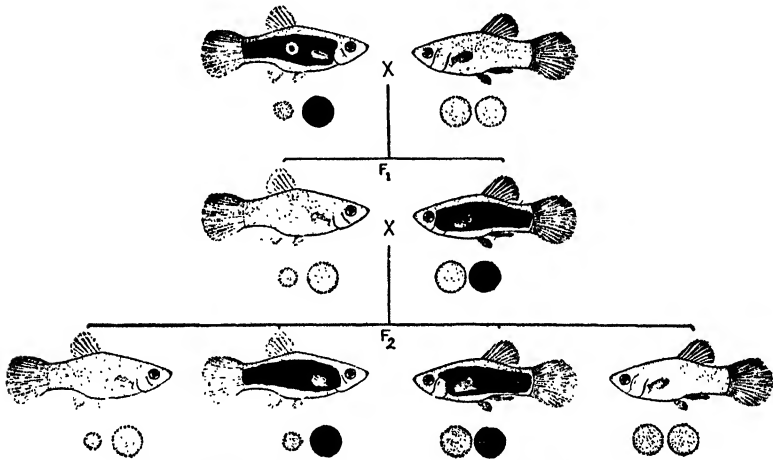

FIG. 46.—Cross in *Platypoecilus* reciprocal to that in Fig. 45. The F_1 generation shows the body color to be sex-linked, since females are phenotypically recessive, males dominant. (Modified from Gordon in *The Aquarium*.)

The two kinds of eggs and the two kinds of spermatozoa produced by the F_1 animals yield four combinations in F_2 , as shown in the lower line of Fig. 45. The two at the right are males because of the two Z chromosomes, the two at the left are females (WZ). Although the ratio of the two colors is $\frac{3}{4}$ black to $\frac{1}{4}$ gray, as in a typical F_2 generation involving any dominant character, the recessive fishes (gray) are all females. This shows that the color is a sex-linked character.

When the reciprocal cross is made (Fig. 46), by introducing the black pattern through the female, the F_1 is divided sharply into two classes, gray females and black males. From them an F_2 is obtained in which the ratio of colors is 1:1, instead of 3:1 as in autosomal characters, and the sexes are equally represented in both classes.

Precisely the same numerical results are obtained as with gray and sable body colors in *Drosophila*, but the sexes are reversed in their

relation to the mode of transmission. The results obtained in the fly from mating a recessive female and dominant male are obtained in *Platypocilus* from mating a dominant female and recessive male, and vice versa. This is the evidence that *Platypocilus* has Z and W chromosomes, for the chromosomes are not known from direct observation.

Y-chromosome Characters.—Not always regarded as sex-linked, but inherited in a special way because of the relation of chromosomes to sex, are those characters dependent on genes in the Y chromosome. Relatively few such characters are known. One likely reason for their

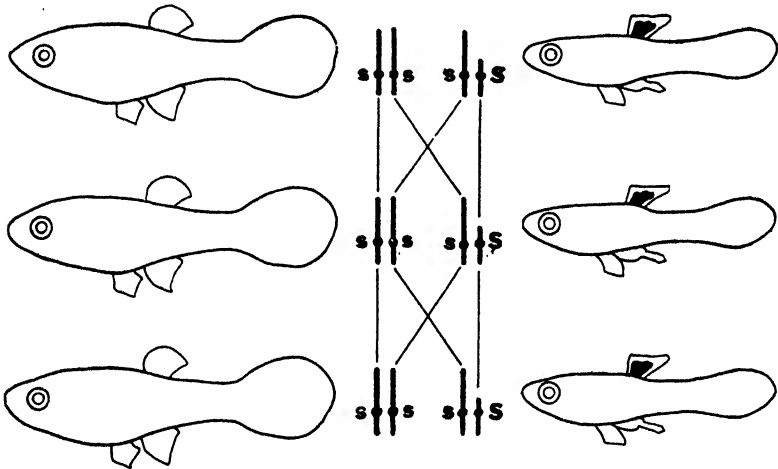

FIG. 47.—Inheritance through the Y chromosome. The black spot on the dorsal fin of the fish *Lebistes* is confined to males because its gene is in the Y chromosome. X chromosomes are the long heavy vertical lines, Y chromosomes the shorter lines. *S*, gene for dorsal-fin spot; *s*, gene for no spot.

scarcity is the existence of relatively few genes in the Y. Another reason is that a gene in the Y chromosome, in order to produce a character, must usually be dominant. There is under normal circumstances only one Y chromosome in each cell, along with an X, so that genes in the Y must be dominant over any homologous genes in the X in order to come to expression.

One character inherited in this fashion is a black spot on the dorsal fin of an ornamental fish, *Lebistes reticulatus*. This example is one of the first to demonstrate Y-chromosome inheritance, and will serve to show that, though some species of fish have the ZZ-ZW chromosome outfit, other fish are of the XX-XY type. *Lebistes* is one having X and Y chromosomes in the male, and the spot in question is transmitted

only from father to son (Fig. 47). In this figure the males are all shown on the right, and their Y chromosomes are assumed to be smaller than the X. The separate designation of germ cells is omitted from this figure, but the chromosomes are traced from generation to generation. Every combination of two X chromosomes, which is necessary to produce a female, has only the genes *ss*, and the resulting fish lacks the spot. Every combination of an X and a Y chromosome correspondingly possesses the genes *Ss*, and a spotted male is produced. This mode of transmission continues as long as the gene *S* is confined to the Y chromosome. Other lines of descent, in which the Y chromosomes have the gene *s* at that locus, produce spotless males.

In one human pedigree of four generations syndactyly (webbed toes or the side-by-side union of the digits) was found to pass from father to son and not through daughters to their sons. This suggested that the gene may be in the Y chromosome. Haldane believes there is evidence that genes for certain human diseases may be located in either the X or the Y chromosome. These diseases are complete color blindness, xeroderma pigmentosum, Oguchi's disease, recessive epidermolysis bullosa dystrophica, and some cases of both dominant and recessive retinitis pigmentosa.

PROBLEMS

54. If in a species a certain character is frequently transmitted through males which do not themselves show it but is not similarly transmitted through females which do not show it, what kind of heterosomes does the species possess?

55. If a male animal receives his sex-linked genes only from his mother, in which kind of heterosome are these genes?

56. If a recessive female butterfly is mated with a dominant male, which generation, F_1 or F_2 , would first show whether the character is sex-linked?

57. If a male bug has 16 chromosomes in each body cell, one of them is a Y. True, or false?

58. A recessive sex-linked mutation arising in a mammal in nature should appear mostly in which sex?

59. A homozygous red-eyed *Drosophila* female mated with a white-eyed male produces red-eyed daughters and white-eyed sons. (These colors are sex-linked and red is dominant.)

60. A white-eyed female *Drosophila* mated with a red-eyed male produces red-eyed daughters and white-eyed sons.

61. A color-blind woman who marries a normal man should have _____ daughters and _____ sons.

62. The gene for a character that is handed on only from father to son for many generations is probably in the _____.

63. If a woman, herself color-blind, has 6 sons, how many of them should be color-blind?

64. Black is a sex-linked character recessive to barred pattern in fowls. If a barred hen is mated with a black cock, the female F_1 offspring should be _____, the male F_1 black.

65. A type of muscular dystrophy (wasting away of the muscles) in man is a recessive sex-linked character that is fatal in early youth. Why is there no recorded case of a girl so afflicted? How could a dystrophic girl be produced?

66. Why is it easier to discover sex-linked recessive mutations than autosomal recessives? Would dominant sex-linked mutations have the same advantage over autosomal dominants?

CHAPTER 9

MULTIPLE ALLELES

In simple genetic experiments one form or condition of a character is contrasted with another form or condition of the same character, as two eye colors, two wing shapes, two color patterns. The genes which are responsible for these two conditions are said to be homologous with one another. They are so related that in the reduction division of maturation they regularly go to different cells. Each germ cell receives one, but not both.

Two genes that necessarily go to different mature germ cells are called *alleles*. Each is an allele of, or is allelic to, the other. These alternative genes are located at the same places, or loci, in their respective chromosomes. The two conditions of a structure, color, or physiological property which these genes principally help to develop are likewise called alleles. Brown and blue eyes in man are alleles of each other, as are yellow and white flower color in four-o'clocks, red and white color in snapdragons, rough and smooth coat in guinea pigs.

Origin of Alleles.—How does it happen that there are different eye colors, different coat colors, and different genes in their respective chromosomes to produce the different phenotypes? They do not always exist. In a young species, one lately arisen from a single ancestry, many of the loci of the homologous chromosomes are occupied each by just one kind of gene. Alleles of these genes arise by mutation. When gene *B* changes chemically, so that in cooperation with the genotype in general it produces a different character, a new gene has sprung into existence at the locus ordinarily occupied by *B*. If the new character is recessive to the old one, the new gene is designated *b*. *B* and *b* are alleles; *M* and *m* are alleles, the one having sprung by mutation from the other. Mutation of a gene produces a new gene in one chromosome, and as a result there are two alleles at that locus.

Multiple Alleles.—Now, genes are probably protein substances, and proteins are of very complex structure. Complex structures have more opportunities to change than simple ones have. Hence, even if a gene is only one molecule of a protein, it probably has the capacity of changing in a variety of ways. A gene should be able to produce by

mutation, not just one other kind of gene, but many kinds. It is known, in fact, that this has happened to a number of genes in different organisms. Since any individual has two chromosomes of each kind, it may have any two of the genes that have arisen at a certain locus. These two, because they are at the same locus and come together as the chromosomes pair, are forced to go to different germ cells in the reduction division. They are thus alleles of one another. Any one of the genes may be allelic to any other gene at that locus.

Three or more genes occupying the same locus of homologous chromosomes in a species are called *multiple alleles*.

White-eye Series in *Drosophila*.—One of the largest known groups of multiple alleles is one that concerns eye color in the vinegar fly *Drosophila*. The wild-type eye color is red. In the year 1910 there was discovered a fly with white eyes, which was later found to be due to mutation of a gene located 1.5 "units" from the "left" end of chromosome 1. In the years of experimentation that have followed, the gene at that locus has mutated again and again. Mostly it has been the wild-type gene in some individual that has mutated, but occasionally one of the mutant forms of the gene has changed to something else. Some of the eye colors resulting from these mutations have been named eosin, apricot, cherry, coral, buff, tinged, blood, and ivory. In all there have been produced 13 mutant genes at that locus. Hence, with the wild-type gene from which they all directly or indirectly arose, there are 14 alleles in this series.

A female fly may have any two of these genes—two eosin genes, or an eosin and a white, or a white and an apricot, or wild-type red and a coral, and so on. In the reduction division the two genes, whichever two they are, separate, one going to the polar body, the other to the oöcyte. Two classes of eggs are produced by a female that has two different genes of this allelic series, just as by any other heterozygous organism. Though only two kinds of eggs may be produced by any one fly, 14 kinds of eggs with respect to this character may be produced by members of the species as a whole.

Symbols of Multiple Alleles.—With more than two genes occupying a given locus in a species, it becomes impossible to use the simple scheme of symbolizing alleles by capital and small letters. *A* and *a* would suffice for two of them, but how are the others to be named? A practice has grown up among geneticists of distinguishing the various alleles of a multiple series by superscripts of a common basic symbol. In the white-eye series in *Drosophila*, since white was the first mutation to be discovered at this locus, the basic symbol is *w*. The white-eye

gene is designated simply by w , but the later mutations are indicated by superscripts. The eosin gene is w^e , apricot w^a , cherry w^c , coral w^{co} , and so on. In harmony with this scheme it is common to call the wild-type gene not W but w^+ , the sign $+$ having long been used to indicate the wild-type fly or characters as contrasted with any or all of the mutant characters or genes.

Multiple Alleles in Other Animals and Plants.—Since every gene probably is able to mutate in more than one way, multiple alleles should be common. A number of series are in fact known, several in plants, more in animals. In rabbits color (C or c^+), albinism (c^a), Himalayan albinism (c^h), and chinchilla (c^{ch}) are members of an allelic

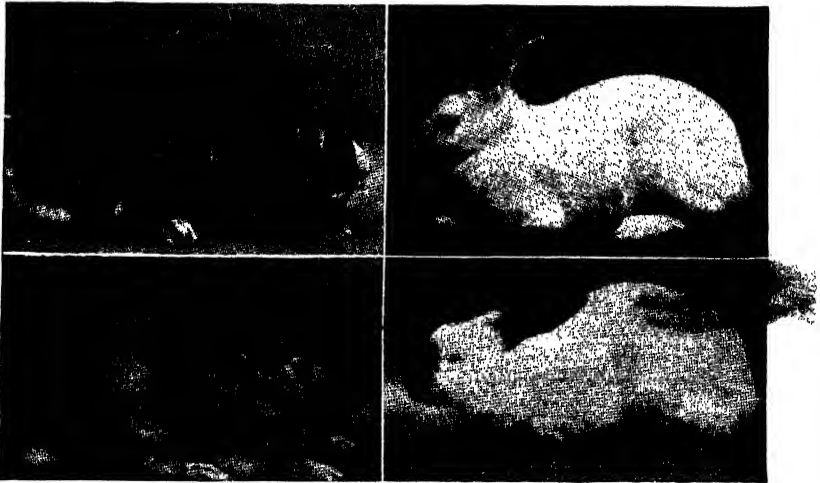

FIG. 48.—Multiple alleles in the rabbit. Upper left, wild type; upper right, albino; lower left, chinchilla; lower right, Himalayan. (From Castle in *Journal of Heredity*.)

series (Fig. 48). In mice there are two well-known series. One consists of color (C or c^+), chinchilla, which is dilute color (c^{ch}), Himalayan dilution (c^h), and albino (c^a). The other series is made up of yellow (A^Y); agouti (which is gray because the pigments are separated into different regions on each individual hair) with light belly (A^L); agouti with gray belly, as in the wild-type mouse (A); the so-called black and tan, which is black back and light belly (a^t); and nonagouti, or absence of the localization of pigment in the hairs, leaving the coat a solid color, such as black or brown (a).

Among plants the snapdragons furnish the largest known series of multiple alleles. There are nine allelic genes representing solid flower colors ranging from red to ivory, besides a red-striped pattern. Corn has some known multiple alleles, as has also barley.

Dominance among Multiple Alleles.—An individual that is heterozygous for the wild-type gene and one of its multiple mutants generally shows the wild-type character. For example, a vinegar fly whose genotype is Ww^e (or w^+w^e), which means that one of the chromosomes of a certain pair contains the eosin gene and the other the wild-type (red) allele of eosin, is wild type (red-eyed). There are some exceptions to this dominance of wild type among the examples cited in the preceding section; for example, yellow (A^Y) and agouti with light belly (A^L) in mice are both dominant over wild-type agouti (A).

In *compounds*, which are individuals heterozygous for two of the mutant alleles, the dominance relation varies. In *Drosophila*, the phenotype of a compound is usually intermediate between the corresponding homozygous mutants. The eosin-white compound (ww^e) has pale eosin eyes, and the apricot-white compound (ww^a) has light apricot eyes. In the albino series in mice (C, c^h, c^k, c^a) the compounds are likewise all intermediate. Dominance is lacking in these instances. However, in the agouti series in mice there is dominance among the mutant alleles, the order of dominance being A^Y, A^L, A, a^t, a , that is, any gene of this series is dominant over any gene following it, with a slight exception as between A and a^t . Thus, $A^Y A^L$ and $A^Y A$ are both yellow; $a^t a$ is black and tan; and $A a$ is agouti with gray belly (wild type). But $A a^t$, while agouti with gray belly, has a lighter belly than the wild-type mouse has.

When the two genes in a heterozygote help to produce characters that do not interfere with one another, so that both characters could exist in the same individual, it is possible for both genes to be dominant. An example is found in the sections that follow.

Blood Groups in Man.—Certain peculiarities of human blood have received much attention because of their clinical importance. While the red cells of blood float freely and separately in their own serum, it was long ago discovered that red cells from one person introduced into the serum of another person might be agglutinated, that is, collected into little irregular clumps. Not every serum agglutinates the red cells of any particular person, but some combinations led to that result. The reaction was a constant one, for when it was found that the serum of one person agglutinates the red cells of another, every repetition of the test between these same two people gave the same result. Since in blood transfusions it would be serious to introduce blood whose red cells would be agglutinated in the patient, hospitals have had to develop a technique of ascertaining the nature of the blood

of both donor and recipient before the transfer is made. That is why so much is known concerning the agglutination phenomenon.

The differences between bloods lie in their possession (or lack) of certain substances called *agglutinogens* in the red cells and certain other substances called *agglutinins* in the serum. Two of the agglutinogens are designated A and B. A given blood may have one, or the other, or both, or neither of them. There are accordingly four kinds of blood, or four *blood groups*. Blood with both agglutinogens in its red cells is said to belong to blood group AB, blood with A only is of blood group A, that which has only B is of group B, and blood which has neither agglutinin is said to be of blood group O.

The agglutinins of the serum are likewise of two kinds, α and β . A given serum may have either, or both, or neither of these substances; but their presence or absence has a very definite relation to the presence or absence of the agglutinogens in the red cells. Blood that has agglutinin A in its red cells *does not* have α in its serum; and conversely, if agglutinin α is in the serum, there is no A in the cells. The two substances are mutually exclusive in any blood. Likewise B and β do not coexist in any blood. These substances are, in fact, the reason for the clumping of the red cells. Bringing red cells with B into serum with β causes the cells to agglutinate; hence, no blood could have both. Cells with A would likewise clump in serum with α ; consequently no blood could have both A and α . Blood of group AB cannot, therefore, have either agglutinin in the serum, while blood of group O can and does have both α and β in the serum.

From the above it will be seen what bloods can be safely mixed. A and α must not be brought together; so also must B and β be kept apart. Cells of group A would agglutinate in serum of group B or in that of group O, because each of these sera contains α . Cells of group B are agglutinated by serum of either A or O, because each of these sera contains β . Cells of group AB are agglutinated by serum of any of the other groups; but cells of group O are not agglutinated by any other serum.

Clinical Test for Blood Group.—Hospitals use these facts in determining what bloods may be used in transfusion. A simple procedure is the following. Serum of group A and that of group B are kept on hand. A small quantity of each serum is placed on a slide, and a little of the blood to be tested is dropped into each. If neither serum agglutinates the cells, the unknown blood is of group O (Fig. 49, top); if serum of group B clumps the cells but that of A does not, the blood is

of group A; if serum A agglutinates the cells but serum B does not, the blood is of group B; and if both sera clump the cells, the blood being tested is of group AB.

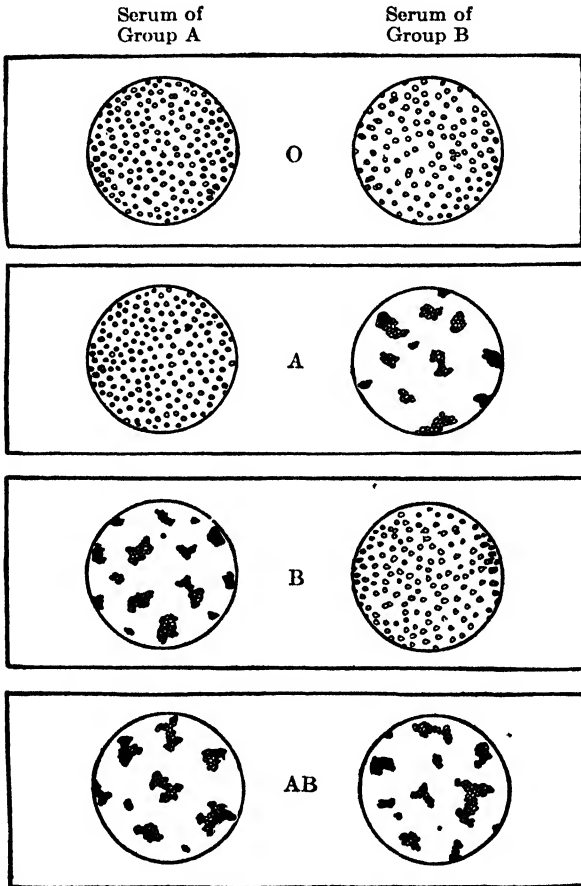

FIG. 49.—Technique of determining group to which an unknown blood belongs. Two drops of serum, one of group A, the other of group B, are put on a glass slide, and a bit of the unknown blood placed in each. If the red cells agglutinate in one, or both, or neither of the drops of serum, the group of the unknown blood is determined in accordance with the scheme illustrated. (Modified from Snyder, *Blood Grouping*, Williams and Wilkins Co.)

Inheritance of Agglutinogens.—Since there is a fixed relation between the agglutinogens and the agglutinins, the inheritance of blood groups may be described in terms of the agglutinogens alone. It is found that each agglutinogen owes its presence to a dominant gene, so that an agglutinogen is developed if there is even one gene for it.

The genes are alleles of one another, so that one person may have two genes—one gene twice, or the other twice, or one of each. In addition there is at the same locus in the chromosome in some individuals a third gene that produces no agglutinin at all. These three genes constitute, therefore, a series of multiple (triple) alleles. Following the usual scheme of symbols, the gene for agglutinin A may be designated A , that for agglutinin B is called A^B , while the gene for no agglutinin is a . Genes A and A^B are both dominant over a , but neither is dominant over the other. Thus, either AA or Aa yields blood group A; either $A^B A^B$ or $A^B a$ produces group B; aa produces group O; and AA^B produces blood group AB.

Multiple Allelism Probably Common in Man.—Multiple alleles must be expected to occur frequently, in man as in other animals. Probable examples are common. Often a defect appears in different families in somewhat different form, though with some uniformity within each single family. The simplest explanation of such discrepancies is to assume that the same locus of the chromosomes is involved in each case but that the gene is slightly different. Even so apparently simple a character as eye color, which exists in various grades of brown, paling out to blue, may be determined in part by different alleles of a multiple series, though there are other plausible explanations of its variability.

Among the human characters that could easily become multiple alleles are two other agglutinogens in the red blood cells. They are called M and N. They are not clinically important, for there is nothing in the serum to agglutinate the cells containing these substances. They can be detected only by injecting them into the veins of other animals (rabbits, for example) where antibodies are developed in response to the injected substances and then using the antisera in suitable tests. By this method it may be discovered whether a given blood contains M or N. The results of such tests show that every person has either M (being homozygous for a gene producing it), or N (being homozygous for a gene producing this substance), or both M and N (being heterozygous for the two genes). M and N are thus alleles of one another. What prevents them from being *multiple* alleles is that, so far as is known, no one lacks both substances. That is, a gene at the same locus that will not produce either M or N has not yet been found. A mere mutation of the gene for M or that for N to a gene that will produce neither substance is all that is required to render the situation of M and N parallel to that of A and B. But that is all that is necessary to originate a group of multiple alleles at *any* locus

where there are already two unlike genes in different homologous chromosomes.

It seems likely, therefore, that some of the supposed instances of multiple alleles in man are actually such, though complete proof is not so easy to obtain as in other animals.

PROBLEMS

67. What would happen if human blood having agglutinin A in its red cells also had agglutinin α in its plasma?

68. If in a given species one gene had mutated several times so that genes d^+ , d , d^u , d^v existed at that locus, what 10 genotypes could individuals of the species have with respect to that locus?

69. If in a plant species having red flowers a gene affecting color mutated to produce blue flowers, then purple, then lavender, how would you symbolize the four genes then existing at that locus?

70. If genes are protein bodies, how likely is it that there are, or have been, multiple alleles at all gene loci?

71. If a person of blood group O marries one of blood group AB, what blood groups should occur among their children?

72. When two incompatible blood groups are mixed in a transfusion, are the red cells of both the donor and the recipient clumped? Why?

73. In what normal living tissue could there be three genes of one multiple-allelic series in each cell?

74. How many human blood groups are there with respect to the MN agglutinogens? Why is the number different from that of the AB types?

75. Two parents, each of blood group A, have a child of group O. What are the genotypes of the parents? What is the chance that their next child will likewise be of group O?

76. A woman of blood group B marries a man of group A, and their first child is of group A. What is the mother's genotype? If their second child is of group B, what is the father's genotype? If these parents were to have eight children, how many of them should be of group AB?

CHAPTER 10

LETHAL CHARACTERS

Partly because they modify expected ratios of classes of individuals, partly because of various influences on evolution, lethal genes or lethal situations of other sorts are of some importance. A lethal gene or character or modification of any sort is one that destroys the individual having a certain constitution with respect to it.

Missing Chromosomes.—Several distinct types of genetic situations have the fatal result described. Some of them are easily understood. For example, an entire chromosome may be missing. Through nondisjunction (pages 18 and 42), or the failure of duplicated or paired chromosomes to go to different daughter cells at division, a cell may

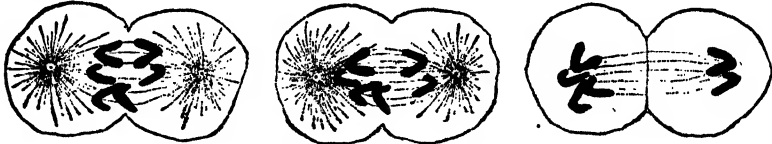

FIG. 50.—Nondisjunction, or the conveyance, to the same cell, of two chromosomes which would ordinarily go to different cells. The lower two chromosomes in each figure are the ones that remain together instead of separating.

arise that lacks one of the usual chromosomes (Fig. 50). In a diploid cell this would not usually be a serious defect, since the homologue of the missing chromosome is still present, and no kind of chromosome or gene would be wholly lacking. Nondisjunction may happen, however, in the reduction division of an oöcyte or spermatocyte, and, since the mature germ cells are haploid, some of them may as a result lack certain genes altogether. In the germ cells themselves this lack of specific genes usually does little harm in animals, because in them the success of the germ cells is not ordinarily dependent on the contained genes. Even the offspring derived from a germ cell lacking a chromosome does not necessarily suffer damage, if the other germ cell uniting with the deficient one in fertilization has a complete set. The resulting individual would merely be haploid for one of its chromosomes, diploid for the others. Yet even this condition may change the visible characters of an organism. In *Drosophila*, for example, nondisjunction in an egg

with subsequent fertilization by a normal spermatozoon has produced a fly that lacks one chromosome of the small spherical "fourth" pair (Fig. 51). This fly is accordingly known as haplo-4. It shows its

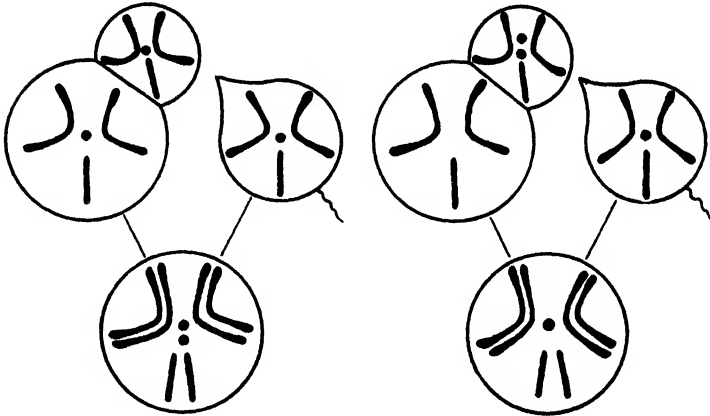

FIG. 51.—Production of haplo-4 in *Drosophila*, or a fly having only one fourth chromosome. Nondisjunction results in the polar body having two fourth chromosomes, the egg none (right). Fertilization by a normal spermatozoon introduces one chromosome of that pair into the zygote. Normal maturation and fertilization at left for comparison.

lack of one chromosome by having short blunt wings, paler cross-stripes (Fig. 52), rough eyes, slenderer bristles, slower development, and higher mortality, and it may be sterile.

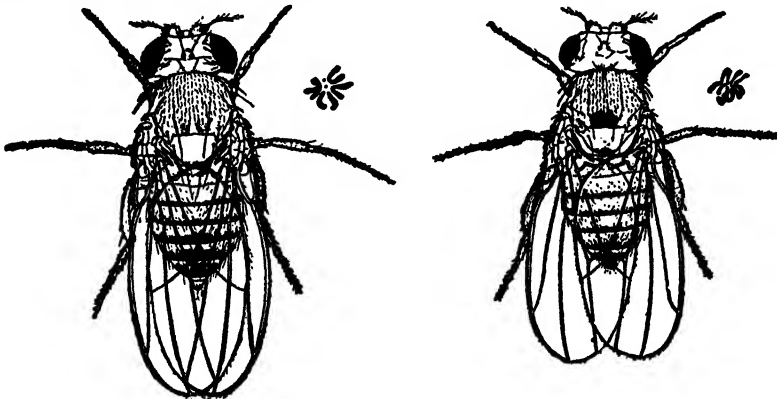

FIG. 52.—Haplo-4 *Drosophila* (right), compared with the wild type. The group of chromosomes characterizing each is shown beside it. (From Bridges.)

Because of the higher mortality that it entails, even the haplo-4 condition may be regarded as semilethal. The real lethality of missing chromosomes appears, however, when both chromosomes of a pair are

absent. This may easily happen with respect to the fourth chromosome in *Drosophila* when egg and spermatozoon both lack it. This regularly occurs in a certain proportion of the fertilizations among the descendants of haplo-4 flies. Those fertilized eggs which contain no fourth chromosome at all do not survive.

Deficiencies.—If the total absence of one particular kind of chromosome is fatal merely because some vital feature of the organism is thus lost, it should sometimes happen that losses smaller than whole chromosomes would be lethal. Chromosomes are occasionally fragmented, and various things happen to the pieces. They may be turned end about in the same chromosome, they may be attached to an entire chromosome of the same pair, they may be attached to a chromosome of some other pair, or they may be lost in the cytoplasm. In the last

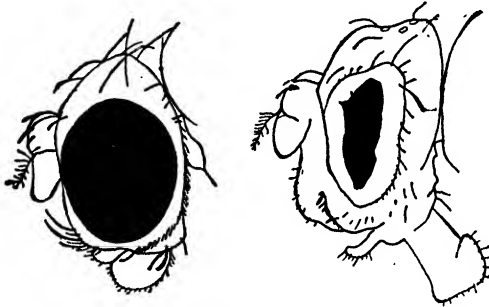

FIG. 53.—Bar eye (right) of the vinegar fly *Drosophila* as contrasted with the normal eye (left). (From Morgan, Sturtevant, Muller, and Bridges, *Mechanism of Mendelian Heredity*, Henry Holt & Co.)

two eventualities, they are lost to their original chromosomes. Such losses of fractions of chromosomes, or the gaps where they had been, are known as *deficiencies*.

If a deficiency involves some essential feature of the constitution of an organism, individuals homozygous for it cannot survive. Not all deficiencies are lethal, however; a two-gene deficiency in the region of the yellow-body gene and one involving at least four of the bands (salivary-gland chromosomes, pages 33–35), both near the left end of the X chromosome in *Drosophila*, permit even homozygotes to survive, though one of them reduces fertility. Similar nonlethal homozygous deficiencies have been found in corn. The explanation of them is presumably that in evolution chromosomes have been broken up and their pieces recombined in new chromosomes. In this shuffling and redealing of the genes, it is certain that the same gene sometimes comes to be represented at two or more places, either in the same chromosome

or in chromosomes of different pairs. When this has taken place, and then at a later time one of the repeated genes is lost through deficiency, that loss should scarcely prove fatal. Bar eye in *Drosophila*, in which the area of the eye is limited to a narrow vertical band in place of the large round normal eye (Fig. 53), is due to a repetition of a group of genes, one group immediately adjoining the other in the same chromosome (Fig. 54), and it has been found that presumed deficiency for bar is not lethal. That is, one of the repeated groups may be removed, and the fly lives. Its eyes are then like those of the wild type.

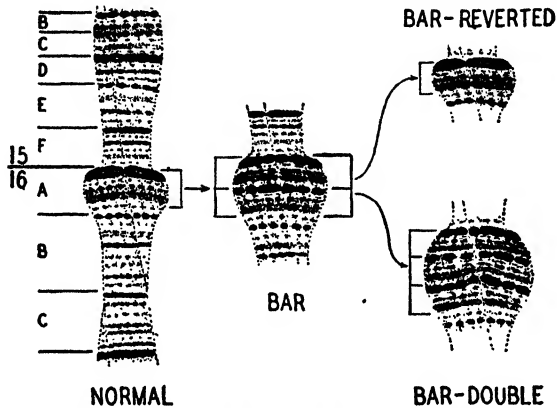

FIG. 54.—The bar duplication in salivary-gland chromosomes of *Drosophila*. Portion of normal X chromosome at left. Most of its segment 16A is repeated in bar flies (middle). If, through irregularities at meiosis, one of the repeated segments 16A is lost from bar, bar-reverted (upper right) is produced; it is not lethal, since each gene is still represented. Adding a third segment 16A produces bar-double (lower right), whose eye is still smaller. (From *Bridges in Science*.)

Lethal Genes.—A gene need not be absent to kill the organism in which it should exist. It may mutate to some form which is incapable of accomplishing an essential end or which produces a positively injurious effect. It is probable that dominant lethal mutations are occasionally produced. These are not usually discovered, however, because the individuals in which they exist perish before the character, if visible, comes to expression. Since, however, visible mutations are mostly recessive to their prototypes, it is probable that most lethal mutations are recessive. Recessive lethal genes can be carried along in a stock of organisms, surviving only in heterozygotes, but regularly entering into some homozygous combinations which thereupon die.

Some of the easiest lethal genes to discover are those having two effects—their lethal effect for which they are recessive, and a visible effect for which they are dominant. A classical example is the gene

for yellow coat in mice. This gene is a member of one of the series of multiple alleles in mice (Chap. 9) and is symbolized by A^Y . The use of the capital letter in this symbol indicates its dominance with respect to coat color; but in its lethal effect it is recessive. This situation leads to a modified ratio of the two color classes in certain crosses. When-

ever a yellow mouse is crossed with a nonyellow (agouti, for example), two kinds of offspring are produced (Fig. 55). This result shows that one of the mice used was heterozygous, the other a homozygous recessive. If the mode of inheritance of these colors were unknown, it might be assumed that either the yellow or the agouti mouse was the heterozygous one; and, to determine which one, it would be necessary to breed each type further. If two of the agouti mice from the first cross be mated, they yield only agouti offspring, showing that the agoutis were not heterozygous for yellow. But if two of the yellow mice from the first cross are bred, they yield both yellow and agouti offspring. Plainly it was the yellow mouse that was heterozygous.

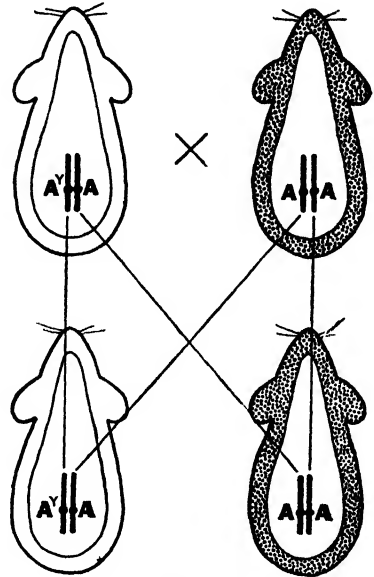

FIG. 55.—Cross between yellow mouse and agouti, showing that one of these mice is heterozygous. Plain figures, yellow mice; dotted figures, agouti. A^Y , gene for yellow; A , gene for agouti.

This happens every time a yellow mouse is crossed to one of another color, so that all yellows must be heterozygous.

A yellow mouse may be heterozygous for any of the other alleles of this multiple series. It may contain the genes for yellow and black, or yellow and black-and-tan, or yellow and nonagouti. Every yellow mouse, even in the absence of knowledge of its parentage, may safely be regarded as heterozygous. Why are there no homozygous yellows? It is because the homozygotes die. Suppose that two yellows are mated and that the other gene possessed by each of them is the nonagouti gene a , which leads in mice homozygous for it to solid black color. They produce offspring of two phenotypes, yellow and black (Fig. 56), but these are in the ratio of about 2:1 instead of 3:1. Moreover, when the yellows are bred further, they prove to be all hetero-

zygous. There is no class of homozygous yellows. The only suitable explanation of these results is that the combination $A^Y A^Y$ is lethal. The eggs are fertilized, but the embryos die. Abortive fetuses are more common in pregnant yellow mice, and the litters from yellow mothers mated to yellow males are on the whole smaller than those from mothers of other colors, and abortive fetuses are more common in these yellow mothers than in mothers of other colors, all of which is in harmony with the assumption that homozygous yellows die.

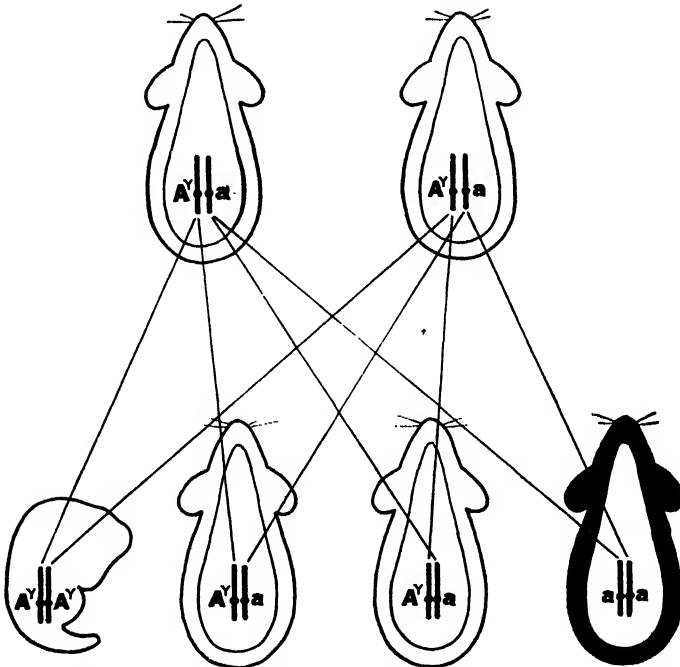

FIG. 56.—Cross between two yellow mice. A^Y , gene for yellow; a , gene for black. Homozygous yellows ($A^Y A^Y$) die in embryonic stage (left, below), leaving ratio of survivors 2 yellow : 1 black.

Other Lethal Characters.—Numerous other animals and plants furnish examples of lethal homozygotes. The “creeper” fowl, a short- and crooked-legged type, behaves in inheritance precisely like the yellow mouse. Several different cultivated plants have given rise to chlorophyll-free mutations that are unable to survive. In canaries, a crested type is always heterozygous, the homozygotes dying early. The so-called Dexter cattle show some effect of the Dexter gene in heterozygotes, for these have short legs; but the homozygotes are quite abnormal and are usually stillborn. A short-tailed mutation in mice

has the same effect. The mutant character *dichaete* in *Drosophila*, so called from missing bristles but more easily recognized by its spread wings, and *star eye*, likewise in *Drosophila*, in which the facets are disarranged instead of being in regular rows, both exist only in heterozygotes. In all these examples the lethal effect is recessive; hence, it is expressed only in homozygotes; but, except in white plants, some other detectable effect of the gene is dominant, or at least partly dominant, so that the character can be recognized in heterozygotes. In chlorophyll-free plants the visible effect (the absence of chlorophyll) is likewise the lethal effect; it is recessive, and heterozygotes look like normal plants. Here the reason why the lethal character has been discovered is that young plants can live for a time on the food stored in the seed; when that is exhausted, they are unable to manufacture their own.

A Possible Lethal in Man.—A particular type of brachyphalangy, shortened second segments of the second fingers and toes in man, may be lethal in the homozygous condition. This character is ordinarily regarded as a dominant one because it appears in every individual which transmits it—hence, in every one which has the gene for it. Sometimes it is considerably weakened in expression, for reasons to be explained in a later chapter, but it has always been found in a person known to be heterozygous. Now, to get a person who is homozygous, it is necessary that both parents be brachyphalanic. Such matings must be rare, but Mohr and Wriedt describe a cousin marriage of this sort, part of a much larger family history which includes 33 brachyphalanic persons. From this cousin marriage came three children (Fig. 57), one of them short-fingered and one a cripple without fingers or toes and with a very much disordered skeleton in general. The latter child lived only a year. Mohr and Wriedt suggest that it was homozygous for brachyphalangy, a condition to be expected in one-fourth of the children of such parents.

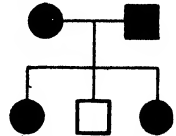

FIG. 57.—Family history of brachyphalangy, part of a much larger pedigree. The parents were cousins. Their last daughter, supposedly a homozygote, died in early childhood. (After Mohr and Wriedt.)

If this child was a homozygote, its nature illustrates one interesting point besides the lethality of homozygosis. That is, that brachyphalangy is not dominant in a strict sense. To say that a gene or character is dominant should mean that a heterozygote is identical in appearance with an individual homozygous for the gene. In the absence of any homozygotes of the one kind, we are not able to make the necessary comparison. When under these circumstances we can

recognize a heterozygote as distinguished from the one known type of homozygote, we call the character dominant. If, however, the quality is expressed in some other, perhaps greatly exaggerated, form in a homozygote, it is scarcely correct to say that the gene is dominant. It is no more dominant than is red or ivory color in snapdragons, or than red or white in Shorthorn cattle. The same may be said of *dichaete* and *star eye* in *Drosophila*, for no one knows what flies homozygous for these genes would look like. Yellow color in mice might be very different in a homozygote; no one knows. One could say of these characters that they are at least partly dominant, which is one way of expressing lack of dominance as in pink snapdragons and roan cattle. It is only in those instances in which the homozygote lives to some stage in which its character may be observed that it is possible to say whether the lethal gene is really dominant or not. If Mohr and Wriedt's interpretation of the skeletally abnormal child in Fig. 57 is correct, brachyphalangy is not dominant, nor is it recessive; dominance is lacking as between this condition and normal fingers.

Time and Manner of Action of Lethal Genes.—The contrasts just made reveal some importance of the time at which lethal genes act. Early action, before the pertinent character develops, leaves us in ignorance of its dominance or lack of dominance. Late enough action permits dominance to be ascertained if it exists.

Lethal genes vary greatly in this respect. In plants a number of lethal genes are known to destroy the germ cells in which they occur, and these are known as gamete lethals. Among the zygote lethals (those which act later than fertilization of the egg), the time of destruction may be early or late. *Dichaete* and *star eye* in *Drosophila* kill the early larvae. Creeper fowls when homozygous die in the shell at about the fourth day of incubation out of the 21 days that normal incubation requires. Short-tailed mice die at the tenth day after fertilization (Fig. 58) out of the usual 21 before birth. Homozygous "bulldog" calves are usually stillborn. White seedling plants survive as long as the food stored in the seed lasts, then starve to death. A number of defects in man that regularly shorten life may be regarded as late-acting lethals.

How the lethal genes work is not yet understood. Ephrussi maintained for a long time, by tissue-culture methods, some of the cells of short-tailed mouse embryos, taken shortly before the embryo died. Embryonic hearts continued to beat for two months, and some of the other tissue cells multiplied and differentiated. These results show that not all cells respond to the lethal genes which they presumably

all contain. Whether some particular type of cell is thus susceptible or whether some relation between cells of different types is the cause of death remains an open question.

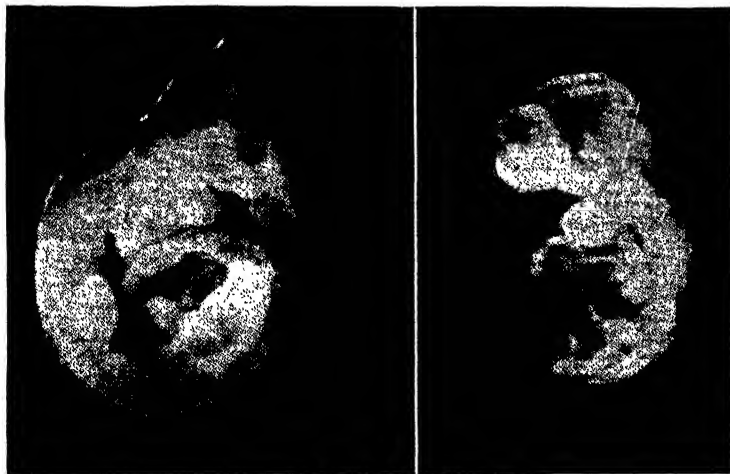

FIG. 58.—Normal embryo (left) of mouse at end of tenth day after fertilization, and that of lethal homozygous short-tailed mouse of same age. (From Ephrussi in *Journal of Experimental Zoology*.)

PROBLEMS

77. Why is it not usually possible to say that a lethal gene, which is recessive for its lethal effect, is dominant for some structural effect?

78. Star eye (disarranged ommatidia) in *Drosophila* is lethal in the homozygous state. If two star-eyed flies are mated together and produce 270 adult offspring, how many of these should be star-eyed?

79. Why does not nondisjunction of chromosomes readily initiate new types of organisms in evolution?

80. Creeper (short-legged) fowls exist only as heterozygotes. If creepers are mated with normal fowls and produce in the aggregate 44 offspring, how many of these should be normal?

81. Under what circumstances could a segment of a chromosome be lost from both chromosomes of a pair without killing the individual losing it?

82. The litters of mice produced by two yellow parents are smaller than those of nonyellows, but are more than three-fourths as large on the average. How is this excess to be explained?

83. How would you describe the dominance or recessiveness of a gene which, like yellow in mice and creeper in fowls, shows in heterozygotes and kills homozygotes?

84. A family whose parents are of blood group O and AB, respectively, includes regularly only groups A and B. If, as a rare exception, a child of group O or AB were produced by such parents, what phenomenon described in this chapter might be the explanation?

CHAPTER 11

TWO OR MORE INDEPENDENT PAIRS OF GENES

Since every organism of the higher groups must possess hundreds or even thousands of genes, and since many of these genes may have mutated within the history of the species, it is inevitable that two individuals which mate should frequently differ in more than one respect. Indeed, unless inbreeding or self-fertilization has been steadily practiced, or there is some other special reason why a population is genetically homogeneous, two individuals which mate are more likely to differ in dozens, scores, or even hundreds of ways. If these various differences do not relate to the same parts of the organism, or sometimes even if they do, it is possible to study the inheritance of a number of characters simultaneously. This is more easily done with only two characters than with three or half a dozen, and the results are simpler if the distinct characters are independent of one another in their distribution to the offspring and in their development or expression in the individual.



FIG. 59.—Diagram illustrating the fortuitous arrangement of two pairs of chromosomes upon the spindle of the reduction division in germ cells.

Independent Characters.—Two characters are independent of each other in their distribution if inheritance of one of them by a given individual does not create a presumption that a particular one of the alternate forms of another character will or will not be inherited by the same individual. In terms of genes, this independence means that the entrance of a particular one of the alternative genes of one pair into a given germ cell does not favor or oppose the entrance of a particular gene of another pair into the same germ cell. Such independence exists only when the two (or more) pairs of genes are in different pairs of chromosomes. In general—there are some exceptions—the pairs of chromosomes are independent of one another. That is, in the reduction division each pair of chromosomes may take either of two positions on the spindle, and taking one of these positions does not

limit the freedom of another pair to take either of its two possible positions purely at random. The various combinations of positions that two pairs of chromosomes may take are illustrated in Fig. 59. If there were a heterozygous pair of genes in each of these pairs of chromosomes, the genes should enter into four different combinations. When there are three pairs of chromosomes, these may take eight different positions in relation to one another (Fig. 60); and three pairs of genes in them would enter into eight different combinations.

Independence of development or expression of different characters means that production of the one does not hinder, or promote, or modify production of the other. Characters are more likely to be independent in expression if they affect distinct parts of the organism, as color of eye and shape of hair, or shape of wings and color of body.

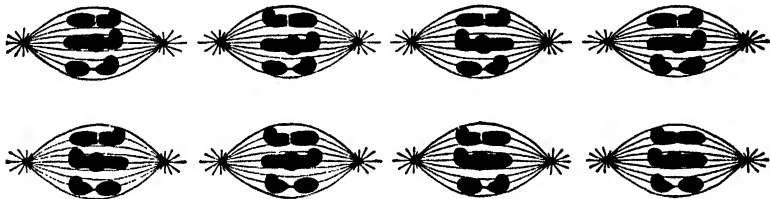

FIG. 60.—Fortuitous arrangement of chromosome pairs on the reduction spindle of spermatocytes of grasshoppers. In each of three pairs, one chromosome was bent in all spermatocytes of the same animal. (After Miss Carothers.)

Yet even such apparently unrelated characters are not always independent in expression.

Color and Shape of Summer Squash.—Illustrative of two independent characters are the color and shape of the fruit of summer squashes. Among the various shapes of the fruit are the spherical and a flattened form that is called the disk. Of the colors, the two here chosen are white and yellow. These characters are independent in expression, and in distribution to the offspring.

Since white is presumably the newer color, and disk the more recently acquired shape, the symbols Ww and Dd are chosen to represent the genes. Being independent in distribution, the two pairs of genes must be in different pairs of chromosomes. In the diagram in Fig. 61 the chromosome pairs are distinguished by showing them as of different sizes, the long pair containing the color genes and the short pair the genes for shape.

The original cross is between a white disk plant and a yellow sphere. The gene and chromosome composition of these plants is shown within the illustrations of the fruit. Their germ cells receive, from the reduc-

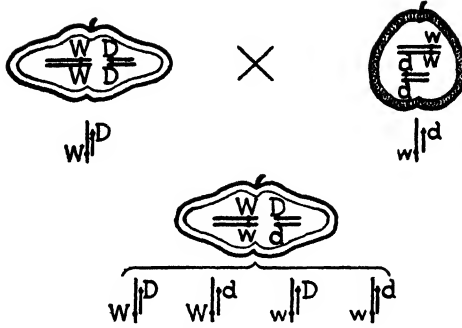

♀/♂	w P	w d	w P	w d
w P				
w d				
w P				
w d				

FIG. 61.—Inheritance of color and shape (disk and spherical) of squash fruit. Plain borders, white fruit; dotted borders, yellow. Heavy straight lines are chromosomes, dots in them are genes. *D*, gene for disk shape; *d*, gene for spherical shape; *W*, gene for white color; *w*, gene for yellow.

tion division, one chromosome of each pair; hence, are of the composition WD and wd , respectively, as shown by the vertical lines beneath the fruit. The F_1 plants resulting from union of these cells must therefore have the genotype $WwDd$, and, since W and D are dominant, the fruit is white and disk-shaped.

When these doubly heterozygous F_1 plants produce their germ cells, and the chromosomes of the two pairs separate in the reduction division, these pairs may be turned either of the two possible ways on the spindle, so that the long chromosome with W may, and in some cells does, go to the same end of the spindle with the short chromosome containing D , or it may, as in other cells, go to the same end of the spindle as does d . The yellow gene w may likewise be turned in such a way as to go sometimes with D and sometimes with d . Four kinds of germ cells are thus produced, WD , Wd , wD , and wd , as indicated by the vertical lines (chromosomes) below the F_1 fruit. Because the placement of the pairs of chromosomes on the reduction spindle is purely fortuitous, these four kinds of cells are about equally numerous. The same numerical relations hold for the eggs and the pollen nuclei—four equally numerous kinds of eggs, four equally numerous kinds of pollen nuclei.

In the production of F_2 plants, therefore, 4 kinds of eggs are fertilized by 4 kinds of pollen, making 16 combinations. Some of these combinations are of course duplicates. A simple way of ascertaining the various combinations is to enter them in a checkerboard, or Punnett square, as in Fig. 61. If the eggs are ranged along the top and the pollen nuclei down the left, their combinations may be placed in the squares where the respective columns and rows cross.

By inspection of the combinations, the type of plant that will develop from each of them may easily be ascertained. Any fruit with at least one W will be white, while ww will yield yellow; any fruit with at least one D will be disk-shaped, dd spherical. By assembling all with the same phenotype, we find that 9 of the 16 combinations are white disk, 3 of the 16 are white spherical, 3 are yellow disk, and 1 is yellow spherical. The $\frac{9}{16}$ class has both dominant characters; each of the $\frac{3}{16}$ classes has one dominant and one recessive; the $\frac{1}{16}$ class has both recessives.

The ratio 9:3:3:1 is characteristic of an F_2 generation when two independent pairs of genes are involved, in each of which one gene is dominant over the other. The ratio may be obtained algebraically by simply squaring the binomial $3 + 1$, that is, by expanding the expression $(3 + 1)^2$. This means that each pair of characters would by

itself yield an F_2 generation consisting of two kinds of individuals in the ratio of 3:1, and, when the two pairs are combined at random, their combinations are in the ratio indicated by the product of the two separate binomials $(3 + 1)(3 + 1)$. It is these numerical results which indicate that the two pairs of genes really are independent of one another in distribution. Were they in some way restricted in relation to each other, other numbers of the several kinds of plants would be obtained.

The Genotypes of F_2 .—Because of the dominance of one gene over the other in each pair, each phenotype in F_2 includes more than one genotype, except the $\frac{1}{16}$ or doubly recessive class (yellow sphere). The combinations thus fall into 9 different genotypes, as follows:

White disk	{	1 $WWDD$
	2	$WwDD$
	2	$WWdD$
	4	$WwDd$
White sphere	{	1 $WWdd$
	2	$Wwdd$
Yellow disk	{	1 $wwDD$
	2	$wwDd$
Yellow sphere	{	1 $wwdd$

Testcross with Two Pairs of Characters.—In the preceding cross the independence of the two pairs of genes in their distribution to the germ cells is first demonstrated by the 9:3:3:1 ratio in the F_2 generation. That ratio is a consequence of the equality of numbers of the four kinds of germ cells from each doubly heterozygous (F_1) parent, and this equality of numbers springs from the randomness of combination of the genes.

That the four kinds of germ cells produced by an individual heterozygous for two pairs of genes *are* equally numerous is more directly shown by a testcross. Two pairs of characters in *Drosophila* may be used to illustrate. One concerns the color of the eye, the normal red eye of the wild-type fly and the mutant brown eye, of which the wild type is dominant. The other relates to the color of the ocelli, the three small simple eyes on the top of the head. The wild type has reddish-yellow ocelli, the mutant one white, yellow ocelli being dominant. The genes for these two pairs of characters are in different pairs of chromosomes, those for eye color being in chromosome 2, those for the ocelli in chromosome 3.

The general scheme in Fig. 62 is the same as in the preceding illustration and requires no extended explanation. Each parent, as there represented, has one dominant and one recessive character, while the F_1 fly has both dominants. The latter is mated with a doubly recessive fly (brown-eyed with white ocelli). The F_1 fly produces four

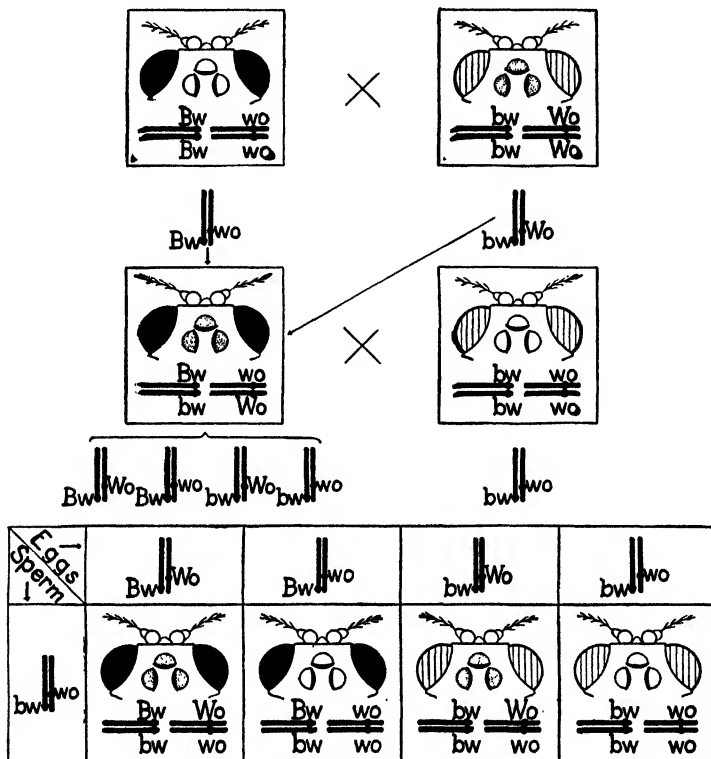

FIG. 62.—Inheritance of color of eyes and color of ocelli in *Drosophila*. Second mating is in the form of a testcross. Genes are represented as in chromosomes. Black eyes are wild-type red, shaded eyes brown; dotted ocelli are wild-type reddish-yellow, plain ocelli white. Ocelli are greatly enlarged. Bw and bw , genes for red and brown eye respectively; Wo and wo , genes for reddish-yellow and white ocelli.

kinds of germ cells; the double recessive produces only one kind. In the squares beneath are shown the four combinations into which these germ cells may enter.

The four kinds of flies in the testcross generation are about equally numerous. Their equality is a demonstration that the four kinds of germ cells produced by the F_1 fly were equally numerous. And the numerical equality of these germ cells follows from the fact that the two pairs of genes are in different pairs of chromosomes. One is obliged to

infer that they are in different pairs in order to explain the equal numbers of the germ cells.

Recombinations in Man.—Similar recombinations of characters in man are frequently witnessed. Since families are small, however, the ratios of the different classes of offspring are less reliable, and it is seldom that one can be sure from a single family history that the genes really are independent of one another. When they are independent, it is inferred that they are in different chromosome pairs. Man has 24 pairs of chromosomes; hence, 2 pairs of genes chosen at random have a good chance of being independent.

Recombination, probably independent, is shown by the color and shape of the hair. Hair may be dark or light, the former being approxi-

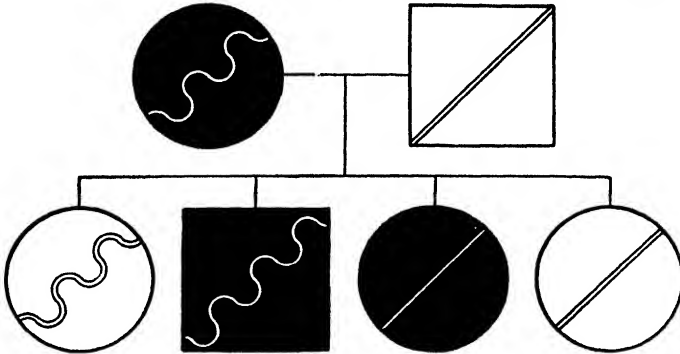

FIG. 63.—Inheritance of color and form of hair in man. Black symbols, dark hair; white symbols, light hair; wavy oblique white lines, curly hair; straight oblique white lines, straight hair. The mother must have been a double heterozygote.

mately dominant. It may be curly or straight, with curliness essentially dominant. Neither of these statements is a whole truth, for both color and shape of hair are inherited in accordance with a more complex scheme, to be described in a later chapter. However, in single families where certain parts of the scheme are eliminated from consideration because all individuals are alike with respect to them, the simple inheritance just indicated may prevail.

An actual family history illustrating the recombination of hair color and hair shape is shown in Fig. 63. The mother had dark curly hair, the father light and straight. Their four children, three girls and a boy, fortunately for this illustration, were of the four possible kinds, light curly, dark curly, dark straight, and light straight. The mother was evidently heterozygous for both characters, while the father was observably homozygous for both recessives. It was largely accident that each of the four expected classes was represented in so small a group, but on the basis of the simple and independent inheritance

postulated above this should happen in 3 out of every 32 families of the same size from similar parents.

F₂ Ratio Dependent on Dominance.—The squashes in the first example presented a ratio of 9:3:3:1 in the F₂ generation partly because one gene was dominant over the other in each pair. When one or both pairs of genes lack dominance, the ratio is changed. There are still 16 combinations, falling into 9 genotypes, but the phenotypes are more numerous.

What the ratio will be in such examples can be foretold by a simple calculation. Suppose that one of the pairs consists of a dominant and a recessive gene; the F₂ generation, with respect to that pair considered by itself, will be divided into two phenotypes in the ratio of 3:1. If the second pair lacks dominance, the F₂ generation with respect to it alone will consist of three phenotypes in the ratio of 1:2:1. If both pairs are studied simultaneously, the F₂ generation will present a ratio which is the product of these two, that is (3 + 1)(1 + 2 + 1). Expansion of this product yields the phenotypic ratio of 3:6:3:1:2:1. This is the expected ratio in F₂ involving two pairs of genes, in one of which there is dominance, in the other no dominance.

To make this result concrete, horns and color in cattle may be used. The polled or hornless condition (*P*) is dominant over horns (*p*), but red (*W*) and white (*w*), as shown in Chap. 5, are neither dominant nor recessive, the heterozygote being roan. Were these two pairs of characters involved in one cross, the offspring would have the genotype *PpWw* and would be polled and roan. Mating together a number of these polled roans would yield the following kinds of offspring:

Fraction	Genotype	Phenotype	Phenotypic ratio
$\frac{1}{16}$ $\frac{3}{16}$	$\left. \begin{array}{l} PPWW \\ PpWW \end{array} \right\}$	Polled red	3
$\frac{3}{16}$ $\frac{3}{16}$	$\left. \begin{array}{l} PPWw \\ PpWw \end{array} \right\}$	Polled roan	6
$\frac{1}{16}$ $\frac{3}{16}$	$\left. \begin{array}{l} PPww \\ Ppww \end{array} \right\}$	Polled white	3
$\frac{1}{16}$	<i>ppWW</i>	Horned red	1
$\frac{3}{16}$	<i>ppWw</i>	Horned roan	2
$\frac{1}{16}$	<i>ppww</i>	Horned white	1

Any other condition in which a heterozygote can be distinguished from both corresponding homozygotes will act in the same way to modify the F_2 ratio. For example, the blood-group agglutinogens (Chap. 9) in man are both dominant; both are present in heterozygotes. Suppose that a man of blood group AB, having normal pigmentation (C) of the skin but born of an albino mother (c) so that he is heterozygous for pigmentation, marries a woman (perhaps his cousin) who is likewise of blood group AB and heterozygous for pigmentation. Their genotype is $AA^B Cc$. While their children would scarcely be numerous enough to fall into a typical F_2 ratio, that ratio would be expected to be 3:6:3:1:2:1. The student is encouraged to verify this expectation by means of a checkerboard or otherwise and to allot the various combinations of blood group and color to the proper terms of the ratio.

If both of the pairs of genes lack dominance, or in some other way enable the heterozygote to be distinguished from the two corresponding homozygotes, so that each pair by itself would produce an F_2 of three kinds in the ratio of 1:2:1, then the F_2 obtained from the two pairs in combination would be 1:2:1:2:4:2:1:2:1, which is derived from the product $(1 + 2 + 1)(1 + 2 + 1)$. This ratio may be made concrete by using color of flower and shape of leaf in snapdragons; for flowers which are heterozygous for red and white are pink, and plants which are heterozygous for broad leaves and narrow ones have leaves which are intermediate. It is left to the student to fit the nine different combinations of red-pink-white and broad-intermediate-narrow to the nine-term ratio just given. There is in this instance only one genotype for each phenotype, though some of the genotypes are repeated among the 16 F_2 combinations.

Combination of Sex-linked and Autosomal Character.—A special situation exists when one character which is sex-linked is tested simultaneously with another which is autosomal. The genetically well-known vinegar fly *Drosophila* furnishes many examples. One character involves the shape of the bristles. While the wild-type fly has bristles of a regularly and gently curved form ending in a single sharp point, a mutant type has irregularly crooked bristles often branched. These characters are sex-linked, the gene being in the X chromosome, and forked bristle is recessive. The other character chosen concerns body color. The wild-type color is usually called gray, and one of the mutants is black. The genes for these characters are in chromosome 2, hence are not related to sex. Black is recessive.

The cross is represented as between a forked gray female and a

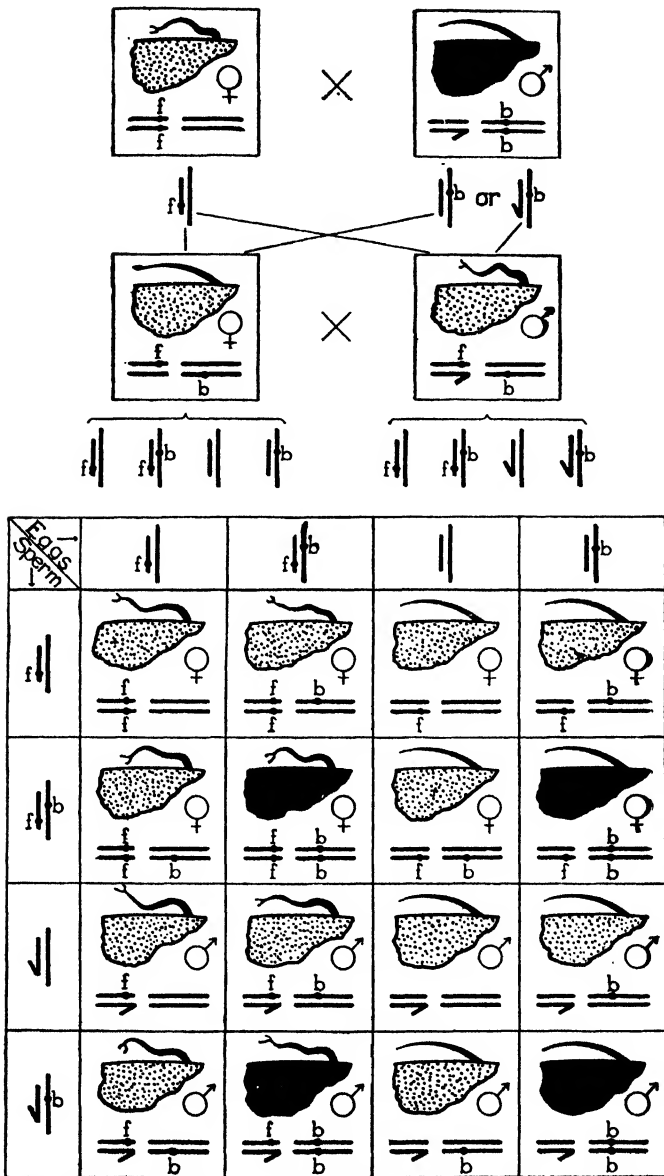

FIG. 64.—Simultaneous inheritance of a sex-linked and an autosomal character. Forked bristle is sex-linked, and recessive to single-tipped wild-type bristle. Black body is autosomal, and recessive to wild-type gray (dotted in figure). X chromosomes short, autosomes long, Y chromosome bent. *f*, gene for forked; *b*, gene for black. Chromosomes with no gene marked contain only wild-type genes; the Y chromosome, however, has no known genes relating to bristle shape.

nonforked black male (Fig. 64). In the illustrations the bristle and a small portion of the body wall, enough to show the color, are given. The shorter of the two chromosome pairs is the X (or XY), the longer one is chromosome 2. The Y chromosome in *Drosophila* is bent and is represented as turned back at one end, as in an earlier illustration. It contains no gene that can be detected as bearing on either of the characters here used; hence, it may be regarded as "empty" for the purpose of this example.

In accord with a general practice among geneticists, which may now be introduced to advantage, only the mutant genes are marked. Any chromosome not marked is assumed to have the wild-type genes in it. An unmarked X chromosome contains the nonforked gene (*F*), an unmarked second chromosome contains the gene for gray body (*B*). The Y chromosome is unmarked but, as an exception, this does not imply any wild-type genes.

With these explanations Fig. 64 should be fairly clear. The germ cells are represented by vertical chromosomes, one chromosome from each pair. While the original female produces but one kind of egg, the male, because of its XY chromosomes, produces two kinds of spermatozoa, as in all instances of sex-linked inheritance in an XY species. There are consequently two combinations in F_1 , one of them yielding females, the other males. Now the males will inevitably contain the gene *f*, received from the mother, and will exhibit the forked bristles. The females will be nonforked, and both sexes will be non-black (gray), because in each of them there is a wild-type (dominant) gene in one of the chromosomes of the pertinent pair.

Each sex in the F_1 generation produces four kinds of germ cells, and these are combined in 16 ways, which are shown in the illustration after the manner used in earlier figures. It is clear at a glance that the ratio of gray to black is 3:1 (12:4), as would be true of any autosomal characters. The ratio of nonforked to forked, however, is 1:1 (8:8), as would happen for any other sex-linked character involved in a cross like the one here made. When the two pairs of characters are combined, and if sex is taken into account, the F_2 generation is made up as follows:

$\frac{3}{16}$	nonforked gray	♀ ♀
$\frac{1}{16}$	nonforked black	♀ ♀
$\frac{3}{16}$	forked gray	♀ ♀
$\frac{1}{16}$	forked black	♀ ♀

$\frac{3}{16}$	nonforked gray	$\sigma^7 \sigma^7$
$\frac{1}{16}$	nonforked black	$\sigma^7 \sigma^7$
$\frac{3}{16}$	forked gray	$\sigma^7 \sigma^7$
$\frac{1}{16}$	forked black	$\sigma^7 \sigma^7$

This ratio could have been foretold at the outset by a brief calculation. The ratio in F_2 for an autosomal character (gray-black) with dominance is 3:1, with the sexes proportionately represented. The F_2 ratio for a sex-linked character, when the recessive member of the pair entered from the XX (or ZZ) sex in the first cross, is 1:1 with the sexes in the same proportion in both classes. And finally, the ratio of the sexes in any generation is 1:1. Combining these at random results in a ratio that is obtained from the product $(3 + 1)(1 + 1)(1 + 1)$, or 3:1:3:1:3:1:3:1.

In man, from the data of various investigators, it is suggested that harelip and cleft palate are due to a combination of one autosomal and one sex-linked gene. This explanation was offered partly because of the greater prevalence of the defect in males.

Three Pairs of Genes.—To illustrate the simultaneous inheritance of three pairs of characters, those of rabbits may be used, two of them concerned with hair color, one with hair length. The two pairs of color genes are part of a more extensive scheme, and certain assumptions have to be made regarding the other members of the system, but these assumptions need not be stated here. One of the genes (A) causes the pigment on each individual hair to be broken up and limited to certain portions of the hair, making the general color agouti, or gray, the wild-type color of rabbits. The allele of this gene (a) causes the pigment to be uniformly spread along the hair, and in this example the color thus spread is assumed to be black. Nonagouti (black), as the small letter indicates, is recessive. The second pair of genes determines how dense the pigment is, d making it dilute, D intense. Black color accompanied by dd becomes "blue," but with D it is deep black. Agouti accompanied by dd is light agouti, while with D it is the typical wild-type agouti. The third gene determines length of hair, l representing long hair (Angora), L short hair.

In whatever combination the genes enter from the parents, the genotype of F_1 is $AaDdLl$, and the phenotype is wild-type agouti and short-haired. The germ cells of F_1 are of eight kinds in each sex, equally numerous, as follows:

Eggs	Spermatozoa
<i>ADL</i>	<i>ADL</i>
<i>ADl</i>	<i>ADl</i>
<i>AdL</i>	<i>AdL</i>
<i>aDL</i>	<i>aDL</i>
<i>Adl</i>	<i>Adl</i>
<i>aDl</i>	<i>aDl</i>
<i>adL</i>	<i>adL</i>
<i>adl</i>	<i>adl</i>

These are combined at random in fertilization, resulting in 64 combinations among which there are many duplicates. It is advisable for the beginner to prepare a checkerboard the first time he analyzes an F_2 generation involving three pairs of characters. The diagram must contain 64 squares. The eggs may be written down the columns of squares, one kind of egg eight times in each column, and the eight kinds of spermatozoa along the horizontal rows.

Then comes the inspection of the 64 genotypes to assign them to their proper phenotypes. There are but eight of these phenotypes, for the same reason that eight kinds of germ cells are produced by the F_1 animals. These eight phenotypes are, however, very unequal in numbers as follows:

$\frac{27}{64}$	dark agouti short-haired
$\frac{9}{64}$	dark agouti Angora
$\frac{9}{64}$	deep black short-haired
$\frac{9}{64}$	light agouti short-haired
$\frac{3}{64}$	deep black Angora
$\frac{3}{64}$	light agouti Angora
$\frac{3}{64}$	light black short-haired
$\frac{1}{64}$	light black Angora

The expression "dark agouti" would ordinarily be simply "agouti," "deep black" merely "black," and "light black" only "blue"; but it seemed better in such a list to use three words, separately indicating the results of the three pairs of genes.

It will be observed that the most numerous class, which makes up $\frac{27}{64}$ of the whole F_2 , consists of those individuals exhibiting the dominant character of each pair. Each of the $\frac{9}{64}$ classes exhibits two dominants and one recessive, but there are three combinations that meet this specification. Each of the $\frac{3}{64}$ classes shows one dominant and two recessive characters, while the $\frac{1}{64}$ class shows all of the recessives.

The F_2 ratio for three pairs of genes, with dominance in each pair, is merely the expansion of the product

$$(3 + 1)(3 + 1)(3 + 1) = 27 + 9 + 9 + 9 + 3 + 3 + 3 + 1.$$

Studies of more than three pairs of characters are mostly beyond the scope of an elementary presentation.

PROBLEMS

85. What F_2 ratios indicate that the grandparents of that generation differed in just one pair of genes?

86. How many phenotypes are produced among the offspring of self-fertilized $AaBb$ if A and B are both dominant? How many if dominance is lacking in both pairs? How many if there is dominance in one pair, none in the other?

87. Self-fertilizing $MmNn$ yields what genotypes among the offspring? Do not repeat; name each one only once.

88. Corn that is heterozygous for starchy and sugary grain and for white and purple endosperm appears starchy and purple. If a plant thus doubly heterozygous is self-fertilized and produces an ear with 320 grains, ____ (a number) grains should be white and starchy, ____ white and sugary, ____ purple and starchy, ____ purple and sugary.

89. A tall pea plant with inflated pods, crossed with a dwarf plant having inflated pods, produces 36 tall inflated offspring, 39 dwarf inflated, 14 dwarf with constricted pods, and 12 tall constricted. The 14 dwarf constricted ones all breed true in the next generation. The genotypes of the original parents, using Dd and Cc as symbols, were ____ and ____.

90. A gray long-winged *Drosophila* is mated with a sooty vestigial-winged fly ($ssvv$). They produce 29 gray vestigial offspring, 32 gray long, 28 sooty long and 30 sooty vestigial. What was the genotype of the gray long-winged parent?

91. If a doubly heterozygous red-eyed gray-bodied fly ($SsEe$) is mated to a doubly recessive safranin-eyed ebony-bodied fly ($ssee$) and they produce 240 offspring, ____ (a number) of these should be safranin gray and have the genotype _____.

92. A plant whose genotype is $XxYy$ is self-fertilized and produces 5 offspring having the phenotype xy . How many should have the phenotype Xy ? How many XY ? How many xY ?

93. One parent in a cross has the genotype $ffmn$; the offspring are 26 of one kind, 21 of another, 28 of a third, 25 of a fourth. The other parent's genotype was _____.

94. In poultry, feathered shank (F) is dominant over clean shank (f); R produces rose, P produces pea comb, absence of both R and P produces single. If $ffRrPp$ is crossed with $FfRrpp$, what proportion of their offspring should have both clean shanks and single combs?

95. Red and white eye in *Drosophila* are sex-linked, with red dominant; long and vestigial wing are autosomal, with long dominant. If a white long female is mated with a red vestigial, what are the phenotypes of the F_1 flies, given for the sexes separately? What will be the phenotypes of F_2 , including their sex?

96. How many kinds of germ cells would be produced by an animal whose genotype is $FfNnSSPp$? What formula could you use to compute quickly the number of kinds of germ cells produced by an individual of any given genotype?

97. In fowls, black plumage (R) is dominant over red, crest (C) dominant over plain head, and feathered foot (F) dominant over clean. If a black plain-headed feather-footed fowl is crossed with a red crested clean-footed one, and they produce 5 black crested feathered, 6 black plain feathered, 1 black crested clean, 2 black plain clean, 4 red crested feathered, 5 red plain feathered, 1 red crested clean, and 1 red plain clean, what were the genotypes of the parents?

98. In radishes, crossing long with round produces oval, and crossing red and white yields purple. If an oval purple plant is crossed with a round red one and 36 offspring are obtained, what phenotypes should be found among them and how many of each?

99. What must a florist do to obtain seed that he can guarantee to produce oval purple radishes (see preceding problem)? If the purchaser obtains seed from his own plants and raises a crop from them the next year, what phenotypes should be found in it? Which of these kinds of plants, if self-pollinated, would breed true the following year?

100. Barred plumage in fowls is a dominant sex-linked character, black recessive. Creeper (short legs) is dominant and autosomal, but lethal in homozygotes. If a barred creeper hen is mated with a black creeper cock and they produce 18 living offspring, how many of these should be barred creeper males? How many black normal-legged females? How many black creeper males?

CHAPTER 12

INTERACTIONS OF GENES

It often happens that genes, which are in different pairs of chromosomes and are therefore independent in their distribution to the germ cells, pool their activities when it comes to producing their characters. Though each of the genes may produce its own primary chemical effect, the influence of their combined products on development may yield something entirely different and unpredictable. Such interaction may

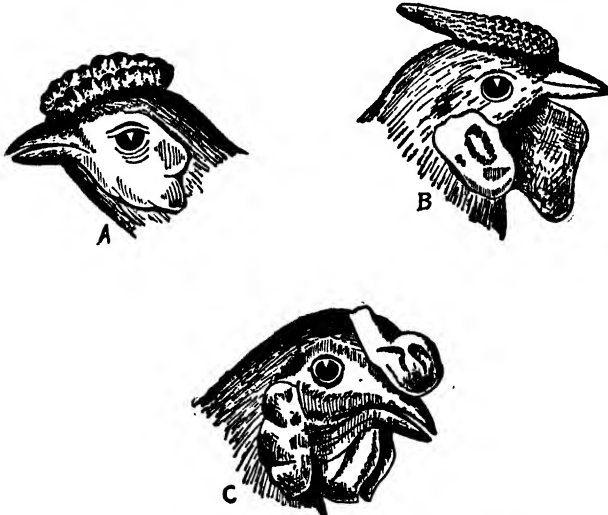

FIG. 65.—A character caused by interaction of genes. Walnut comb (C) is produced when the dominant genes for pea comb (A) and rose comb (B) are both present in the same fowl.

modify the ratio of the phenotypes in the F_2 generation, but in the first example below it does not have that effect.

Interaction between Dominant Genes.—Some breeds of fowls have what is called the pea comb (Fig. 65, A), resulting from a dominant mutant gene (P) at a certain locus. Without this mutation (hence with p) the comb is of the high, thin, notched form which approaches the presumable wild-type comb of ancestral birds and which is called single. Crossing pea with single yields pea in F_1 , and pea and single

in the ratio of 3:1 in F_2 . In another chromosome there is, in certain varieties, a dominant mutant gene (R) that results in rose comb (Fig. 65, B). Without this mutation (hence with r) the comb is likewise single, and crossing rose with single gives rose in F_1 and rose and single (3:1) in F_2 . Interaction between the two dominant genes P and R is obtained by crossing pea- and rose-combed fowls. The pea-combed bird has the genotype $PPrr$, the rose-combed fowl $ppRR$. Their hybrid must be $PpRr$. Very unexpectedly (to one who has not made the test) its comb is like that in Fig. 65, C , which is called walnut. This new comb is the product of the combined action of P and R .

The F_2 generation will consist of a $\frac{9}{16}$ class possessing at least one P and at least one R —and having the phenotype briefly designated PR^1 —whose combs are walnut; a $\frac{3}{16}$ class of phenotype Pr which has pea combs; another $\frac{3}{16}$ class of phenotype pR which is rose-combed; and a $\frac{1}{16}$ group phenotypically pr which has single combs. The ratio is not at all disturbed; there is merely an interaction between the two dominant genes affecting the comb such that a totally different form of comb is produced.

Color in sweet peas also results from interaction between two dominant genes. To have colored flowers, a plant must have what is called a *chromogen* (a basic substance out of which colored matter may be developed) and an *enzyme* which will convert the chromogen. Both the chromogen and the enzyme are colorless, but the two together produce color in the flowers. The dominant genes for these substances have commonly been designated C and R , respectively. A sweet pea with the genotype $CCrr$ is white because it forms only the chromogen. A pea whose genotype is $ccRR$ is likewise white, for it has only the enzyme. When they are crossed, however, the F_1 plants are of the genotype $CcRr$, both chromogen and enzyme are produced, and the flowers are colored. When these colored F_1 plants are self-fertilized, the F_2 generation consists of a $\frac{9}{16}$ class whose phenotype would be indicated by CR , which is colored; a $\frac{3}{16}$ class Cr which has white flowers; a $\frac{3}{16}$ class which is cR and therefore white; and a $\frac{1}{16}$ class which is the doubly recessive cr , likewise white.

Here the ratio of the F_2 phenotypes is changed to 9:7, for the last three classes of the 9:3:3:1 distribution are quite indistinguishable. Such modifications of expected ratios are quite common where genes

¹ This common practice among geneticists should not prove confusing. When referring to the phenotype, a single symbol for each pair of characters designates the character and is not the formula of a germ cell, as a single symbol would otherwise be.

interact. To get a 9:7 ratio the interacting genes must be such that neither one produces anything visible by itself, but the two together yield a perceptible product.

Interaction between Recessive Genes.—In summer squashes, as already indicated (Fig. 61), disk-shaped fruit (*D*) is dominant over spherical (*d*). Now, there is another pair of genes also concerned with shape. One gene at this other locus makes the fruit disk-shaped, is dominant, and may be symbolized by *F* (from flat). Its allele (*f*) makes the fruit spherical. There are thus two kinds of spherical squashes, one genotypically *ddFF*, the other *DDff*. Being homozygous for either *d* or *f* makes the fruit spherical; but to be disk-shaped a fruit must contain both *D* and *F*.

If the two spherical types are crossed, their hybrid is *DdFf*, and it is disk-shaped. If the F_1 is self-fertilized, the F_2 generation consists of a $\frac{9}{16}$ class phenotypically *DF* which is disk-shaped; a $\frac{3}{16}$ class *Df* which is spherical; and a $\frac{3}{16}$ class *dF* which is likewise spherical. Finally, the $\frac{1}{16}$ class *df*, perhaps not surprisingly, has elongated fruit.

There are two interactions here. Since disk shape requires both *D* and *F*, these genes must cooperate to produce that form. This is comparable to the interaction that produces walnut comb or colored sweet peas, since it occurs between two dominant genes. The second interaction is between the two recessive genes *d* and *f*, to produce elongate fruit. In this joint action, one gene may be regarded as merely accentuating the effect of the other. For, taking disk fruit as the standard of comparison, spherical fruit itself is somewhat elongate. The two genes for spherical form merely increase this elongation.

The F_2 ratio in this cross is 9:6:1. To yield this ratio, the two dominant genes, taken singly, must produce similar characters, and the two recessives, taken singly, must produce similar characters; but the two dominants together or the two recessives together must produce something different.

It is difficult to prove specific interactions in man, but there is little question that they occur in abundance. A scheme of inheritance of human hair color adopted by Lenz involves several of them. As an example, the color he designates blond rests first of all on a recessive gene for general pigmentation of medium degree and next upon another recessive gene responsible for a lack of melanization (black pigment formation). There are other genes, and the whole system is described in a later chapter. The part here indicated illustrates interaction between recessive genes. The distinction between dominant and recessive in such interactions is not, however, important.

Modifiers.—When a gene produces no observable effect in one genetic background, but changes the character produced by another gene when that gene is present, it is called a *modifier*. One modifying gene was introduced into the preceding chapter without calling attention to its nature. That gene is the diluting factor in rabbit color which changes black to “blue” and agouti to light agouti. The diluting gene can be detected only in the presence of a color gene or combination.

Agouti itself is a modifier, for its effect is to rearrange the color (black or brown) produced by other genes. In the absence of the



FIG. 66.—Polydactyly in both hands and feet. Thumbs and great toes are either duplicated or branched. (From Atwood and Pond in *Journal of Heredity*.)

agouti gene the pigment is spread more or less uniformly along the hairs. With the agouti gene, the pigment is restricted by yellow. In the absence of the genes requisite to color of any kind (in an albino animal), the agouti gene cannot be expressed.

Sometimes the dominance of one gene is modified by other genes. The bristle character known as forked in *Drosophila* (Fig. 64) is ordinarily recessive; but in the presence of a certain other gene, which has no other known effect, forked shows to some extent even in a heterozygote. It is not at all unlikely that extra fingers in man (polydactyly, Fig. 66) has its dominance determined in a similar manner. It is well known from family histories that extra fingers may or may not show in a heterozygote. Figure 67 presents evidence of this capriciousness.

When present, the extra fingers may be well developed or quite small (Fig. 68, contrasted with Fig. 66). This variable condition has long been known as "irregular dominance." From what is known of other animals, it seems probable that this variable expression of extra fingers is caused, not by any variability of the polydactyly gene itself, but by certain other genes which may or may not accompany it. It has been impossible to identify any such genes, or to trace them through lines of descent, in man. If they exist, they too are modifiers.

Spotting factors limit the distribution of colors in various organisms. Colored beans homozygous for a spotting gene are mottled, and colored

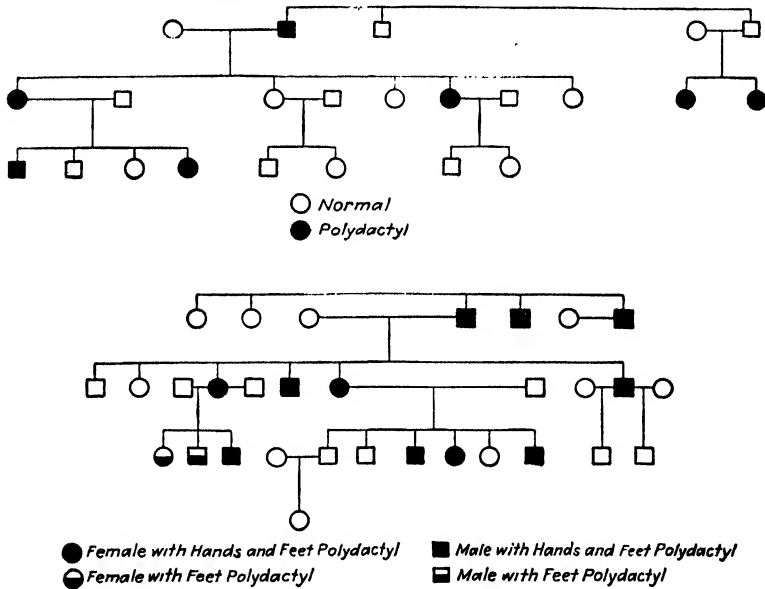

FIG. 67.—Two family histories of polydactyly which, together, indicate that the character is sometimes recessive, sometimes dominant. (From Mülles in *Journal of Heredity*.)

mice homozygous for a spotting gene have white areas of variable size and shape along with colored ones. Mice without any color gene (albinos) cannot, of course, exhibit spots.

So many examples of modifying genes have been discovered that it seems likely that every gene is thus related to others. Probably every gene has its effect partly determined by other genes and in turn is a modifier of other genes. Characters are thus produced not by certain genes but by the whole genetic complex or a considerable part of it.

Dominance Modified by Sex.—Just as dominance of forked bristles in *Drosophila* and perhaps of polydactyly in man is influenced by other

genes, so is dominance of certain characters dependent on sex. These characters are dominant in one sex, recessive in the other. Horns in sheep behave in this way, at least in certain breeds. In one breed both sexes are horned, though the horns of rams are larger than those of ewes. In another breed both sexes are hornless. When these breeds are crossed, the male F_1 offspring are horned, while the females are hornless. The character is not sex-linked, as one might first suppose on obtaining such a result, for both reciprocal crosses between the breeds yield the same distinction between the sexes. That is, in the first cross the horns may be introduced either through the female or through the male; in either case the male progeny are horned, the female hornless. Were horns sex-linked, only one of the two reciprocal crosses would yield an F_1 in which the sexes were different.

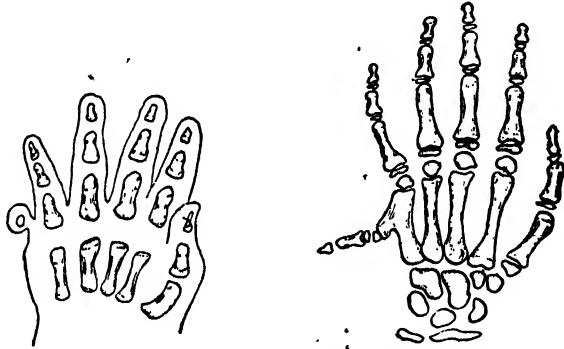

FIG. 68.—Skeletons of polydactyl hands illustrating, respectively, slight and intermediate development of extra fingers. Strong development is shown in Fig. 66. (From Miles in *Journal of Heredity*.)

When an F_2 generation is obtained from these F_1 sheep, there are some horned and some hornless in each sex; but among the males the ratio is 3 horned to 1 hornless, while among the females it is 1 horned to 3 hornless. All these peculiarities are explained on the assumption that a heterozygote (Hh) has horns if it is a male, no horns if it is a female. One homozygote (HH) is horned regardless of sex; the other homozygote (hh) is hornless in either sex.

Similarly, baldness in man appears to be dominant in men, recessive in women. There is, however, a difference in the degree of expression of the character in the two sexes; for women who are homozygous, and are regarded as bald, are seldom as free of hair on the scalp as markedly bald men are.

Suppression of a Character in One Sex.—If sex physiology can prevent one gene of a pair from coming to expression, it should not be

surprising if both genes of a homozygote could be suppressed. This happens in the male of the clover butterfly. This species of butterfly is typically yellow, but it has a white variety. The white color is exhibited by females, which have the gene for it, but never by the males. Even homozygous "white" males are not white. Males transmit the white gene if they possess it (transmit it to all their offspring if homozygous), and their daughters may be white, but their sons are only yellow. Something in the male physiology prevents the white genes from producing any visible effect even when there are two of them.

Epistasis.—When two genes occupying different loci (hence, not allelic to each other) affect the same feature of an organism, they often bear the relation, one to the other, known as *epistasis*. This term has been used in two senses. Sometimes it is used merely to mean that one gene depends on the presence of another gene to produce any effect. The diluting gene already referred to in connection with hair color is an example. It has no effect unless a color gene accompanies it. Modifiers in general have no effect unless the gene whose action they are capable of changing goes with them. Mammals in general must have a fundamental color gene *C* in order to be pigmented at all. What color they will exhibit is then determined by one or more other genes. Some geneticists have used the word epistasis to indicate the relation of the overlying genes in all these examples to the genes on which they are dependent. The genes of a mouse that determine the nature of the color are all, in this sense, epistatic to the basic gene *C*. Modifiers are epistatic to the genes they influence.

Another and somewhat cruder but simpler form of epistasis is the concealment of one character by another. According to one proposed scheme of hair color in man, there is a gene for red pigment and another for black or brown pigment. When both genes are present, both pigments are produced; but if the black pigment is heavy the red may be completely hidden. Black is then said to be epistatic to red.

Inhibitors.—A special form of epistasis is shown by inhibiting genes. One gene may entirely prevent another (nonallelic) gene from producing its character. The absence of color in White Leghorn fowls is due to an inhibitor. Such a fowl may have genes that would make it black, or brown, or barred; but, if the inhibiting gene (*I*) is present, the color genes are entirely inoperative and the plumage is white. The correctness of this explanation is attested by hybrid generations in which, due to the shuffling and recombination of the genes, some fowls receive the color genes and not the inhibitor, and consequently they are colored.

Sheep may also possess a dominant inhibiting gene that prevents

black color of their wool. Such sheep are white but are capable of transmitting black color to some of their progeny in which the inhibitor may be absent.

White color in squashes is a further example of inhibitors. The inheritance of white as contrasted with yellow has already been described in Chap. 11, Fig. 61. The story is not quite so simple as there told, however, for squashes may have a third color, green. When yellow is crossed with green, yellow proves to be dominant over green, even though it is recessive to white.* There must be a second pair of genes Yy , which determines whether the squash can be yellow or not. A squash of genotype $wwYy$ is yellow, while $wwyy$ is green. The inhibiting gene in squashes is W ; when this is present, as in $WwYY$ or $WWyy$, neither the yellow nor the green color can be produced, and the squash is white.

It has been suggested that there may be in some human beings a gene inhibiting brown pigment in the iris of the eye. This suggestion is made to explain the occasional instances of brown-eyed children derived from parents both of whom are blue-eyed. As has been indicated (Fig. 32), absence of brown pigment is recessive to its presence; that is, blue is recessive to brown. Under these circumstances all blue-eyed persons should be homozygous, and two blue-eyed parents should have only blue-eyed children. The occurrence of a brown-eyed child in the family of two blue-eyed parents is thus exceptional and requires an explanation. One possibility is that one of the parents is blue-eyed because of an inhibitor. That parent is supposed to have a gene for brown pigment, but also a dominant inhibiting gene which prevents the pigment from developing. If such parent is heterozygous for the inhibitor ($IiBB$ or $IiBb$), some of the offspring may receive the gene B but not I . These offspring will be brown-eyed.

Complex Interaction Groups.—Most interactions of genes probably involve a number of loci, even if only two have been discovered. Some rather complicated systems of interaction have been thoroughly established. One of the simplest schemes of multiple-gene interaction is that in which the genes at the several loci have similar effects and in which their product is cumulative. An example is red color in the grains of wheat, as contrasted with white grain. The red color is due to three pairs of genes, all having the same effect and perhaps, though not necessarily, equal effects. It is common practice among geneticists to symbolize such similar genes by subscripts to a common base— R_1 , R_2 , and R_3 . None of these genes is dominant over its allele (r_1 , r_2 , r_3) which produces no red pigment, so that heterozygotes are intermediate.

Thus, $r_1r_1r_2r_2r_3r_3$ is white, $R_1r_1r_2r_2r_3r_3$ has a little red color, and $R_1R_1r_2r_2r_3r_3$ has somewhat more red. Each pair behaves in the same way, so that $r_1r_1R_2R_2r_3r_3$ is a little redder than $r_1r_1R_2r_2r_3r_3$. Now, the effects of the genes at different loci are cumulative. This means that $R_1r_1r_2r_2R_3R_3$ is darker red than $R_1r_1r_2r_2r_3r_3$, and perhaps of about the same color as $r_1r_1r_2r_2R_3R_3$ or $r_1r_1R_2R_2r_3r_3$. Any two genes, whether at the same locus or at different loci, produce more red than one, three produce more than two, four more than three, and so on. If it be assumed, as is approximately if not strictly true, that the genes at the three loci have equal effects, then three genes produce a certain amount of red color no matter which of the six places they occupy. Four genes, in any of the positions, would produce a deeper red, five genes still deeper, while six would duplicate the original red variety, which is $R_1R_1R_2R_2R_3R_3$. A hybrid generation (F_2 or later) could thus include six different grades of red in addition to strictly white wheat.

More complicated interactions occur when the genes at different loci have qualitatively different effects. Coat color in mice will serve as an illustration. With the omission of the yellow color, which has already been presented as lethal in homozygotes (Fig. 56), the system is in part as follows. To be colored at all, a mouse must have the basic dominant gene C ; if its genotype is cc it is albino. If in addition to C the mouse has the gene A , the pigment in the hairs is restricted to certain parts and the coat is agouti. In the absence of A , that is, in $CCaa$, the pigment is spread along the entire hairs and solid color results. What that color is depends on still another pair of genes. If that pair includes B , the mouse is solid black, while bb is brown. The effect of the agouti gene A is the same for black and brown mice; but in mice with B it produces the typical wild agouti coat, while with bb the banding of the color on the individual hairs results in the color called cinnamon. Another pair of genes determines whether the pigment granules are clumped or are spread evenly. The clumped condition results in a dilute color (d) as contrasted with the dense color (D) due to even distribution. Dilution affects any of the colors produced by the other genes, so that there are dilute agouti, dilute black (blue), and dilute brown mice. Still another pair of genes (Pp) determines the amount of pigment. The mutant member (p) of this pair causes the iris of the eye to be reddish, owing to reduction of pigment, and is known as the pink-eye gene. Its effect on the hair is likewise to reduce the amount of pigment, giving the mouse a faded appearance. Any of the colors may be washed out by this pink-eye reduction, just as they may be diluted by the clumping of the granules (d). Finally,

distribution of pigment over the body is governed by a sixth pair of genes (*Ss*). In *ss* individuals the pigment is restricted to spots, and mice of any color may be spotted.

A wild-type mouse must have the dominant gene of each pair; hence, if true-breeding (homozygous) it must have the genotype *CCAABBDDPPSS*. Substitute for any one of these pairs their recessive mutant alleles, and a different kind of mouse is produced.

Human hair color is probably as complicated as that of the smaller mammals, but conjectures concerning that system are reserved for a later chapter, where a number of hereditary traits in man are assembled for reference.

Blending Characters.—The color of wheat, described in the preceding section, exemplifies what are known as blending characters. This name was applied to them because they did not *appear* to show the sharp segregation that Mendelian heredity ordinarily involves. The distinctive marks of a blending character are for the F_1 generation to be intermediate between the parents (and fairly uniform among themselves if the parents were homozygous) and for the F_2 generation to break up into a variety of types ranging, by small steps, practically from one grandparental extreme to the other. These conditions are met, it will be observed, in red and white wheat. When these two varieties are crossed, according to the scheme presented, each F_1 plant will contain three of the six red genes ($R_1r_1R_2r_2R_3r_3$), and will be about half as red as the red variety. Since all F_1 plants have the same genotype, that generation has nearly uniform color. In the F_2 generation, however, a plant may have any number of red genes from none at all to six. This generation is accordingly very variable in color. A small fraction of the plants should be fully red and an equal portion strictly white, while the bulk of them would be intermediate in various degrees.

It is very common for quantitative characters, such as length, weight, or depth of color to be inherited according to the blending scheme. The probable explanation in most such instances is that many pairs of genes having somewhat similar effects are at work. There are other possibilities, such as multiple alleles, and one such possibility for human hair color is described in a later chapter.

Modified F_2 Ratios.—Often the geneticist's interest in the interaction of genes is less concerned with their physiological relation than with the discovery of puzzling genotypes. If a character is early found not to be simple—that is, not differentiated by a single pair of genes—the first clue to the more complex situation is frequently furnished by the ratio of the phenotypes in F_2 . Experiments have

uncovered a number of typical ratios, each dependent on two or more pairs of genes, which bear certain relations to one another. When one of these ratios turns up in an F_2 generation, it is tentatively assumed that the genetic situation known to produce such a ratio is responsible. More specific tests can then be applied to obtain definite proof. Several of the common F_2 ratios, in addition to the 9:7 and 9:6:1 already given, are considered below.

The Ratio 9:3:4.—The complex scheme of color inheritance in mice offers an opportunity to obtain a ratio of 9:3:4 in F_2 . To be colored at all, a mouse must possess the gene *C*. If it has only *cc* at that locus, it is albino, even though a number of other genes for particular colors or distribution of color may be present. To use only two of the genes belonging to this system, assume that a mouse is of the genotype *CCaa*. The gene *a* is the nonagouti gene, which means that the mouse will be of solid color—say, black. Another mouse, of genotype *ccAA*, will be albino, even though it has a gene (*A*) that would make it agouti if it had color of any kind. If these two mice are crossed, their offspring are *CcAa*—hence agouti. Mating these F_1 mice among themselves yields the following F_2 generation:

Fraction	Genotype	Phenotype	Ratio
$\frac{1}{16}$ $\frac{2}{16}$ $\frac{2}{16}$ $\frac{3}{16}$	<i>CCAA</i> <i>CcAA</i> <i>CCaA</i> <i>CcAa</i>	Agouti	9
$\frac{1}{16}$ $\frac{2}{16}$	<i>CCaa</i> <i>Ccaa</i>	Black	3
$\frac{1}{16}$ $\frac{3}{16}$	<i>ccAA</i> <i>ccAa</i>	Albino	4
$\frac{1}{16}$	<i>ccaa</i>	Albino	

The 9:3:3:1 ratio, expected from two pairs of genes, is converted into 9:3:4 because the last two classes are phenotypically identical. This ratio regularly occurs when, of two interacting dominant genes, one has a detectable effect by itself, while the other has none. The gene *C* (under the assumptions made for this illustration) has an effect by itself, *A* does not.

The Ratio 12:3:1.—In oats there is a variety with black chaff, another with white. When these were crossed, the offspring had black

chaff, and there was every expectation that the original black and white varieties would prove to differ in only one pair of genes and that the F_2 generation would divide between the black and the white type in the ratio of 3:1. To the breeder's surprise, however, while there were blacks and whites in F_2 , there was also a third class with gray chaff, and this kind was several times as abundant as the white.

The explanation was that the black variety had, in addition to the gene B for heavy black pigment, also the gene G for a smaller amount of black pigment, which by itself would make the chaff gray. The black oats was thus of the genotype $BBGG$. Either the effect of G was completely concealed by that of B or the two genes cooperated to produce a result identical with that of B alone. The white-chaffed oats had the recessive genes of both pairs ($bbgg$); hence, it had no pigment.

The F_1 generation was $BbGg$, and was black. The F_2 generation consisted of $\frac{9}{16}$ BG (using the customary way of indicating characters by just one symbol), $\frac{3}{16}$ Bg, $\frac{3}{16}$ bG, and $\frac{1}{16}$ bg. The first two of these classes were indistinguishable, black; the third was gray, the fourth was white. The phenotypic ratio is thus 12 black to 3 gray to 1 white. It is derived from the 9:3:3:1 ratio by combining the first two terms.

The 12:3:1 ratio is obtained from two pairs of genes when each dominant gene has a visible effect by itself, but one of them conceals the other or the two cooperate to produce an effect identical with that of one of the genes alone.

The 13:3 Ratio.—As has already been noted in an earlier chapter, the white plumage of White Leghorn fowls is nearly dominant over the colors black, brown, or barred. Since white plumage in some other breeds, the Wyandottes and Plymouth Rocks for example, is recessive to color, the dominance of the Leghorn white is peculiar. The reason for the difference is that the white of Leghorns is due to an inhibiting gene (I), which prevents the color genes, if any, from coming to expression, whereas the white of Wyandottes and Plymouth Rocks is due to the absence of genes producing color.

When the breeds are crossed, these two kinds of white may be brought together. The White Leghorn may be indicated by $IICC$, the gene C being that for color, which is inhibited by I . The white Wyandotte is icc , since it lacks both the inhibitor and the basic color gene. The F_1 fowls are $IiCc$ —hence white. The F_2 derived from them are $\frac{9}{16}$ IC, $\frac{3}{16}$ Ic, $\frac{3}{16}$ iC, and $\frac{1}{16}$ ic. Of these classes, three (IC, Ic, and ic) are white (the first because of the inhibitor, the third

because no color gene is present), while one (*iC*) is colored. The ratio in F_2 is thus 13 white to 3 colored.

Inhibiting genes are the primary cause of this particular modification of the 9:3:3:1 ratio.

Duplicate Genes.—Sometimes a character may be produced by either one of two pairs of genes at different loci. These genes are identical. If they are not cumulative in their effect, both pairs may exist in the same individual and still produce only the character that either one alone would determine. Such genes are known as *duplicate* genes. They do not afford an example of interaction of genes, but they do cause a striking modification of the expected F_2 ratio.

One of the earliest known instances of duplicate genes concerned shape of seed capsule in the weed shepherd's-purse. Among the several forms that the seed capsule may assume are the common triangular one and the spindle shape. When plants with triangular capsules were crossed with those having spindle-shaped capsules, the F_1 was triangular. The F_2 , as was expected, divided between the two forms; but the triangular ones were much more abundant than three-fourths of the total.

The reason for this unexpectedly large proportion of triangular capsules is that two genes, identical with each other, produce that shape. These genes have been called *C* and *D*. The triangular-capsuled plants were *CCDD*, the spindle-shaped *ccdd*. Their hybrid (*CcDd*) had triangular capsules. When these double heterozygotes were self-fertilized, the 16 F_2 combinations were those shown in Fig. 69. The formulas there shown are separated into their egg and pollen components but may easily be recast to bring the two genes of the same pair together as is usually done. Any of these F_2 plants which have at least one *C* or at least one *D* will have triangular capsules. Having both *C* and *D* does not alter the shape, the capsule is still triangular. Fifteen of the sixteen combinations thus yield triangular capsules, only one spindle-shaped. This 15:1 ratio is derived from 9:3:3:1 by combining the first three classes. Duplicate genes without cumulative effect are regularly expected to produce this modified ratio.

That duplicate genes are the true explanation of the capsule shapes of shepherd's-purse is readily shown by breeding the F_2 plants further. If the various plants of that generation be self-fertilized, they produce one or both kinds of offspring, depending on their genotypes. The ratios placed below the illustrations in Fig. 69 indicate the proportion of triangular to spindle-shaped in the progeny of the respective plants.

The ratio 1:0 means that all plants are triangular, while 0:1 indicates that all are spindle-shaped. The other ratios involve both types. Any plant that is homozygous for the recessive genes of one pair and heterozygous for the other pair yields triangular and spindle-shaped in the ratio of 3:1, while a plant heterozygous for both pairs produces the same types in the ratio of 15:1. Finding that certain proportions of the triangular F_2 plants yield these several ratios (1:0, 3:1, and 15:1) is evidence that duplicate genes are the correct explanation.

















	$\sigma \rightarrow CD$	Cd	cD	cd
$\text{♀} \rightarrow CD$	$CD \cdot CD$  1:0	$CD \cdot Cd$  1:0	$CD \cdot cD$  1:0	$CD \cdot cd$  15:1
Cd	$Cd \cdot CD$  1:0	$Cd \cdot Cd$  1:0	$Cd \cdot cD$  15:1	$Cd \cdot cd$  3:1
cD	$cD \cdot CD$  1:0	$cD \cdot Cd$  15:1	$cD \cdot cD$  1:0	$cD \cdot cd$  3:1
cd	$cd \cdot CD$  15:1	$cd \cdot Cd$  3:1	$cd \cdot cD$  3:1	$cd \cdot cd$  0:1

FIG. 69.—Duplicate genes in the inheritance of the shape of seed capsule of shepherd's-purse. The formulas are those of the F_2 generation from a cross between a variety with triangular seed capsule and a variety with spindle-shaped seed capsule. If the plants of the F_2 generation are self-fertilized, they produce triangular and spindle-shaped offspring in the ratios indicated in the respective squares. (From G. H. Shull.)

The origin of duplicate genes is almost certainly to be found in the doubling of the chromosomes. The species of shepherd's-purse used in the foregoing experiments has 32 chromosomes per cell, but there is evidence that it came from a species having 16 chromosomes, merely by duplicating each chromosome. If there was one pair of genes for capsule shape in the 16-chromosome species, there would be two pairs in the 32-chromosome species. The two pairs would be identical in nature. They would commonly be designated by the same letter with

different subscripts (T_{1t_1} and T_{2t_2} , respectively), but the earlier designations C and D have here been preserved to correspond to the illustration.

Three Pairs of Genes.—Modified ratios are as much to be expected when three pairs of genes interact as when there are only two pairs. One example will suffice to illustrate what happens. Color in the flowers of sweet peas has already been used to show the effect of interaction between two genes. One of the genes (C) produces a chromogen, the second (R) an enzyme that converts the chromogen into a colored substance. To these may now be added a third, gene B , a bluing factor. If C and R are together in a given plant, the flower is red. If in addition the plant has the gene B , the red is converted into purple.

Suppose that a plant with the genotype $CCRRbb$ (which is red) is crossed with one which is $ccrrBB$ (which is white). The offspring are $CcRrBb$, and are purple. When these F_1 plants are self-fertilized, they produce the kinds of F_2 shown in the following table, in which only the genes coming to expression are shown:

Fraction	Expressed genes	Phenotype	Ratio
$\frac{27}{64}$	CRB	purple	27
$\frac{9}{64}$	CRb	red	9
$\frac{9}{64}$	CrB	white	28
$\frac{9}{64}$	cRB	white	
$\frac{3}{64}$	Crb	white	
$\frac{3}{64}$	cRb	white	
$\frac{3}{64}$	crB	white	
$\frac{1}{64}$	crb	white	

The usual trihybrid ratio, which is indicated in the first column of the above table, is converted into 27:9:28 by combination of its last six terms. Some of the white plants are white because they lack the enzyme, some because they lack the chromogen, some because both chromogen and enzyme are missing.

PROBLEMS

101. Black is dominant in the male, recessive in the female in Ayrshire cattle. If a red cow mated with a red bull has given birth to a black calf, what is the sex of the calf? What is the genotype of the mother? Of the father?

102. If black-chaffed oats $BbGg$ is crossed with gray $bbGg$, and they produce 160 offspring, how many of these should be gray?

103. If a white leghorn hen $Iicc$ is mated with a colored cock $iiCc$, how many of their offspring should be colored?

104. How many chromosomes in a leaf cell of shepherd's-purse should contain the locus for capsule shape?

105. If skin color in Negroes is produced by five pairs of genes, all equally potent, all lacking dominance, and having cumulative effects as between pairs, how many grades of mulattoes are there?

106. By what tests would you recognize "blending" inheritance (that is, inheritance dependent on multiple nondominant cumulative genes)?

107. If an F_2 generation from a cross between homozygous rose- and pea-combed fowls includes 15 pea-combed fowls, how many rose should there be? How many single? What other phenotype, and how many?

108. In corn, C and R are necessary for color of endosperm, which is red in the absence of any modifying gene. If P is likewise present with C and R , the endosperm is purple. With either cc or rr the endosperm is white. If red corn $CcRrpp$ is crossed with white $ccRrPp$, how many of their 80 offspring should be white?

109. A white female clover butterfly Ww mated with a yellow male Ww produces 56 offspring. How many of these should be yellow females? How many yellow males? White females? White males?

110. If a triangular-capsuled shepherd's-purse of genotype $Ccdd$ is pollinated by a triangular-capsuled $CcDd$ and they produce 80 offspring, how many of these should have spindle-shaped capsules? How many triangular?

111. What is the phenotype of a mouse whose genotype is $CCauBbddPpss$?

112. If a cross between two plants of shepherd's-purse with triangular capsules yielded 23 plants triangular and 3 spindle-shaped, what genotypes could you assign to the parents? Is more than one answer possible?

113. If in the preceding problem the progeny had been 23 triangular and 8 spindle-shaped, what genotypes could the parents have? Give three answers.

114. If a cross between red and white wheat is carried to the F_2 generation, and this includes 7 whites among 118 plants, what is the genotype of the original red?

115. If in the preceding problem there are 4 whites among 251 in F_2 , what is the genotype of the original red?

116. How many true-breeding strains of red wheat, differing in the degree of redness, could you establish out of the F_2 generation of the preceding problem?

117. One type of deafness in man results from either or both of two recessive genes at different loci; both of the dominants together give normal hearing. If a normal man marries a deaf woman, and five of their eight children are deaf, what genotypes could you assign to the parents?

118. Baldness is dominant in men, recessive in women. A bald man whose wife has normal hair has a bald daughter and a nonbald son. What are the genotypes of the parents? If they had had four more sons, how many of them should have become bald? If they had had four more daughters, how many of these should have become bald?

119. Two yellow clover butterflies have some yellow and some white female offspring. What are the genotypes of the parents? What phenotypes may their sons possess?

CHAPTER 13

MODIFICATION BY ENVIRONMENT

The development of an organism, or of any part of it, rests on the interplay of chemical and physical forces. The genes are chemical and physical units, working in a chemical and physical laboratory, the protoplasm. The organism as a whole is in an environment that is largely chemical and physical. It is inevitable, then, that some of the activities of some genes should be influenced by some features of the environment. The student of heredity is deeply concerned with these influences. Some of the best understood environmental agents and their known influences are described below.

Influence of Temperature.—Among the numerous color varieties in the Chinese primula are one with red and one with white flowers. Under ordinary circumstances these two types are quite distinct, each one breeding true. In greenhouses, where temperatures are apt to range from 13° to 18°C., or even in dwelling houses with temperatures of 20° to 22°C., the distinction is maintained. But if a plant of the red variety is grown at a temperature of 35°C., its flowers are white. If a plant of the red type is raised at 18°C. until it begins to blossom, its flowers being red, and then is transferred to 35°C., the flowers that open the next few days will be red, but those opening later will be white. At the higher temperature flowers continue to open white; but if the plant is returned to the lower temperature, after a few days the new flowers open red as before. The effect of high temperature is strictly temporary. The genes distinguishing the two varieties have not been changed.

In the vinegar fly *Drosophila* the eye is regularly large and elliptical; but a genetic modification results in the bar eye (Fig. 53), in which the separate elements or ommatidia are limited to an irregular vertical band. The size of this band depends on the temperature at which the flies are raised; the higher the temperature, the smaller the band. At low enough temperatures bar eye is almost like the wild-type eye.

Vestigial wing in the vinegar fly, a short and crumpled wing which is held out from the body and is useless for flight, is subject to change by temperature. High temperature makes the wings more nearly normal,

but it must be applied to the larva; keeping the pupa warm has no such effect. The vestigial wing developed at ordinary temperature and that at high temperature are shown with the wild-type wing in Fig. 70.

In each of the foregoing examples the environmental effect is observed only in individuals having a certain gene. Primulas must have the red gene, *Drosophila* the duplication (page 86) for bar eye, in order that temperature may have the effect indicated. Each of these varieties differs from the normal organisms by just the one pair of genes.

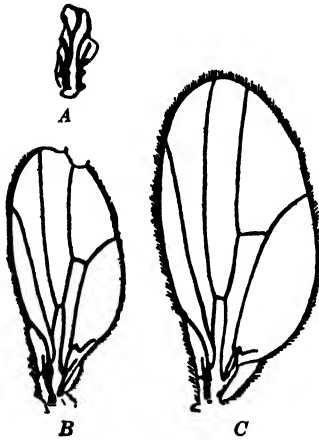

FIG. 70.—Effect of temperature on vestigial wing in *Drosophila*. A, vestigial at normal temperature; B, at high temperature; C, wild-type wing. (From Li and Tsui in *Genetics*.)

Effect of Light.—The best known developmental influence of light is that upon wings in plant lice or aphids. These insects, in the parthenogenetic part of their reproductive cycle, may be either winged or wingless. Just how genes are related to wings is not known, but wings have a genetic basis, for different strains have different propensities to wing development, and they respond differently to light. One kind of aphid, under a given set of environmental conditions, may have wings in 50 per cent of

individuals, another kind in only 2 per cent. In some strains of a certain species, aphids raised in continuous light are almost all wingless, while those reared in alternate light and darkness are almost all winged. The winged and wingless members of this strain are presumably genetically alike but are made phenotypically different by light conditions.

Light produces a well-known darkening of the skin in human beings. Races of men are unlike in their skin pigmentation, and this distinction rests on differences in genes. While no amount of tanning of the skin of a white person could deceive anyone into thinking that the darkened individual belonged to one of the colored races, the lack of confusion is partly due to the fact that races are distinguished by other things than skin color—shape of hair, features, etc. With respect to skin color alone, the influence of light on a white skin does tend to erase the racial distinction.

Nutrition.—In the common weed called the teasel, the stems are normally squarish. One variety, however, differs from the normal

type by one mutant gene and has as a consequence a twisted stem (Fig. 71). Not all possessors of the twisted gene have twisted stems, however. Plants must be rather well fed for the torsion to develop. Good soil, enough water and room, freedom from disturbance during growth, are means of providing this nutrition. Set the plants in sandy or gravelly soil, crowd them, withhold water from them, or transplant them two or three times, and the stems remain square even in the twisted variety. No such influence of nutrition can be exerted on the normal type. Despite any favorable treatment with respect to food, the common variety remains square-stemmed.

Many modifications of animals by differences in nutrition have been observed. A moth whose caterpillars normally eat only oak leaves may, by being forced to feed on walnut in these young stages, be made much paler. Bullfinches develop darker feathers if fed hempseed. Green parrots of South America, if fed on the fat of catfish, become variegated with red and yellow. In none of these examples does the environmentally modified individual resemble a different genetic variety; yet the characters changed are undoubtedly determined by genes.



FIG. 72.—Mammalian embryo in the uterus of the mother, showing mode of nutrition. *p*, placenta; *u*, umbilical cord.

cord (Fig. 72). The mother may therefore influence the qualities of



FIG. 71.—Portion of teasel plant of one variety showing twisted stem. (After DeVries, *The Mutation Theory*, Open Court Pub. Co.)

Nutrition in developing embryos is capable of determining to some extent such general qualities as size, vigor, and general health. The advantage given to favored individuals in the developmental stages sometimes holds over to the adult. In mammals, this environmental modification may *appear* to change the rules of heredity because of the source of the nutrition. The embryo is developed within the body of the mother, and the already digested food is received from her through the placenta and umbilical

her offspring more than the father does in general physiological respects. Genetically the influence of the two parents is of the same degree except in sex-linked characters. But within the lifetime of the individual, particularly in early life, the mother may seem to be the more important.

Moisture.—A single example of the influence of moisture may be given. In *Drosophila*, each segment of the abdomen is marked by a dark stripe, extending across the body. In one of the mutant varieties of this fly, differing from the wild type in just one pair of genes, these bands of color may be interrupted, narrowed in places, or even lost. This mutation is called "abnormal abdomen." To possess these irregular markings, however, the fly must grow up in ordinarily moist conditions. If its surroundings are exceptionally dry, as in a very old culture bottle, the disturbances may largely or even wholly disappear, and the abdominal markings appear normal.

Chemical Substances.—Since development is largely a chemical phenomenon, it would be expected that unusual substances present during growth would modify adult form very considerably. Mostly, however, attempts to modify organisms by chemical treatment have proved disastrous. It is hard not to make the treatment too severe, and inviable monsters result. Nevertheless, some aquatic crustacea have been modified by putting small quantities of salts into the water in which they live. These animals have different forms of body, including a beak or protrusion of the head, in different strains. To some extent these differences are genetic, since the strains differ with respect to them under like conditions, though in no instance is it known how many pairs of genes are concerned in the distinction. Changing the salt content of the water has changed members of a long-beaked strain, for example, so as to make them resemble those having a short rounded beak.

Hormones.—The most widespread success in chemical interference with genetic characters has been attained by the use of hormones in the vertebrate animals. Hormones are substances produced in ductless or endocrine glands (Fig. 73), or perhaps by tissues in general. From these glands or other places of origin, whatever their nature, they diffuse into the blood. There they are carried about, come into contact with many different organs or tissues, and, to some of these organs, serve as chemical messengers. The hormones control in some degree the activities of those parts which are responsive to them. In adult animals, physiological processes are thus controlled; in embryos, development is in part directed by them.

Important endocrine glands are the thyroid, the adrenal bodies closely associated with the kidneys, and the pituitary at the base of the brain. Certain other organs best known for other functions also produce endocrine secretions. Thus the principal reproductive organs, the ovaries and testes, secrete substances directly into the blood, as also does the pancreas whose best understood function is the production of a digestive fluid.

The functions of these glands are exceedingly variable. The thyroid has primary control of the rate of metabolism, accelerates growth, and regulates differentiation. Through these capacities, it normally prevents such defects as cretinism and myxedema. Metamorphosis in frogs and salamanders, or the transformation of the tad-

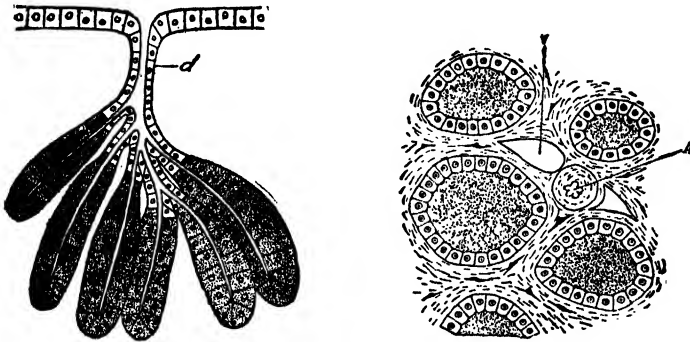

FIG. 73.—Two kinds of glands. At the left, gland with duct (*d*) through which the secretion is discharged into some cavity or upon a surface. At the right, part of a ductless gland, the thyroid, whose secretion leaves the gland by diffusion into the blood carried by the arteries (*A*) and veins (*V*) scattered through the organ.

pole into the adult, is dependent on a proper thyroid secretion. The pituitary produces several hormones, by which it regulates growth, controls the cyclical development of the reproductive organs, and governs the activity of several other endocrine glands. Adrenalin stimulates the sympathetic nervous system, and through it affects the heart and blood vessels, involuntary muscle action, and coagulation of the blood. The adrenals and pituitary together govern color changes in frogs and other amphibia, by expanding or contracting the pigment in certain cells of the skin. Insulin, which is produced by certain groups of cells in the pancreas, governs sugar metabolism and is important in the prevention of diabetes mellitus. The ovaries and testes produce internal secretions that influence the development of secondary sexual characters, to be described in a later chapter.

Hormone Modification of Inherited Characters.—Among the things altered by endocrine secretions are some that have a known and sometimes fairly simple genetic basis. Cretinism, some kinds of goiter, hair growth, blood pressure, diabetes insipidus, and diabetes mellitus are in some degree inherited, as described in a later chapter, and their dependence on certain hormone conditions indicates the important relation which these substances have to heredity.

Endocrine racial types have been distinguished by some anthropologists, who describe the Caucasian as marked by strong development of the pituitary and adrenals, the Negro as deficient in adrenals, and the Mongolian as defective in the thyroid. Certain biologists have suggested that such features as slenderness or stockiness of build, baritone or tenor voice, alert or sluggish mentality, and long or round head are dependent on whether the thyroid is highly effective or deficient. Along with this suggestion goes the companion notion that if the food of an individual habitually includes much iodine-containing material, the activity of the thyroid is thereby increased, and the corresponding structural changes follow. Sea foods in general contain more iodine than do the foods common in most inland regions, and those who see in the thyroid an important agency in the production of certain physical and mental characteristics are not at a loss for examples of corresponding differences between coast dwellers and those far from the ocean.

Since racial characters are inherited characters, the supposed dependence of race distinctions upon hormones would constitute chemical modification of genetic characters.

Internal Environment.—The question may be raised whether, with respect to endocrine secretions, we are or are not dealing with the environment. Are they not merely part of the physiological mechanism through which the pertinent characters are developed? If the hormones themselves are governed by genes, any characters that they modify are as purely genetic as are other characters in whose development the intermediaries are not known. The hormones would constitute an internal environment, but one which, if the above supposition were correct, would be wholly controlled by the genotype.

The endocrine secretions have, however, some variability, which is, or may be, independent of the genes. They are not always present in the same quantity, nor have they always the same quality. Some of them are notably influenced by the diet and by mental and other physiological states. The mode of life, degrees of comfort or hardship, would therefore have an important relation to hormones and hence to

development. Furthermore, the essential chemical principles of these secretions may be extracted and administered in medical practice. Important means of artificial control of inherited characters are thus afforded.

Heredity versus Environment.—The knowledge that genetic characters are modified by environmental agencies, even to the extent of making them resemble other genetic characters, should effectively dispose of any notion that a quality (phenotype) must be either hereditary or environmental. One still hears asked the question whether this or that trait is hereditary or environmental, with the implication that these categories are mutually exclusive. The fact is, it may be both. A quality may properly be said to be inherited if it has a genetic basis of any sort, no matter how much it may be influenced by external agencies. If two individuals, in their development, respond differently to the same environment, it is usually safe to say that the respect in which they differ is a genetic quality. Even if environment is much more influential than the genes, the character is still hereditary. And no matter how little environment changes development, any trait thus modified is environmental—as well as genetic.

Qualities differ enormously in their degree of dependence on external factors. Eye color in man, as in the other mammals, is almost wholly fixed by the genes. Fingerprint patterns, short of actual mutilation of the skin, are probably nearly free of any environmental influence, except that which resides within the individual. Stature, on the contrary, can be considerably modified by treatment sufficiently early. General vigor is likewise so governed in large part, and conditions bad enough may easily undermine even the most perfect physique.

It is seldom profitable to estimate the relative dependence of a character on heredity and environment. To say that a quality is 70 per cent inherited has only a statistical significance, which might be of use to an insurance company when writing policies. More is to be gained by discovering the *way* in which both heredity and environment influence it. This information, if gained, can then be applied to individual cases.

PROBLEMS

120. How do you suppose development would be altered by low temperature if rates of growth of different parts were affected unequally?

121. What effect on inherited characters of mammals might be produced if blood were to pass rather freely through the placenta between mother and fetus?

122. What is misleading in the old classification of human traits in two categories, hereditary and environmental?

123. Why did hormones once contribute to the confusion of heredity and environment as controlling influences in development?

124. What human characters do you conceive to be most nearly free from environmental modification?

125. If a disease is found to be caused by an infective germ, and never develops in the absence of that germ, does that absolve heredity from any responsibility for the disease?

126. If means should be found of curing a hereditary defect or disease, would that make it undesirable to reduce the frequency of the causative gene in the population?

127. Of what advantage are identical twins in studies of the general subject matter of this chapter? Why are they more useful than fraternal twins?

CHAPTER 14

LINKAGE

In earlier chapters, when two pairs of genes were simultaneously studied, examples were so chosen that genes would be distributed to the germ cells independently. As a consequence of their random recombination in the reduction division, the several classes of germ cells produced by a heterozygous organism were equally numerous, and the phenotypic dihybrid ratio in F_2 was 9:3:3:1. When in some of these examples the genes interfered, or cooperated, with each other in the

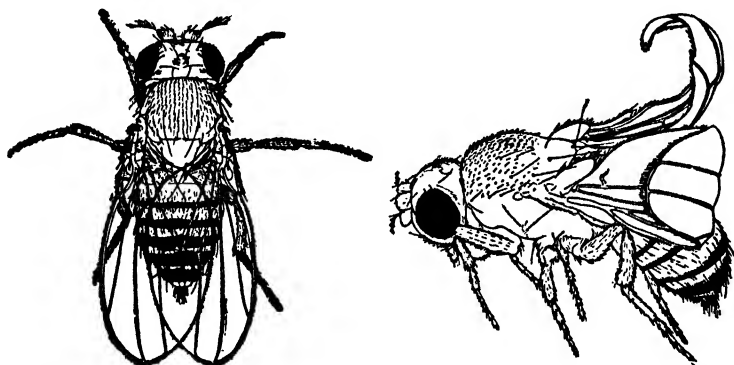

FIG. 74.—Wild-type *Drosophila*, left, and its curled-wing mutation, right. (From Morgan, Bridges, and Sturtevant in *Bibliographia Genetica*.)

production of their characters, their distribution to the gametes was still free and random, and the F_2 ratio was some modification of the 9:3:3:1 ratio, such as 9:3:4 or 9:7. All this independence rested on the fact that the two (or more) pairs of genes were in different pairs of chromosomes, and the chromosomes are independent in their placement on the reduction spindle.

Linkage in Male *Drosophila*.—The story is very different when the two pairs of genes are in the same pair of chromosomes. What happens will be better understood from concrete examples, and the first is taken from among the numerous characters of *Drosophila*. One pair of genes concerns the shape of the wings; the wild-type fly has flat wings which rest horizontally, the mutant type curled wings (Fig. 74). The other

pair governs the color of the ocelli, the wild type being reddish-yellow, the mutant variety white (Fig. 62).

These two pairs of genes are in the same pair of chromosomes, namely, the so-called third pair. The genes for shape of wings are located about the middle of these chromosomes, those for color of ocelli about halfway between the middle and one end, as diagrammatically illustrated in Fig. 75. Suppose that the mutant genes are matched against their wild-type alleles by crossing a fly having flat wings and yellow ocelli (the wild-type characters) with one having curled wings and white ocelli, as in Fig. 76. In accordance with a common practice already outlined in an earlier experiment, only the

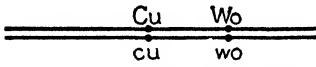

FIG. 75.—Chromosome pair 3 in *Drosophila* with the genes for curled wing (*cu*) and white ocelli (*wo*) and their wild-type alleles.

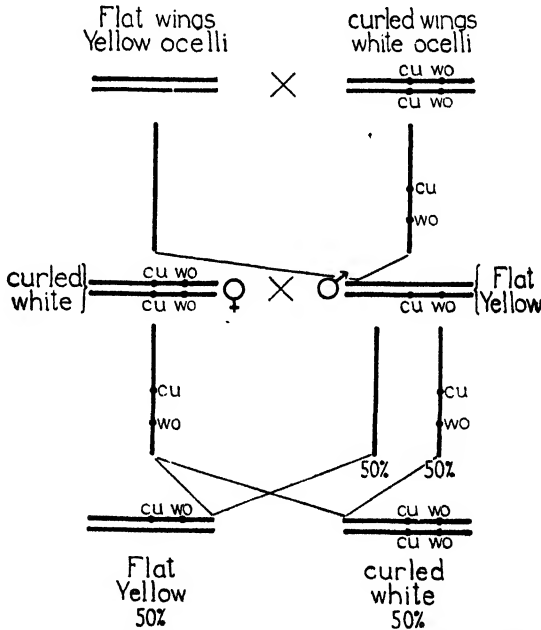

FIG. 76.—Linkage of genes for curled wing (*cu*) and white ocelli (*wo*) in *Drosophila*, as illustrated by a cross between a doubly heterozygous F_1 male and a doubly recessive (hence homozygous) female. Wild-type genes are not marked.

mutant genes are marked in the chromosomes. Any chromosome unmarked is thus shown to contain only wild-type genes, with respect to all loci under consideration. The eggs of the wild-type female (left) thus have only wild-type genes; the spermatozoa of the male

(right) have the genes for curled and white ocelli in the same chromosome. In the offspring, therefore, one chromosome of this pair has the two mutant genes *cu* and *wo*, while the other has no mutant genes (that is, it contains *Cu* and *Wo*). These F_1 flies have, of course, flat wings and yellow ocelli.

A male is now chosen from the F_1 generation, and mated with a doubly recessive female out of the curled white stock. She has the genes *cu* and *wo* in both of her chromosomes of the third pair. This homozygous female produces only one kind of egg, *cu wo*, with both of these genes in the same chromosome. The F_1 male shows now the

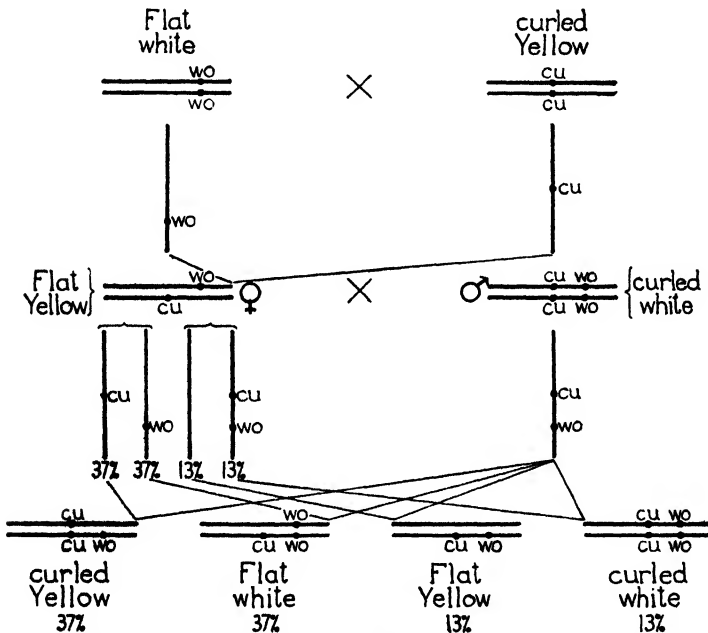

FIG. 77.—Linkage of genes for curled wing (*cu*) and white ocelli (*wo*) in *Drosophila* as illustrated by a cross between a doubly heterozygous F_1 female and a doubly recessive (hence homozygous) male. The chromosomes remain intact in 74 per cent of the oöcytes, break and recombine in the other 26 per cent.

effect of the linkage. While in all examples so far presented an individual that is heterozygous for two pairs of genes produces four kinds of germ cells, this male produces only two kinds of spermatozoa. At the reduction division the chromosomes separate, the wild-type chromosome going to one spermatocyte, the *cu wo* chromosome going to the other. Two, and only two, kinds of spermatozoa are thus produced. They should be equally numerous.

When these two kinds of spermatozoa fertilize the one kind of egg, two kinds of testcross offspring are produced. One kind has the wild-type characters, flat and yellow, and is heterozygous; the other kind is curled and white. They are present in about the same ratio as were the two kinds of spermatozoa, namely, 1:1.

Linkage in Female *Drosophila*.—An important modification of the linkage phenomenon is shown by the female. To illustrate this difference, let the cross involving curled wing and white ocelli be repeated; and to introduce variety, use a female having white ocelli (otherwise wild type, hence with flat wings) and a curled male (otherwise wild type, that is, with yellow ocelli). The cross is illustrated in Fig. 77. The eggs of the female are all *wo*, the spermatozoa of the male all *cu*. The F_1 flies are therefore heterozygous for both genes—hence are wild

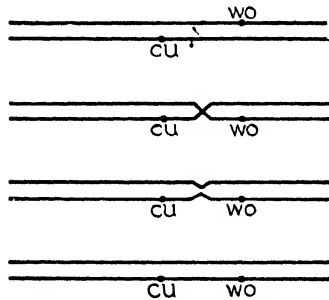

FIG. 78.—Diagram illustrating how two mutated genes in different chromosomes of the same pair may come to lie in the same chromosome, leaving wild-type genes at both loci in the other chromosome.

type, with flat wings and yellow ocelli; but *wo* is in one chromosome 3, *cu* is in the other chromosome of the same pair.

To proceed with the linkage test, let a female F_1 be mated with a doubly recessive male (*cucu wowo*). The male produces only one kind of spermatozoon (*cu wo*). The doubly heterozygous female, however, produces several kinds of eggs. Her chromosomes of pair 3 separate without change in the reduction division in most of the oöcytes, and there result some eggs containing *cu* and others with *wo*, in about equal numbers. Not all the oöcytes behave this way, however. In some of them the chromosomes of pair 3 effect an exchange, such as is diagrammatically shown in Fig. 78. The two chromosomes break at some point between the locus of *cu* and that of *wo*, and the pieces are recombined. As newly constituted, the one chromosome contains both *cu* and *wo*, while the other has both wild type alleles. When cells that have experienced this exchange undergo reduction, two additional kinds of eggs are produced, namely, wild type and *cu wo*.

About 74 per cent of all oöcytes retain their chromosomes of pair 3 intact, so that 37 per cent of the eggs are *cu*, 37 per cent *wo*. In the remaining 26 per cent the chromosomes break between *cu* and *wo* and exchange parts. Hence, 13 per cent of the eggs are *cu wo*, 13 per cent wild type (*Cu Wo*). When these eggs are ferti-

lized by the *cu wo* spermatozoa, four kinds of offspring are produced, as illustrated in the lower part of Fig. 77. Naturally, these four kinds of offspring bear the same numerical relation to one another as did the four kinds of eggs, for they are the same individuals with identical spermatozoa added. Their ratio is thus 37:37:13:13.

Proof of Linkage.—Though the order of events is that described in the preceding sections, linkage is discovered in concrete examples by reasoning backward. One infers what happens from the adult offspring produced in crosses. For example, in Fig. 76, when the last cross results in only two kinds of offspring in equal numbers, it is known that the father (the only heterozygous parent) produced only two kinds of spermatozoa in equal numbers. Furthermore, from the characters of the offspring it is known that one of the kinds of spermatozoa had the genes *cu* and *wo*, the other kind their wild-type alleles. It is obvious that these chromosomes have gone over to the germ cells without change. That is, there have been no breakage of the chromosomes and recombination of their parts.

In Fig. 77, when the last cross yields four kinds of offspring in the ratio of 37:37:13:13, it is known that the eggs of the mother (the heterozygous parent) produced four kinds of eggs likewise in the ratio of 37:37:13:13. The characters of the offspring also show what genes were in each of these kinds of eggs. They prove that the two more numerous classes had the same genes as did the respective parents of the heterozygous female. These two classes must therefore have received unbroken, unrecombined chromosomes from the reduction division. The two minority classes of eggs are similarly shown to contain chromosomes reconstituted through breakage and exchange of pieces. To explain the 37:37:13:13 ratio, it is necessary to assume that in 74 per cent of the oöcytes the chromosomes of pair 3 remain intact, at least they do not break between *cu* and *wo*, while in 26 per cent of the oöcytes such breakage and recombination occur.

The argument thus leads back from ratios of offspring and the characters they possess, to the behavior of the chromosomes necessary to explain those ratios and characters.

Multiple Crossing Over.—The breakage and recombination of parts of chromosomes are known as *crossing over*. It may happen at more than one place in the length of a chromosome pair. To detect the additional crossing over, it is necessary to have more heterozygous pairs of genes as markers. Specifically, the number of markers must be one more than the number of crossovers to be discovered. To prove double crossing over, therefore, the chromosomes must have

unlike genes at each of three loci; to discover triple crossing over requires four loci with heterozygous genes.

To illustrate double crossing over concretely, take the characters black body (*b*), curved wing (*c*, different from curled, *cu*), and plexus or irregular wing veins (*px*), all in chromosome 2 in *Drosophila*. If a black curved plexus fly is crossed with the wild type, their offspring will have the composition shown in Fig. 79, *A*. When these F_1 flies produce their germ cells, oöcytes in which the chromosomes of this pair remain intact yield two kinds of eggs, *b c px* and wild type. If single crossing over occurs between *b* and *c* (Fig. 79, *B*), the resulting germ cells are *b* and *c px* (omitting mention of wild-type genes). Single crossing over between *c* and *px* yields eggs that are *b c* and *px*,

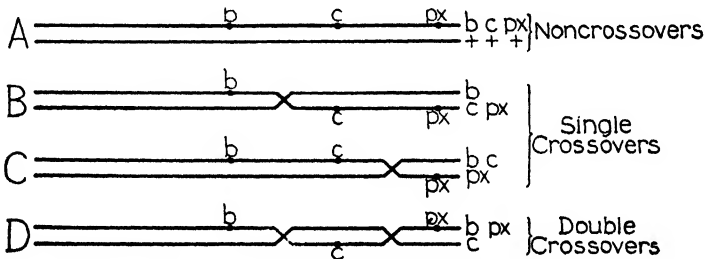

FIG. 79.—Single and double crossing over involving the genes for black body (*b*), curved wing (*c*), and plexus (*px*). The plus signs indicate wild-type genes, as does also the absence of any indicated mutated genes.

respectively (*C*). Finally, if there is double crossing over (*D*), the germ cells are *b px* and *c*.

Proof that these eight kinds of eggs are produced would be obtained by mating the F_1 females to males homozygous for all three recessives (*bb cc pxpx*). The offspring would show the various recessive characters for which there are genes in the several kinds of eggs in Fig. 79. The flies resulting from double crossover eggs would have curved wings, or they would be black-bodied with plexus wing veins (omitting mention as usual of the wild-type characters).

Crossing Over and Sex.—In *Drosophila* there is an important difference between the sexes with respect to linkage. While crossing over occurs in the female, there is under ordinary circumstances none in the male. In certain stocks of these flies it has been found possible to induce crossing over in the male by high temperature and by X rays, and such exchange may happen in very rare individuals under ordinary conditions; but in typical experiments these possibilities may be ignored.

In at least one other organism, the silkworm moth, there is a similar difference between the sexes, but their relations are reversed. There is crossing over in the male but none in the female. The reason for this distinction between the sexes is unknown for either animal, but the reversal in the silkworm as compared to *Drosophila* is doubtless part of the reversed relation of sex to chromosomes in these species (page 65).

In most organisms, however, both animals and plants, crossing over occurs in both sexes. Moreover, there is no striking difference in the frequency of that exchange in the two sexes. Unless it is specified in a particular example that it is *Drosophila* (several species) or the silkworm moth that is involved in linkage, crossing over should be assumed in either sex.

Chromosome Maps.—The genes *cu* and *wo* used to illustrate linkage were assigned definite locations in the third chromosome. How is it known where these genes are? They cannot be recognized in a microscope. Even in the greatly enlarged salivary-gland chromosomes (Fig. 19), where perhaps the genes may be identified with the disks or crossbands, the tests which would indicate which of these disks are *cu* and *wo* have not yet been made. Knowledge of the position of genes comes from linkage experiments. It is assumed that crossing over (breakage of chromosomes) occurs at random throughout the length of the chromosomes. This is not a wholly correct assumption, for it is known that certain regions of a chromosome break somewhat more readily than others; but the supposed indiscriminate placement of the breakages may stand for this discussion.

Now, crossing over can be discovered by genetic experiments only when the chromosomes break at some point between two pairs of genes for which the individual is heterozygous. Breakage may occur at other places, but if there is not a heterozygous pair of genes on each side of this break to serve as markers, the crossover is not detected. If these pairs of heterozygous genes are far apart and the chromosome breakages occur at various points at random, many crossovers should occur between them and be discovered; if the pairs of genes are close together, recognized crossovers will be few. Under these circumstances, the distance between the marking genes is judged from the number of breakages between them. If breakage occurs between genes *a* and *b* in 10 per cent of the oöcytes, these genes are a certain distance apart; if breakage between *a* and *c* occurs in 20 per cent of the oöcytes, *a* and *c* are twice as far apart as *a* and *b* are.

The data just postulated permit a beginning of the mapping of the

chromosome. Genes *a* and *b* are placed somewhere on the chromosome, at a distance from each other which is assumed to allow 10 per cent of crossing over (Fig. 80). Gene *c* must then be placed twice that distance from *a*. There are, however, two positions that fulfill this requirement, one beyond *b* to the right, one to the left of *a*, as shown by the second and third lines of Fig. 80. Which of these is the correct position is determined by using *b* and *c* in a linkage experiment. If it is found that crossing over (breakage) between *b* and *c* occurs in about 10 per cent of the oöcytes, *c* is placed to the right; but if crossing over between *b* and *c* occurs in about 30 per cent of all oöcytes, *c* is placed 20 units to the left of *a*. The unit is a distance that permits 1 per cent of crossing over.

Let it be assumed that *c* is to the left of *a*. Another gene, *d*, is now used with one of the located genes, perhaps *b*, in a linkage experiment.

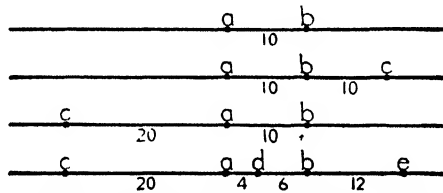

FIG. 80.—Early steps in the mapping of a chromosome. The numbers refer to the percentages of crossing over, hence distances, between the genes.

If it is found to be 6 units from *b*, and in another experiment using *d* and *a* is found to be 4 units from *a*, gene *d* is placed between *a* and *b*, as in the fourth map of Fig. 80. Suppose gene *e* is subsequently found to be 22 units from *a* and 42 units from *c*. It is accordingly located on the map 12 units to the right of *b*. Further new genes are added by testing them with 2 genes whose loci are already known and by placing them on the map at the place that will satisfy both distances thus determined.

After a considerable number of genes have thus been placed, one gene is found to occupy one extreme position beyond which no new gene has been located, another gene is located at the other end of the row. These genes are then assumed to be near the ends of the chromosomes, and one end is arbitrarily called "left," the other "right." These terms are mere conveniences, however. In making a map the earliest known gene is set down somewhere, and the next one known or located is put to the right of it, so that right and left depend merely on the order of discovery or testing. The gene that has held the extreme left position for a long time is then assigned the locus 0, and others are

given numbers that represent their ascertained distances from one another.

Maps showing a partial list of the genes located in the four chromosome pairs of *Drosophila* are shown in Fig. 81. The left end is at the top, right at the bottom. The gene for curled wing (*cu*) is at locus 50 of chromosome 3 and that for white ocelli (*wo*) is at locus 76.2. They are placed 26.2 units apart because crossing over occurs between them in 26.2 per cent of the oöcytes. From these maps, by noting the loci of any two genes, the amount of crossing over that might be expected to take place between them can be estimated. Thus, if vestigial wing, which is at locus 67 in chromosome 2, were tested with brown eye, whose locus is 2-105, there should be about 38 per cent of crossing over between them.

Linkage Ratios in F₂.—While test crosses are the best *measures* of linkage, because the percentages of crossing over can be read off directly in the proportions of the different classes of offspring, linkage can usually be *detected* in F₂ generations because of the peculiar ratios which result. This is particularly true in *Drosophila* because of the absence of crossing over in the male, and it is true in other organisms if the linked genes are very close together. Some practice in determining F₂ ratios in various linkage situations is desirable.

The genotype of a double heterozygote, if linkage is involved, must be written in such a way as to show which genes are in one chromosome, which in the other. If both dominant genes are in one chromosome, both recessives in the other, the formula is *CD-cd* or (*CD*)(*cd*). If there are one dominant and one recessive in each chromosome, the genotype is *Cd-cD* or (*Cd*)(*cD*). The F₂ ratio depends on which arrangement prevails.

Suppose that the double heterozygote is *CD-cd* and that there is 40 per cent of crossing over between the two pairs of genes. Assume further that the organism is *Drosophila*, with no crossing over in the male. The female *CD-cd* produces eggs of which 30 per cent are *CD*, 30 per cent *cd*, 20 per cent *Cd*, and 20 per cent *cD*. The male *CD-cd* produces only two kinds of spermatozoa, of which 50 per cent are *CD* and 50 per cent *cd*.

How these eggs and spermatozoa are combined may be ascertained by a calculation that resembles algebraic multiplication. The percentages are converted into decimal fractions, and the multiplication problem is set down thus:

$$\begin{array}{r} 0.3 CD + 0.3 cd + 0.2 Cd + 0.2 cD \\ 0.5 CD + 0.5 cd \\ \hline \end{array}$$

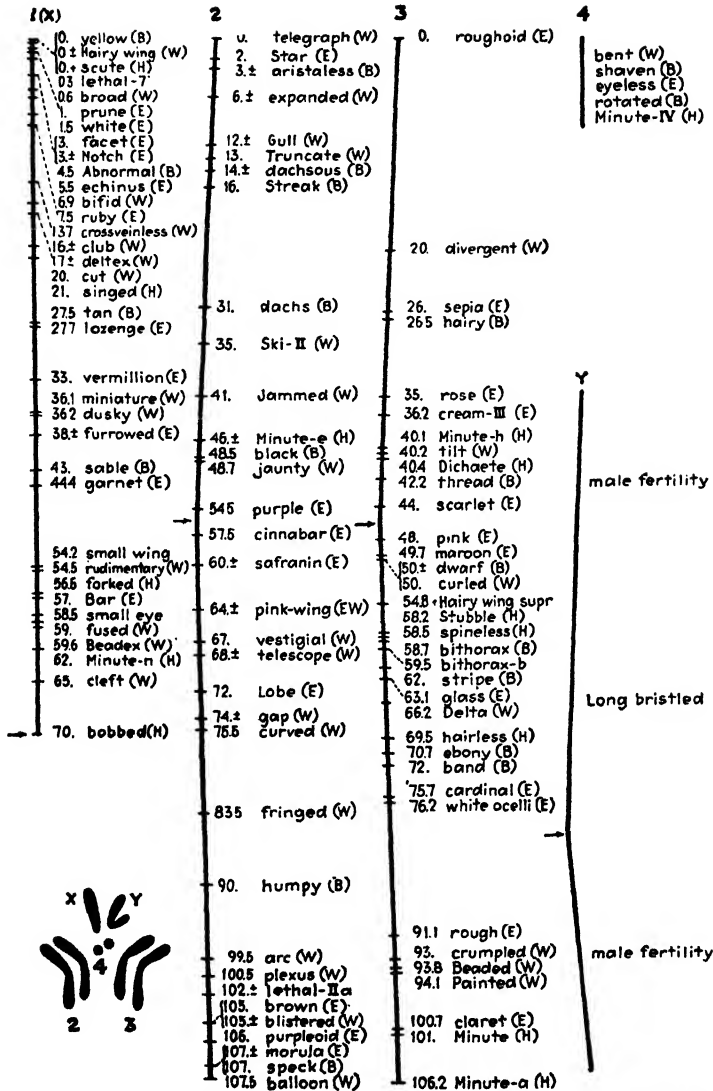

FIG. 81.—Partial maps of the chromosomes in *Drosophila melanogaster*. The letters in parentheses indicate the part of the body affected. B, body; E, eye; H, hairs; W, wings. Arrows point to attachment of spindle fibers. Locations in Y chromosome are not precisely known. Those in chromosome 4 are too closely linked for significant separation. (From Sharp, *Introduction to Cytology*, after Morgan, Sturtevant and Bridges, and Stern.)

The coefficients, indicating the proportions of the kinds of germ cells, are really multiplied. The formulas of the germ cells are not multiplied, but merely combined to form the genotype of one class of the offspring. In the offspring, the more usual formula may be used, not the one showing the arrangement of linked genes in the chromosomes, since the kinds of germ cells the offspring will produce are of no interest here.

The first partial product in this multiplication is 0.15 *CCDD*. The student will be allowed to carry out the remainder of the operation. When this is done, and the various partial products are collected into their respective phenotypes (appearances), it is found that the F_2 ratio is 0.65 *CD*:0.15 *cd*:0.10 *Cd*:0.10 *cD* or 13:3:2:2. Were the genes independent, this ratio would be 9 *CD*:1 *cd*:3 *Cd*:3 *cD*. The existence of linkage is thus demonstrated by the observed ratio.

If the organism used is not *Drosophila*, so that there is crossing over in both sexes, the other assumptions made in the foregoing example would result in both eggs and spermatozoa 30 per cent *CD*, 30 per cent *cd*, 20 per cent *Cd*, and 20 per cent *cD*. The multiplication thus becomes:

$$\begin{array}{r} 0.3 \text{ } CD + 0.3 \text{ } cd + 0.2 \text{ } Cd + 0.2 \text{ } cD \\ \hline 0.3 \text{ } CD + 0.3 \text{ } cd + 0.2 \text{ } Cd + 0.2 \text{ } cD \end{array}$$

If this multiplication is completed, and all of the same phenotype collected together, the F_2 ratio is found to be 59 *CD*:9 *cd*:16 *Cd*:16 *cD*. Again it is different from the 9:1:3:3 expected from independent genes, though not so strikingly different.

Next, assume that the linkage in the double heterozygote is *Cd-cD*, and that there is no crossing over in the male. The problem is:

$$\begin{array}{r} 0.3 \text{ } Cd + 0.3 \text{ } cD + 0.2 \text{ } CD + 0.2 \text{ } cd \\ \hline 0.5 \text{ } Cd + 0.5 \text{ } cD \end{array}$$

From this the phenotypic ratio in F_2 is 2 *CD*:1 *Cd*:1 *cD*. There is no *cd* class at all—a very easily detected indication of linkage.

Finally, let the linkage arrangement be *Cd-cD*, and assume that as in most species there is crossing over in the male. The multiplication is:

$$\begin{array}{r} 0.3 \text{ } Cd + 0.3 \text{ } cD + 0.2 \text{ } CD + 0.2 \text{ } cd \\ \hline 0.3 \text{ } Cd + 0.3 \text{ } cD + 0.2 \text{ } CD + 0.2 \text{ } cd \end{array}$$

The completed product, arranged into its phenotypes, is in the ratio 54 *CD*:21 *Cd*:21 *cD*:4 *cd*. Perhaps this would not be recognized as a result of linkage, since it might pass for 9:3:3:1.

From most of the ratios described in this section there is no *simple* or *direct* way of determining what the percentage of crossing over is. One of them gives absolutely no clue to that percentage. For species in which there is equal crossing over in both sexes, there are methods which enable one to ascertain the amount of crossing over, but these methods are scarcely suitable for elementary work.

Number of Linkage Groups.—The characters of any organism which are linked with each other because their genes are all in one pair of chromosomes constitute what is called a linkage group. Any two or more characters within one such group are linked; any two or more characters all of different linkage groups are independent in distribution.

The number of linkage groups in any animal or plant is the number of chromosome pairs. Only in a species that is genetically very well understood could characters of all of these groups be known. For *Drosophila*, the best understood species has long had on record the four linkage groups assigned to its four pairs of chromosomes; and these chromosomes are distinguishable in microscopic preparations. Corn has 10 linkage groups for all 10 of its pairs of chromosomes.

Other organisms are less well known. For these others no distinction will be made between linkage *groups* (two or more linked characters) and single independent characters. In rats, for example, 10 chromosomes are marked by groups of linked genes or by single independent genes. In tomatoes 10 of the 12 chromosomes have had genes assigned to them, in the morning-glory 12 out of 15, in the mouse 15 out of 20, in the rabbit 11 out of 22, and in poultry 10 out of the 16 or 17 that fowls must possess.

A word of caution is needed against the assumption that two characters found together most of the time are linked. Linkage does not make two characters hang together *in the long run*. It does so in some single families in which their genes happened to start together in the same chromosome; but in other single families linkage keeps these characters apart most of the time, because their genes started in opposite chromosomes of a pair. On the whole, therefore, linked characters are neither more nor less commonly together than independent characters are. When two qualities are found to occur together more frequently than would be expected from random distribution, the probable explanation is that they have some part of their genetic (physiological) basis in common. This relation could be called correlation (see Appendix), but it is not linkage.

Linkage in Man.—The best-known linkage group in man is the sex-linked group. Seven genes have been assigned either to the X chro-

mosome or to the Y, or to both. These genes have mostly not been tested with one another, but since they are all in the same pair of chromosomes they must be mutually linked. Fortunately certain of these X-chromosome characters have been found in the same family, so that their linkage could be tested in the usual way. Red-green color blindness was found to cross over with myopia and night blindness to the extent of around 40 per cent. At least one other such direct test of crossing over in the X chromosome has been made, and a tentative map involving seven genes for the XY pair has been prepared.

Linkage in the autosomes of man cannot be discovered in the usual way, because testercrosses with individuals of known genotypes cannot be made. There are statistical methods, however, which measure the probability of linkage. These methods are based on the number of like and unlike brothers and sisters in families. By these methods congenital absence of certain teeth is found to be linked with hair color, the crossing over occurring in about 14 per cent of the cells. Similarly, myopia was found linked with eye color. Oval blood cells and the blood-group agglutinogens A and B are probably linked, but the data are equivocal. Kloefer finds several groups of three characters that are linked. One such linkage group is eye color, finger length, and ear flare; another is hair whorl, hair color, and cross-eyes.

PROBLEMS

128. What determined the numbers by which the four chromosomes of *Drosophila* are designated?

129. What determined "left" and "right" as designations of the ends of a chromosome?

130. What sort of influence do you imagine would prevent crossing over in *Drosophila* males?

131. If for any reason the eggs of a female were 0.4 *CD*, 0.15 *Cd*, 0.2 *cD*, and 0.25 *cd*, and the spermatozoa of a male were 0.1 *CD*, 0.35 *Cd*, 0.5 *cD*, and 0.05 *cd*, and these two were mated, what fraction of their offspring should be *Ccdd*?

132. Why does linkage not suffice to keep two characters apart, or together, in evolutionary lines?

133. Does crossing over occur in *Gh-Gh*, as well as in *Gh-gH*?

134. If *AB-ab* × *aabb* produce, among 120 offspring, 50 of one kind, and *Cd-cD* × *ccdd* produce 60 of one kind among 180 offspring, which is the greater distance along the chromosome, from *A* to *B* or from *C* to *d*?

135. Is it likely that a testercross family which might demonstrate linkage would consist of 48 individuals of phenotype *St*, 13 *sT*, 16 *st*, and 52 *ST*? Why?

136. How many linkage groups of human characters should there be?

137. If *MmPp* × *mmpp* produce 160 offspring, numbering 39, 42, 38, and 41, respectively, how many pairs of chromosomes are required to contain the genes named?

138. If a *Drosophila* female *ttww* is mated with a male *Tw-tW*, what kinds of offspring should be produced and in what relative numbers?

139. If $(XY)(xy)$, in which 20 per cent of crossing over occurs, is mated with $(xy)(xy)$ and 600 offspring are produced, how many of these offspring should be $(XY)(xy)$? How many $(Xy)(xy)$? How many $(XY)(xY)$?

140. If $CcDd \times ccd$ yield offspring in the following numbers 28, 32, 94, 99, and if $FfGg \times fgg$ yield 62, 66, 12, 10, the genes *Cc* and *Dd* are how many times as far apart as are the genes *Ff* and *Gg*? (An answer to the nearest one decimal place is sufficient.)

141. (a) A certain tall spherical-fruited tomato plant that is heterozygous for dwarf stem and pear-shaped fruit is crossed with a dwarf pear-fruited plant and produces 81 tall spherical, 79 dwarf pear, 22 tall pear, and 17 dwarf spherical. (b) Another tall spherical plant crossed with a dwarf pear produces 21 tall pear, 18 dwarf spherical, 5 tall spherical, and 4 dwarf pear. Using parentheses or hyphens to indicate linkage, what is the genotype of the first plant in (a)? Of the first plant in (b)?

142. If crossing over between *R* and *S* is 15 per cent, that between *S* and *T* is 22 per cent, and that between *R* and *T* is 7 per cent, indicate the order of the genes and the distances between them in the chromosomes.

143. Why is a testercross preferable to F_2 for determining linkage?

144. If the linked genes *Pp* and *Cc* are far enough apart for crossing over to occur at two points between them, could this crossing over be detected in an experiment?

145. What genotype would be needed in an individual in order to ascertain whether any of its cells experienced double crossing over? Triple crossing over?

146. If in a linkage testercross one of the classes of offspring were, say, four times as abundant as its complementary class (having the other character of each of the pairs), what peculiarity of the time of crossing over might offer an explanation?

CHAPTER 15

PROOF THAT GENES ARE IN CHROMOSOMES

From the first description of the genetic mechanism in the early chapters and in all the explanations of breeding experiments, it was stated that the genes are in the chromosomes. It would have been difficult to offer proof of the correctness of this statement when it was first made, though the fact that so many events appear to have a reasonable and harmonious foundation if the genes are in the chromosomes should create a presumption in its favor. It is time now to assemble a few of the more pertinent facts which go to show that the mechanism of heredity has been correctly portrayed.

The Mendelian Mechanism.—Among the more general evidences that the chromosomes are the conveyers of the genes is the correspondence between the behavior of the genes and that of the chromosomes. Breeding experiments show as a logical necessity that whatever an organism receives from its two parents, with respect to a certain characteristic, it passes on *separately to different* individuals among its offspring. Calling the things it receives genes, no matter what or where they are, one must conclude from crosses of unlike parents that the genes contributed by the parents are separated—segregated, we say—in the germ cells of the next generation, so that each germ cell receives one of them, not both. F_2 generations and backcrosses would not be what they are without the segregation of the genes of a pair into different germ cells. Now, all this has an explanation if the genes are in the chromosomes, for the reduction division can then be the cause of segregation.

When two characters are studied simultaneously, it often happens that these characters prove to be independent of each other in their distribution to the offspring. The ratios of offspring in F_2 and other hybrid generations demand this independence. The ratios would be different if the genes were not independent. Here again there is a reasonable explanation of the logically deduced relation if the genes are in the chromosomes; for the different pairs of chromosomes are ordinarily free from any mutual interference.

Even when the two pairs of genes are not independent, as is true in

all instances of linkage, the chromosomes offer an excellent explanation if it be assumed that both pairs of genes are in the same pair of chromosomes, for the chromosomes provide the means of canceling independence.

No normal behavior of genes has yet been discovered from hybridization experiments that is not paralleled by normal behavior of chromosomes. This is a circumstantial indication that the two are connected.

Haploid and Diploid Organisms.—Any organism that is derived from two parents should have two homologous chromosomes of each kind. Likewise any organism with two parents should have two genes of each kind. It has been assumed that any two homologous genes are in two homologous chromosomes. If, now, any individual of such a species is haploid, whether as a normal phase of the cycle or as an accident, it should have only one gene of each kind—if the genes are in the chromosomes.

In the simple plants, or algae, the only diploid cells ever produced are the zygotes formed by the fusion of two cells in sexual reproduction. Such a zygote, by two divisions, produces four cells, which may be observed to be haploid. Reduction has occurred in one of the divisions, and many cytological observations go to show that it is the first of the two divisions in which the homologous chromosomes separate. Now, what happens to the genes in the course of these divisions? In one species of alga, two varieties having a different shape of eye spots were crossed, and the zygote was observed to have an eye spot of intermediate form. This shows that the zygote had two genes for eye shape, and neither was dominant over the other. When, however, the zygote had divided into the four characteristic vegetative cells, two of these cells had eye spots of one of the parental shapes, the remaining two of the other parental shape. None of these cells had intermediate eye spots. These facts show that each of the four cells had but one gene for eye shape, while the zygote had two genes. The diploid cell had two genes, haploid cells only one. This should be the situation if the genes are in the chromosomes.

The cycle of the mosses includes both a haploid and a diploid phase, which are represented by conspicuous structures. From a spore (Fig. 25, *a*) there is produced a group of cellular threads in the soil. From these threads, in turn, develops the moss plant, or gametophyte (Fig. 25, *b*). At the top of the gametophyte, eggs and spermatozoids (male cells) are formed. Everything so far described is haploid. There is no reduction in the number of chromosomes when the germ

cells are formed, for the gametophyte itself is already haploid. When fertilization of an egg by a spermatozoid takes place, the combined cell is diploid. From this fertilized egg develops the sporophyte (*c*), which remains attached to the top of the gametophyte. The sporophyte, like the fertilized egg from which it springs, is diploid. Then, within the capsule of the sporophyte, spores are formed. These are haploid. When, therefore, a cell in the sporophyte divides twice to form four spores, reduction of the chromosomes take place. With the haploid spores, the cycle may begin all over again.

What is the number of genes in these two generations of the moss cycle? Fortunately, there are enough variations in the mosses to answer this question. As for the diploid sporophyte generations, there are different colors, red, green, orange, etc. Each race, when grown by itself produces sporophytes of its own peculiar color. When, however, two of them are crossed, by controlled fertilization of the egg by a spermatozoid from another race, the sporophyte that develops from the egg is intermediate in color. This color is due to lack of dominance, and could occur only if two different genes were present. The diploid sporophyte therefore has two genes for color in each cell.

In the gametophyte, the shape of the leaves is different in different varieties. The genes for leaf shape go into the eggs and spermatozoids, and when two varieties are crossed, two different genes enter the sporophyte. In the sporophyte, which has no leaves, these genes cannot come to expression; but they go into the spores, from them to the cellular threads in the soil, and finally into the gametophytes where they can come to expression. Here, however, the leaves are not intermediate; in some individual gametophytes the leaves have one of the varietal shapes, in other individuals the other shape. That the leaves would be intermediate if both genes were together in a gametophyte is shown by regenerating a gametophyte from a heterozygous sporophyte; but this is a phase of the work that must be passed over with this brief reference. All this means that each gametophyte has only the one gene or the other, not both of them. It is thus shown that the haploid generation has only one gene for a character, not two as the diploid generation has.

Number of Linkage Groups.—It was shown in the preceding chapter that in no organism does the number of known groups of linked characters exceed the number of pairs of chromosomes. If the genes were not in the chromosomes, that is, if linkage were due to something else than the chromosomes, it would presumably be possible to have more linkage groups than there are chromosome pairs. This is negative

evidence, but important, since if the linkage groups exceeded the chromosomes in number, the genes could hardly be regarded as being in the chromosomes, or some peculiar chromosome behavior (fragmentation, perhaps) would have to be sought.

Sex-linked Genes.—In Chap. 8 it was shown that genes for sex-linked characters are possessed unequally by the two sexes. In man and the mammals generally, and in most insects, the female must have two genes for such characters, the male only one. In no other way can the peculiar type of inheritance of sex-linked characters be explained. The only anatomical feature in which the sexes can be observed to differ in precisely this way is the X chromosome; the female has two X chromosomes, the male only one. The assumption that the sex-linked genes are in this chromosome is almost necessary.

Closely related to sex-linkage is Y-chromosome inheritance. Some characters pass only from father to son. When these are known not to be secondary sex characters, because not all males have them, it is necessary to find some structure that passes only from father to son, if an explanation is to be had. The Y chromosome is the only known feature of mammals and most insects which is known to be transmitted in this way, and it is natural to suppose that the genes in question are in the Y.

Nondisjunction.—Sometimes a genetic experiment shows that a certain individual has only one gene of a given pair, although it has the expected two genes of other pairs. The absence of one gene is shown in a variety of ways. It may appear that a gene of that pair is going to only half of the offspring, after the manner of sex-linked genes in a male fly. Or a recessive gene may come to expression in a heterozygote, which could happen only if the dominant gene of the same pair, supposedly present, were absent or inactivated. These peculiarities are characteristic of the haplo-4 *Drosophila* described on page 83, and this particular fly lacks one of the small fourth chromosomes (Fig. 51). The obvious explanation is that the gene that is going into only half the offspring, or that is coming to expression in a supposed heterozygote, is in the one fourth chromosome which remains. Any instance of nondisjunction may bring forth similar modifications of inheritance.

Duplicate Genes.—By means of a 15:1 ratio in F_2 and confirmatory evidence from the F_3 generation, it has several times been shown that a species has four genes for a certain character, instead of the usual two. These two pairs are precisely alike and hence are known as duplicate genes. Examples are known in the shape of seed capsule in shepherd's-

purple (page 119), in the red pericarp color of rice, and others. In some such examples the species is known, from observation of its chromosomes, to be tetraploid. This merely means that it has twice as many chromosomes as does some other species which is regarded as diploid. It is believed that the tetraploid species was derived from the diploid by a duplication of the chromosomes, which is a not exactly rare way of producing new species in plants. If it may be assumed that the genes are in the chromosomes, the duplication explains not only the origin of a species but the existence of duplicate genes as well.

Chromosome Aberrations.—Occasionally in such a genetically well-known organism as *Drosophila* or corn, a gene is found to change its linkage relations. A character that has long been known to be a member of linkage group 2, for example, is suddenly found linked with group 3 instead. At the same time, some individuals may show unexpected peculiarities in the group 2 characters—a recessive character of group 2 may show in a heterozygote, or the amount of crossing over between genes in a certain part of group 2 may be greatly reduced, even to zero. In some of these instances, it has been possible, by examining the chromosomes of these irregular individuals, particularly those which have the second-group characters tied up with group 3, to observe that a piece of chromosome 2 has been broken off and attached somewhere to chromosome 3. A transfer of a fragment of a chromosome to some other *nonhomologous* chromosome is called a *translocation*. If it may be assumed that the genes which are behaving unusually are in the translocated fragment, all the peculiarities described above are explained.

There are other types of displacement of chromosome fragments that are paralleled by changes in the behavior of genes, but it is not desirable here to add to the complexity of evidence of this sort.

Salivary-gland Chromosomes.—With the discovery of the enormous chromosomes of the salivary glands in *Drosophila* (Fig. 19), translocations and other chromosome aberrations and deficiencies (vacant places left when a chromosome fragment has been removed) have assumed a new importance. Whenever a character shows any irregularity in its behavior, in any stock of flies, salivary glands from larvae of that stock may be examined with some hope of observing exactly what has happened. When genetic experiments show that certain genes are missing from linkage group 2, for example, salivary-gland chromosome 2 may be seen to lack certain of its disks. Many disks may be missing, though the experiment detected only the absence of one gene. Later another deficiency involving the same gene may

be found to accompany the absence of a certain other series of disks in the salivary-gland chromosome. The missing segments in these two examples overlap, however, and it is thus known that the gene which both experiments indicated was missing must be in the overlapping part. By subsequent similar tests with the same gene, the overlapping portions may be reduced to a very small amount. In this manner, it has often been possible to say that a certain gene is located in the region of two or three definite disks, sometimes even in only one of them.

These and other related phenomena seem to offer abundant confirmation of the view that the genes are in the chromosomes. There is among geneticists no difference of opinion on this question.

PROBLEMS

147. In what ways might *Drosophila* come to have more than four linkage groups?

148. In discovering breakages of chromosomes that harmonize with peculiarities of gene behavior, which is likely to be discovered first, the chromosome aberration or the genetic peculiarity?

149. What advantage do the mosses have over animals in demonstrating that diploidy goes with two genes of each kind, haploidy with one gene?

150. If a piece of a moss sporophyte is caused to regenerate, producing a gametophyte, what kind of genetic information would be obtained that could not be discovered from the normal moss cycle?

151. Male honeybees are haploid, the females diploid. Can you devise a way of proving whether the male has only one gene, the female two, of each kind?

CHAPTER 16

NATURE AND ACTION OF GENES

The architecture of the germ plasm is pretty well known. The structure of chromosomes, the arrangement of genes in them, the function of the reduction division in effecting segregation of genes, the importance of crossing over in the recombination of genes, the reorganization of chromosomes through fragmentation and redistribution of the pieces—all these have been subjects of exhaustive study for many years.

Progress is now being made in solving the even more important problem of how the genes work. What are the physiological steps between gene and character? How is development controlled by genes so that the end product is so regularly the same wherever a given genotype is present? The gene must initiate a chain of events to which other genes contribute, in conformity with basic principles of chemistry and physics. The nature of each gene itself determines what part it shall play in this cooperative action.

Nature of the Gene.—One's conception of the fundamental nature of the gene depends on the definition of the term gene. Two practices have arisen with respect to this definition, in one of which the genetic material is regarded as only a small part of the chromosomes, while in the other it may be most of the chromosomes. In keeping with the former idea, the gene has frequently been thought of as a single molecule. The suddenness and sharply defined differences of mutations have favored the idea that each gene is a single molecule, rather than a group of molecules. Under the second concept, the gene is greater than a molecule, possibly even a visible segment of the chromatin thread. It is impossible to distinguish between these possibilities in specific instances. The criteria of a gene are that it shall be self-reproducing, that it shall behave as a unit, that it may be separated from any other such units, and that it is not broken up by crossing over or by chromosome fragmentation. None of these requirements provides means of determining the nature of any particular gene.

Originally genes must have been very simple. Numerous biologists have likened genes to viruses, those minute chemical entities

which are best known in relation to disease. Known viruses exist only in living organisms—as do genes. Both viruses and genes reproduce themselves with precision; both of them mutate. The suggestion is that genes were once as independent as viruses are and that they were capable of being moved about from one situation to another as viruses are now. How genes came to be permanently associated with organisms, as part of them, is a portion of the problem of the origin of life, with which this book does not deal. If the genes were comparable to viruses, they must have been very simple—probably single molecules. Perhaps many of them are still as simple as that. If grosser forms of genes exist now, as many geneticists believe, they presumably arose in relation to the gradual evolution of chromosomes. Some of them may even owe their existence to the breakage of chromosomes. Some of these grosser genes may be visible in the giant salivary-gland chromosomes of flies, but it is not yet possible to point out any specific gene that is visible.

Reproduction of a gene, if it is a single molecule, may be merely a process of rapid growth involving a copy mechanism of some sort. Or it may involve the formation of a mold. The surface contour of a molecule is as characteristic of it as the number of atoms of different elements that enter into its composition. Some geneticists have supposed that this contour is impressed on some other substance serving as a matrix, thus producing a mold, into which material of the same sort as the gene is “poured,” producing a cast which would be identical in contour with the impressing gene. This suggestion is highly speculative, and there must be more to the process than has been proposed; but any mystery in it need be nothing more than our ignorance.

The material making up the genes is presumably protein. Chromatin threads mechanically isolated assay almost pure nucleoprotein. Such substances have the complexity of structure that the highly variable life processes require. Furthermore, they possess the feature of specificity to a high degree; that is, each substance enters into certain reactions with great precision and uniformity, and into other reactions not at all. Each of them is also capable of certain well-defined molecular alterations, which tend to persist about as tenaciously as did the “original” structure. These features are so strikingly the characteristics of genes that it is generally assumed that the heredity units are nucleoproteins.

Mutation of Genes.—When genes are molecules of some substance, mutation is presumably a change in structure—substitution, removal, shifting, or addition of side chains or radicals. Genes that are of

grosser nature, such as minute segments of the chromatin thread, probably change in a cruder way, possibly even by mechanical breakage. It is difficult, however, to distinguish between mutation and "position effect" when chromosomes are broken. It has been demonstrated many times that a gene, occupying a certain spot in the chromosomes and having a given phenotypic effect, has a different effect if moved to another spot. Hairy wing and bar eye in *Drosophila*, for example, are each caused by duplication of a small segment of the X chromosome, one segment immediately adjoining another segment identical with it (see Fig. 54 for bar-eye arrangement). In crossing over, it occasionally happens that the two chromosomes break at slightly different levels, so that both hairy-wing genes, or both bar-eye genes, get into the one chromosome, while the other chromosome of the pair lacks the gene altogether. Flies having the two genes in one chromosome have an exaggerated hairy wing, or exaggerated bar eye. The two genes in one chromosome have a greater effect on development than do the same two genes in different chromosomes. Similar or greater position effects have been found when the genes are transferred greater distances, perhaps to nonhomologous chromosomes as in translocation. Consequently, when organisms are phenotypically different because of chromosome breakages, it is not certain that any gene has changed. It may merely be at a different place. Whether such modifications should be called mutations is debatable; the practice of geneticists has varied.

Of the agents that artificially produce mutations, radiation is the most effective. High-energy radiation, such as X rays (which cause ionization) and fast neutrons (which may not ionize) commonly break the chromosomes in radical fashion, the neutrons being about half as effective as X rays in some organisms where they have been compared, equally effective in others. Ultraviolet, without ionization, has produced very minute chromosome breakages (deletions or deficiencies) or changed the gene structure without breaking the chromosomes. The breakage or mutation need not, perhaps never does, occur immediately. The radiation appears to create some sort of tension that causes the break to occur later. The most effective wave lengths of both X rays and ultraviolet have been determined for certain organisms, and that for ultraviolet corresponds closely with a strong absorption band of nucleic acids in the spectrum. This tends to confirm the conclusion that the genes are nucleoproteins.

Cosmic rays are also held to produce mutations, because *Drosophila* exposed for 25 to 40 days at an elevation of 14,000 feet, where frequency

of cosmic rays is 15 times as great as at the earth's surface, yielded three times as many mutations as in laboratories. Where the cosmic rays were only three to five times as frequent, the mutation rate was increased by one-third to one-half.

Mutations are also caused by certain genes. In corn, the gene *a* for colorless aleurone is made to mutate freely to *A* (colored aleurone) if the dominant gene *Dt* is present. Also in a species of *Drosophila*, visible mutations arise much more frequently in the X chromosome if a certain gene is present in the second chromosome. The sex-linked mutations are about 35 times as frequent as in the wild type if the causative gene is present in only one of the second chromosomes, 70 times as frequent if it is in both of them. Other stocks of *Drosophila* have been found to be exceptionally mutable because of certain genes they possess. Presumably also an effect of genes is the greater rate of mutation in hybrids of two *Drosophila* species; the sex-linked lethal mutations were found in 8 per cent of the hybrids, as compared with almost no such mutations in nonhybrid flies. The possibilities of gene-controlled evolution opened up by these discoveries are very important.

Mustard gas has proved to be very effective in breaking chromosomes in *Drosophila*. Other chemical substances (ammonia and acetic acid) applied to larvae or adults have increased mutation modestly in *Drosophila*; antibodies (in sera) have produced a similar effect in the mold *Neurospora*; zinc nitrate caused mutation in another mold; and raising *Drosophila* on food treated with uranylacetate made X rays almost twice as effective in producing mutations. Crowding (perhaps by causing starvation) increased mutation in the plant *Lycopersicum*, and aging of seeds (7 to 10 years) raised the mutation rate in wheat. How these agents work is not known.

Action of Genes in *Neurospora*.—The influence of a gene on the characteristics of an organism appears to be exerted through the production of a specific substance. Each gene is probably responsible for a given product. This activity has been beautifully shown for the tropical bread mold *Neurospora* by Beadle, Tatum, and others following basic studies by Dodge and Lindegren. This mold reproduces asexually, so that large quantities of any strain can be reared for tests. It also reproduces sexually, through the fusion of certain cells of physiologically unlike (positive and negative, male and female) strains. The hyphae of these strains are haploid; hence, they contain only one gene of each kind. When the cells fuse, the zygote produced is diploid, having two genes of each general kind. When this zygote divides

(three times, to produce eight spores, Fig. 82), reduction occurs, the spores are haploid, and each contains again only one gene of each kind. If the zygote is heterozygous, four of the spores produced from it are of one kind, four of the other. From each spore a vegetative mass may be raised, in whatever quantity is needed for testing it.

Ordinary "wild-type" *Neurospora* grows well on a simple medium, which includes a source of energy and carbon, nitrates or ammonium salts for nitrogen, certain inorganic salts and elements, and biotin, one of the B vitamins. *Neurospora* makes everything it requires from these raw materials.

Now, if the mold is exposed to X rays of certain dosage, mutations may be produced in a small number of cells (one in several hundred, perhaps). If the mutation is one that destroys the ability to synthe-

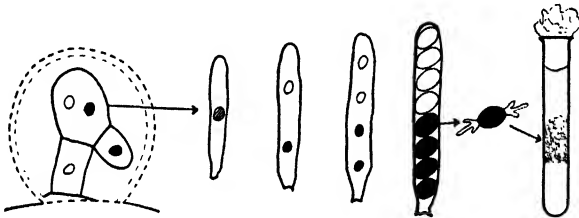

FIG. 82.—Sexual reproduction in *Neurospora*, showing fusion of two unlike cells, divisions of the zygote into eight spores, and vegetative development of one of the spores into hyphae in a test tube. The black-and-white nuclei and spores represent segregation of the "sexes" or of genes in a heterozygote. (Modified from Beadle.)

size some vital product from the materials in the medium, the mutant mold will not grow on that medium. To save many of the possible mutants, the X-rayed products are raised first on a medium that is fortified by the addition of numerous amino acids and vitamins. Any mutant is preserved if the substance it cannot now synthesize is included among the things added. Any strain which grows on the fortified medium, but not on the standard medium, is then tested on a medium to which only a number of vitamins are added, and on a medium to which only a group of amino acids are added. If it fails on the vitaminless medium, it is then tested on media to which single vitamins have been added. If it grows on a medium to which pyridoxin has been added (Fig. 83), but not on any of the others, one infers that the mutation destroyed the capacity of the mold to synthesize pyridoxin.

While such a change has here been called a mutation, it could conceivably be some physiological change other than a genetic one. To test this possibility, the "mutated" mold is then crossed with a normal kind, and the eight spores produced (Fig. 82) are tested to ascertain

their requirements. If four of them require addition of pyridoxin, while the other four grow on the usual basic medium, it is inferred that the defect results from change of a gene—that is, that it is really a mutation.

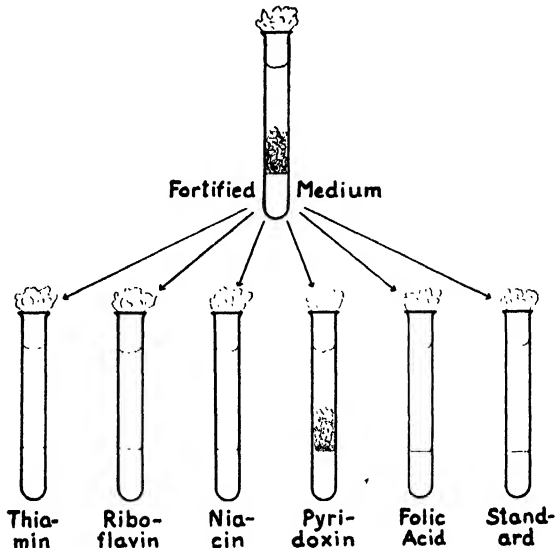

FIG. 83.—Testing a mutant strain which requires an added vitamin in the medium, to determine which vitamin it cannot synthesize—pyridoxin in this example. (Modified from Beadle.)

In such experiments mutations have been produced which destroy the capacity to synthesize most of the vitamins of the B complex, a number of amino acids, and the purine and pyrimidine components of nucleic acid. Each mutation affects just one of these syntheses. The importance of such syntheses to the general physiology of living things lies in part in the fact that the proteins of protoplasm are made up of amino acids. An example of this process as far as it involves the amino acid tryptophane and the known genes of *Neurospora* is illustrated in Fig. 84. One gene in the mold synthesizes anthranilic acid, another gene converts this to indole, and this in conjunction with serine produces tryptophane. These steps, or substitutes for them, are necessary in the synthesis of any of the many proteins that include tryptophane.

Gene Activity in Other Organisms.—Some of the earliest known simple recessive characters in man must be caused by the failure of some particular synthesis. Albinism is an example. Human food

necessarily contains the amino acid phenylalanine, which the body can oxidize to produce another essential amino acid tyrosine. The latter in turn is oxidized to 3,4-dihydroxyphenylalanine—whose name, fortunately, is important only to professional biologists and biochemists,

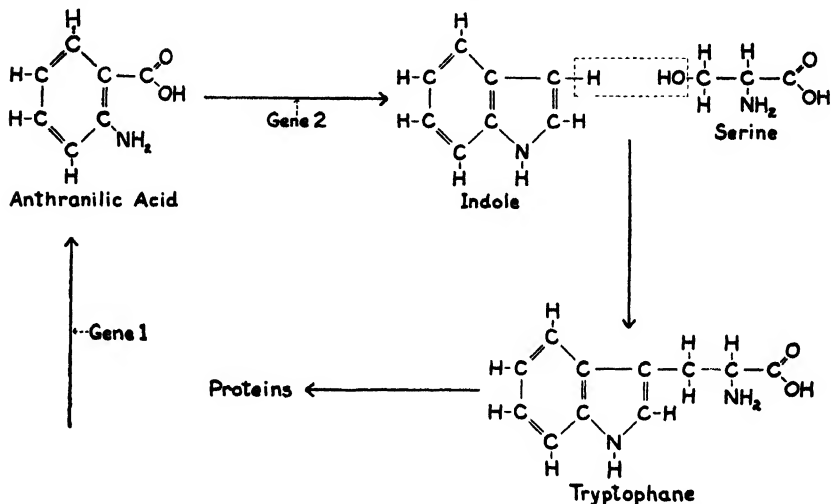

FIG. 84. —Synthesis of tryptophan in *Neurospora*. Known genes control the changes at two of the steps. (After Beadle in *American Scientist*.)

and by the former is abbreviated to “dopa.” In normal men and women, dopa is converted to the pigment melanin, which colors the hair, skin, and eyes. What chemical change occurs in this transformation is not known, for the formula of melanin has not been discovered; but by analogy it must be brought about by a gene. That gene, for mammals in general, is called *A* (or *a*⁺). Now, in some people this gene is in the mutated form *a*, which is unable to transform dopa to melanin. These people are albinos; their skin is florid and eyes pink because the color of the blood in them is not concealed, and their hair is whitish or straw-colored from the lack of pigment.

Another long-known physiological hereditary defect in man is alcaptonuria, in which the urine contains homogentisic acid, and turns dark on exposure to air. The phenylalanine mentioned above can be converted to phenylpyruvic acid, and both this and tyrosine are convertible into parahydroxyphenylpyruvic acid (again names are unimportant except to physiologists and chemists). The latter substance is broken down by a series of steps in which homogentisic acid is one of the products. Normal people continue this degradation by con-

verting the acid finally to carbon dioxide and water. But alcaptonurics lack the gene (they have a recessive ineffective mutant of it) that controls the destruction; so the homogentisic acid remains unaltered and must be excreted.

In *Drosophila*, one of the substances involved in production of red eye color is kynurenine, a derivative of tryptophane. When the sex-linked gene *V* (or *v*⁺) mutates to *v*, kynurenine is not produced, and the eye color is vermilion. A derivative of kynurenine is necessary to prevent the eye color from being cinnabar, and mutation of a certain gene has resulted in this color. There is evidence that the effect of the gene *v*⁺ in *Drosophila* is identical with that produced by gene *a*⁺ in the moth *Ephestia*, and here too eye color (along with some other things) is affected. Gene *a*⁺ converts tryptophane into kynurenine, and moths with the genotype *aa* contain more tryptophane because it is not oxidized. It is not surprising to find the same substances produced in unrelated organisms, for there are only about two dozen amino acids, and the derivatives of these are limited by their molecular structure. A given substance would have different effects in unlike animals, however, because of the dissimilar substrate on which it has to work.

Genes in *Drosophila* also influence the amount of oxygen consumed by certain developing structures in the larvae, according to Villet (1946). The wing disks (small masses of cells in the larva which develop into wings in the adult) consume a little less oxygen if the larva contains the genes for miniature wings, and much less oxygen if the genes for vestigial wings are present. The consumption of oxygen by the leg disks in these same larvae is not lowered, even though the legs contain the miniature-wing or vestigial-wing genes. The respiration effect of the genes is manifested only in the organs which those genes will modify.

Genes Acting Independently in Heterozygotes.—In the above examples one gene produces a substance, while its allele simply does not produce it. The contrast is essentially one of presence or absence of a certain reaction. There are some pairs of genes, however, in which each gene produces a substance. The blood groups of man and the apes are determined by several genes that are responsible for the agglutinogens in the red cells of the blood. One gene (*A*) produces agglutinogen A, another gene (*A*^B) at the same locus in homologous chromosomes produces agglutinogen B. Besides these there is a third gene (*a*) in this multiple allelic series that does not produce any agglutinogen. Genes *A* and *A*^B are dominant over *a*, so that heterozygotes having the genotype *Aa* have agglutinogen A, and those with

the genotype $A^B a$ have agglutinin B. These relations are of the presence-and-absence type, like those described in the preceding section. Heterozygotes with the genotype AA^B , however, produce both agglutinogens A and B. These substances are not mutually exclusive, both can exist in the same red cell, and both are produced.

There is in man another locus that controls agglutinogens in the red cells, but in this case there are only two alleles. One produces agglutinin M, the other N. In heterozygotes both M and N are present, showing that the two genes have each a positive action which is independent of the other gene.

Separate action of the two genes of a pair is also found in the so-called mating types of certain protozoa. In *Euplotes* there are three alleles (mt^1 , mt^2 , mt^3), which can enter into individuals, two at a time, in six different genotypes. Three of these are homozygotes, three heterozygotes. In the heterozygotes, each gene produces its characteristic substance, so that the protozoon has two of them. These substances are so related that one protozoon can conjugate with another which does not possess the same substance.

What appears to be similar independent action of two genes of a pair is concerned with the determination of sex in the wasp *Habrobracon*. Like those of the honeybee, the eggs of this wasp may develop without fertilization, producing haploid males. Unlike the bee, however, the fertilized eggs may yield either females or males, all diploid. At least nine members of a multiple allelic series of sex genes have been discovered by Whiting; they may be called x^a , x^b , x^c , etc. A haploid individual can have only one of these genes, which produces only its characteristic substance, and a male results. A diploid individual that is homozygous for one of the alleles likewise produces only the one substance, and is also a male. But a diploid that is heterozygous for two different alleles produces both of their substances, and a female results. Again there is separate action of the two genes, each acting independently of the other.

PROBLEMS

152. What are the grounds for likening the genes to viruses?
153. What reason is there to regard viruses as living?
154. Why would the suddenness of mutation suggest that genes are single molecules?
155. What is the criterion by which the changes in *Neurospora* are judged to be mutations?
156. What chemical knowledge is necessary before one can say what particular synthesis is controlled by the gene (a^+) for pigment in man?
157. What mutant genes are known to produce, not simply nothing, but a different substance from that produced by the "original" gene?

CHAPTER 17

NON-MENDELIAN INHERITANCE

The evidence that the genes are in the chromosomes completely identifies these nuclear bodies with the mechanism of Mendelian heredity. There is, however, a group of phenomena that do not follow the Mendelian rules. Before we turn to these nonconformist phenomena, the rules which they violate must be clearly in mind. What is Mendelian heredity?

Mendelian Heredity Defined.—Mendel's laws, as derived from his own experiments, involved (1) segregation of the genes of the same pair and (2) independent assortment of genes of different pairs. Since Mendel's time, it has been found that the second of these, independent assortment, is not universal. Linkage has been found to be exceedingly common. Mendel never observed linkage; should linkage then be excluded from Mendelian heredity? Considering that linkage is produced by the very things (chromosomes) which are responsible for independent assortment, geneticists chose not to separate linkage from the other fundamental features of heredity and have extended the term Mendelian heredity to cover it.

Once this extension was accepted, it was logical to include the other things that are dependent on the regular behavior of chromosomes, such as sex-linked inheritance. And finally, even those phenomena which result from irregularities of chromosome conduct—nondisjunction, translocation, duplication, deficiency—were regarded as Mendelian phenomena. At the present time, any transmission that is directly dependent on chromosomes is considered Mendelian heredity.

The inheritance that may be said to disregard Mendelian rules must therefore depend on something else than chromosomes. Most of the phenomena of this exceptional sort relate to inequality of the influence of male and female parents. Some of these inequalities are permanent; others gradually decrease and disappear.

Variation in Plants.—One of the permanent inequalities between the two parents is their relation to variegation in plants. Green plants owe their color to chlorophyll-bearing bodies, the *plastids*, in their cells (Fig. 4). So long as the plastids are normal healthy organs, the green

color is maintained. Sometimes, however, they are deficient in their power to produce chlorophyll; such plastids become pale green, or yellow, or white. If the deficiency extends throughout the plant, it is fatal, because nutrition depends on the photosynthesis for which normal chlorophyll is a prerequisite. Only young plants, therefore, which are still drawing nourishment from the seed, can afford to be white. Older plants may, however, be yellow or white in spots, a condition known as variegation.

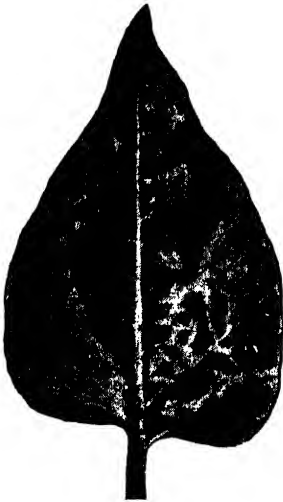

FIG. 85.



FIG. 86.

FIG. 85.—Variegated leaf of the four-o'clock *Mirabilis jalapa*. (After Correns.)
 FIG. 86.—Variegated corn; stripes of pale green in otherwise green leaves. This variegation is transmitted only by the mother. (Photograph by E. G. Anderson.)

When a variegated four-o'clock (*Mirabilis jalapa*, Fig. 85) is crossed with a solid green one, the offspring are always like the mother. If the female parent was variegated, the offspring are variegated; if the mother was solid green, the offspring are green. On a variegated plant, some branches may be solid green, some solid white, some variegated. When a flower on a green branch and one on a white branch are cross-pollinated, the offspring are again like the mother, whichever way the cross was made.

Corn also has its varieties with pale green stripes among the dark green of the leaves (Fig. 86). The variety illustrated arose suddenly in a single plant among more than a hundred in one family. This one plant was raised, and produced one ear. The grains on this ear were

planted the next year in rows in a plat, in the order in which they were placed on the cob. Though the majority of the plants growing from these seeds were green, one large area of the original ear yielded pale plants (Fig. 87), which soon died. Along the margins of this white area, the grains produced many variegated plants. From these originated a variety that continued to produce striped plants. Any crosses between striped and green plants yielded only striped or only green, to agree with the mother.



FIG. 87.—Plat of corn seedlings from striped parent. The seeds were planted in the same relative positions as they occupied in the ear. The plat shows that seeds from one considerable area on the ear produced mostly pale green plants. Along the border of this area the seeds produced many striped plants. (From Anderson in *Botanical Gazette*.)

Similar inheritance only from the mother is found in Chinese plantain lilies, in a pale green variety of barley, and in a tricolored barley.

In every example the explanation is that the plastids are carried over from generation to generation only in the egg. Recognizable plastids are not to be seen in either egg or pollen, but some representative of these structures must be present in the egg. Even if similar representatives were in the pollen, they might never be transmitted to the offspring, for what reaches the egg from the pollen tube in fertilization (Figs. 13 and 24) is practically only a male generative nucleus.

If the plastids reside in the cytoplasm (protoplasm outside the nucleus) of the egg, and not in the pollen or are ineffective in the pollen, the strictly uniparental transmission of variegation is explained.

Breast Cancer in Mice.—What appeared for a time to be cytoplasmic heredity is the maternal transmission of susceptibility to breast cancer in mice. Strains of mice differ in their liability to this disease. In a "high" line as many as 85 or even 100 per cent of the individuals develop the tumors, though any line exhibiting 50 per cent incidence is regarded as high. In "low" lines, few individuals (down to 0.1 per cent) are susceptible. Crossing a high female with a low male yielded 39 per cent cancerous offspring, while in the reciprocal cross (low female by high male) only 6 per cent of the offspring developed breast cancer. It turned out later that the cancer came from something in the milk of the nursing female. Unrelated mice feeding on her milk acquired the causative agent. Care needs to be exercised to rule out such environmental agents in every apparent instance of maternal heredity.

Cytoplasmic Influence under Control of Genes.—Some maternal influences, exerted through the cytoplasm of the cells of the female, are

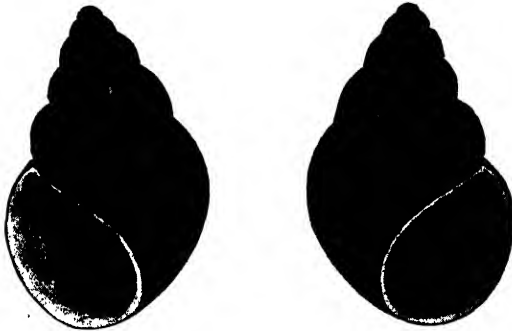

FIG. 88.—Sinistral (left) and dextral shells of snail. The direction of the coiling appears to be determined by the hereditary nature, not of the snail itself but of its mother.

nevertheless controlled by genes. An example is the inheritance of direction of coiling in snail shells. In some species the shell always coils to the right (dextral), in other species always to the left (sinistral). In a few kinds both dextral and sinistral individuals are found (Fig. 88), and in one of these it has been shown that dextral coiling is dominant over sinistral.

The direction of coiling, however, is not determined by the genes of the snail itself, but by those of its mother. If the gene for sinistral

coiling is symbolized by l and that for dextral by L , any female whose genotype is LL or Ll will produce only dextral offspring. Even if she is mated with a male that is Ll or ll , and some of their offspring are ll , yet these homozygous recessives will show the dominant character because their mother carried the dominant gene L .

The reason for this peculiarity is that the cytoplasm of the eggs has had impressed on it, before the reduction division, the influence that governs direction of coiling. Any female carrying L will produce only eggs that have experienced this influence, even if some of them have the gene l after maturation. Any ll offspring, though themselves dextral, will produce in their turn only sinistral offspring, however, for the cytoplasm of *their* eggs grows under the guidance of the sinistral gene.

How plausible this maternal influence is will be understood from the fact that direction of coiling in a snail is determined by the position which the spindles of the dividing cells take in the early cleavages of the egg. The cytoplasm governs this position, hence controls direction of coiling.

Cytoplasmic influence is likewise shown in the eye color of the meal moth *Ephestia*, though it is transitory and partial. When a heterozygous female (Aa) is mated with a recessive male (aa), some of the offspring are of course homozygous recessives (aa). These larvae show the dominant eye color at first (a cytoplasmic holdover from the mother) but become intermediate later.

Diminution of Cytoplasmic Effect in Subsequent Generations.—The disappearance of the cytoplasmic effect is more leisurely in some organisms and requires several generations. In beans, different varieties have very unequal resistance to the mosaic disease, which is caused by a virus. Both Michigan Robust and Corbett Refugee are resistant varieties. When they are crossed with susceptible kinds, the F_1 plants resemble the mother much more than the father. If Michigan Robust is pollinated from a susceptible plant, the F_1 generation is resistant, though somewhat less so than Robust itself. If a susceptible variety is pollinated from either Robust or Refugee, the F_1 plants are susceptible. The resistance shown by F_1 from the former cross is continued, but diminished, in F_2 ; and there is still some extra resistance in F_3 . Under the influence of genes that should make these later generations intermediate, the cytoplasm thus gradually loses its high resistance.

PROBLEMS

158. What feature of crosses indicates that a character is transmitted only through the mother?

159. How can coiling of snail shells be inherited "maternally" even though it is controlled by genes?

160. What is the explanation of apparent maternal inheritance in mammals?

161. If a flower on a variegated branch of a four-o'clock is pollinated from a flower on a green branch of the same plant, what will be the nature of the plants produced from the eggs thus fertilized?

162. What evidence would be needed to show that plastids are carried by pollen cells as well as by eggs in any kind of plant?

163. The eggs of silkworm moths may be either oval (*O*) or spindle-shaped (*o*); *OO* and *Oo* females lay oval eggs, *oo* females spindle-shaped eggs. An *Oo* or *oo* fertilized egg may be either oval (if the female that laid it is *Oo*) or spindle-shaped (if the laying female is *oo*). How must one assume egg shape is determined? What do the facts show regarding the action of the genes?

164. If an *OO* female is crossed with an *oo* male (see preceding problem) and the F_1 moths are mated together, from what shape or shapes of eggs will the F_2 moths hatch? What kinds of eggs will the F_2 moths lay?

CHAPTER 18

DETERMINATION AND DEVELOPMENT OF SEX

The dependence of sex on chromosomes was pointed out in Chap. 8 in explanation of sex-linked characters and again in Chap. 15 as proof that the genes are in the chromosomes. In the mammals, most insects, and some fishes there are two X chromosomes in the female and only one in the male. Along with the one X of the male there may or may not be a Y chromosome. In the moths, birds, some fishes, and the caddis flies, the chromosome relation to sex is reversed. The male has two similar chromosomes related to sex (here called Z chromosomes), while the female has only one. Along with the one Z of the female there may or may not be a W chromosome. As previously indicated, the X and Y, Z and W chromosomes are known as heterosomes.

Heterosomes in Maturation and Fertilization.—The manipulation of these chromosomes in maturation is illustrated for an XO species—one lacking a Y chromosome—in Fig. 89, which shows the male cells of the bug *Protenor*. The male has 13 chromosomes, made up of 12 autosomes and one X chromosome. At the left of the figure is the reduction division, with the single X going to the lower pole. At the completion of this division the two daughter cells, shown in the middle of the figure, are unlike in their chromosomes; the one at the top has 6 autosomes, the lower one 6 autosomes plus an X chromosome. The final spermatozoa are likewise of these same two kinds. The eggs of the female of this species all have 6 autosomes plus an X, like the lower male cell. When these eggs are fertilized by the two kinds of spermatozoa, there result the two different combinations shown at the right in Fig. 89. One combination consists of 12 autosomes and one X (above), and this kind develops into males. The other combination (below) has 12 autosomes and two X chromosomes, and this kind develops into females. The spermatozoa are thus the sex-determining agents, the X-bearing type being female-determining, the one without an X (whether with a Y or not) being male-determining.

In the moths, birds, and other groups having the Z or Z and W chromosomes, it is the female that produces two kinds of germ cells. Some of her eggs contain a Z chromosome; others do not. All sper-

matozoa are alike in containing a Z. Here the eggs are sex-determining. An egg with a Z chromosome is male-determining, one without a Z (whether with a W or not) is female-determining.

Y chromosomes when present pass down the male line exclusively, in normal reproduction, but Y is not male-determining. The presence of but one X is what makes the individual male. W chromosomes are transmitted only in the female line but are not female-determining. It is the presence of but one Z that makes the individual a female. Both X and Z chromosomes act in relation to other chromosomes, or in relation to the cytoplasm, as is pointed out later.

Sex and Chromosomes in Plants.—

The problem of sex determination in plants is somewhat different also, because of the separation of gametophyte and sporophyte generations, described for the mosses on page 41. In the flowering plants the gametophyte is reduced to a structure composed of three to eight cells; the male gametophyte is the pollen grain and is formed in an anther; the female gametophyte is the embryo sac (pages 23 and 40) and is lodged in a carpel. It is the gametophytes that

really possess sex. If a sporophyte generation, which is the conspicuous member of the cycle in flowering plants, allows only one kind of gametophyte to develop within it, these sporophytes are then more or less properly designated as male or female.

Sex chromosomes were first discovered in plants by Allen, studying a liverwort. Male gametophytes of this liverwort were found to contain 7 autosomes and a Y chromosome, female gametophytes 7 autosomes and an X chromosome. The sperm and eggs produced by these gametophytes experienced no further reduction, just as in mosses, and were of the same chromosomal constitution as the respective gametophytes. The fertilized egg thus contained 14 autosomes and an X and a Y. The sporophyte developing from the fertilized egg was likewise $14A + X + Y$ and was, of course, sexless.

In flowering plants also a number of species with distinguishable chromosomes associated with sex have been found. Mostly it is the male which is heterozygous (XY), but in certain strawberries it is likely

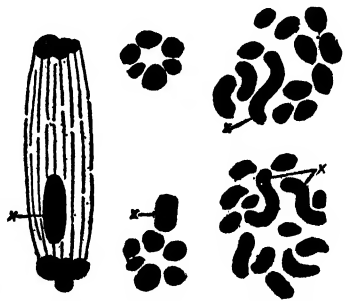

FIG. 89.—Chromosomes of an XO male, the bug *Protenor*. Reduction division at left, resulting cells in middle. At right, diploid condition restored by union of the two kinds of spermatozoa with the one kind ($6 + X$) of egg. *x*, the X chromosome. (Modified from Wilson.)

that the female is the heterozygous sex (like ZW in birds). No instance of XO, or the absence of a Y chromosome in the male, has yet been discovered.

Sex Genes.—Since chromosomes house the genes for inherited characters in general, the question promptly arose whether the X and Z chromosomes as a whole are responsible for sex, or whether one or more genes for sex are located in them. The most fruitful source of information on which an answer to this question could be based has been the production of translocations (page 149) and deficiencies (page 85) in *Drosophila*. Such breakages can be induced by X rays; hence, abundant material for study is available. By using flies in whose X chromosomes there are mutant genes scattered along the map, to serve as markers, the location and extent of the aberrations can be roughly ascertained by breeding. The effect of aberrations at different places on the sex characters of the flies was at the same time observed. The general conclusion from such studies is that there are numerous X-chromosome sex genes and that they are distributed along much of the length of the chromosome. It is not necessary, however, that all of the genes (that is, the whole chromosome) be present to bring about normal development of sex.

Genic Balance and Sex.—That sex genes are located also in the autosomes is proved by the work of Bridges on intersexes and "supersexes" in *Drosophila*. These modifications of the typical sexes are characterized by various degrees of development, not only of the ovaries or testes, but of other distinguishing marks of sex—the external genitalia, black bands on the abdomen, sex combs on the front tarsi of the males. Through nondisjunction, flies (or patches of their bodies) were obtained that had irregular numbers of chromosomes of the several pairs, and sex was found to be dependent on the ratio of the X chromosomes to the autosomes. A typical female has two X chromosomes and two sets of autosomes; she may be formulated as being 2X:2A. A male, by the same characterization, is 1X:2A. Among the flies with unusual chromosome numbers, those in which the ratio of X to A was 1:1 (as in 3X:3A, 4X:4A, 1X:1A) were all females. When the ratio of X to A was between 1:1 and 1:2 (as in 2X:3A), the fly was an intersex (intermediate between the sexes). If the ratio was more than 1:1 (3X:2A) an exaggerated female (superfemale) was produced, while a ratio less than 1:2 (1X:3A) yielded a supermale.

While the autosomes tended to behave as a group in nondisjunction, the small spherical fourth chromosome sometimes broke away. When this happened, it was found that chromosome 4 assisted the X chromo-

some in favoring femaleness, while chromosomes 2 and 3 favored maleness. It was a balance of these two groups against each other that determined sex. It seems reasonable to suspect, then, that sex may be dependent on genes in many chromosomes in animals in general.

Also dependent on a balance, but not wholly a genic balance, is the sex of the gypsy moth, as conceived by Goldschmidt. He regards the male-determining genes as residing in the Z chromosomes, while the female-determining influence is in the cytoplasm of the egg. A



FIG. 90.—Bilateral gynandromorph of silkworm moth larva. (From Goldschmidt and Katsuki in *Biologisches Zentralblatt*. Verlag Georg Thieme, Leipzig.)

balance between these two determines the sex. Two Z's are enough to override the cytoplasm, and a male is produced. A single Z, however, is dominated by the cytoplasm, and a female results.

Gynandromorphs.—Sometimes, through irregularities of cell division, maturation, or fertilization, animals are produced that have one chromosome combination in one or several parts of the body and another combination in other parts. When these chromosome combinations are sex-determining ones, patches of genetically female tissue may be interspersed among areas that are genetically male. In insects these adjoining areas are able to develop in accordance with their contained genes, and a sex patchwork results. Such mosaic individuals are called *gynandromorphs*. An example is shown in Fig. 90, cater-

pillars of the silkworm moth that are male on one side, female on the other.

Several possible means of producing gynandromorphs exist. One is through nondisjunction of the X chromosome in the first cleavage of the egg. A gynandromorph of *Drosophila* was proved, by mutant genes in the X chromosomes, to be of this kind. At the first cleavage, one of the X chromosomes was lost (did not enter either daughter cell, Fig. 91), so that only one X remained on the left side, while there were two X's on the right. The resulting fly was male on the left side, female on the right.

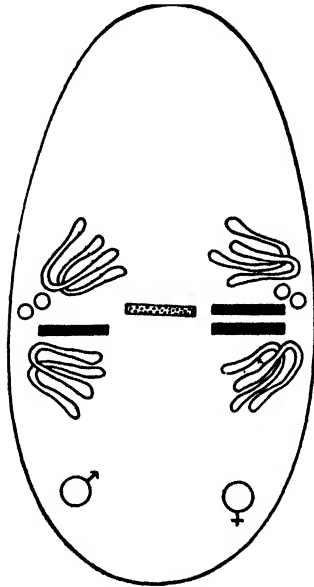

FIG. 91.

FIG. 91.—Production of a gynandromorph by nondisjunction of one X chromosome in first cleavage of *Drosophila*. Left side becomes male, right female. X chromosomes are black, except the lost one, which is dotted. (After Stern.)

Another way of producing gynandromorphs is by means of eggs with two nuclei. Such eggs have been discovered in cytological studies. The two nuclei

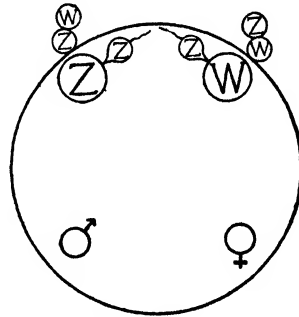

FIG. 92.

FIG. 92.—Maturation of a binucleate egg of a ZW species. Small cells at sides above are polar bodies. The Z chromosome remains in one egg nucleus, the W in the other, after reduction. A gynandromorph, male on the left, female on the right, could develop from it.

were supposedly present before maturation began, and each is conceived to have gone through the maturation process independently of the other. If this binucleate condition occurs in moths, where the constitution of the female is ZW, one of these nuclei may eliminate its Z chromosome into the polar body, while the other eliminates its W chromosome (Fig. 92). The haploid nuclei are therefore one W and the other Z. If they are both fertilized (necessarily with a Z spermatozoon), one should develop female tissue, the other male.

The moth larvae in Fig. 90 could have come from binucleate eggs if one combination nucleus went to the left side, the other to the right.

Sex in the Honeybee.—In the honeybee, the eggs may either be fertilized or they may develop parthenogenetically. The fertilized eggs produce females (queens or workers, depending on how they are fed in the larval stages), while unfertilized eggs yield males (drones). The males are thus haploid, the females diploid.

How sex is related to chromosomes in the honeybee is not exactly known. The female (queen) has 32 chromosomes, and after reduction the mature eggs have 16. The male has only 16 chromosomes and, through an unusual type of maturation which involves cells of very unequal size, and in which there is in effect no reduction, produces spermatozoa likewise with 16 chromosomes. Fertilization of the egg restores the number 32 for the females, while males, developing parthenogenetically, have only 16. While there is a large chromosome difference between the sexes and while the female may very well have two X chromosomes and the male only one, there would appear to be no different ratio of X chromosomes to autosomes. Haploid *Drosophila* is still female, because the ratio of X to A is 1:1. Either this ratio does not govern sex in the honeybee, or there is some feature of maturation that escapes detection.

Multiple Embryos and Sex.—As a rule one egg, fertilized or parthenogenetic, gives rise to one individual. In some animals, either as a regular occurrence or as an occasional event, a single egg may produce two, a dozen, or hundreds of offspring. The larger numbers occur in the insects; in the armadillo it is four; while in man the number may vary from two to five. In man they are called identical twins (Fig. 93), identical triplets, etc., referring to the fact that they have precisely the same genotypes. The litters of most mammals are not identical, since many eggs are liberated from the ovaries at the same time, and each fetus develops from a separate egg.

The feature of multiple embryos that is of interest in sex determination is that those of one group are all of the same sex. The meaning of this is merely that sex is determined before the embryos start their individual development. Were it not determined so early, the offspring ought frequently to be of different sexes, just as the members of ordinary litters usually include both sexes. Now, this separation, or at least separate development, of the multiple embryos occurs rather early. In insects, it is already taking place or has taken place when the embryonic mass is in the mulberry stage consisting of some hundreds of cells. In the armadillo, the number of cells in the blastocyst is

probably greater than this when the buds that produce the separate individuals arise, but it is still an early stage. In species in which it is already known that sex is determined at the fertilization of the egg, multiple embryos give no new information; they merely confirm the conclusion drawn from chromosomes.

In insects there are sometimes, in species which produce multiple embryos, broods which include both sexes. These proved very puzzling, and led to various explanations. The evidence now available appears



FIG. 93.—Identical twins so much alike that even their mother often confused them. From their origin from a single egg their genes must be alike. (From Wiggam in *Journal of Heredity*.)

to indicate that two eggs gave rise to the mixed broods. These insects are mostly parasitic on other insects, and it has been observed that the parasite often lays two eggs in the host. If one has the chromosome constitution of a male, the other that of a female, the resulting offspring should be of both kinds.

Secondary Sexual Characters.—The organs that carry on the actual functions of reproduction are known as primary sex organs. Those that distinguish the sexes from each other but play no *direct* part in reproduction are called secondary sexual characters. Examples of male secondary characters are the long tail feathers and spurs of fowls, the mane of the lion, the brilliant plumage of many birds, and the beard and baritone voice in man.

In vertebrate animals the secondary sexual characters are mostly under the control of hormones produced by the testes or ovaries. These hormones appear to be produced, not by the germ cells themselves, but by the interstitial cells which surround them; for treatment of the organs with X rays of proper dosage may inactivate the germ

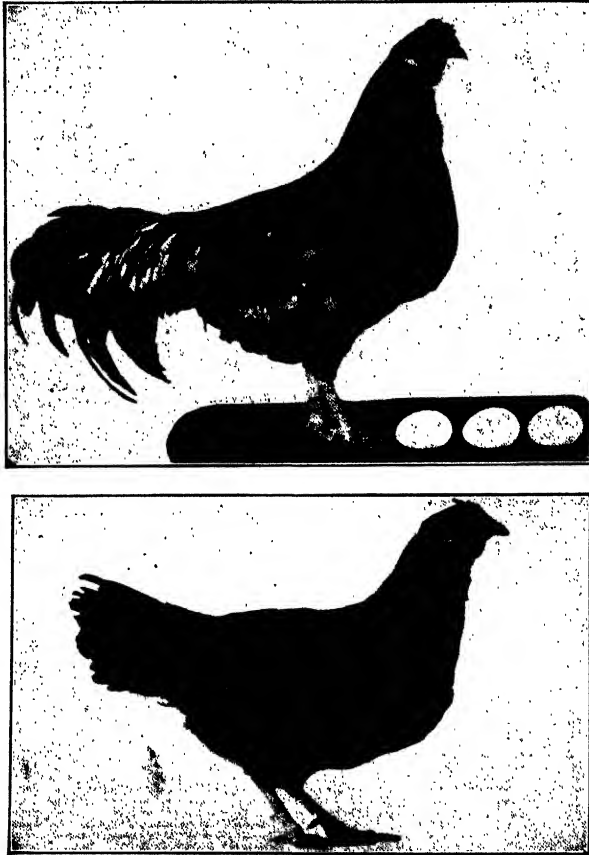

FIG. 94.—Above, a hen with cocklike tail feathers developed presumably as a result of disease in the ovary. The ovary resumed its normal functions and eggs were produced, and at the next molt short tail feathers were produced (below). (From Cole in *Journal of Heredity*.)

cells, at least with respect to their reproductive function, without interfering with the production of the hormone. Absence of the proper hormone at an early stage may prevent the development of the expected secondary characters. Thus, castrated male Brown Leghorn fowls do not develop their combs and wattles beyond the juvenile

stage. Many other examples of such interference with normal development are on record.

Sometimes the interference arises without man's intervention. Cole describes a fowl which must originally have been a hen, but which when first observed had long tail feathers like those of a cock (Fig. 94). While in this partially male condition the fowl laid eggs from which normal chicks developed. After the next molt, however, the tail feathers were short, and the fowl was a typical hen. The probable explanation is that some disease, perhaps tuberculosis, practically

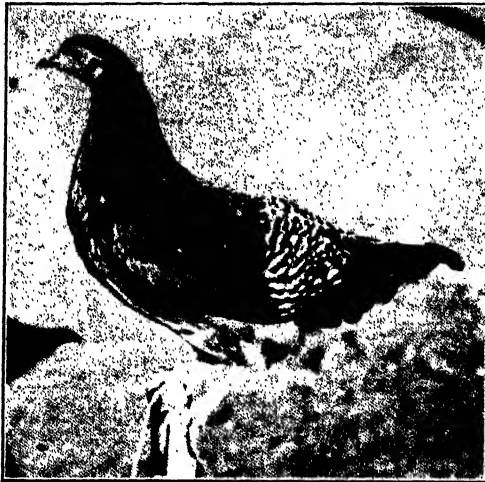

FIG. 95.—Patch of skin from a barred male fowl grafted upon a self-colored female, before the feather characters had developed. (*From Danforth in Journal of Heredity.*)

destroyed the ovary so that the usual female hormone was lacking. When new feathers developed after this change, long tail feathers were part of the equipment. Then the ovary recovered, and eggs were laid as described, but the long tail feathers necessarily persisted until the next molt.

An important difference between secondary sex characters and ordinary genetic characters is shown by some transplantation experiments of Danforth. He removed a patch of skin from the back of a young female fowl destined to be of solid color, and grafted in its place skin of a barred male. When the adult feathers developed, there was a patch of barred plumage in the midst of self-colored (Fig. 95). The color pattern is an ordinary genetic character. The secondary sex character involved is the shape of the feathers. In the male the feathers taper off to a point, while in the female the ends of the feathers

are rounded (Fig. 96). When the transplanted patch was examined, it was found that the feathers were rounded. Though these feathers came from a male and would there have been pointed, they assumed the rounded form on a female. Mere transplantation was not the cause of the change of shape, for skin grafted from male to male bore pointed feathers (Fig. 96, *B*). Pattern is genetic in the ordinary sense; shape of feather is a secondary character. Strictly speaking, the secondary characters are likewise genetic; but since hormones are

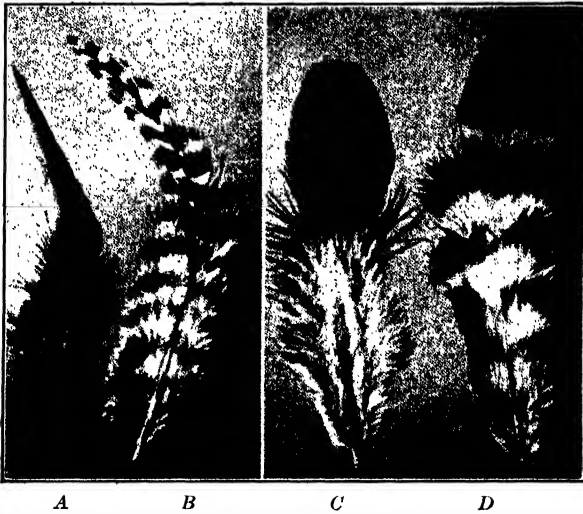

FIG. 96.—The difference between ordinary inherited characters and secondary sexual characters. *A*, feather produced by skin of a black female transplanted to a barred male; *B*, from a barred male transplanted to another barred male; *C*, feather from the female fowl shown in Fig. 95, developed from her own skin; *D*, from the transplanted patch of skin on the fowl of Fig. 95. (From Danforth in *Journal of Heredity*.)

part of the mechanism of their development, it is relatively easy to bring about environmental modification.

Sex Reversal.—Occasionally environmental influence may completely reverse the sex of an individual, both as to gonads and ducts and as to secondary characters. A remarkable instance of reversal is that of an adult hen which became a cock, as reported by Crew. This hen had laid normal eggs from which chicks hatched. Then she began to develop the secondary characters and the behavior of a male (Fig. 97). When the change appeared completed, the fowl was used as a male, and actually fathered normal chicks. The reversed fowl was a Buff Orpington, and, to prove that it was actually the father of the chicks produced, it was mated to a hen of another breed. The chicks

had Buff Orpington characters, which their mother, even if she had previously mated (which could have happened only with males of her own breed), could not have given them. Postmortem examination of the reversed fowl showed that the original ovary had been destroyed by a tumor caused by tuberculosis, and for some reason a testis had been produced by regeneration in its place.

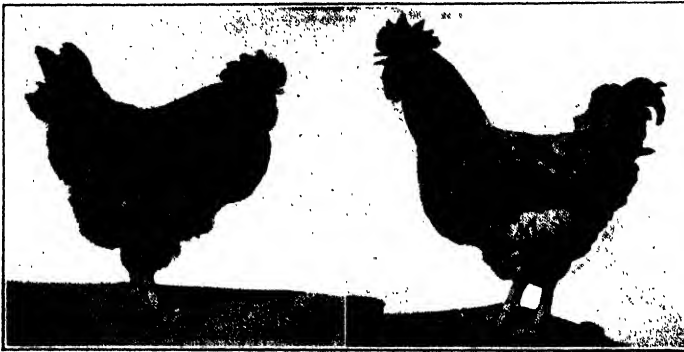

FIG. 97.—A Buff Orpington hen that became a cock. Two stages, early and late, in the transformation of a female into a male. (From Crew in *Journal of Heredity*.)

Intersexes.—Incomplete sex reversal often leads to the production of individuals intermediate between the sexes. Usually such organisms are patchwork in a sense, because their various parts are not intermediate to the same degree. Some structures may be more like the female, others more like the male. Individuals like this are not gynandromorphs, because the parts are not definitely and clearly male or female; the parts, or at least some of them, are intermediate. Such intermediate individuals are known as *intersexes*.

The nature of intersexes has afforded a clue concerning the manner of their production. Goldschmidt, in intensive studies of the gypsy moth, has offered the following explanation. An intersex is an individual that started development as of one sex, experienced a change of developmental physiology at some point, and thereafter proceeded to develop as of the other sex. The various structures that distinguish the sexes have their fate decided at different times. If an embryo starts developing as a male, any sex organs having their future decided early will be of the male type. Then the physiological change takes place, development is thereafter that of a female, and any organs determined later will be female. Since either the physiological change is gradual, not sharp, or the determination of the fate of structures is spread over an appreciable time (not momentary), some or all of the

structures resulting are intermediate. An intersex gypsy moth is shown in Fig. 98 between the typical sexes. The intermediacy is most apparent in the pattern of the wings but is observable also in the size of the body and in the antennae.

What are essentially intersexes are produced in cattle through hormone action in fetal development. When twins are produced, they may be both males, both females, or one of each sex. In any of these cases, the embryonic blood vessels may be separate, or may join to a greater or less degree. If one twin is male, the other female, and if their blood vessels anastomose anywhere, the blood of the male may flow through the vessels of the female, or vice versa. The male fetus develops a little faster than the female, and arrives earlier at the stage in which the sex hormones are produced. The male hormone thus travels in the vessels of the female before any female hormone is present. The effect of the male hormone is to arrest female development, and the female fetus never does reach the stage of hormone production. The original female thus continues its development more or less as of the male type and becomes an intersex. An intersex which is made so by action of a hormone of the opposite sex is called a *freemartin*. In cattle the freemartins are all modified females.



FIG. 98.—Gypsy moth intersex between typical female (above) and typical male (below). (From Goldschmidt in *Ergebnisse der Biologie*.)

Intersexes, whether in man or other animals, are almost invariably sterile.

PROBLEMS

165. How has it been shown that there are a number of sex genes in the X chromosome and that they are distributed over a considerable portion of that chromosome?

166. How was it shown for *Drosophila* that sex is dependent on autosomes as well as heterosomes?

167. How could a right-left gynandromorph be explained by assuming that fertilization did not take place until after the egg nucleus had divided once parthenogenetically?

168. How was the distinction between ordinary genetic characters and secondary sexual characters demonstrated in fowls?

169. Why should intersexes usually be sterile rather than hermaphroditic?

170. Why is an artificial increase in the proportion of one sex not necessarily an environmental determination of sex?

171. How do you suppose maturation of the spermatozoa of a male honeybee avoids a further reduction of the chromosomes below the haploid number?

172. Among ornamental fishes certain species have the XY mechanism of sex determination, others the ZW mechanism. If a ZZ male were crossed with an XX female, what prediction would you make regarding the sex of the offspring?

CHAPTER 19

HEREDITY AND EVOLUTION

Despite their conservatism, which they owe to their genetic mechanism, the types of organisms on the earth have undergone considerable change through long periods of time. There are many indications that the hundreds of thousands of species now in existence have sprung from relatively few origins of life, perhaps even from only one origin. These indications come from similarities of structure, of development, or of physiology, from distribution on the earth, and from fossils. With practical unanimity, the evidence points to a very extensive evolution of living things. How has this change come about?

From all that can be seen happening now, or inferred from the end results of past occurrences, evolution is and has been slow. When any change is effected, it lasts for a long time as a rule. The scheme of living things is plastic but is also resistant. There is nothing chaotic about evolution; it is certain there are brakes upon it. The reasons for both the existence of evolution and its slowness are matters of some importance.

Heredity may be counted upon to furnish the resistance. The protein nature of the genes and the very specific nature of their actions provide a strong tendency to maintain the *status quo*. If, then, change is possible, and if alterations may themselves become semipermanent through heredity, the evolution process is largely explained. Heredity and evolution used to be regarded as antithetic phenomena. One was thought of as undoing the work of the other. Difficulty was experienced in conceiving of heredity taking up the changes produced in evolution and making them permanent.

All this difficulty was gradually removed with development of understanding of the Mendelian mechanism. It was realized that the changes which constitute evolution occur in the genetic mechanism itself. The mechanism of heredity is also the mechanism of evolution. It is responsible for both the modifications and their permanence. The problem of evolution is first of all to discover how the genetic mechanism operates to bring it about.

Primary Sources of Variation.—The primary method of producing change is through *mutation*, or modification of individual genes. The

genes are chemical substances of a highly complex composition, hence they are subject to alteration; and an altered gene has a different effect. When the gene at locus 104.5 in chromosome 2 in *Drosophila* changes in a particular way, a fly that has two such modified genes develops brown eyes instead of red. That change took place many years ago, and the new gene has remained unaltered through a long line of descent ever since.

Hundreds of genes have mutated in *Drosophila* since the year 1910. Probably they had been doing so earlier. The structures modified are the eyes, wings, body, bristles, and legs. A few of the mutated characters are shown in Fig. 99. Corn also has experienced such changes in every part of the plant. Smaller numbers of mutations have been

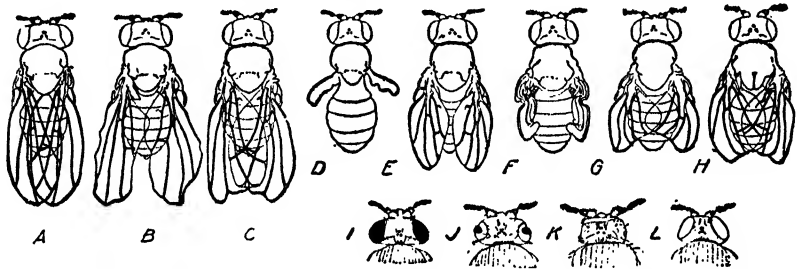

FIG. 99.—Some of the modifications that have arisen in the vinegar fly *Drosophila melanogaster* since 1910. A, normal wing; B, beaded wing; C, notch wing; D, vestigial wing; E, miniature wing; F, club wing; G, rudimentary wing; H, truncate wing; I, normal red eye; J, bar eye; K, eyeless; L, white eye. (From Shull, LaRue and Ruthven, *Principles of Animal Biology*.)

observed in mice, rats, guinea pigs, and rabbits. Every animal or plant that is raised in large numbers under careful scrutiny has produced mutations. It is safe to assume, therefore, that modification of genes is so widespread that evolution may be regarded as starting in that manner.

Other methods of introducing change are either minor or secondary. One of them is change of position of genes. While genes have a definite arrangement in the chromosomes that is regarded as normal, their relations to one another may be disturbed by translocations, inversions, duplications (page 86), and unequal crossing over. The first "position effect" discovered was that of the bar-eye gene already discussed (page 153). A number of other position effects have been found since then. A gene in one position in the chromosomes does not always do quite the same work as in another position; the characters of an animal or plant may thus be changed merely by rearranging the genes.

An important source of change is the doubling of the chromosome number in the cells. Any change in the number of chromosomes is apt to modify the nature of the individual in which it occurs. Even a change of only one in that number is often noticeable in physical appearance. We have already observed how the loss of one fourth chromosome changes the appearance of *Drosophila* (page 84). Addition or subtraction of two, three, or four chromosomes has comparable effects. The special significance of doubling the number of chromosomes is that it makes normal maturation of the germ cells possible. The homologous chromosomes pair in that process, and the paired chromosomes pass to different cells. When all chromosomes pair, all germ cells have like groups of them. If only one chromosome is added, it cannot unite with any other; the odd chromosome goes to some germ cells, not to others. Adding more than one chromosome, unless they are homologous, increases the irregularity, and many cells are incapable of functioning. The advantage of doubling the chromosomes is that there are two like chromosomes of every kind, all chromosomes pair, and all germ cells receive similar groups of chromosomes.

One of the very common effects of this doubling is larger size and more vigorous growth, as observed in evening primroses, Jimson weeds, tomatoes, and other plants. New races and species have originated at a single step by this method. Varieties of *Petunias* have sprung from other varieties by doubling the chromosomes; the tape grass or wild celery, *Vallisneria spiralis*, with its 20 chromosomes produced another species *V. gigantea* with 40 chromosomes; *Oenothera lamarckiana* with 14 chromosomes produced *O. gigas* with 28 chromosomes, etc.

Recombination.—Once a multiplicity of unlike genes at various loci have arisen by mutation, the chief source of further variation is recombination. The genes are brought together in ever new combinations as rapidly as crosses are effected between individuals differing with respect to them. Mutation does not stop, but a greater amount of difference among individuals is derived from recombination than from changes of genes.

With the general principles of recombination we are already familiar. It takes place whenever two animals or plants differing in two or more characters are mated. It is freer if the characters are independent of one another (genes in different chromosome pairs), but linkage is no barrier to the ultimate production of every possible genotype. All the combinations expected from a certain mating may be realized in somewhat fewer generations if the genes are independent than if they are linked, but in a long-range phenomenon like evolution

a few generations are unimportant. With even the greatest possible hindrance by linkage, variation by recombination should still occur more rapidly than the new types can fit themselves into the environment.

Were mutation to cease, recombination would finally reach a qualitative conclusion, in that all possible genotypes would exist unless other factors prevented that result. A population in which this had happened would include a certain proportion of each of the genotypes. What proportion of genotype there would be would depend on the relative abundance of the alternative genes. Thus, if in a population, 90 per cent of the chromosomes of pair 1 had gene *A* and 10 per cent gene *a*; if 75 per cent of the chromosomes of pair 3 had gene *B* and 25 per cent gene *b*; and if 60 per cent of chromosomes of pair 7 had gene *M* and 40 per cent gene *m*; then each of the 8 phenotypes, or the 27 genotypes, into which the genes *Aa*, *Bb*, and *Mm* could enter should exist in a certain calculable fraction of the population. If, however, the respective percentages were 80 and 20, 45 and 55, 17 and 83, the fraction of the population represented by each genotype or phenotype would be different. All this is based on the assumption that the various kinds mate at random, that all are equally fertile, and that none of them possesses any advantage over the others.

Such an equilibrium never actually exists. It is only an ideal condition from which to measure fluctuations or more permanent changes. The equilibrium is repeatedly upset by new mutations, which permit more combinations to be formed. Some genes are bred out of the species, causing a reduction of variability. Some of the genotypes turn out to be more frequent than is expected, purely as a result of chance. Moreover, mating is probably never random, for in most species, owing to restricted travel, each individual is limited in its choice of mates to those in its neighborhood. Under these several conditions, if something happens in one area of a species—a new mutation, accidental excess of one genotype—there is bound to result, in that immediate neighborhood, a redistribution of the proportions of the various genotypes. Something like a local race arises, even though there is no visible change in the organisms.

Migration also changes the relative frequency of certain genes or combinations merely because, in their travels, more animals of certain kinds happen to move about. Local races, differing in gene frequencies, are thus established.

With all these factors working against an equilibrium, recombination of genes goes on continuously. As stated earlier, it is the principal source of change after mutations have accumulated.

Hybridization of Species.—The recombination just described results from hybridization among individuals having to some extent different genes. A somewhat more radical recombination is effected when organisms belonging to different species cross. Although individuals of the same species may differ in one or several genes, those of different species may be unlike in dozens of them. It is not always, not even usually, possible to cross species, for there is a strong tendency for species to be intersterile. Some of them will not mate, or their germ cells will not unite, or the hybrid does not reach maturity. Other species leap all these hurdles, cross, and yield offspring, but the hybrids are sterile. There are, however, many grades of interfertility between species, and some such crosses are as fruitful as matings within species. When there is high fertility, recombination of the characters of the two species occurs about as freely as recombination with a species.

One difficulty in species crosses arises from differences in the chromosomes of the two species. These differences prevent some pairing of the chromosomes in the hybrid, with the production of irregular germ cells. In this situation, doubling the chromosomes is again of service. If one species has 18 chromosomes (the haploid number $n = 9$) and another has 24 ($n = 12$), the hybrid would have 21, but they could not be matched in pairs. However, if these 21 chromosomes are duplicated, there are at once 21 pairs of identical chromosomes, and pairing before maturation should be facilitated. Apparently, ordinary tobacco, *Nicotiana tabacum*, originated from a cross between *N. sylvestris* and *N. tomentosa*, or between *N. sylvestris* and *N. rusbyi* in which the chromosomes of the hybrid were duplicated.

Cause of Mutation.—While mutations are presumably the material with which species are created, there is little information concerning the reason for such changes under natural conditions. That the alterations must be chemical modifications has been assumed. Production of mutations by artificial means is not at all difficult (page 153). The first notable success in this line was that of Muller who, by X-ray treatment, speeded up the production of lethal mutations in *Drosophila* to 150 times its normal rate. Structural mutations were subsequently induced by the same treatment, such as the character "scute" in *Drosophila* (Fig. 100). Other types of radiation have likewise proved effective. Radium has been so used in barley, *Datura*, the evening primrose, snapdragons, and others; ultraviolet has produced mutations in *Drosophila*, snapdragons, and corn; and high temperatures applied to the larvae induced such changes in *Drosophila*. Age of pollen or seed determines the number of mutations in some

plants. The seeds of snapdragons and *Datura* yield many more mutations at an age of 7 to 10 years than they do if germinated promptly.

At first it seemed possible that radiation might be responsible for mutations occurring naturally, since the earth sends forth such rays at all times. Some calculations based on the intensity of this radiation showed, however, that there is not enough of it.

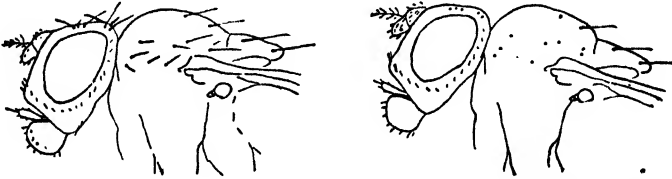

FIG. 100.—Visible mutation produced by X rays in *Drosophila melanogaster*. Normal fly at left; "scute" mutation (absence of certain long spines on head and thorax) at right. (From Serebrovsky and Dubinin in *Journal of Heredity*.)

Because of its historical interest, mention should be made of the old view that environment in general might cause mutations by modifying the body in some respect and that this altered body would then produce mutations in the germ cells within it. This idea has been generally abandoned, but an example showing how it might have arisen

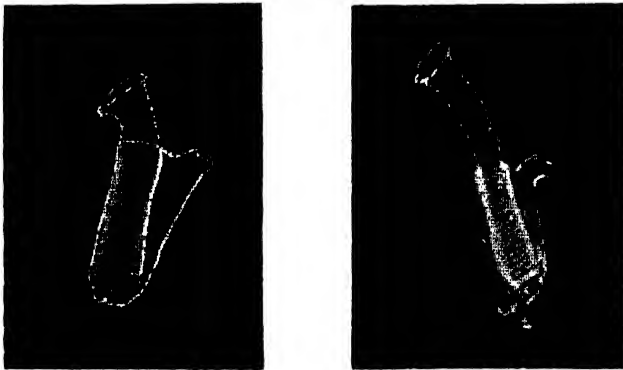

FIG. 101.—A sea squirt, *Ciona intestinalis*. At the left, typical animal. At the right, similar individual after nine days of especially abundant nutrition, showing the elongated siphons. (From Fox in *Journal of Genetics*.)

will be useful. In the sea squirt *Ciona* water travels through the body, entering and leaving by two projecting tubes called siphons. Kammerer cut off these siphons in a number of individuals, and allowed them to regenerate. The regenerated siphons were longer than those removed. He then obtained offspring from the regenerated animals and found that these likewise had long siphons. Kammerer supposed

that the long siphons of the offspring were inherited as an acquired character, which would mean that the regenerated siphons of the parents had induced a long-siphon mutation in one or more of the germ cells in the bodies of the parents. The experiments were repeated by Fox who was unable to obtain the same results. He discovered, however, that individuals especially well fed grew long siphons (Fig. 101). It seems likely that Kammerer had cared for his regenerating animals and their offspring better than those with which he compared them and was deceived into thinking that the nutritive effect was the result of a mutation induced by an altered body.

Direction of Mutation.—The remaining problems of evolution, as related to genetics, are mainly those of guidance. What has caused evolution to take the course it has followed? It has produced the thousands of species existing at the present time, when it might conceivably have led to organisms of very different kinds. The agents causing change might have been very much the same as they have been and yet have produced in the end species quite different from any we now have.

The first step in the guidance of evolution has been the guidance of mutation. Evolution cannot go in directions in which there are no mutations. It is quite clear that mutations are not happening in every conceivable way and that some mutations which do happen are more abundant than others. That is, the *direction* of mutation is limited by something.

It is to be expected, from the chemical nature of the genes, that they can be modified in some ways, not in others. All chemical substances are similarly restricted; they enter into certain reactions, not into others. Their chemical structure is the reason for this limitation.

Parallel mutations in different species illustrate the restriction on direction of mutation. If the sorts of mutation that arise are not subject to some guidance, the mutations of one species should not show any particular resemblance to those of another species. Yet such correspondences are common. In two species of *Drosophila*, *D. melanogaster* and *D. simulans*, the similarity is very marked. In each of them there have appeared prune, white, ruby, and garnet eye-color mutations; in each of them a yellow body-color mutation; in each of them crossveinless and rudimentary wings; in each of them forked and bobbed bristles; and some others. When their chromosomes are mapped (Fig. 102), it is found that these genes are in about the same order in the chromosomes of both species. One might at first suppose that each of these mutations arose just once, in either species, and then

was transferred to the other by hybridization. But that cannot happen; for though these species can be crossed, and offspring obtained, these offspring are completely sterile. The mutations that are found in both species must have originated in them independently. That so many of these mutations should be identical is inconceivable, unless the direction (nature) of mutation is being guided. Presumably the chemical structure of the similar genes furnishes this guidance.

Other indications that mutation is directed are the repeated occurrence of the same mutation (scores of times for the white-eye mutation

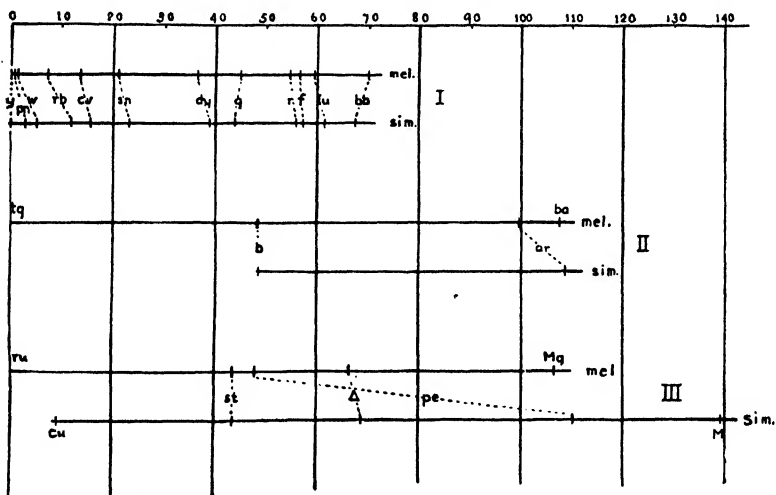

FIG. 102.—Maps of three homologous chromosomes of *Drosophila melanogaster* and *D. simulans*. The correspondence is closest in chromosome I (the X chromosome) in which the mutations to yellow, prune, white, ruby, crossveinless, singed, dusky, garnet, rudimentary, forked, fused, and bobbed are shown. (After Morgan, Bridges and Sturtevant, in *Bibliographia Genetica*.)

of *Drosophila*); and reversibility of mutation (the tendency of a mutated gene to go back to its original form rather than to some other new one). Neither of these things should happen if mutation were purely random as to nature (direction).

Chance in the Direction of Evolution.—When mutations have been produced, they begin at once the process of combination with other genes. If they enter into these combinations purely at random, it is expected that each combined genotype will exist in a certain fraction of the population, as explained in an earlier section. The expected fraction is, however, seldom realized. The actual proportion is usually something else, above or below expectation. This fluctuation is due to “chance.” The genes may not enter into the germ cells in quite

the expected proportions, the germ cells that are fertilized may not be drawn from the various classes in proportion to their numbers, the individuals that mate may not be taken proportionately from the several genotypes.

After the offspring are produced, there is a good deal of accidental elimination among them. Many are lost because they happen to be at a certain place where a destructive event (drying of a pond or a forest fire, for example) occurs—an event over which they have no control and from which they could not escape through any individually different qualities which they might possess. By means of these fortuitous occurrences, a sort of evolution *may* occur. Relatively more individuals of genotype *AaBBCc* may exist in this generation than in the last, and they *may* be even more abundant in the next. Though not highly probable, a succession of changes in the same direction may occur, redounding to the advantage or disadvantage of some particular genotype.

Changes may happen in one part of the range of a species, not at all or in the opposite direction in another part. When a mutation occurs, it must arise at some one place. Since migration in most organisms is neither rapid nor extensive, the mutated gene and its descendants remain for a long time in a limited area. Furthermore, in the migrations that occur individuals of one genotype may accidentally collect more abundantly in one place than in another. As a result of either of these processes, a species may become divided into a number of mildly different local races, purely by accident.

Although an extensive evolution can hardly result from chance alone, Wright, after a careful mathematical study of the random operations of the genetic mechanism and the random behavior of animals, is of the opinion that subspecies of a species, or perhaps even species of a genus, might arise in this way.

Selection.—The remainder of the guidance of evolution is largely a question of choice among classes of individuals. The genes possessed by each generation must come to it from its parents. If for any reason the parents possess one genotype more frequently than another, the offspring will have more abundantly the genes of that class. Any tendency of one genotype to produce more than its share of the next generation must result in an increase in the frequency of its genes. To illustrate concretely, suppose that in any generation, at a certain locus in the chromosomes of a species, 80 per cent of the chromosomes contain gene *A*, 20 per cent gene *a*. Random matings among the individuals, and equal fertility of all of them, would make the following

generation consist of the product $(0.8 A + 0.2 a)(0.8 A + 0.2 a)$, which is $0.64 AA + 0.32 Aa + 0.04 aa$. The genes are still in the ratio of 8 A :2 a . With random mating and equal fertility, the ratio remains the same indefinitely.

Suppose, now, that in some generation reproduction is not random. Assume that, among the individuals that reproduce, the heterozygotes (Aa) make up not the expected 32 per cent but 40 per cent, that the AA group drops to 55 per cent, and that the aa group rises to 5 per cent. Only 75 per cent of the genes at this locus in the parents are now A , 25 per cent a , and the next generation should consist of $(0.75 A + 0.25 a)(0.75 A + 0.25 a) = 0.5625 AA + 0.375 Aa + 0.0625 aa$. The homozygous recessives (aa) have risen from 4 to $6\frac{1}{4}$ per cent, the heterozygotes have increased, but the AA group has declined.

The above changes in proportions of classes of individuals resulted from a disproportionately large number of two classes and a smaller proportion of the third among those which reproduced. Precisely the same sort of change will occur if all individuals reproduce, but some of them are more fertile (produce more offspring) than others. Differences in fertility among individuals of a species are quite common. If increased fertility is caused by certain genes, those genes should increase in frequency from generation to generation. As the favored genes increase, their alleles diminish in number and are finally bred out of the species.

Any gene that causes its possessors to leave more descendants is said to possess a selective advantage. It may do this by increasing fertility, by saving lives that would otherwise be lost, or by merely prolonging life if the reproductive period is likewise prolonged. The only advantage which a gene can confer that is of any significance in evolution is ability to leave more descendants. Ease in getting food, facility in escaping enemies, attractiveness to the opposite sex are all advantages in evolution only if they result in a larger relative number of descendants.

One of the consequences of the preponderant influence of selection in the guidance of evolution is the remarkable adaptation of living things to their environment. Perhaps this statement would seem more significant if it were turned about: the chief reason for attributing the highest role to selection is the prevalence of adaptation, for selection would lead to fitness. One who notes that most mutations are harmful, at least in some physiological respect if not in curtailment of descendants, may wonder how evolution can ever be adaptive. There are two answers. First, it has been shown in *Drosophila* that certain

genes, by themselves all harmful, in combination with one another are beneficial. The mutations of *Neurospora* (page 155) that destroy the capacity to synthesize some needed substance should all be regarded as harmful; but one mutation discovered by Emerson and Cushing enables this mold to grow better than the wild type on a medium containing sulfanilamide (Fig. 103). While this particular substance is not naturally present in the mold's environment, the possibility exists that some mutation will enable the mold to live in situations now closed to it. A new species could well get its start from such a mutation.

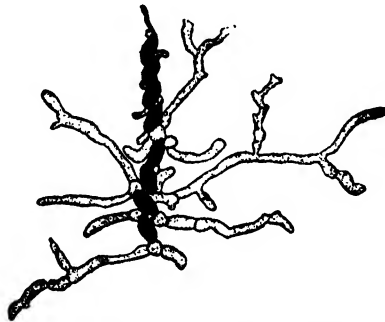

FIG. 103.—Spores of *Neurospora* germinating in medium containing sulfanilamide. Four lower spores (mutants) are tolerant, upper four inhibited. (From Emerson and Cushing in *Federation Proceedings*.)

Isolation.—One peculiarity of species is not accounted for in the foregoing description of the evolution process. That is the rather sharp definition of each species from other species. Although differences within a species merge gradually into one another, those between species are mostly rather sharp. An individual can as a rule be assigned to a certain species without question because of this clear separation. The sharp definition results from the absence or scarcity of intermediate forms.

On the whole the distinctness of species results from the absence or infrequency of crossing between them. Sometimes the lack of crossing stems from geographic separation of the ranges. Occasionally there is an impassable barrier between them. More frequently, however, the species could intermingle freely and still be isolated genetically. This isolation results from the inability of different species to breed with each other. Although as pointed out earlier there are species that cross freely and some from whose hybrids new species have been known to arise, most species are unable to cross at all or at best produce partially or completely sterile hybrids.

Were it not for this isolation, the distinctions between species would largely disappear; the gaps would be bridged over by intermediate individuals. Whether the merging of species into one another would be an advantage or a disadvantage is uncertain. Probably it would make little difference one way or the other in the success of the organisms. But one very characteristic feature of living things would be removed, and the problem of the classifier would either be much more difficult or not exist at all.

How isolation (other than geographic) is brought about is known for only a few species. As between *Drosophila melanogaster* and *D. simulans*, whose mutations and chromosomes are so similar, the separation is caused by what may be regarded as sterility genes. Sterility arises from the interaction of two dominant genes of different pairs. One species has one of these dominants, the other species the other dominant. Each species is fertile within itself, but in their hybrid the interacting genes are brought together and sterility results. In some other examples, sterility results from unmatched chromosomes in the hybrid. The chromosomes do not pair properly and are distributed irregularly in maturation. While some germ cells should accidentally receive a viable chromosome combination, many would not, and partial sterility would result. When species mate but do not produce any offspring or when they do not mate, the difficulty may be chemical (within the germ cells), or structural, or psychological. Species whose germ cells mature at different seasons are very effectually isolated, even though living in the same region.

PROBLEMS

173. Why cannot evolution occur in every conceivable direction?

174. How does a doubling of all the chromosomes help to bring about evolution through the crossing of species?

175. What is the argument that a change in the frequencies of alternative genes constitutes evolution even when no change in the appearance of the individuals can be detected?

176. How does the origin of mutations bear on the question of inheritance of acquired characters?

177. At what places in the evolution process is chance an important factor?

178. Why must selection be regarded as the principal guiding factor in evolution?

179. What must a character do to have an "advantage" in evolution, as compared with an alternative character?

180. Can you think of a reason for supposing that reproductive isolation of species is an advantage in evolution as compared with free intercrossing?

CHAPTER 20

INHERITANCE OF HUMAN STRUCTURAL CHARACTERS

A few human characters have already been presented at various points, where they appear to illustrate certain types of genetic phenomena. It is desirable now to add a representative group of others, many of which are too little understood to be useful in the illustration of principles. These are collected in this and the two following chapters. In selecting characters for inclusion, out of the hundreds about which something is known, weight has been given to their significance to human welfare, to the number of people affected by them, and to the extent of knowledge concerning them. For convenience they are classified as structural, physiological, and mental. This division is largely arbitrary, since structure arises out of the physiology of development, physiology differs according to structure, and mental qualities rest on the structure and physiology of the brain. Characters are listed as structural if they are detected chiefly by observation in the absence of any particular activity, but the line between structure and function is not easily drawn.

Difficulties of Human Heredity.—The student of heredity in man must be prepared to accept information that is incomplete, and to find that conclusions often remain in doubt. Things that appear to be the same character are inherited in different ways in different people or different families. One common contradiction relates to dominance. A character that obeys the rules of a recessive trait in one pedigree is apparently dominant in another. A character that is transmitted to the two sexes equally in one kinship occasionally gives strong indications of being sex-linked.

One source of uncertainty is the lack of experiments. One can not inbreed human stocks until they are homozygous for most characters before crossing them with reference to a single character. Furthermore, man's heredity is complex, and two features that are clinically identical may be produced by genes at different loci in the chromosomes. Where dominance is in dispute, the difference may well be the unlike genotypes of different individuals or different families. Genes in other animals are known to vary in dominance because of the influence of

other genes. Only homozygous human strains, bred to a given set of characters, could be free from discrepancies of this sort.

When a character is generally dominant in one large kinship, recessive in another, the explanation may lie in multiple alleles. The "normal" gene may have mutated in two different ways, one form being dominant, the other recessive, in the midst of an ordinary set of other genes. When a character usually autosomal shows apparent sex-linkage, there may have been translocation of a chromosome segment containing its gene to one of the X chromosomes. When a trait that is sex-linked, and therefore passes (in phenotype) from father to daughter and mother to son in certain crosses, suddenly begins to go from father to son, the explanation might be crossing over between X and Y chromosomes.

Often all that pedigrees show about a certain character is that it is occasional or frequent in some families, entirely wanting in others. This means that it is in some degree inherited, even if there is no clue to the method. The same conclusion is reached when there is distinct correlation (see Appendix) between parents and offspring, or between brothers or sisters. Greater similarity between identical twins than between other brothers or sisters likewise indicates heredity. These peculiarities and weaknesses of the sources of information are adequate to explain much of the indefiniteness of statement that must be employed in the following pages.

Eye Color.—Color of eyes was referred to briefly (page 56) in discovering recessiveness or dominance of a character from a family history. Inheritance of eye color is somewhat more complex than was there suggested. The tissue of the iris contains minute bodies that reflect blue light, as the sky reflects blue. When there is nothing to obscure this reflection, the eyes are blue. There is very commonly, however, a brown pigment in the front part of the iris. If this pigment is dense, the eyes are dark brown; if less dense, the colors are light brown, green, or gray. The quality of the color is also slightly affected by the texture of the iris.

Absence of the brown pigment (blue iris) is in a rough sort of way recessive to its presence. That is, in a general sense, blue is recessive to brown. Were this strictly true, two blue-eyed parents could have only blue-eyed children. Occasional brown-eyed children, however, have two blue-eyed parents, as pointed out on page 114. The easiest explanation of this exceptional result is that one of the parents carried the brown-eye gene, but also a dominant inhibitor which prevented brown from developing. A child inheriting the brown gene but not

the inhibitor would have brown eyes. Some investigators have held the brown color to be due to two kinds of pigments and two pairs of genes, *Aa* for brown and its absence, *Bb* for yellow and its absence.

There is a popular notion that eye color and skin color vary together, a notion which could easily be gained through failure to take racial origins into account. Correlation of eye color and skin color within a fairly homogeneous population seems never to have been adequately studied.

Finally, both the blue and the brown color of the iris may be missing, producing the pink iris of an albino. Although this condition may be part of general albinism, which affects also hair and skin color and is recessive to pigmentation, there is a form of it relating only to the eye. This latter pigmentless eye condition may accompany the usual color of skin and hair and is sex-linked and recessive.

Skin Color.—Color of skin plainly rests on a number of genes. Most races of men have some brown pigment, much or little. In addition, Negroes appear to have a yellow pigment which is readily concealed by heavy brown and which is recessive in crosses with whites, whereas Mongolians have a genetically different yellow which is dominant in crosses with whites. Inhibiting genes (the so-called dominant white) have also been postulated to account for a considerable number of instances in which mulatto children are darker than their parents. The inhibitor would be present in light parents, missing in the darker children. It should be pointed out, however, that children may be darker than their parents if the several color genes (of the same kind) are cumulative in their effect, after the manner of red color in the grains of wheat (page 114). This theory of Negro skin color has been held and corresponds well with the generally intermediate and very variable color of mulattoes, such as would be expected in blending inheritance (page 116).

Within the white race, differences in skin color may be much simpler. Family histories give the general impression that the darker colors are dominant over the lighter ones, but lack of dominance or even blending could often be postulated.

Distribution of skin color is sometimes irregular. Large patches of pigment are occasional, freckles rather common. The most striking examples of freckles are found in light-colored skins. The spotted condition is dominant over uniform distribution.

Albinism, or the complete absence of the usual pigments in the skin, is due to mutation of the gene *A*, which converts dopa to melanin, as related on page 157. General albinism is recessive to pigment.

Color of Hair.—Several schemes of inheritance of hair color have been proposed. Besides the basic gene A without which there is no color, Lenz postulates the pairs Bb and Mm , which are the real pigment factors; B yields brown pigment, M black (melanism). A person whose phenotype is AbM or ABM is black-haired, while ABm is brown-haired.

Lenz also assumes a number of mutant alleles of A . He suggests first of all a , which as stated results in albinism, then a^1 , a^2 , a^3 , and a^4 . These multiple alleles represent increasing pigmentation, in the order named. The phenotype a^3Bm is called blond, while a^3bM is medium gray. Among these mutant alleles, the darker ones are held to be

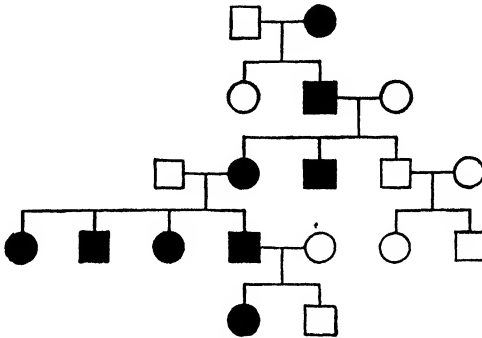

FIG. 104.—Five generations of premature whitening of the hair. The black squares and circles represent the affected individuals. In most of these the hair whitened before the age of 25 years. The character is here dominant. (From Hare in *Journal of Heredity*.)

dominant over the lighter ones, as is generally true in the other mammals studied.

Another pigment, red, is produced in some individuals by the gene R . Its locus is likewise held to be the site of three or four alleles; nonred is r , while r^1 and r^2 produce larger amounts of red color. Neel postulates a not quite recessive gene (perhaps more than one gene) for red, which is concealed by black or brown when one of these is present. There may, of course, be several kinds of red, genetically different.

The tendency of hair to whiten varies greatly in individuals and to some extent in races. Negroes become gray later than whites, and mulattoes are between these extremes on the average. Markedly premature whitening occurs in certain families (Fig. 104). In the one here shown it behaves as a dominant. Graying may depend on a hormone disturbance, but the hormones themselves are under genetic control.

Hair color is distributed unevenly in most people, as when mustache or beard is sandy while the hair of the head is dark, hair on the chest is different from that in the armpits, or hair on the front part of the scalp is lighter than that on the back of the head. In other mammals the agouti pattern is due to unlike placement of the colors on each individual hair, but man has nothing to compare with agouti.

Form and Distribution of Hair.—The form of the hair depends chiefly on its shape in cross section. If the cross section is circular or nearly so, the hair is straight; if an ellipse, the hair is wavy, curly, or woolly according to the degree of flatness (Fig. 105). It may even have a spiral shape. These features are impressed on it as it develops from the follicle. Naturally there are many degrees of this flattening and many grades of curliness.

What passes for straight hair in the white races is recessive to the curly or kinky or spirally wound hair of Negroes and Hottentots. Within the white races, according to one proposed scheme, there is a gene *W* for wavy, another gene *C* for curly; they are assumed to be at different loci, not alleles. The genotype *wccc* would produce straight, while if both *W* and *C* are present, curly tends to be epistatic (page 113).



FIG. 105.—Cross section of woolly (left) hair and straight hair. (From Schokking in *Journal of Heredity*.)

In the Mongolian races straight hair is genetically different from straight hair of European descent. Crosses with wavy-haired Hawaiians reveal the difference. While straight hair of the European types is recessive to the Hawaiian wavy, Chinese straight hair is dominant over it. Of modern races, the Hopi Indians have the coarsest hair, the Dutch the finest. The hair of the ancient Maya was more nearly circular than that of any present-day people.

In monilethrix the individual hairs are alternately thick and thin, at intervals of about 1 mm. There is a tendency in hair of this sort to break off near the roots. It has appeared as a dominant character in some family histories, irregularly dominant in others.

Distribution of hair on the body is irregular and of somewhat the same pattern in different individuals. Yet there are racial differences, some races having abundant, others sparse, hair on the chest; some having heavy, others thin, beards. The heredity of these things is unknown. The principal specific indication that hair distribution is inherited is the pattern of its loss in baldness. In some it is the crown that first becomes bare, in others the front part of the scalp, in still

others the whole top of the head (Fig. 106). These regions of baldness tend to be alike in various bald members of the same family. As indicated earlier, baldness is dominant in men, recessive in women.

Facial Characters.—In racial crosses, such as that between white and Negro, a broad nose appears to be regularly dominant over a narrow one. Within the white races, however, a high narrow nose is approximately dominant. Several genes are probably concerned, however, and some family histories are not quite so simple.

Thickness of the lips is undoubtedly genetic; but some have concluded thick lips are dominant, others that they are recessive, while Dunn in Hawaiian crosses finds hybrids intermediate. The genetic basis is not simple, apparently, or not always the same.

In some people, more often children, the skin of the upper eyelid is developed into a ridge or fold set obliquely across the inner end of



FIG. 106.—Pattern of baldness, spread over the whole top of the head. (*From Osborn in Journal of Heredity.*)

the eye opening. It is called the Mongolian fold, because it helps give the eye the appearance of sloping downward toward the nose. It does not have anything to do, however, with the real eye slope, as determined from the levels of the inner and outer angles. The Mongolian fold seems to be definitely dominant over the foldless type of lid, except in the Eskimo, where crosses with Europeans show it to be recessive. Perhaps the Eskimo lid fold is a different character.

A common difference in human ears is that the lower lobe in some is attached to the skin beneath, while in others it is free. Figure 107 is only part of a large family history assembled by Powell and Whitney that shows throughout the dominance of free lobes. A peculiar form of the ear that may be described as cup-shaped (Fig. 108) must be regarded as dominant. Small but distinct pits in the ears are dominant or nearly so; Pipkin finds them probably linked with a dominant type of albinism in certain Negroes.

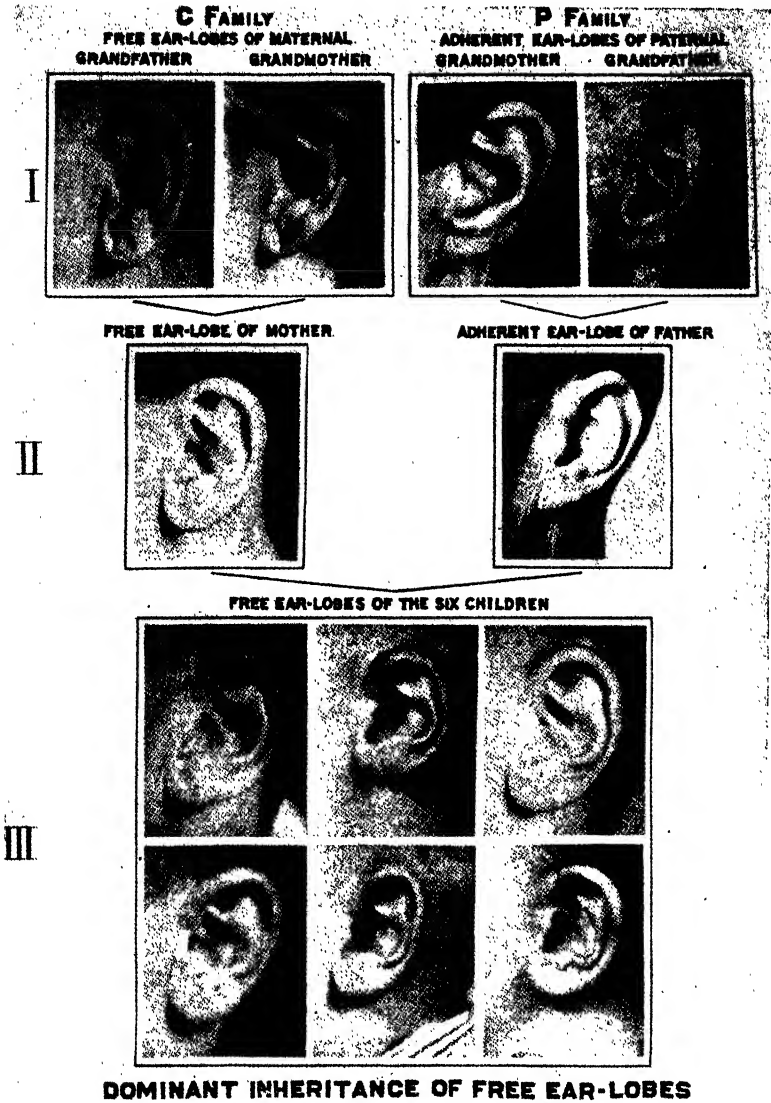

FIG. 107.—Inheritance of free and adherent ear lobes. (From Powell and Whitney in *Journal of Heredity*.)

The Teeth.—The time at which children cut their milk teeth is shown by twins to be partly inherited. Identical twins were found to cut them sometimes on the same day, sometimes a few days apart, and seldom more than 2 weeks apart; but of the fraternal twins studied



FIG. 108.—Cup-shaped ear, dominant over the usual type. (From Potter in *Journal of Heredity*.)

none cut them the same day, and a great majority cut them more than 2 weeks apart. Differences in resistance to caries, however, are not very unequal in the two kinds of twins. This decay of the teeth is partly of dietary origin, but family histories show similarities of parents and children in this respect.

As a rather rare condition, the enamel of the teeth may be missing (Fig. 109). Both the temporary and permanent set are similarly defective. They lack the usual resistance to wear, and the teeth of a 20-year-old man were worn down to the gums. This defect was found in the direct line in each of six generations; hence, it is plainly dominant.

Teeth of one or more kinds are sometimes missing. Dahlberg reports the absence of six of the eight incisors in both temporary and permanent sets. He concluded that the defect is sex-linked and dominant.



FIG. 109.—X-ray photographs of teeth without enamel (right); normal teeth at left. (From Clark and Clark in *Journal of Heredity*.)

Defects of the front teeth may depend on some failure of the two halves of the jaw to complete their growth and to unite in the middle line in the fetus. A smaller degree of the same failure may result in a slight gap between the middle incisors. This separation has been

noted in families, and appears as a dominant character. An overgrowth of the jaws results in prognathy, which is regularly dominant.

The Jaws.—Deficiency in the growth of the jaws may be much more extensive than in these tooth defects. The two halves of the upper jaw, as they grow toward one another in the embryo, may fall considerably short of uniting in the middle line. Harelip and cleft palate are the results. In some family histories these defects are nearly dominant, in some irregularly dominant, in some recessive and sex-linked. Reed finds harelip in mice to be due to many genes and believes that man follows a similar rule. The growth failure of the embryonic jaws is probably of several kinds, genetically different. By surgical treatment early enough the defect can be largely removed; but the genes go on.

Head Form.—Because it is used so extensively by anthropologists as a racial character, the form of the head assumes some importance in human genetics. The shape is usually measured by the ratio of greatest width to greatest length, a quotient that is called the *cephalic index*. A ratio of 0.72 is low, 0.86 is high. The former is that of a narrow or long head, the latter that of a broad or round head (Fig. 110). Between them and even beyond them in both directions is a finely graded series of indices.

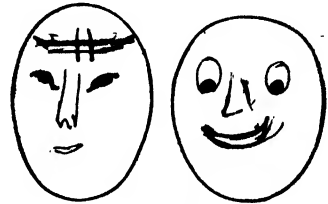

FIG. 110.—Outline of head with low and with high cephalic index.

The most decisive information about the shape of the head is that identical twins differ less than do fraternal twins. Some differences are due to distortion at birth, but these largely disappear. Discovery of the mode of inheritance is largely prevented by environmental influences. Growth in general is influenced by hormones, particularly that of the pituitary. During the last generation or two, growth in man (as indicated by stature) has increased, probably because of increasing knowledge of hormones and vitamins. How has this growth affected the cephalic index? Deficiency of vitamin A in rats has diminished the length of the skull, thereby raising the ratio of width to length, and similar effects may well be produced in man. There are in fact some indications that increase of stature in man carries with it a lowering of the cephalic index.

In actual race crosses between broad-headed Hawaiians and narrow-headed Europeans, Dunn has found the broad head dominant. It is unlikely, however, that just one pair of genes is responsible. Different

growth factors are presumably at work, and the ratio of width to length is not a good way of expressing their combined activity.

Bone Abnormalities.—Among the examples of human heredity cited in earlier chapters are several modifications of the skeleton of the hands



FIG. 111.—Syndactyly in which only the flesh of adjoining toes is joined. (From Pipkin in *Journal of Heredity*.)

and feet. Some of these are symphalangy, or fusion of the segments of the digits end to end without shortening, producing stiff fingers; syndactyly, fusion of the digits side by side, sometimes only as to the



FIG. 112.—Radiograph of brachyphalange thumb. Only the thumb was thus shortened, and only the terminal segment of it; one thumb (left) was normal. (After Hefner in *Journal of Heredity*.)

flesh (Fig. 111), not the bones; brachyphalangy, in which one or more phalanges are shortened (Fig. 112); and polydactyly, or extra fingers or toes. Brachydactyly or shortening of the fingers or toes as a whole, often to two phalanges per digit, is rather definitely dominant. These

all probably rest on some irregularity in the rate of development of the affected parts.

A form of syndactyly that is particularly marked results in a division of the hand or foot into a fork, sometimes called a "lobster claw." Clubfoot, in which the deformed member is pointed downward, with toes in, appears in most pedigrees as recessive, but occasionally dominant. This defect occurs in about one in a thousand and is found more often in men than in women. Lateral curvature of the spine, once attributed to wrong posture or to rickets, has been found to extend over several generations as a dominant character.

Brittleness of the bones, due to scant development in thickness, occurs (if at all) in childhood but usually is reduced or lost at maturity. It is nearly dominant. The defect is often associated with a blue-gray color of the (usually white) sclerotic coat of the eyes, which is regularly dominant. There is presumably some common basis for the two characters, since both develop from mesenchyme in the embryo. Deficient growth of the long bones at their cartilaginous zones results in dwarf stature, a condition that is sometimes plainly recessive, in other family histories dominant. Bone development is dependent on hormones, particularly those of the pituitary, thyroid, and gonads; hence, it is subject to possible nongenetic variation; yet in most instances the influence of the hormones is merely part of the genetic-physiological control.

General Growth and Size.—Not only the bones, but the body as a whole, grows or ceases to grow at the behest of hormones, particularly the three named above as influencing the skeleton. So many things enter into growth and volume that a specific mode of inheritance for the whole process and its total product cannot exist. That size is inherited is shown, however, by studies of twins. In every ordinary criterion of size—chest measurement, weight, length of arms, length of legs, breadth between specific points—identical twins have proved to be much more alike than are fraternal twins.

The shape of the body, whether slender or stout, is best measured by a ratio such as that of chest girth to height. It is commonly called body build. It is made up of different elements, of unknown number. Factors for stoutness are in general dominant or partially dominant in children, for the children of stout parents deviate less from the average of the general population than do the children of slender parents. In one study a group of stout women were found to have stouter parents than a group of slender women. In a number of family histories accumulation of fat appears to be dominant; but it must

usually be related to the activity of some endocrine gland, and is subject to a considerable measure of environmental control.

Skin Defects.—Local expansions of the small blood vessels in the skin, resulting in habitual nosebleed when they occur in the mucous membrane of the nose, are due to a dominant factor. Pigmented spots or moles, also red swollen birthmarks, occur often enough in certain families to suggest dominant or irregularly dominant inheritance; but also they appear in lines that never before exhibited them and here must be environmental or possibly mutations.

In xeroderma pigmentosum the exposed parts of the skin develop pigmented spots and inflammation that usually lead to cancer, and the victim seldoms lives beyond his teens. Since this ordinarily precludes reproduction, the character cannot be expressed in a direct line; hence, it is not dominant. Though the mode of inheritance has already been suggested as following either the X or the Y chromosome (page 73), some have held it to be an autosomal recessive. It is a rare condition and perhaps may not be genetically always the same.

Epidermolysis bullosa is a tendency to form epidermal blisters in response to pressure, friction, or injury. It exists in several forms, one dominant, one recessive, and one sex-linked, which may also follow the Y chromosome. Inflammation due to chemical stimuli is in general called eczema. Mostly it is probably a form of allergy, more particularly discussed in the next chapter. The mode of inheritance is not clear. Keratosis, a horny condition of the palms and soles, is dominant. In ichthyosis, the epidermis is covered with rough scales or horny plates. A common form of it is dominant; another not clinically distinguishable from it is a sex-linked recessive, while congenital ichthyosis is autosomal and recessive.

Muscles.—Absence of one of the muscles of the forearm can be observed externally and has been traced through three successive generations as a dominant. Muscle dystrophy, a gradual wasting away of a certain group of muscles, is really due to a nerve defect. It is sometimes spread over decades, or may occur more rapidly. The victim often becomes almost helpless. It appears in some family histories as a dominant, in others recessive, or even partly as sex-linked. Atrophy of the muscles of the lower leg and the feet begins usually in children, but may extend in later years to the arms. The nerves to these muscles are also degenerate, and it is probable that the nerve defect is the cause of the muscle atrophy. In different pedigrees it has the appearance of a dominant, a recessive, or even a sex-linked recessive.

Another muscular deficiency caused by nerve defect allows the eyelids to droop. It is called ptosis and is regularly dominant. Nystagmus, or rolling of the eyeball, though manifested by the muscles, is likewise a disease of the nerves. It is usually dominant, but in one pedigree it seems to be a sex-linked recessive and in still another an irregularly dominant sex-linked character.

Dimples, which depend in part on the arrangement of muscles beneath the skin, were long thought to be inherited—some said as a recessive, others as a dominant. The newer studies on twins, however, show that identical twins are only slightly more alike with respect to dimples than are fraternal twins. The environmental influence, much of it probably developmental, would seem to be large.

Hernia is to some extent a result of failure of a muscle wall to develop fully. The commonest type is that in which the viscera protrude through the inguinal canal. The testes descend from the abdomen through this passage late in fetal life, and then the canal should close. If it fails to do so, the viscera may sometime be forced out under stress of great exertion. From this origin, hernia is more common in men than in women; 3 to 5 per cent of men are affected. The transmission of this defect is practically that of a dominant, though a generation might appear to be skipped through lack of sufficiently strenuous physical labor to call attention to the rupture in some individuals.

Blood Vessels.—Varicose veins are swollen because of a weakness of the vessel wall. They are observed particularly in the lower leg because, in addition to the ordinary blood pressure, these veins must resist the hydrostatic pressure from the blood alone in the standing position. The weakness is generally dominant. A special form of this defect is observed in hemorrhoids, which are swellings of the veins at the end of the rectum. Sedentary habits and constipation are conducive to them.

Fingerprints.—The skin of the fingers is covered with a number of fine ridges which have so definite and distinctive a pattern for each individual that they are used as means of identification. The patterns are made up of three elements, namely, arches, loops, and whorls, combined in endless ways. Bonnevie has endeavored to show how these patterns are inherited. The number of the ridges depends on the thickness of the epidermis, the thinner it is the more ridges it bears. Bonnevie concludes that there is a general thickness gene *V* affecting all the fingers; that in addition there is a second gene *R* further determining thickness of epidermal pads on the thumb and first two fingers

(radial digits); and finally a third gene U affecting such pads on the remaining two fingers (ulnar digits). Heterozygotes (Rr , Uu , and Vv) are held to be intermediate in epidermal thickness.

Further influence on the pattern is exerted by the shape of the fingertips. If a finger with thick epidermis is flat, the pattern consists mostly of arches. If the surface of the finger is strongly elevated, the discontinuous patterns (loops and whorls) prevail.

PROBLEMS

181. What are the principal sources of uncertainty regarding the mode of inheritance of human characters?

182. If a character has behaved as sex-linked for several generations, then begins to pass from father to son, how could you explain the change?

183. How do you suppose degeneration of a nerve might cause atrophy of a muscle?

184. What could cause an increase of 3 inches in mean human stature in a given country within a period of 40 years?

185. What feature of hair makes it curly? Where is this feature impressed upon it?

186. If 30 per cent of men are bald at middle age, could you compute what fraction of the pertinent chromosomes in the population contain the gene for that character? Would it then be possible to compute the number of women who should be bald?

CHAPTER 21

HUMAN HEREDITY: PHYSIOLOGICAL CHARACTERS

In this chapter are assembled some of the better understood or more important characters that are not primarily observed in structure. These qualities may be detectable only in activities, or the structural element may be obscure. In some of them there is a well-known structural modification, but the physiology is more conspicuous. In a few the structural expression may be the more conspicuous, but since the physiological basis is known it seems more fitting that the fundamental feature be emphasized by including them with other physiological qualities. And finally, there are some that could, as explained before, be equally well placed in either the physical or the physiological group. The mental characters, as physiological as any traits can be, are set apart in the next chapter.

Defects of the Eyes.—One of the common causes of blindness is cataract, an opacity of the crystalline lens. Often only a part of the lens is affected, and blindness is not complete. It appears first in advanced years in some of its forms, in children in other forms. Heat seems to favor its development, and furnace stokers have been more than proportionately susceptible to it. While cataract is in general dominant, it sometimes does not appear in every generation of a direct line. The cornea also has its opacities, one of which arises at puberty and gradually increases until vision is greatly impaired. These defects are simple dominants.

Myopia or shortsightedness is due to a defect in the adjustments of refractive power. Refraction is due to curvature of the corneal surfaces and convexity of the lens, while length of the eyeball determines how much refraction is required. In myopia the structures are so shaped that at rest the vision is centered on near-by objects. More distant ones are not sharply in focus. Probably more than one gene is involved in the determination of myopia, for in different pedigrees it appears to be recessive or dominant. The opposite tendency, hyperopia or farsightedness, is usually dominant. When it occurs in children, it is frequently outgrown later.

Astigmatism is caused chiefly by unequal curvature of the cornea

in different directions. At a given focus vertical lines may be distinct while horizontal ones are blurred. The defect is usually dominant, but family histories indicating recessiveness have been reported. In some families where astigmatism occurred repeatedly, the axis of greatest curvature was found to be the same in each individual.

In strabismus (squinting) the axis of the two eyes cannot be converged on the same point, at least at a suitable focal distance, owing to incoordination of the eye muscles. The eyes may be turned either inward or outward. The defect is ordinarily recessive. Operative correction is frequently possible.

Night blindness is due to a defect of the retina that is detected only because it prevents vision in twilight or similar weak light. It exists in several forms, genetically and sometimes otherwise distinguishable. One form is dominant, one a sex-linked recessive, while a third, which

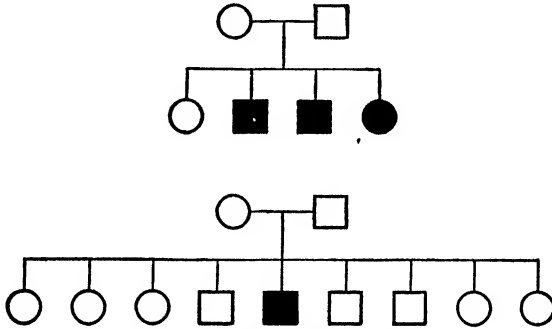

FIG. 113.—Pedigrees of day blindness.

is correlated with myopia, is an autosomal recessive. Retinitis pigmentosa begins in youth as a form of night blindness coupled with a narrowing field of vision. Eventually the sight is lost even in the middle of this field. Some have regarded it as an autosomal recessive; others as a sex-linked recessive and perhaps also an autosomal dominant. The suggestion has already been recorded (page 73) that the gene may cross over between the X and the Y chromosome.

Sight by daylight is dependent on the cones of the retina, which are also responsible for color vision. In weak light it is the rods that function, and color is not detected. Night blindness is therefore a result of a defect of the rods. When the cones are deficient there results a condition known as day blindness or (less appropriately) total color blindness. A day-blind person can see by moonlight or other weak light, but is blinded by bright daylight. This condition is recessive, as indicated by the brief family histories in Fig. 113. Day blindness,

despite its alternative name, has no relation to ordinary color blindness, already described as a sex-linked recessive character.

Deafness.—Hereditary deaf-mutism arises from a defect of the nerve of hearing or of the auditory centers of the brain, not from any abnormality of the ear itself. It is transmitted in recessive fashion. Unfortunately for the study of pedigrees the same defect results from several environmental causes. Meningitis and scarlet fever in early childhood may injure the inner ear and such children become deaf-mutes. Congenital deaf-mutism is often a result of syphilis.

Deafness due to a defect of the inner ear usually starts after middle age as a slight difficulty in hearing and becomes slowly or rapidly more pronounced, sometimes ending in total deafness. Anatomically two malformations of the labyrinth are known; hence, there may be more than one kind of inner-ear deafness. The varying degrees of affliction may rest on these anatomical differences. Pedigrees quite regularly show the character dominant.

In otosclerosis there is a disturbance of calcium metabolism affecting the growth of the bone in the neighborhood of the middle and inner ear. Although only two or three per thousand in the United States are deaf for this reason, the proportion in the families where it occurs rises to one-fourth or even one-half. Twice as many women as men exhibit the defect. Davenport holds that two genes are responsible, one of them sex-linked. Others have considered the character a simple dominant, or irregularly dominant, or occasionally recessive. There is some association of otosclerosis with brittleness of bones.

Taste.—Remarkable differences in the capacity to taste certain substances have been discovered. Many people do not taste phenylthiocarbamide (PTC) at all, to others it is extremely bitter, to others salty or sour. Among those who experience a similar taste, the threshold of sensation is very different. Some people require nearly a thousand times as great a concentration as others in order to detect the substance. Many other substances bring out similar though less striking differences in taste capacity. They show that the same person may have an acute sense of taste for one substance, a dull sense for another substance.

In general, ability to taste PTC is dominant; but in view of the different thresholds of sensitivity, and the different tastes experienced by those who are sensitive, any statement of the mode of inheritance must be qualified.

Allergy.—Strictly a physiological character is the sensitiveness of many people to foreign proteins or other substances. The irritating

substances may be those of pollen, or of foods, or of dust from hair. Hay fever, asthma, hives, eczema, edema, and migraine are expressions of this hypersensitiveness. The most suitable explanation appears to be a dominant or irregularly dominant gene. A person who possesses this gene may become sensitized to some foreign substance, usually a protein, and thereafter when exposed to the same substance develop a reaction against it. The members of a family who presumably carry the same gene may be sensitive to different things. The allergic manifestation may be hay fever in one, hives in another, but often it is the same reaction in members of the same pedigree. In the family shown in Fig. 114, the affliction was hay fever, and it behaved as a dominant;

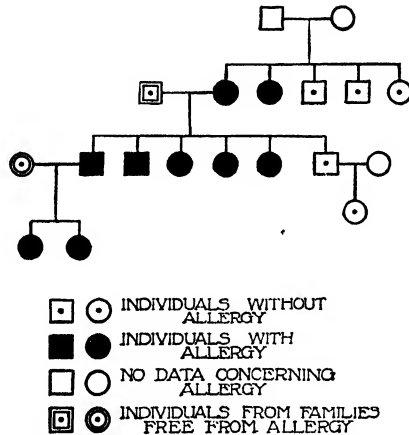

FIG. 114. Pedigree of hay fever. (Modified from Balyeat and Richards.)

in Fig. 115 it is expressed in different ways, and occasionally skips a generation. For some unknown reason expression of allergy is more prevalent in cities than in rural areas, and more frequent in people of high intelligence than in those of lower IQ.

Migraine is a recurring severe headache that may affect one side or the other, or some part of the head. It lasts several hours to a day and is probably caused by a swelling of the cerebral membranes. In some of the same pedigrees relating to migraine, other allergies, such as asthma, bronchitis, eczema, hay fever, and urticaria (hives) are found, and a parent affected by one of these types of allergy might transmit another to his children.

Blood and Blood Vessels.—To the facts relating to the ABO and the MN blood agglutinogens given earlier should here be added reference to the rhesus factor (gene *Rh*), so-called from its occurrence in

rhesus monkeys. About 87 per cent of human beings possess this factor, which is dominant; they are said to be Rh-positive. The other 13 per cent lack it; they are Rh-negative (gene *rh*). The gene exists in eight different forms (multiple alleles), which greatly increases the number of blood groups. Strandskov and Diederich reported 53 pairs of identical twins, all alike with respect to this gene (45 both positive, 8 both negative), while of 59 fraternal pairs 49 were alike (44 positive, 5 negative) and 5 were mixed. These are about the expected random combinations.

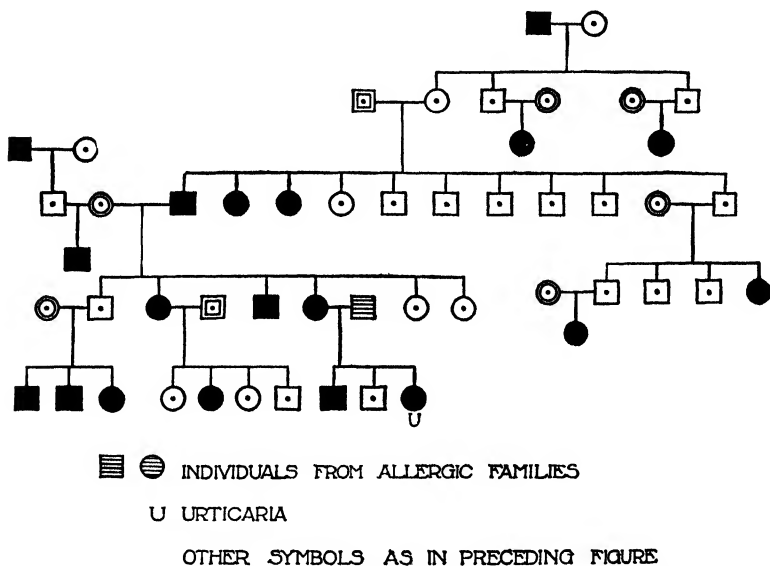

FIG. 115.—Pedigree of hay fever and other forms of allergy. (Modified from Balyeat and Richards.)

Hemophilia has likewise already been described. One of the principal defects of the blood is pernicious anemia, a progressive reduction in the number of red blood cells or of their hemoglobin content. This malady occurs more frequently in some families than in others, and some pedigrees indicate that it is dominant, some are quite irregular. One author believes it is dependent on two recessive genes, one of which acts on the gastric mechanism, the other on the bone marrow in which red cells develop. Patients are usually deficient in their gastric secretions, and there is some indication that this failure is dependent on a nervous disorder. Sickle-cell anemia is a rarer disease in which in drawn blood the red cells are sickle-shaped. It is accompanied by

weakness, sometimes by ulcers and pains. The few known pedigrees indicate that it is an autosomal dominant character.

An important feature of blood vessels is the pressure that they maintain. Normally about 140 mm. in middle-aged people, this pressure may rise to 160, 180, or even 200 mm. with a corresponding increase in the burden on the heart. Reduced blood pressures are less common. High blood pressure could be regarded as a simple dominant character from most of the pedigrees, but environmental conditions (diet, mental strain) influence it considerably.

Closely connected with high blood pressure is arteriosclerosis, or hardening of the arteries. Most elderly people have some degree of this defect, and the occupational and other environmental influences are considerable. The indication that arteriosclerosis is hereditary is largely that in some families it has a tendency to affect the vessels of the same organs in different members—in some the brain where it leads to apoplexy, the coronary arteries of the heart in others, the vessels of the kidneys in still others.

The heart itself has some genetic defects. Inflammation of the valves is most often due to infection, but sometimes occurs so frequently in families as to make infection improbable as a sole cause. These pedigrees fit dominant inheritance best.

Metabolic Disturbances.—Though any physiological character is metabolic, medical writers have applied the term metabolic diseases chiefly to those relating to sugar metabolism, arthritis, and obesity. The last named has already been mentioned as a structural character because of its ease of observation. To the metabolic diseases are added, for this discussion, one pertaining to the kidneys.

Diabetes mellitus is an inability to utilize carbohydrates in the normal manner. The rejected carbohydrates appear as sugar in the urine and are thus eliminated. The disease appears chiefly in elderly people and is due to the failure of certain groups of cells (islands of Langerhans) in the pancreas to produce a normal hormone, *insulin*. The quantity of urine is increased, and the patient experiences great thirst and hunger, and emaciation follows. Most family histories indicate approximately recessive heredity, but some are irregular, and rarely they appear to show dominance. Men suffer from diabetes more than women do, but it is not sex-linked. Nondiabetic relatives of persons suffering from diabetes mellitus sometimes have more than the normal amount of sugar in the blood. These relatives may be future diabetics, but not all diabetes can be predicted in this way.

Diabetes insipidus is characterized by excessive discharge of urine,

but there is no excess of sugar and no other unusual substance in the urine. The patient suffers great thirst. Family histories mostly indicate that the disease is a regular dominant, but there are exceptions in which heterozygotes do not show it.

Renal glycosuria, in which sugar is likewise excreted in the urine, is not to be confused with diabetes. It is relatively harmless and does not rest on any progressive deficiency of the kidneys. It is inherited apparently as a dominant character.

Arthritis (gout) is inflammation of the joints, accompanied by an accumulation of urates in the tissues and of uric acid in the blood. The uric acid is probably not, however, the cause of the disease. Arthritis appears as a dominant character in most pedigrees but is irregularly so in some of them.

Susceptibility to Infection.—In infectious diseases, the principal feature of interest is a possible difference in the susceptibility or resistance of individuals to the infective organism. This difference is of especial importance when the causative germ is always or usually present. Resistance to tuberculosis has for this reason been the subject of much study. That this resistance is inherited is indicated by studies of twins. Of 37 identical pairs, 26 were alike and 11 were different in their relation to tuberculosis; of 69 pairs of fraternal twins, 17 were alike and 52 were different. This is a plain indication of heredity. Correlation studies of parents and offspring have led to the same conclusion. Both Pearl and Goring found this correlation (see Appendix) to be about 0.5. Since living in the same family might lead to infection, hence to correlation without genetic basis, similar correlation studies were made for husband and wife, in whom the genetic relationship would not ordinarily exist. Pearl found the husband-wife correlation to be 0.24, while in Goring's study it was 0. The difference between 0.5 and 0.24, or between 0.5 and 0, is the correlation attributable to heredity. Pearl also found that 4.3 times as many people have tuberculosis when both parents are afflicted as when neither parent had it; and 1.6 to 1.7 times as many people have the disease if one parent has it as are diseased if neither parent has the infection. Only heredity seems adequate to explain all of these differentials.

These results are the more plausible because similar correlations in rabbits, where the infection with a standard bacillus could be carefully controlled, were calculated by Wright and Lewis, who found that 30 per cent of the difference in susceptibility was due to heredity, 10 per cent to age, weight, etc., and 60 per cent to environment.

Resistance to tuberculosis, as probably to most pathogenic organ-

isms, is assuredly not a simple character. Lenz ventures the conjecture that the separate elements of susceptibility are recessive.

Susceptibility to Environment.—A number of defects have an environmental basis, but, even to these external agents, different individuals may respond differently. Rickets is due to a disturbance of bone development in early childhood. Already formed bones can be partially decalcified and become soft and capable of bending somewhat. Teeth are as susceptible as bones. Deficient sunlight and lack of vitamin D are the obvious causes of rickets, but under similar conditions some families suffer much more harm than others. Identical twins are more alike with respect to this defect than fraternal twins are. These results indicate inheritance, a conclusion supported by analogy with rats, in which rickets was more easily induced in some individuals than in others, and in which selection for 14 generations succeeded in establishing two lines differing in their susceptibility.

A similar difference in susceptibility to goiter appears to exist but is slight. Goiter is an enlargement of the thyroid gland. It is favored by lack of iodine compounds in the food or water and is alleviated by very small quantities of iodine. The principal indication of heredity of goiter is the slightly greater similarity of identical twins as compared with fraternal. Cretinism, a dwarf condition that impairs mental development, is in some way related to goiter. It occurs prevalently in regions where goiter is common and in certain families. The afflicted families usually have goiterous mothers, and it has been suggested that cretinism is transmitted by the cytoplasm of the egg (that is, as a non-Mendelian character).

Whether Mongolism is in any degree a family character has long been debated. This congenital defect involves a round shape of the head, large tongue, slanting eyes, and abnormal mental development. It certainly is not a dominant character, and the fact that cousin marriages do not yield Mongoloid children in undue proportion is against its being a recessive. Many investigators have noted that the defect occurs often in the children of older mothers. In view of these facts, it is suggested that some injury to the germ occurs as an accident of development. If the defect has any genetic basis, the expression still is dependent on age or some condition of the mother.

Longevity.—Life expectancy in the United States in 1946, as computed by insurance companies from the latest data, was over 65 years, somewhat higher for women than for men. In 1900 it had been about 49 years. This increase makes it obvious that longevity is largely dependent on environment, since so striking a change in genetic char-

acteristics could hardly occur in a generation or two. Yet there are plain indications of hereditary contributions to it. In some early studies of longevity Ploetz found that infant mortality (in the first 5 years) was only a third to a half as great in families in which one of the parents later reached an age of 85 or more as in families of shorter lived parents. Another early study, by Bell, showed that of the fathers of persons dying under 40 years of age, less than 21 per cent reached the age of 80; but of fathers of persons living to be 80 years old, 46 per cent reached 80 years. In families in which neither parent lives to be 80, only 5.3 per cent of the children reach that age; if one of the parents lives to 80, 9.8 per cent of the children reach 80; and if both parents live 80 years, 20.6 per cent of the offspring attain a similar age. In the same family, the father's longevity was found to give a more reliable prediction of the children's age than did the mother's.

Many causes of reduced years are environmental and preventable. Fisher has calculated that if these preventable causes were removed, 13 years would be added to the average length of life. This is less than the amount added by having long-lived parents, indicating that heredity is really responsible in the latter group. Pearson has likewise employed mathematical methods to this problem, by the correlation procedure, and concludes that roughly two-thirds of longevity is due to heredity, one-third to environment.

Cancer.—Roughly one-tenth of all human beings who pass the critical years of early childhood develop some sort of malignant growth in later years. Though irritation of several kinds (X rays, chemical substances) helps to induce tumors, there are many indications that they have also a genetic basis. First is the frequency with which cancer appears in certain families. Little calculates that this frequency has not one chance in a million of occurring purely by accident, and Pearl describes a pedigree in which cancer occurs 200 times as abundantly as in the general population. There is a strong tendency for cancer to begin at about the same age in different members of the same family, and the chance that this could happen without heredity is very small. A number of identical twins have developed similar growths. Macklin finds that in identical twins tumors affect both more frequently, are more often of the same type, and develop more nearly at the same age, than in fraternal twins. Even with respect to others than twins it is frequently the same organ that is attacked in different members of a family. Thus among 258 breast cancer patients in an Amsterdam hospital, 76 had very near relatives afflicted with cancer, and 30 of these had breast cancer. Cancer of the stomach

runs similarly through some families, intestinal cancer through others. Such likenesses must rest on a genetic foundation. Relatives of cancer victims are more often cancerous if the organ affected is breast, rectum, or stomach than if it is the liver or the uterus. Uterine cancer has been found more commonly in Gentiles than in Jews. Finally, cancer has been extensively studied in mice and some other animals and, while supposedly a virus in the milk is one cause, heredity seems also to be important.

When the mode of inheritance is sought, several theories are found, but there is little certainty. In glioma retinae, the evidence rather favors recessive genes. Some have supposed one or more recessive genes to be responsible for cancer in general, though certainly a single pair will not suffice. Others have regarded the gene as dominant, and there are family histories which could be simply explained in this way. It seems necessary, however, to assume multiple genes for cancer in general and to regard the genes as different in different families or in different types of growth.

Nerve Defects.—Atrophy of muscles caused by nerve degeneration has been described among the inherited structural characters. Several other nerve diseases may now be added. Spastic spinal paralysis, resulting from destruction of certain elements of the spinal cord, causes lameness and stiffness of the legs. One family history shows an unbroken line of descent for six generations, as if it were dominant, but more often the defect appears in the children of normal parents, which indicates recessiveness. Spastic paraplegia, marked by stiffness of the legs, irregular eye movements, strabismus or squinting and lowered powers of vision, is mostly recessive, though one pedigree indicates sex-linkage.

Friedrich's disease (hereditary spinal ataxia), due to degeneration of parts of the spinal cord, involves loss of coordination of movements of the limbs. Several extensive pedigrees indicate recessive inheritance. There is another form of ataxia which is dominant. Oliver and Gray report five generations of cerebellar ataxia, regarded as dominant, in which 46 per cent of the kinship over 21 years of age were afflicted. These genetic forms of ataxia are not to be confused with the ataxia caused by syphilis.

Parkinson's disease, or paralysis agitans, is a fairly common condition arising in elderly people, in which the hands are in constant motion as in counting coins. Later a stiffness of the muscles develops, which may make the face resemble a mask, or which causes a stooping posture. Family histories indicate that it is a dominant character,

though the fact that it appears only in elderly people could easily make it seem to skip a generation. Some who inherit the defect presumably do not live long enough to show it.

In Huntington's chorea or St. Vitus's dance there are likewise twitching movements of the hands, face, or other parts of the body. These begin ordinarily between the ages of 30 and 50 and increase in later years. Mental degeneration accompanies them, and there is frequently a tendency to suicide. The many family histories agree (Fig. 116) in showing chorea to be a dominant character.

Myotonia or Thomsen's disease is present at birth in affected individuals. Muscles that have been at rest a long time enter into a state of stiffness or contraction which later disappears; or muscles may for

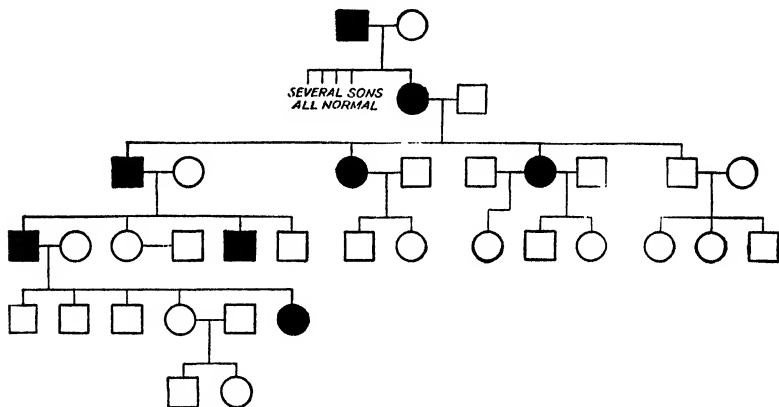

FIG. 116. --Pedigree of Huntington's chorea, which indicates that the defect is a dominant character. (From Popenoe and Brousseau in *Journal of Heredity*.)

hours at a time be quite incapable of contraction. Cold weather seems to favor these manifestations. Pedigrees indicate that the disease is a simple dominant character.

Stuttering and other impediments of speech doubtless rest on some nervous defect, and there are indications that it has a genetic basis in part. Some families show several examples of it, as against about 1 per cent in the population as a whole. About half of the stutterers have stuttering relatives. Some have supposed that when children of stuttering parents also stutter, they do so in imitation; but some children of such parents have been removed to other surroundings and still stutter. The notorious Juke family included one branch with stuttering members in successive generations, indicating dominant heredity; but mostly the inheritance is not so clear.

Left-handedness was found by Chamberlain to be more prevalent

among the children of two left-handed parents (46 per cent) than among the children of two right-handed parents (2.1 per cent). Rife found nearly three times as many left-handed children in families with one or both parents left-handed, as in families with both parents right-handed. Yet identical twins are not much more alike in this respect than are fraternal twins. Twinning itself seems to increase the likelihood of left-handedness, but the type of twinning appears to make little difference. Rife regards handedness as to some degree genetic, but more than one gene must be involved, and environmental agencies (presumably in development) are important.

PROBLEMS

187. What parts of the eye are responsible for night blindness and color blindness?

188. Why may allergy be a genetic character and yet take different forms in parents and their children?

189. How have the number of people reaching 75 years and the number reaching 5 years changed since 1910?

190. Many human characters may be modified by administration of hormones. Discuss the thesis that these characters are nevertheless genetic.

CHAPTER 22

INHERITANCE OF MENTAL CHARACTERS

Because of their complexity and the absence of unmistakable distinguishing marks in some instances, mental qualities are in general less well understood with respect to their heredity than are either the physiological or the structural characters. However, it is certain that many of them have a genetic basis even if the precise mode of inheritance has eluded discovery.

Feeble-mindedness.—The milder forms of mental defect are generally called collectively feeble-mindedness. There are many kinds and grades of it. Some are environmental, with syphilis and perhaps alcohol among the causes. In goiterous regions, feeble-mindedness occurs as part of the prevalent cretinism (page 212). The mental deficiency that inheres in Mongolism is at least partly environmental. Yet, after all these environmentally produced forms of mental defect are excluded, the bulk of feeble-mindedness must be attributed to genetic factors.

Some characteristic facts regarding heredity follow. Goddard found in a number of families in which both parents were feeble-minded that 470 of the children were feeble-minded, 6 normal. In other families in which one parent was feeble-minded and the other normal but shown by the pedigree to be heterozygous, 193 children were feeble-minded and 144 normal. In 26 families in which both parents were heterozygous, 83 children were normal and 39 feeble-minded. The ratios in these last two groups are near enough to 1:1 and 3:1, respectively, to suggest that feeble-mindedness is dependent on a single gene difference and that it is recessive. This assumption does not fit the first group, however, in which 6 normal children had sprung from 2 feeble-minded parents. There are many other family histories which similarly indicate that this mental deficiency is nearly a simple recessive, but with a few exceptions. Doubtless some of the exceptional individuals are illegitimate, but they can hardly all be explained in this way.

A justifiable conclusion would be that feeble-mindedness is of a number of kinds, some of them really simple recessives. A source of

exceptions to the rule of recessiveness may possibly be found in the Rh factor (page 208). It has been observed that about twice as many of the mothers of feeble-minded children are Rh-negative (genetically *rhrh*) as would be expected from the frequency of the *rh* gene in the general population. Also, among feeble-minded children more than twice as many are Rh-positive from Rh-negative mothers as would be expected from random fertilizations. An important physiological relation between Rh+ fetuses and their Rh- mothers has been discovered, but is reserved for a later chapter. May there not be such a reaction modifying development of the brain or in some way affecting mentality? The effect would be an immunological one, and could easily occur in only a fraction of the situations where it would be possible. This might explain instances of feeble-minded children from normal parents, even if the parents are homozygous for normal genes at the loci regularly affecting mentality. It might also explain normal children from two feeble-minded parents, if one or both parents owed their defect to being Rh+ from Rh- mothers.

A special form of mental deficiency is that which accompanies phenylketonuria, a defect in which phenylpyruvic acid is excreted in the urine. Why this "error of metabolism" relates to the mind as well as to the kidneys is unknown. It is genetically a simple recessive.

Dementia Praecox.—One of the commonest mental diseases is dementia praecox or schizophrenia. More than half of the inmates of insane asylums are committed for this defect. Often arising in the twenties, sometimes in earlier or later years, it takes many forms. Patients perform meaningless movements, or are subject to spells of rigidity, or have curious delusions. Their emotions and will are dulled; they lose interest in people and things; they are incoherent in thought and action. Their dullness and stupor may, however, be punctuated with periods of excitement.

More than one pair of genes must be responsible for this defect, and they might all be recessive; but the mode of inheritance is still not clear.

Other Insanity.—On the basis of statistics from institutions in New York State, about 4.4 per cent of all females and 4.7 per cent of all males are treated for mental disorder at some time in their lives. The actual number of psychotic individuals is presumably larger.

About 10 per cent of the affected males and 20 per cent of the females are treated for manic-depressive psychoses. This is probably a group of different but related disorders. Patients are subject to periods of severe melancholia and strong excitement, sometimes alternately. Violence and crime are likely to be part of the expression

of excitement, suicide a result of depression. Twin studies speak strongly for inheritance. In identical twins 31 pairs were concordant, 2 discrdant; while in fraternal twins 1 pair was concordant, 13 discordant. A dominant gene could well be responsible for manic-depressive insanity, but it does not always develop the character.

When insanity is considered a unit, without respect to the type of disorder, no conclusion as to mode of inheritance is to be expected. The pedigree in Fig. 117 shows presumable transmission but no definite rule for it.

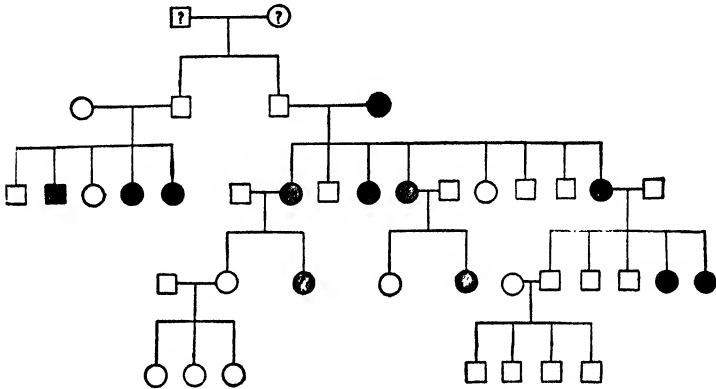

FIG. 117.—Pedigree of insanity, indicating that the defect is inherited but leaving the mode of inheritance in doubt. Black, insane; shaded, peculiar, queer, highly nervous; white, normal. (From Hanson in *Journal of Heredity*.)

Amaurotic Idiocy.—Children born apparently normal begin sometimes to lose their sight, become crippled, and recede in mental development in their early childhood years. The disease results from degeneration of nerve ganglia and the retina of the eye and regularly ends in death in early life. It is a simple recessive character.

Epilepsy.—This defect is manifested by spells of unconsciousness and peculiar muscular spasms. While accidents resulting in injury at birth may cause it, most epileptics have relatives similarly affected. Fundamentally the disorder seems to rest on disturbance of the brain waves. These waves, recorded by the electroencephalograph, are so similar in identical twins (Fig. 118) as to be of undoubted genetic origin. In all epileptics tested they show dysrhythmia or wide irregular swings of the curve. The dysrhythmia itself is inherited as a dominant character. Not all dysrhythmics, however, have epilepsy. Whether in such persons the disturbance is not great enough, or whether some supplementary condition is lacking, is not known.

Crime.—Crime is assuredly not a single character, and what constitutes a crime depends on the laws under which the individual lives. Also whether an individual is criminal, or rather how criminal he is, is partly determined by his environment. Yet it would be easy to overrate the influence of these nongenetic elements in crime, for a person whose mental qualities lead him to disregard the rights of others is well on the way to crime no matter what the laws are. Furthermore the facility with which a person gets into a crime-breeding environment is often one of his most distinctly hereditary characteristics. Genetic constitution not only helps to choose its environment, it helps to make it. This is one of the chief weaknesses of the view so often held that

GARFIELD - AGED 22 - 8-1/2 PER SECOND



CHARLES



MARJORIE - AGED 39 - 25-30 PER SECOND

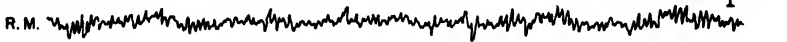

MARION



FIG. 118.—Brain waves of identical twins of two pairs, as recorded by the encephalograph. (From Lennox and Gibbs in *Journal of Heredity*.)

society itself is responsible for the crime in its midst. While admitting that the penal system may help to perpetuate itself by making itself necessary, one need not dismiss the hereditary element.

A few of the pertinent facts follow. Some of the mental defects known to be inherited naturally lead to crime. The cold cruelty and thoughtless violence that often go with schizophrenia easily have criminal consequences. Psychopathic individuals easily conceive that they have suffered a great wrong and are led to crime out of conviction that it is just. Epileptics are guilty of crimes of violence more often than is their numerical share. Feeble-minded people do not foresee the consequences of their acts, and are led to follow their desires. One study of 470 youths who came into conflict with the law showed 30 per cent to be distinctly feeble-minded, while 70 per cent were of lower intelligence than the average for their age. Mental tests have shown that repeating criminals have on the average a low IQ. In a study of

500 prostitutes, it was found that their families showed a high incidence of psychopathy, insanity, oligophrenia, alcoholism, criminality, and suicide. There are, of course, some types of crime that require high intelligence.

The criminal records of twins are of interest. One study showed that in 10 pairs of identical twins both had a criminal record while in 3 pairs only one was criminal; and in 2 pairs of fraternal twins both were criminal, in 15 pairs only one. A number of these twins were repeaters.

Notorious Families.—Because of the hereditary nature of some elements of criminal tendency, families tend to exhibit it frequently if they exhibit it at all. A number of notoriously criminal families are on record. One of the earliest of these is the so-called Juke family in New York State, carefully studied by Dugdale up to the year 1875. The name Juke is fictitious, but the real name is known, and the family history was brought down to 1915 by Estabrook. In the interval between these two studies, the family had changed little except in numbers. Of nearly 2100 individuals (three-fifths of whom were still living in 1915) belonging to this family, 378 were prostitutes, 181 victims of alcoholism, 170 paupers, 129 otherwise dependent, 118 criminals, and 86 kept houses of ill fame. Approximately half of the family are feeble-minded, and much more than half of the criminal part of the family are feeble-minded. Indeed, by Estabrook's classification, all criminal members known to him were rated as mentally defective. All these people are descendants of one woman, named "Ada" in the records, who was herself a harlot, and the son of a backwoodsman of Dutch descent. Little has been ascertained directly about the mental qualities of this pair, but it is likely that both were defective. These two people, through their descendants, without counting any indirect losses, have cost the state of New York millions of dollars.

Another such family was later studied by Goddard and described under the name Kallikak. The progenitor of this family, himself of respectable though not prominent ancestors, in Revolutionary times became the father of an illegitimate child by a feeble-minded girl, and later married a cultured woman of good family by whom he also had children. Two lines of descendants were thus begun, one of which has been almost wholly normal, the other including many feeble-minded and some other defectives. Not all of this difference is attributable to the differences between the two women who originated the two lines, since the descendants consorted with others of their kind; but the beginning was made by them.

The Tribe of Ishmael, studied first by McCulloch and later by Estabrook, furnishes additional examples of what is presumably mental defect running through general families. This notorious group is not of a single relationship, but includes perhaps four hundred families, of which the Ishmael family was the largest and worst. An early record is that of John Ishmael, who migrated from Kentucky to Indianapolis in 1825, and thereafter made "gypsying" trips annually, returning to the vicinity of Indianapolis for the winter. Other families with similar wandering proclivities followed the same route and stopped at Indianapolis because of the generosity of the inhabitants. Central Indiana thus became the headquarters of numerous families having similar qualities and receiving collectively the designation Tribe of Ishmael, though not of a single kinship. They have since spread more or less into the surrounding states and number almost certainly more than ten thousand. The characteristics of these people are shiftlessness, gypsying, petty thieving, begging, and sexual immorality, including prostitution and polygamy. Without much doubt these traits are basically due to feeble-mindedness or other mental defects.

Similarly notorious are the Zeros of Switzerland, the Wins of Virginia, the Hill Folk of Massachusetts, and the Nams of New York. To describe them would be repetitious. The fundamental cause of their peculiarities must be in each of them widespread mental deficiency.

Intelligence.—On the credit side of the genetic ledger no item is of more importance than intelligence. Mental tests have been used with school children, and have shown that of 41 superior children only 2 lacked a near relative who was also superior. Identical twins furnish the usual valuable information. The first critical examination of such twins was made by Muller. The twins in question (Fig. 119) lived in very different environments, although in families of the same general social rank. Comparison of their physical likenesses and differences indicated, by a statistical method, a probability of 386:1 that they were really identical twins and should therefore have identical inheritance. Intelligence tests resulted in strikingly close ratings—153 and 156 with the army alpha test, and 62 and 64 with the Otis advanced test. These are very superior ratings. In other tests, designed to reveal will, temperament, emotion, social attitude, etc., considerable differences were revealed, which are fairly attributable to differences in training and other experience. Later studies of identical twins by Newman did not lead to such clear results. Using fingerprints and other physical characters to determine which twins were identical, he found that the mental equipment of some of those regarded as identical might be very differ-

ent. One pair, described rather fully, lived together until two years of age, after which one went to Canada, the other remained in London. Their physical likenesses indicated a probability of about 2000 to 1 that they were identical. Eleven tests were applied to them, including the Stanford-Binet, Thurstone psychological, Otis self-administering,



FIG. 119.—Identical twins who were separated at the age of eight months and were together an aggregate of ten months after that time. One was trained in a business college and held numerous secretarial positions; the other was a teacher, married and had one child. Their physical likeness is obvious. Their mental likeness was tested by Professor Muller (see text). (From Popenoe in *Journal of Heredity*.)

International (Dodd), Stanford achievement, and Downey will-temperament. The twins were quite different in nearly all cases. Whether the differences between them are thus proved nongenetic, or whether the criteria of their being identical twins are proved inadequate, is not decided. Fingerprints, often used in determining which twins are identical, are not wholly reliable; and besides, even fraternal twins are alike in all respects for which their parents are homozygous. One

would like also to know what results would be obtained by administering the various psychological tests to identical twins who had lived together all their lives. This would be a test of the tests themselves.

How intelligence is inherited is not understood; few have attempted to discover a definite method, owing to its complexity. Hurst, from a consideration of the numbers of people of the various mental grades, proposed a scheme involving six pairs of genes which he calculates will produce the observed distribution. First in his scheme is a dominant gene *N* for mediocrity. In the presence of this gene other genes are of no effect. With *nn*, which permits atypical mental development, either good or bad, modifying genes (*Aa*, *Bb*, *Cc*, *Dd*, *Ee*) determine the result. These modifiers are cumulative and lack dominance. One gene of each of these pairs favors ability, the other the reverse. Hurst estimates that the random combinations of these genes would provide the observed numbers of individuals of the various grades of intelligence, but no attempt has been made to determine the genotypes of individuals in any family history.

Musical Ability.—The classical evidence of the inheritance of musical ability is the family relationship of many musicians. A favorite pedigree for this purpose is that of Johann Sebastian Bach which, because of errors in all earlier accounts of it, has recently been carefully reexamined. The new family history may be summarized as follows. In six generations, taking into account only men (because of the limited opportunities for women) and omitting all not old enough to have demonstrated their capacities, this pedigree includes, besides Johann Sebastian himself, 29 professional musicians, 16 others who were composers, 2 known to have musical ability but who were not professional, and 7 who are not known to have had any special musical gifts. This list is complete; no men have been omitted. Similar pedigrees have been assembled for Mozart, Beethoven, Brahms, Schubert, Liszt, and Weber, each through three or more generations and each including many more musicians than the general population can boast.

It is not profitable to try to fix dominance or recessiveness of musical ability as a single character. It is obviously made up of sense of pitch, consonance or dissonance, intensity and rhythm, tonal memory, feeling, imagination, and the like. Psychological tests devised by Seashore have been used to measure some of these separate elements, and it is found that they may be fairly independent both in their occurrence in individuals and in their inheritance. A person may have a good sense of pitch with a poor memory for tones, or a good sense of intensity without a good recognition of consonance. The

results of these tests are not appreciably affected by musical training, hence are to be regarded as measures of ability, not achievement. Even these single abilities have not been shown to be inherited in any clear fashion, as children may be either superior or inferior to their parents or intermediate between two dissimilar parents. Inheritance of musical ability is therefore quite complicated.

Other Special Aptitudes.—Painting and sculpture have likewise their celebrated families. Titian was one of nine artists in one general relationship, and the historical painter Feuerbach was similarly related. Mathematics is also a family accomplishment; the Bernoulli family included at least eight important mathematicians. This ability may concern chiefly form (geometry) or logic (algebra, etc.), and one investigator concluded that divisions of mathematics tended to run separately in families. This same student held that the single components of mathematical ability were probably mostly dominant and autosomal. The occurrence of both mathematical and musical ability in the same individuals is so common as to lead to the belief that they have something in common.

PROBLEMS

191. What apparent irregularities of the rule that feeble-mindedness is recessive could be explained by the Rh factor?

192. If insanity and feeble-mindedness are apparently becoming more common, what various explanations of the increase may be given?

193. Why do mental tests not always yield equal ratings of identical twins?

194. What elements enter into musical ability? Which of them do you think there is some hope of measuring?

195. How do you suppose the idea gained currency that criminals can be recognized as such from the shape of their ears or noses?

196. In what genetic situations is correlation most useful in showing that characters are inherited?

197. Which is the more likely, heredity or environment, to explain differences between children of the same parents?

198. How do you suppose tests of musical ability avoid showing the results of training?

199. Why has it been more difficult to discover the heredity of mental characters than of structural traits?

200. If numerous men in a kinship have been naval engineers, does that mean that naval-engineering ability in this line is inherited?

CHAPTER 23

APPLIED GENETICS

Knowledge of heredity is extensively applied in three directions: to the improvement of farm crops and domesticated animals, to the settlement of disputed points at law, and to betterment of the human race itself. The first two of these methods are treated, with representative examples, in this chapter.

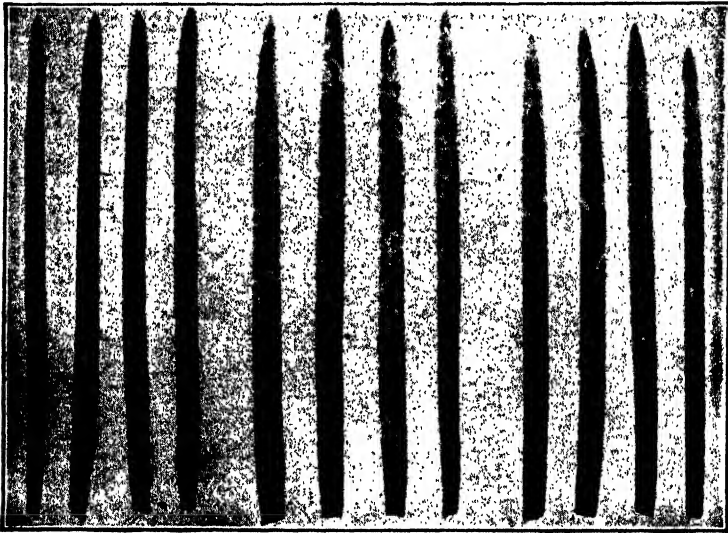

FIG. 120.—Differences in resistance of wheat to black stem rust; resistant type at left, others partly susceptible. (From Hayes and Aamodt.)

Crop and animal improvement is chiefly concerned with the food supply, but to a lesser extent with clothing, sometimes with shelter. Plants have yielded more than animals to the newer knowledge of heredity, partly because their economic characters are simpler, but more because it is inexpensive to rear them in experiments.

Resistance to Disease in Plants.—One of the most important features of a cultivated variety of plant is its yield, and one of the principal obstacles to high yield is disease. There are many of these diseases, and for nearly all crops some varieties are more resistant than others.

It is desirable to know how this resistance is inherited, so that it may be combined, in crosses, with the other features of economic value. In stating the mode of inheritance, one needs to remember that resistance which is dependent on, say, three pairs of genes may appear in a given cross as dependent on only two, or even on only one pair. In that cross the two contributing plants were simply alike for one or two of the necessary genes, but different for the rest.

Resistance of wheat to rust (Fig. 120) may differ from susceptibility by just one gene, with resistance dominant. Bunt resistance in wheat rests on three pairs of genes, two strong pairs and one weak. Resist-



FIG. 121.—Copenhagen cabbage, susceptible to the "yellows," at left; Marion Market, resistant, at right. (From *Reinking in Farm Research*, N. Y. State Agr. Exp. Sta., Geneva.)

ance to rust in snapdragons, which exempts 80 to 90 per cent of the plants, is provided by a single dominant gene.

Blight in corn is prevented by a single dominant gene, stem rust in oats by one dominant gene, crown rust in oats sometimes by one dominant gene but sometimes by two complementary dominant genes at different loci. Smut resistance in oats requires two pairs of genes in some contrasts, three pairs in others, but often only one. Mildew in barley is affected by one dominant and one recessive gene, while mildew in beans is largely prevented by one dominant. Wilt resistance in tomatoes depends of one dominant gene.

Varieties of cabbage differ greatly in their resistance to the "yel-

lows," a disease caused by a fungus which develops best in hot weather. The Copenhagen variety is very susceptible, whereas Marion Market is nearly immune (Fig. 121). The heredity of this resistance is not fully known.

Resistance of Plants to Pests.—It is not only to the disease-producing organisms that plants show resistance, but sometimes to the pests that feed on them. Varieties of cantaloupes differ in the extent to which they withstand the attacks of aphids. Ivanoff has tested the strains by putting aphids on them in the seedling stage and watching the drooping of the leaves that takes place several days later in the susceptible plants. Crosses between resistant and susceptible types show the resistance to be dominant, and there is ordinary segregation in F_2 (Fig. 122).

One of the worst pests of wheat is the Hessian fly; but some varieties of wheat are resistant to it. Some varieties are found, in crosses, to differ in two pairs of genes with respect to this resistance,

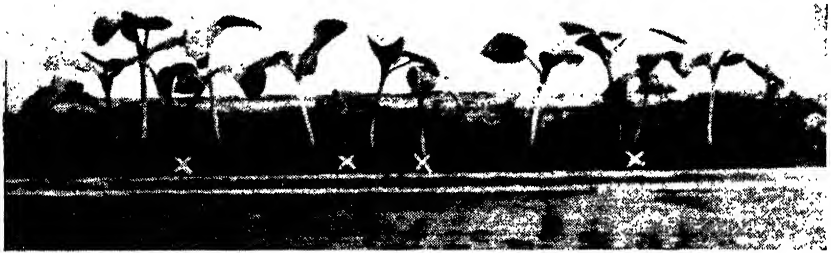

FIG. 122.—Susceptibility of seedling cantaloupes to aphids. An F_2 generation from cross of resistant and susceptible; susceptible plants marked X. (From Ivanoff in *Journal of Heredity*.)

others in only one. Resistance tends to be dominant under field conditions but recessive in the greenhouse, at least in certain crosses.

The wine-producing grapes of France are largely susceptible to phylloxera, aphidlike insects which attack the roots. Certain American varieties are immune to the phylloxera, but do not possess the qualities needed for wine. Hybridization between the French and American strains has led to the combination of immunity with some other desirable qualities to produce good table grapes, but attempts to make the wine grapes immune have not been very successful so far. Just how the resistance to phylloxera is inherited is not clear, but it obviously is a segregating character.

Amargo corn in Argentina is resistant to locusts, and this property is inherited as a recessive character. A variety of peach from China

and the Philippines is resistant to nematode worms, which attack the roots, and this property is found to be dominant. And finally, hybrids between certain strains of corn are more resistant to the corn borer (Fig. 123) than are the parent strains. This response may be merely part of the phenomenon of hybrid vigor, to be discussed later, but here it is only indirectly related to yield.

Resistance to Disease in Animals.—

Much less definite is the knowledge of inheritance of resistance to disease in animals. The resistance of poultry to *Salmonella pullorum*, the bacterial germ of white diarrhea, is probably provided by the larger number of white blood cells present soon after hatching, which is the time of greatest danger. This extra number is inherited and is in general dominant, but it may rest on more than one gene since the resistance is increased by selection. Susceptibility to typhoid in fowls was reduced from 85 per cent to 10 per cent in five generations of rigid selection, but even then considerable genetic variability remained in the flocks. The mode of inheritance was not discovered. Frateur concluded that resistance to diphtheria in poultry is due to a single pair of genes, but the numbers of fowls observed was too small to justify so definite a conclusion.

Rabbits differ considerably in their resistance to the bacterium causing abortion, and Manresa was able to produce by selection nearly true-breeding strains of susceptible and resistant animals. He tentatively concluded that the difference is governed by one pair of genes and that resistance is dominant or partially dominant.

Many other experiments with resistance to infection have been conducted on laboratory mammals, particularly rats and mice, but these animals are not of direct economic importance in the same sense as poultry and rabbits. They confirm by analogy, however, the expectation that such resistance will be found to be genetic and that it is probably Mendelian.

The question has been raised whether resistance may not be more dependent upon the mother than upon the father and thus be attribut-

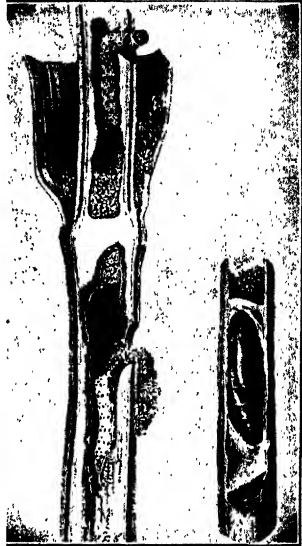

FIG. 123.—The European corn borer. (From Snodgrass, U. S. D. A. Bureau of Entomology.)

able to cytoplasmic or (in the mammals) developmental influence. In a number of experiments this possibility has been tested by making two series of matings, in one of which only males were selected, in the other only females. The results were essentially alike, indicating that resistance is transmitted nearly equally by the two sexes.

Economic Features of Poultry.—Fowls have yielded more to experiments on heredity than most other domesticated animals, because they are least expensive to rear. Besides resistance to the pullorum disease, mentioned in the preceding section, important results relating

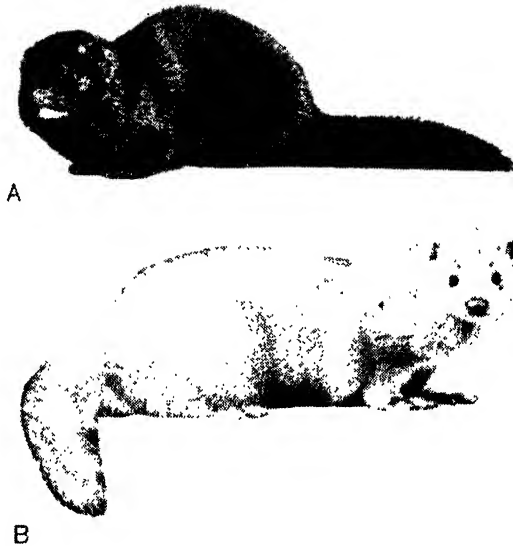

FIG. 124.—Wild-type mink (above), and platinum or silverblu mutation (below).
(From Smith *et al.*, in *Journal of Heredity*.)

to egg production have been obtained. Hays finds that early maturity, which is one mark of a good layer, is dependent on two dominant genes, one sex-linked, the other autosomal. Their effects are separate, and are cumulative if both are together. Pullets that lack both of these genes lay their first eggs at 250 to 300 days of age. Those with either the sex-linked or the autosomal gene, not both, mature at 190 to 200 days. But fowls with both of these genes begin laying at the age of 170 to 175 days.

An important influence against laying is broodiness, the periodic tendency of fowls to sit on their eggs; laying stops in such periods. In Rhode Island Reds about 57 per cent of the fowls become broody at

least once in their first year, 34 per cent not until the second year, and 9 per cent not until the third year. Broodiness is dependent on the action of two dominant complementary genes, which exert their control by regulating the rate of secretion of the broodiness-controlling hormone, prolactin, by the pituitary gland.

Size of eggs is to some extent inherited, but the mode of transmission is unknown. The evidence of heredity lies in the correlation between the size of eggs laid by mothers and by their daughters. In Rhode Island Reds the coefficient of correlation (see Appendix) in three different lines was 0.40, 0.47, and 0.53. These values indicate a moderate but unmistakable influence of heredity.

Mutations.—Part of the improvement of animal breeds starts with the discovery of new mutations. The mutant type may be immedi-

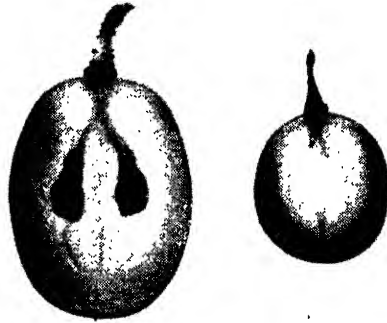

FIG. 125.—Emperor grape and its seedless mutation (right). (From Olmo in *Journal of Heredity*.)

ately of such value that it needs only to be made homozygous. One of the most valuable of these mutations is the silverblu mink, called also platinum (Fig. 124). This one is recessive and was of course homozygous when discovered. Other recessive mutations, also some dominants, have been found, and several recombinations of them have already been made. Thus koh-i-nur mink and blufrost have been combined to produce "dominant white," also blufrost with silverblu (platinum), and silverblu with pastel. Most of the mutations and the recombinations still need to be tested by the fancy of furriers and their customers.

In plants somatic mutations, genetic changes in some part of the plant itself instead of in the germ cells, are not uncommon. Because the altered part may be vegetatively reproduced (a method not available in animals), such mutations may be used to establish new varieties.

A seedless type of grape (Fig. 125) arose in this manner from the Emperor variety. Seedless grapes are smaller than their seedy progenitors, but are preferred by the trade.

Miscellaneous Qualities of Plants and Animals.—Aside from yield, every crop has other qualities, of which some are preferable to others. Sugar in melons has been found to depend on several genes; glucose and fructose are in the main dominant, sucrose mostly recessive. Long fiber in cotton, valued because of the strength it confers on cotton fabrics, is nearly dominant over short fiber in F_1 , but there is some variability in length of fiber in F_2 (Fig. 126), indicating that more than

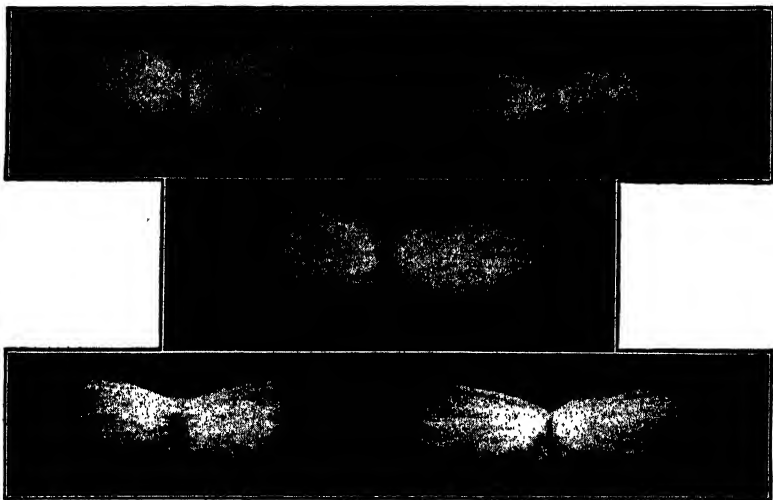

FIG. 126.—Inheritance of fiber length in cotton. Above, at left, short-fibered Holdon cotton; at right, long-fibered Pima. Center, the F_1 generation, with fibers nearly as long as the Pima. Below, extremes of length in F_2 generation. (Modified from Kearney in *Journal of Heredity*.)

one pair of genes is concerned. Yellow color of the flesh of peaches is dominant over the less desirable white. The sugar content of beets is different in different varieties, and it is partly inherited, since there has been some improvement of it through selection.

The polled (hornless) condition of cattle, valued as a contribution to safety, is dominant over horns. Color in horses, though not thoroughly understood, is inherited after a multiple-gene plan as in other mammals, with gray dominant or epistatic (page 113) to all others. Knowledge of this color scheme should aid in obtaining matched teams. A high percentage of butterfat increases the value of milk, and there seem to be one or more genes for this richness apart

from those for yield. High butterfat is in general recessive, or nearly so. One variety of bees produces honey rich in levulose, another variety honey with much dextrose. The levulose type appears to be dominant, for the F_1 generation of a cross produces levulose-rich honey, while a backcross of the F_1 to the dextrose type produces intermediate honey, presumably due to a mixture of the two types of workers. Most breeds of animals have association standards which breeders try to meet and which are distinct from productiveness. For the most part the inheritance of these arbitrarily favored characters is not understood, so that the problem of "improvement" is a continuing one.

Synthesis of Varieties.—Recombination of characters of a simple sort has been mentioned in connection with many useful qualities. Sometimes the desirable qualities are so numerous, and are "originally" found in so many different strains, that combining them into one variety becomes a far more ambitious project than the study of the mode of inheritance of each trait separately. Improvement of wheat and barley is an example, since there are a number of different "forms" of rust to which a good variety must be resistant, the yield must be high, the straw strong, the plant winter-hardy, and maturity early. It is a convenience in threshing to have no beard or awn, and it has been removed in some varieties. In barley Hayes found it undesirable to remove the awns because they were in some way correlated to yield; so he rendered them harmless by removing the barbs from them (Fig. 127) through hybridization.

In tobacco likewise new varieties have been made to order. A good variety must burn rather freely, leave a tenacious ash, and possess a good flavor. The wrapper leaves should have a delicate aroma and

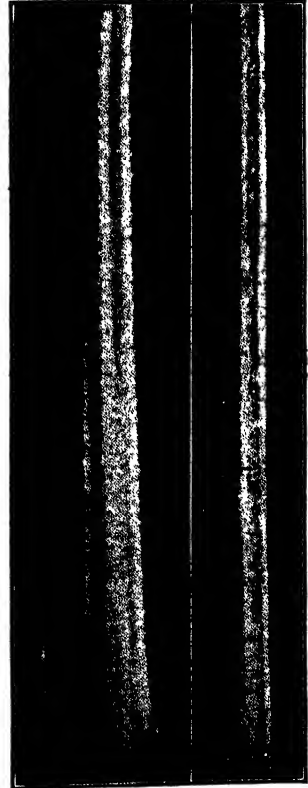

FIG. 127.—Barbed and smooth awns of barley; a seed with awn attached, portion of barbed awn of Manchuria variety, and portion of smooth awn from Lion variety. (From Hayes in *Journal of Heredity*.)

a uniform greenish-brown color, be lacking in coarse veins, and be thin, strong, elastic, and broadly rounded at the tip. The tobacco plant should mature quickly, have no lateral branches, produce many leaves per plant, resist disease, and stand up against wind and rain. Broadleaf has three of these qualities not found in Sumatra, and Sumatra has two of them not present in Broadleaf. Several others of the right characters are in both of them, and in three respects a variety intermediate between them would be better. East and Jones, by hybridizing Broadleaf and Sumatra and selecting for four or more

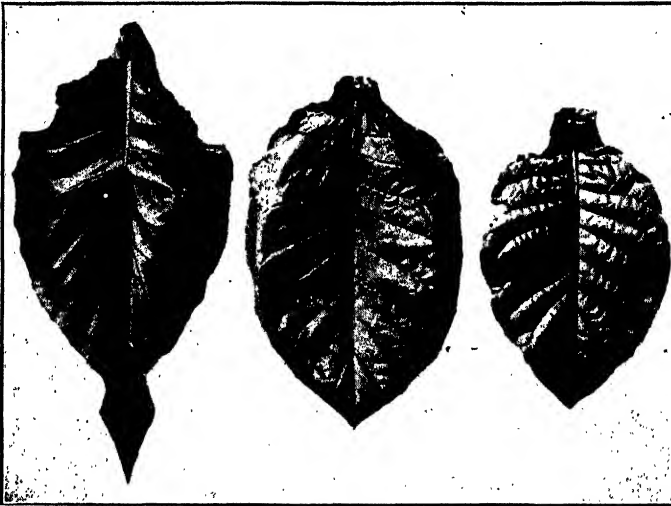

FIG. 128.—Production of a new tobacco variety by hybridization. Left, Broadleaf variety; right, Sumatra; middle, Round Tip, produced by crossing Broadleaf and Sumatra. (Reprinted by permission from Jones, *Genetics*, John Wiley & Sons, Inc.)

generations, produced Roundtip (Figs. 128 and 129), which is near the ideal.

In strawberries, hybridization between cultivated varieties and a wild type is found to involve winter hardiness, which is dominant over winterkilling; large fruit, which is dominant over small; many runners (dominant over few); early bloom (dominant over late); and early ripening (dominant over late).

Hybrid Vigor.—In certain organisms hybrids—at least some of them—possess a greater vigor than either of their parents. The counterpart of this phenomenon is that inbreeding results in a diminution of vigor. Corn is a particularly good illustration of both effects. Under field conditions the pollen, which is produced in the tassels at the tops of the plants, falls and is blown by the wind upon the silks

of the same plant and of neighboring plants at random. There is some inbreeding, therefore, and a good deal of cross-fertilization, but by human intervention either one may wholly replace the other.

If a strain of corn is self-pollinated, a number of generations in succession, it almost always becomes less healthy. Stalks become shorter and slenderer, the leaves have a paler color, and the ears are smaller. Since size of ears largely determines yield, the crop from successively self-pollinated corn becomes less and less.

Now, if two such weakened varieties are crossed, the F_1 plants raised from their hybrid seed are almost always much larger and healthier, as first shown by G. H. Shull. The ears of these F_1 plants

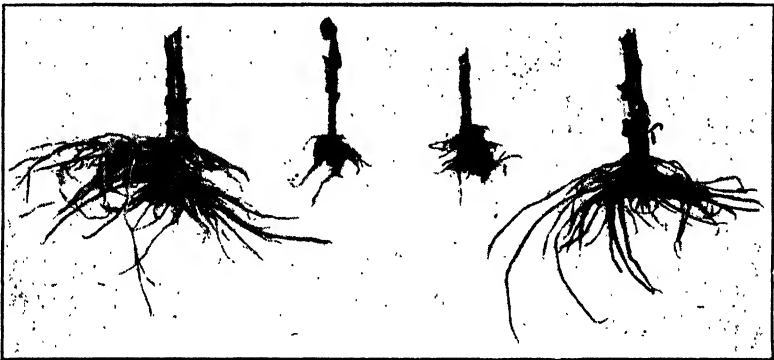

FIG. 129.—Resistance to root rot in tobacco. Roots of the Round Tip variety at left and right, those of Havana in the middle. (From East and Jones in *Journal of Heredity*.)

are considerably larger, and the yield is accordingly increased. The effect on both the plant and the yield is illustrated in Fig. 130. The two plants at the left below belong to two strains weakened by repeated self-pollination, and the corn in the two baskets at the left above is the yield obtained from them on a certain small area of ground. When these strains were crossed F_1 plants like the third one in the figure were produced, and the yield from the same amount of ground is shown in the third basket above. The yield is about three times that of either parent strain. If, however, the F_1 plants are self-pollinated and their offspring are self-pollinated, and so on, there begin at once a weakening of the plants and a diminution of the yield. Jones finds that the reduction in the size of plants stops at about five generations of self-pollination, and the reduction in yield at about 20 generations—though the bottom is *almost* reached much earlier.

Crossing of the strains for seed for farm production is done by

planting the strains in alternate rows, and detasseling one of them, thus destroying its pollen. The detasseled plants bear the hybrid grains, which are planted for the main crop the next spring. Probably three-fourths of the corn crop in the United States is produced from hybrid seed.

Barley crosses also show hybrid vigor. The F_1 generation in one test yielded 27 per cent more than the parents, but the F_2 generation



FIG. 130.—The effect of self-fertilization and cross-fertilization on vigor and yield in corn. (From Jones in *Conn. Agr. Exp. Sta., Bull. 266.*)

(from inbreeding) dropped back to a 24 per cent gain, the F_3 to 13 per cent.

Hybrid vigor has been observed in radishes, hemp, rye, wheat, cucumbers, and tomatoes, and in pigs, cattle, and sheep; but no organized attempt has been made to take advantage of it commercially in most of these.

Plant Patents.—One development in plant breeding hopefully designed to be of economic value is the system of plant patents in the United States. The originator of a new variety was to be given con-

trol of his product, with whatever financial advantage he could get from such control. From 1930, when the law was adopted, to 1944 a total of 612 patents had been granted, of which 299 were for roses, 151 for other ornamentals, and 137 for fruit or other agricultural products.

A defect of the plan is that it merely extends to plant varieties the operations of the patent laws designed to protect inventors of manufacturable devices. In obtaining a patent, the inventor is required to "disclose" the method by which his product is made so that others can reproduce it. Unfortunately, the "originator" of a new plant variety can seldom tell any one how to produce it anew. Usually he has merely observed a new thing to arise, has recognized its value, and has perpetuated it by asexual reproduction. If any one else "originated" the same thing, it would be accidental, not because he had followed any procedure outlined in a patent application. The kind of variety that a breeder could really originate would be a recombination of a number of traits through sexual reproduction. If an attempt were made to maintain such a variety by sexual reproduction, mutation and residual heterozygosis would eventually (perhaps soon) change the combination, and it would be questionable whether the variety was then still the thing that was patented.

A more workable scheme would be one that limited the patent to a line of descendants, by vegetative reproduction, from one specified ancestor. The only question that then could arise concerning alleged infringements would be whether the supposed infringing variety were thus descended. There would be no question whether it were genetically identical with the patented one—a question that could not usually be answered even by a geneticist, not to say a court of law.

A number of suits have been brought under the plant-patents law, but it would be difficult to say whether any originator had really been aided by the patent privilege.

Legal Applications.—Knowledge of heredity can sometimes be used to help settle legal questions. One of the first applications of this sort was made in Norway, where by law illegitimate children have the same right to the father's name and property as the legitimate children have. In the case in question a child born out of wedlock had brachydactylous hands and feet, while the mother and all her relatives were normal. The alleged father was brachydactylous, and no other man in the neighborhood had this character. He was accordingly adjudged guilty. Short fingers are too uncommon to figure in many lawsuits, but its very rarity enabled the court in this instance to fix the guilt upon a single individual. Had the character been a common abnormality, all that

the court could have decided from the facts of heredity would have been that the father was some brachydactylous person.

To be of frequent use in the courts, the inherited characters involved must be those in which many people differ from many others. Eye color would be excellent if it were a little less erratic in its expression. At the present time one of the most reliable characters is the blood group. Everyone belongs to one or another of four blood groups, the mode of inheritance is known (page 80), and the technique of determining the group is subject to few errors. If the blood group of a child and that of one of its parents are known, the blood of the other parent is limited to certain groups, as in the table below.

Blood group of child	Blood group of known parent	Blood group of unknown parent
O	O	O, A, or B
O	A	O, A, or B
O	B	O, A, or B
A	O	A or AB
A	A	O, A, B, or AB
A	B	A or AB
A	AB	O, A, B, or AB
B	O	B or AB
B	A	B or AB
B	B	O, A, B, or AB
B	AB	O, A, B, or AB
AB	A	B or AB
AB	B	A or AB
AB	AB	A, B, or AB

Although in a few instances an unknown father might belong to any of the groups, in some combinations of child and mother he would be limited to three of them and in a few of them to two of the groups (see last column of table). No man could in this way be proved to be the father of a given child without the aid of other evidence, but he could often be shown not to be the father. Thus, a man of blood group AB could not be the father of a child of blood group O no matter who the mother was (first three lines of the table), and a man of group A could not be the father of a child of group B if the mother were of group O (eighth line). The possibilities of the scheme are increased by the fact that agglutininogen A exists in three distinguishable forms (A_1 , A_2 , A_3)

and by the existence of other allelic series of blood agglutinogens. Wiener has estimated that, by the use of blood groups based on the ABO alleles, it would be feasible to decide about one-sixth of the cases of disputed paternity, while if the MN groups (page 81) be also included, about one-third of such cases could be settled. With more general knowledge of the Rh alleles (page 209), the proportion of cases that could be decided should be considerably increased.

Sometimes the problem is to decide which of two children might belong to a certain pair of parents. Instances of this sort have arisen in hospitals where babies could be inadvertently exchanged. A case of such exchange in a metropolitan hospital a few years ago was decided beyond doubt by determination of the blood groups. A similar question arises when a possible impostor claims to be the long-lost child of wealthy or titled parents, and the same possibility of an answer from the blood groups exists. In both of these situations the parents are known and the child is uncertain; or the child is known and both parents are uncertain. The possibilities open to the unknown child are shown in the following table.

Parents	Possible Children
O × O	O
O × A	O, A
O × B	O, B
O × AB	A, B
A × A	O, A
A × B	O, A, B, AB
A × AB	A, B, AB
B × B	O, B
B × AB	A, B, AB
AB × AB	A, B, AB

Eugenics.—The application of knowledge of heredity to improvement of the human race, referred to in the opening paragraph of this chapter, constitutes the science of eugenics. Because of its complicated nature, and because natural human interest necessitates a more extensive treatment, this subject is segregated in a separate chapter.

PROBLEMS

201. How can two investigators, without any mistakes in experiments or reasoning, reach different conclusions regarding the number of genes involved in some economic character?

202. Which of the practical applications of genetics do you think has done most to increase the food supply of man? Be specific, not general.

203. What various features of poultry do you think contribute to their annual egg production, either favorably or unfavorably?

204. In what circumstances is combination of valuable qualities in one variety more difficult than discovery of the mode of inheritance of each quality?

205. What would be the explanation of hybrid vigor if it should be found that a true-breeding race, as productive as the hybrid, could be established?

206. Hybrid vigor in corn was discovered in 1907. How do you account for the passage of decades before practical use of it was common?

207. Why is the plant-patents law of the United States unsatisfactory?

208. A man of blood group AB claims the estate of a recently deceased millionaire whose blood group is on record at the hospital as O, explaining that he was long estranged from his alleged father. What should be the conclusion of the court or jury trying his claim?

CHAPTER 24

EUGENICS

The name eugenics is given to the collective principles and procedures that lead, or would lead if used, to improvement of the human race. The word was coined by Sir Francis Galton (Fig. 131) in 1883, in his "Inquiry Into Human Faculty and Its Development," and means literally good (or true) birth (or origin). Any theories or actions that look toward the reduction or elimination of human defects, or the increase of desirable qualities, are thus part of the science of eugenics or of the eugenics movement.

Individual Décisions.—Much of what may be done to improve man's traits must probably always depend on voluntary actions of individuals. It is reasonable to suppose that right-minded people will not wish to visit any serious handicaps upon future generations. This should be especially true when prevention can be accomplished without greatly disturbing the physiological and emotional outlets of those who have to make the decisions.

If a young couple produce a child afflicted with amaurotic idiocy (page 219), they probably learn for the first time that both of them are heterozygous for this grievous defect. Naturally they do not wish other children of the same kind. It is possible to compute (see below) the chance that they will have such children if their family is continued. There is still greater chance that any further children, although normal, would carry the gene along, ready to come to expression whenever there is a union of two heterozygotes. The decision as to what to do must be made by these parents.

A rarer condition which creates the same problem is phenylketonuria (page 218), a defect of both kidneys and mind, which is recessive. The chief difference between it and amaurotic idiocy, as a eugenic problem, is its comparative rarity; there would be less risk, in later generations, of the union of two heterozygotes. Yet the gene would be present, and would constitute a danger, particularly in generations so late that the occurrence of the trait in the ancestry was no longer on record or in the traditions of the family.

Sometimes a defect is physical, and of a sort that can be surgically

corrected. Harelip and cleft palate, already described (page 199), belong in this category. Early correction of this defect should of course be made in every case; but parents should understand that, as in other acquired characters, somatic correction does not change the genes. Later generations are likely to have the same problem to solve.

If the unwanted character is dominant, the predictions are simpler. If dominance is complete and regular, it is usually possible to say whether the affected person is heterozygous or homozygous. For the rather uncommon dominant characters, such a person almost always is heterozygous. A fortunate feature of such characters is that persons



FIG. 131.—Francis Galton. (From Galton, *Memories of My Life*, Methuen and Co.)

free from them are likewise free from the gene. A normal person cannot transmit a dominant mutation, no matter how many of his relatives had it. Such certainty exists, of course, only if the character is really dominant; any irregularity of dominance introduces uncertainty. Such regularly dominant characters include a number of those in which bone growth is restricted. If all people having lobster claw, for example, were to refrain from producing children, the gene for that character could be eliminated from the population in one generation—except as it arose by mutation, which undoubtedly occurs.

Basis of Judgment.—For various reasons, parents who must make the decision to limit their family should do so after a study of their own situation. Very few human defects are so uniformly expressed that they may invariably be recognized for what they are; many of them are

clinically similar to something else, which may be genetically very different. A careful diagnosis by a competent physician is usually required, and even this is not always certain. Two human traits that physicians would judge the same are sometimes inherited differently. Numerous examples of the uncertainty of the mode of inheritance in man were indicated in the chapters on human heredity. It is not safe, therefore, even after diagnosis, to accept the published facts and conclusions regarding the inheritance of the supposed character in question. It is far better to study the family histories of the parents who are obliged to decide their momentous question. Any decision should, if possible, be made after both diagnostic and genetic study.

Calculating the Risks.—Even after the necessary studies are made, parents are seldom faced with the certainty that the dreaded character will appear in any of their children. Usually there is only a fractional chance that it will do so. What are the rules relating to this chance?

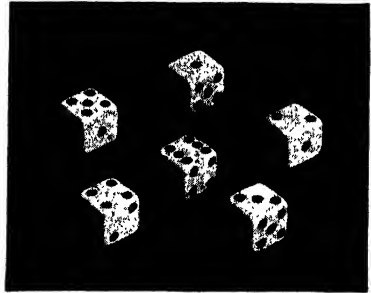

FIG. 132.—The six possible positions of dice. If the cubes are perfect, each position should occur as frequently as any of the others in a large number of throws.

When dice are thrown, each die may turn up in any one of six ways (Fig. 132). If the dice are perfect, the chance of any particular number coming out on top is one in six, or one-sixth. The likelihood that another die will turn up this same number is also one-sixth. Now, if two dice are thrown simultaneously, the chance that both will show the number four is $\frac{1}{6} \times \frac{1}{6}$, or $\frac{1}{36}$. Any other specified combination of numbers, for example, four on the first and two on the second, would have 1 chance in 36 of being realized. If three differently colored dice are thrown, the chance that any particular combination of numbers, such as two on the red one, six on the blue, and one on the green, will appear is $\frac{1}{6} \times \frac{1}{6} \times \frac{1}{6}$, or $\frac{1}{216}$. The probability of any designated combination of several independent events is always the product of their individual probabilities. These are the laws of chance.

How does this affect the decisions of parents regarding a possible limitation of their families? Or the question raised may be whether a given individual should marry. The discussion will be based on the assumption that the latter is the question raised. Suppose that the defect which it is desired to avoid perpetuating is some form of feeble-mindedness and that the study advocated in the preceding sec-

tion indicates that it is a simple recessive. The known family history is that shown in Fig. 133, and the subject of inquiry is the man numbered 3. It is desired to know what chance he has of carrying the feeble-minded gene (*f*). Now, the fact that No. 2 is feeble-minded shows, under the assumption that this defect is a simple recessive, that both parents are heterozygotes. Consequently, their phenotypically

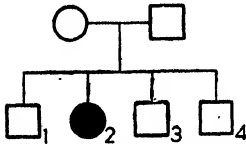

FIG. 133.—Family history illustrating chance. The blackened individual is feeble-minded. What is the probability that her brothers are heterozygous for this defect?

normal children will be of two genotypes: $\frac{1}{3}$ of them ($\frac{1}{4}$ of the whole family) should be homozygous normals (*FF*) while $\frac{2}{3}$ of them (half of the whole family) should be heterozygous normals (*Ff*). Number 3, like each of his brothers, has therefore two chances in three of carrying the feeble-minded gene.

Perhaps the policy to be decided is whether cousins should marry. The general family to which they belong has produced an occasional individual possessing a recessive trait which it is not desirable to pass on. What is the chance that the cousins would have a child burdened with it? A concrete problem is presented in Fig. 134, in which the unfortunate recessive persons are shown in black. Individuals III-3 and III-6 contemplate marriage. Though they are normal, may not a child of theirs exhibit the character they fear?

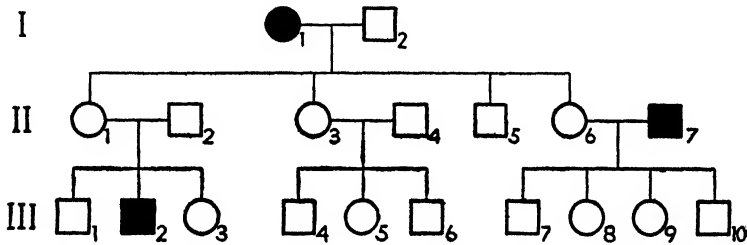

FIG. 134.—Family history illustrating chance. The blackened individuals exhibit an undesirable recessive character. What risk of transmitting this character would inhere in cousin marriages within the last generation?

In answering this question, it is first to be noted that, in order that any of their children might be homozygous recessives, both III-3 and III-6 must be heterozygotes. One must decide first, therefore, what their chances of being heterozygous are. Consider III-3 first. One of her brothers is recessive; hence, their parents (II-1 and II-2) must both be heterozygous. Any normal child of II-1 and II-2 has in consequence

two chances in three (a $\frac{2}{3}$ chance) of being heterozygous, as was just explained for feeble-mindedness in a similar situation. The probability that III-3 is heterozygous is thus $\frac{2}{3}$. Turn now to III-6. It is known that his mother (II-3) is heterozygous for she had a recessive mother; no chance is involved in this feature of the family history. Her husband (II-4) we will assume is a homozygous normal, because his family history has been examined and no relatives found to possess the character in question. With these parents, II-6 has therefore a $\frac{1}{2}$ chance of being heterozygous.

Since III-3 has a $\frac{2}{3}$ chance of being heterozygous and III-6 has a $\frac{1}{2}$ chance of being heterozygous, the chance that *both* of them are heterozygous is $\frac{2}{3} \times \frac{1}{2}$, or $\frac{1}{3}$. There is thus one chance in three that both of the cousins contemplating marriage are heterozygous. Now, when both parents are heterozygous, any child of theirs has a $\frac{1}{4}$ chance of exhibiting the recessive character. Inasmuch as the chance that both parents are heterozygous is $\frac{1}{3}$, the chance that any given child of theirs will be recessive is $\frac{1}{3} \times \frac{1}{4}$, or $\frac{1}{12}$. Each child they produce has 1 chance in 12 of showing the undesirable quality. If they have a family of 4, there are 4 chances in 12 that one child will be recessive.

For drill, the student is encouraged to determine what chance a child of III-5 and III-7 would have of being recessive. To verify his solution, the answer may be given as 1 in 8.

What weight is to be assigned to the ascertained chances in a specific situation is necessarily left to those responsible for deciding.

Modified Probabilities.—Sometimes the calculable chances are combined with events that may not be random or whose single probabilities can be determined only empirically. An important eugenic problem of this sort is that raised by the rhesus factor of the blood cells (pages 208 and 218). This Rh factor exists in a number of allelic forms which, in the aggregate, are found in about 87 per cent of white people in the United States; the other 13 per cent lack it altogether, their genotype being *rhrh*. Now, under these circumstances, with random marriages among the blood types, about 11 per cent of all couples should consist of an Rh- woman (*rhrh*) and an Rh+ man. Many of the children of such parents will, of course, be Rh+. Unfortunately, the blood of an Rh+ fetus may sometimes seep through the placenta to the mother's blood, which, if she is Rh-, at once begins to react by producing antibodies. These antibodies may then seep back into the fetal circulation where the Rh antigens are. The antibodies tend to destroy the red cells of the fetal blood, and the result is

anemia, jaundice, lowered oxygen supply, and frequently stillbirth. The pathological condition is known as erythroblastosis.

If every Rh+ fetus in an Rh- mother suffered this fate, certainly no Rh- woman should marry an Rh+ man. Fortunately only about one-sixteenth of such fetuses actually develop erythroblastosis. The reasons for this lower frequency may be several. It takes some time for antibodies to develop in the mother, so that first-born children usually escape. Also, seepage of the Rh antigens may be slow, or perhaps not occur at all, in some women. Finally, some of the returning antibodies may produce other effects than erythroblastosis. Mention has already been made of the unexpectedly greater frequency of feeble-mindedness in Rh+ children of Rh- mothers (page 218). It has been suggested that the returning antibodies, perhaps through lowered oxygen supply, may affect the development of the brain and hence of normal mentality.

The predictions that one could make regarding the dangers of marriages of Rh- women and Rh+ men are thus not of the mathematical sort which are possible when all the contributing factors are known. With the possibility of feeble-mindedness, and even with the lower than expected frequency of erythroblastosis, an Rh- woman should at least know the Rh character of the man she marries. Whether she should refuse such a marriage probably only she and her prospective husband should decide.

Public Policy.—In all the preceding situations it has been assumed that the decisions regarding marriage or rearing families will be made by people who are capable of forming sound judgments. That assumption is not well founded when the undesirable character is one which affects the mentality and *may* not be well founded with respect to purely physical traits. What, if anything, is to be done when individual judgment is unreliable is a matter of public policy. Society as a whole must decide. The call for social control is especially obvious with respect to feeble-mindedness because the afflicted persons are not only incapable of sound judgment but are often particularly prolific. Such control may be warranted when the defect constitutes a heavy economic burden on the whole population and when individual responsibility is plainly not producing the desired result. It is worth while to examine these situations.

The Public Burden.—Let us see how great a burden the more important human defects are. The best estimates of the frequency of feeble-mindedness for various regions, most of them in the United States, range from 1 in 294 to 1 in 138. In Indiana, 2.1 per cent of the

population of 10 counties is said to be mentally deficient. That the number is not decreasing is indicated by cases like the following. One feeble-minded woman had 11 illegitimate children; one of her daughters, also feeble-minded, had 8 illegitimate children, 7 of them feeble-minded; and one of these 7 has had 4 illegitimate children. All told, the first of these 3 women had 56 direct descendants, 31 of them feeble-minded, 18 of them having been in institutions. Four generations of the feeble-minded have been found in one institution at the same time, all living at state expense. One Iowa county maintained one family as a dependent group for 38 years, and in that time 10 of their 15 children were born. This county had on record 1720 dependents, of whom 424 were convicted of major criminal offenses. Of the 226 who were given mental tests, 188 were found to be deficient. Public agencies are actually helping to increase the burden they were created to bear. In the United States as a whole, according to an estimate by a White House Conference, 2 per cent of the population is definitely feeble-minded. It is estimated there are 6,000,000 in the United States who have been, are now, or will sometime be legally committed as insane to state institutions. If epilepsy is as prevalent everywhere as in the states where epileptics have been carefully estimated, there are 150,000 of its victims, only part of them in institutions. One might add to these the paupers and petty criminals, though many, perhaps most, of these would fall also in one of the previously mentioned classes.

We are not at present considering those at the opposite end of the scale of human capacity, the leaders in every field—art, science, literature, religion, government, invention, education, and business. The policy under discussion relates only to the possibility of reducing the defectives.

A Public Eugenics Program.—What is to be done to better the situation just described? The answer to this question constitutes a major part of any eugenics program. The first feature of such a program should be research. The need of more accurate knowledge of the mode of inheritance of human characteristics, particularly those which throw a burden on society, is a prime consideration. No public action can have the best results unless it is based on rather accurate knowledge of the heredity involved. At the present time we have too little or too inaccurate information about most of the defects whose reduction is sought. Then, to carry out any plan, there must be public support. Education regarding heredity and the means of guiding human trends must be widespread. Experience in the United States

has shown that corrective movements, however laudable in their aims, do not succeed unless people in general feel that they are essential.

To whatever extent the necessary knowledge and public understanding are attained, to that extent legislative action may perhaps be instituted. Only the most grievous of the human defects have any chance of being controlled by law at present, largely because of the meagerness of public support. Such support should grow, however, and in time legal measures could have some effect.

Human nature being what it is, the restriction of reproduction by those whose heredity is unsatisfactory is certain to be most complete if it does not rest on frequent decisions which must usually be made under the stress of strong emotions. Also, restriction is not likely to occur so long as those making the decisions are incapable of forming sound judgments. To render the preventive action more certain, defective individuals, or those who run some risk of transmitting undesirable qualities, may be sterilized. This opportunity should be open to any one on a voluntary basis, and may be provided by law for certain others.

The Sterilization Operation.—There is much common misunderstanding concerning the nature of sterilization. It leaves the sexual emotions unaltered, and reproductive processes remain with the exception of the actual production of children. The operation is in no sense a "mutilation." In the male it consists of a severance of the duct which carries away the sperm cells, which is a rather simple operation. In the female it involves severing the oviduct, and that requires opening the abdomen. In both sexes the gonads (testes and ovaries) remain, and in them are still produced the hormones that produce the sexual emotions and guide the sexual behavior. Sterilization has often been reported, by physicians, to have a beneficial effect on the general physiology and mental state of the person who has experienced it. The improved mental state might well stem from the absence of any fear that a defective family will be produced. It seems likely, therefore, that a therapeutic advantage to the present generation must be added to the eugenic advantage of future generations, in assessing the value of sterilization.

Legal Sterilization.—Official sterilization in the United States began, with the patient's consent, in 1899. Indiana was the first state to adopt a law providing for compulsory sterilization under certain conditions. That was in the year 1907. Thirty states, up to January 1, 1947, had sterilization laws on the books, the latest addition being Georgia in 1937. Two Canadian provinces have made similar

provision. Tests of these laws in the courts have been made and some of them have been nullified; but usually modified laws were enacted later. Some of the nullifications were based on the constitutional ban on class legislation, in that only the inmates of institutions were made subject to the law. The Supreme Court of the United States has, however, declared this objection invalid. In the state where the largest number of sterilization operations have been performed (California) only inmates of institutions are affected. Another reason assigned for nullification has been that the laws read as if the sterilized person were being punished; where the law made clear that no punishment is involved, that sterilization aims only at improvement of heredity, it has been sustained.

While California has performed the largest number of sterilizations, Delaware has performed the most in proportion to her population. On the basis of absolute numbers, the first five states are California, Virginia, Kansas, Michigan, and Minnesota; based on percentages of their populations, the first five are Delaware, California, Kansas, Oregon, and Virginia. Probably a larger proportion of operations than any of the above are performed in Hawaii, which has no law. In general, the laws are being observed, since operations were performed in 22 of the 30 states in 1945. In 12 states the operations are ordered only for the feeble-minded and insane, in three only for the feeble-minded, and in one (Arizona) only for the insane.

Some time will be required to demonstrate any improvement as a result of sterilization, partly because the number of feeble-minded is increased by other factors, including mutation. The reported decline in the frequency of feeble-mindedness in South Dakota from 64 per hundred thousand in 1916 to 31 per hundred thousand in 1926, though sometimes called a result of the sterilization program, must presumably be due to something else, at least in part.

Elimination of Recessive Defects Not Possible.—Objections to the sterilization program have sometimes been raised on the ground that defectives cannot be eliminated and that the reduction in their numbers is too slow to be worth the effort. The first of these reasons is well founded for any recessive character; only homozygotes could be removed even by the most rigid scheme, leaving numerous heterozygotes by whom homozygotes would continue to be produced. The second reason has, however, sometimes been made to appear more significant than it is. If, for example, 1 per cent of any population is feeble-minded at the beginning of a corrective program in which all feeble-minded were to be sterilized, it would require 22 generations to

reduce the feeble-minded to one-tenth of 1 per cent. Were that reduction spread evenly over the 22 generations, the improvement would be discouragingly slow. But it is not a uniform decline. In the first generation there should be a 17 per cent reduction, in the next generation 13 per cent more, and in the third generation an additional 10 per cent.

The above computations are based on the assumption that feeble-mindedness is strictly recessive. If it should show any fractional dominance, so that heterozygotes would sometimes be adjudged subject to the law, the rate of reduction would be correspondingly higher.

Increasing the Superior.—Reduction in the number of defectives, which is contemplated in most of the measures so far discussed and which may be called the negative part of the eugenics program, does not add anything to the higher levels of human value. Though the average is raised by eliminating the worst, the best is no better than it was before.

Many measures have been proposed for preserving and if possible increasing this superior class. The first problem is to recognize it, for superior people often spring from parents who by ordinary standards were not in any way remarkable, and mediocre offspring often come from very gifted parents. Pearl points out that very few of the people who attained such eminence as to receive a page or more of biography in the *Encyclopaedia Britannica* had parents who were in any way distinguished. He states that if during the past 2000 or 3000 years breeding had been restricted to those who were eminent, 95 per cent of the great people who existed in that time would never have been born. Such criticisms merely mean that we have not yet discovered the really applicable criteria of superiority. So long as human traits of different values are inherited, and people differ from one another in their genotypes, there are bound to be superior and inferior classes.

When superiority can be detected without too many errors, how shall it be increased? Deliberate control of matings by constituted authority is not possible in a democratic society, though it was once attempted through a voluntary renunciation of individual rights. This attempt was made in the Oneida Community, which was founded in Vermont in 1841 and moved to New York in 1848. The control referred to extended from 1868 to 1879. During this period a group of young men and young women placed themselves at the disposal of the founder of the community, to arrange whatever marriages he deemed desirable. The control was exercised part of the time by the leaders of the community, part of the time by a special committee.

Couples desiring to marry made application to this central authority, which rejected about 17 per cent of the applications. Other marriages (about one-fourth of the whole number) were arranged on the initiative of the committee. To these controlled unions there were born 58 children. They showed a better than average longevity; only two of them had any mental deficiency, and these could have been attributed to injury. On the whole, their qualities indicated that the control had not been badly administered.

Differential Birth Rate.—In other communities the choice of mates must usually be voluntary, and the problem of increasing the superior classes resolves itself into a question of proper birth rates. A century ago the economically successful types, which may be roughly identified with the superior classes, had the larger families. There was little limitation of families then. The landed gentry of Great Britain, for example, then had families of 7.1 children. Fifty years later, however, the average number had dropped to 3.1 per fertile marriage. All other available statistics show similar comparisons—a high birth rate for the successful classes, which fell over a period of decades to a moderate or low rate. If all birth rates had fallen proportionately the decline would affect only the population problem (see Chap. 25), not the eugenic situation. But the birth rate of the inferior classes remained high. Later a decline set in for the lower classes also, but so far it has not equaled that for the upper groups.

There are minor reversals of the contrast between economic classes. Yale graduates of several classes graduating in the nineties were graded by their colleagues as to their value to humanity, and it was found that those rated high had on the average larger families than those rated low. Similar results were obtained from a study of Harvard graduates, and for those included in "Who's Who in America." Certain colleges can even boast a birth rate among their graduates that is about as high as that of the population as a whole, or a rate among their superior graduates which is higher than that of those who barely passed. While these differences are favorable ones, they do not count heavily in the total birth rate, for all of them belong to a class that is not maintaining itself. They are favorable items in a much larger unfavorable situation.

Net Reproductive Rate.—Offsetting or abetting the changes that have taken place in the birth rate of different classes are changes in the death rate. The total death rate has declined to such an extent in the United States that since 1900 sixteen years was added to the average expectation of life. This extension of life, if it affected the different

classes unequally, as it has done, might upset all calculations based on relative birth rates alone. No startling modification of the conclusions is necessary, however, when birth rates and death rates are balanced to obtain what may be called the net reproductive rate. Computations of this net rate show that the professional, business, and clerical classes are not maintaining themselves, while labor and farmers are more than holding their own. To what extent eugenics is involved in this contrast cannot be said without detailed explanation. There are many families in the laboring and agricultural classes that are eugenically sound; yet there are enough low-grade families in them to reduce their *average* below that of, say, the professional classes. This statement makes unpleasant reading for some who cannot distinguish individuals from averages, but every comprehensive study which bears on the question indicates that it is correct. The low birth rate of the professional, business, and clerical classes is a phenomenon of major concern.

Proposed Methods of Positive Eugenics.—To secure larger families from the classes with greater native ability, several concrete proposals have been made. It must be recognized that the more intelligent groups can never be induced to compete for numbers of children with the lower classes. If some increase in their families can be effected, however, that is a worth-while gain. Education is first of all necessary, because in the present state of popular information on the subject nothing more effective can be made to succeed. Education as to the needs of the race might in some families lead to voluntary effort to raise the birth rate; but the chief hope from education is that it will lead to democratic support for other steps.

One suggested other step originated with Francis Galton, who proposed that promising young couples be provided good houses at low rentals.

Another proposal is that the income of a family meeting certain requirements be increased at the birth of each child. To avoid prejudicial treatment such increase would probably have to be borne, not by individual employers, but by the industry as a whole. The general effect of such a plan would probably be to lower the wages of single and childless workers, so that the total cost to the industry would be about the same. Missionaries of some churches receive such a family allowance, and their families are considerably larger than those of other ministers of the same denominations.

A system of loans to young couples (canceled in part on the birth of children) has been proposed, and even put into effect in the past in

certain countries; but unless the hereditary qualities are taken into account this would scarcely be a eugenic procedure.

The outlook for putting any of these plans into effect is not bright. Holmes in a thoughtful and conservative appraisal of the prospects of positive eugenics points out that people are not now interested in improving the hereditary qualities of the human breed. They know little about heredity and have little appreciation of the importance of hereditary distinctions among men. To remove this ignorance and improve the understanding of what is at stake is the first task.

PROBLEMS

209. Why should parents, in considering the risk of transmitting some objectionable character, study their own family histories thoroughly in addition to ascertaining from the literature what is already known of the heredity of that character?

210. Why in casting dice does a pair of fives have 1 chance in 36 of turning up, while a three and a five have 1 chance in 18?

211. If in the family history shown in Fig. 134 the man II-2 had come from a family known to have included some members who exhibited the recessive character indicated by the black symbols, how would that fact affect the chance that III-3 and III-6 would produce a child with the recessive character?

212. If in Fig. 134 II-2 in a second marriage were to marry III-5, what chance would their first child have of showing the recessive character possessed by III-2 and others?

213. What distinguishes the situations in which individual judgments on eugenic questions should suffice from those in which public regulation is required?

214. What unfounded objections are sometimes urged against sterilization of defective persons?

215. Which of the proposed measures of "positive eugenics" do you think might improve human quality, and which ones merely increase size of families?

216. Is it advantageous, eugenically, to have the knowledge of birth-control measures continue to spread to the less intelligent classes of society?

217. What factors must be considered in determining how many children must be born to a pair of parents in order to maintain the class to which they belong?

CHAPTER 25

THE POPULATION PROBLEM

While from a eugenic standpoint it is the quality of the human race which is of prime importance, there are many respects in which its mere numbers are of considerable significance. The problems raised by growth, decline, or changing age distribution of a population are not only biological but, to an even greater extent, economic, political, and social. The population problem has been in a sense before the public ever since Malthus published his "Essay on Population" in 1798; in recent decades it has become a matter of serious concern.

Growth of an organism typically follows a well-recognized curve. It rises slowly at first, but with increasing speed, since the absolute increase in size in any period tends to be always about the same percentage of the size in the preceding period. This is true only of the early growth. After attaining a maximum rate of increase, the organism grows more slowly. While it still grows, the rate of growth declines. Finally the rate of increase reaches zero, and growth stops. The curve representing such growth is sigmoid in form, concave upward in the first part, concave downward later.

Pearl demonstrated a similar growth curve for a population of flies. A few flies were put into a bottle with suitable food, and were allowed to reproduce. Their offspring progressively became adult, and they too reproduced. A census of the population was taken every few days. When the experiment was finished, in a couple of months, he plotted the population against time, smoothed the irregularities by certain mathematical procedures, and obtained the curve shown in Fig. 135. It is very similar to that of a growing animal. Presumably other populations would follow such a growth curve if the conditions under which they live were determined by the population itself and the natural changes of things with which they are permanently associated. Rate of growth could be modified by factors introduced irregularly from extraneous sources, but if these influences were not too great, the expected sigmoid growth curve would still be recognizable.

Statistics of countries in which censuses had been taken over long enough periods were then examined, and Pearl believed they showed a

general confirmation of the conclusion that growth of populations follows in general the rules of growth of individuals. He could at the same time see that there were irregularities, some of which had obvious explanations. As demographic studies have advanced, the irregularities and their sources have proved numerous enough and serious enough to make the use of these long-time curves hazardous. Nevertheless, the principles at the bottom of such graphs are recognized as valid, and are often applied to shorter periods with considerable success.

The value of such fractional curves as may be devised is that they may be projected into the future. It is possible to predict—always

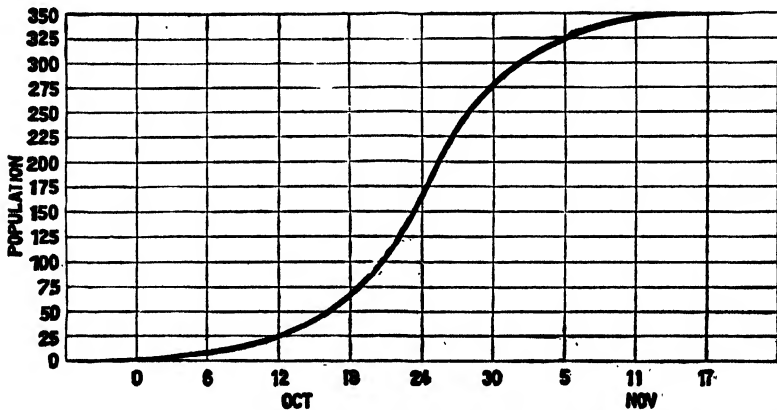

FIG. 135.—Increase in population of vinegar flies in a "universe" of limited size. (Modified from Pearl.)

on certain assumptions—how large a population is likely to be at some specified time not too far ahead. Many matters of public policy can be based on such predictions.

The elements that enter into the size of a human population are primarily the birth rate, the death rate, the sex ratio, and the age distribution. The extraneous and less predictable factors are such things as war and industrial and agricultural revolution.

Population Growth.—As an indication of the changes which require explanation and the bases on which prediction for the future may rest, it will be useful to record some of the facts of past growth of populations. The population of the world in 1850 is estimated to have been somewhat over a billion. By 1940 it had just about doubled. During that period Asia's share of the earth's people had dropped from about 61 per cent to 53 per cent. Europe's share rose from 24 to

26 per cent, and North America's rose from about 3.5 to nearly 9 per cent. Some of these figures belie popular notions.

For the United States a statement covering a longer period will be useful. From 1790 to 1820 the gain was nearly 150 per cent, and another such increase was realized by 1850. But in the 30 years from 1850 to 1880 the gain was only 116 per cent, from 1880 to 1910 only 80 per cent, from 1910 to 1940 only 43 per cent. Of this last gain only about 9 per cent belongs to the decade of 1930 to 1940. Population increase has slowed down very markedly over the century and a half.

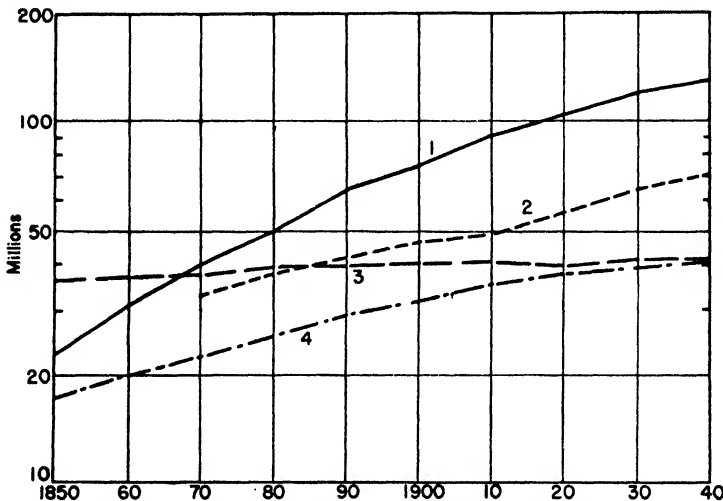

FIG. 136.—Population growth of selected countries. In interpreting populations, note the graded vertical spacing characteristic of semilogarithmic graphs. Curve 1, United States; 2, Japan; 3, France; 4, England and Wales.

In western Europe the growth was slower. England and Wales slightly more than doubled from 1850 to 1940, and France increased only about 15 per cent in the same period (Fig. 136). Almost none of France's increase has been realized since 1900. For Europe as a whole, the recent gains are more largely those of the southern and eastern countries.

Japan had about 32 millions in 1870 and about 70 millions in 1940 (Fig. 136). The pattern of growth, that is, the successive rates of increase, of Japan has been nearly the same as that of the western European countries, but has lagged behind the latter by, say, 30 years; the rate of change in Japan from 1910 to 1940 was about the same as the British rate from 1880 to 1910.

India, one of the storm centers of population problems, has had a more fluctuating increase than most countries. This irregularity arises from her periodic famines—famines so terrible that no amount of possible aid from outside can prevent the loss of millions of lives. At her first census in 1872, after allowance for errors and subsequent changes of boundaries, India's population was about 257 millions. In the first half century after that she increased about 19 per cent, in the next 20 years about 27 per cent. This latter rate is very high, as compared with other lands, and constitutes one of India's great dangers—as well as one of the world's great dangers. India has had a strong government which provided relief; it will be of some concern to note whether, when India governs herself, she passes her famines with losses no greater than in the past.

China's population growth has been the subject of many ominous conjectures. They are really conjectures, for little is definitely known. The estimates tend toward what might be called potential population, and the potentialities probably have not been, and will not be, realized. The reason for the lag behind the potentialities is the weakness of the government which cannot organize relief. While a strong government might enable China to increase the 10 to 15 per cent each decade which predictions call for, it is not likely that she has done so in the past.

Birth Rate.—What is known as the crude birth rate is the number of births per thousand of the population per year. This is often the only measure readily available, hence it is often used; but it is not a very good measure because it does not take into account the sex ratio or the age groups of the population. A measure that does take these factors into account is the number of births per thousand married women of child-bearing age, say 15 to 45 years. Either of these rates, as recorded, may be in error because of incomplete registrations, and allowance must be made for this fault whenever there is any basis for estimating it.

The birth rate has long shown a strong tendency to decline in most countries where records have been kept. This decline is of importance to the general economy, to war, and to such matters of public policy as immigration. In Fig. 137 are shown the birth rates of certain countries that have been allies or enemies of the United States or sources of immigration to this country. Their rates have, with one exception, declined through most of the period shown; the exception, Japan, joined the procession late. Rumania and Italy are rather typical of the states of southern and eastern Europe, from which

region the United States began to receive greatly increased numbers of immigrants after 1880. The birth rate of Russia, which is of more importance to the world, is not well enough known to include in the diagram, but almost certainly it was well above 40, even up to the time of the Second World War. In general the birth rates of the East are high, as those of the West were a number of decades ago. Whether the rates of Russia and the Orient will decline after the pattern of western Europe and North America is uncertain; but at least they are

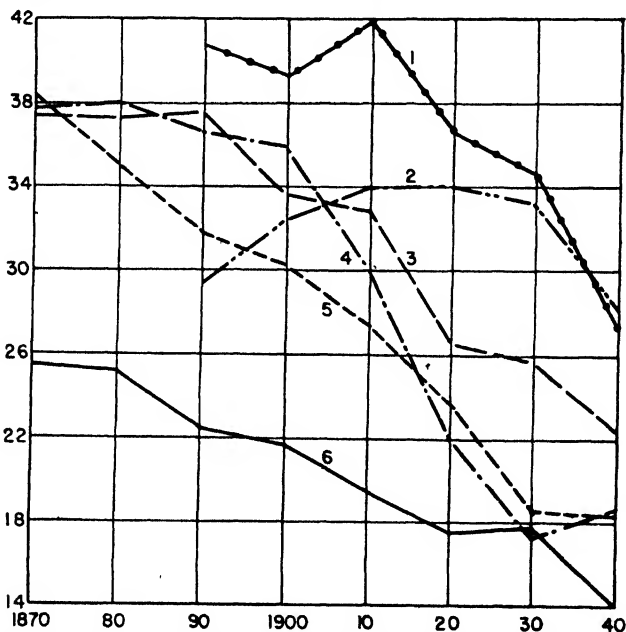

FIG. 137.—The crude birth rate of selected countries in recent decades. Curve 1, Rumania; 2, Japan; 3, Italy; 4, Germany; 5, United States; 6, France. Each 10-year value is the mean of a group of years.

lagging behind in that decline, and population will increase much more in the East than in the West in the next few decades.

A small increase in the birth rate in one year must not at once be assumed to be a reversal of this downward trend. In the depression following 1930 there was an accentuated decline of the birth rate in the United States, culminating in 1933. Then in the following year the rate rose slightly. This change was probably only a shift of births from one time to another, not a change in the total number. Birth rates decline in hard times. Then as economic conditions improve a little, they rise. Births that might well have occurred in 1932 or

1933 were merely postponed. Thus the depression would account for both the low point of 1933 (making it lower) and the rise in 1934. The secular trend may not have changed at all.

Differential Rates within a Population.—Some striking differences in the birth rates of classes within the same population have long been known. One of the most easily observed of these contrasts is the lower birth rate of cities as compared with that of rural areas. The comparison can be most significantly made by means of the *replacement index*. When the death rate by ages for a given class is known, it is possible to compute how high the birth rate must be just to maintain that class in its present numbers. If the birth rate is just high enough to maintain it, the replacement index of that class is 1.00.

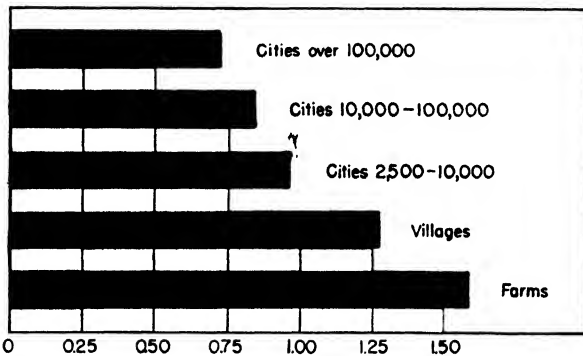

FIG. 138.—Replacement indices of farm, village, and city populations in the United States in 1940.

With indices higher than 1.00, the class gains, or it contributes to other classes; with indices lower than 1.00, the class loses or must be recruited from others.

The urban-rural contrast in the United States is illustrated in Fig. 138. It should be noted that in the United States census the rural class includes villages up to a population of 2500. In the diagram the farmers are separated from the villagers. Of all these communities only the rural ones are keeping up their potential numbers; the cities are all falling behind, the larger ones more rapidly than the smaller. Among the large cities, New York has a replacement index of 0.65, San Francisco 0.55, both well below that of cities in general.

Since the farm population is not increasing, it is obvious that there is a movement from farm to city. There are, of course, movements in both directions, which fluctuate with the economic state of the nation. In depressions the movement from city to farm has increased;

in booms it is diminished. But as a secular phenomenon, the net movement is toward the cities. It has been so for a long time, as shown in Fig. 139. The number of people in agriculture has declined steadily. The diagram stops at 1930, but an extension to 1940 would show no important change. How the war affected it is only imperfectly known, but that effect would be only temporary. The decline in farm population has accompanied the mechanization of agriculture, the improvement of cultural practices (fertilizers, rotation, soil conservation), and the creation of improved breeds, hybrid corn, etc.

Another differential within a population is that between the economic classes, also between racial classes, though the latter often cannot be separated from the former. One study showed that in the United States the number of births per thousand white wives of ages

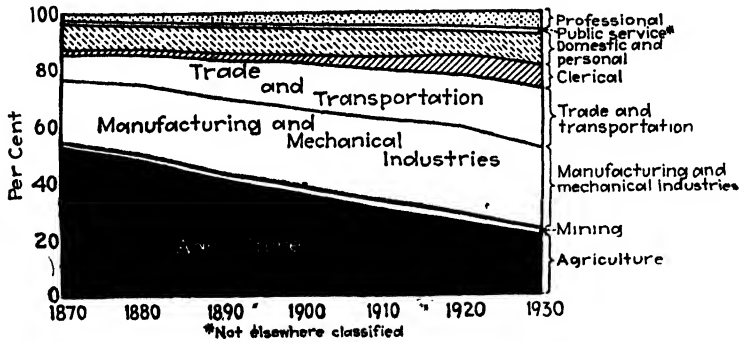

FIG. 139.—Decline of rural and increase of urban population in the United States from 1870 to 1930. (From Holmes, *Human Genetics and Its Social Import*.)

15 to 45 was 96; but within this group the number was 115 for unskilled labor, 100 for skilled and semiskilled labor, 86 for business, and 94 for the professional classes. The latter two were obviously losing to the others. The same study showed 147 births per thousand wives in families on relief (in the depression of the 1930's), 90 for self-supporting families with incomes not over \$1500, 81 where the incomes were just under \$2000, a further decline to 76 with incomes up to \$3000, then a small rise to 78 as incomes rose above \$5000. Discussion of the biological significance of these facts, aside from mere numbers, belongs to the chapter on eugenics.

The racial difference mentioned above is, for the United States, chiefly that between Negro and white. The replacement index for the nonwhites is about 20 per cent above that of the whites; but within the nonwhite group there is the same difference between rural and urban, and between the poor and well to do, as among the whites.

Reasons for Decline of Birth Rate.—The rural-urban difference in the size of families is largely of economic origin. On the farm, children begin to help with the chores in early childhood and with the major tasks in early youth. On mechanized farms mere strength is no longer an important requirement. Children thus furnish a reliable source of inexpensive labor. There is the further advantage that, so far as farm children will remain on the farm, their parents can train them in their future occupation at little expense.

In cities there is no such advantage. Children are of help only in household work, and around the yard where there are yards. They

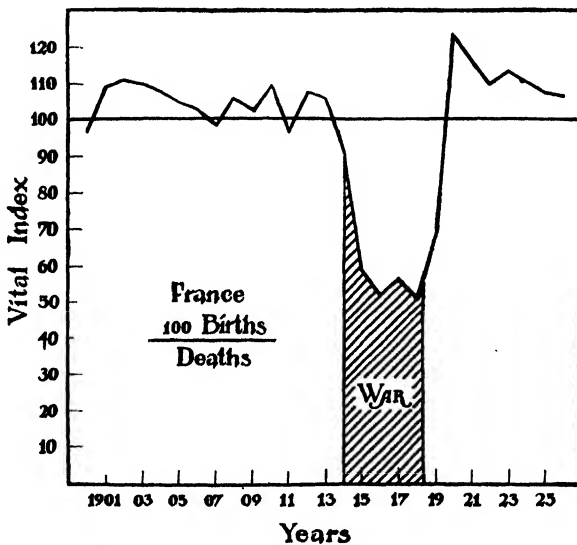

FIG. 140.—Curve of the ratio of births to deaths in France during the twentieth century, showing great reduction of this ratio in wartime. (From *Pearl in Human Biology and Racial Welfare*, Paul B. Hoeber, Inc.)

are expensive to rear without any compensating economic gain. Parents cannot themselves train their children for the occupations they will follow in the cities. Children tie the parents more or less to the home. There are, moreover, grades of success as individuals for which ambitious people strive, and, in general, families are a handicap in attaining such success. Add to these the desire for ease even where ambition is negligible, and the arguments for small families seem overwhelming.

It is important to note that the lowering of the birth rate does not stem from lateness of marriage. Age at marriage has been decreas-

ing, rather than increasing. Every census in recent decades in the United States has shown that lowering. It is plain that the chief factor in the decline of the birth rate is voluntary restriction of families and increasing knowledge of means of effecting that result.

War and the Birth Rate.—Wars have affected the birth rate differently. When soldiers are away for long periods, the rate declines markedly. This factor entered into the ratio of births to deaths in France in the First World War, as shown in Fig. 140. It is too early to say with certainty just what effect the Second World War had on the birth rate, particularly in the United States. Births in this country have been delayed, and hastened, and no one can yet tell how the totals for a decade or more will be changed, if at all. Births rose rapidly soon after the attack on Pearl Harbor. One factor was the desire of young men to have some experience of marriage before entering military service, particularly since for some that would be their only such experience. Moreover, at that time it was thought that a wife and child might prove to be a reason for exemption. The birth rate accordingly rose in 1942, reached a peak in 1943, then declined somewhat. There is as yet no information that would indicate a reversal, on account of the war, of the long-time downward trend of the birth rate.

Death Rate.—In a discussion of longevity in an earlier chapter it was pointed out that the expectation of life in the United States has risen rapidly in the present century, and in 1946 was over 65 years. Most of the increase was attained by helping children through their early years; the number of people living past 70 is not so greatly changed.

The measure of the death rate most often used is the crude rate, which means the number of deaths per thousand of the population per year. The weakness of this measure is its failure to take account of the ages of the people involved. A population made up largely of young people, as newly settled areas are apt to be, has a low crude death rate. Later as these same people become old, their crude death rate rises. There may be no change whatever in the biological factors that characteristically enter into the causes of death, it is merely the difference in age. Despite its defects, the crude rate is most often used because it is available where adjusted measures are not.

This death rate differs greatly as between countries, but has some stability in each one. In the United States, for the 5-year period centering in 1940, the crude death rate was 10.6 per thousand on the average. Any increase or decrease of more than 1.0 in this figure would call for explanation, and any increase of 3.0 would cause alarm.

In China, on the contrary, a death rate of 40 would occasion no comment. This high rate results from poor crops, epidemics, and the lack of any health program. The countries of Europe have mostly experienced declines in the death rate for a century, with temporary reversals, and in Japan there was a marked decline in the last two decades before the war.

This 20-year decline in Japan had its counterpart in Russia. Both of these countries made great strides in public health work, once they decided to begin, because they were able to borrow the technique from the Western world. Russia, after this start, lowered her death rate as much in 20 years as England had in the whole nineteenth century. The Philippines, India, and the Dutch East Indies have similarly had the advantage of Western knowledge—sometimes without too much effort on their own part.

One comment is needed concerning the death rate in countries where it is already low. Not much further improvement can be expected there. The United States is not likely to attain rates much below the crude rate of 10.6. At any rate, any further reduction cannot be an important element in the growth of population. Such growth will have to come from changes in the birth rate.

War and the Growth of Population.—The effect of war on the birth rate has already been discussed. War has an effect also on the death rate. Both of these direct effects are projected into the future, since the people who died and those who were not born do not leave descendants in the next several generations. Probably such losses are never actually made up, but the signs of them diminish.

As an example of the operation of this principle Germany may be used. The total loss of population in that country, because of the First World War, may be set at roughly 10 millions. Less than one-fifth of this came from military deaths. Approximately a quarter of it was the number of babies that would have been born but for interruption of marriages. Another quarter, or more, was the reduction in the birth rate during the war for families not broken up. The remainder, which was greater than any of the three items just named, was the number of babies who were not born in the next generation because their potential parents were not born during the war. These are conclusions reached from statistical computations, but the assumptions on which they are based cannot be greatly in error. By similar methods it is estimated that Russia experienced a deficit from the First World War of 20 millions within 5 years after her withdrawal from that war, and has a prospective deficit of 50 millions or more from that source

by 1970. It is too early to make similar computations of population losses in these countries resulting from the Second World War.

For the United States, with little or no reduction of the birth rate in the late war, it is estimated that there may be a deficit of 3 millions—not more—by 1990.

Future Populations.—These projections of birth rates and death rates into the future have been made on a much larger scale than has been so far indicated. Such forecasts are useful in determining industrial and public policy, as well as world politics. They are based on present birth and death rates unless there is some reason to believe these will change, on immigration prospects, and on the calculable changes in age distribution.

Among the predictions that concern the world are those calling for an increase in the population of Russia of 40 per cent from 1940 to 1970, an increase of only 18 per cent in the United States in the same period, and a simultaneous loss of nearly 10 per cent in England and Wales and a somewhat greater loss in France.

The countries which will increase little, or even lose population, are those which already have considerable control over both birth and death rates. Among these are the United States, Canada (except Quebec), most of western Europe, Australia, and New Zealand. These countries had their rapid growth earlier, before they acquired the mentioned controls. Countries that have less control over the death rate, and still less over the birth rate, will increase moderately. Most of the states of southern Europe, Russia, Japan, and the most advanced South American countries (Brazil, Argentina, Uruguay) are in this group. Where vital controls are slight or wanting, increase of population is likely to be considerable, but erratic. India, China, the East Indies, and some South American countries are in this category.

In making such predictions, there is, of course, risk that rates will not remain at their present levels, or will not change in the expected ways. To show how differently future populations might turn out if the assumed rates differed, the population of the United States has been computed on different bases. In Fig. 141 are given four projections into the future, on different assumptions regarding birth and death rates. The two middle curves have been supported by statisticians; few think that the top or bottom trend is likely to be realized.

Great increases of population in areas already overcrowded are a source of unrest. Trouble is likely to arise eventually wherever the

actual increase is more than one-third of the maximum of which a people is physiologically capable. Restriction of numbers to that level would be a boon to all. A people is not likely to be thrown into turmoil by its hard lot so long as it has known nothing better. But with a start of industrialization, and a taste of better living, people become acutely aware of their status. The great need is acceptance of control of birth rates in the crowded countries, as it has already been accepted elsewhere. That step is not likely to be taken soon by India or China, and not fully or not at once in Japan or the Balkans. Much human misery will doubtless result from their refusal or negligence.

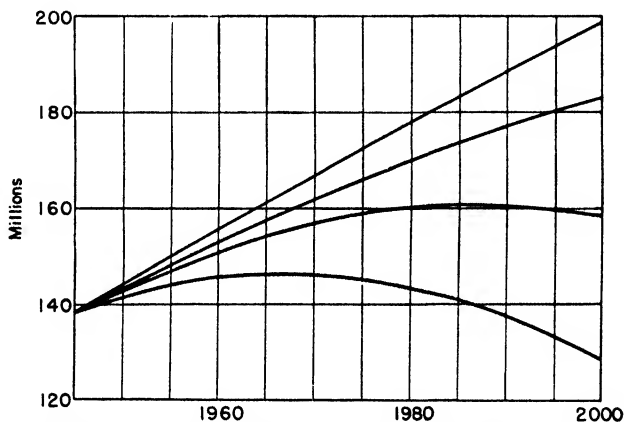

FIG. 141.—Projection of the population of the United States to the year 2000 on different assumptions. Top curve, high birth rate and low death rate; second curve, high birth rate and high death rate; third, medium birth and death rates; fourth, low birth rate and high death rate.

Areal Distribution.—In connection with the greater birth rate in rural than in urban populations, attention was called to the implied migration from farm to city. Countries differ greatly in the extent to which this migration has already occurred. The industrial revolution, whenever it comes, is a stimulus to such movement. That revolution began in the United States before 1880. At the first census in 1790, allowing for the distorted definitions of rural, probably 20 per cent of the people were off the farm. In 1940, only 23 per cent were left on it (Fig. 142). The rate of change between those dates depended on (1) improved methods of agriculture which released some people to other pursuits, (2) means of transporting farm products to the urban centers, and (3) the exhaustion of the supply of free land for settlement. Growth of large cities was facilitated by development of

steam power, since it was easier to expand a manufacturing business by additions than by building new plants elsewhere. It is possible that an opposite movement, that is, decentralization or the dispersal of metropolitan groups into smaller ones may follow the greater use of electricity or of internal-combustion engines, since the power is more easily transported. Fear of atomic bombs of enemies could easily be another incentive to decentralization.

1920	1940	
15	17	Over 500,000
10	12	100,000-500,000
10	11	25,000-100,000
16	17	2,500-25,000
19	20	Villages
30	23	Farms

FIG. 142.—Percentages of population of the United States living in communities of different sizes in 1920 and 1940.

Age Distribution.—The numbers of people of different age groups in a population are important in gauging the probable size of the population as a whole at any particular future time, because reproduction occurs only within a certain age range. From the number of people of ages 25 to 30 at the present time, and the known death rate at these ages, one can predict the number 15 years later of people of ages 40 to 45. Also, one may predict the number of children who will be born to this group at any period, if it be assumed that birth rates remain the same. Any pulse given to the population at a given period tends to flow through the subsequent age groups as the population grows older.

As noted in earlier sections, the birth rate has long been declining in the United States. When this lowering finally began to result in absolutely fewer births, the number of children up to 5 years of age was actually smaller than the number from 5 to 10 years. Figure 143 shows the age distribution in 1930. The short bottom band shows the reduction in the actual number of births.

Any population in which birth and death rates tend to fluctuate from year to year would have an irregular age distribution, like that in Fig. 143. If, however, rates remain the same long enough for all

the members of the population to live their lives out, the age distribution becomes stabilized, and there is a regular decline in the size of the age groups from youngest to oldest. In such a population birth and

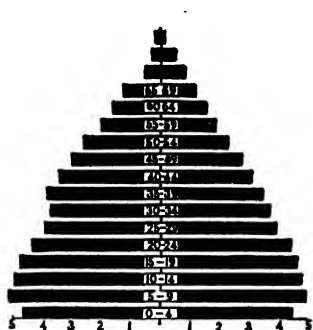

FIG. 143.

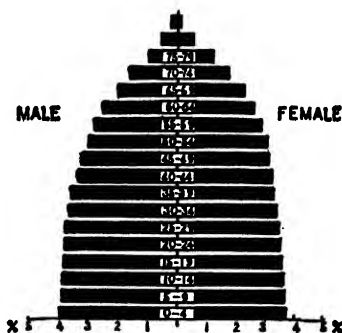

FIG. 144.

FIG. 143.—Age distribution of the population of the United States in 1930, showing the result of the declining birth rate. Left side of diagram males, right females. (From Burch in *Journal of Heredity*.)

FIG. 144.—Age distribution in a stationary population, with birth and death rates constant and equal. (From Burch in *Journal of Heredity*.)

death rates are actually indicative of population growth. The replacement index (page 259) has then no advantage over birth and death rates. If the birth rate exactly equals the death rate, the population being stationary, the age groups settle down to a regular relation to

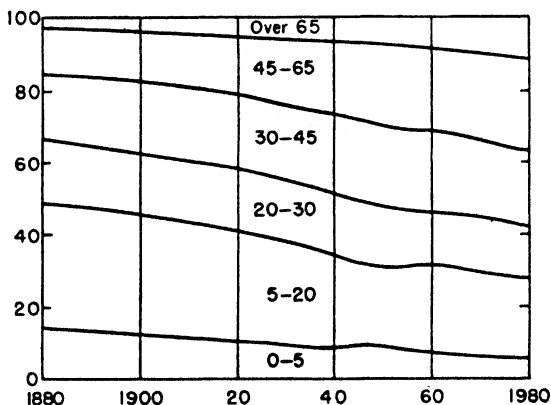

FIG. 145.—Percentage of population of the United States in the various age groups from 1880 projected to 1980.

one another as in Fig. 144. The base of such a beehive diagram is narrow, as compared with that of a growing population. A stationary population contains a greater proportion of old people than does a

growing one, and one which is growing slowly has more old people than one which is growing rapidly.

The change in age distribution in the United States, resulting from its slowing down in growth and from its change in immigration policy is shown in Fig. 145. The middle age classes have not changed, and presumably will not change, very markedly in the century represented. But the two youngest groups have become distinctly smaller, and the two oldest very plainly larger. Most of the world has been accustomed to a relatively young population, so this change is something to which it must adjust itself. The reason for this aging is simply that birth rates and death rates have declined. Fewer babies are born; fewer aged die. The factors leading to these changes have already been discussed.

Adjustments to Aging Population.—School authorities need to look forward to the demands for schools and teachers as the pulse started by the war-stimulated rise in the birth rate moves through the population ages. Elementary schools will be the first to be overloaded, then the secondary schools, then presumably the colleges—though it is uncertain how far the percentage of those seeking education will keep up beyond the compulsory years. Fortunately the birth record is always known, and school systems will have a few years to get ready. Less fortunate are the manufacturers of layettes and baby carriages, who may have to convert rapidly to either accelerated or retarded schedules. The makers of toys and children's clothing have on the average as much warning as the schools. Added supplies of youth's outfits should come later, and so on. They need also to watch for a subsequent decline. It is not yet clear what the trend of the birth rate is to be. The estimated births in 1946 were at an all-time high in absolute numbers (3,260,000), but the rate (23.3 per thousand) is still below the peak of 24.3 per thousand in 1921. The secular trend has been downward, and it remains to be seen whether that trend is to be resumed.

The great increase in the numbers of elderly people creates problems of employment and old-age benefits. Heretofore men over 45 have found it hard to obtain employment in new lines; if they changed jobs they found employers looking for younger men. When the number of people over 45 increases, this problem becomes more acute. It would seem desirable that employment suitable for the middle-aged and elderly be arranged, perhaps through reclassification of tasks. Less easily solved, probably, is the problem of old-age security payments. The increase of the aged lays a greater burden on those who pay. It

may prove economically preferable to extend the working period to later years than has been customary, reserving the less onerous jobs for the elderly holdovers.

Quality versus Quantity.—In this chapter the emphasis has been put upon numbers of people rather than on their values. This is because population problems concern themselves with numbers. The discussion could properly have included quality as well as quantity; but it would have suffered a loss of unity. The student of heredity is more interested in evaluating human beings than in counting them. For this reason assessing of values is separated out and included in the chapters on eugenics and race and immigration.

PROBLEMS

218. What factors do you think might explain the form of the growth curves of organisms or populations, particularly the reversal of its curvature—that is, the change from an increasing rate of growth to a decreasing rate?

219. How do you think the great industrialization of the United States beginning, say, in the 1870's, should have affected the form of the curve of population growth? Why?

220. What do you conceive to be the greatest obstacle to the solution of the population problem in India?

221. What is the best measure of the birth rate? Why are other measures misleading?

222. What is the best measure of the growth of a population or of any group within a population? Why?

223. Why should the effect of the Second World War on the birth rate in the United States have been different from that in other countries at war, and from that of other wars?

224. How do the crude birth and death rates of newly settled countries or areas differ from older ones, and why?

225. In what ways does war reduce the population of a country?

226. What questions of policy would you wish answered if you undertook to predict the population of a given country at some future date?

CHAPTER 26

RACE AND IMMIGRATION

A race is a group of people having many characters largely in common because of common descent. The real basis of judgment of race is the possession of like genes. Not all the genes are common to all members of a race, for there are individual differences within races just as within species. It is not necessary, indeed, that all individuals have any one gene in common. The characters which distinguish races are all multiple-gene characters, so that one gene in one individual could be different from the homologous gene of every other individual, without so altering him that he would not be recognized as belonging to the same race. Each locus could have a gene which in one individual differed from its homologues in all the rest of the population, without destroying the general similarity which characterizes races. All that need be true is that most members of a race have most of their genes in common. This flexible requirement allows a wider range of variation in some races than in others, and such differences actually exist. A race is not a fixed group, and the word race does not everywhere apply to comparable assemblages. Such flexibility of the term may not be desirable, but it cannot be helped.

The only likely way in which thousands or millions of individuals may come to possess genes in common is by inheriting them from the same ancestry. It is *conceivable* that genes derived from different ancestries might come to be alike through convergent mutation. It is also *conceivable* that enough genes from different sources might mutate in this convergent fashion to build up two unrelated groups of great similarity. Whether two such groups would be regarded as belonging to the same race, if their separate origins were known, is a question that geneticists have not had to answer, though taxonomists have sometimes thought they were faced with that situation in species. Because the amount of convergent mutation necessary to make two unrelated groups look like the same race is so exceedingly improbable, the stipulation in the definition of race that the likenesses must be due to common descent is justifiable.

Nonracial Characters.—A common error concerning race is to confuse it with language, or nation, or even religion. People living

together learn to speak the same language, regardless of their genes or descent. They also live under the same scheme of government merely because they are neighbors. Neighbors tend to adopt the same customs and to respect the same traditions, without reference to remote ancestry. And so, there is no Anglo-Saxon race. Those who use that expression may have the correct concept of race in mind but are mistaken in applying the term to a particular group. The people they call Anglo-Saxon have a certain speech, a body of traditions, and a group of customs in common; but racially they are very mixed. There is no French race, for the inhabitants of France have derived their genes from three somewhat distinct sources.

Racial Classification.—Mankind falls into three groups, with several minor ones which elude simple classification. The three large groups are the Negroid, the Mongoloid, and the Caucasian races. Each has its subdivisions. In the Negroid group are the African Negroes, the Oceanic Negroes, and the Negritos or Dwarf Blacks. Closely related to the last of these are the Bushmen of South Africa. In the Mongoloid group are the Asiatic Mongoloids, the Oceanic Mongoloids, and the American Indians. Allied to the Oceanic Mongoloids are also Polynesians. The Caucasian race is composed of the Nordic, Alpine, and Mediterranean races, with the Hindus similar to the Mediterranean.

Among the minor races not easily placed in any of the major assemblages are (1) the Ainu of Japan, with leanings to the Caucasian type, (2) the Australian aborigines who are nearer the African Negroes but different from them, and (3) the Indo-Australians who approach the Hindu.

The classification of races goes farther than this and is extended later in this chapter; but the main features here indicated will furnish the orientation needed for a first discussion of race problems.

Characters Distinguishing Races.—Anthropologists have always placed emphasis on stature as a racial mark, though it is subject to much fluctuation, partly environmental, within each race. Since few races have an average stature of less than about 60 inches, and none a mean of over 70 inches, it is clear that there is a great deal of overlapping.

The cephalic index, or ratio of width to length of the skull (Fig. 146), is also very extensively used. It has the fault of responding somewhat to dietary or other conditions. In a homogeneous environment, however, head shape is a very serviceable racial mark.

The nasal index, or width of the nose in relation to its length, is

likewise racial. In the Negroid races that ratio is very high. Prognathism, or the protrusion of the jaw in front, is another trait the anthropologists employ.

Cranial capacity varies considerably. For the white race as a whole, the average capacity is between 1450 and 1500 cc. in males, about 10 per cent less in females. European males have a mean between 1500 and 1600 cc., American Indians between 1400 and 1500 cc., and Bushmen between 1300 and 1400 cc.

Texture or shape of the hair is important. As indicated earlier (page 195), this shape is due to the form of the hair in cross section.



FIG. 146.—Skull shape as a racial character: left to right, narrow, medium, and round. (From Ward's Natural Science Establishment.)

The woolly hair of the Negro is considerably flattened, the straight hair of Mongoloids circular, and the wavy hair of Caucasians intermediate.

Hairiness is especially useful in some situations. The variation between races chiefly relates to the beard and body hair. Caucasians are usually quite hairy, while Mongoloids and Negroids are relatively smooth. The Ainu are separated racially from the Japanese largely because of their hairiness. Likewise the Australian aborigines are considered a different race from the Negroid chiefly because they are hairier.

Hair color and eye color are useful because they are almost free from nongenetic modification. Black hair and eyes are the rule outside the Caucasians but within this race the color has many gradations.

Miscellaneous Race Distinctions.—In addition to the easily observed characters which anthropologists use, a number of other differences between certain races have been observed. The blood groups

are differently distributed. Most American Indians are of group O, possessing neither agglutinogen A nor B (page 158). The proportions of A and B in other nationalities vary from west to east in the Old World, A being prevalent in Europe, while B gains to the eastward (Fig. 147). These proportions need not indicate kinship in all cases of similarity, however, since the agglutinogens may have arisen more than once as parallel mutations (page 185) in different races.

Basal metabolism was found to be 6.5 per cent higher in Mayan men in Yucatan than in Caucasians, in south Indian women 17.4 per

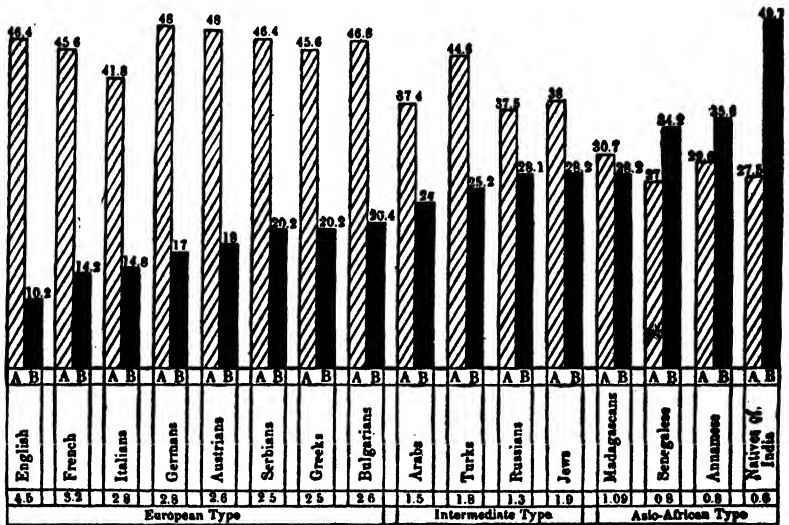

FIG. 147.—Diagram showing the increase of agglutinogen B of human blood from west to east in Europe and Asia, and the decrease of agglutinogen A in the same direction. (From Snyder, *Blood Grouping in Relation to Legal and Clinical Medicine*, Williams and Wilkins Co.)

cent lower than in white women, and in Australian aborigines 14 to 16 per cent below Caucasians (Benedict 1932). If these differences stood alone, they might be attributed to climate and food; but American-born pure-blooded Chinese girls in Boston had a metabolism 9 per cent below that of American white girls, and here climate was identical and food not very different.

Sweat glands are more abundant in Negroes than in whites, at any place on the body, though their relative distribution is the same in both.

These various distinctions would not aid an anthropologist greatly in diagnosing races, but they all help to illustrate that races are distinguished by hereditary characters, that is, by genes.

Three White Races.—Because the civilized peoples are prevalently Caucasian and America is mainly European, three of the subdivisions of the white race figure extensively in the topics further developed in this chapter. The Alpines (Fig. 148) have a round face and wide skull, moderately dark hair and eyes, and a stocky build. They are found chiefly in the divisions of old Russia, in the Balkan states, Switzerland, Bavaria, Austria, northern Italy, and central France. The Mediterraneans have a slight build, narrow skull, and dark or



FIG. 148.—Alpine woman from Lapland. (From *Mjphen in Eugenics in Race and State*, Williams and Wilkins Co.)



FIG. 149.—Mediterranean type from south Italy. (From *Dizon, Racial History of Mankind*, Charles Scribner's Sons.)

swarthy complexion (Fig. 149). They are in Portugal, Spain, southern Italy, Sicily, and north Africa, and less extensively the British Isles and littoral regions of the Balkan peninsula. The Nordics (Fig. 150) are tall and fair, with light hair and eyes, narrow skull, hairy body, and a domineering disposition. They are collected largely around the Baltic Sea in Scandinavia, Germany, the Netherlands, and the British Isles, but have some representation at many other places.

These definitions must not be interpreted to mean that pure races exhibiting the characters named exist in the regions indicated or anywhere else. They represent idealized races and doubtless more accurately the conditions of the ancestors of the present-day groups.

Much mixture between them has occurred so that no white race is now pure. The nearest approaches to purity and adherence to "original" type in the white race are found in Sweden (Nordic) and Sicily (Mediterranean).

Mentality of Races.—Races undoubtedly differ in their mental qualities just as they differ physically. In view of the way in which genetic differences between groups arise, it is inconceivable that genes



FIG. 150.—The Nordic type. (*From Mjφen in Eugenics in Race and State, Williams and Wilkins Co.*)

affecting mentality and cultural capacities should have escaped the evolutionary processes that other genes have experienced. When, however, an attempt is made to assess these differences, it is glaringly apparent that no reliable measure exists. Very probably some races are more inventive than others; but no test of this property excludes opportunity and relates only to genes. It is highly likely that some races are more musical than others, and that in musical races some are more gifted in composition, others in vocal or instrumental performance; yet no test so far devised excludes the influence of the economic

status of musicians, and depends solely on their genotypes. It is even more true of art that no suitable test of ability exists, for what passes for art in the minds of some is sheer monstrosity to others. The esteem in which a piece of art will be held many generations hence is still its safest measure, and if any eugenic policy were involved that would be a long time to wait.

The lack of any suitable measure is particularly evident when claims of the "superiority" or "inferiority" of any race are made. In such claims, some one has to decide how to balance, let us say, literary ability against artistic, scientific bent against philosophy. Races unquestionably differ in such matters, and perhaps at any particular time and place one type of ability would work out more advantageously than another. But such needs change more rapidly than races can change, so that even if "good" and "bad" could be correctly determined at any moment the judgment would not long remain correct. A still more serious fault of such decisions, however, lies in the plain fact that people who have made them in the past have expected to benefit economically from them. One can scarcely avoid the conclusion that estimates of racial worth are simply rationalization; some one is trying to brand as true that which he wishes were true, and acceptance of which as true would for the moment benefit him.

Race Hybridization.—One practical problem around which questions of comparative racial values tend to revolve is that of the desirability or undesirability of race crossing. A popular conclusion has been that hybrids between races are apt to sink to the level of the inferior race or to be worse than either of them. With respect to characters determined by environment, that conclusion is often justified, particularly in regions where miscegenation is regarded with disfavor. In such regions hybrids are social outcasts, and their status may tend to unsettle them. Hybrids may also be inferior for genetic reasons, because where race mixture is taboo it is chiefly the inferior individuals of either race who will indulge in it. In the latter situation the offspring may not be inferior to the children that would have been produced by the same parents had each one married a similar person within his own race.

Where miscegenation is not frowned upon, as is true in most of South America, the value of race hybrids may be estimated on purely biological grounds. In size, color, and some other characters, the hybrids tend to be intermediate, as was found by Davenport and Steggerda to be true of the brown people of Jamaica. If one race is superior to the other, an intermediate hybrid is inferior to one parent,

but an improvement upon the other. To the race as a whole, there is no detriment in this relation.

The principal biological disadvantage that may come from race mixtures is the production of disharmonious combinations. To what extent disharmonies exist is uncertain. A favorite alleged example is the combination of teeth and jaws of different sizes from different races. Within each race growth of one part is properly adjusted, it is said, to that of the other, and well-formed rows of sound teeth are usual in purebred races. In the hybrid, however, with independent inheritance of size of jaw and size of teeth, small teeth may be set in a large jaw with consequent spacing, or large teeth in a small jaw resulting in distorted rows of teeth. There are numerous examples of such misfits in the tremendously hybridized American population, and their explanation may be as simple as just stated. Davenport adheres to this view, but Castle believes that conspicuous disharmonies are uncommon if the crossed races are not too dissimilar.

The normal result of free intercrossing is the disappearance of racial distinctions. With any tendency to avoid crossing even when the races intermingle, a considerable degree of separation may be maintained. With respect to the Negro and white races in the United States, Holmes points out that miscegenation is less frequent than formerly and that fertility of the mulattoes is relatively low; hence, the two races are not likely to merge.

The antagonisms that sometimes exist between unlike races are probably not due to any of their biological characteristics, but to their social relations.

Racial Composition of United States.—About 9 per cent of the people of the United States are Negroes. The largest other minority racial group is the American Indians, of whom there are fewer than half a million, though the number is growing. There are smaller numbers of orientals (Japanese, Chinese, Filipinos).

The remainder of the population belongs to the various divisions of the white race, greatly mixed. There is no accurate information as to the distribution of these whites among the idealized branches of the white race, but there is an estimate of the numbers derived from the several nations from whom immigrants have been received. This estimate was based on the 1920 census and other data, was made by a committee of the President's Cabinet, and was published in 1928. It took into account the numbers from various countries who were in America in 1790 (the colonial stock), the numbers which have immigrated since then, and the numbers of descendants which each of these

national groups had presumably produced by 1920. Because the immigration policy, to be discussed later, was based on this distribution, it is worth while to present the results. The following table shows the proportion of the population contributed by each nation that was responsible for at least 1 per cent of the total.

APPORTIONMENT OF WHITE POPULATION OF THE UNITED STATES IN 1920, BY
COUNTRY OF ORIGIN
(000 Omitted)

Country of origin	Colonial stock	Post-colonial stock	Percentage of total
Great Britain and Ireland.....	31,804	7,412	41.4
Germany.....	3,037	12,452	16.3
Irish Free State.....	1,822	8,832	11.2
Canada.....	646	3,391	4.3
Poland.....	9	3,884	4.1
Italy.....	3,462	3.6
Sweden.....	217	1,760	2.1
Netherlands.....	1,367	515	2.0
France.....	.767	1,075	1.9
Czechoslovakia.....	55	1,660	1.8
Russia (in Europe and Asia).....	4	1,657	1.8
Norway.....	75	1,343	1.5
Mexico.....	294	832	1.2
Switzerland.....	389	630	1.1

Fertility of Component Races in United States.—In computing the probable future racial complexion of the United States, the fertility of the several racial types is of interest. The Negroes, as the largest group of nonwhites, claim first attention. According to Pearl the inherent fertility of white and Negro women is about the same, within limits of probable error (see Appendix for significance of probable error). Contraception, however, is more effective as practiced by whites than among Negroes. There is accordingly a higher birth rate among the Negroes (18.79 per thousand as against 17.15 per thousand in the whites) in a group of cities. Greater wastage in Negroes, partly due to greater prevalence of venereal disease, compensates the higher birth rate, leaving the rate of increase about the same in the two races.

The rate of increase of immigrant stocks is always higher in their early years in America than that of the native population. But this rate has always decreased later. The children of the immigrants, if not the foreign born themselves, have adopted the American family

pattern, congregation in cities has had the same effect on them that it has on American farmers, and the birth rate has rapidly declined. It seems unlikely that the immigrant stock will continue long to gain on the native stock.

Course of Immigration.—The foregoing considerations of immigration relate only to numbers. Nothing has been said about quality, but many Americans have believed that quality is involved. Whether or not they are correct depends on unequal values of the racial types that have come in. Let us see how those types have varied. Immigration prior to 1820 was negligible. In that year a little over 8,000 immigrants came. Thereafter the number fluctuated, depending partly on political conditions in Europe but more on economic conditions in the United States. The first peak was reached in the early 1850's, then the number fell until after the American Civil War. Immigration rose again in the early 1870's but dropped with the depression following the panic of 1873. Industrialization was by that time in full swing and immigration rose sharply in the 1880's but once more declined during the depression years around 1893. The all-time high was in 1907, when 1,250,000 immigrants entered this country. The average was maintained at 1,000,000 a year until 1914, when it dropped greatly during the First World War. After that war immigration started up strongly, but by that time it was the subject of legislative action, and restrictions began to be imposed. Because of these restrictions the number of immigrants declined, and in the depression of 1932 and near-by years it was practically zero. Indeed, in certain years more foreigners left the country than entered it.

The first three peaks of immigration, ending with that between 1880 and 1885, were very largely due to arrivals from countries of northern and western Europe. The great influx between 1900 and 1914, however, was mainly from southern and eastern Europe. This change of the source of immigrants from northwest to southeast Europe played a large part in the adoption of legislation governing immigration, the particulars of which will be pointed out presently.

Restriction of Immigration.—The attitude of the United States toward this century-old accretion of foreigners was at first one of welcome. The country was large and thinly populated and was devoted chiefly to agriculture. Additions of people of the same European stocks, who came here to settle on farms, could only be beneficial. It was not until the period of industrialization set in, around 1870, that this attitude changed. Immigration became an economic question then. The economic difficulties included competi-

tion with American labor and the indigence of some of the people whom foreign countries sent us. Various laws were adopted, with the aim of excluding those who might become a social burden, and at the same time of reducing the total number of immigrants. The present law was adopted in 1924, but this law provided for a later presidential proclamation which did not become effective until 1929. It also permitted presidential discretion in *lowering* the number of immigrants admitted; hence, there has been considerable fluctuation in the annual accretions. The reduction during the depression of the 1930's has already been mentioned (Fig. 151). Then in the Second World War immigration was restricted (by presidential action under the law) for

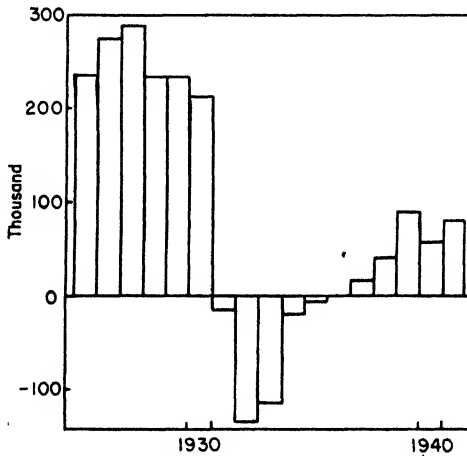

FIG. 151.—Net immigration (arrivals minus departures) into the United States after the enactment of the immigration law of 1924.

other reasons. After the war the numbers again began to rise, and in 1946 about 80,000 were admitted.

The law of 1924 provides that 150,000 may be admitted from Europe each year, divided among the countries in proportion to their contribution to the United States population of 1920, as shown in the table on page 278. The number is somewhat more than that, since even the smallest countries have a quota of at least a hundred. A very considerable addition is also made by admitting, over and above quotas, certain relatives of those who are already American citizens. The annual admissions for the first few years totaled nearly 300,000.

It should be noted that there is no restriction of immigration from any country in the Western Hemisphere. The only country which has taken much advantage of this privilege is Mexico. China, whose

citizens were long excluded, was put on the quota basis in the Second World War, and may now send about 105 immigrants each year.

Since the quotas are based on the components of the United States population as of the year 1920, countries of northwestern Europe are favored; they are the countries from which most of the American people came prior to 1880. This distinction is the result of deliberate intent of the Congress in 1924. Some Congressmen had the prejudices that many others have on racial questions, and their attitude could be regarded as confirmed by a study which they ordered made.

Laughlin's Study of Custodial Institutions.—At the request of the Committee on Immigration and Naturalization of the Federal House of Representatives, H. H. Laughlin made a survey of the inmates of custodial institutions. He obtained information regarding the inmates of 684 such institutions, with special reference to whether these inmates were of native or foreign stock. The quality of a given nation as a source of immigrants was judged by the relative frequency with which individuals from that nation were found in these institutions, taking into account the number of people from that nation in the whole country. For example, at the time when Laughlin's studies were made, there were 1,343,125 people of Italian birth in the United States. This number constituted 1.46 per cent of the total population of the country. If Italians are neither more likely nor less likely to furnish defectives than is the average of the whole population, 1.46 per cent of the inmates of the custodial institutions should be Italian. Occurrence of exactly the expected 1.46 per cent of Italians in institutions would be regarded as 100 per cent fulfillment of the Italian quota. Exceeding this 100 per cent of the quota is a bad sign; a figure less than 100 per cent indicates a more satisfactory condition.

The results of the study indicated that a somewhat larger proportion of the immigrant stocks got into institutions than were entitled to; that is, they more than fulfilled their quotas. It also appeared that in general those who immigrated got into institutions more often than did their children born in America.

Northwest versus South and East Europe.—To answer the questions in the minds of Congressmen, Laughlin then analyzed his data by countries, and grouped the countries into a northwestern and a southeastern bloc. Figure 152 shows the extent of quota fulfillment for these two blocs and the native population, with respect to the nine principal defects for which they were confined, and for all defects together. The record was moderately derogatory to the southeastern group, which confirmed some ideas held in advance. This study may

or may not have influenced legislation greatly, but it was given considerable prominence in the debate.

The low quota fulfillment of all Europe with respect to feeble-mindedness, blindness, deafness and deformity, and to a slight extent

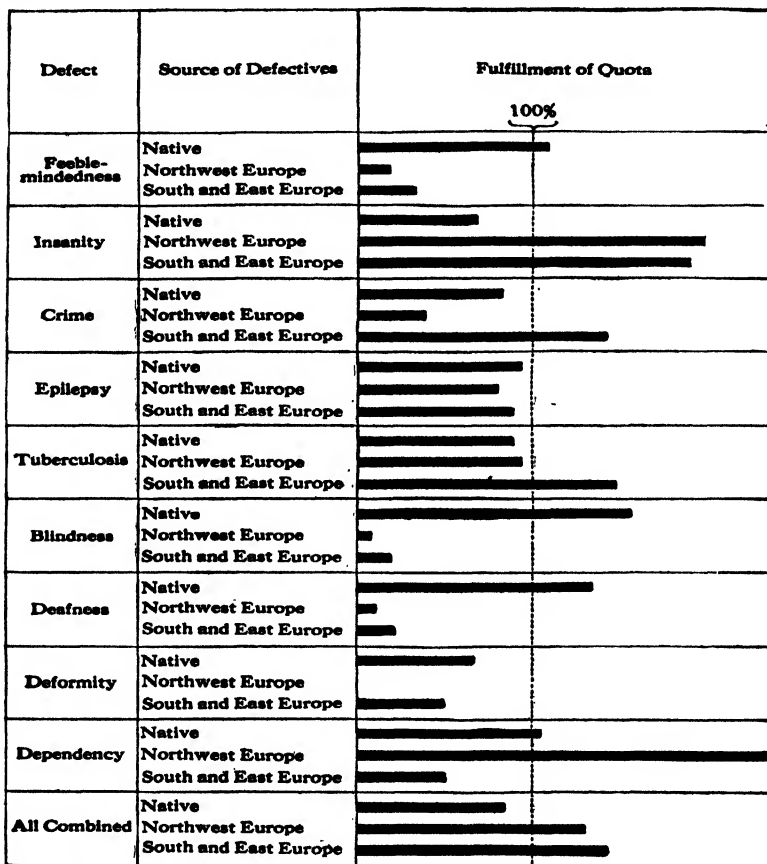

FIG. 152.—Comparison of Northwestern and Southeastern Europe with respect to their contribution of inmates of American custodial institutions. A black band extending to the right of the dotted line indicates that the group in question furnished a larger percentage of the inmates of institutions than of the population of the country.

epilepsy, merely reflects the screening at the immigration office. Most such people were recognized as defectives and were not admitted.

Possible Misinterpretation.—The principal source of error in the conclusions to be drawn from Laughlin's study is the fact that it dealt only with inmates of institutions. There are many people of both immigrant and native stocks suffering from the same defects who are

still at large. If the institutional defectives are truly representative of the whole group, in and out of the institutions, no serious mistakes would be made by basing policy upon them. If something, national custom, for example, should prevent the people from one country from entering institutions as freely as do those of another nation, the relative numbers in institutions would give an entirely erroneous notion of the relative desirability of those two countries as sources of immigration. There is no way of knowing how great an error creeps into the conclusions from this source, short of taking a census of all defectives at large. The latter remedy can hardly be applied because of the labor required, but in its absence it is necessary to be cautious in interpretation.

Another weakness of the interpretation that was put upon this study stems from the large number of insane people involved. Immigrants greatly exceeded their quota for this defect (Fig. 152). Their American-born children, however, were only slightly above their quota for insanity. This probably means that much of the insanity of the immigrants was environmentally caused, as could easily be true for people under the strain of new conditions. To whatever extent the insanity was environmentally caused, to that extent the conclusions about a stock of bad genes would be erroneous. Since the insane made more than 40 per cent of all the inmates studied, this group influences total results considerably.

Improvement of Immigration Policy.—Probably the most useful change in the immigration policy of the United States, if it were feasible, would be to base admission on genetic constitution rather than nationality. The best people should be obtained, no matter whence they come. To determine genetic constitution, it would be necessary to examine the family histories of applicants in their home countries, before they set sail. Examinations are now given abroad to a considerable portion of the applicants, but they bear mostly if not exclusively on the qualities of the applicant himself, not his family. All persons who on this examination show any mental defect are excluded, and they constitute 1 to 3 per cent of the total, at different ports. About 9 per cent show some defect, but not all of these are rejected. If it proved practicable to ascertain genetic constitution from pedigrees, national allotments could well be discarded. A quota could still be set to govern total admissions.

Other changes, generally designed to make regulation more strict, have been proposed by students of immigration. The following are taken from Laughlin in a study made for the Chamber of Commerce

of the State of New York. He calls for the immediate extension of immigration restrictions to all nations, which means adding the countries of North and South America, which are now exempt. Mexico is the only American country now sending us large numbers. Its peon class flocks over the border in good times and goes back in bad. Racially they are quite distinct from the people of the United States.

To make restrictions against North American countries effective, it would be necessary either to enlarge the border patrol very greatly, or to require registration of all aliens. Aliens not able to show registration certificates would then be deportable no matter where found. Whether it would be desirable, on grounds political as well as genetic, to attempt such restrictions is a very different question.

PROBLEMS

227. Do you think it will ever be possible to divide mankind into races which will be sharply marked off from other races? Why?

228. Does the reliance of anthropologists on physical characters to distinguish races mean that races differ only in physical traits? If not, why are not mental characters used?

229. What is the nature of valid objection to race hybridization?

230. Tentative immigration rules adopted by the United States in the early 1920's based quotas on the number of people of the various national groups who were in this country in 1910 and 1890. Why do you suppose these earlier census dates were used despite the fact that the data of 1920 were already available?

231. What do you regard as the greatest defect of Laughlin's studies of immigrants? Why?

232. What scheme could be used to admit immigrants on the basis of genes instead of national origins?

233. What is the meaning, to a geneticist, of the political dictum that men are created equal?

APPENDIX

QUANTITATIVE CHARACTERS

Many of the characters of organisms exist in such sharply defined forms that names suffice to distinguish them. Eye color may be scarlet, blood, or peach; plant stems may be tall or dwarf with no doubtful intermediates; feathers may be solid black or barred. It is with qualities like these that this book has chiefly dealt. They are sometimes called qualitative characters.

Often, however, the expression of a character in individuals is highly variable. Two strains of wheat have grains of unequal size, and when they are kept separate it is easy to see that one is larger than the other. Yet the individual grains are of various sizes, and the smaller grains of the large strain are smaller than the larger grains of the small strain. Such qualities may be called quantitative characters. Names for them will not suffice; they must be measured.

The Mean.—The first measure of a quantitative character is the *mean* or average of its expression in a considerable number of individuals. It is assumed that the student is familiar with ordinary arithmetical methods of calculating the mean, but the short method used in statistical work may not be so well known. The method is here illustrated with the weight of hens' eggs, whose mean is worth ascertaining in instances where two breeds differ in egg size. To simplify the calculation, it will be assumed that the eggs were weighed with the idea of the statistical study in mind and that they have been grouped into classes. It was decided, we may suppose, to group the eggs together to the nearest tenth of an ounce; one class would include all eggs weighing between 1.85 ounces and 1.95 ounces, another class all between 1.95 ounces and 2.05 ounces. The complete data obtained are shown in Table 1, in which only the first three columns were filled.

This table shows that there were 2 eggs (frequency, f) between 1.45 and 1.55 ounces in weight (class range), 5 eggs between 1.55 and 1.65 ounces, and so on. Each class is treated as if the eggs in it were concentrated at its middle point. The third class is made up of 17 eggs weighing 1.7 ounces (class value, v), the fifth class of 60 eggs each weighing 1.9 ounces. Now, it is obvious that the mean weight of these eggs is approximately 2 ounces, and this value may be called the assumed mean (a). The mean assumed is always one of the class values. All other classes deviate from this assumed mean, in either a positive or a negative direction, and the deviation (d') is measured with the class interval as a unit. The deviation of the first class of eggs from the assumed mean is -5 class intervals; that of the eighth class is $+2$ class intervals.

Each frequency is now multiplied by the deviation of its class from the assumed mean, and the respective (negative and positive) products (fd') are set down in the sixth and seventh columns. These products are summed up at the bottom, where it appears that the negative ones outweigh the positive ones, so that the net sum of the products ($\Sigma fd'$) is -34 . From these numbers the mean is calculated from

the formula

$$M = a + i \frac{\Sigma fd'}{n}$$

in which i is the class interval (0.1 ounce), n is the total number of eggs (291), Σ indicates summation, and the other symbols have the significance already indicated. Substituting the actual values in the formula, we have

$$M = 2.0 + (0.1) \frac{-34}{291} = 2.0 - 0.0116 = 1.9884 \text{ ounces}$$

This value of the mean may be rounded off at 1.99 ounces for any further calculations.

TABLE 1

Class range	Class value v	Frequency f	d'		fd'		fd'^2	
			-	+	-	+		
1.45-1.55	1.5	2	5		10		50	
1.55-1.65	1.6	5	4		20		80	
1.65-1.75	1.7	17	3		51		153	
1.75-1.85	1.8	31	2		62		124	
1.85-1.95	1.9	60	1		60		60	
1.95-2.05	2.0	74	0	0	0	0	0	
2.05-2.15	2.1	58		1		58	58	
2.15-2.25	2.2	29		2		58	116	
2.25-2.35	2.3	10		3		30	90	
2.35-2.45	2.4	2		4		8	32	
2.45-2.55	2.5	3		5		15	75	
$i = 0.1$		$n = 291$			$\Sigma fd' =$	203	169	$\Sigma fd'^2 = 838$
						34		
$\Sigma fd'/n = -0.116$			$\Sigma fd'^2/n = 2.8797$					

Significance of the Mean.—How much the mean tells regarding a population depends on how nearly it describes the individuals composing the group. When the mean weight of American silver dollars is given as so many grains, that mean is highly descriptive because every dollar weighs very close to the stated amount. Coins deviating much from the standard weight are rejected at the mint. When, however, the mean per capita wealth of a certain eastern city is given as so many dollars, that information is of little descriptive value because almost no one in the city has that wealth. For the city is made up of several multimillionaires and a considerable group of merchants and laborers. The silver dollars constitute a very uniform population, the people of the eastern city a highly variable one. The mean of a nearly uniform group is always more informative than the mean of a very variable one.

It is necessary, therefore, to have a measure of the variability of a population in order to judge the significance of its mean. Besides, the variability itself is sometimes of considerable importance entirely apart from its relation to the mean.

Variability.—The measure of variability is the *standard deviation* (σ), defined by the formula

$$\sigma = \sqrt{\frac{\sum fd^2}{n}}$$

in which f is the frequency as already used in the preceding section, d is the deviation of each class from the mean, Σ is the sign of summation, and n as before is the total number of individuals. This formula is difficult to use because, since the mean nearly always ends in a fraction, d likewise involves fractions, and squaring fractions is laborious. For calculation, therefore, the following formula is substituted:

$$\sigma = i \sqrt{\frac{\sum fd'^2}{n} - \left(\frac{\sum fd'}{n}\right)^2}$$

In this formula d' is the deviation of each class, not from the actual mean, but from an assumed mean; and to save labor the mean assumed should be the same (a) as was used in calculating the mean. The deviation is thus always a whole number. It is measured in class intervals and is therefore always small, so that squaring it is an easy operation. The other symbols in the formula have the same significance as was indicated in connection with the mean.

Using the assumed mean rather than the actual mean from which to measure deviations introduces an error which is corrected by deducting $(\sum fd'/n)^2$ before the square root is extracted.

In calculating the standard deviation from this formula, much labor is saved by preserving the calculation of the mean, as in Table 1. The values fd'^2 are readily computed (eighth column) by multiplying the deviation (d') in column 4 or 5 by the product fd' in column 6 or 7. The sum of these products is $\sum fd'^2$, and in this population it is 838. The quotient $\sum fd'/n$ was found, in the calculation of the mean, to be -0.116 . We may, therefore, substitute concrete values for the symbols in the equation of the standard deviation, thus:

$$\sigma = 0.1 \sqrt{\frac{838}{291} - 0.116^2} = 0.1 \sqrt{2.8663} = 0.17$$

The standard deviation of these eggs is thus 0.17 ounce. The correction factor $(\sum fd'/n)^2$ is almost negligible in this particular population because the assumed mean ($a = 2.0$) was so near the actual mean, 1.99. In other populations when the mean is not so correctly guessed or does not come so near one of the class values, the correction factor is important.

Abstract Measure of Variability.—The standard deviation, 0.17 ounce, measures the variability of the eggs satisfactorily in all relations arising within this particular population. It does not, however, suffice to compare the variability of the eggs with the variability of the height of men in inches. It cannot be used to compare variability measured in any other unit than ounces. It cannot be used even to compare the variability of one group of eggs with that of another group of eggs, unless both lots have the same mean weight, for, if the second population of eggs has a higher weight, it should have also a larger standard deviation in order to have the same variability as the first group.

For comparisons of variability in different populations, the measure of variability must be changed to the *coefficient of variation*, which is defined as

$$V = \frac{100\sigma}{M}$$

in which σ is the standard deviation, M the mean. For the population of eggs in Table 1,

$$V = \frac{0.17 \times 100}{1.99} = 8.5$$

This value 8.5 is an abstract number, not ounces, not inches; it is comparable with the coefficient of variation of any other population.

Direct Use of Measures of Variability.—The coefficient of variation is directly used in genetic work in deciding the degree of variability of F_1 and F_2 generations. Blending inheritance (page 116) is characterized by fairly uniform F_1 (if the parents are homozygous and all of the same genotype within each parent group) and a variable F_2 . Suppose that, in an experiment testing the inheritance of the number of rows of grains in the ears of corn, two strains differing in that number have been crossed and that both F_1 and F_2 generations have been obtained, with the result shown in Table 2.

TABLE 2

Generation	Number of ears having the following rows of grains					
	6	8	10	12	14	16
Parent 1.....	5	7				
Parent 2.....	1	5	2
F_1	6	62	35		
F_2	1	12	58	29	19	2

For the F_1 generation $M = 10.56$ rows, $\sigma = 1.13$ rows, and $V = 10.7$. For the F_2 generation $M = 10.98$ rows, $\sigma = 1.90$ rows, and $V = 17.3$. The student is encouraged to verify these figures by his own computation. The contrast of 17.3 with 10.7 shows that F_2 is more variable than F_1 (which was in this instance obvious from mere inspection of the table) and that therefore this particular condition of blending inheritance is met. The number of rows of grains is presumably a multiple-gene character.

Normal Curve of Variation.—Turning now to the use of variability in judging of the value of the mean, we must first observe the normal distribution of the values of a variable character. If any measurable quality fluctuates (in a large number of individuals) in a purely random manner about a mean condition, a graph of the values of the character in the whole population tends to take the form of the curve in Fig. 153, which may be called the normal curve of variation. It rises to a peak in the middle, just as the weights of eggs in Table 1 would do if they were plotted, and falls off symmetrically to right and left, almost to zero.

This curve has certain properties in relation to the standard deviation. If distance be marked off on the base line (with the standard deviation as the unit) in plus and minus directions from the mid-point which represents the mean, it is found that practically the entire population lies between two extremes, one of which is three times the standard deviation above the mean, the other three times the standard deviation below the mean. If the mean of a population is 20 and

its standard deviation is 2, very few of the individuals will be over 26 or under 14, that is, if the population is distributed in the normal random manner. Moreover, between these extremes, certain fractions of the population lie at certain distances from the mean. These fractions and their respective distances (measured with the standard deviation as the unit) are given in part in Table 3.

TABLE 3

$M - x\sigma$	Fraction of total population	$M - x\sigma$	Fraction of total population	$M - x\sigma$	Fraction of total population
0.05	0.0199	1.35	0.4115	2.65	0.4960
0.10	0.0398	1.40	0.4192	2.70	0.4965
0.15	0.0596	1.45	0.4265	2.75	0.4970
0.20	0.0793	1.50	0.4332	2.80	0.4974
0.25	0.0987	1.55	0.4394	2.85	0.4978
0.30	0.1179	1.60	0.4452	2.90	0.4981
0.35	0.1368	1.65	0.4505	2.95	0.4984
0.40	0.1554	1.70	0.4554	3.00	0.4987
0.45	0.1736	1.75	0.4599	3.05	0.4989
0.50	0.1915	1.80	0.4641	3.10	0.4990
0.55	0.2088	1.85	0.4678	3.15	0.4992
0.60	0.2257	1.90	0.4713	3.20	0.4993
0.65	0.2422	1.95	0.4744	3.25	0.4994
0.70	0.2580	2.00	0.4772	3.30	0.4995
0.75	0.2734	2.05	0.4798	3.35	0.4996
0.80	0.2881	2.10	0.4821	3.40	0.4997
0.85	0.3023	2.15	0.4842	3.45	0.4997
0.90	0.3159	2.20	0.4861	3.50	0.4998
0.95	0.3289	2.25	0.4878	3.55	0.4998
1.00	0.3413	2.30	0.4893	3.60	0.4998
1.05	0.3531	2.35	0.4906	3.65	0.4999
1.10	0.3643	2.40	0.4918	3.70	0.4999
1.15	0.3749	2.45	0.4929	3.75	0.4999
1.20	0.3849	2.50	0.4938	3.80	0.4999
1.25	0.3944	2.55	0.4946	3.85	0.4999
1.30	0.4032	2.60	0.4953	3.90	0.5000

This table shows, for example, that between the mean and 0.35 times the standard deviation above or below the mean (see seventh line of table) there is 0.1368 of the whole population; between the mean and 0.90 times the standard deviation above or below the mean is 0.3159 of the population; and between the mean and 2.10 times the standard deviation above or below the mean is 48.21 per cent of the population. The table may be used backwards. If one wants to know within what limits, equidistant from the mean on either side, 80 per cent of the population is to be found, it is only necessary to look at the bottom of the first column where the limit of approximately 40 per cent (0.4032) is given. It appears there that 80.64 per cent lies within the limits of 1.30σ above and 1.30σ below the

mean. If more precise limits are to be set, a more complete table is needed, or one must interpolate between the points given.

This table of distribution of a normal population is most important in judging of the significance of means and other statistical values.

Reliability of the Mean.—The means with which statistical work deals are usually computed from only a small fraction of the individuals which might have been included. If the mean thus obtained is near the mean of the whole group, it is reliable; if the mean of a limited number is apt to be far from the mean of the whole existent population, it is unreliable. Reliability depends on how variable the population is, and on how many individuals have been obtained from it for study and measurement. How a measure of reliability is to be devised should be clear from the following considerations.

If an investigator today takes 500 individuals from a population consisting of a million or more, he obtains from them a certain mean. Tomorrow he takes

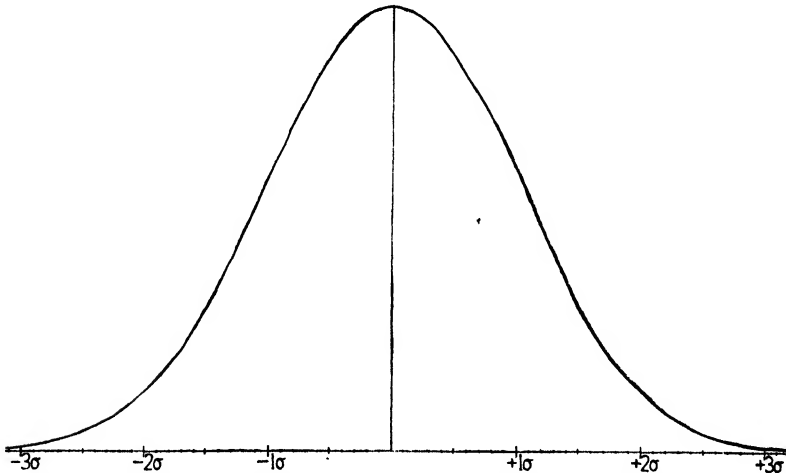

FIG. 153.—Normal curve of variation, with multiples of the standard deviation marked on the base line.

another 500 and obtains another mean. It is not the mean obtained from the first 500, and neither mean is that of the entire million. He and other investigators take various samples, not always the same number of individuals, and calculate from them various means. Probably no mean is identical with any other one. Yet they tend to cluster about a certain value. Indeed, the distribution of these means is of the same sort as the distribution of individuals in Fig. 153. The means all fall within a certain range. The bulk of them accumulate near the middle of that range, while fewer and fewer are successively farther and farther from the middle point. Theoretically the value around which the various means tend to collect is the real mean of the population of a million, or whatever the total number is. In statistical work one is constantly trying to judge what that real mean is from the mean of a much smaller number of individuals.

Standard Error of the Mean.—These attempts focus on the calculation of what is called the standard error of the mean. This standard error may be symbolized

by σ_M , and is defined by the equation

$$\sigma_M = \frac{\sigma}{\sqrt{n}}$$

in which σ is the standard deviation of the limited group whose mean is being judged as to reliability, and n is the number of individuals from which the mean was computed. The letter σ is used as the symbol of the standard error because that error corresponds to the standard deviation of a large number of means separately calculated from different samples of the entire extant population. Consequently the standard error may be used as the unit of measurement in Table 3, in place of the standard deviation. Some practice in making this use of Table 3 is desirable.

To make the judgment concrete, we may return to the weights of hens' eggs in Table 1. The mean weight of these eggs was 1.99 ounces, their standard deviation was 0.17 ounce, and the number of eggs was 291. Substituting the pertinent numbers in the equation of the standard error of the mean, we find that

$$\sigma_M = \frac{\sigma}{\sqrt{n}} = \frac{0.17}{\sqrt{291}} = 0.01 \text{ ounce}$$

This standard error of the mean, 0.01 ounce, is indicated by writing the mean as 1.99 ± 0.01 ounces.

What does this standard error tell us? Since the standard error corresponds to a standard deviation, Table 3 is the criterion of judgment. Three times the standard error above and below the computed mean are limits within which the real mean is almost certain to lie. These limits for the hens' eggs are 2.02 and 1.96 ounces, respectively. Though the mean of only 291 eggs has been ascertained, it is practically certain that, had an indefinitely large number of eggs from the same source been weighed, their mean would not have been over 2.02 or under 1.96 ounces. If a narrower limit be set, say two times the standard error, it is found from the center of Table 3 that 95.44 per cent (twice 0.4772) of the chances are that the real mean weight is within this narrower range. That is, if all the possible eggs from that source had been weighed, there are less than 5 chances in 100 that their mean would have been more than 2.01 or less than 1.97 ounces. Still narrower limits may be set, and Table 3 shows what chance there is that the real mean falls within them.

Most investigators are content to regard 9974 chances out of 10,000 as practical certainty (see eighth line of last columns of Table 3), and consider that the real mean of any indefinitely large population is not more than three times the standard error away from the computed mean of a limited portion of that population.

Other Standard Errors.—Every other value computed in statistical work has its standard error, which is the measure of reliability. Everywhere it corresponds to the standard deviation, and Table 3 is used to determine the significance of the quantity to which it relates. For the standard deviation the standard error is

$$\sigma_\sigma = \frac{\sigma}{\sqrt{2n}} = 0.7071\sigma_M$$

For the coefficient of variability the standard error is

$$\sigma_v = \frac{V}{\sqrt{2n}} \sqrt{1 + 2 \left(\frac{V}{100} \right)^2}$$

One of the most useful of standard errors in genetic work is that pertaining to a proportion. It is desired to know how far the actual ratio obtained in an F_2 generation may depart from the expected 3:1 without indicating differential mortality, lethal homozygosis, or indeed anything else than chance. The standard error of the ratio gives that information. If the group under consideration is expressed as a fraction of the whole, the formula of the standard error is

$$\sigma_p = \sqrt{\frac{p(1-p)}{n}}$$

in which p is the proportion, and n is the total number of individuals. Thus, in an F_2 generation consisting of 289 individuals of which 205 are of one kind, 84 of another, how likely is it that this distribution differs in any but an accidental way from a ratio of 3:1? The actual proportion in the majority group is 0.7093. The standard error of this proportion is accordingly

$$\sigma_p = \sqrt{\frac{0.7093 \times 0.2907}{289}} = 0.0267$$

It requires only 1.52 times this standard error to be added to 0.7093 to make it the theoretical 0.75; so according to Table 3 there are about 13 chances in 100 that the drop to 0.7093 is purely accidental.

Without converting the numbers of individuals into a proportion, the standard error can be computed according to the formula

$$\sigma = \sqrt{\frac{c(n-c)}{n}}$$

in which c is the number of members of one of the two classes, and n is the total number of individuals. The standard error thus computed is in individuals, not a fraction. Its significance and use in connection with Table 3 are not in any way changed. The major class of the pair just used is

$$205 \pm \sqrt{\frac{205 \times 84}{289}} = 205 \pm 7.7$$

It would take adding only 1.52 times this standard error to 205 to make it the 216.75 that would be exactly three-fourths of the total.

Standard Error of a Difference.—Frequently it is desired to know whether one population differs from another as indicated by their means or whether one is more variable than another as indicated by their standard deviations. Each mean or each standard deviation has been calculated with its own standard error. The difference between the means, for example, is found by simple subtraction. The standard error of that difference is determined from the errors of the two means by the equation

$$\sigma_d = \sqrt{\sigma_a^2 + \sigma_b^2}$$

in which σ_a is the standard error of the one mean (or other measure) and σ_b is the standard error of the other mean. If one mean is 28.6 ± 0.93 and the other is 26.9 ± 0.54 , the difference between them is

$$1.7 \pm \sqrt{(0.93)^2 + (0.54)^2} = 1.7 \pm 1.07$$

The difference is only 1.59 times its own standard error, and, by referring to Table 3, we find that there are about 89 chances in 100 that the two means represent really different populations, or 11 chances in 100 that the difference is due only to the accidents of random sampling. A difference must be at least three times its standard error to make it practically certain (9974 chances in 10,000) that it is not merely accidental.

Probable Error.—Some investigators prefer to use a measure of reliability that divides the probabilities evenly. They wish to attach to any uncertain measure an error that is just as likely to be exceeded as not. To ascertain what this error is it is only necessary to find in Table 3 that multiple of the standard deviation which marks off 0.25 of the population (which is 0.50 when fluctuation both positively and negatively is included). This multiple is nearly midway between 0.65 and 0.70 times the standard deviation. By interpolation it is found to be 0.6745. Hence, an error that is 0.6745 times the standard error is chosen. This measure of reliability is called the probable error. The probable error of a mean is

$$PE_M = 0.6745\sigma_M = \frac{0.6745\sigma}{\sqrt{n}}$$

The probable error of a standard deviation is

$$PE_\sigma = 0.6745\sigma_\sigma = \frac{0.6745\sigma}{\sqrt{2n}}$$

Any probable error may be found by multiplying the corresponding standard error by 0.6745.

There is no advantage in the probable error, but it is still frequently used. It entails more labor: (1) it requires one more multiplication to calculate it; and (2) if Table 3 is to be used in forming judgments of probability, the probable error must first be divided by 0.6745 before the table is of service.

In connection with error, either standard or probable, it should be made clear that it does not refer to any mistake in calculation or in the original observations or measurements. It is merely the error which one makes in assuming that the entire population is like the limited sample which has been studied.

Correlation.—Many geneticists find the principle of correlation useful as evidence of heredity when other signs fail. Correlation is a connection between two properties of the individuals of a population such that, as one of the properties varies, the other tends to vary. If as one property increases the other tends to increase, the correlation is positive; if as the one property increases the other tends to decrease, the correlation is negative. Positive correlation indicates that the two qualities have part of their physiological bases in common, and the physiological bases are not infrequently genetic.

The most commonly used measure of correlation is Pearson's coefficient of

correlation, defined by the equation

$$r_{xy} = \frac{\sum d_x d_y}{n\sigma_x \sigma_y}$$

but calculated from a more complicated equation to be given later. To use it, one must first have measures of the two qualities in each of a considerable number of individuals. The data are collected with the idea of correlation in mind and are entered in a table ruled in squares. To make the discussion concrete, suppose that one contemplates ascertaining any correlation between the depth of yellow color in the ear lobes of fowls and the number of eggs they lay. A color chart or some more objective way of determining yellow must be available, and we may arbitrarily divide the range of color into nine grades, 1 the palest, 9 the darkest yellow. If it be guessed that the poorest layers will produce at least 100 eggs in a year, the best ones less than 200, the egg production may be divided into 10-egg classes, beginning 100-109, 110-119, and ending 190-199.

On a sheet of cross-section paper the egg-production classes may be written along the top, and the color classes down the left margin. Suppose the first hen is of color grade 5 and lays 132 eggs; a dot is placed in the square in the fifth row and fourth column. For a hen which is of color grade 2 and lays 160 eggs, a dot

TABLE 4

Color \ No. of eggs	100 to 109	110 to 119	120 to 129	130 to 139	140 to 149	150 to 159	160 to 169	170 to 179	180 to 189	190 to 199	Color
	1						1 -4				
2				4 +12			2 -12		1 -12		7
3		2 +12			7 0	4 -8	2 -8	2 -12			17
4			9 +18	8 +8	14 0	8 -8	8 -16	4 -12	2 -8		53
5		7 0	6 0	13 0	11 0	9 0	7 0	4 0		1 0	58
6		3 -9	5 -10	10 -10	12 0	10 +10	5 +10				45
7	1 -8	4 -24	3 -12	5 -10	7 0	6 +12	3 +12				29
8		2 -18		1 -8	2 0	2 +8		1 +9			8
9			1 -8			1 +4					2
Eggs	1	18	24	41	53	41	27	11	3	1	220

is placed in the square in the second row and seventh column. Each fowl is recorded by a dot. When the data are complete, the dots in the several squares are counted and the number written in place of them. The result is what is called a correlation table (Table 4).

By summing up the horizontal rows there is obtained at the right the distribution of the color classes of the hens; and by adding the columns there is placed at the bottom the distribution of the egg production of the same hens. For each of these distributions there is calculated usually the mean and always the standard deviation, by the methods already described. The calculations should be preserved, for some portions of them enter into the computation of the coefficient of correlation. Suppose that the assumed mean color grade was 5, and the assumed mean egg production was 144.5, both being the middle points of the ranges of the most numerous classes. If these classes are marked off by heavy lines, the table is divided into quadrants.

The equation used to calculate r differs from the defining one already given, because assumed means have been used in order to save labor. This calculating formula is

$$r_{xy} = \frac{\sum fd_x'd_y' - \frac{(\sum fd_x')(\sum fd_y')}{n}}{n s_x s_y}$$

in which d_x' is the deviation of any group from the assumed mean egg production, d_y' is the deviation of the same group from the assumed mean color grade, f is the number in the respective squares of the table, n is the number of hens in the total sample, s_x is the standard deviation of egg production in class intervals (not eggs) s_y is the standard deviation of color grade in class intervals, and Σ is the sign of summation.

The first term in the numerator of the formula is now computed. The frequency 2 in the upper left quadrant of Table 4 is that of a class which deviates -3 from the assumed mean egg production and deviates -2 from the assumed mean depth of color. For this group, therefore, $fd_x'd_y'$ is $2(-3)(-2)$, which is $+12$. This product is set in small figures in the square with the frequency. For the group of 4 in the lower left quadrant, the deviation from one mean is -3 , from the other $+2$; hence $fd_x'd_y'$ is $4(-3)(+2)$ or -24 . The corresponding products are computed for the other groups in the table. In the assumed mean classes all products are 0 because one of the deviations is 0. In the upper left and lower right quadrants all products are positive, those of the upper right and lower left are all negative. The quantity $\Sigma fd_x'd_y'$ is the sum of all these products, with their signs taken into account; for this particular table it is -99 .

The value of $\Sigma fd_x'$, used in computing the mean egg production, was found to be -2 . That of $\Sigma fd_y'$, used in determining the mean color grade, was $+23$. The total number n is 220; σ_x is 17.0 eggs; hence s_x is 1.7 class intervals; and σ_y is 1.45 color grades, so that s_y is 1.45 class intervals. If these concrete values be substituted in the equation, it is found that $r = -0.18$. The correlation is negative; as egg production increases, depth of yellow color is diminished.

Values of r range from 0 to 1, either positive or negative. If one quality has no relation whatever to the other, r is 0. If, for a given value of one variable, there is inevitably a certain value of the other variable, r is 1. The relation between ear-lobe color and egg production is therefore relatively slight. The standard error

of the coefficient of correlation is

$$\sigma_r = \frac{1 - r^2}{\sqrt{n}}$$

However, since r is not a very accurate measure of the common basis of the correlated properties, the standard error is of less use than elsewhere. For Table 4, $\sigma_r = 0.065$; the coefficient of correlation is thus only 2.77 times its error, and hence not very meaningful.

Genetic Uses of Correlation.—In asexually reproducing organisms, the heredity of a variable character cannot be proved by comparison of parents and offspring in a single family, since the parents might accidentally be below the mean of their strain while the offspring might, likewise accidentally, be above the mean of their strain. Size of the protozoan *Paramecium* fluctuates tremendously without any genetic basis for the variability; the number of spines on the shell of *Diffugia* varies less, also without any corresponding genetic change. If in these examples the character of the parents be plotted against the mean of their offspring in a correlation table and a positive coefficient of correlation is obtained, this is evidence that the size or the number of spines has a genetic foundation as well as an environmental one.

In man a quantitative character like the nasal index may vary so much as to leave one in doubt, in single pedigrees, whether it is inherited or not. If in this situation a number of identical twins are available, correlation between them may be compared with correlation between fraternal twins. If the former correlation has a higher coefficient than the latter, nasal index is partly hereditary.

PROBLEMS

234. What is the nature of the error to which the terms "standard error" and "probable error" refer?

235. In demonstrating that a blending character is determined by a group of similar nondominant cumulative genes (as in red color of wheat, page 115), show that standard deviation or coefficient of variation of the F_1 and F_2 generations is more important than their means.

236. If the mean of a collected sample is 17.4 with a standard error of 0.15, how likely is it that the mean of the natural population from which the sample was taken is over 17.7?

237. When one says that a mean based on 400 individuals is better than a mean based on 100 individuals, is the improvement a greater probability that the mean is correct? If not, what is the measure of improvement?

238. If an F_2 generation consists of 215 individuals of one kind and 65 of another, where a 3:1 ratio was expected, how likely is it that one needs to look for some disturbing factor, such as lower viability of the recessive individuals?

239. If two snail samples taken from streams *A* and *B* have mean lengths of 15.6 ± 0.24 and 15.9 ± 0.19 , respectively, what is the probability that the snails of stream *A* are longer than those of *B*, instead of shorter as the samples indicate?

240. If you used correlation to show whether the number of spines is inherited in the asexually reproducing protozoon *Diffugia*, what would you write at the top and side of the correlation table? What result would show that the number is inherited?

241. If a line be drawn around all the numbers within a correlation table, what geometric form does the figure tend to take if there is correlation? If the correlation is high, how does the form of this figure differ from its form when correlation is low?

242. What would the geometric figure referred to in the preceding problem become if correlation were perfect ($r = 1$)? What would it be in the absence of correlation ($r = 0$)?

243. Men were once said to be more variable than women because their standard deviations (of stature, strength, etc.) were greater. Discuss the error of this conclusion.

244. If only one individual has been taken from a population, and it is being regarded as representative of the whole group, what property of the population, if known, would constitute the standard error of such individual?

245. If you have collected 40 specimens and find that the smallest is 13 mm. long and the largest 20 mm. long, make a rough estimate of the standard deviation of the group as it should be when you have collected 300 specimens.

LIST OF VISUAL AIDS

The following list of visual aids may be used to supplement some of the material in this book. It is suggested that each film be previewed before use as some may contain information that is too advanced or too elementary.

These films may be obtained from the producer or distributor listed with each title. (The addresses of the producers and distributors are given at the end of this listing.) In many cases these films may be obtained from your local film library or local film distributor; also, many universities have film libraries from which they may be borrowed.

The running time (min) and whether it is silent (si) or sound (sd) are given with each title. All those not listed as color (C) are black and white. All of the motion pictures are 16mm.

Each film has been listed only once. However, many films may be used advantageously with several chapters.

Heredity (EBF 10min sd). Presents Mendelian laws of inheritance; explains mitosis and meiosis in relation to genes; chance combinations of sperm and eggs; genotypes and relationships.

Heredity in Animals (VisLib 20min sd). Explains the principles of heredity; illustrates the processes of mitosis and meiosis.

Heredity in Man (VisLib 15min sd). Presents a number of superior British genealogies with inference that heredity plays a leading role in physique, musical talent, and artistic abilities; contrasts these pedigrees with others in which many of the offspring are feeble-minded or crippled.

From Generation to Generation (VisLib 25min sd). A condensation and combination of "Heredity in Animals" and "Heredity in Man."

The Living Cell (EBF 15 min si). Describes the division and growth of single-celled organisms; yeast, amoeba, paramecium; many-celled organisms; hydra and flatworms; tissue cells; cell division.

Development of the Bird Embryo (EBF 15min si). Describes development of the bird embryo using the chick for early stages and the wren for last stage and hatching.

Development of a Fertilized Rabbit's Ovum (EBF 15min si). Shows the segmentation of the fertilized ovum.

Fertilization—A Study through the Microscope (EBF 8min si). Pictures entrance of sperm into eggs of marine invertebrates; cleavage divisions of fertilized eggs.

Ovulation, Fertilization and Early Development of the Mammalian Egg (USDA 30min si). Portrays ovulation; spermatozoa attacking the ovum; cell division in fertilized egg.

Reproduction among Mammals (EBF 10min sd). The story of embryology using the domestic pig for an illustration.

Reproduction in Higher Life Forms (Bray 15min si). Describes reproduction in fish, reptiles, birds, and mammals.

Reproduction in Lower Life Forms (Bray 15min si). Shows primitive hydra; reproduction by budding; cell division of paramecium.

Human Body Series, Part VII: Human Development (Bray 23min si). Presents the reproductive system; fertilization of the ovum and various stages of development of the embryo and fetus.

Wizards of Svalof (USDA 14min sd). Shows the practical side of the work in the laboratory; shows Swedish scientists at work at Svalof; illustrates changes in plants and improvement as a result of scientific selection, crossbreeding, X-ray and chemical treatment of seeds.

Achievement (Allis-Chalmers 11min sd C). Portrays the growing of hybrid corn.

The Desert Harvest (Bray 4min si). The cactus made spineless—an accomplishment of Luther Burbank.

SOURCES OF FILMS LISTED ABOVE

Allis-Chalmers Mfg. Co., Milwaukee, Wis.

Bray Studios, Inc., 729 Seventh Ave., New York, 19

EBF—Encyclopaedia Britannica Films, Inc., 20 N. Wacker Dr., Chicago 6

USDA—U. S. Dept. of Agriculture, Motion Picture Div., Washington, D.C.

United World Films, Inc., 445 Park Ave., New York 22

VisLib—Visual Library, 1600 Broadway, New York 19

INDEX

Numbers in **boldface** indicate pages bearing illustrations

A

Abortion, resistance to, in rabbits, **229**
Acquired characters, old ideas of heredity of, 1
Adaptation, evidence of guidance of evolution by selection, 188, **189**
Adrenals, influence on nervous and circulatory systems, 127
Agglutinins, in blood serum, 79, 80
Agglutinogens, 143, 208, 209
 independence of production in blood cells, 158, 159
 racial frequencies of, **273**
 in red blood cells, 49, 50, 79, 80, **82**
Albinism, 193
 nature of mutation causing, 156, 157
Alcaptonuria, nature of mutation causing, 157, 158
Algae, number of genes in, 146
Alleles, 75
 multiple, 75-82
 and blood groups in man, 78, 79, **80, 81**
 dominance of, 78
 in *Drosophila*, 76, **78**
 in human eye color, 81
 in mice, 78
 in rabbits, **77, 78**
 in snapdragons, **77**
 symbols of, 76-77
 origin of, 75
Allergy, 207, **208, 209**
Alpine race, **274**
Amaurotic idiocy, 219, 241
Amino acids, 11
 synthesized by *Neurospora*, 155
Amoeba, fission of, **19**
Andalusian fowls, 50
Anemia, 209

Anther, **23**

Aphids, resistance to, **228**

 wings dependent on light, 124

Applied genetics, 226-240

Armadillo, multiple embryos of, 171

Arteriosclerosis, 210

Arthritis, 210, 211

Artistic ability, 225

Asexual reproduction, 19-21

Asthma, 208

Astigmatism, 205, 206

Ataxia, 214

Autonomy, developmental, 31

Autosomal character, recombination
 with sex-linked, 100, **101, 102-103**

Autosomes, 64, **65**

 containing sex genes, 168, 169, 177

 in man, 64, **65**

B

Backcross, 59, **60, 61, 62, 63**

Baldness, 195, **196, 204**

 dominance related to sex, 112, **122**

Bar eye, in *Drosophila*, a duplication,
85, 86

Barley, awns and yield of, **233**

Basal metabolism, racial differences in,
273

Bateson, and rediscovery of Mendel, 7

Beans, resistance to virus, 164

Birds, color affected by food, 125

Birthmarks, 202

Birth rate, crude rate, **258**

 decline of, 257

 reasons for, 261

 in different populations, 259-261

 in economic classes, 260

 effect of war on, **261, 262**

 in eugenics, 261

Birth rate, in racial classes, 260
 urban-rural contrast in, 259, **260**, 261,
 265, **266**
 Blastula, **27**, 28
 Blending inheritance, 1, 2, 116, 122
 Blight resistance, 227
 Blood-group agglutinogens, 50
 Blood groups, 82, 91, 143, 158, 159, 208,
 209
 clinical test for, 79, **80**
 distinguishable heterozygotes, 100
 in legal questions, 238-240
 as multiple alleles, 78, 79, **80**, 81
 Blood pressure, 210
 Blood vessels, defects of, 203
 Body build, 201, 202
 Bone, abnormalities of, 200, 201
 brittleness of, 201
 Brachydactyly, in disputed paternity,
 237
 Brachyphalangy, 48, 49, 200
 possibly lethal in homozygote, **89**, 90
 Brain waves, in epilepsy, 219
 in twins, **220**
 Bronchitis, 208
 Budding, **20**
 Butterflies, color in, 113, 122

C

Cancer, 213, 214
 of breast, in mice, 163
 Cataract, 205
 Cattle, color of, 99
 in Ayrshires, 121
 genes determining butterfat, 232, 233
 inheritance of horns, 99, 232
 intersexes in, 177
 Caucasian races, 271, 272
 Cell division, 14, 15-18
 significance of, 17-18
 Cell membrane, **12**
 Cells, characteristics of, 11-13
 chemical composition of, 11
 cooperation among, 13
 generalized structure of, **12**
 germ and somatic, 13-14
 nature and origin of, 11-18
 Cell wall, in plants, **15**
 Centriole, **12**
 Centrosphere, **12**
 Cephalic index, **199**, 271, **272**
 Chance, in casting dice, **243**, **244**
 in direction of evolution, 186, 187, 190
 in family histories, 243, **244**, 245, 246,
 253
 Chemical substances, affecting heredi-
 tary characters, 126-128
 cause of mutation, 154
 China, population problem in, 257
 Chondriosome, **12**, 13
 Chromatin, **12**, 13
 Chromogen, interaction with enzyme,
 108
 Chromomeres, 15, **16**, 17
 Chromosome map, **132-136**, 137, **138**,
 139, **140**, **186**
 Chromosome number, in different spe-
 cies, 183
 doubling of, 181
 relation to isolation, 189
 Chromosomes, **14**, 15
 aberrations in, 149, 150
 arrangement of pairs in reduction
 division, **92**, **93**
 homologous, 35, **36**, 38, 39
 individuality of, 17, 18
 lengthwise duplication of, 18
 locating genes in, 149, 150
 in man, 64, **65**
 mechanism of heredity, 8
 pattern in, 15, **16**, 17
 proof that they contain genes, 145-
 150
 relation to sex, 166-168
 in salivary gland of *Drosophila*, 149,
 150
 Ciona, effect of nutrition on, **184**, 185
 Cleavage of egg, **27**, 28, **37**
 influenced by cytoplasm, 29
 Cleft palate, 199, 242
 Clubfoot, 201
 Coefficient of correlation, 293-297
 Coefficient of variation, 287, 288, 296,
 297
 Color blindness, 68, **69**, 70, 73, 143, 216
 total, 206
 Combs of fowls, **107**, 108

- Compounds of multiple allelic mutations, 78
- Corn, color of endosperm in, 105, 122
 heredity in, 9
 resistance in, 228, **229**
 segregation in, **3**
- Corn borer, resistance to, **229**
- Correlation, 293-296
 coefficient of, 293-297
 genetic uses of, 296
 table of, 294, 296
- Correns, and rediscovery of Mendel, 7
- Cosmic rays, cause of mutation, 153-154
- Cotton, length of fiber in, **232**
- Cranial capacity, 272
- Creeper fowl, 106
 lethal as homozygote, 88, 90, 91
- Cretinism, 212, 217
- Crime, 220-222, 225
- Crossing over, **134**, 135-137
 relation to sex, 136-137, 143
 unequal, 153, 180
 between X and Y chromosomes, 192
- Crustacea, shape changed by salt, 126
- Cytoplasm, **12**
 influence on cleavage, 29
- Cytoplasmic inheritance, 160-164
- D**
- Day blindness, **206**
- Deaf-mutism, 207
- Deafness in man, 122, 207
- Death rate, 262, 263
 in eugenics, 251, 252
- Deficiencies in chromosomes, 85, 149
 a part of Mendelian process, 160
- Dementia praecox, 218
- Determination, organic, 28-31
 time of, 30-31
- Development, autonomy in, 31
 embryonic, 28-32
- De Vries, and rediscovery of Mendel, 7
- Dexter cattle, lethal as homozygote, 88, 90
- Diabetes insipidus, 210
- Diabetes mellitus, 210
- Dice, random positions of, **243**, 253
- Dimples, **203**
- Diploid, 38, 42
- Diploidy, a two-gene condition, 146-147, 150
- Dominance, 51-58
 affecting F_2 ratio, 99-100
 contradictory conclusions concerning, 191, 192
 judged from family histories, 58
 in lethal homozygotes, 89-90
 modified by sex, 111-112
 among multiple alleles, 78
 recognition of, in man, 54-58
- Dopa, source of melanin, 157
- Drosophila, abnormal abdomen affected by moisture, 126
 alleles in, white-eye series of, 76, 78
 bar eye changed by temperature, 123
 bar-eye mutation, 153, **180**
 body color, 100, **101**, 102-103, 105
 bristle shape, 100, **101**, 102-103, 110
 chromosome maps, **132-134**, 136-137, **138**, 139, **140**
 color of eye, 105
 determination of, 31
 and ocelli, 96, **97**
 crossing over related to sex, 136-137
 curled-wing mutation, **131**, 132-135
 dichaeete a lethal, 89, 90
 doubling chromosome number, 181
 gynandromorphic, **170**
 hairy-wing mutation, 153
 haplo-4 in, **84**, 85, 148
 haploidy, and sex, 171
 of single chromosome, 181
 heredity in, 9
 isolation of two species, 190
 linkage, in female, 134-135
 in male, 131-134
 material for study, **33**
 mutations affecting oxidation, 158
 nature of vermilion and cinnabar mutations, 158
 parallel mutations, 185, **186**
 sable body color, **66**, 67, **68**
 scute mutation, 183, **184**
 sexes, intersexes and supersexes in, 168, 169
 shape of wing, 105

Drosophila, star eye a lethal, 89, 90, 91
 various mutations in, **180**
 vestigial wing affected by temperature, 123, **124**
 white-eye series of alleles in, 76, 78
 white ocelli, 132-134

Duplicate genes, 119, **120**, 121, 148, 149
 origin of, **120**

Duplication of genes, in chromosomes, **85**, **86**, 180
 a part of Mendelian process, 160

Dystrophy, muscular, **202**

E

Ear lobe, in man, 196, **197**

Ear pits, in man, 196

Ear shape, 196, **198**

Ectoderm, 28, **29**

Eczema, 202, 208

Edema, 208

Egg, **22**, **23**, **37**, **38**
 definition of, **22**

Embryology, aims common to genetics, **32**

Embryo sac, **23**, 24, **40**

Endocrine glands, 126, **127**
 as internal environment, 128-129

Endoderm, 28, **29**

Endosperm, in flowering plant, 42

Environment, affecting hereditary characters, 123-129
 contrasted with heredity, 129
 internal, 128-129

Enzyme, in color reaction, 108

Ephestia, cytoplasmic influence on eye color, 164

Epidermolysis bullosa, 202

Epilepsy, 219, 220

Epistasis, 113

Equation division, **37**, **38**

Erthyroblastosis, 246

Eugenics, 239, 241-253
 positive program of, 250, 251, 253
 methods of, 252, 253
 public program, 247-249

Eugenics Record Office, 10

Euplotes, independent action of multiple mating-type alleles, 159

Evolution, guidance of, 185-189
 chance in, 186, 187
 relation to heredity, 179-190

Eye color, in man, **55**, 114, 192, 193

Eye defects, 205-207

F

F₁, defined, 44

F₂, defined, 44

Family limitation, basis of judgment concerning, 242, 253
 calculating risks, 243-246, 253
 decisions concerning, 241, 242
 public policy concerning, 246, 253
 unpredictable features of, 245, 246

Feeble-mindedness, **62**, 217, 218, 220, 243, 244, 246-248
 impossibility of eliminating, 249, 250
 a public burden, 246, 247

Fertility of races, 278, 279

Fertilization, **23**, **37**, 39

Fingerprints, 203, 204

Fission, **19**

Flower, reproductive parts of, **23**

Four-o'clocks, color inheritance in, 62, **63**

Fowls, color in, 74, 106, 113, 118, 119, 121
 comb shapes, 58, 105, **107**, 108, 122
 creeper form, 106
 crest of, 106
 feathers on shanks, 105, 106
 modification of sex in, **173-176**

Freemartin, 177

Friedrich's disease, 214

G

Galton, Sir Francis, and human heredity, 9-10, 241, **242**, 252

Gamete, 47

Gametophyte, **14**
 of moss, 146

Gastrula, **27**, **28**, **29**

Gemmules, 21

Genes, 28, 33-36
 action of, 152-159
 in homologous chromosomes, 35, **36**

- Genes, independence of, 92-99
 interactions of, 107-121
 nature of, 151, 152
 number of, 33
 proof they are in chromosomes, 145-150
 symbols of, 54
- Genetics, aims common to embryology, 32
 modern, rise of, 1-10
- Genic balance, and determination of sex, 168, 169
- Genotype, 47
 in dihybrid F_2 generation, 96
 recognition of, in man, 61, 62
- Germ cells, 13-14
- Glioma retinae, 214
- Goster, 212, 217
- Golgi apparatus, 12
- Gradients, in development, 31-32
- Grapes, resistance to phylloxera, 228
- Growth, 201, 202
- Growth curves, 254, 255, 269
- Guinea pigs, rough and smooth coats of, 59, 60, 61, 63
- Gynandromorphs, 169, 170, 177
- Gypsy moth, intersexes of, 176
 sex in, 169

H

- Habrobracon, independent action of multiple sex alleles in, 159
- Hair, color of, 98, 109, 113, 194
 distribution of, 195
 form of, 98, 195, 196, 204
- Haplo-4, in *Drosophila*, 84, 85, 148, 181
- Haploid, 38, 42
- Haploidy, a one-gene condition, 146-147, 150
- Harelip, 199, 242
- Hay fever, 208
- Head form, 199, 200
 in race hybrids, 199, 200
- Hemophilia, 209
- Heredity, ancient ideas concerning, 1
 and legal questions, 237-239
 in man, 9-10, 191-225
- Heredity, in man, difficulty in discovering, 191, 192
 mechanism of, 33-42, 145, 146
 same as evolution mechanism, 179
 particulate, 2-3
 practical applications of, 10
 relation to evolution, 179-190
- Hernia, 203
- Hessian fly, resistance to, in wheat, 228
- Heterosomes, 64, 65, 73, 166
 genes in, 65, 66
 in man, 64, 65
- Heterozygote, 47
 independent action of allelic genes in, 158, 159
 recognizable in man, 48-50
- Hill Folk of Massachusetts, 222
- Hippocrates, ideas of heredity, 1
- Hives, 208
- Homozygote, 47
- Honey, levulose and dextrose in, 233
- Honeybee, number of genes in cells, 150
 sex determination in, 171
- Hormones, affecting growth, 201, 202
 affecting hereditary characters, 126-128
 determining secondary sex characters, 173, 174
 relation to heredity, 130
 relation to racial characters, 128
- Horns, in sheep, 112
- Horses, color of, 232
- Huntington's chorea, 215
- Hybridization, of races of men, 276, 277
 disharmonies in, 277
 as source of knowledge of heredity, 43
 of species, 183
- Hybrid vigor, in barley, 236
 in corn, 234, 235, 236
 in various plants, 236, 240
- Hydra, budding in, 20

I

- Ichthyosis, 202
- Identical twins, 172
 intelligence quotients of, 222, 223, 225
 in study of heredity, 130
- Idiocy, amaurotic, 219, 241

- Immigrants, Laughlin's studies of, 281, 282, 283
 contrast of northwestern and southeastern Europe, 281, 282
 weakness of, 282, 283, 284
- Immigration, to United States, 279-284
 course of, 279, 280
 restriction of, 279-282
 none against Western hemisphere, 280
- Immigration policy, 279-283
 improvement in, 283, 284
- India, population problem in, 257, 269
- Infection, susceptibility to, 211
- Inheritance, cytoplasmic, 160-164
 particulate, 10
- Inhibiting gene, affecting eye color, 192
 affecting skin color, 193
- Inhibitors, 113-114
- Insanity, 218, 219
- Insulin, in diabetes, 210
- Intelligence, 222-224
- Interactions of genes, 107-121
- Intersexes, 168, 176, 177
- Intersterility of species, 183
 source of, in *Drosophila*, 190
- Inversion, 180
- Ishmael, Tribe of, 222
- Isolation of species in evolution, 189-190

J

- Jaws, defective growth of, 199
- Juke family, 215, 221

K

- Kallikak family, 221
- Keratosis, 202
- Kölreuter, Joseph Gottlieb, plant hybridizer, 2
- Kynurenine, derived from tryptophane, relation to eye color, 158

L

- Lebistes, Y-chromosome character in, 72, 73

- Left-handedness, 215, 216
- Lethal characters, 83-91
- Lethal genes, 86
 dominance of, 89-90
 time of action of, 90, 91
 in yellow mouse, 87, 88
- Lethal homozygotes, 86, 87, 88, 89-91
 dominance in, 91
- Light, effect on hereditary characters, 124
- Linkage, 131-144
 in man, 142-144
 number of groups, 142, 143, 147, 148
 proof of, 135
 ratios in F_2 , 139, 141
- Lip thickness, in man, 196
- Lobster claw, 201, 242
- Locusts, resistance to, in Amargo corn, 228
- Longevity, 212, 213

M

- Malthus, "Essay on Population," 254
- Mammals, influence of nutrition on, 129
 unequal effects of parents on nutrition of offspring, 125, 126
- Manic-depressive insanity, 218, 219
- Marriage age, 261
- Maternal inheritance, 160-164, 165
- Mathematical ability, 225
- Maturation, 22, 23, 36-39
 involving heterosomes, 166, 167, 168
- Mean, 285, 286
 reliability of, 290, 291
 significance of, 286, 296
- Mediterranean race, 274
- Meiosis, 22, 23, 24, 25, 36-39
- Melanin, derived from dopa, 157
- Melons, inherited sugar in, 232
- Mendel, Gregor, and hawkweed experiments, 7
 neglect of, 6-7
 pea-experiments, 3-4
 rediscovery of, 7-8
 story of, 3, 4, 5, 6-8
- Mendelian heredity, definition of, 160
- Mendelian mechanism, 145-146
- Mentality of races, 275, 276

- Mice, color of, 51, **52**, **53**, 54, 63, 115-117
 multiple alleles in, 78
 short-tailed a lethal, 90, **91**
 manner of action, 90, **91**
 time of action, 90, **91**
 spotting factors in, 111
 yellow, as lethal, **87**, **88**
 size of litter from, 91
- Migraine, 208
- Migration, effect on frequency of genes, 182
- Mildew resistance, 227
- Mink, mutations of, **230**, 231
- Mitochondria, **12**, 13
- Modifiers, 110, **111**, 112
- Moisture, effect on hereditary characters, 126
- Mongolian fold, 196
- Mongolism, 212, 217
- Mongoloid races, 271, 272
- Monilethrix, 195
- Monohybrids, 43-45
- Mosses, life cycle in, **41**
 ploidy and number of genes in, 146, 147, 150
 reduction in, **41**
- Multiple alleles, 75-82
 and blood groups in man, 78, 79, **80**, 81
 dominance of, 78
 in *Drosophila*, 76, 78
 as explanation of irregular dominance, 192
 in hair color, 194
 in human eye color, 81
 for mating types in *Euplotes*, 159
 in mice, 78
 in rabbits, **77**, 78
 for sex in *Habrobracon*, 159
 in snapdragons, **77**
 symbols of, 76-77
- Multiple embryos, sex of, 171, **172**
- Muscle atrophy, 214
- Muscle defects, 202, 203
- Muscular dystrophy, 74
- Musical ability, 224, 225
- Mutation, 152-154, 179
- Mutation, in animal and plant improvement, 231, 232
 causes of, 183-185
 direction of, 185, 186, 190
 parallel, 185, **186**
 providing material for recombination, 182
 repeated, 186
 reversible, 186
 in somatic cells, 31-32
- Myopia, 143, 205, 206
- Myotonia, 215
- N
- Nägeli, correspondence with Mendel, 6
- Nams, 222
- Nasal index, 271-272
- Negroid races, 271, 272
- Nerve defects, 214, **215**, 216
- Net reproductive rate, 251, 253
- Neurospora, action of genes in, 154-156
 mutation in, 155, **156**
 of capacity to germinate, **189**
 segregation in, **155**
 testing for mutation, **156**, 159
- Night blindness, 143, 206, 216
- Nondisjunction, altering balance determining sex, 168
 causing shift of genes, 148
 a part of Mendelian process, 160
 producing gynandromorph, **170**
 reductional, 42, 83, **84**, 85, 91
 somatic, 18, **83**
- Non-Mendelian heredity, 160-165
- Nordic race, 274, **275**
- Nosebleed, 202
- Nose shape, in man, 196
- Notorious families, 221, **222**
- Nuclear membrane, **12**, 15
- Nuclear sap, **12**
- Nucleolus, **12**
- Nucleoproteins, material of genes, 152, 153
- Nucleus of cell, **12**
- Nutrition, affecting hereditary characters by, **124**, **125**, 126
 affecting siphons of *Ciona* by, **184**, 185

Nystagmus, 203

O

Oats, color of chaff in, 117, 118, 121
 Obesity, 201, 202, 210
 Oenothera, heredity in, 9
 Oneida Community, eugenics project
 in, 250, 251
 Oöcytes, 36, 37, 38, 39
 Oögonia, 36, 37
 Organizers, 30, 32
 Organs, formation of, 28-29
 Otosclerosis, 207
 Ovary, as endocrine gland, 127

P

Pancreas, production of insulin by, 127
 Paralysis agitans, 214
 Paramecium, conjugation in, 25
 fission in, 20
 sexual reproduction in, 24-25
 Parkinson's disease, 214
 Parthenogenesis, 26-28
 variability in relation to, 27-28
 Particulate inheritance, 2-3, 10
 Peaches, color of, 232
 Peas, flower color in, 108, 121
 size of plant and shape of pods in, 105
 Phenotype, 47
 Phenylketonuria, 218, 241
 Phenylthiocarbamide, ability to taste,
 207
 Phylloxera, resistance to, 228
 Pituitary gland, influence on growth
 and on other glands, 127
 Plant patents, 236, 237, 240
 Plants, ancient cultivation of, 1
 chromosomes related to sex in, 167,
 168
 Plastids, 12
 division of, 12, 18
 involved in variegation, 160, 162, 163,
 165
 Platyocellus, sex-linkage of color, 70-
 72
 Ploidy, relation to number of genes,
 146, 147

Polar body, 37, 38, 39
 Pollen, 23
 germination of, 24, 40, 41
 Pollen tube, 23
 Polydaetyly, 200
 irregularly dominant, 110-112
 Population growth, 255, 256, 257
 affected by war, 263
 and age distribution, 266, 267, 268
 adjustments to, 268, 269
 and areal differences, 265, 266
 eugenic implications of, 269
 predictions for future, 264, 265, 269
 Population problem, 254-269
 Position effect, 153, 180
 Poultry, broodiness in, 230, 231
 egg production of, 230, 239
 resistance to pullorum disease, 229
 size of eggs, 231
 Primula, Chinese, flower color changed
 by temperature, 123
 Probable error, relation to standard
 error, 293
 Prolactin, relation to broodiness, 231
 Proteins, 11-12 ~
 specificity of, 11-12
 Protenor, maturation in, 166, 167
 Ptosis, 203
 Pullorum disease, in poultry, 229

Q

Quantitative characters, 285-297

R

Rabbits, hair color of, 103-105, 110
 hair length of, 103-105
 multiple alleles in, 77
 resistance to abortion bacterium, 229
 Race, confused with language, nation,
 or religion, 270, 271
 definition of, 270
 Races, characters distinguishing, 271-
 272, 284
 classification of, 271, 274, 275, 284
 fertility of, 278, 279
 hybridization of, 275, 276
 mentality of, 275

- Racial composition of United States, 277-279
- Radiation, cause of mutation, 153-154, 183, 184
- Radishes, shape and color in, 106
- Ratio in F_2 , dihybrid derived from monohybrid, 95-96, 99, 100, 103
 modified by interaction of genes, 108, 109, 116-118, 121
 trihybrid, derived from monohybrid, 105
- Recessive, 51
- Reciprocal crosses, definition of, 64
- Recombination of genes, 4, 8, 92-105
 change in frequency of genotypes, 182
 in plant and animal improvement, 233, 234, 240
 as source of variation, 181-183
- Reduction division, 37, 38, 42
 in flowering plants, 40, 41
 in mosses, 41
- Regression, law of, 9
- Renal glycosuria, 211
- Replacement index, 259
- Reproduction, 19-32
 ancient ideas concerning, 1
 asexual, 19-21
 variability in relation to, 21
 sexual, 21-26
 variation in relation to, 25-28
 size of parental contribution, 32
- Reproductive rate, net, 251, 253
- Resistance, to fungous diseases in plants, 226-228
 to pests, 228, 229
- Retinitis pigmentosa, 206
- Rh factor, 208, 209
 relation to mental development, 218, 225, 245, 246
- Rickets, 212
- Roan cattle, color inheritance in, 48, 49, 50
- Rust resistance, in snapdragons, 227
 in wheat, 226, 227
- S
- Saint Vitus's dance, 215
- Salivary gland of *Drosophila*, 33-35, 43
 Salivary gland of *Drosophila*, chromo-
 somes in, 149, 150
 pattern of chromosomes, 34
- Salmonella pullorum, 229
- Schizophrenia, 218
- Secondary sex characters, 172, 173, 174, 175
- Seedless grape, 231, 232
- Segregation of genes, 3, 4, 8, 50
- Selection, in guidance of evolution, 187-189
- Selective advantage, 188, 190
- Sex, effect on dominance, 111, 112
 genes for, 168
 genetics of, 166-178
 and genic balance, 168, 169
 in plants, 167, 168
 reversal of, 175, 176
 suppressing autosomal character, 112-113
- Sex-linkage, 64-73, 142, 143, 148
 recognition in man, 68-69
- Sex-linked character, recombination with autosomal, 100, 101, 102-103
- Sheep, color of, 113-114
 horns of, 112
- Shepherd's-purse, capsule shape, 119, 120, 122
 leaf shape, 47, 48
- Silkworm moth, gynandromorphic, 169, 170
 shape of eggs, 165
- Skin, color of, 122, 193
 affected by light, 124
 distribution of, 193
 defects of, 202
- Smut resistance, 227
- Snails, direction of coiling, 163, 164, 165
- Snapdragons, inheritance of color in, 44, 45, 46, 47, 50
- Somatic cells, 13-14
 identical in one individual, 31-32
- Spastic paraplegia, 214
- Spastic spinal paralysis, 214
- Species, hybridization of, 183
- Spermatids, 37, 38
- Spermatocytes, 36, 37, 38
- Spermatogonia, 36, 37

Spermatozoon, **22, 23, 39**
 Spinal ataxia, 214
 Spores, 21
 Sporophyte, **41**
 of moss, 146, 167
 Spotting genes, 111
 Squash, color of, **93, 94, 95, 96, 114**
 shape of, **93, 94, 95, 96, 109**
 Squinting, 206
 Standard deviation, 287
 use of in genetics, 288-290, 296, 297
 Standard error, 290-293, 296
 of coefficient of variation, 292
 of difference, 292, 293, 296
 of mean, 290, 291
 of ratio, 292, 296
 relation to probable error, 293
 of standard deviation, 291
 Starfish, development of, **27**
 Statoblasts, 21
 Stature, a race character, 271
 Sterilization, 248, 249
 Stigma of flower, **23**
 Strabismus, 206
 Strawberries, improvement of, 234
 Stuttering, 215
 Susceptibility, inherited, 211, 212
 Sweat glands, racial differences in, 273
 Symmetry, origin of, 29-30
 Symphalangy, **55-57, 200**
 Syndactyly, **200, 201**
 gene in Y chromosome, **73**

T

Taste capacity, 207
 Teasel, stems affected by nutrition,
 124, 125
 Teeth, absence of, 198
 lack of enamel on, **198**
 resistance to caries, 198
 spacing of, 198, 199
 time of cutting, 198
 Temperature, effect on hereditary char-
 acters, **123, 124**
 effect on mutation, 183
 Testercross, 60, 61
 dihybrid, **96, 97**
 Testis, as endocrine gland, 127

Thomsen's disease, 215
 Thyroid, an endocrine gland, **127**
 Tobacco, recombination in, **233, 234, 235**
 Tomato, height of, 144
 shape of fruit, 144
 Translocation, 149, 180
 a part of Mendelian process, 160
 Tribe of Ishmael, **222**
 Trihybrid ratio in F_2 , 103-105
 with interaction, **222**
 Tryptophane, synthesis in Neurospora,
 156, 157
 Tuberculosis, resistance to, 211, 212
 Twins, identical, **173**

U

Ultraviolet as cause of mutation, 153,
 183
 Urticaria (hives), **208, 209**

V

Vacuole, **12**
 Variability, 286-290
 abstract measure of, **287, 288**
 in asexual reproduction, 21
 normal curve of, **288, 289, 290**
 in parthenogenesis, 27-28
 in sexual reproduction, **25-26**
 Variation, coefficient of, **287, 288, 296, 297**
 primary source of, 179-181
 secondary source of, 181-183
 Varicose veins, 203
 Variegation, in corn, **161, 162**
 in *Mirabilis*, **161**
 in plants, 160-163
 Vegetative reproduction, 19-21
 Virus, resistance to in beans, 164
 similarity to gene, 152, 159
 Vitamins, synthesized by Neurospora,
 155

W

W chromosome, 65, 166, 167, **170, 177**
 Wheat, bunt resistance in, **227**
 color of, 114-116, **122**

Wheat, rust resistance of, **226, 227**
Wilt resistance, **227**
Wins, **222**

X

X chromosome, 64, **65**, 166-168, **170**,
171, 177, 178
genes in, 148
relation to sex-linkage, 66-70
Xeroderma pigmentosum, **202**
X rays, a cause of mutation, 153
hastening mutation by, 183

Y

Y chromosome, 64, **65**, 166-168
genes in, **72, 73**, 148
Yellows in cabbage, **227, 228**

Z

Z chromosome, 65, 166, 167, 169, **170**,
178
relation to sex-linkage, 70-72
Zeros, **222**
Zygote, 47

