

# Birta Central Library

PILANI (Jaipur State)

Class No :- 778.6  
Book No :- H548C  
Accession No :- 32411





Color Photography  
for the Amateur





# Color Photography for the Amateur

---

by KEITH HENNEY

*Consulting Editor of Electronics; Consulting Editor of Nucleonics;  
Author of "Principles of Radio" and "Electron Tubes in Industry";  
Editor of "Radio Engineering Handbook"; Coeditor of  
"Handbook of Photography"; Associate, Photographic  
Society of America*

---

WHITTLESEY HOUSE

MCGRAW-HILL BOOK COMPANY, INC.

NEW YORK : TORONTO

COLOR PHOTOGRAPHY  
FOR THE AMATEUR

Copyright, 1938, 1948, by the McGraw-Hill Book Company, Inc.

All rights reserved. This book, or parts thereof,  
may not be reproduced in any form without  
permission of the publisher.

REVISED EDITION

32911

66 2186  
50

*The quality of the materials used in the manufacture of  
this book is governed by continued postwar shortages.*

PUBLISHED BY WHITTLESEY HOUSE  
A division of the McGraw-Hill Book Company, Inc.

Printed in the United States of America

---

## Preface

**G**REAT PROGRESS has been made in color photography during the ten years that have elapsed since the first edition of this book was published. New materials have become available; some old ones have been improved and simplified; and others have gone out of existence. All the existing methods of making transparencies and color prints are treated in this book, largely from the author's own experience with them.

The viewpoint is that of an amateur writing for other amateurs. It is quite probable, however, that the professional—the photographer who has to make his work pay—can learn from amateur techniques how to get the best possible results with the least expenditure of time, effort, and money.

Details of making transparencies on Kodachrome, which the manufacturer processes, and on Ektachrome and Ansco Color, which can be processed at home, will be found here. The techniques of making color prints by carbonyl, wash-off, and its modern version, dye transfer, as well as the single-exposure method by Printon, are described.

There is still no royal road to making color prints; but it is fun, and with care the results are both beautiful and a source of pride as examples of excellent craftsmanship.

**KEITH HENNEY**



---

# Contents

	PAGE
<i>Preface</i> .....	v
<b>CHAPTER</b>	
<b>I. INTRODUCTION</b> .....	<b>1</b>
Is color photography worth while? Is it expensive? Cost of transparencies and prints. Is it difficult? Use of exposure meter and exposure guides. Equipment needed for color. Experience needed.	
<b>II. COLOR AND COLOR PROCESSES</b> .....	<b>9</b>
What is color? The color spectrum. Qualities of color. Primary and complementary colors. Theory of vision. Properties of light. Color processes. Additive process. Subtractive process. Comparison of additive and subtractive processes.	
<b>III. FILMS AND FILTERS</b> .....	<b>26</b>
Film construction. The photographic process. H & D curve. Tone range. Film latitude. Light-intensity range. Density and contrast. Purpose of development. Effect of development on contrast. Contrast definition. Gamma. Calculation of gamma. Film types. Picture-making process. Color photographic methods. Filters. Filter factors. Exposure factor. Neutral density filters. Films for color separation. Correct exposure for color. Latitude, density range for color.	
<b>IV. MAKING TRANSPARENCIES</b> .....	<b>54</b>
Films available. General conditions in exposing color film. Lighting contrast for color film. Exposure. Backgrounds. Photoelectric exposure meters. Outdoor subjects. Synchronized flash. Exposure index tables. Color photographs by artificial light. Use of exposure meter. Clothing and background color. Portraits. Flood lamps to supplement daylight. Filters for color films. Color temperature. Light sources and filters for use with daylight color film. Color compensating filters. Black-and-white prints from color transparencies. Voltage control in color. Exposures for close-ups. Color film. Color-film processing. Color-processing solutions. Reducing solutions for Ansco color transparencies. Capacity of solutions. Color film cost per exposure. Defects in transparencies. Kodacolor film.	

CHAPTER	PAGE
<b>V. SEPARATION NEGATIVES .....</b>	<b>139</b>
Equipment for color separations. Films or plates for separations. Gray scale. Lighting for separations. Identification of separation negatives. Development of separation negatives. Troubles in processing separation negatives. Requirements for separation negatives. Separations direct from subject. Filter factors for separation negatives. Densitometer. Densitometry. Effect of separation filters. Films for separations. One-shot cameras. Out-of-register negatives. Separation negatives from transparencies. Separations in a copying camera. How to determine correct exposures. Masking. Unsharp masks. How masks improve color.	
<b>VI. IMBIBITION COLOR PRINTS.....</b>	<b>253</b>
Necessary equipment. Wash-off process. Orthotone process. Dye Transfer process. Dye Transfer vs. Wash-off Relief. Tanning developer. Contrast control in Dye Transfer process. Corrective measures in wash-off. Wash-off formulas. Judging correct exposure in wash-off. Use of densitometer to determine exposure. Tanning developer formulas. Dyes for wash-off printing. Dye mordanting.	
<b>VII. CARBRO PIGMENT PRINTING.....</b>	<b>304</b>
Monochrome carbro. Trichrome carbro. McGraw Colorgraph carbro method. Making bromides for carbro. Stripping the pigment. Forming the pigment images. Transfer of pigment. Final transfer. Spotting. Carbro formulas. Use of combiner. Duplicate prints. Carbro and wash-off combined. Calibration of enlarger. Cost of making prints.	
<b>VIII. ANSCO PRINTON; RECENT DEVELOPMENTS.....</b>	<b>339</b>
Printon characteristics. How to use Printon. Filters required. Color compensation. Recent improvements in Printon. Use of densitometer, exposure meter, or photometer. Comparison of Printon negative with bromide negative. Ektacolor film. S-T Tripac separation films.	
<b>Index .....</b>	<b>349</b>

Color Photography  
for the Amateur





## Introduction

**F**OR ALMOST EXACTLY a hundred years professional photographers, advanced amateurs, snap shooters, portraitists, pictorialists, and scientists have wished to make photographs in the full glory of natural color. Many processes have been suggested, and many have been tried; but it is only recently that the making of such photographs has been placed within reach of all camera enthusiasts, including the newest and most unskilled of amateurs. It is now possible for the professional, even for the amateur, to make beautiful color photographs and to impress on color film (still or motion picture) his personal record—his children, his hobbies, his vacations, his automobile trips, his voyages.

The headaches of color photography, which have been many, are easing up before the research of many scientists in many laboratories. According to one of the best known and most respected of these scientists, the years of black-and-white photography are numbered. Just what the future holds no one can say, but the amateur who wishes to be in the vanguard of early workers, who wishes to be a jump ahead of his friend hobbyists, has yet time to get in on the ground floor of what promises to be a revolution in photography.

But before he embarks seriously upon his campaign he should ask and get answers to these questions:

- Is it expensive?
- Is it difficult?
- Is the equipment too elaborate?
- What experience is needed?
- Is it worth while?

**Consider the last question first.**

## IS IT WORTH WHILE?

The answer is Yes.

Nature did not make her flowers, her seas, her skies, and her clouds in black and white. Only the color-blind see natural beauty in the way we have been accustomed to seeing it in photographic reproductions. Fruits and vegetables, butterflies and birds, shadows, trees, still ponds, and running water all have color. Black and white at its best gives but a dull re-creation of their original beauty.

The photographer who takes up color has a new medium with which to work, and he experiences the same delight a painter might if, after years of restriction to black crayon and white paper, he were suddenly given a full palette of bright colors. He will become color-conscious, perhaps for the first time in his life. He will learn to watch for beauty of color, as well as for the beauty of form and the variations of brightness that have made his black-and-white photographs distinctive, and he will learn that certain colored subjects, which looked quite all right in black and white, look very bad indeed in color. Color will lead the amateur photographer in many directions and will open up new and fascinating interests, but each person must, after all, decide for himself if he thinks it is worth while.

To determine this simply and cheaply, let the amateur buy a roll of color film—Kodachrome or Ansco color—load his camera with it, and shoot off his exposures on a clear day. Let him choose subjects that have strong color—children in bright dresses, flowers, blue skies with white clouds. When the finished product comes back from the manufacturer, he can decide whether he wants to stop here or go ahead.

## IS IT EXPENSIVE?

Yes, compared to black and white.

But it produces vastly superior results, and the amateur must pay

for this improvement. It would not be possible even to estimate the number of dollars and the number of man-hours that have gone into the research that makes color pictures possible. The wonder is that they do not cost more than they do.

Color film can now be purchased for most of the more popular sizes of roll-film cameras. It can be bought in sheet film for the larger cameras used by the more serious amateurs and professionals. A single shot for any of the 35-mm cameras will cost about 15 cents and prints made from these miniature transparencies may be had for prices from 60 cents up, depending on size and quality.

These prices will probably come down. It is the earnest desire of every manufacturer to make the processes simpler, less subject to error, and less expensive. Much money and effort are being spent in these directions; it would be strange if they did not bring results. Already reductions have been made, and it seems reasonable to hope that others will follow with greater appreciation on the part of photographers and consequent greater volume of business to the manufacturers.

The prices quoted above for "transparencies" are for films on which the color picture appears in full brilliancy when held up to the light or when projected on a screen. Transparencies are made by processing the films that were used in the camera; they are originals, not prints. To display their complete beauty, they should be thrown on a screen, like a movie. To do this involves buying a projector (\$35 will buy a good one) but many a photographer has decided that this is a better way to exhibit the fruits of his labors than passing around black-and-white prints.

If the amateur does his own work (and it is highly desirable that he should), he will find the cost of processing transparencies somewhat greater than that involved in developing a black-and-white film. To have a large print made on paper, however, will cost good money—about \$3.50 for an 8- by 10-inch enlargement—and only a few laboratories are offering the service. These prices, like the cost

of film, will probably come down, but anyone familiar with the work involved in making a color print understands why they are so high compared with those of black-and-white prints.

If the amateur goes in for print making, he will find that costs depend on his skill and on the number of prints he wants. The purpose of this book is to describe for him the most practical methods of making prints. It is the ability of the photographer rather than the cost of the process that determines the excellence of the pictures.

### IS IT DIFFICULT?

Not too difficult.

Only simple rules must be followed to take pictures that are subsequently processed to make transparencies. One has to have the proper light, to have the subject under fairly strong illumination, to use the proper exposure, and to push the button. It is as easy as that.

But the color photographer cannot go barging about shooting here and there with the abandon he has enjoyed in using up his black-and-white film, leaving to the film latitude and the photo-finishers the job of getting good prints from his exposures. He must get the exposure right, or his color picture will be a failure. An exposure meter, used intelligently, is a good guarantee of success; it is not a necessity. As a matter of cold fact, the exposure guides prepared by the manufacturers take care of almost all circumstances, so that it is the unusual picture taken under unusual conditions that requires the exposure meter. The manufacturer is as anxious as the user of the materials to make failure difficult and rare. It is the author's experience that an exposure meter followed blindly will occasionally produce bad results—in snow scenes, for example. Color photography is serio is business; to get the best results the amateur must be willing to follow a more rigorous system than he has used for his work in monochrome.

When it comes to making color prints on paper, either from life or from transparencies, it is only fair to state that the art is in a state of rapid flux. Many amateurs make excellent prints; commercial photographers have been making them for some years. But as yet there is no royal road to the making of colored prints. Processes are lengthy and rather expensive, the wastage of materials in the average amateur's hands is rather high—but there is no greater thrill in all photography than the successful production of a good color print. There is no greater challenge to the amateur and no phase of photography in which the future holds so much.

The color plates in this book were made from paper prints made by an amateur—some from original subject matter, some photographed first in the form of transparencies and then made into prints—but it is all amateur work.

### IS THE EQUIPMENT TOO ELABORATE?

For transparencies nothing is needed but color film and a camera of one of the sizes for which color film is made. For the more painstaking work of making "separations" like those of the engraver or the professional photographer, the amateur will need a camera (and any good camera will do, whether roll or pack film or plate), filters, a sturdy tripod, and the necessary trays and chemicals for processing. Fortunately, many of the chemicals needed for color can be used for other photographic purposes and, again fortunately, the chemicals themselves are not expensive.

There are other pieces of equipment that the amateur can buy, such as one-shot cameras (\$275 and up), but they are not necessary. He can get into color without them.

For making transparencies, the minimum equipment is

Camera

Color film

If the amateur does his own processing (this is not possible with Kodachrome film), he will also need

Trays or tanks

Chemicals

A place to work—the kitchen or the bathroom will do

For more serious work, add

Tricolor filters

Tripod—get a good one

More chemicals

More trays

A better place to work, preferably a well-equipped darkroom

### WHAT EXPERIENCE IS NEEDED?

When a person goes to college, he learns that he cannot enroll in certain courses until he has previously mastered more elementary or preparatory ones. This is true of photography. Although anyone with a camera can learn to make excellent transparencies, which are beautiful and which may have sales value, the amateur who proposes to process his own color film or to make prints should take a preliminary course in general photography.

The amateur who sends all his work to the drugstore to be processed is not ready to build himself a darkroom and to plunge immediately into color-print making or even into processing his transparencies. He has no sense of photographic values; he cannot tell what is wrong if success does not crown his first efforts.

The amateur should know how to develop a film or plate. He should have some idea of the photographic processes, which involve not only the preliminary step of making the exposure but also the vastly important steps of developing the film and fixing, washing, and drying it. And he should have some experience at making prints from negatives. Through this type of work he learns to judge by looking at a negative whether it has been underexposed or overexposed, underdeveloped or overdeveloped, and so on. Proficiency at black-and-white processing, however, is only an initiation, and much more must be learned to work in color effectively.

To sum up, to make transparencies the amateur needs to know only how to focus his camera and how to measure exposures. The amateur without any interest in processing or in print making can learn as much about composition, about colors, about exposure, about models and lighting—all of the elements of making pictures—as the fellow who spills chemicals all over himself and who makes a considerable investment in processing apparatus and materials. There is no reason why an amateur who intends to confine his work to transparencies, whether for projection or for sale or for engravers to work with, cannot make just as good ones as the man who spends his days and nights in a darkroom. Many very fine transparencies were made with 35-mm cameras costing as little as \$12.50 (prewar).

If, however, the amateur desires to make prints or to process his own transparencies, he should first learn how to develop and print black-and-white pictures. He will thereby learn how to handle his apparatus in absolute darkness, how to mix chemicals, how to clean trays, and how to expose paper or films to negatives for making prints or lantern slides, and in general he will equip himself with experience that will save him time and energy and money when he comes to do his own color processing.

This book assumes a rudimentary knowledge of monochrome photography. In the following chapters the amateur will be able to learn something about color, about films and filters, and about film processing. Then he will be taken into the adventures of making and processing transparencies; then into the several processes of making prints from separation negatives. In this manner he should be equipped, finally, to make prints in any of the several processes available and to choose the medium that, for him, seems best.

There is no doubt that a thorough study of color-print making from separation negatives will educate the photographer into a



much better appreciation of the whole photographic process and will, thereby, improve his black-and-white work immeasurably. He will find out much about the sensitivity of modern emulsions both to white light and to light passed to the materials through filters of various colors. His techniques will improve so that he will finally attain technical perfection, having the ability to make negatives and prints of practically any sort he wishes.

If, in addition, he develops the power of making pictures that have artistic merit, that tell a story, then he can be proud of his all-round proficiency in an art and a science.

## Color and Color Processes

**B**EFORE THE AMATEUR begins to work with color, he should understand something about what color is. Webster's New International Dictionary calls it "a quality of visible phenomena, distinct from form and from light and shade, such as the red of blood, the blue of the sky, the green of grass." Color, then, is a physiological sensation. It is a property of light; the sensation produced depends on the way the light acts upon the human eye.

Pure white light—sunlight at noon on a clear day—contains all colors, each of which is represented by a different wave length. The band of light wave lengths emitted by the sun is very wide, extending from 290 to more than 2,300  $m\mu$  ( $m\mu$  = millimicron = one millionth of a millimeter). Of this band only a small portion (the wave lengths between 400 and 700  $m\mu$ ) produces sensations visible to the human eye. These constitute the physical, or visible, spectrum. Photographic emulsions are available that detect wave lengths that the eye cannot see, and there are other ways of detecting and measuring the other radiations from the sun.

When a beam of white light is sent through a prism, it separates into the seven colors of the rainbow—red, orange, yellow, green, blue, indigo, and violet. Red is produced by the longer wave lengths (700  $m\mu$ , approximately), violet by the shorter ones. The action of the prism might loosely be compared with that of a radio set designed for the wave lengths of light rather than for the wave lengths of wireless radiations. Shoot a wave length of 700  $m\mu$  into the human eye and the brain registers "red," just as a radio receiver responds with WJZ when it is tuned to 760 kilocycles.

The figure shows the wave lengths of the visible spectrum and the corresponding colors as seen by the normal human eye. Wave lengths shorter than the violet are known as *ultraviolet*; light from these produces tan when one's skin is exposed to them (this is in

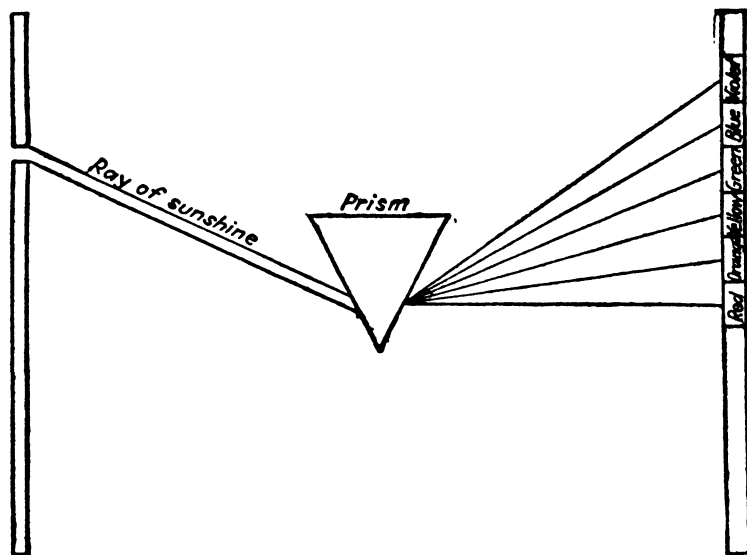

Ray of white light from the sun is split up by a prism into many hues. The prism divides white light into the colors of the rainbow: red, orange, yellow, green, blue, and violet.

itself a kind of photographic process). Wave lengths longer than the red are known as *infrared* and are heat producing.

The colors of the spectrum are not sharply divided from one another. They blend into a continuous band that seems at first glance to be made of only seven colors. But different hues may be detected within each of the colors. The number of these perceptible to the eye is variously estimated as between 30 and 130. Through combinations of these spectral colors the number of hues, including tints and shades, runs into the thousands.

Every color has three qualities. These are known as the color constants. They are

1. *Hue*, the property that distinguishes one color from another; for instance, reddish blue from a greenish blue.
2. *Value* or *luminosity*, the property that indicates the amount of light and dark in a color—the greater the amount of light, the higher the value; the greater the amount of dark, the lower the value.
3. *Purity, intensity, or saturation*, that which expresses the strength or vividness of a color; for instance, the difference between a pure

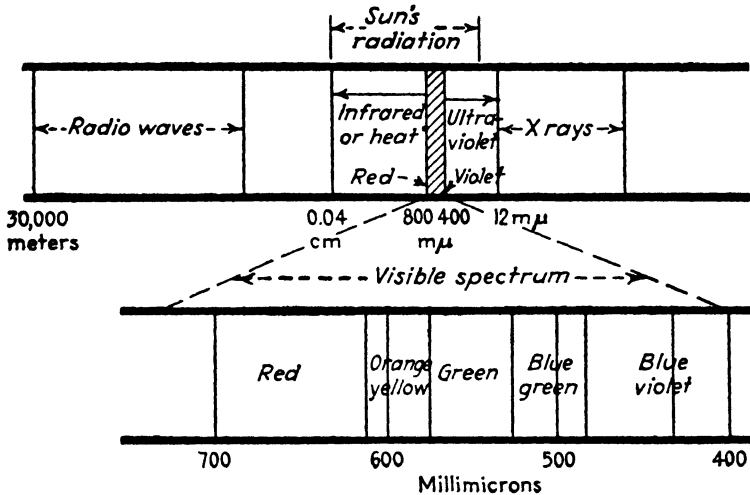

Electromagnetic spectrum with visible portion expanded to show relation between colors and wave lengths.

spectral blue and a blue mixed with gray. Two colors are identical when they exactly correspond in these three qualities. A *tint* is lighter than a saturated color. A *shade* is darker than a saturated color.

The colors of the spectrum are the *chromatic* colors. Black, white, and the intermediate shades of gray are the *achromatic*, or *neutral*, colors. Variations of the shades of gray are measured in terms of *brilliance*. Halfway between black and white lies a gray that contains equal amounts of black and white. All other grays are lighter or darker than this. Dark grays have low brilliance. Light grays have high brilliance. Pure black (and it is possible only theoretically to obtain pure black) is a complete absence of color. Its degree of

brilliance is zero. Pure white is a combination of all colors. Its degree of brilliance is very high.

There is no standard nomenclature for color. Even in this day of scientific accuracy, colors of the same wave lengths are called by different names, depending largely on the person who makes use of them. A painter, a stylist, an advertiser, a manufacturer, and a photographer may all speak of the same color, yet each uses a different name for it. Some efforts toward standardization have been made, but they have not been entirely successful. There are many obstacles in the way. But since in making color photographs only three primary colors and their complementary colors are dealt with, the complicated subject of color names need not be discussed here.

### PRIMARY AND COMPLEMENTARY COLORS

There is some confusion as to which are the *primary* colors. Popularly, the seven prismatic, or rainbow, colors are often referred to as the primaries. Psychologically speaking, there are four primaries—red, yellow, green, and blue. These cannot be described in terms of other colors, but they can be used to describe other colors. Orange, as far as the sensation it registers on the eye is concerned, is a combination of red and yellow. Indigo is a combination of red and blue. Violet is another combination of red and blue. For the artist working with pigments there are three primary colors—red, yellow, and blue. By proper combinations of these three he can make all other colors in the chromatic scale. For the color photographer, also, there are three primaries, but they are not the same three. The difference comes from the fact that the artist gets his colors through mixing pigments while the photographer gets his through mixing light. For the man (or woman) with the camera the three primary colors are red, green, and violet-blue.

Scientists have discovered that any color may be considered as made up of varying proportions of these three primary colors—

red, green, and violet-blue. The whole scheme of color photography is founded upon this fundamental principle.

One of the oldest and most efficient of color cameras is the human eye. A ray of light entering the eye passes through four

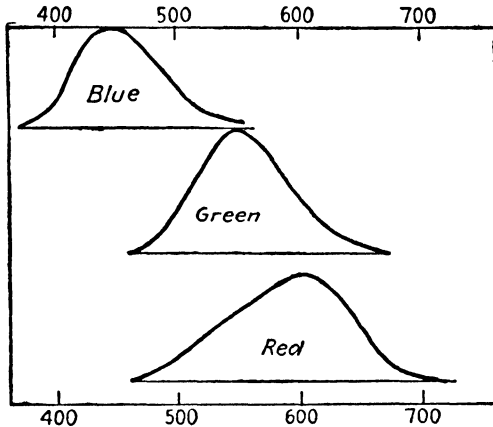

The three color sensations of the eye. If all wave lengths between 500 and 700  $m\mu$  are "seen," the sensation will be yellow.

transparent mediums before it enters the terminal organ of vision, which is the retina. These mediums are

1. The cornea
2. The aqueous humor
3. The vitreous humor
4. The crystalline lens

As the ray of light enters the eye, it passes through the cornea practically unchanged; but in the three other transparent mediums it is bent or refracted until it makes a focused image on the retina. There are several theories as to how this image is made and how the colors in it are registered. According to the Young-Helmholtz theory, which grew out of the discovery of the red, green, and violet-blue primaries, there are three kinds of nerves in the retina, each sensitive to light of a different band of wave lengths. One set is

sensitive to red wave lengths (600 to 700  $m\mu$ ), another to green wave lengths (500 to 600  $m\mu$ ), and the third to violet-blue wave lengths (400 to 500  $m\mu$ ). When a certain set of nerves is stimulated, the brain registers "red." Similarly the other sets of nerves tell the brain when colors to which these nerves are sensitive are being received. If all three colors are stimulated equally, white is the sensation recorded. If these three nerves are stimulated in the proper proportion, any color of the spectrum can be seen.

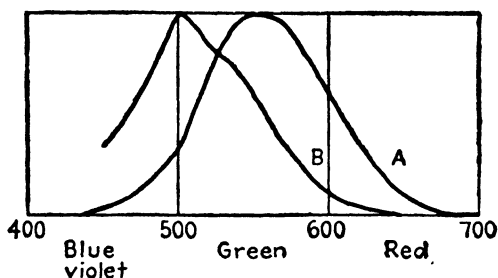

Shift of sensitivity (from a peak in the yellow, A) of the eye toward the green, B, under poor illumination.

In normal illumination the eye is more sensitive to yellow light than to light of any other color. But in weak illumination—as in a darkroom—this sensitivity shifts toward the green. This is why green safelights are often employed in the photographic darkroom when panchromatic materials are used.

Whether or not this trichromatic, or three-component, theory of Young and Helmholtz is true with regard to the eye (and it has been seriously questioned), it is true with regard to the color camera.

### *Properties of Light*

Light—and color is a property of light—travels in a straight line from its source as long as it moves through the same medium. If it strikes a medium of different density, three things may happen to it. It may be absorbed. If it is completely absorbed, the object upon

which it falls will appear black; all light is gone, and there is no color. If it is partially absorbed, the color of the object illuminated will depend on which of the wave lengths are absorbed. It may be reflected—i.e., sent back in the direction from which it came. Or

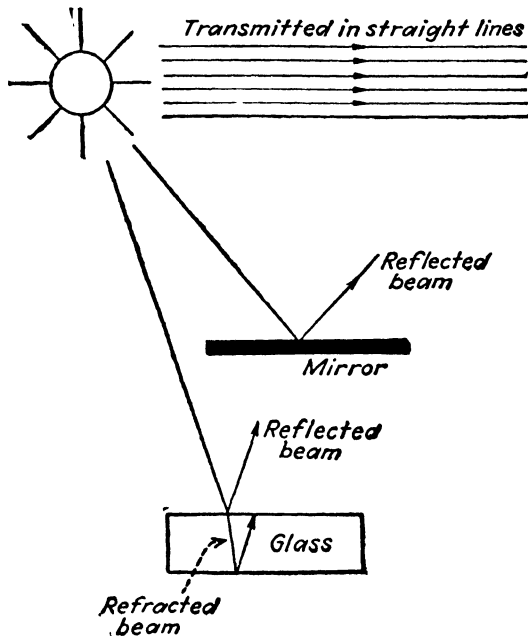

Light can be reflected, refracted (bent), and transmitted. It can also be absorbed.

it may be *refracted*, or bent, in which case it will travel in an entirely different direction. When a beam of light traveling from the sun through the air strikes a lens, it enters a medium in which the speed of transmission is less than in the air. The ray, then, is bent, or refracted. At the same time some of it may be absorbed and some of the rest of it may be reflected, so that the total amount of light leaving the lens may be much less than the total amount entering it.



Light, therefore, can be transmitted, reflected, refracted, or absorbed. It is with absorption that the color photographer is most concerned, for it is through absorption that colors are registered on the human brain.

The three-component theory states that the color of a rose is due to a proper combination of the three primary colors. This is because white light falling upon the rose is partially absorbed, partially reflected. A red rose absorbs blue and green. Only one of the primaries is left—red. This red component of the white light is reflected—i.e., sent back—and thus reaches the eye. All colored objects absorb certain colors and reflect or refract the others.

A rose will remain red as long as it is illuminated by a white or red light. It will appear black if it is illuminated by a beam of light that contains no red—a ray, for instance, sent through a blue-green filter. In such a beam there is no red left to be reflected to the eye.

### *Complementary Colors*

It is an interesting and important fact that for each of the three primary colors there is another color, known as its *complementary*, that, when mixed with the primary, will produce white. Subtract the primary from white light and the complementary is left. The complementaries for the color photographer's three primaries are as follows:

PRIMARY	COMPLEMENTARY
Red	Blue-green
Green	Magenta
Blue-violet	Yellow

Looked at in another way, this table appears as follows:

1. White light minus red equals green plus blue-violet, which makes blue-green.
2. White light minus green equals red plus blue-violet, which makes magenta.
3. White light minus blue-violet equals red plus green, which makes yellow.

## COLOR PROCESSES

All methods of making photographs in color depend on the fact that any color can be made up of the proper proportion of the three primary colors. Conversely, any color can be analyzed into its three components, which are varying proportions of the three primaries.

The photographer, therefore, proceeds in the following way, speaking very generally at first and more specifically later. He takes his scene apart, separating it into its three primary colors. He registers on one film all the red, on another all the green, and on another all the blue-violet. Then he performs his various operations on these three "separations" and finally puts the picture back together again. There is no known process that does not depend essentially on this complicated business. There are short cuts, as in making transparencies, but in print making the photographer must perforce go through this separation and consolidation process with various operations between.

That is the general scheme. Now, speaking specifically, the photographer may use three films, taking his picture three times, once through each of three filters, which admit to the film only those colors that will pass through them. Thus there is a red filter, and a green one, and one that is blue-violet in color. From these three negatives, positives can be made and then colored properly and superimposed in register. Now the picture has been taken apart and put back together again.

Or the photographer may use one film in which the manufacturer has, in effect, imbedded both filters and sensitive emulsion, so that the separating, processing, and reassembly take place more or less automatically. The manufacturer actually uses three emulsions coated onto a single film base. Between the individual layers of emulsions are filters so that the light of the color that exposes the outermost layer of emulsion is prevented from getting to the

second layer, although colors that will affect the second and third layers are transmitted through the outermost emulsion and the filter. Part of this light exposes the middle layer and the rest, after passing through another filter, exposes the innermost layer. After processing, this film becomes a positive transparency in full color. If prints are desired, the colors of this transparency must be separated on three negatives and three new positives must be made, just as though the photographer had made separations of the original scene. The difference is that he has been able to bring the scene home to do his "separating" there at his leisure.

### *The Additive Process*

There are two general methods of procedure in making a color photograph. A very beautiful demonstration of the possibilities of one of them was made as early as 1860 by a celebrated English physicist, Clerk Maxwell. It is worth while to study this method carefully because it leads directly to methods of making transparencies by Dufaycolor, Agfa plates, Finlay, and other processes not now in vogue in this country.

Maxwell made three filters for his camera—one red, one green, one violet-blue—then made three exposures of the same subject, one through each of the filters. The red filter prevented any but red colors from reaching the plates, the green kept out all but green, and the violet-blue absorbed all but violet-blue. This is the fundamental principle of color separation as it is used today by countless photographers and photoengravers.

From each of his negatives Maxwell made a positive on a transparent material like film or plate. Then he placed each of these positives in a projection lantern focused on a white screen. In the beams of the three lanterns he placed filters; before the red positive he placed a red filter; before the green positive he placed a green filter; and before the violet-blue positive he placed a violet-blue filter. The three positives were stationed so that the images were in

exact register on the screen, which showed a reproduction in full color of the original subject.

This is the *additive color process*. Each component added to the others in the right proportions makes up the final hue. Color photographs made in this way must be on transparent material and must be shown through three beams of light (that is, three filters) exactly like the filters through which the original exposures were taken.

Why did Maxwell have to make positives from his three separation negatives and why did he have to use colored beams of light by which to project the images on a screen?

Considering a red object, only the color red will get through the red filter and will expose the sensitive material. After this material is processed, a dark deposit of silver will exist where the red light hit it. All the rest of the film will be clear. If this film is projected on a screen with red light, all of the screen will be red except the portions that represent the original red. So this scheme is no good. On the other hand if a print (on film or plate) of the red-filter negative, like Maxwell's, is made, then the light and dark portions will be reversed; the dark parts of the negative will become clear and all the rest of the film or plate will become dark, representing the nonred parts of the original scene. Now if this positive is projected by a red beam of light, the screen will show red in the portions where the original subject was red.

An amateur who has the tricolor filters can perform an interesting experiment in color synthesis. Get two small mirrors and a white screen—a sheet of white paper will do. Let a shaft of sunlight fall on one filter and let the colored light that gets through the filter fall on the screen. Then with the mirrors, direct light on the other two filters and move them about until the light that gets through them falls on the screen. Let two of the beams fall on top of each other and, finally, let the three beams superimpose. It will not be possible to get a good white because the filters are not

perfect transmitters of the desired wave lengths nor perfect absorbers of the undesired wave lengths.

It will be noted that a sort of yellow results when the red and green beams overlap and that a blue-green is the result of green and blue beams overlapping. If, however, the red and blue filters are overlapped and held in front of the eye, very little light will get through, because the red filter transmits only red (and no blue) and the blue filter transmits only blue (and no red). Therefore, one filter intercepts what the other transmits and so nothing (theoretically) gets through.

### *The Subtractive Process*

Maxwell could have secured exactly the same results if he had proceeded by dyeing the red-filter positive blue-green in color (the complementary of red), the green-filter positive magenta in color, and the blue-filter positive yellow. Then, if he had placed these in register, illuminated them by light from a single white beam shining through these three positive images in register, the screen would have had on it a reproduction of the scene in full color exactly like the one he actually had in his demonstration.

This is known as the *subtractive process*. It consists of making three negatives, then from these negatives three positives, each of which is then dyed a color complementary to the filter through which the negative was made. These three positives may be registered and bound up with tape to form a transparency; or they may be transferred to a paper base; or they may be engraved and run through a printing press.

The additive and the subtractive processes are two different methods of producing the same result. Beautiful pictures are possible by either method.

If transparencies are all that is wanted, the additive process may be used. If prints are desired, the subtractive process must be used.

### *Comparison of Additive and Subtractive Processes*

All that you learn now will be useful throughout your dealings with color photography—unless the scientists produce some radically new and radically simple process not now in sight.

Suppose you photographed three pure colors, the colors of the tricolor filters, red, green, and blue-violet. (It must be said here that pure colors are almost never found in nature. All colors are mixtures, and the illustration given here shows that this is true.)

Consider the red-filter negative. The red filter absorbs blue-violet and green. It transmits red. Therefore only red light will get through the filter and expose the film. Upon development the red portions of the scene will therefore produce a dense deposit of silver in the film. The green and blue-violet parts of the scene will not get through the red filter and will not register on the film. The developed film will show a dark place where the red portion of the scene exposed the film and transparent portions where no light got through the red filter.

The green and the blue-violet negatives will, similarly, have dense and transparent portions corresponding to the parts of the scene that got through the respective filters and the parts whose colors were absorbed by the filters. The positives, of course, will have the light and dark portions reversed.

Now suppose the red-filter positive is placed in the red beam of the lantern of Maxwell. Where there was red in the original scene, the positive is transparent and the red beam will be projected on the screen. Where there was green—i.e., no red, the red-filter positive will be dark and no red light will get to the screen.

Similarly the green positive is placed in a green beam and the blue-violet positive is placed in a blue-violet beam. Since the red portions of the scene are opaque in the green and blue-violet positives, no light from these lanterns will get to the screen, which will

be red only in these portions. In this manner each portion of the scene will be registered on the screen.

The additive process is thus made up by adding colors to the screen. If a certain portion of the scene is white, each of the three positives will be transparent, because each negative will be affected by the white light (since white light is made up of red, green, and blue-violet), and some of each of the three colored beams will get to the screen. Thus white light is seen to be made up of equal proportions of red, green, and blue-violet.

The process can be looked at in another way. The red filter absorbs blue-violet and green and prevents these colors from affecting the film. It subtracts these colors from the scene. Similarly the red filter placed on the white beam of the lantern absorbs nonred (blue-violet and green) and prevents these portions of the white beam from reaching the screen.

In the subtractive process the same three negatives can be used. Positives are printed from these negatives. These positives can be dyed, or pigmented, or in some way colored in hues that are the complementaries of the filters through which the respective negatives were made. Suppose they are dyed in such a manner that the deposit of dye is proportional to the density of the deposit of silver in the positives. Where the positive is clear, there will be no dye. Where the positive is opaque, the dye deposit will be heavy.

Now look at the illustration of the subtractive process. It will be seen that in the red parts of the scene the positives are dyed as follows: the red-filter positive is clear, the green-filter positive is magenta, and the blue-violet positive is yellow. In other words, the portions of the original scene where there was no red are now dyed magenta and yellow.

Place the dyed positive made from the red-filter negative down on a piece of glossy white paper. The light reflected from the paper will now be partially absorbed by the dye and will not reach the eye. The dyed portions have subtracted from the white light of the

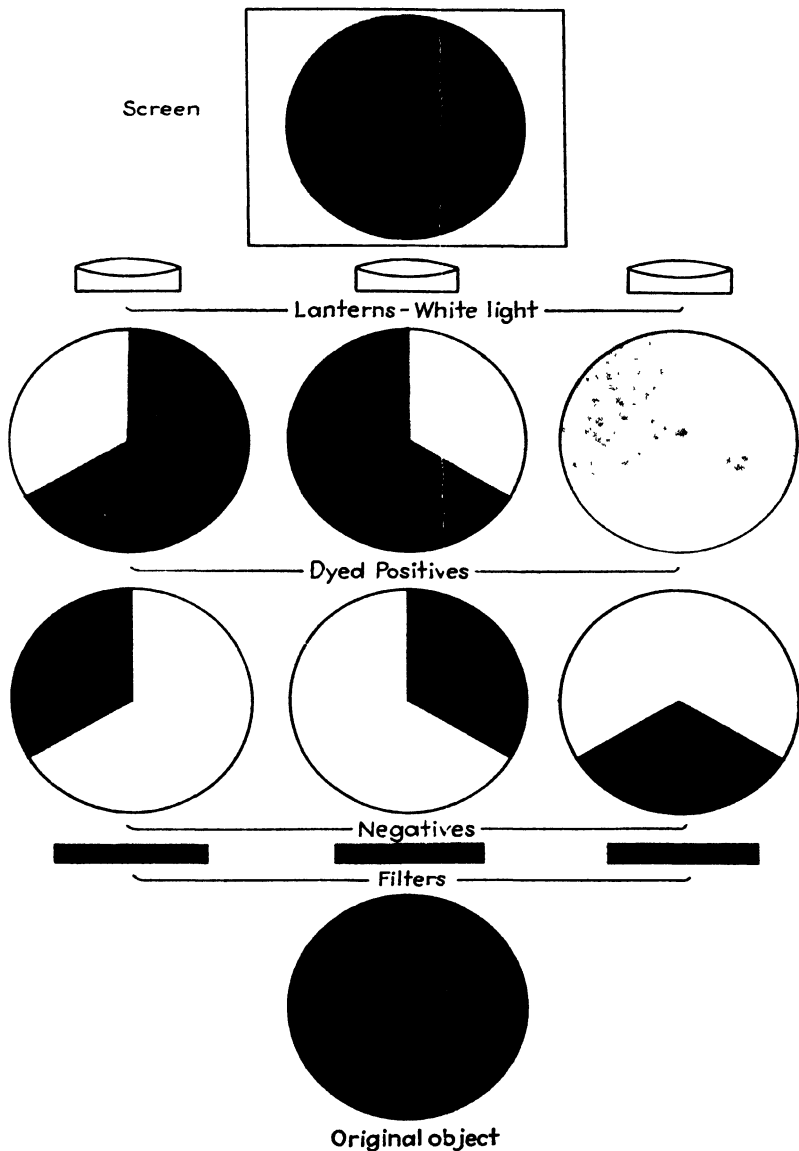

**Subtractive color process.** The object is photographed as in the additive process. The positives, printed from the separation negatives, are colored in the colors complementary to the taking-filter colors. These colored positives are superimposed and projected through a single lantern or through three lanterns using white light.





paper those portions of the original scene in which there was no red. From the red-filter positive no light should be reflected to the eye in those portions of the picture in which there was no red in the original scene. Since white light minus red equals blue-green, the nonred portions of the red-filter positives are dyed blue-green.

The green-filter positive has magenta dye in the portions where there was no green in the original, because white light minus green equals magenta; the blue-violet positive has yellow dye in the portions where there was no blue-violet in the original, because blue-violet subtracted from white light makes yellow.

Now place one positive on top of the other in register and all three on the white-paper support. Each dyed positive subtracts its share from the white light of the paper and helps to build up the final image. If all three positives are clear, white will show through. If all three positives are dark with dye, all light will be subtracted and the picture will be black.

Where magenta and yellow overlap, there will be red; where blue-green and magenta overlap, there will be blue; where blue-green and yellow overlap, there will be green. Other colors will be formed of various combinations of these three colors and by varying depths of dye deposit.

Thus

White minus blue-violet makes yellow.

White minus green makes magenta.

White minus red makes blue-green.

And

Magenta plus yellow makes red.

Magenta plus blue-green makes blue-violet.

Blue-green plus yellow makes green.

In the subtractive process the nonred portions of the red-filter positive are printed in nonred or blue-green; the nongreen parts of the green filter positive are printed in nongreen or magenta, and so on. The red portions of the red-filter positive do not print at all.

The green portions of the green-filter positive do not print at all. But the red of the original scene is made up, in the final print, by an overlap of magenta and yellow; green is made up of an overlap of blue-green and yellow; and blue is made up of blue-green and magenta.

Looked at in another way, the relation between the primary colors, red, green, and blue-violet, and the colors complementary to these colors—i.e., white light minus these colors—blue-green, magenta, and yellow, may be thought of as follows:

White minus green and blue-violet equals red.

White minus green and red equals blue-violet.

White minus red and blue-violet equals green.

Since white light minus red makes blue-green, this latter color is often spoken of as being "minus red"; in the same way, yellow is "minus blue-violet"; magenta is "minus green."

If all of this business seems very confusing, remember that an experienced photographer can look at a negative and, even though the light and dark portions are reversed from what they will be in the final black-and-white print, he can visualize this print perfectly. The negative that he makes by photographing a subject has all of its high lights and shadows exactly reversed from the original, and it is only by making a print from this negative (which then becomes a positive) that the reproduction of the original subject becomes possible. Similarly in color, the negatives made of the original subject have their light and dark portions the exact opposites of the original, so that in reproducing the colors, they too must be "reversed," and this leads to the apparent contradictory performance of producing the red of the original scene by actually laying down a dye or pigment made up of the two colors magenta and yellow.

The advantage of the subtractive process, just described, lies in the fact that brighter pictures result. In the additive process, to procure white, one must project on a screen all three primary

colors, whereas in a subtractive process one projects no color at all—the white of the screen is merely the place where the unfiltered, unattenuated illumination from the projector reaches the screen. In color prints, such as the photographic processes described in this book or such as the photomechanical processes like letterpress or offset printing, white is merely the whiteness of the paper support—and the whiter the paper, the brighter the pictures.

Black in a subtractive process is made up of equal amounts of all of the subtractive printing colors overlaid on each other, so that when each subtracts one-third of the visible spectrum, no light whatever is reflected to the eye from the white paper; or in a projector system, no light reaches the normally dark unilluminated screen. In a subtractive process the whites are whiter and the blacks blacker than in an additive system.

The red, green, and blue filters employed in making separation negatives for use in color printing are often called “additive-analysis” filters; the cyan (blue-green), magenta (blue-red), and yellow (red-green) prints made from these negatives are often called “subtractive-synthesis” colors. Thus, color films and separation negatives may be said to “take” a color picture by an additive method but to display the final result by a subtractive process.

## Films and Filters

**U**P TO THE present moment it has been assumed that the amateur about to embark upon an adventure in color knows something about sensitive materials like films and plates and something about filters. The average amateur knows a film as something he buys at the drugstore or the camera-supply house and a filter as something that brings out clouds in the sky.

The color amateur should have something more than this superficial knowledge. He should know what films are made of, their sensitivity to various colors, how to develop them, and so on.

### FILMS

A sensitive film is composed of a support upon which is a coating of silver bromide suspended in a solution of gelatin. This coating is called an emulsion. The film base or support for the light-sensitive emulsion is usually made of cellulose nitrate or cellulose acetate, derivatives of cotton. Plates, of course, have sheets of glass as supports.

Before the film has been exposed to light and developed, the silver bromide exists in the form of small crystals, which are usually triangular or hexagonal in form. They are thinner than they are broad and lie flat in the plane of the film. These grains are of various sizes, some large and some small, but all of them are much too small to be seen except with a powerful microscope.

On the size of these grains depends the characteristic of the film (or plate). Fast films have a larger proportion of large grains than of small grains. Slow films have more small grains—they are “fine”

grain. Supersensitive materials used for night photography are inherently coarser grained than slow or fine-grain films. Coarse-grained films are also less contrasty than fine-grain films. The latter are said to be "hard," while the very fast films tend to be "flat." They will, however, reproduce a wider range of tones than the harder films. A process film is excessively contrasty and at the same time is very slow.

Fine grain, high contrast, and slow speed go hand in hand; coarse grain, relatively low contrast, and high speed go hand in hand.

When the sensitive film is exposed to light, a "latent," or invisible, image of the subject being photographed is formed in the sensitive emulsion. When the film is developed, the portions of the film that were exposed to light turn black because the light-yellow silver bromide is converted to black particles of pure silver in the developing process. Fixing, after development, gets rid of the unexposed silver bromide grains and leaves nothing but pure silver grains and the transparent film base. Since the developer only acts on the silver bromide grains that have been exposed to light, the fixing process is most important. The undeveloped silver bromide grains are still light-sensitive. If the developed film is exposed to light, the image will be of temporary value only since the unexposed grains now become black, because they will be exposed to light when the picture is displayed. The fixer, therefore, gets rid of these unexposed grains and permits the picture to be examined in full daylight without danger of its turning black.

There is no point in trying to explain what happens when light hits the silver bromide crystals. Many of the world's scientists have puzzled over this question, and there are almost as many theories as there are scientists. The important thing for the amateur photographer to know is that something happens. The "something" is the formation of the latent image. The photographer's scene is

instantly frozen in the form of silver bromide crystals, which become metallic silver upon development. These silver images absorb light and make a black image in a negative or a print.

Every photographer who has exposed a film and has had it developed knows that there is some relation between the blackness (density) of the final negative and the amount of exposure. A long exposure produces a dense film, darker than a short exposure.

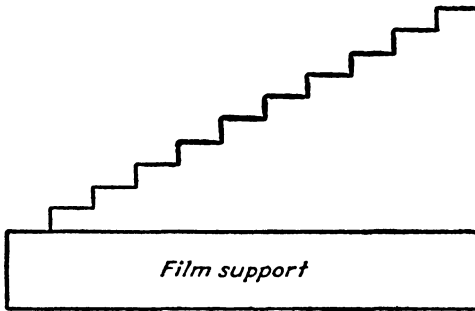

Greatly exaggerated representation of film and emulsion. If there are ten layers of sensitive emulsion, only the outermost will be exposed by a small exposure (product of light intensity multiplied by time). Longer exposures penetrate to layers nearer the support.

The relation between exposure and density of the negative is very definite and has been known for a long time. Twice the exposure, however, does not make the negative twice as dense. It is a bit more complicated than that.

Suppose you look at a greatly enlarged cross section of a film. First comes the support. On this is the sensitive emulsion. Suppose, for example only, this silver bromide in gelatin is laid down in ten layers, each as thick as the others and each having the same number of silver grains per square inch. Now give the film a short exposure—enough, say, for the light to penetrate only the first layer. Subsequent development will convert this layer into metallic silver, and fixing will get rid of the unexposed silver grains. Deposited on the

support will then be a layer of black silver crystals. On looking through the film at the light you will see a slight blackening (indicating that the silver is absorbing light).

If a longer exposure is given, layers of silver bromide nearer the film base will be exposed, and if the exposure is long enough, all ten layers will be exposed. Now if the film is developed and fixed, there will be ten layers of silver crystals, each more or less opaque, each taking its percentage of the light when the film is held up to a source of illumination. The ten-layer portion of the negative corresponding to a long exposure will be very dark and opaque; the one-layer portions corresponding to a short exposure will be light; and portions that got no exposure at all will be nothing but clear film base, practically colorless. Some light will be absorbed by the base film but this will be small.

This, in a very inexact way, is the process of exposure and development. Characteristics of any film are given in the form of an H & D curve named after Hurter and Driffield, the scientists who worked out the relation between exposure and density. Such a curve expresses the relation between a given exposure and the density produced by it. It will be noted in the figure that there are three distinct portions to this curve. There are a lower bending portion, a steep straight portion, and a flattening-off portion. Such a curve could be made in the laboratory in the following manner. A film is exposed for a short time, developed, fixed, washed, and dried. The density produced by this exposure is measured on a densitometer. This gives one point on the curve. Now other films of the same material are exposed for longer and longer times and the corresponding densities are plotted on the curve. Finally enough points will be secured so that a smooth curve can be drawn through them.

Actually only a single film need be used. One portion is exposed while the rest is protected from the light. Then certain portions are exposed while the other portions are protected. Very accurate and



elaborate machines are used in the laboratories of the film makers for this purpose.

The three portions noted above are known as the region of under-

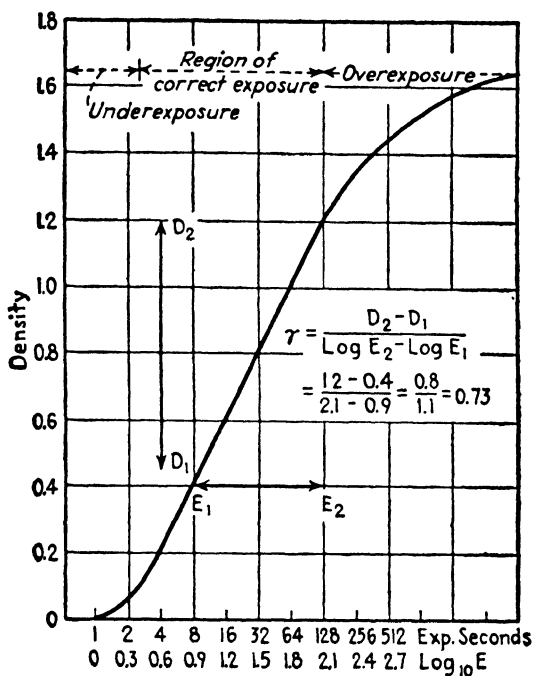

Typical H & D curve showing relation between exposure and the resultant density. Contrast of a particular negative is the difference between its greatest and least density; gamma ( $\gamma$ ) is the slope of the straight-line portion of the curve. Note that exposure is plotted as increasing geometrically, log exposure and density increasing arithmetically. The contrast of a particular negative seldom if ever approaches the maximum contrast possible with the emulsion used.

exposure, the region of correct exposure (the straight portion), and finally the region of overexposure. In the first region you should note that it requires a relatively long exposure to produce a given

change in density. Then over the straight portion each time the exposure is doubled, for example, an equal change in density is produced. At the top of the curve it will be noted that longer and longer exposures produce very little change in density.

### *Tone Range*

When the black-and-white photographer wishes his photograph to reproduce the exact differences in tone value of a scene, he uses the straight-line portion of the curve. Thus, if one portion of the scene is twice as bright as another, the print made from this film will show that the brightness of these portions differs by a factor of two. If the scene has such a tone range that the difference between the lightest and the darkest portions is not very great, the photographer can expose his film anywhere along the straight portion of the curve. The film latitude is such that there are many correct exposures. If a long exposure is used, the entire film will be dense and will take longer to print, but the tone values of the print may still bear correct relations to each other compared with the tone values of the original scene.

Suppose, however, the scene has a wide difference between the brightness of the high lights (sky, for example) and the shadows. Now the photographer must be more careful or the sky will be overexposed or the shadows underexposed. There may be only one correct exposure. Any other exposure may cause the sky to be completely dark in the negative, perfectly white in the print (like the average drugstore print of the average amateur's film), or if the exposure has been too little, the sky may have proper balance with the middle tones while the shadows may be perfectly clear in the negative, perfectly black in the print. There will be no details in the shadows.

Fortunately, the range of brightness found in the average out-of-doors scene rarely exceeds the range of tones the film can reproduce. This means, in the photographer's language, that the "latitude" of

the film is sufficient to handle the usual subject. The length of the straight portion of the H & D curve is a measure of this latitude.

It is entirely to the credit of the producers of film materials that the average amateur can get as good pictures as he does, with as little care about correct exposure. The manufacturers have increased the latitude of their films, have increased film speed, have decreased graininess, have produced printing papers of several degrees of contrast to take care of various kinds of negatives, and, in general, have made a highly scientific procedure so simple that the least experienced tyro can get results.

### *What Light-intensity Range Must Be Reproduced?*

Dr. Mees\* shows a typical wide-range outdoor scene in which the brightest portion, a white cloud, has a brightness of 4,250 foot-lamberts (a measure of brightness) while the deepest shadows, under trees and not illuminated by sky or sun, have a brightness of 162 foot-lamberts. This was a brightness range (ratio) of 26 to 1.

Films differ. Some have wide latitude; others have less latitude. A high-speed panchromatic film can handle a tone range of 250 to 1—i.e., the brightest portion may be 250 times as bright as the shadows and still the photographer can get true tone rendering. A fine-grain film may have a latitude of half this figure; a process film used for getting very white lines on very black background may reproduce a brightness ratio of only 4. This means that there are few tones between black and white; the picture reproduced by it is very contrasty—it is practically either black or white. A film of wide latitude is called a long-scale film.

Although the black-and-white photographer need not worry too much about his exposure unless he has a wide-range picture, the color photographer must take great care about his exposures. He must take considerable pains to see that his color scenes will not present him with widely varying brightnesses. He can use colors

\* MEES, C. E. K., *Photography*, Macmillan, 1937.

that are different in hue but of the same intrinsic brightness—not an extremely bright red, for example, and a dull blue.

### *Density and Contrast*

Two terms used vaguely by amateurs are *density* and *contrast*. They are related but are not the same thing. It is a good plan to get the distinction between these terms well in mind.

The density of the silver deposit on a film depends on the exposure, greater exposure producing greater densities. *Density* is a technical term and can be explained somewhat as follows.

When a film is exposed and developed, the silver bromide in the emulsion is changed to metallic silver, which is more or less opaque—i.e., it prevents the passage of light. A longer exposure, or a longer development, or both, will produce more silver and, therefore, a greater opacity. The range of exposure and the corresponding range of opacity in modern emulsions may be very great, and if a curve is plotted showing the relation between exposure and opacity, it may require considerable space to show all of it. For this reason it is customary to plot the *logarithm* of the opacity against the *logarithm* of the exposure.

This brings up the business of logarithms. A logarithm of a number to the base 10 (which is the commonly used system) is the number of times 10 must be multiplied by itself to become the number. Thus, 100 is 10 times 10 or 10 multiplied by itself. Therefore, the logarithm of 100 is 2; the logarithm of 1,000 is 3. All numbers between 100 and 1,000 have logarithms that lie somewhere between 2 and 3. The logarithm of 200 is about 2.3; the logarithm of 500 is about 2.7; and so on. A scale of logarithms is a compressed scale and by using logarithms much less space is required to plot a given set of data.

Photographers use a technical term *density*, which is the logarithm of the opacity. Thus, if the opacity of a film could be measured (i.e., the ratio of the light that is incident on one side of a

film to the light that gets through the film) and then the logarithms of these various values of measured opacity looked up, the relation of density to the logarithm of the exposure could be plotted. Such a curve would be an H & D curve. Note that in making such a curve, each time one moves a given distance to the right along the exposure scale, he has doubled the previous exposure. If the opacity is plotted instead of the density, then exposure can be plotted directly, but the curve will be greatly expanded.

Densities in photographic films may vary from almost zero to as high as 3 or 4, corresponding to opacities of 1,000 or 10,000. This means that the transmission of light through the film may only be  $\frac{1}{1000}$  or  $\frac{1}{10000}$  of the light incident on the film. Such densities are rare. In color photography the maximum densities likely to be found are about 2, corresponding to an opacity of 100, or somewhat less. A good color-separation film might have a density ranging from 0.3 to 1.5, the high lights being the more dense portions.

This matter of density, opacity, and transmission is covered in greater detail later under the general subject of "densitometry." Exposure controls the density by controlling the deposit of silver.

What does development do? Development changes the silver bromide to metallic silver. It stands to reason that, if the developer is poured on a film and then is poured off quickly, the chemicals will not have long to act on the silver bromide crystals and therefore will not convert many of them to metallic silver. Such a film will be very thin. Longer development will give the chemicals time to convert more and more silver bromide to metallic silver and thus will build up the deposit of silver.

Now, for an experiment, set up two pieces of paper, one white and one gray or black, and photograph them. Then proceed in two steps.

Case A. Expose two films for different times, but give them the same development time. Inspection of the negatives will show that the film with the longer exposure will have a greater density in both

the high lights and the shadows. If densities are measured and the density of the shadows is subtracted from the density of the high lights, the difference between them is a measure of the contrast.

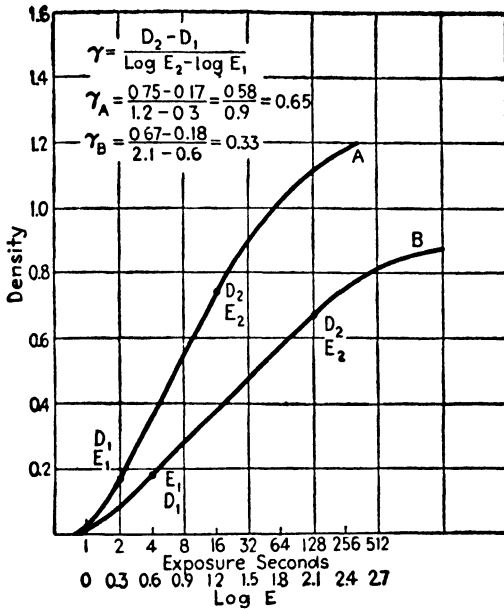

Film represented by A has been developed longer than film B; it has a steeper slope, which is expressed by stating that the negative has a higher gamma. The contrast of A will be greater than B for identical ranges of exposure.

The difference will be the same in the two films. This means that the contrast is the same in the two films.

Case B. Expose two films for identical times, but develop one longer than the other. Now measure the densities and get the difference. The film that had a longer development will have a greater density difference than the film developed a shorter time. The shadow portion will have a slightly increased density, but the portion representing the white piece of paper will have a much greater

density. In other words, the high lights (which look dark in the negative) have a greater deposit of silver in relation to the deposit in the shadows.

This brings up the technical term *contrast*. Contrast expresses the difference between the density of the high light and the density of the shadow. For a given exposure, development controls the difference between the maximum and the minimum density.

There is one more technical term; it, too, is very loosely used. This is gamma. It is often used, incorrectly, as an expression for contrast and, while the two terms are related, they are not synonymous. Gamma is actually the slope of the straight part of the H & D curve, expressing the rate at which density increases with exposure. A negative with high gamma may be a contrasty negative. If the gamma is equal to 1, then all portions of the final negative will bear the proper density relations compared to the brightness range in the original scene as long as the exposures fall on the straight portion of the H & D curve. Thus on the straight part of the curve in the illustration on page 30, note that an exposure of 4 seconds is represented by a density of 0.2; that doubling the exposure increases the density by 0.2 to 0.4; that if the exposure is doubled again (to 16 seconds), another 0.2 has been added to the density so that it now has become 0.6. Doubling the exposure does not double the density necessarily. The actual increase in density depends on the film and how it is processed. Note, too, that density changes mean the "differences" in density, whereas brightness or exposure ranges are in "ratios."

If the gamma to which a film is developed is greater or less than unity, then a different relation between density and exposure will exist. A negative of lower gamma will be "flat" compared to the original scene. The difference between high-light and shadow densities will not be as great as the brightness ratio that produced these densities. If this negative is printed on a contrasty paper, however, the original brightness range will be secured.

Amateur films are usually pretty contrasty. Fine-grain films used in miniature cameras are usually developed to a gamma of 0.7 to 0.9. They call for somewhat more contrasty paper than the average run of amateur film.

If two films of the same type are exposed the same time but developed differently, the one with the longer development will have greater contrast. If they are developed alike, they will have equal density and equal contrast. If exposed differently but developed alike, the longer exposure will produce a denser negative but the gamma will be the same in the two negatives. The longer exposure will require a longer printing time, but it can be printed on the same type of paper as the thinner negative.

Development increases each density value of a negative proportionally. If increasing development increases a given density by 50 per cent (the shadow portion, for example), it will be found that all other densities will be increased 50 per cent considering only the straight part of the film curve.

The manner in which development increases contrast can best be seen by a curve. If two exposures,  $E_1$  and  $E_2$  are picked from the curves on page 33, then the resulting densities,  $D_1$  and  $D_2$ , can be taken from the curve *B*.  $E_2$  and  $D_2$  are greater than  $E_1$  and  $D_1$ .

$$\text{Gamma}^* = \frac{D_2 - D_1}{\log_{10} E_2 - \log_{10} E_1} \text{ or } \frac{D_2 - D_1}{\log_{10}(E_2/E_1)}$$

\* The term gamma relates only to the straight portion of the H & D curve. Gamma expresses the rate at which density builds up with increasing exposure. A film developed to a high gamma may be contrasty or not, depending on the brightness ratio of the subject photographed. A subject with a small brightness range will produce a noncontrasty negative, even if developed to a high gamma, simply because the range of exposures to which the film has been subjected is small. Contrast is the total density difference created by the total exposure ratio. A film exposed to a very wide brightness range and developed to a low gamma may be as contrasty as a film developed to a high gamma but exposed to a limited range of brightness.

Now carry out the same business on the curve representing a longer development and see what results.



Suppose that a longer development increases all densities by 50 per cent and further, that the shadows of the first negative have densities of 0.2, the high lights densities of 0.7. Now the second film will have a shadow density of 0.2 plus 50 per cent or 0.3, and a high-light density of 0.7 plus 50 per cent, or 1.05. The density range (contrast) of the first film will be  $0.7 - 0.2$ , or 0.5 (a fairly flat negative), while the second film will have a density range of  $1.05 - 0.3$ , or 0.75. This is still a fairly flat negative—i.e., one of low contrast—but it is 50 per cent more contrasty than the first film.

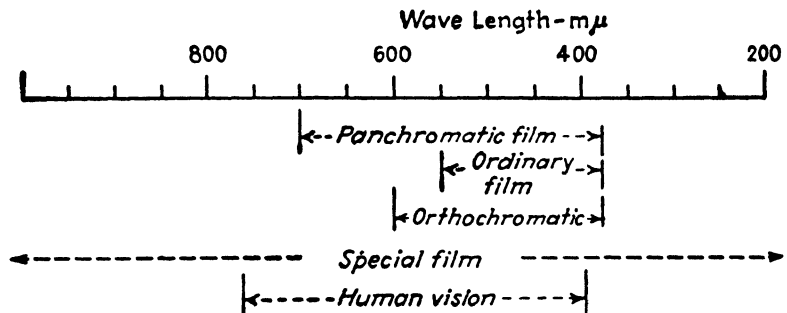

Portions of the spectrum to which various kinds of film, and the human eye, are sensitive.

### Film Types

Just as the human eye responds best to certain wave lengths of light, so does the photographic film respond best to certain wave lengths. Certain types of film respond to a very limited portion of the visible spectrum; others are sensitive to a much wider band of wave lengths. *Ordinary* or color-blind films are sensitive only to blue, violet, and ultraviolet. They are not sensitive at all to red and very little to yellow or green. *Orthochromatic* films differ from the color-blind emulsions by having certain dyes added to the silver bromide. This makes them respond to wave lengths corresponding to yellow and green. *Panchromatic* films are responsive to still more of the spectrum and can be exposed by red light.

Special films are made that are sensitive to very short wave lengths extending down into the invisible ultraviolet; others are sensitive to long wave radiations the eye cannot see. These are the infrared films which are more or less in vogue among amateurs and which are so useful to scientific photographers who wish to make photographs when the atmosphere is hazy. Since color photographs should show all colors, not merely the blue to which ordinary films are sensitive, the sensitive emulsions must be panchromatic.

Films also differ as to their speed, their contrast, their graininess. In general, panchromatic films are faster than color-blind films, but this is not necessarily so. They are very much faster to incandescent light because this light has an excess of red. Obviously, a film that is not sensitive to red would require a longer exposure to red light than would a red-sensitive film. Contrasty films are slower than long-scale films. Slow films have less grain than fast films. For color work a film with a long linear curve is advisable.

### *The Picture-making Process*

After an exploration of the technical language of films, a brief explanation of the entire picture-making process may be useful.

In making a black-and-white picture or a color-separation exposure, the photographer must pursue the following routine:

He must expose the film to light reflected from the scene upon which his camera is focused.

Having exposed the film and thereby secured a "latent" image, he must develop the film.

The exposed silver bromide grains are thereby converted into metallic silver grains.

The unexposed silver bromide crystals must be disposed of because they are still light-sensitive and will turn the picture black if it is exposed to light. The next process is *fixing*. This is a term describing the action of hypo (sodium hyposulfite) on the silver

bromide that has not been converted to metallic silver. In this process the bromide is dissolved out of the film.

Now the film should be washed to clean it of all the chemicals, and then it should be dried.

Making a picture, then, involves

- Exposure
- Development
- Fixing
- Washing
- Drying

Wherever the light hit the film, the negative will be opaque. Thus a *light* portion of the original object will be *dark* in the negative. The light and dark portions will be reversed. Making a positive print, which reverses again the order of light and dark and brings back the proper values, involves the same processes—viz., making a positive print involves

- Exposure
- Development
- Fixing
- Washing
- Drying

Wherever the original scene was light, the print will be light. Wherever the original picture was dark, as in a shadow, the print will be dark.

Positives are usually made on paper sensitized by silver chloride (contact printing paper) or silver bromide (enlarging paper). These papers are very much less sensitive to light than are films. Exposures on contact paper through an average amateur negative will be matters of 15 to 30 seconds when placed about 2 feet from a 60-watt lamp. Bromide or enlarging paper is about 100 times as sensitive as contact paper and about one-tenth as sensitive as film.

Ordinary film, being sensitive only to blue and violet, can be handled by a red light. Orthochromatic films are sensitive to blue,

green, and yellow and can be handled by the proper red light; but more care should be taken with them than with ordinary film. Panchromatic film is sensitive to all colors, however, and therefore must be handled in darkness. A very dim, green safelight can be used; but the amateur will do well to accustom himself to working in absolute darkness.

Printing paper is sensitive to blue only. Therefore, it can be handled in yellow light; and since contact paper is much less sensitive than bromide, it can be handled in stronger light than bromide.

### *Color Photographs*

In making color photographs the same general routine must be followed. The scene is photographed by exposing a color film, which is then developed. After development, the image is reversed, instead of being printed on paper, and in this process the original light and dark portions are made light and dark in the film. Because of certain dyes in the film emulsion or because of a particular development, colored images take the place of opaque silver images.

This is the process of making a transparency.

To make color prints, the scene must be photographed three times onto three negatives, each through a different filter. Then positives must be made on bromide paper in the Carbro method, on stripping film by the Chromatone (discontinued) method, on special gelatin film in the wash-off or Dye Transfer process. These positives are colored in some manner and then are transferred in register onto a final support.

By more modern processes the colored transparency is projected onto a sensitive material coated on a celluloid base, which is then processed. This material is similar to the film on which the original exposure was made in that there are three sensitive layers that, upon proper processing, give the original colors directly. In time it seems certain that such printing methods will supplant the more tedious process of making "separation negatives" and the subse-

quent printing that must take place. Printon, the Ansco material based on this general method, is the present prototype of this material.

The amateur who intends to go into color seriously, therefore, should be well acquainted with the mechanical motions necessary to expose, develop, fix, and print a film. The color technique is not essentially different from black-and-white processing. It is longer and more exacting.

Such is the photographic process in simple terms. The amateur need know very little about what happens when light hits a sensitive emulsion, or about the complicated chemical processes that take place when developer works on exposed silver bromide grains, or about what the fixer does. If he can work out a routine for handling his film and for developing it in darkness without scratching it, he will follow the paths of many hundreds of photographers who know extremely little about the chemical or physical phenomena of exposure and development and yet who make perfectly good pictures in black and white and in color.

## FILTERS

In black-and-white photography filters are used for several purposes. The average amateur uses a yellow or a green filter to bring out clouds against blue sky. Filters can also be employed in monochrome photography to make one tone stand out against another in a black-and-white picture or to bring out detail that otherwise would be lost.

In color photography filters are used for two purposes. One is for *correction*, e.g., such as correcting for excessive ultraviolet, especially in high altitudes, or making a daylight film useful at night by incandescent lamp. The other purpose is for *separation*. Filters divide up the colors of the scene into the three primary colors; they take the scene apart as to color. They are the heart of the color process.

A vast amount of work has been done to determine the proper characteristics both of the dye colors employed in color films and of the separation filters employed in recording the colors on the film on which separation negatives are made. When one makes separation negatives directly from the original subject, the characteristics of the filters—*i.e.*, the amount of the spectrum each passes—must be correlated to the sensitivity of the separation film

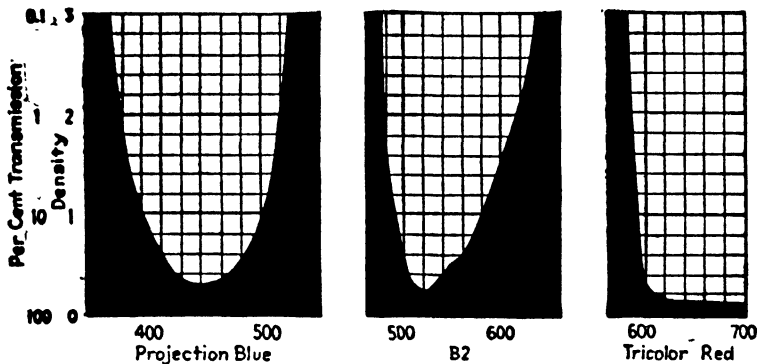

Bands of wave lengths transmitted by the tricolor filters most often used for making separation negatives. Tricolor red is the Wratten A; projection blue is the C5; B2 is a green filter.

to the various portions of the spectrum, as well as to the tristimulus (color mixture) curves for a practical set of color primaries. On this basis the Wratten tricolor filters (A, B, and C5) are very close to the ideals desired.

When separation negatives are made from a color transparency, the situation is somewhat different, since the objective is to secure the maximum separation among the three layers of the transparency. The characteristics of the filters should be based on the transmission characteristics of the dyes in the transparency. For these reasons, a different combination of filters is recommended for making separation negatives from transparencies from that used for making separations directly from the original copy.

Separation filters not only pass different portions of the spectrum but pass these portions with different degrees of efficiency. The red filter may transmit 85 per cent of light of its own color; the blue filter may pass only 20 per cent of blue light. Offhand that might seem to be a disadvantage. But remember that films and plates do not record these same portions of the spectrum with equal ability; they are more sensitive to blue light than to red light. Furthermore, under practically no illumination conditions will the subject receive equal quantities of light of all colors. In other words, in making separation negatives one must take into account the transmission of the filter, the sensitivity of the film, and the quality of the illumination.

The author believes that the best form of filters for separation work is the simplest—i.e., thin sheets of gelatin of the required colors mounted in such a way that they can be attached to the camera. When these gelatin sheets are mounted between glass, they are in less danger of being harmed, but there is also greater chance of getting negatives that do not register the three images correctly. Suppose one uses colored glass sheets instead of thin gelatin sheets. Any variation in the thickness of the glass will cause trouble, especially if lenses of focal length of 6 to 8 inches or over are employed.

A good set of tricolor filters matched in thickness and other qualities is a fine asset; but, again citing from experience, the author has found that such filters, too, are easily damaged, that the cement often loosens, that the devices by which they are held up to the camera lens are prone to injure the filter—in short, it is hard to beat the simple unmounted thin gelatin filter. Modern gelatin filters are lacquered so that they are much more resistant to abrasion and fingerprints than those not so lacquered.

Slides can be purchased in which all three square filters can be held. In operation, each can be slid over the lens in turn so that

the three exposures can be made quickly. If there is no hurry, as with still life, the three filters can be single filters, which are placed over the lens in the proper order and at the proper time.

### *Filter "Factors"*

It requires a longer time to expose a film to attain a given density when a filter is used than when none is used. The number of times the normal exposure is increased is usually called the *filter factor*, although a more correct term would be *exposure factor*. There are several reasons for this increased exposure.

In the first place, the filter does not transmit all the light of its own color; it absorbs some of it. Thus some of the light is lost. In the second place, only a portion of the wave lengths to which the film is sensitive is now being used for exposing it. The Wratten A or red filter passes only wave lengths longer than 600  $m\mu$  (it passes only 10 per cent of light of a wave length of 590  $m\mu$  or shorter), whereas the same film without a filter would receive wave lengths of from 250 to 800  $m\mu$  in sunlight.

Furthermore, films are not uniformly sensitive to all colors or wave lengths. And what is more, different films differ in this respect. For every filter, and for every film used with that filter, there is a multiplying factor by which the exposure with the filter must be increased to produce the same silver deposit that is secured without a filter.

This matter is worth considering a bit further. Suppose the film is exposed to a source of white light for a sufficient time to give the film a density of  $D$  after development. Now put the Wratten A filter on the lens. At once the amount of light that reaches the film has been reduced because all the wave lengths shorter than 600  $m\mu$  have been cut off. It is apparent that, to attain a given density after development, the film must be exposed for a longer period when the filter is used.



Suppose a filter that transmits green, 500 to 570  $m\mu$ , is used. It is still less efficient than the red filter because it absorbs more of its own color. The film is a bit more sensitive in this region, however, and so the time taken to attain a given silver deposit on the film might be about the same as with the red filter. A blue filter, however, is even less efficient. All things considered, a longer exposure still is required to produce a given density on the film. It might require 5, 6, and 10 times as much exposure with these filters as it would without them.

In color work it is desirable that a red of given brightness after passing through a red filter should produce the same density as a blue of the same brightness after passing through a blue filter. Therefore, some relation must be found between the light source, the film characteristics, and the filter transmission characteristics that will make it possible so to relate the exposures that all colors will produce identical results.

Red, green, and blue images could be set up and photographed through the three filters, giving the three negatives identical exposures. After the films had been developed, the density could be measured to see how the exposures would have to be changed to produce equal densities on the film.

A better way would be to set up a neutral-colored image in a graduated scale starting with black at one end and progressing to lighter and lighter colors until pure white was reached at the other end. These grays should pass through each of the filters equally well because gray contains all wave lengths in about the same amount.

Now the film can be exposed and developed, the density measured, and the proper exposure calculated. By this means three factors can be found that will so relate light source, film, and filters that the scales of gray will be exactly alike when photographed through the three filters on the same type of film, illuminated by the same light source, and developed in exactly the same way. In general, this

is the manner in which filter factors are determined. Manufacturers of film and filters provide tables showing the approximate factors for these products; but the photographer must really determine his own factors. As will be demonstrated in the chapter on making color-separation negatives, the photographer determines his own factors each time he makes a set of negatives. He actually uses a scale of grays in each scene, and by matching them in his three separation negatives he can tell if his exposure factors and development times have been correct.

### *Neutral Density Filters*

In making color photographs by the separation process indoors and under artificial light the fact that three exposures, each of a different time, are required is no great hardship. It would be an advantage if all three films could be exposed exactly alike, but when sufficiently long exposures are required, the photographer can time them with a watch and get them fairly accurate.

Out of doors, however, the situation is somewhat different. If the exposures are fractions of a second, the cameraman must adjust the shutter so that it exposes the films in a ratio of, say, 3, 7, and 10 for the red, green, and blue filters. Now suppose the exposure required without a filter, as measured by a good exposure meter, is  $\frac{1}{8}$  second. The exposures with filters will be  $\frac{3}{8}$ ,  $\frac{7}{8}$ , and  $1\frac{1}{8}$  seconds. The cameraman must rely on his skill at guessing as to where to set the shutter and on the mechanism of the shutter to open and close accurately in these times and in these ratios. In such a case it would be highly desirable if the exposure factors were equal. The shutter could be set once and would serve for all three exposures.

There are at least two answers to this problem. By the use of a neutral-density filter of the proper transmission, in addition to the colored separation filters, it is possible to lengthen the exposure of the green and the red filters so that they equal the exposure

required by the blue (or whichever is the longest exposure). These filters are gelatins that are neutral gray in color, like exposed film, and light transmitted through them is not affected except as to its strength. This means that there is no color effect produced by the neutral-density filter—only a diminution of the light that gets through it. Suppose that one filter requires ten times as much exposure as another. If, to the filter with the shorter exposure factor, is added a neutral-density filter whose transmission is one-tenth, the exposure required by the first filter will be approximated.

Neutral-density filters serve other purposes, but for the color photographer they have this interesting and useful possibility. The trouble is that a given neutral-density filter would be useful with only one type of film and for only one type of illumination. Thus, if it were used with Agfa Superpan for daylight, it would not be ideal for Superpan under incandescent light.

Another solution has been provided by Defender. When using X-F pan film for making separations, Defender provides two sets of separation filters, one for use with incandescent light and one for sunlight. The filters are made so that they provide more or less equal exposure with X-F pan film. Excellent negatives and prints can be made by this method.

### FILMS FOR COLOR SEPARATION

While any panchromatic film can be used for separating colors, some are better than others for color work. Some photographers do not use the same film for all three exposures but use two or even three different films. For example, a photographic emulsion, not made color-sensitive by dyes or other methods, has its peak of sensitivity in the blue region of the spectrum. This could be used as the blue-recording negative. Since, however, it is also sensitive—although to a small extent—to other colors, say green or even to a slight degree red, its separation will not be sharp. Colors other than blue will register on such a film, especially if it is overexposed.

Some color experts use a special blue-record film (for example, Defender Blue Record), a panchromatic for the red colors, and a highly green-sensitive film for the green. The green-record film of this sort may be "sharply cut" like a sharp filter, registering only green and, when used behind a deep yellow filter to cut out blue, to which the film is also sensitive, may give somewhat better separation than is obtained by using a panchromatic film behind a green B filter.

### *Advantages of Nonpanchromatic Films for Separation*

The use of a film that has high green sensitivity for the green record makes it possible to use a yellow filter. A yellow filter is more efficient than a green filter. Thus the exposure can be shorter. As an example, the filter factor for photoflood light with X-F Orthochromatic behind a Wratten B filter is 6; behind a Wratten K-3 filter, it is 3. Since the ortho and the pan films have about the same speed, the exposure time has been halved by using the X-F ortho film and a yellow filter instead of a pan film and the green filter.

Consider the film that is to record blue. Using X-F (Defender) pan film and a blue filter (Wratten C-5), the filter factor is 10. Using the Defender Blue Record film and no filter, the exposure factor compared to pan is 1.7. This represents a decrease in exposure of six times. Furthermore, the blue-record film does not require additional development time to bring it to the same gamma as the films exposed for red and green records. More on this general problem will be found in a later chapter.

### *Effect of Overexposure and Underexposure*

The following data are taken from the Defender booklet on making separation negatives.\*

\* POTTER, ROWLAND S., *Methods of Making Three-color Separation Negatives*, Defender Photo Supply Company, Rochester, N. Y.

While the latitude in exposure in color work is not so great as in black and white, still there is some leeway. It is better to overexpose than to underexpose. Underexposure will hopelessly upset color balance. Overexposure with standard development will give dense negatives that will require longer printing time, in case prints are to be made; but if the three scales of gray are well matched, good prints can be obtained. If the colors in the object to be photographed are all bright but of varying hue and if the range of brilliance is not great, it is possible to give eight times normal exposure. But suppose the colors are not all equally bright. Consider a subject that is a bright orange-red tinted with a small percentage of blue and, in the same subject, a deep purple with a small percentage of red. Now the exposure latitude will be much reduced.

Overexposure will bring up the blue of the bright reds, and underexposure will suppress the small percentage of red in the purple shadows.

It is for this reason that the most pleasing color effects are secured when the intensities of the several colors are approximately equal. Flat lighting helps in this respect, but the intrinsic brightness of the colors themselves must be watched.

### *Correct Exposure*

It is a good plan to expose so that shadows (the least bright portions of the scene) will just reach the straight-line portion of the H & D curve. The negatives should show detail in shadows; they should not be blank film. In making portraits, avoid strong lights on faces. Otherwise they will print white, and there should be color in the face. It is the author's feeling that most amateurs use altogether too much light in their portrait making. Photofloods, unprotected by diffusing cloth, give blank white faces that are very sad indeed. Overexposed faces will be devoid of flesh tones in a color print, and unless the photographer is careful in lighting, his prints will not be successful.

### LATITUDE, DENSITY RANGE FOR COLOR

Modern films of the panchromatic type will handle without distortion a very wide range of brightness, and after exposure and development will contain a very wide range of densities from high lights to shadows. The color photographer, however, must not attempt to utilize the full capabilities of his negative materials.

Color-printing processes do not have as long an exposure scale as the material on which separation negatives are made. This means that ideal separation negatives are not so contrasty as average snapshooters' negatives developed at the corner drugstore. The density range for color-printing methods should be about 1.0 or a bit more—*i.e.*, the maximum density may be 2 and the minimum may be 1, or the maximum may be 1.5 and the minimum may be 0.5. In the Kodak Dye Transfer Process for making color prints, negatives having density ranges all the way from 0.8 to 1.8 can be used by varying the process slightly.

If the photographer makes separation negatives from the original scene, he can control this density range. But if he works from color transparencies, he will often get into trouble. The density range in Kodachrome film will be greater than the desired range of 1.0 in nearly every case. Suppose a bright red butterfly is on a dull green milkweed leaf. Ideally, a print should show both green and red in proper color and contrast. But it may be found that beautiful green leaves are secured in the final print while the butterfly is not red but mostly white. Inspection of the separation negatives made from the transparency will show that the green leaves do not have a very great deposit of silver. They print in fairly short time. The red butterfly, on the other hand, is very bright. It reflected much light into the camera and registered as a brilliant red. The separation negatives, therefore, are very heavy (dense) in the portions of the butterfly that represent this red color. These portions will require much longer printing time.

The photographer must decide whether he wants true red or true green. If he prints for the green leaves, his butterfly will be weak in color. If he exposes longer and prints for the red of the butterfly, the green leaves may turn out black. The trouble is that the transparency that represents the original scene covers a wider brightness range than can be handled in the chosen printing process. Soft separation negatives are a requirement for subjects of this type.

This is one of the reasons why flat lighting is desirable. It is also one of the reasons why the colors selected for photography should be of the same brilliance. In outdoor scenes this is difficult, but in still life the photographer has matters more under control. This is one of the reasons why so little outdoor color photography is shown at exhibits.

Another reason for flat lighting is to avoid dark shadows. In some printing processes it is difficult to print these dark heavy colors (black in the case of shadows). Therefore, the lighter colors of the final print may be correct, but the heavy colors may be weak. This may be a mechanical reason—as in making transfers of dyed images when the heavy dyed portions do not transfer well—or it may be a chemical or photographic reason—as when the heavy portions block up and do not come out true. In the chapter on making separation negatives will be found lists of films, filters, and processing procedures that will relate more directly to this step in making a color print.

For the moment the amateur should remember that some films are good for color and some are not so good, that there are filters and filters, that each filter and each film and each light source has a contribution to make to a color print, and that each must be taken into consideration when prints are to be made.

Most amateurs have educated themselves to believe that a good negative is one that is “snappy.” A snappy negative is one with plenty of contrast; it is hard. Contrast between dark and light objects is one of the implements with which the black-and-white

photographer works in addition to form, relative size, and other dimensional attributes of objects. To some extent he can use color in his pictures because some colors register as dark and some as light in black-and-white photography. But contrast is very important. Negatives for color printing should have a contrast (density range) that will require a No. 2 or No. 3 paper for a good black-and-white print.

The color worker has all of these factors to deal with, and in addition he has true colors. It is a characteristic of color materials that less latitude of exposure is available for the photographer to work with than in black-and-white photography.

What is desired in color work is good color separation, not harsh contrasty negatives. Suppose that a scene could be arranged so that every object reflected equal amounts of light to the eye and to the camera. It would be a flat subject when photographed without a filter. There would be little contrast in the negative because there is little contrast in the scene. Suppose, however, that this scene has different colors in it and that it is photographed three times, once through each of the color-separation filters. Inspection will show that the three negatives do not look at all alike. Certain colors might register only a little on one of the films and considerably on the others. In other words, the separation process has been successful. Later processing of these negatives will produce a good color picture.



## Making Transparencies

**S**IMPLEST OF ALL color photography is the making of a transparency. At the present time it is also the most satisfactory; and it is the oldest form of color photography. A transparency, as one might suppose, is a film or plate on which the scene or subject is registered in natural colors. It is viewed by transmitted light and is a positive, not a negative.

It is simple because one buys a film that is inserted into the camera, is exposed, and is processed, whereupon one has his picture in colors. It is in the form of a film, and there is only one copy. Other copies, which are also transparencies, can be made from this original.

Color prints on paper can be made from these transparencies by several methods, but none of the methods is simple. The least difficult do not produce the best pictures; the most difficult are time-consuming and require a more rigorous procedure than the average amateur has had to learn.

At the present time three color films are available for making transparencies—Kodachrome, Ansco color and Ektachrome. In addition, Kodacolor is a different type of film, not adapted to making transparencies for projection but produced for the sole purpose of making color prints. Kodachrome and Ansco color are supplied in two general forms—roll film for use in small cameras and sheet film for larger cameras. The sizes available vary with the manufacturer, Kodachrome roll film being available only for 35-mm and Kodak Bantam cameras while Ansco color is stocked for several small film sizes. Sheet film can be obtained in the most generally used sizes. Since the list will be changed from time to time, the photographer

should check to see if films are available in the sizes he wishes to use. The most recent change in this picture is the production of 35-mm Kodachrome film in thirty-six exposure lengths and the introduction of Ektachrome in the 120 and 620 roll-film sizes. On the latter films one can secure six  $2\frac{1}{4}$  by  $3\frac{1}{4}$  or nine  $2\frac{1}{4}$  by  $2\frac{1}{4}$  pictures. The similar Ansco roll produces nine and twelve pictures, respectively. The cost per roll is approximately the same and, of course, is appreciably less than the same size films purchased as sheet film.

Color films are made for use under two lighting conditions—daylight and artificial light. It is possible to use these films under conditions for which they were not specially made, but better results will be obtained if daylight film is employed when the subject is illuminated by daylight and if film adapted to artificial illumination is used under the corresponding condition. If it is necessary to carry a single type of film and to use a single filter, then the best bet is to standardize on artificial-light film and to use the proper filter so that the daylight film can be employed outdoors.

### GENERAL CONDITIONS IN EXPOSING COLOR FILM

Although it is no more difficult to expose and to get a good picture with color film than it is with ordinary black-and-white film, certain conditions are important and must be recognized and kept in mind when using color film. Otherwise one simply wastes film and time and stores up disappointments. The rules for making good transparencies and good color prints are not many nor are they difficult to follow out. These rules can be violated when one knows what he is doing and how to achieve special results. But for general work, follow the rules.

**SUBJECT COLOR.** One must always remember that the appearance of an object varies with the color of light by which it is illuminated. He must also remember that one is accustomed to “discount” the special appearance of the subject when lighted by special conditions

so that, when a color film looks peculiar, the cause may not be in the film or in its processing but, rather, in the very way the photograph was made. Subjects photographed in the late afternoon may appear quite reddish or yellowish for the simple reason that the sunlight at that time of day is red or yellow rather than blue or white. Subjects photographed under ordinary tungsten lamps will also appear yellow or red unless special film or filters are employed. The truth is that humans automatically adjust their seeing abilities to these special circumstances and do not realize how red or yellow the subject is unless they look for this condition carefully. The color film, however, has no ability to make the necessary mental adjustments. It takes what it sees and it takes it accurately. The result, however, may be very distressing to the eye!

Shadows on snow on a day when the sky is brilliant blue are bluish and painters and color film so record them. The eye, however, does not see this blue color since humans are accustomed to think of shadows as being gray or black. If the photographer focuses such a scene on the ground-glass screen of a camera and covers up his head and the rear of the camera so that he sees nothing but the screen, then the shadows will appear blue. Another test is to stand inside one's house looking out the window or the door in such a way that a black frame is around the scene he views. Then if his eyes are not partially blinded by the brightness of the snow, he will see that the shadows are blue. This blueness comes from the natural fact that the subject shaded from the direct rays of the sun is illuminated only by the blue sky. Since any object illuminated by blue light will appear blue to the eye, the snow shadows are blue.

One should remember, too, that a subject will take on the color of objects that reflect light to them. Thus many an otherwise excellent portrait is ruined because the delicate tones of the face appear green (if the subject is near green foliage) or red (if the subject is near a brick building). One way to overcome this difficulty partially

is to make sure that the object that is reflecting colored light to the subject appears in the photo. Then the person who looks at it does not have an uneasy feeling if the face tones are tinged with green or red.

**LIGHTING CONTRAST.** Color film will not record as great brightness ranges as will black-and-white film. If the scene is very bright in places and yet has dense shadows, one must expose so that either will be correct—*i.e.*, so that details will be seen in either the shadows or in the high lights; the color film will not record both. The way out of this difficulty is to illuminate the shadows with reflectors or with supplemental flash. A white cardboard or cloth or even a newspaper will often raise the illumination in dark areas by a factor of two or three if properly placed.

The best position to take with respect to the subject is such that the illumination comes from the rear of the camera. This is “flat” lighting and it produces flat black-and-white pictures without much shadow; but it is best for color pictures. High noon on a summer day is not the best time to make portraits outdoors. Heavy shadows under the eyes, nose, and chin are sure to result. Here, again, a reflector placed on the ground and propped up at the proper angle will reduce these shadows. Midmorning or midafternoon will produce better results than noontime. Days on which the sun is somewhat hazy produce very soft shadows and pleasing color pictures. Similarly, photos made on dull days may be excellent, although they may be a bit on the bluish side.

The use of great masses of shadow is not ruled out of color photography, but such shadows must be employed with far greater caution than is the case in black-and-white photography. The placement of such areas is most important; the extent of the shadow in relation to the high-light portion is also important. The amateur should note how professionals of high standing employ dark backgrounds as evidenced in the fashion magazines and in certain other national advertising.

Much useful data will be found in the "Data Book on Color Photography with Kodachrome and Kodacolor Films," a section of the *Kodak Reference Handbook*.

## EXPOSURE

Color pictures must be exposed with much greater care than that which the average amateur gives his black-and-white films. It is an axiom that correct exposure lies within a half stop of the lens diaphragm. By this is meant that if the correct exposure is made at a lens opening of  $f/6.3$ , opening the lens to  $f/4.5$  would over-expose the film and would make it too light. Since the ratio of the light admitted to the film at the larger opening ( $f/4.5$ ) to that at the smaller opening is 2 to 1, it can be seen that doubling or halving the correct exposure is most likely to produce a transparency that fails to be up to the photographer's expectations.

The following table taken from the data book, *Kodachrome and Kodacolor Film*, places the run-of-mine pictures that one is likely to take into three general categories.

**Average Subjects**—Combination of light and dark subjects in about equal proportions. Ordinary family snapshots usually fall in this group with normal exposures required.

**Light Subjects**—Beach and snow scenes, light-colored flowers, people in white clothing, light-colored buildings, and subjects of similar character. Light subjects should be given a half stop less exposure than would be needed for average.

**Dark Subjects**—Dark foliage, deep-colored flowers, dark animals, buildings, and like subjects. A half stop more than the exposure for average subjects is required.

When one has made a mistake and wishes not to do it again, he should remember that transparencies are made by a reversal process—i.e., contrary to black-and-white print experience, an over-exposed color picture is light and not dark, an underexposed color picture is too dark. When one thinks of such pictures as having too little light so that the picture is too dark, he will soon be able to

judge correctly the incorrectness of his exposures. In an overexposed color transparency, the colors are thin and washed out.

The author has found that with a Leica camera the correct exposure for "average" subjects in full sunlight is  $\frac{1}{60}$  second at  $f/6.3$ . One must remember, however, that the speed markings of practically no camera shutter are correct and that the actual exposure, made up of the amount of light admitted (lens opening) multiplied by the length of time the shutter is open (shutter speed), may be far from what one would suppose by looking at the markings on the lens and shutter.

The best thing one can do in getting acquainted with color film is to deliberately shoot a roll or two at several "average" scenes, varying the exposure and lens opening, keeping track of the exposure conditions. When the films are processed, one can see which of the combinations of lens opening and shutter speed produces the best results. To make the best possible transparency—not just an acceptable job—requires a very accurate exposure.

The effect of placing various colors in proximity to each other is a subject that must be learned by experience. Some colors "fight" with others; on the other hand, proper use of contrasting colors will produce pleasing effects. Autumn foliage is more startling against a darkened blue sky, as produced by use of a Kodak Pola-Screen. The color of other objects in the picture will not be changed by the Pola-Screen.

The whole question of backgrounds is most important; many an otherwise perfect color shot has been ruined by improper background or by improper lighting of a good background. Solid backgrounds are less obtrusive than splotched ones and at the same time can point up a color shot tremendously. Inadequate lighting of a solidly colored background will change its color completely. With each roll of film the amateur will find a sheet of instructions and he can do himself a good turn by observing these directions carefully.

Photoelectric exposure meters can be as useful in color photography as they are in black and white. They must be used with more care, however, since the latitude of exposure with color film is so much less than with black and white. Therefore, if one throws his exposure meter around and upsets the calibration, he will be in trouble. One must remember that the photoelectric meter is a delicate instrument; extremes of temperature may be harmful, and a mechanical shock occasioned by dropping it on the floor or a general lack of the care that should be given to any expensive and accurate measuring device may throw it out of calibration.

Other types of exposure meters, such as the extinction types or visual exposure devices, are not sufficiently precise and reliable to produce good results in the hands of the average amateur. Meters with Scheiner and DIN settings fall in this category. Furthermore, two photoelectric meters may not read alike. Test exposures should be made using the photographer's camera on subjects of the type he generally records and under conditions normal to the particular photographer. In this way he will discover the best settings for his particular equipment.

Numerous methods have been advanced for using the exposure meter, some depending on the use of a white or gray card illuminated by the same light as the subject. The card should be so placed that the entire field of view of the meter is covered by it. For example, the outer envelope from a package of Kodak photographic paper, 8 by 10 size or larger, can be placed in front of the subject and facing the camera. The meter is held close to the envelope but not close enough to cast a shadow on it. For average subjects the exposure indicated by the meter should be doubled.

Some meters, such as the General Electric, can be used at the subject position by pointing it at the light source. This indicates the amount of illumination falling on the subject. Such procedure is especially useful when the light intensity is low.

In general, the meter should be placed close to the subject so

that the light entering the meter is restricted to the light that is reflected by the subject. Standing far off and pointing the meter in the general direction of the subject is not so good since the angle of view may take in brighter reflecting sources than the subject and thus lead to underexposure. A very prevalent cause of overexposure is inadequate illumination of the background in artificial lighting setups. The meter reading, taken from the camera position, indicates a longer exposure than is required by the subject.

Any meter reading on outdoor subjects that indicates less exposure than  $\frac{1}{50}$  second at  $f/8$  (less than  $f/11$  with an amateur motion-picture camera) should be disregarded, as underexposure is certain to result unless such exceptional subjects as bright clouds or airplanes in flight are recorded.

### Outdoor Subjects

Although color film can be used to record any subject that might be recorded in monochrome, it is on close-ups that the full benefit of color is realized. Scenes that include distant colored objects do not show off to best advantage because distance dulls colors unless the atmosphere is extremely clear. Bright sunlight provides bright colors but also causes deep shadows. It is amazing how dark masses of shadow attract the eye in color pictures; they must be avoided by the use of flat lighting (the sun over one's shoulder) unless special effects of shadow are desired. Even then the picture is likely to be disappointing.

Although cameras and shutters differ, basic exposure for color film at present on the market is  $\frac{1}{50}$  second at a lens opening between  $f/5.6$  and  $f/8$  in direct sunlight. Wherever possible shadows should be illuminated by reflectors or by flash bulbs.

The tables below, provided by the manufacturers, are good starting points. But remember to get familiar with the particular camera and shutter to be employed, using the exposure meter settings as guides only.



## EXPOSURE METER SETTING—DAYLIGHT ROLL FILM

	<i>Weston</i>	<i>GE</i>	<i>ASA</i>
Kodachrome Film, Daylight Type	8	12	10
Kodachrome Film, Type A*	8	12	10
AnSCO Color Film	10	16	12

\* With Kodachrome Type A Filter for daylight.

### *Special Outdoor Subjects*

The following notes are from the author's experience as well as from the Kodak data book, *Kodachrome and Kodacolor Film*. Since Kodachrome and Ansco color films have essentially the same speed, it is likely that the data will apply to both films.

**FLOWERS.** Flowers are delightful subjects and can be photographed in masses or individually. Many amateurs make hobbies of recording single blooms by means of accessory close-up lenses (portrait attachments) or by the sliding focusing attachments available for certain 35-mm cameras. A small camera using sheet film and having double extension bellows will enable one to make pictures of blooms the same size as the subject. Attachments are also available for sheet-film cameras enabling one to use 35-mm film. There is a certain advantage in using these larger cameras since one can focus the flower critically upon the ground-glass screen; and one has available a lens of longer focal length. A 9- by 12-cm camera, a popular size, has a lens of about 135-mm focal length, thus enabling the photographer to make larger pictures from the same distance, subject to lens, than would be possible with the 2-inch lens ordinarily employed on a 35-mm camera.

Flowers have one objection—they want to move with the wind. This difficulty requires the use of a faster shutter speed, larger lens opening, or considerable patience waiting for a moment when the bloom is quiet.

If side or back lighting is employed to bring out texture, longer exposures will be required. A reflector of white cardboard, crumpled tin foil, or a metal plate having a neutral color will be useful in the field. Backgrounds are always troublesome, so one needs to provide himself with a set of colored or neutral cardboards for this purpose.

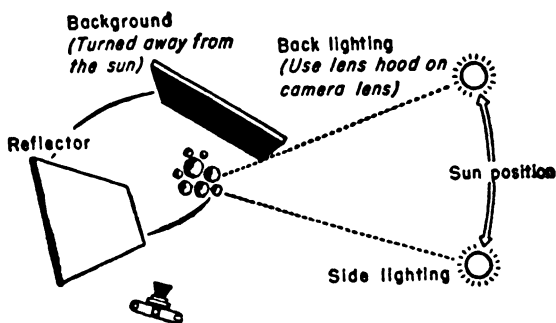

Use of reflector and background in making pictures of flowers out of doors.

**SUNSETS.** Many persons have been taught that they cannot shoot a picture against the sun. For this reason they believe they cannot photograph sunsets or sunrises in color. One will catch on film what one sees with his eye, and if he stares directly into an unobscured sun, he won't see anything he will want to record on film. But when the sun is partly or entirely behind clouds and the sky is aglow with color, he can try  $f/4.5$  at  $\frac{1}{50}$  second. After the sun has actually set, much longer exposures will be required to record the delicate colors remaining in the sky.

**SNOW AND BEACH SCENES.** The tendency in winter, when the ground is covered with white snow, is to underexpose, especially if an exposure meter is used. The trouble comes from the vast expanse of light-reflecting snow—the same trouble one gets into in summer when the exposure meter is permitted to “see” too much of the light of the sky compared to the immediate subject of interest. Take the exposure meter up close to the subject and expose for it,

not for the acres of white snow all about. Landscapes, in which sky or ocean or snow or sand is the major element of interest, are different matters. Under any conditions estimate or measure the exposure for the subject of major interest.

Remember that the light in winter is not so strong as in summer; so if there is no snow, give about double the summertime exposure.

The Kodak Reference Manual has the following item on tropic exposures:

There are two extremes of prevailing tropical weather conditions, and these require a slight difference in exposure:

1. In many tropical areas, such as the West Indies, the air is almost continually hazy, but this haze appears to be neutral in color and its effect on color is neutral. The haze is actually helpful in making color pictures, because it diffuses sunlight, softens shadows, and thus lowers the contrast range of the scene.

For this type of hazy-day picture with Daylight Type Kodachrome films, the exposure required is  $\frac{2}{30}$  second at between  $f/4$  and  $f/5.6$  for average-colored subjects; for light-colored subjects—beach, marine, and distant views— $\frac{1}{30}$  second at  $f/5.6$ . Kodachrome movies at normal speed require  $f/5.6$  for the first-mentioned subjects and one-half stop less for the second. On very hazy days, the diffusion is so complete that no additional exposure is needed for side or back lighting.

2. The second tropical weather condition is the one encountered in the southwest United States and central Mexico, where the atmosphere is often extremely clear and the range of light intensities very great. The lighting contrast may be so great that if the exposure be calculated for the brightest parts of the scene, the shadow areas will be rendered very dark. The best pictures under these conditions are those made with full front lighting so as to have relatively few shadow areas. Pictures of people taken at midday with the sun directly overhead should be avoided because of the shadows under eyes, nose, and chin. The exposure for such subjects, which are usually very light in color, is  $\frac{1}{30}$  second at  $f/8$ .

Eight- and sixteen-millimeter Kodachrome Daylight Type film require an aperture of halfway between  $f/8$  and  $f/11$  at normal camera speed. If the shadow areas are large and important, as is the case with some side-lighted subjects, the exposure must be doubled and some of the high-light detail sacrificed. If the subject is back-lighted and the

high-light details unimportant, the scene should receive four times as much light as the same scene in flat sunlight. In this instance, the shadow regions alone will receive correct exposure and there is no need to give a compromise exposure for both high lights and shadows.

### *Synchronized Flash in Outdoor Photography*

It is a fact that color films will not record details over as wide a brightness range as black-and-white films and that deep shadows are to be avoided in color work. At times, even out of doors, there is not sufficient light for straight photography even if the shadow problem is disregarded. Fortunately it is possible to use flash lamps in these situations. A brightness range of 9 to 1 or greater is not uncommon when the sun is bright. For a good picture, the brightness ratio should not be much greater than 3 to 1 obtainable in bright sunlight and with a clear blue sky by use of No. 22B or 5B flash lamps.

A reflector can be used to improve the illumination of the shadows. Flash lamps Nos. 5B and 22B can be fired in synchronism with the shutter for the same purpose. These lamps have blue bulbs and emit light having approximately the quality of daylight. They should be used with a shutter equipped for flash or in a correctly adjusted synchronizer having an efficient reflector. Obviously, the illumination from the flash should be aimed at the shadows if the purpose in using them is to lower an incorrect illumination ratio.

If the lamps are to be kept at the camera regardless of the distance to the subject, then some means must be provided for reducing the amount of illumination for close-ups. Kodak literature recommends the use of a clean white handkerchief draped over the flash reflector. The table on page 66 is stated to be effective under clear blue sky and bright sunlight and applies to front lighting as well as side and back lighting.

One thickness of handkerchief reduces the illumination from a flash lamp by one-half. For more data on the use of supplemental flash, the reader should procure a copy of the Kodak pamphlet, Sup-

DAYLIGHT TYPE KODACHROME,  $\frac{1}{2}$  SECOND AT  $f/5.6$  TO  $f/8$ 

<i>Lamp-to-subject Distance in Feet</i>	<i>Use of Handkerchief with 5B Lamp</i>	<i>Use of Handkerchief with 22B Lamp</i>
4	2 thicknesses	Use 5B lamp
6	1 thickness	2 thicknesses
8½	No handkerchief	1 thickness
12	Use 22B lamp	No handkerchief
17	Use 2 22B lamps	No handkerchief, 2 lamps
24	Use 4 22B lamps	No handkerchief, 4 lamps

plementary Flash for Outdoor Color Pictures, from which this table was taken.

The author has used the metal foil wrapped around photographic sensitive materials as reflecting material after it has been crumpled up and then straightened out again. Crumpling breaks up the surface into many small surfaces and tends to prevent "hot spots" of reflected light. Still-life separation negatives can be taken in this manner, especially where light comes from overhead and the under parts of the subject may be poorly lighted. The crumpled foil can be placed around the base of a flower setup, thereby giving some illumination to the under parts of the petals or leaves.

## COLOR PHOTOGRAPHS BY ARTIFICIAL LIGHT

Color film is "balanced" for illumination of certain characteristics, and if the wrong lights are used, the colors of the finished transparency will not be satisfactory. Ordinary home-lighting lamps, for example, are much too yellow and produce too little illumination for use with color film.

## EXPOSURE METER SETTINGS—ROLL FILM

<i>Film</i>	<i>Weston</i>	<i>GE</i>	<i>ASA</i>
Kodachrome, Type A	12	20	16
Anso Color	10	16	12

Photoflood lamps have the proper characteristics for use with 35-mm Kodachrome. For Kodachrome Professional (sheet) film and roll and sheet Ansco color film, special lamps known as 3200°K lamps are available. The manner of using these sources of light is described below. Although the data are taken largely from Kodak literature, it is quite probable that the same data will apply to Ansco color film.

Photofloods Nos. 1, 2, and R2 enable one to use Kodachrome film, Type A, without filters. The R2 lamps require no reflectors and for this reason are specially useful in the home. They and the No. 2 lamps have twice the life and give twice the light of No. 1 lamps. Daylight flood lamps can be used with daylight color film when an indoor subject illuminated by daylight requires supplementary lighting. If these lamps are employed as the principal light, as for portraits, or independently of daylight, the results are inclined to be on the red side. (See Daylight Sheet Color film below.)

PHOTOFLOOD EXPOSURE TABLE—STILL CAMERAS

*Basic exposures for Kodachrome Type A with No. 2 flood lamps in reflectors or with R2 photofloods*

Shutter Speed in Seconds	Number of Lamps	Lamp-to-subject Distance with No. 2 or R2 Photoflood Lamps in Feet					
		f/2	f/2.8	f/3.5	f/4	f/4.5	f/5.6
1/25 or 1/30	1	5	3 3/4	3			
	2	7 1/2	5 1/2	4 1/4	3 1/2	3 1/4	
1/5 or 1/4	3	9	6 1/2	5	4 1/2	4	3 1/4
	1	12	8 1/2	6 1/2	6	5 1/2	4
	2	17	12	9 1/2	8 1/2	7 1/2	6
	3	21	15	12	10	9 1/2	7 1/2

*Note* Not more than six No. 1 or three No. 2 or R2 flood lamps should be used on a single fused circuit, as any load in excess of this number is likely to blow the fuses. If there are two independently fused circuits in a room, two No. 2's can be used on each circuit, but one should remember that the total load should not exceed this value.

Photoflash lamps are useful for short exposures indoors when one is making photographs of children or large groups where lots of light is necessary. Lamps Nos. 22 and 50 may be fired from the house-lighting circuits; SM and Nos. 5 and 11 are to be fired from synchronizers; Nos. 6 and 31 are long-peak lamps designed for use with focal-plane shutters.

#### PHOTOFLASH EXPOSURE TABLE—STILL CAMERAS

*For Type A Kodachrome with Kodak CC15 filter for average subjects in average rooms with light-colored walls and ceilings. For dark-colored surroundings or dark-colored subjects use one full lens opening larger*

Distance in feet of No. 22 lamp in Kodoflector (matte side)	7	10	14	20	28
Lens aperture for open-flash exposures	<i>f</i> /22	<i>f</i> /16	<i>f</i> /11	<i>f</i> /8	<i>f</i> /5.6

#### PHOTOFLASH GUIDE NUMBERS

*When used in an average flash reflector, divide the guide number by the distance in feet from lamp to subject to get the recommended f-number (lens opening) for average subjects in average-sized rooms with light-colored ceilings and walls*

	<i>Between-the-lens Shutters</i>					<i>Focal-plane Shutters</i>	
	<i>SM*</i>	<i>No. 5†</i>	<i>No. 11†</i>	<i>No. 22†</i>		<i>No. 6†</i>	<i>No. 31†</i>
Open, $\frac{1}{25}$ , $\frac{1}{50}$	50	90	100	145	$\frac{1}{50}$	65	70
$\frac{1}{100}$	50	75	80	115	$\frac{1}{100}$	45	50
$\frac{1}{200}$	35	60	65	90	$\frac{1}{250}$	30	35

\* No filter or Kodak CC23 for slightly warmer results.

† With the Kodak CC15 filter.

AnSCO color film is adapted to the 3200°K lamps originally brought out for use with Kodachrome sheet film. AnSCO color film, both roll and sheet film, is balanced for this particular type of lamp without the use of filters, and the amateur should plan on obtaining such lamps. Filters (see below) are available for adapting the

film to other sources of artificial light. Under the general subject of SHEET COLOR FILM will be found data on the 3200°K lamps.

Daylight type Kodachrome film may be used indoors independently of daylight by use of flash lamps Nos. 5B and 22B. Use the following guide numbers:

Lamp No. 22B: Open flash, 50;  $\frac{1}{100}$  sec, 40;  $\frac{1}{200}$  sec, 25

Lamp No. 5B: Open flash, 45;  $\frac{1}{100}$  sec, 35;  $\frac{1}{200}$  sec, 25

### USE OF EXPOSURE METER WITH LIGHTS

When one employs an exposure meter on artificially lighted scenes, it should be held near the subject and not at the camera position. If held far from the subject, too much of the background will be "scanned" by the exposure meter with the result that the subject, which is brighter than the background, will be overexposed. The meter should be placed within 10 inches of the subject without casting a shadow on it. The directions furnished by the meter manufacturer should be followed.

As in outdoor photography, it is desirable to have the whole scene adequately and evenly illuminated. One must remember that color itself furnishes contrast in color pictures—not black-and-white contrast so valuable in monochrome. Great areas of shadow attract the eye away from the important subject matter and when present must be illuminated by additional lamps. Here the exposure meter is of great help. The background and other areas that are not the important subject matter should give not less than one-third as much reflected light as the principal subject. The ratio should be 2 to 1 if possible—i.e., the background should be lighted so that it reflects about one-half as much light as the subject.

If the Weston meter is used and if the light values fall within the "A" and "C" arrows, the illumination ratio will be 4 to 1, indicating that the illumination should be adjusted so that more light falls on the darker parts of the scene or that less light falls in the brighter portions.



## *Clothing and Background Color*

The color photographer must exercise much more care about the color of backgrounds than is required of the monochrome worker. Clothing worn by subjects whose portraits are to be made enters into the same problem. Children and older people should be photographed against different backgrounds for most pleasing results. The background should be lighter or darker than the subject but not so much different in brightness as not to photograph properly. A light subject should appear before a darker background and vice versa. The following Eastman Kodak table is most useful.

### SELECTION OF CLOTHING AND BACKGROUND COLOR

**COLOR OF CLOTHES:** Light, soft colors are most effective and should be chosen to harmonize with complexion and hair color. Avoid dark colors or black. Also avoid brilliant colors, which take attention away from the face.

**BACKGROUND:** Use light buff or gray when in doubt. Other suggested colors are as follows:

	<i>Clothing Color</i>	<i>Background Color</i>
<b>Children</b>	Light colors	White or very light tints
<b>Women</b>	Pink	Gray blue, jade green
	Blue	Yellow, darker blue
	Yellow	Gray blue
	Green	Darker green, lavender, gray
	Maroon	Gray blue
	Gray	Dull blue
	Lavender	Gray green
	White	Any light color harmonizing with subject's hair
<b>Men</b>	Brown	Buff or olive green
	Tan	Buff or olive green
	Gray	Dull blue
	Blue	Gray or buff
	White	Any light color harmonizing with subject's hair
	Khaki	Dark green

## Nighttime Shots in Color

Numerous special occasions arise when one wonders what to do. The following notes will help.\*

**STREET SCENES AT NIGHT.** If brightly lighted with signs and street lights, try  $\frac{1}{10}$  to  $\frac{1}{2}$  second at  $f/2$  with Type A Kodachrome film. Use a tripod. Give sheet Kodachrome film about 60 per cent more exposure.

**STORE WINDOWS.** About the same exposures as above.

**FIREWORKS.** Try  $f/5.6$  or  $f/8$ ; leave shutter open until display has been recorded. Use a tripod.

**STAGE SCENES.** First get permission to photograph. Try  $\frac{1}{10}$  to  $\frac{1}{20}$  second at  $f/2$ . Don't sit too far back.

## PORTRAITS IN COLOR

Portraiture in color differs from black-and-white technique only in that much flatter lighting can be employed and, in fact, is desirable. Once the flat-lighting method has been mastered, more "arty" arrangements can be attempted.

A single R2 flood lamp or a No. 2 lamp in a reflector can be placed slightly above and to one side of the camera, providing almost full front lighting with some shadow areas cast outside the important picture area. A reflector such as a white matte card or a bed sheet draped over something flat and rather solid should be located just outside the picture area and at such an angle that the maximum amount of light is reflected upon the subject into the areas that are shadowed without the reflector. Direct the lamp at the reflector. Place the subject close to a light-colored background. Such an arrangement taken at  $\frac{1}{10}$  second at  $f/4$  or  $f/4.5$  will provide a good one-lamp picture.

Another simple placement of subject, camera, and lights employing two R2 lamps or two No. 2 lamps in reflectors is as follows.

\* Data from Eastman Kodak Company.

One lamp is at camera level or slightly above it, the other is used as a modeling or side light and is above camera level. Both should be about 5 feet from the subject, which is close to a light-colored background. The side light is placed so that it casts a triangular area of light on the cheek of the subject opposite the lamp. Such an arrangement will give a 2 to 1 lighting ratio and is the basic two-lamp setup. Variations giving a greater lighting ratio may be experimented with after this technique is mastered. An exposure of  $\frac{1}{10}$  second between  $f/4$  and  $f/5.6$  will give good results. A lens shade or hood is helpful in keeping direct rays of light from the lamps out of the camera lens.

A useful article by W. S. Kals on the subject of color portraits using larger cameras and more lights will be found in *American Photography*, August 1942, page 8. Another source article is that of S. G. Hall in *Studio Light*, Vol. 29, No. 2, which covers the problem of make-up for Kodachrome; and another by the same author on the general problem of portraiture in color will be found in *Studio Light*, Vol. 29, No. 3, published by Eastman Kodak Company.

### SHEET COLOR FILM

For the amateur or professional who prefers to make his color photographs in sizes larger than those obtainable in roll film, both Eastman Kodak and Ansco provide sheet film in sizes up to 11 by 14. As far as the user is concerned, the only difference between roll and sheet film is the difference in speed (sheet film is slower) and the fact that the Kodachrome roll- and sheet-film types for use under artificial light employ different light sources. Speed data and lighting directions follow.

The table on page 75 is based on tests with average subjects in bright sunlight. As lamp-to-subject distance increases, lens opening must be increased if illumination in shadows is to remain constant. Larger lens openings in turn require faster shutter speeds so that

## EXPOSURE METER SETTINGS—SHEET COLOR FILM

<i>Film</i>	<i>Weston</i>	<i>GE</i>	<i>ASA</i>
Kodachrome, Daylight Type	6	10	8
Ektachrome, Daylight Type	6	10	8
Kodachrome, Type B	8	12	10
Ektachrome, Type B	8	12	10
Anso Color, Daylight Type	8	12	10
Anso Color, Tungsten Type	8	12	10

## DAYLIGHT EXPOSURE TABLE—KODACHROME PROFESSIONAL FILM AND EKTACHROME FILM

*Lens apertures at 1/50 second shutter speed*

<i>Lighting</i>	<i>Basic Exposure for Average Subjects</i>	<i>Light-colored Subjects</i>	<i>Dark-colored Subjects</i>	<i>Side-lighted Subjects</i>	<i>Back-lighted Subjects</i>
Bright, direct sunlight	<i>f/6.3</i>	<i>f/8</i>	<i>f/5.6</i>	<i>f/6.3*</i>	<i>f/4.5*</i>
Weak, hazy sun — no distinct shadows cast	<i>f/4.5</i>	<i>f/5.6</i>	<i>f/4</i>		
Sky overcast — cloudy, but bright	<i>f/3.5</i>	<i>f/4</i>	<i>f/2.8</i>		
Open shade on bright day		<i>f/2.8</i>			

\* Assuming shadow areas are unimportant. With close-ups having important shadow areas, use one full stop larger.

## DAYLIGHT EXPOSURE TABLE—ANSCO SHEET COLOR FILM

	<i>Shutter Speed</i>	<i>Front Lighted</i>	<i>Side Lighted</i>	<i>Back Lighted or Open Shade</i>
Bright sunlight	$\frac{1}{100}$	<i>f/4.5</i>	<i>f/3.5</i>	<i>f/2.5</i>
	$\frac{1}{50}$	<i>f/6.3</i>	<i>f/4.5</i>	<i>f/3.5</i>
	$\frac{1}{25}$	<i>f/9</i>	<i>f/6.3</i>	<i>f/4.5</i>
Hazy sunlight, soft shadows	$\frac{1}{100}$	<i>f/3.5</i>		
	$\frac{1}{50}$	<i>f/4.5</i>		
	$\frac{1}{25}$	<i>f/6.3</i>		
Sun overcast, bright day, no shadows	$\frac{1}{100}$	<i>f/2.5</i>		
	$\frac{1}{50}$	<i>f/3.5</i>		
	$\frac{1}{25}$	<i>f/4.5</i>		
Sun overcast, dull day	$\frac{1}{100}$	<i>f/1.8</i>		
	$\frac{1}{50}$	<i>f/2.5</i>		
	$\frac{1}{25}$	<i>f/3.5</i>		

*Note:* For use in Temperate Zone, average summer conditions, from 2 hours after sunrise until 2 hours before sunset. In winter use next larger lens opening unless there is snow. With exceptionally brilliant light, as in seascapes, snow scenes, or high altitudes, the indicated exposure can be halved. Dark subjects require one-half stop greater exposure; light subjects require one-half stop less.

PHOTOFLASH GUIDE NUMBERS—KODACHROME  
PROFESSIONAL DAYLIGHT FILM

<i>Flash Lamp</i>	<i>Shutter</i>	<i>Guide Number</i>
22B	Open	50
	$\frac{1}{100}$	40
	$\frac{1}{200}$	25
5B	Open	45
	$\frac{1}{100}$	32
	$\frac{1}{200}$	22

**PHOTOFLASH GUIDE NUMBERS—ANSCO DAYLIGHT TYPE  
COLOR FILM**

*Shutter set on time or bulb or  $\frac{1}{2}$  second and synchronized with flash lamps in metal reflectors. Light-colored indoor surroundings*

FLASH LAMP	GUIDE NUMBER
GE 5B	50
GE 22B	65
Wabash 25B	50
Wabash 2B	95

**PHOTOFLASH GUIDE NUMBERS—ANSCO TUNGSTEN TYPE  
COLOR FILM**

*Use UV-16 Filter*

FLASH LAMP	GUIDE NUMBER
GE No. 5	95
GE No. 11	115
GE No. 22	135
Wabash Press 25	115
Wabash Press 40	115
Wabash No. 2	135

*How to use guide numbers.* Divide the guide number by the distance in feet from lamp to subject to obtain recommended *f*-number. Thus, if the guide number is 50, the correct lens opening at 5 feet is  $50 \div 5$ , or *f*/10.

**SYNCHRONIZED FLASH EXPOSURES IN DAYLIGHT**

*Kodachrome Professional Daylight Film, using No. 22B or No. 5B photoflash lamps to illuminate shadows in outdoor subjects*

<i>Lamp-to-subject Distance in Feet</i>	<i>Shutter Speed</i>	<i>Lens Opening</i>
5	$\frac{1}{60}$	<i>f</i> /8
7	$\frac{1}{100}$	<i>f</i> /5.6
10	$\frac{1}{200}$	<i>f</i> /4

the sunlit portions of the subject will not be overexposed. The change in shutter speed does not affect the shadow illumination proportionally, because the duration of highest intensity of the flash is very short.

As was indicated under 35-mm Kodachrome film, supplemental flash may be very useful out of doors to reduce excessive contrast by illuminating the shadows with light approximating daylight in quality. Lamps Nos. 5B and 22B should be used in a correctly adjusted synchronizer having an efficient reflector.

With bright sunlight and clear blue sky, a desirable lighting ratio of about 3 to 1 is obtained by using one No. 22B lamp at 12 feet or one No. 5B lamp at 8½ feet. At closer distances a clean white handkerchief can be draped over the reflector to lower the illumination and thus to maintain the desired ratio. With Kodachrome Professional Daylight Type film, an exposure of  $\frac{1}{50}$  second at  $f/6.3$ , use the table under "synchronized flash photography outdoors" under the description of 35-mm film usage.

### *Use of Flood Lamps to Supplement Daylight*

Blue-bulb flood lamps can be used to supplement daylight illumination when Kodachrome Professional sheet film is the chosen color medium. It is assumed that the daylight is diffused and that direct rays of the sun do not hit the subject; that the photographer realizes that the blue bulbs tend to give the picture a warm tone especially with living models; that the illumination without the lamps is about half that when the lamps are turned on.

### *Sheet Color Film for Use with Artificial Light*

Neither Type B Kodachrome Professional film nor Ansco sheet color film is balanced for use with photofloods. On the contrary,

## KODACHROME PROFESSIONAL FILM, DAYLIGHT TYPE

*Exposure Time: 2 Seconds*

Number of Lamps	No. B1 Daylight Photofoods in Kodaflectors (matte side)			No. B2 Daylight Photofoods in Kodaflectors (matte side)		
	Average Lamp-to-subject Distance in Feet			Average Lamp-to-subject Distance in Feet		
	7½	11	16	10	14	20
1	f/5.6	f/4		f/5.6	f/4	
2	f/8	f/5.6	f/4	f/8	f/5.6	f/4

*Note:* Use the exposures indicated for two lamps only when two lamps are used together to illuminate the same part of the subject and not when a number of lamps are used separately to illuminate extended areas of the subject.

these films are adapted for special lamps having a color temperature of 3200°K. If the tungsten or artificial-light films must be used with lamps other than these special lamps, then compensating filters must be employed. The use of such filters will be described below under the general subject of filters for color film. The photographer should consult Kodak literature for more details on the use of such film than are given here.

In the studio under artificial light conditions, Type B Kodachrome Professional film can be tested for exposure as follows. Kodak Super Speed Direct Positive paper is available in sheet-film sizes and can be inserted in film holders and exposed in the camera in the usual manner. Several exposures differing by one-half stop should be made and processed. Judge the result by high-light detail, remembering that the paper is orthochromatic and will render reds and browns as very dark. The Type B film is about one-third stop faster than the Direct Positive paper.



## EXPOSURE-METER SETTINGS—COLOR FILM TUNGSTEN TYPES

	<i>Weston</i>	<i>GE</i>	<i>ASA</i>
Kodachrome Professional, Type B	8	12	10
AnSCO, Tungsten Type, Sheet	8	12	10

BASIC EXPOSURES—KODACHROME PROFESSIONAL AND  
EKTACHROME FILM, TYPE B

*Average subjects—two 500-watt PS-25 3200°K lamps in bowl-type studio reflectors*

DISTANCE IN FEET FROM LAMPS TO SUBJECT	CAMERA SETTINGS
5	<i>f/16, 1 sec.</i>
7	<i>f/11, 1 sec.</i>
10	<i>f/8, 1 sec.</i>
14	<i>f/5.6, 1 sec.</i>
20	<i>f/5.6, 2 sec.</i>

*Note:* When possible, one lamp near camera should be at lens level, the other considerably higher and at an angle of 45° to the camera-subject line.

**PHOTOFLASH EXPOSURE TABLE—  
KODACHROME PROFESSIONAL AND EKTACHROME FILM,  
TYPE B**

*For open-flash exposures with Wratten filter No. 2A and Mazda photoflash lamps in large studio reflectors*

<i>Distance in Feet from Lamps to Subject</i>	<i>F-number</i>							
	<i>Number of No. 22 Lamps</i>				<i>Number of No. 50 Lamps</i>			
	<i>1</i>	<i>2</i>	<i>4</i>	<i>8</i>	<i>1</i>	<i>2</i>	<i>4</i>	<i>8</i>
6	18							
6½	16	22						
8½	12.5	18	25		18	25		
9½	11	16	22		16	22		
11½	9	12.5	18	25	12.5	18	25	
13	8	11	16	22	11	16	22	
16½	6.3	9	12.5	18	9	12.5	18	25
19	5.6	8	11	16	8	11	16	22
23	4.5	6.3	9	12.5	6.3	9	12.5	18
26	4.0	5.6	8	11	5.6	8	11	16
30	3.5	4.5	6.3	9	4.5	6.3	9	12.5
38		4.0	5.6	8	4.0	5.6	8	11
42		3.5	4.5	6.3	3.5	4.5	6.3	9
54			4.0	5.6		4.0	5.6	8
66			3.5	4.5		3.5	4.5	6.3
75				4.0			4.0	5.6
90				3.5			3.5	4.5

*Note:* Values apply when light from all lamps is directed at the same part of the subject, and when exposures are made in rooms with light-colored walls and ceilings. Indoors with dark-colored surroundings or dark-colored objects, use one full lens opening larger. Values apply strictly only when all lamps are at the same distance from the subject.

## PHOTOFLASH GUIDE NUMBERS—KODACHROME TYPE B FILM

*Lamps flashed in an average reflector*

<i>Between-lens Shutters</i>	<i>No. 5*</i>	<i>No. 11*</i>	<i>No. 22*</i>	<i>Focal-plane Shutters</i>	<i>No. 6*</i>	<i>No. 31*</i>
Open, $\frac{1}{2}$ , $\frac{1}{50}$	75	80	105	$\frac{1}{50}$	55	60
$\frac{1}{100}$	65	65	85	$\frac{1}{100}$	35	40
$\frac{1}{200}$	40	40	60	$\frac{1}{200}$	20	25

\* With Wratten Filter No. 2A.

## EXPOSURE GUIDE—ANSCO TUNGSTEN TYPE COLOR FILM

*One 500-watt PS-25 3200°K lamp in reflector  
For average-colored subjects in light-colored rooms*

<i>Shutter Speed</i>	<i>Lamp-to-subject Distance in Feet</i>						
	<i>4</i>	<i>6</i>	<i>8</i>	<i>10</i>	<i>12</i>	<i>14</i>	<i>16</i>
<i>1</i>	<i>f/11</i>	<i>9</i>	<i>8</i>	<i>6.3</i>	<i>5.6</i>	<i>4.5</i>	<i>4</i>
$\frac{1}{2}$	<i>f/8</i>	<i>6.3</i>	<i>5.6</i>	<i>4.5</i>	<i>4</i>	<i>3.5</i>	<i>2.8</i>
$\frac{1}{5}$	<i>f. 4.5</i>	<i>4</i>	<i>3.5</i>	<i>2.8</i>	<i>2.5</i>	<i>2</i>	<i>—</i>

*Note:* Table also applies when one No. 2 flood lamp is used instead of the 3200°K lamp. Use UV-15 filter over lens.

*Data on Kodak Ektachrome Film*

Introduced in the middle of 1946, Kodak Ektachrome film is a sheet film that can be processed by the user. The chief difference between it and Kodachrome film seems to be in the shadows, which are more open. If the same scene is taken with the two films, that made on Ektachrome will have more details in the shadows, while the Kodachrome film shadows will tend to be deep black without details.

Ektachrome film, Type B, adapted for use with 3200°K lamps, can be used with photofloods, provided a color-compensating filter CC13 is employed; with flash lamps provided the Kodak CC95

filter is employed and can be used outdoors with Wratten filter No. 85B. With Weston and GE meters not calibrated in the new ASA numbers, use settings of 6 and 10, respectively, or ASA 8.

As is true of all color films, Kodak Ektachrome may be changed from time to time so that the data given here must be checked with current information supplied when the film is purchased.

The exposure table given below is for average subjects and two 500-watt PS-25 3200°K Mazda lamps in bowl-type studio reflectors. The table is based on using both lamps at the same distance and within 45 degrees of the camera-subject axis.

#### EKTACHROME EXPOSURE TABLE FOR 3200°K LAMPS

<i>Lamp-to-subject Distance in Feet</i>	<i>Camera Settings*</i>
5	<i>f/16, 1 sec.</i>
7	<i>f/11, 1 sec.</i>
10	<i>f/8, 1 sec.</i>
14	<i>f/5.6, 1 sec.</i>
20	<i>f/5.6, 2 sec.</i>

\* These values are intended for use as a guide. They will vary somewhat, according to the shape and surface properties of the reflectors, the position of the bulbs in the reflectors, and the age of the lamps.

#### *Photoflash Exposures with Ektachrome Type B Film*

Photoflash exposures can be made without a synchronizer by the usual openflash technique, which gives an effective exposure of about  $\frac{1}{50}$  second. Open the shutter, flash all lamps on the same circuit, close the shutter. The general room illumination must be low enough so that it will not affect the film while the shutter is open.

With moving subjects the use of a synchronizer is necessary. The synchronizer must be adjusted precisely so that the camera shutter will be fully open at the peak of the flash. Use an efficient reflector with photoflash lamps. Since lamps may shatter when flashed, the use of a transparent protective screen over the reflector

is recommended. Do not flash the lamps in an explosive atmosphere.

### PHOTOFLASH GUIDE NUMBERS, EKTACHROME TYPE B FILM

*For use with average reflectors and Kodak color-compensating filter CC95*

<i>Between-lens Shutters</i>	<i>No. 5</i>	<i>No. 11</i>	<i>No. 22</i>	<i>Focal-plane Shutters</i>	<i>No. 6</i>	<i>No. 31</i>
Open, $\frac{1}{25}$ , $\frac{1}{50}$	75	80	105	$\frac{1}{50}$	55	60
$\frac{1}{100}$	65	65	85	$\frac{1}{100}$	35	40
$\frac{1}{200}$	40	40	60	$\frac{1}{200}$	20	25

### FILTERS FOR USE WITH COLOR FILMS

While the manufacturers of color film make every effort to provide the photographer with materials that are easy to use—i.e., without filters or any other accessory equipment—the manufacturers have not yet been able to make a “universal” film, one that can be used under any and all lighting conditions. The trouble is that film is more exact than the human eye; it “sees” what it sees and has no power to imagine anything or to interpret what it sees. The average picture maker discounts the fact that home-lighting lamps make everything quite yellow in color. If, however, he uses daylight film to record a picture under average home-lighting conditions, he will find his color picture decidedly yellow or reddish and may be inclined to blame the designer of the film.

As a matter of fact, an enthusiast for making photographs in color will find that his perception of color subtleties will increase greatly as his experience with color-picture making builds up. He will note, for example, that his color pictures of snow scenes will have blue shadows when the picture is made under the clear blue sky. His eye has always seen these shadows as black or gray, but color film does not lie. The fact is that the shadows are not lighted by direct rays of the sun, which have all colors in them, but only by the blue sky. Thus the shadows cannot help but be blue. Paint-

ers recognize this fact and make their shadows on the blue ("cold") side.

As another example, pictures taken early in the morning or late in the afternoon are inclined to be yellowish or reddish for the reason that the blue portion of the sun's light has been filtered out by the earth's atmosphere through which it must go to reach the earth. The eye quickly adapts itself to these yellowish or reddish tones, but in a photograph they are not acceptable unless the viewer knows the facts.

White paper has a bluish tinge by north daylight, but it is yellow by ordinary tungsten light; a turquoise is blue by north daylight, green under a tungsten lamp.

The film manufacturer helps the photographer with such problems by providing him with filters that correct, or tend to correct, abnormal lighting conditions.

### *Color Temperature*

This brings up the term "color temperature." Everyone is familiar with the fact that the hotter a body gets—a piece of iron, for example—the whiter it becomes. Thus one speaks of a "dull red" heat, meaning that the temperature is low, or of something being "white hot." If a certain special type of lamp known as a "black body" is heated to a certain temperature and if the color of light given off at this temperature is measured, then another light source that has the same color characteristics may be said to be operating at a color temperature corresponding to the actual temperature of the black body.

There are various temperature scales, such as Fahrenheit, centigrade, Kelvin, and others. Centigrade has its zero at the temperature at which water freezes; Fahrenheit's zero is 32 degrees below freezing. Water boils at 100°C and at 212°F. Thus, when one speaks of so many degrees of temperature, he must define the scale about which he is speaking.

The Kelvin temperature scale is also known as the "absolute" temperature scale and is rather theoretical in that its zero is supposed to be representative of the absence of all heat. At 0°K, all molecular motion has stopped. This zero is 273° below zero on the centigrade scale.

When one speaks of a 3200°K lamp, for which Ansco color tungsten film and Kodachrome Professional film Type B are adapted, he merely means a tungsten lamp whose color characteristics are such that they resemble the color output of a theoretical "black-body" lamp operating at an actual temperature of 3200°K. He does not mean that the glass bulb has a temperature of 3200° in any scale or that it emits 3,200 units of light. He means merely that its light is bluer than that of a 25-watt house-lighting lamp because its tungsten filament is hotter than that of the 25-watt lamp. On the other hand, the illumination from a 3200°K lamp is not so blue as that of a photoflood; but while color film will register the difference in color of these two lamps, the eye will never detect this difference. A picture made by means of one light source when the film is "balanced" for the other may cause the photographer some surprise and disappointment. Filters to correct such a situation are available.

#### COLOR TEMPERATURE OF ARTIFICIAL LIGHT SOURCES IN °K

Tungsten lamp, 20 to 40 watts	2600 to 2775
Tungsten lamp, 100 watts	2870
PS-52 750, 1,000-watt lamp	2955 to 3020
Photoflood lamps Nos. 1, 2, 4	3425
Daylight photoflood lamp	4800
PS-25 3200°K lamp	3200
Photoflash Nos. 5, 6, 11, 22, 31, 50	3800
Photoflash SM lamp	3300
Blue photoflash lamps Nos. 5B and 22B	6300
Daylight fluorescent lamp	6500
White-flame carbon arc	5000

Each of the lamps in the above table has its own color characteristics, those lamps burning at higher color temperatures having

bluer light than those whose filaments actually burn at lower temperatures. All of these lamps will have a color temperature dependent on the voltage across the lamp—the higher the voltage, the higher the color temperature and the bluer the light. Thus, if one buys a 3200°K lamp made to burn on 110 volts and actually operates it at 125 volts, his pictures are likely to be too blue. A tungsten lamp designed to operate at 115 volts increases in color temperature about 10°K for each increase of one volt. Note that blue lamps have a higher effective color temperature than lamps with clear bulbs.

Furthermore, the actual voltage in the average home varies somewhat with the “load” or amount of power taken from the lines. It is unlikely that a single, or perhaps two, 500-watt lamps will lower the house voltage appreciably; but if the lamps are operated at the end of a long line of small wire, the voltage will undoubtedly be lower than the photographer thinks. For precise work, therefore, he should know the actual voltage at which the lamps are operating and buy lamps adapted for that voltage. By the use of color compensating filters, however, he can adapt his own conditions to those of the films he proposes to use.

In professional studios where great quantities of light are used, special power circuits must be installed to carry the large currents employed. Lights corresponding to 50,000 watts are not unusual where fast action in color must be photographed or where large scenes with numerous models are employed.

The average home is fused for 30 amperes or about 3,000 watts. If more power than this is required, special arrangements must be provided. If more power is taken through a set of wires than that for which they are adapted, they are liable to heat up and cause fire. That is why the circuits are fused—the fuse blows and opens the circuit before trouble occurs. Voltage regulators are not too expensive unless the power load is rather high—1,000 watts or more.



## COLOR TEMPERATURE OF DAYLIGHT IN °K\*

Mean noon sunlight at Washington, D.C.	5400
Direct sunlight about noon in midsummer may rise to	5800
Sunlight plus light from clear sky about noon, as high as	6500
Light from totally overcast sky may be as high as	6800
Light from a hazy or smoky sky may range from	7500 to 8400
Light from clear blue sky	12000 to 27000
Direct sunlight early or late in day in winter may drop below	5000
Sun's rays at sunset	2000 to 4000

\*[Data from A. H. Taylor, *Transactions Illumination Engineering Society*, 25: 154-160 (1930).

Since the color temperature of daylight varies with weather conditions, time of day, and time of year and since the color of objects illuminated by daylight will vary accordingly, filters are provided for affecting conditions at the camera so that the photographer can achieve the result he wishes. The following tables, taken from Kodak literature, show the filters to be used for securing best results with Kodachrome and Ektachrome.

LIGHT SOURCES AND FILTERS FOR USE WITH DAYLIGHT  
COLOR FILM

(Data from Eastman Kodak)

<i>Light Sources</i>	<i>Approximate Color Temperature in °K</i>	<i>Color Film</i>	<i>Filter Required</i>	<i>Color Results</i>
Sunlight plus blue sky*	6100 to 6500	Kodachrome and Ektachrome, Daylight Type	No filter	Correct
Hazy sunlight, slightly overcast sky	5800	Kodachrome and Ektachrome, Daylight Type	No filter or CC14, CC15	Warm
Noon sunlight, no sky-light	5400	Kodachrome and Ektachrome, Daylight Type	No filter or CC14, CC15	Warm

**LIGHT SOURCES AND FILTERS FOR USE WITH DAYLIGHT  
COLOR FILM—Continued**

(Data from Eastman Kodak)

<i>Light Sources</i>	<i>Approximate Color Temperature in °K</i>	<i>Color Film</i>	<i>Filter Required</i>	<i>Color Results</i>
Totally overcast sky	6500	Kodachrome and Ektachrome, Daylight Type	Haze filter or CC14, CC15	Satisfactory
Sun's rays at sunrise or sunset	2000 to 4000	Kodachrome and Ektachrome, Daylight Type	No filter	Reddish
Clear skylight alone	†	Not recommended	2A or CC15	Bluish
Daylight fluorescent	‡	Kodachrome and Ektachrome, Daylight Type	CC33	Bluish
Kodatron Flashtube FT-402 for Kodatron Speedlamp	‡	Kodachrome, Daylight Type Ektachrome, Daylight Type	CC15 C33	Satisfactory
Blue Photoflash 5B, 22B, and 50B	6000	Kodachrome and Ektachrome, Daylight Type	No filter	Satisfactory
White-flame carbon arc		Kodachrome and Ektachrome, Daylight Type	CC23	Satisfactory
Daylight (blue) photo- flood lamps	4800	Not recommended as sole source		Reddish

\* For average conditions. Color will vary with atmospheric conditions.

† 12000 to 26000°K.

‡ Discontinuous spectra.

**LIGHT SOURCES AND FILTERS FOR USE WITH ARTIFICIAL  
LIGHT KODACHROME AND EKTACHROME**

<i>Light Sources</i>	<i>Approximate Color Temperature in °K</i>	<i>Color Film</i>	<i>Filter Required</i>	<i>Color Results</i>
Clear photoflash lamps Nos. 5, 6, 11, 22, 31, 50	3800	Kodachrome, Ektachrome, Type B	Wratten 2A CC95	Satisfactory
		Kodachrome, Type A	CC15	Satisfactory
Photoflood lamps Nos. 1, 2, 4, R-2	3400	Kodachrome, Ektachrome, Type B	CC15	Satisfactory
CP lamps	3350	Kodachrome, Type A	No filter	Correct
White fluorescent lamps	*	Kodachrome, Type B Kodachrome, Type A Ektachrome, Type B	CC34 and CC95 CC34 CC34 and CC95	Bluish
Photoflash SM lamp	3300	Kodachrome, Type A	No filter †	Satisfactory
3200°K lamps	3200	Kodachrome, Type B Ektachrome, Type B	No filter	Correct
		Kodachrome, Type A	CC4	Correct

\* Discontinuous spectra.

† Or use CC23 for warmer results.

*Note:* A difference of 100°K will be more apparent in the range of tungsten lamps (2900 to 3400°K) than in the range of sunlight and blue sky conditions (6000 to 6500°K).

### *Filters for Kodachrome Photography*

A general description of the several Eastman Kodak filters recommended for use with Kodachrome film follows.

**THE KODACHROME HAZE FILTER (WRATTEN No. 1).** Colorless, absorbs all ultraviolet rays of shorter wave length than  $380\text{ m}\mu$ ; used with daylight-type film to reduce excessive blueness sometimes resulting from making pictures of distant mountains where the blue haze is undesirable, at high altitudes, for outdoor shots on overcast days, or in shade on blue-sky days. When the Type A filter (Wratten No. 85) is used with Type A Kodachrome, a haze filter is not required. As a matter of fact, somewhat better results will be obtained under high altitude, hazy conditions with Type A film plus the Type A filter.

Filter No. 1 (haze filter) gives warmer results than are obtained without the filter. For still warmer pictures, use the Wratten No. 2A filter. In the author's experience, the No. 1 filter has very little effect and the No. 2A filter sometimes makes pictures greenish.

**WRATTEN No. 2A FILTER.** In addition to usage indicated above, this filter is recommended for use with Kodachrome Professional film, Type B, exposed by means of flash lamps, such as Nos. 5, 6, 11, 22, 31, and 50.

Filters Nos. 1 and 2A require no increase in exposure.

**KODACHROME TYPE A FILTER (WRATTEN No. 85).** Used with Type A Kodachrome when exposed under daylight conditions. This filter may fade particularly when exposed to sunlight. See above for use at high altitudes. Salmon in color.

For general outdoor use the daylight type of film is recommended.

**KODACHROME FILTER FOR PHOTOFLOOD (WRATTEN No. 80).** Bluish in color; used with Daylight Type film exposed by photoflood illumination; requires four times as much exposure as Type A film with same lights and does not produce as good color.

**KODACHROME TYPE B FILTER (WRATTEN No. 85B).** Salmon in color; used with Kodachrome Professional or Ektachrome Type B

film in daylight; requires twice the exposure of Daylight Type Professional film and does not give as good color balance.

**KODAK COLOR COMPENSATING FILTERS.** Special-purpose filters made in three concentrations of yellow, magenta, and cyan. Designed to absorb different amounts of the three primary colors—blue, green, and red—they can be used singly or in combinations with themselves or other filters for slight color corrections under unusual light conditions or when heat-absorbing or opal glass is used in an optical system.

<i>Relative Concentration</i>	<i>Yellow (Absorbs Blue)</i>	<i>Magenta (Absorbs Green)</i>	<i>Cyan (Absorbs Red)</i>	<i>Red (Absorbs Blue and Green)</i>	<i>Green (Absorbs Blue and Red)</i>	<i>Blue (Absorbs Red and Green)</i>
$\frac{1}{8}$	CC21	CC31	CC41	—	—	—
$\frac{1}{4}$	CC22	CC32	CC42	CC52	CC62	CC72
$\frac{1}{2}$	CC23	CC33	CC43	CC53	CC63	CC73
1	CC24	CC34	CC44	CC54	CC64	CC74
2	CC25	CC35	CC45	CC55	CC65	CC75
4	CC26	CC36	CC46	CC56	CC66	CC76
8	CC27	CC37	CC47	CC57	CC67	CC77

#### APPLICATIONS OF THE PRIMARY ABSORBING FILTERS

1. To correct for deficiencies in the color of illumination.
2. To produce slight corrections in light sources used in making color-film duplicates. If the duplicates are definitely greenish, one of the pale magenta filters (CC33 or CC34) can be used; if too pink, try the CC43 or CC44, or the CC43 and CC23 combined. Experimentation is the only satisfactory method by which to select the proper filters.
3. To correct an undesirable over-all tint of color in a transparency that is to be duplicated or color-printed.
4. To balance variations in different batches of plates and films used in one-shot color cameras instead of combining neutral density filters with the tricolor filters inside the camera. The same result may sometimes be achieved more easily by using CC filters over the camera lens. The palest filters are equivalent to about 0.07 neutral density over the complementary tricolor filters; the medium filters are equivalent to

about 0.15 neutral density; the deepest filters to about 0.3 neutral density.

5. In submarine photography with color film, the magenta and yellow filters can be used to compensate the strong red absorption of sea water. The color of the water varies with location and depth, so that no specific recommendations can be made.

6. With miniature transparencies that show over-all tints of color in viewing or projection, pieces of the gelatin filters can be mounted in glass slides with the transparencies to modify the color balance.

### *Color Temperature Conversion Filters*

Seven color compensating filters are supplied by Eastman Kodak to enable the photographer to adjust the color quality of the illumination to the correct value for proper color rendering.

Blue filters to raise effective color temperature	$\left\{ \begin{array}{ll} \text{CC3} & \text{light} \\ \text{CC4} & \text{medium} \\ \text{CC5} & \\ \text{CC6} & \text{dark} \end{array} \right.$	$\left. \begin{array}{ll} \text{CC13} \\ \text{CC14} \\ \text{CC15} \end{array} \right\}$	Yellow filters to lower effective color temperature

The CC3, CC4, and CC13 filters absorb so little light that no increase in exposure is necessary. The CC5 and CC14 filters require  $\frac{1}{4}$  to  $\frac{1}{2}$  stop more exposure than is indicated by an exposure meter; the CC6 and CC15 filters require  $\frac{1}{2}$  to  $\frac{3}{4}$  stop more.

Kodak Pola-Screens are used to darken blue skies and to subdue nonmetallic reflections; they require one stop greater than normal exposure.

The following recapitulation of the several Eastman Kodak filter-film combinations will serve as a convenient table for reference purposes.

#### KODACHROME—35-MM DAYLIGHT TYPE

<i>Filters</i>	<i>Purpose</i>
Kodachrome filter for photoflood	Permits use of this film in photoflood light
Kodachrome haze filter, Wratten No. 1	Absorbs ultraviolet, reducing distant haze
Kodak CC14 and CC15	Better correction than obtainable with haze filter
Kodak CC33	For use with daylight fluorescent lamps
Kodak CC23	White-flame carbon arc lamps

## KODACHROME—35-MM TYPE A

<i>Filters</i>	<i>To Permit Exposure By</i>
Type A (Wratten No. 85) filter for daylight	Daylight
Kodak CC15	Wire-filled or shredded-foil photoflash lamps
Kodak CC4	3200°K lamps
Kodak CC34	White fluorescent lamps
Wratten No. 78B	Ordinary tungsten home-lighting lamps

## KODACHROME, EKTACHROME SHEET FILM, DAYLIGHT TYPE

<i>Filter</i>	<i>Purpose</i>
Wratten Nos. 1, 2A	These filters are used to avoid the bluish cast that is otherwise evident in (a) pictures taken on an overcast day, (b) pictures taken in shade under a clear blue sky, and (c) distant scenes, mountain views, etc. Color rendering in daylight becomes warmer with the No. 1 filter, still warmer with the No. 2A. CC14 and CC15 are preferred for these purposes
Kodak CC15	For use with Kodatron Flashtube FT-402
Kodak CC33	Compensating filter for daylight fluorescent lamps, for slightly warmer results than are obtained with no filter
Kodak CC23	Compensating filter for white-flame carbon arc lamps

## KODACHROME, EKTACHROME SHEET FILM, TYPE B

<i>Filter</i>	<i>Purpose</i>
Kodak CC15	Photoflood lamps
Wratten No. 2A	Recommended for use with wire-filled and shredded-foil photoflash lamps (CC95 for Ektachrome)
Kodak CC34 plus CC95	Compensating filter combination for white fluorescent lamps

*Anso Filters for Color Photography*

Anso color filters currently available fall into three groups.

1. *Ultraviolet absorbing filters*, primarily designed for haze correction in photographing distant landscapes and seascapes and at high altitudes. Since they absorb at the blue end of the spectrum,

they may be employed for minor color correction or change in color balance.

2. *Conversion filters*, making it possible to use Tungsten Type Ansco color film with light sources differing in color temperature from the 3200°K for which this film is balanced.

3. *Color compensating filters*, for minor changes in color balance—for example, in photomicrography, where the standard light source may not yield transparencies of the desired color balance—and in making color prints on Ansco Color Printon and Ansco color paper.

#### ANSCO COLOR FILTER USAGE

<i>Filter</i>	<i>Use</i>
Ultraviolet	
UV-15	<ol style="list-style-type: none"> <li>1. Slight haze correction</li> <li>2. When exposing Tungsten Type Ansco color film by photoflood light</li> </ol>
UV-16	<ol style="list-style-type: none"> <li>1. Normal haze correction</li> <li>2. When exposing Ansco color film, Tungsten Type by clear flash-lamp illumination</li> <li>3. With Ansco Printon and Ansco Color Paper</li> </ol>
UV-17	<ol style="list-style-type: none"> <li>1. For greater haze correction</li> </ol>
Conversion Series	
No. 10	<ol style="list-style-type: none"> <li>1. Exposing Daylight Type Ansco color film under 3200°K illumination: give 4 times exposure that Tungsten Type film would require under identical conditions</li> </ol>
No. 11	<ol style="list-style-type: none"> <li>1. Exposing Tungsten Type film to daylight: give 1.5 times exposure that daylight film would require under identical conditions</li> </ol>
No. 12	<ol style="list-style-type: none"> <li>1. Exposing Tungsten Type film to high-speed gaseous discharge lamps</li> </ol>



## BLACK-AND-WHITE PRINTS FROM COLOR TRANSPARENCIES

Color transparencies are really small scenes brought home in natural color and in proper proportions. It is a very simple matter, therefore, to make good black-and-white prints from these transparencies by means of an intermediate negative. The transparency is a positive, and to print a positive on paper, a negative must be made.

All that is necessary is to print, by contact or by projection, the transparency onto some negative material and to use the developed negative for the printing process just as any other negative is used. Since the transparency is in color, it is advisable, although not necessary, to use panchromatic material for the negatives. In fact, prints may be made from one of the separation negatives made from the transparency for color printing.

If the printing negative is to be the same size as the original transparency, contact printing should be used. Same-size negatives can then be placed in the enlarger and the final black-and-white prints can be made by projection. In contact printing all that is necessary is to place the transparency in a printing frame and, on top of this, to place the panchromatic film. Close the printing frame. Place it at the proper distance from a source of light and expose. Then develop and fix it in the same way you would handle any black-and-white miniature film.

If negatives larger than contact size are to be made, the enlarger can be used. Place a sheet of white paper on the easel and focus the image on this. Then in darkness, substitute film for the sheet of white paper and expose for the required length of time.

The amateur must determine for himself the required printing exposures. The following data, however, will give him a good start. If Kodak Panatomic-X film is used, a contact negative will require about 3 seconds' exposure to a bare 15-watt lamp 3 feet distant. Using the Kodak Precision enlarger, a 3-diameter enlargement will

require an exposure of about 6 seconds at  $f/16$  on Panatomic-X sheet film or about 3 seconds using Kodak Plus-X film pack.

Since color transparencies have high contrast, the films on which the negatives are made should be developed a shorter time than is customary. Thus Panatomic-X and Plus-X films should be developed in D-76 for about 5 minutes in a tray or 7 minutes in a tank.

Film packs provide a convenient method for making negatives of transparencies by projection, minimizing the danger of finger marks. An opaque mask the same size as the top of the film pack should be made by mounting a sheet of white paper on a sheet of black opaque paper. On the white paper mark in ink the exact size and position of the opening of the film pack. Some means of holding the pack tightly to the easel should be arranged and care must be taken that the mask does not leak light while focusing takes place. Focus on the white mask, turn out lights, remove mask, make exposure on film pack, pull tab, replace mask, and place new transparency in the negative carrier of the enlarger. By such a method a number of negatives can be made very quickly.

Another method of making a number of printing negatives from 35-mm transparencies is to mount the individual frames of color on the glass of a 5 by 7 or 8 by 10 printing frame and to expose the whole batch at one time to a sheet of film of the correct size. This can be developed as a unit after which the individual negatives can be cut apart. If the transparencies are chosen so that they have about the same high-light densities (minimum density) and sufficient exposure is given so that the negative high-light density is well up on the straight part of the negative emulsion curve—say a density of 1.6 or higher—then details in the shadows of the transparencies will appear in the negatives. The high inherent contrast of color transparencies can be reduced if desired by masking them as described later.

One word about the orientation of the transparency with respect to the negative material will not be amiss. If the emulsion sides of

the transparency and negative emulsion are face to face, the picture will be reversed on the negative from what would be the situation if the negative were made in the camera in the normal manner. To make a black-and-white print with proper orientation will require that the negative be placed in the enlarger with the emulsion side away from the paper and toward the light source. This will cause no difficulty; but in making the contact prints sharper images will result if the negative and paper can be placed emulsion to emulsion. The thing to remember is that if the image on the negative is to be reversed left to right, as it would be when made in a camera, then in making the negative by contact or by projection the two emulsions must face the same way, not face to face.

There is nothing to prevent the use of filters when making contact or enlarged negatives from transparency positives. They can be used for the same purpose they are used for out of doors on the original location. Thus a yellow filter can be used to bring out clouds better; or the three tricolor filters can be used to make separation negatives as outlined later. If projection is employed to make the negatives, the filters can be placed over the lens of the enlarger or they can be placed next to the glass of the printing frame; then comes the transparency and finally the negative material. Filters can be used for enhancing color contrasts, as in making black-and-white pictures in the normal manner. Similarly, the use of pan film with a Wratten X2 filter will improve flesh tones. The normal increase in exposure must be employed to take account of the light absorption of the filter.

### BLACK-AND-WHITE PRINTS BY REVERSAL

In *Defender News*, Autumn, 1947, a few notes will be found indicating that Defender Velour Black and Varigam enlarging paper can be used for making prints from color transparencies by the reversal technique. In this process the paper is exposed to the transparency, developed in a high-energy developer, bleached, cleared,

exposed again to white light, and redeveloped, whereupon a black-and-white image results. No formulas are given, and the experimenter will have to work out his own system. The notes indicate, however, that the effective contrast of Velour Black is reduced in this method so that the high-density ranges of transparencies can be handled effectively, that approximately three times normal exposure is required when using Velour Black, that Varigam reverses well without filters but not with filters, that the second development can be carried out by the use of Defender 53-D diluted 1:2, and that the exposure to white light can be eliminated by use of a second developer made up of sodium hydrosulfite.

### VOLTAGE CONTROL IN COLOR PHOTOGRAPHY

It was mentioned above that the voltage at which a tungsten lamp operates determines its color temperature and that variations in voltage produce variations in color output. In the January-February, 1946, issue of *The Ansconian* there is some discussion of this problem. Tests were made on Ansco color film balanced for 3200°K and designed for 115 volts but actually burning at 95 or 125 volts. The 95-volt transparencies were on the warm or reddish side and the 125-volt transparencies were on the cold or bluish side when the individual films were directly compared, but each transparency was considered as satisfactory when viewed alone.

It must be remembered, however, that a change in voltage produces not only a change in color content of the illumination but a change in intensity as well, the actual light output varying as the square of the voltage. As a general guide, a shift of 20 volts requires  $\frac{1}{2}$ -stop change in exposure. Test exposures under the photographer's own conditions must be employed to determine correct voltages. Then one must assume that these voltage conditions will obtain at all times.

Rapid variations in voltage are more important than a voltage higher or lower than normal. Such variations may be caused by

sudden heavy loads thrown on the lighting circuit causing sudden drops in voltage. If the lights blink when the refrigerator comes on or when an electric iron goes on or off, the photographer had better get a separate circuit for his lights or choose a time for working when domestic activities are at a minimum. This point is important when separation negatives are made and when prints from such negatives are made.

### ADDITIONAL NOTES ON KODACHROME

Several bulletins have been published by Eastman Kodak that should prove helpful to photographers having special interests or problems. For example, many amateurs, and professionals, too, have occasion to make microscope slides in color. "Kodachrome Photomicrography of Stained Slides," by R. P. Loveland of the Kodak Research Laboratories, was originally published in the *Journal of the Biological Photographic Association* and is available in reprint from Eastman Kodak.

Several articles have appeared in the photographic literature on methods of duplicating transparencies on other transparency material, but this is a rather technical problem and the photographer had best get advice from the manufacturer of the material he proposes to use before he starts his work. One article on this subject that appears to have considerable merit is that of Morris Colman published in *Photo Technique*, October, 1941.

### EXPOSURES FOR CLOSE-UPS

When one photographs objects fairly close to the lens, the exposure must be greater than indicated by an exposure meter. In fact, if one photographs an object so that it is as large on the film as it really is ("same size") the exposure must be 4 times that indicated by the meter; if it is photographed one-half its natural size, the normal exposure must be increased  $2\frac{1}{4}$  times. This is a most important matter when exposing color film.

The table on page 100 indicates not only the multiplying factor for the exposure when the object is at certain distances from lenses of certain focal lengths, but it indicates what this distance must be to produce an image bearing a certain relation to the size of the

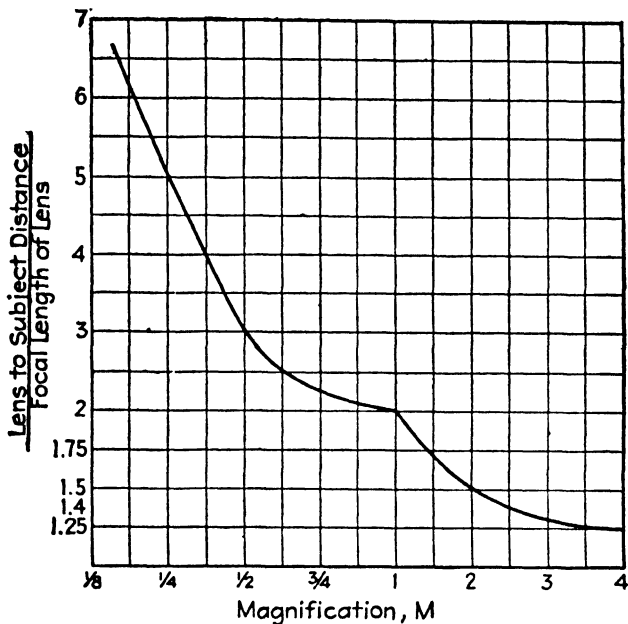

If a picture is to be made same size as the original, the distance between the camera lens and the subject must be twice the focal length of the lens. The lens-to-subject distance for other degrees of magnification may be found from this curve.

actual object. The table must be used to indicate reductions or magnifications.

Suppose, for example, that one is to make a 4- by 5-inch negative and that in the finished 8 by 10 print the image is to be the same size as the original. How far must a 6-inch lens be from the subject matter? Since the 8 by 10 print represents an enlargement of 2 times, the image on the ground glass must be half the size of the

FOCAL LENGTH OF

$s$	3	3½	4½	4¾	5	5½	5¾	6	6½	6¾	7½
-----	---	----	----	----	---	----	----	---	----	----	----

$$\text{Lens - Object Distance in Inches } (D) = \frac{f}{m} + f$$

26	39	45 ½	53 ¾	61 ¾	65	68 ½	71 ½	78	81 ½	82 ¾	84 ½
14	21	24 ½	28 ¾	33 ¾	35	36 ¾	38 ½	42	43 ¾	44 ¾	45 ½
10	15	17 ½	20 ¾	23 ½	25	26 ½	27 ½	30	31 ½	31 ¾	32 ½
8	12	14	16 ½	19	20	21	22	24	25	25 ½	26
6½ <sub>0</sub>	10½ <sub>0</sub>	11 ½	14	16 ½	17	17½ <sub>0</sub>	18½ <sub>0</sub>	20½ <sub>0</sub>	21 ½	21 ¾	22 ½ <sub>0</sub>
6	9	10 ½	12 ¾	14 ¾	15	15 ¾	16 ½	18	18 ¾	19 ½	19 ¾
5	8½ <sub>0</sub>	9 ¾	11 ¾	13	13 ¾	14 ¾	15	16¾	17 ½	17 ¾	17 ¾
5 ½ <sub>0</sub>	7½	8 ¾	10 ¾	11 ¾	12 ½	13 ½	13 ¾	15	15 ¾	15½ <sub>0</sub>	16 ¾
4½ <sub>0</sub>	7	8 ¾	9 ¾	11 ¾	11½ <sub>0</sub>	12 ½	12½ <sub>0</sub>	14	14 ¾	14 ¾	15 ¾
4 ¾	6¾	7½ <sub>0</sub>	9 ¾	10 ¾	11	11 ¾	12 ½	13½ <sub>0</sub>	13 ¾	14 ½	14 ¾ <sub>0</sub>
4 ¾ <sub>0</sub>	6½	7 ¾	8 ¾	9½ <sub>0</sub>	10 ¾	11	11 ½	12½ <sub>0</sub>	13 ¾	13 ¾	13 ¾
4	6	7	8 ¾	9 ¾	10	10 ½	11	12	12 ½	12 ¾	13
3 ¾ <sub>0</sub>	5	5½ <sub>0</sub>	6 ¾	7½ <sub>0</sub>	8 ¾	8 ¾	9 ¾	10	10 ¾	10 ¾	10½ <sub>0</sub>
3	4½	5 ¾	6 ¾	7 ¾	7 ½	7 ¾	8 ¾	9	9 ¾	9 ¾	9 ¾
2½ <sub>0</sub>	4½ <sub>0</sub>	4 ¾	5½ <sub>0</sub>	6 ¾	7	7 ¾	7½ <sub>0</sub>	8¾	8 ¾	8½ <sub>0</sub>	9 ¾
2½ <sub>0</sub>	4	4½ <sub>0</sub>	5 ¾	6 ¾	6½ <sub>0</sub>	7	7 ¾	8	8 ¾	8 ½	8½ <sub>0</sub>
2 ¾ <sub>0</sub>	3¾	4 ¾	5 ¾	6 ¾	6 ¾	6 ¾	7 ¾	7¾	8 ¾	8 ¾	8 ¾
2 ½	3¾	4 ¾	5 ¾	5 ¾	6 ¾	6 ¾	6 ¾	7½	7½ <sub>0</sub>	8	8 ¾

original subject. With the 6-inch lens, therefore, the subject must be 18 inches from the lens. The exposure will be 2¼ times that indicated on the exposure meter.

These exposure multiplying factors are very important, since accurate exposure is most necessary in all color work.

From this table may be found the lens-to-subject distance necessary to produce an image bearing a desired relation in size to that of the subject. Expressed in terms of the focal length of the lens, the table is as follows:

LENS IN INCHES (*f*)

7	7½	8¼	8½	9¼	10	10¾	11	11¾	12	Magnification on Ground Glass ( <i>M</i> )	Exposure Multiplier Factor $E = (1 + M)^2$
---	----	----	----	----	----	-----	----	-----	----	--	--

Lens - Object Distance in Inches (*D*) =  $\frac{f}{m} + f$

91	97 ¼	107 ¼	110 ¼	123 ¼	130	136 ¼	156	182	¼	1.17
49	52 ¼	57 ¼	59 ¼	66 ¼	70	73 ¼	84	98	½	1.36
35	37 ¼	41 ¼	42 ¼	47 ¼	50	52 ¼	60	70	¾	1.56
28	30	33	34	38	40	42	48	56	1	1.78
23 ½	25 ¼	28 ¼	28 ¼	32 ½	34	35 ¼	40 ½	47 ½	1 ¼	2.01
21	22 ¼	24 ¼	25 ¼	28 ½	30	31 ¼	36	42	1 ½	2.25
19 ¼	20 ¼	22 ¼	23 ¼	25 ½	27 ½	28 ½	32 ¼	38 ¼	1 ¾	2.51
17 ¼	18 ¼	20 ¼	21 ¼	23 ¼	25	26 ¼	30	35	2	2.78
16 ¼	17 ¼	19 ¼	19 ¼	22 ¼	26 ¼	24 ¼	28	32 ½	2 ¼	3.06
15 ¼	16 ¼	18 ¼	18 ¼	20 ¼	22	25 ¼	26 ¼	30 ½	2 ½	3.36
14 ¼	15 ¼	17 ¼	17 ¼	19 ¼	20 ¼	22	25 ¼	29 ¼	2 ¾	3.68
14	15	16 ¼	17	19	20	21	24	28	3	4.00
11 ¼	12 ¼	13 ¼	14 ¼	15 ¼	16 ¼	17 ¼	20	23 ¼	3 ¼	6.25
10 ¼	11 ¼	12 ¼	12 ¼	14 ¼	15	15 ¼	18	21	4	9.00
9 ¼	10 ¼	11 ¼	11 ¼	13 ¼	14	14 ¼	16 ¼	19 ¼	5	12.25
9 ¼	10	11	11 ¼	12 ¼	13 ¼	14	16	18 ¼	6	16.00
9	9 ¼	10 ¼	10 ¼	12 ¼	12 ¼	13 ¼	15 ¼	18	7	20.25
8 ¼	9 ¼	10 ¼	10 ¼	11 ¼	12 ¼	13 ¼	15	17 ¼	8	25.00

Image Size

Subject Size

- ¼
- ½
- ¾
- 1
- 1 ¼
- 1 ½
- 2
- 1 (same size)
- 2
- 3
- 4

Lens-to-Subject Distance

Focal Length of Lens

- 7
- 5
- 4
- 3
- 2 ½
- 2 ¼ (approx)
- 2
- 1 ½
- 1 ¼
- 1 ¼



Thus, to make a picture one-half natural size with a 4-inch lens requires that the lens be  $3 \times 4$ , or 12, inches from the subject. The average camera equipped with a 4-inch lens probably does not have a bellows of sufficient length to make it possible to focus an image one-half size, but the principle is good nevertheless. As the lens gets closer to the subject for close-ups, the lens-film distance increases.

### HOW COLOR FILM WORKS

The idea must have occurred to many people that, if three films were exposed, one beneath the other, with each film sensitive only to one-third of the spectrum—say one sensitive to red and the others to blue and green, respectively—a three-color picture might be made at a single shot. In effect, this is what Kodachrome, Ektachrome, and Ansco color films have accomplished. While the following description applies specifically to Kodachrome film, it is general enough to apply to other color films.

The film is made up of a base that is noninflammable, on which are three sensitive emulsions separated by layers of gelatin. The outermost layer is sensitive to blue, the middle layer to green, and the emulsion nearest the support is sensitive to red. Between the first and second layer—i.e., between the blue-sensitive and the green-sensitive emulsions—is a yellow filter. This filter prevents blue light from getting through to the green-sensitive and red-sensitive layers, which are sensitive to blue light in addition to the colors that they are supposed to record. These layers, with the gelatin and the yellow filter between, make up so thin that the total thickness is only a little more than that of ordinary film.

The top emulsion is sensitive to blue only. The middle layer is sensitive to green and blue, but no blue reaches this emulsion because of the yellow filter. Green and red light pass through the first layer (but do not affect it) and through the yellow filter. The middle layer is exposed by the green light but not by the red and not by the blue. The innermost layer is red- and blue-sensitive but

no blue reaches it, and whatever green light reaches it does not expose it because it is not sensitive to green.

### *Formation of Images on Kodachrome Film*

After exposure, all three emulsions are developed to negatives. The film is then exposed through the base to red light, which makes developable the previously unexposed silver bromide in the bottom layer; this is developed with a cyan "coupler developer." (A coupler developer differs from ordinary developers in that, while converting exposed silver bromide to metallic silver, it also deposits a dye of predetermined color.) Next, the top side of the film is exposed to blue light and developed with a yellow coupler. At this point, all the silver bromide is exhausted except that corresponding to the positive image in the middle layer, and this is developed with a magenta coupler. The film now contains three positive images in appropriate colors plus all of the silver bromide converted into silver by the two developing operations that each layer has undergone. Finally, the silver is removed from all three layers, and the film is fixed, washed, and dried. A positive dye image remains in each layer, and its color is complementary to the color to which its emulsion layer was originally sensitive.

When the transparency is projected on a screen, the following is the mechanism by which the original colors appear. White light (on the screen) is secured by the unobstructed passage of light from the projector lamp to the screen. Red light results when a ray of white light is filtered by successive layers of magenta and yellow dye. The magenta layer absorbs green, leaving only blue and red. The yellow layer in turn absorbs blue, leaving only red. To secure green light, the blue-green layer absorbs red, leaving green and blue. The yellow layer then absorbs blue, and green light proceeds to the screen. For blue light, the blue-green layer again subtracts red, leaving blue and green. The magenta layer then takes out the green, leaving only blue. Intermediate colors

and mixtures are secured by partial absorptions at each layer. Heavy dye deposits in all three layers subtract light of all colors, resulting in a black screen image.

### Kodachrome vs. Ansco or Ektachrome Film Color Processing

Ansco and Ektachrome color film are, like Kodachrome, three-emulsion films. They are exposed in exactly the same way as Kodachrome and, as far as the photographer is concerned, differ only in the method by which they are processed. As explained above, Kodachrome is first developed to a negative, all three emulsion layers in exact register because they were all exposed at one time and the individual layers have not been separated. Now there remains in the film the silver bromide that was not exposed when the picture was taken. In black-and-white photography, this silver bromide is disposed of by the use of the "fixer"—i.e., hypo. In processing Kodachrome, however, what is wanted is not a negative but a positive, and since the unexposed silver bromide represents portions of the original scene where there was no light or color, this silver bromide can be developed to a "positive" image representing exactly the original scene. This positive can be projected on a screen. If black-and-white film is employed to make a monochrome for projection, two possible processes are available. An ordinary negative is made and from this negative a print is made on film. This print is a positive in that its darkest portions correspond to the lightest portions of the negative. If, however, the film exposed in the camera is first processed to a negative and then if the silver resulting from this processing is gotten rid of, the unexposed silver bromide in the film remains. Exposure to light renders this silver bromide developable. After processing, the film is a positive and can be used for projection.

All present-day color films are processed in this manner. In the Kodachrome film the unexposed silver bromide, existing in the

three emulsions, is exposed, one layer at a time, and is developed in such a manner that the image exists in the form of a dye rather than in the form of silver. This is accomplished by introducing into the developer certain chemicals that produce the dye deposit. Thus with Kodachrome film there is a first exposure made by the photographer. Then there is a first development, which converts all three layers to a negative. Then there are three more exposures and developments.

AnSCO and Ektachrome color films are exposed exactly like Kodachrome film and are first developed to a negative. Then the film is exposed to white light and is developed again. In the film, however, the manufacturer has placed the chemicals that produce the colored dyes upon development. These dyes are not in the developer, as in Kodachrome, but in the film emulsions themselves.

Since Kodachrome must be processed with great care as to time and temperature and since the three individual exposures that produce the final colored images must be made to light of definite characteristics, the manufacturer has not felt that the average photographer could process his own films with sufficient success to encourage home processing by making available the formulas or materials. It must not be thought, however, that this statement indicates that the photographer can process his AnSCO or Ektachrome color film with the lack of care he exercises with his black-and-white films. If the colors are to be correct, the photographer must observe with great care the instructions issued by the manufacturer.

### PROCESSING ANSCO COLOR FILM

Introduction of AnSCO color film brought to the photographer a color material that he could process himself. Thus he could see the results of his labors in a few hours. In 1946 Eastman Kodak added its own home-processed color film, Ektachrome. The manufacturers provide developing kits of various sizes; complete formu-

las for Ansco are also available so that the photographer can compound his own processing solutions. The following notes are taken from the several publications from Ansco laboratories, chiefly in *The Ansonian* for 1944–1946. Since the film was made available, some simplification has been effected in the processing and the photographer will be wise to keep in touch with dealers to make sure that he receives latest data on processing procedures.

The procedure is not difficult and the chief difference between handling Ansco color film and developing black-and-white negative materials is that careful attention to such details as agitation, times of treatment, and temperature is more necessary in color work. The various steps in processing the film are outlined briefly below, together with the time required for each step.

#### TIME REQUIRED FOR EACH PROCESSING STEP

<i>Step</i>	<i>Time in Minutes</i>	<i>Step</i>	<i>Time in Minutes</i>
1. First development No. 502	14	7. Shortstop No. 858	1
2. Shortstop No. 858	1	8. Hardener No. 901	4
3. Hardener No. 901	4	9. Wash	5
4. Wash	3	10. Bleach No. 709	8 to 10
5. Second exposure	3	11. Wash	3
6. Color development No. 605	16	12. Fixer No. 800	4
		13. Wash	10
		14. Dry	

The purpose of the several processes is as follows:

1. First developer produces a black-and-white negative.
2. Shortstop neutralizes developer solution.
3. Hardener hardens emulsion.
4. Wash gets rid of developer and hardener.
5. Second exposure prepares residual silver halide for color development.
6. Color development forms positive image in silver and dyes.
7. Shortstop neutralizes developer solution.

8. Hardener again hardens emulsion softened during color development.

9. Wash gets rid of developer and hardener solution.

10. Bleach converts positive and negative silver images to silver bromide.

11. Wash removes bleach solution.

12. Fixer dissolves negative and positive silver-bromide images leaving positive dye image.

13. Wash removes fixer.

Equipment required for processing Ansco color film is essentially the same as that needed for black-and-white development. The chief difference is the fact that several more tanks, trays, or other containers are necessary. Where many films are to be processed, tank development is preferable to tray development, and the instructions concerning agitation and times of treatment in the instruction sheet are based on tank processing. Stainless steel or plastic hangers suitable for black-and-white work are also satisfactory for Ansco color film. Tanks and trays can be made of any photographically inert material, such as glass, enamelware, or hard rubber. Stainless steel presents no problem, provided the bleach bath is not stored in the metal container when not in use. Glass battery jars, incidentally, make excellent tanks for color-film processing.

Since temperature control is important, the use of a large tank, tray, or sink as a water bath to hold all the smaller tanks of processing solutions is advisable.

Under adverse conditions, where Ansco color film must be processed with very soft water or where it is extremely difficult to control wash water and solution temperatures, precautions must be taken to avoid trouble. There are several expedients that can be adopted. In the first place, the wash-water temperature must definitely be kept at 70°F or below, and it is advisable to check the thermometer used to measure this temperature. Frequently, uncalibrated photographic thermometers give readings erroneous by as

much as 2 or 3°. One method of cooling the wash water is to let it run over a block of ice before it comes into contact with the film. Another method is to substitute for tank washing in running water successive washings of 1 minute each in trays of cooled water. For this purpose, a 1-minute tray wash with a complete change of water and constant agitation can be considered equivalent to roughly 1½ to 2 minutes, tank-washing time.

Further permissible alterations in the recommended processing technique include reducing the second exposure to one minute, with a 30-second exposure on each side rather than the 1½ minutes specified in the instructions. There is a possibility of this giving inadequate second exposure; if so, tests should be carried out to discover the satisfactory minimum under the operator's own working conditions. The wash in step number 9 can be reduced from 5 to 3 minutes if there is a good flow of water, and the wash in step number 11 can be reduced to 1 minute under the same conditions of water flow. Adequate washing is essential for clear colorless clouds, for example, and only under bad conditions of temperature or soft water should these expedients be employed. A test in one's own darkroom may disclose that warmer or softer water may cause no trouble—but try to do as the manufacturer advises.

These expedients should not be adopted as standard practice since they present certain dangers, such as staining of the final transparency. However, in an emergency, they may make the difference between a successful and an unsuccessful result. If all such measures fail, the film should be carried through first development, 3 minutes in the shortstop (no hardener), and a wash 5 to 10 minutes. It should then be dried before being given the second exposure. The drying renders the gelatin somewhat more resistant to subsequent swelling and will probably make it possible to complete the processing without further difficulty.

The Ansco color process offers opportunities for varying the procedure for special purposes. It is possible, as pointed out above,

to develop the film in the first developer, treat it in the shortstop bath, wash it for 5 to 10 minutes, and then dry it. The dried films can be shipped to some other location for the completion of the processing or they can be stored indefinitely. The only precautions necessary, other than protection against actual physical damage, are to see that the film is not exposed to direct sunlight or strong daylight over a period of time. When it is desired to finish the transparencies, they are given normal second exposure and the processing is carried out as though it had not been interrupted.

After some experience in handling Ansco color film, the dark-room operator can judge, when the films are removed from the shortstop bath, the correctness of the exposure given to the film. This allows a rapid check on the exposure under circumstances where it might be possible to remake the photographs if errors could be known within 20 minutes to  $\frac{1}{2}$  hour. In a properly processed film at this point the deepest shadows are very light, the picture areas that will make shadows are very light, and the picture areas that will make up the middle and high-light tones are black.

Ansco color film is a reversible material, and anyone familiar with the photographic characteristics of this type of film would expect that variations in the time of first development would bring about changes in the effective emulsion speed. In fact, this is true, and in an emergency where added film speed is urgently needed, an increase in the time of first development will provide up to  $1\frac{1}{2}$  lens stops or more additional speed. Since tungsten-type Ansco color sheet film, for example, has a recommended Weston meter setting of 8, this means that satisfactory pictures can be obtained if the exposure corresponds to a Weston meter setting of 20.

Naturally, in a material as complex as Ansco color film, with its three separate emulsion layers all balanced in both speed and gradation, a variation in developing time upsets the relationship between the three layers to some extent. It also increases the contrast and reduces the maximum density of the final transparency.



However, the slightly bluish results obtained are, in many instances, a small sacrifice to make for the added film speed. If the transparencies are subsequently to be printed, the over-all coldness can be corrected at that time.

### *Processing Instructions*

One word of caution is necessary to those who intend to mix their own formulas from bulk chemicals. The purity of the ingredients in color-processing solutions is much more critical than in ordinary black-and-white development. Photographic testing, at least of some of the chemicals, is almost a necessity, and for this reason photographers are strongly urged to use tested chemicals.

The photographer should bear in mind that with color film he is working not with one emulsion but with three emulsion layers. It is necessary that these layers develop simultaneously to give the same effective emulsion speeds and the same shaped characteristic curve or else improper color balance will result.

Errors in weighing or improper changes in the constitution of any one of the developing solutions may disturb the relationship between the speed or contrast of the emulsion layers and upset the color balance.

The individual formulas are given in a complete table later. The following notes apply to the several solutions.

**FIRST DEVELOPER No. 502.** Variations of the metol and hydroquinone concentrations may be made to permit slight increases or decreases in development times, but only moderate variations are possible before color differences become noticeable. The metol to hydroquinone ratio may also be changed to obtain slightly softer or steeper gradation; but in attempting to soften the gradation by increasing the metol, care must be taken to retain sufficient hydroquinone in the formula, for high concentrations of metol alone will not give sufficient density to insure clear high lights.

No. 502 developer also contains sodium thiocyanate, which gives added developing potential and at the same time dissolves out the more insensitive smaller grains of silver halide that do not ordinarily develop. Because of this solvent action, the concentration of sodium thiocyanate is relatively critical. Too much will dissolve out more of the silver halide than is desired, while too little will fail to clear the high lights. Because the yellow layer is on top, where the developer solution acts on it directly, changes of thiocyanate concentration are particularly noticeable as differences in the amount of yellow in the finished transparency. Deviations of as little as 0.1 gram per liter produce noticeable changes.

Sodium sulfite serves the function of a preservative exactly as in black-and-white developers, but with color film it also serves to insure clear high lights by exerting slight solvent action on the silver halides, particularly in the yellow layer. Considerable increases or decreases of sulfite will not affect the keeping qualities appreciably but will affect color balance by changes in solvent action.

Another function of sodium sulfite in the first developer is to prevent any coupling between the oxidation products of metol and hydroquinone and the color components incorporated in the layers. If such coupling should occur, undesirable stains would result.

Moderate changes of sodium carbonate in the first developer have only slight effects on developer characteristics. Increases or decreases of 10 per cent will slightly lower or raise developing times but will not harm color balance.

As in black-and-white developers, potassium bromide is used as a restrainer to prevent excessive fog and to minimize the shifts of developer characteristics as the developer accumulates additional bromide through use.

Whenever hard water is used to mix the No. 502 or No. 605 developer formulas, considerable sludging or cloudiness will result

unless a water-softening agent is used. The addition of 0.5 to 1 gram per liter of Calgon\* (sodium hexameta-phosphate) to the water used to mix the No. 502 developer and of 1 to 2 grams per liter to the water of the No. 605 developer will prevent this cloudiness. The exact concentration is not critical since the developing properties are not affected.

No. 502 first developer is retained with the new process (January, 1947) but with two minutes' increase in developing time to compensate for the slight loss of emulsion speed caused by the hardening step that follows prior to color development.

SHORTSTOP No. 858. The exhaustion capacity of formula No. 851 is four 8- by 10-inch sheets of film paper per liter when the recommended procedure of carrying the film directly from the developer to the shortstop is followed and when the solution is used twice.

This formula serves to neutralize the developer and to stop developing action. It also prevents the carrying of sodium carbonate into the hardening solution, where it might produce a scum of chromium hydroxide. Sufficient acetic acid is provided in the No. 858 formula to make the shortstop quickly neutralize all carbonate carried over by the film from both the first developer and the color developer, even without an intermediate rinse, but it is advisable to drain the film of developer for at least 10 seconds before shortstopping to prevent excessive contamination of the solution.

The sodium acetate in the No. 858 formula reduces the acidity of the acid and prevents rapid neutralization of the carbonate with formation of gas bubbles that might blister the emulsion. When fresh, the shortstop has a pH of about 4.7. It should be discarded when a pH of 5.5 is reached. This is equivalent to exhaustion by about 400 square inches of first-developed and color-developed film per liter. Compounding of the shortstop chemicals is not critical and may vary 10 per cent from normal without harm.

\* Calgon, Inc., Pittsburgh, Pa.

After the shortstopping process, the film should be placed in No. 901 chrome alum hardener. This is to harden the gelatin layers to prevent softening during the succeeding washing and second exposure steps. The concentration of chrome alum is not critical. In fact, 20 grams per liter or 40 grams per liter will be okay.

The hardener solution must be freshly made up for best results. When in solution, potassium chrome alum undergoes a chemical reaction known as "hydrolysis," which results in a chemical breakdown of the compound, forming a more acid solution. As the solution becomes more acidic, its hardening ability deteriorates. When cold-water washes are used, this loss of hardening is not dangerous as the film does not require highest hardening; but for use where wash-water temperatures rise to 75°F or above, maximum hardening is required.

Chrome alum solutions vary greatly in their rate of deterioration. For this reason, it is recommended that for extreme conditions, where warm, and perhaps soft, water is encountered, fresh chrome alum solution should be changed weekly. It should never be left longer than two weeks, or trouble may result. Under no circumstances should chrome alum solutions that are greenish in hue be used. A chrome alum hardener may be overage and of doubtful hardening ability when the color remains the original purple, but if green it most certainly will not harden well.

**DRYING FILM BEFORE COLOR DEVELOPMENT.** If it is desired that the film be dried prior to color development and the remaining processing steps be completed later, the hardening bath No. 901 should not be used. Instead, the time in shortstop No. 858 should be increased to 3 minutes, after which the film should be washed for 5 to 10 minutes in cool running water. If the film is hardened, then dried prior to color development, it will show a loss of yellow density resulting in bluish transparencies.

After hardening, the film should be washed for 3 minutes in water not over 80°F. The wash can be extended if desired, for the

film is now quite resistant to reticulation or softening. The second exposure can be given while the film is in the wash water or after its removal, but in any event each piece of film should get an exposure equivalent to at least  $1\frac{1}{2}$  minutes on each side from a No. 2 photoflood not over 3 feet away. Move the lamp or the film during second exposure so that the light gets under the edges of the developing hanger and exposes the film margins. Improper second exposure will give transparencies lacking in cyan or magenta. Roll films, except 35-mm film on open wire reels, should be removed from the developing reels for second exposure.

No. 605 color-developer solution is basically the same as No. 602 color developer used previously with the exception of reduced potassium-bromide concentration and the addition of 1 gram per liter of sodium bisulfite. The decrease in bromide concentration gives a slightly more energetic developer, necessary to overcome the effect of chrome alum hardener used before development. The addition of the sodium bisulfite gives a more stable developing solution by helping to reduce aerial oxidation.

When the film is placed in No. 605 developer, the residual silver halides are reduced to positive silver images and at the same time the decomposition product of the color-developing agent, Dicola-mine, reacts chemically with the color-forming groups, which are placed in each emulsion layer during manufacture to form full-color positive dye images in each layer.

Following color development, the film is again immersed in No. 858 shortstop and No. 901 hardener to remove the developing agent and harden the emulsions. The second hardening is necessary because the alkali of the color developer destroys the hardening imparted by the first hardening bath. To conserve space, the same shortstop and hardener solutions can be used as were used after the first developer.

Variations in the concentration of the developing agent (Dicola-mine) will increase or decrease the time necessary for color develop-

ment and will also modify color balance slightly. A reduction in the concentration of the developing agent will give generally warmer tones, and an increase will give generally colder tones.

The concentration of sodium carbonate has a marked effect on color balance of the transparency. Lower concentrations of carbonate will give relatively more development of the cyan and magenta layers to yield a colder color balance. Higher concentrations of carbonate than the recommended 67.5 grams per liter increase yellow layer development to give warmer-than-normal tones. Ten per cent variations of carbonate can easily be detected.

Potassium bromide again serves the purpose of a restrainer and must be controlled within 10 per cent to insure proper developer activity.

**Caution!** The manufacturer recommends that the photographer wear rubber gloves during the color development and while this formula is compounded. If the developer gets on the hands, rinse them in 2 per cent acetic acid. The author detests rubber gloves, he has not worn them since he dropped a slippery developer bottle and broke it because of clumsy gloves. But he exercises reasonable caution about keeping solutions off his hands.

Following the second hardener, the film must be washed for at least 5 minutes in running water before being bleached. This wash must be thorough to remove all traces of the hardener and color-developer solutions.

The concentration of potassium chrome alum used is not critical but should be kept between 2 per cent and 4 per cent for best results. Care should be taken to get the purple potassium chrome alum and not white (potassium) alum, or some loss of color may result due to the highly acidic character of white alum.

The No. 901 hardener should be used within two weeks after mixing.

If desired, baths Nos. 854 and 901 may be replaced by a combined clearing and hardening bath No. 903, used for 5 minutes.

**BLEACH No. 709.** The concentration of ferricyanide can be increased to give a higher bleaching rate, but it should not be reduced below 60 grams per liter or poor bleaching may result. Fifteen grams of bromide is sufficient for normal exhaustion of the bleach, and increased bromide will increase the corrosive action.

The ratio of bisulfate to disodium phosphate should not be varied more than 10 per cent in either direction. Too high a bisulfate concentration will give a strongly acid bleach that will harm the colors, and too alkaline a bleach (from too much disodium phosphate) will give stained high-light areas.

The corrosion protection can be raised or lowered by varying the concentrations of sodium bisulfate and disodium phosphate simultaneously.

**BLEACH No. 713.** Another bleach formula, No. 713, is recommended where continuous processing is done or where great quantities of film must be run through the processing solutions.

This formula will give more rapid bleaching throughout a longer life by reason of its higher ferricyanide concentration. The increased amounts of disodium phosphate and sodium bisulfate tend to reduce corrosion to a minimum.

Regardless of the bleach solution used, it is necessary to make certain that bleaching action is complete. Failure to secure adequate bleaching through too short a bleaching time, insufficient agitation, or the use of exhausted solution will result in a yellowish veil of silver over the entire picture.

Following the bleaching, wash the film in cool running water for 3 to 5 minutes or until the wash water is no longer stained yellow. Failure to wash properly so that bleach is carried over into the hypo will not harm the transparency, but the bleach carried over will greatly shorten the life of the fixer. Adequate washing is quite important in all steps of color-film processing.

**FIXING No. 800.** A good rule to follow is that of fixing for twice the time necessary to clear the film—approximately 5 minutes. At

this point the transparency should appear as a beautiful full-color reproduction of the original scene.

A word of caution is advisable. If an acid fixer is used to fix color film, part of the dyes will be destroyed. A neutral or slightly alkaline hypo bath should always be used.

After fixing, the film should be washed in running water for at least 10 minutes, sponged gently, and dried away from heat and dust. It is important to observe great cleanliness in the operation of sponging and drying. Particles of dirt or chemical dust on the sponge or chamois may scratch or cause spots on the emulsion. The air should also be entirely free from chemical fumes, particularly acid or sulfur dioxide fumes. Even the slight amount of fumes arising from an open tank of No. 851 shortstop can cause the magenta image to fade if the film should be hung near by to dry.

### *Keeping Properties of Color-Processing Solutions*

First developer No. 502 has excellent keeping qualities. Tightly stoppered samples of the developer have been stored under ideal conditions in the laboratory for over six months and are still perfectly satisfactory for use.

Naturally, when the solution is used repeatedly, its keeping properties will be considerably reduced. With optimum care, a solution kept in a covered deep tank or poured back into a stoppered bottle after each use should have a life of three to four weeks, provided the exhaustion capacity is not reached before that time.

The shortstop, clearing bath, hardener, bleach, and hypo all have lives of more than a month either with or without use. However, the shortstop should be stored in a closed container to avoid excessive release of sulfur dioxide fumes in the darkroom, since in sufficient concentration these may bleach any transparencies that may be drying near by.

The ability to mix your own color solutions is a great advantage due to this fact that they do not have equal keeping properties.



## LIFE OF SOLUTIONS

<i>Solution</i>	<i>Recommended Life in Covered Tanks or Closed Bottles</i>	<i>Exhaustion Capacity in Number of 8 by 10 Films per Liter</i>
No. 502 developer	1 month	4
No. 858 shortstop	1 month	4
No. 901 hardener	1 week	8
No. 605 color developer	2 weeks	4
No. 709 bleach	1 month	4
No. 800 fixer	1 month	8

*Second Exposure*

Hang film 4 feet from a No. 2 flood lamp and expose for 3 minutes—approximately 1½ minutes each side. The entire surface of the film should be exposed, but care must be taken that heat from the lamp does not soften the film emulsion. Exposure times longer than 3 minutes do no harm except to increase the danger of softening. If insufficient second exposure is given, the finished transparency will lack cyan and magenta and will have low-density blacks.

*Processing Equipment*

Most types of black-and-white processing equipment are satisfactory for processing Ansco color film.

Standard stainless-steel or plastic sheet-film hangers can be used successfully in regular hard-rubber sheet-film developing tanks or in glass battery jars of suitable size.

If tray development is desired, glass, stainless-steel, plastic, or uncracked enamel trays can be employed.

Enclosed development reels or racks that do not permit free access of light to all portions of the film require that the wet film be removed for second exposure, then reloaded. With many types

of reels this can be accomplished more easily if both the film and reel are held under water during the reloading operation. "Open type" wire reels are quite satisfactory for processing 35-mm film and do not make necessary the removal of the film.

Longer lengths of motion-picture film can be wound on large racks made to fit deep tanks of stone or impregnated wood. Reels of the squirrel-cage type, which only partially immerse the film in the solutions, cause excessive aeration of the developers and should be avoided.

With any type of equipment, provisions must be made to secure and maintain vigorous, reproducible agitation to avoid streaking and insure consistent results. And above all, strict cleanliness is necessary. Dirty or corroded equipment can lead to disappointing results just as surely as can careless processing or improperly compounded solutions.

## PROCESSING SOLUTION FORMULAS FOR ANSCO COLOR FILM

### ANSCO FIRST DEVELOPER NO. 502

	<i>Liter</i>	<i>Quart</i>	<i>Gallon</i>	<i>3½ Gallons</i>
Water 65 to 90°F	750 cc	24 ounces	3 quarts	2½ gallons
Metol	3 grams	44 grains	¼ oz. 65 gr.	1¼ oz. 65 gr.
Sodium sulfite	50 grams	1½ oz. 80 gr.	6¾ ounces	1 lb. 7 oz.
Hydroquinone	6 grams	90 grains	¾ oz. 25 gr.	2¾ ounces
Sodium carbonate, monohydrated	40 grams	1¼ oz. 40 gr.	5¼ ounces	1 lb. 2½ oz.
Sodium thiocyanate	2 grams	30 grains	¼ oz. 5 gr.	¾ oz. 80 gr.
Potassium bromide	2 grams	30 grains	¼ oz. 5 gr.	¾ oz. 80 gr.
Water to make	1 liter	1 quart	1 gallon	3½ gallons

Do not dilute for use.

Develop both Daylight and Tungsten Type film 14 minutes at 68°F.

## ANSCO SHORTSTOP NO. 858

	<i>Liter</i>	<i>Quart</i>	<i>Gallon</i>	<i>3½ Gallons</i>
Water 65 to 90°F	750 cc	24 ounces	3 quarts	2½ gallons
Ansco acetic acid (glacial)	10 cc	10 cc	40 cc	140 cc
Ansco sodium acetate	20 grams	½ oz. 75 gr.	2½ oz. 75 gr.	9¼ ounces
Water to make	1 liter	1 quart	1 gallon	3½ gallons

Do not dilute for use.

Use for 1 to 2 minutes at 60 to 75°F.

## ANSCO SHORTSTOP NO. 851

	<i>Liter</i>	<i>Quart</i>	<i>Gallon</i>	<i>3½ Gallons</i>
Water 65 to 90°F	750 cc	24 ounces	3 quarts	2½ gallons
Sodium bisulfite	50 grams	1½ oz. 80 gr.	6¾ ounces	1 lb. 7 oz.
Water to make	1 liter	1 quart	1 gallon	3½ gallons

Do not dilute for use.

Use for 3 minutes at 60 to 70°F.

## ANSCO COLOR DEVELOPER 605

	<i>Liter</i>	<i>Quart</i>	<i>Gallon</i>	<i>3½ Gallons</i>
Water 65 to 70°F	750 cc	24 ounces	3 quarts	2½ gallons
Ansco Dicolamine	16 cc	16 cc	64 cc	225 cc
Sodium bisulfite	1 gram	15 grains	60 grains	210 grains
Sodium carbonate, monohydrated	67.5 grams	2¼ ounces	9 ounces	2 pounds
Potassium bromide	1 gram	15 grains	60 grains	210 grains
Water to make	1 liter	1 quart	1 gallon	3½ gallons

Do not dilute for use.

Develop film 16 minutes at 68°F.

## ANSCO CLEARING BATH NO. 854

	<i>Liter</i>	<i>Quart</i>	<i>Gallon</i>	<i>3½ Gallons</i>
Water 65 to 90°F	750 cc	24 ounces	3 quarts	2½ gallons
Sodium bisulfate	10 grams	¼ oz. 40 gr.	1¼ oz. 40 gr.	4¾ ounces
Sodium acetate	30 grams	1 ounce	4 ounces	14 ounces
Water to make	1 liter	1 quart	1 gallon	3½ gallons

Do not dilute for use.

Use for 3 minutes at 60 to 70°F.

## ANSCO HARDENER NO. 901

	<i>Liter</i>	<i>Quart</i>	<i>Gallon</i>	<i>3½ Gallons</i>
Water 65 to 90°F	750 cc	24 ounces	3 quarts	2½ gallons
Potassium chrome alum	30 grams	1 ounce	4 ounces	14 ounces
Water to make	1 liter	1 quart	1 gallon	3½ gallons

Do not dilute for use.

Use for 4 minutes at 60 to 75°F.

ANSCO ALTERNATIVE CLEARING AND HARDENING BATH  
NO. 903

	<i>Liter</i>	<i>Quart</i>	<i>Gallon</i>	<i>3½ Gallons</i>
Water 65 to 90°F	750 cc	24 ounces	3 quarts	2½ gallons
Potassium chrome alum	30 grams	1 ounce	4 ounces	14 ounces
Sodium bisulfate	20 grams	½ oz. 75 gr.	2½ oz. 75 gr.	9¼ ounces
Sodium acetate	22.5 grams	¾ ounce	3 ounces	10½ ounces
Water to make	1 liter	1 quart	1 gallon	3½ gallons

Do not dilute for use.

Use for 5 minutes at 60 to 70°F.

## ANSCO BLEACHING BATH NO. 709

	<i>Liter</i>	<i>Quart</i>	<i>Gallon</i>	<i>3½ Gallons</i>
Water 65 to 90°F	750 cc	24 ounces	3 quarts	2½ gallons
Dipotassium monosodium ferricyanide or potassium ferricyanide	60 grams	2 ounces	8 ounces	1¾ pounds
Potassium bromide	15 grams	½ ounce	2 ounces	7 ounces
Dibasic sodium phosphate	13 grams	¼ oz. 80 gr.	1¾ ounces	6 ounces
Sodium bisulfate	6 grams	90 grains	¾ oz. 25 gr.	2¾ ounces
Water to make	1 liter	1 quart	1 gallon	3½ gallons

Do not dilute for use.

Use for 8 to 10 minutes at 60 to 75°F or twice the time necessary to change the color on the back of the film to blue-green.

## ANSCO ALTERNATE BLEACH BATH NO. 713

	<i>Liter</i>	<i>Quart</i>	<i>Gallon</i>	<i>3½ Gallons</i>
Water 65 to 90°F	750 cc	24 ounces	3 quarts	2½ gallons
Dipotassium monosodium ferricyanide or potassium ferricyanide	100 grams	3¾ ounces	13¾ ounces	2 lb. 15 oz.
Potassium bromide	15 grams	½ ounce	2 ounces	7 ounces
Dibasic sodium phosphate	40 grams	1¼ oz. 40 gr.	5¼ ounces	1 lb. 2½ oz.
Sodium bisulfate	25 grams	¾ oz. 40 gr.	3¼ oz. 40 gr.	11½ ounces
Water to make	1 liter	1 quart	1 gallon	3½ gallons

Do not dilute for use.

Use for 8 minutes at 60 to 70°F or 2 minutes longer than is necessary to change the color on the back of the film to blue-green.

## ANSKO PLAIN HYPO FIXING BATH NO. 800

	<i>Liter</i>	<i>Quart</i>	<i>Gallon</i>	<i>3½ Gallons</i>
Sodium thiosulfate (hypo)	200 grams	6¾ ounces	1¾ pounds	5¾ pounds
Water (125°F) to make	1 liter	1 quart	1 gallon	3½ gallons

Do not dilute for use.

Use for 4 minutes at 60 to 75°F or for twice the time necessary to clear film of all traces of silver halide.

### *Compensating for Underexposures and Overexposures in Ansco Color*

Some opportunity is offered with Ansco color film for compensating a certain amount of error in exposure, provided it is realized that the incorrect exposure occurred. Compensation takes place by variations in the time of the first development, all other parts of the processing being carried out exactly according to directions for correctly exposed film. The following table will indicate the changes in first development required to correct or partially correct for improper exposure.

<i>Overexposure</i>	<i>First Development Time in Minutes</i>	<i>Underexposure</i>
1½ stop	9½	—
1 stop	10½	—
½ stop	12	—
Normal exposure	14	Normal exposure
—	17	½ stop
—	20½	1 stop
—	25	1½ stop

### *Reducing Solutions for Ansco Color Transparencies*

Ansco color photographs which are overly dense because of underexposure or which have slightly incorrect balance because they were exposed by illumination that was not of correct color

quality are sometimes salvageable by aftertreatment in reducing solutions. The Ansco Research Laboratories have worked out a set of formulas for reducing selectively each of the three dye layers. These reducers act slowly enough so that the progress of the treatment can be observed and controlled without undue difficulty.

The density reduction effected when minor errors in color balance are being corrected is small enough so that a well-exposed transparency with saturated colors is not spoiled. However, transparencies that are even slightly overexposed to start with can be changed in color balance only at the expense of a thin image.

When a transparency shows good color balance but is simply too dense from underexposure in the camera, satisfactory correction can be achieved to the extent of compensating for approximately one full lens stop underexposure.

Under these circumstances the yellow reducer should be employed first, followed by the cyan and magenta reducers. If a different order is followed, the dye bleached by the earlier treatment will be partially or wholly recolorized during subsequent reducing operations. The yellow reducer, for example, tends to counteract the effect of previous magenta reduction.

The solutions are known as proportional reducers—i.e., they tend to bleach the heavier dye densities at a faster rate than the lighter areas. Since in color-balance correction it is the lighter areas which are of greater importance and which therefore most need to be changed, care should be exercised that the darker parts of the picture are not reduced too far. For the same reason the solutions are not well adapted for use with Ansco Color Printon, in which the shadow areas will be considerably weakened before sufficient change has been effected in the middle and light tones. However, as an emergency measure, they can be employed with Printon, as well as with Ansco color film transparencies.

The reducing formulas and the procedures for treating transparencies with them are from *The Ansconian*, March–April, 1946.

## YELLOW REDUCER

<i>Formula</i>	<i>Metric</i>	<i>Avoirdupois</i>
Potassium ferricyanide	20 grams	½ oz. 70 gr.
Sodium hydroxide	3 grams	44 grains
Boric acid	1.5 grams	22 grains
Water to make pH—11.8	1 liter	32 ounces

*Procedure*

- (1) 5 minutes in 1 per cent formaldehyde solution—60 to 75°F
- (2) 5 minutes—wash
- (3) 1 to 3 minutes in yellow reducer depending on amount of reduction desired—68°F
- (4) 15 minutes—final wash

## CYAN REDUCER

<i>Formula</i>	<i>Metric</i>	<i>Avoirdupois</i>
Sodium sulfite	10 grams	¼ oz. 35 gr.
Chlor-hydroquinone	10 grams	¼ oz. 35 gr.
Water to make pH—7.7	1 liter	32 ounces

*Procedure*

- (1) 5 minutes in 1 per cent formaldehyde solution—60 to 70°F
- (2) 5 minutes—wash
- (3) 1 to 5 minutes in cyan reducer depending on amount of reduction desired—68°F
- (4) 15 minutes—final wash

The cyan reducer should be prepared fresh each day.

## MAGENTA REDUCER

<i>Formula</i>	<i>Metric</i>	<i>Avoirdupois</i>
Sodium sulfite	5 grams	73 grains
Sodium bisulfite	18 grams	½ oz. 44 gr.
Water to make pH—6.9	1 liter	32 ounces

*Procedure*

- (1) 5 minutes in 1 per cent formaldehyde solution—60 to 75°F
- (2) 5 minutes—wash
- (3) 1 to 4 minutes in magenta reducer depending on amount of reduction desired—68°F
- (4) 15 minutes—final wash



## NOTES ON PROCESSING ANSCO AND KODAK COLOR FILM

The author has found that processing transparencies is tedious rather than difficult. One should use tanks, but the job can be done in trays. Several trays must be on hand and they must be clean. After the first development and shortstop (hardening in Ektachrome), which must be done in darkness, full light can be utilized so that one can see what is transpiring at each point. The author carries Ansco through the first development, shortstop, and a 5-minute wash in one stage. At this point the films are dried. Ektachrome processing, too, can be interrupted at this point.

The first Ansco transparency was processed all by itself, as a sort of trial run. After this was successful, four 4 by 5 films were run through in 8 by 10 trays without trouble. Exactly 70 minutes were required, in each case, for all processing except the first developing, stop bath, and washing. The only real difficulty arose from a tendency to frill at the corners where the films were held by the fingers when they were lifted out of the first developer at regular intervals to insure proper agitation. For this reason, subsequent pictures were kept well away from the edges of the films so that any frilling present would not cut into the desired image. Probably a pair of stainless-steel tweezers with which to hold the films would eliminate this slight trouble—which would not occur if the films were placed in hangers and developed in a tank.

So well spaced apart in time are the several steps that the individual solutions through which the films must go after the short-stop can be placed in trays one or two steps ahead of the time actually needed. Thus, three trays can have in them the second developer, the clearing bath, and the hardener. When the films go into the hardener and have been agitated for a minute or so, the color developer can be replaced in its bottle and the tray washed and filled with water for the rinse following the hardener. During the wash the clearing bath and the hardener can be replaced

in their containers and the trays washed and prepared for the bleach and the fixer.

In this manner only three trays are necessary, so that the amount of space required is correspondingly reduced. One must move right along, however, timing each step carefully and having things so arranged that there is no chance of contamination.

There is an undeniable thrill in watching the colors appear in the fixing bath. Where time is important, where the photographer likes to carry through his own work in his own place and in his own time, the home-processed transparency materials like Ansco and Kodak Ektachrome color film provide most welcome media.

One of the things to remember is that the solutions do not keep long. For best results they should be made up just before actual processing is to take place. This places a handicap on the amateur who wishes to run through some films only now and then. Since Ansco publishes the formulas, this matter is not of too great importance, but it must be kept in mind. Seven solutions are required for Ansco, five for Ektachrome film. The mere matter of weighing out of the chemicals, mixing them with the required amount of water, placing the resulting solutions in clean bottles, labeling the bottles—all this takes time. The Eastman Kodak Company does not publish the formulas for use with Ektachrome film. Thus it is important to know the amount of film that has gone through the solutions and to be sure that the film at hand will not overstep the limits prescribed by the manufacturer. It is always wise to take stock occasionally of one's chemical larder so that plenty of everything can be kept on hand.

When Ektachrome films are finally hung up to dry, they look ready for the wastebasket; but as they dry, the full beauty of the color becomes apparent. The opalescent, semitransparent appearance disappears when the films are dry.

One can see, from this discussion, that home-processing color film is no joy ride; it is very doubtful that the average amateur has

much business in doing it. All that is saved is the time required to send the film to a laboratory especially set up to process it, the time to get it back, and some processing money. On those occasions when time is important—and this applies to professional photographers mostly—then home processing makes sense.

### Capacity of Solutions

Each gallon of Ektachrome solutions will process about 8 square feet of film, and 10 square feet can be run through with some change in color balance. However, the quality suffers so little, according to the manufacturer, that only the critical will be bothered by it. One gallon will process about 1,200 square inches, which amount to sixty 4 by 5 films and a correspondingly greater number of smaller films as shown in the table below based on 1,200 square inches to the gallon. Since Eastman does not sell the materials in quart sizes, the costs in the table are figured on the basis of a 2-quart kit of chemicals. Ansco kits are available in 1-quart sizes.

COLOR FILM COST PER EXPOSURE

Film Size	Area in Square Inches	Kodak Ektachrome Film				AnSCO Color Film			
		Number per 2 Quarts	Cost in Cents			Number per 2 Quarts	Cost in Cents		
			Film	Processing	Total		Film	Processing	Total
2¼ by 3¼	7.3	80	34.5	6	40	93	37	2.3	40
3¼ by 4¼	14	44	48	10	58	51	51	4.2	55
4 by 5	20	30	65	15	80	34	69	6.3	75
5 by 7	35	16	107	28	135	19	112	11.3	125
35-mm roll	—	—	—	—	—	12	20	2	22
120 } 2¼ by	—	—	—	—	—	—	—	—	—
620 } 2¼ by	—	—	15	5	20	10	11	2	13
620 } 3¼ by	—	—	23	7	30	10	17	2	19

Note: Prices are approximate and include excise tax as of November, 1947.

All Ansco solutions except developers and hardener (3 per cent solution of chrome alum) keep well. Small quantities of Ansco developer should not be kept more than a few days; if the quantity is several gallons, it can be kept in tightly stoppered, full bottles for two weeks; partially used solutions should not be stored more than a week.

### Common Defects in Transparencies

All aspects of exposing and processing color transparencies are critical—i.e., the user of color film must exercise much greater care than he does with his black-and-white film. There is little opportunity to correct errors made in exposure or processing. Once one has committed an error, it is necessary to find the cause so that it is not repeated and, if possible, to find a method by which the error can be compensated. The following table gives a list of the common defects found in Ansco color transparencies with suggestions as to their causes and some possible remedies.

COMMON DEFECTS IN ANSCO TRANSPARENCIES

<i>Defect</i>	<i>Possible Causes</i>	<i>Remedy</i>
<b>Too bluish</b>	<ol style="list-style-type: none"> <li>1. Tungsten film exposed to daylight without proper filter (No. 11)</li> <li>2. Tungsten film exposed to clear flash without proper filter (No. UV-16)</li> <li>3. Daylight film exposed in shade or on cloudy overcast day without proper filter (UV-16)</li> </ol>	
<b>Too red or pinkish</b>	<ol style="list-style-type: none"> <li>1. Daylight film exposed by ordinary clear flash lamp or by flood without proper filter (No. 10)</li> <li>2. Film exposed too late or too early in the day</li> <li>3. Insufficient washing between <b>hardening and bleaching</b></li> </ol>	<b>None</b>

## COMMON DEFECTS IN ANSCO TRANSPARENCIES—Continued

<i>Defect</i>	<i>Possible Causes</i>	<i>Remedy</i>
Over-all lack of density	<ol style="list-style-type: none"> <li>1. Overdevelopment in first developer</li> <li>2. Exhausted shortstop</li> <li>3. Insufficient second exposure</li> <li>4. Insufficient color development</li> </ol>	None None None None
Excessive density with over-all "muddy" appearance	<ol style="list-style-type: none"> <li>1. Insufficient first development</li> </ol>	None
Excessive density with exaggerated color and contrast	<ol style="list-style-type: none"> <li>1. Overdevelopment in color developer</li> </ol>	None
Brownish streaks or spots	<ol style="list-style-type: none"> <li>1. Incomplete bleaching</li> </ol>	Rebleach, fix, and wash
Grayness or dull colors with normal over-all density	<ol style="list-style-type: none"> <li>1. Incomplete bleaching</li> </ol>	Rebleach, fix, and wash
General greenish cast	<ol style="list-style-type: none"> <li>1. Exposure of transparency to sulfur dioxide fumes from shortstop bath while drying</li> </ol>	Rebleach (3 minutes), fix, and wash
General milky appearance	<ol style="list-style-type: none"> <li>1. Incomplete fixation</li> </ol>	Refix and wash

## KODACOLOR FILM

Since the beginning of 1942 amateurs have had another color process, one gotten up expressly for them. Kodacolor film makes it possible for the rankest amateur to have color prints of the subjects he likes to record without much more bother than he experiences in making black-and-white pictures. While Kodacolor film reproduces colors with sufficient fidelity to afford attractive color prints,

the material is not intended for making color records or for matching or measuring colors. In the hands of the average amateur, the color prints are as good as black-and-white prints, as far as a definition goes, with the added advantage of being in color. This means that Kodacolor prints are inclined to be contrasty and not too sharp in details—characteristics of amateur prints made with amateur box and folding cameras. In other words, Kodacolor film is for use with cameras that are not essentially precision instruments operated by expert technicians.

The negatives made on Kodacolor film are like any monochrome negatives except that the images are in colored dye and not in black silver. Black-and-white prints can be made from these negatives by the same methods employed in making any positive paper print from a negative. In addition, the manufacturer will make color prints from these negatives—in fact, that is the whole object of making the film available.

### *How to Use Kodacolor Film*

This film is balanced for use at  $\frac{1}{50}$  second in full or hazy sunlight. The basic exposures for these conditions are  $f/11$  and  $f/8$ , respectively, for average-colored subjects in the summer. This works out to be a Weston speed of 20 or 32 with the GE meter. The tables on page 132 summarize the exposure conditions.

Compared to black-and-white materials, Kodacolor film has limited latitude, but it is greater than is possible with Kodachrome film, chiefly because Kodacolor film produces negatives whereas Kodachrome is a reversal material designed to yield positive images. An error of about 2 to 1 can be tolerated with Kodacolor—i.e., one full stop over or under the correct exposure. Correct exposure is necessary, however, for best results. This is one of the great troubles with the average amateur; he has been so spoiled by the technique of “you push the button, we do the rest” that he is inclined to refuse to use good judgment and then to blame the processor when the pictures are poor.

Overexposure and underexposure produce the same results with Kodacolor film as they do with monochrome film. Underexposure results in lack of shadow details; overexposure results in flat, blocked-up high lights. Persons' faces become blank white without modeling if the exposure is too great. Both underexposure and overexposure falsify colors.

#### RECOMMENDED METER SETTINGS FOR KODACOLOR

<i>Kodacolor Roll Film</i>	<i>Weston</i>	<i>GE</i>
Daylight	20	32

#### DAYLIGHT EXPOSURE TABLE

*Lens apertures at  $\frac{1}{50}$  second shutter speed for Kodacolor exposures in summer or in winter when snow is on the ground. For winter scenes without snow, use one lens opening larger in all cases*

<i>Lighting Conditions*</i>	<i>Exposures for Average Subjects</i>	<i>Light-colored Subjects</i>	<i>Dark-colored Subjects</i>
Bright summer sunlight	<i>f/11</i>	Between <i>f/11</i> and <i>f/16</i>	Between <i>f/8</i> and <i>f/11</i>
Hazy sun, soft shadows	<i>f/8</i>	Between <i>f/8</i> and <i>f/11</i>	<i>f/6.3</i>

\* Since Kodacolor film is color balanced for bright or hazy sunlight, best results can be expected under these lighting conditions only. Kodacolor pictures made on cloudy days or in shade require about  $\frac{1}{50}$  second at *f/4.5* but tend to be flat and somewhat bluish.

#### SUPPLEMENTARY FLASH FOR OUTDOOR SUBJECTS

*Synchronized outdoor flash pictures with No. 22B or No. 5B photoflash lamps*

<i>Lamp-to-subject Distance in Feet</i>	<i>Shutter Speed</i>	<i>Lens Opening</i>
5	$\frac{1}{50}$	<i>f/16</i>
7	$\frac{1}{50}$	<i>f/11</i>
10	$\frac{1}{50}$	<i>f/8</i>

*Note: Clear-bulb photoflash lamps cannot be used for this purpose.*

This table is based on practical tests with average subjects in bright sunlight. As lamp-to-subject distance increases, lens opening must be increased if illumination in shadows is to remain constant. Larger lens openings in turn require faster shutter speeds so that the sunlit portions of the subject will not be overexposed. The change in shutter speed does not affect the shadow illumination proportionally, because the duration of highest intensity of the flash is very short.

### *Lighting Suggestions*

Those who are accustomed to making Kodachrome pictures for color printing or photomechanical reproduction will find that the same lighting principles apply with Kodacolor. The best color prints are obtained when the subject is evenly lighted and when shadows are soft rather than dark and hard.

When dark shadows cannot be avoided, the subject should be lighted from the front so that important details will not be obscured in shadow. In front lighting, the sun should be well to the front of the subject but not "head on"—i.e., it should strike the subject from a slight angle over the photographer's shoulder rather than from directly over his head. When the sun is directly in front of the subject, the face usually tends to have a flat, washed-out appearance.

Groups of persons should not be photographed when standing partly in sunlight and partly in shade. Precautions such as this are necessary because color-printing processes can accommodate only a rather limited range of subject brightness.

Hazy sunlight provides an excellent opportunity for pleasing Kodacolor pictures. Shadows are soft and well lighted, and there is less tendency for subjects to squint than on bright days. In exposure tables and guides, hazy sunlight refers to haze sufficiently dense that the sun's disk can be viewed directly without discomfort. Under this condition, one stop more exposure is required than for bright sunlight.



**TIME OF DAY.** The angle of the sun is an important consideration in all outdoor photography. During the middle of the day, with the sun directly overhead, there are heavy shadows under the eyes, nose, and chin of the subject. More pleasing shadows and better modeling are obtained when the sun is lower in the sky—i.e., during midmorning and midafternoon. In general, scenic and architectural subjects also photograph to best advantage with the sun at an angle.

During the two hours after sunrise and before sunset, sunlight is too orange for pictures of persons on Kodacolor film. For pictorial treatment of scenic subjects, however, the lighting effects and warmth of color obtainable at these periods may be very desirable. Such pictures require from one-half to two stops greater exposure than that recommended for bright sunlight.

**CLOSE-UPS.** Many of the most attractive color pictures are close-ups of individuals. When properly made, these pictures afford bold, colorful compositions that compliment both the photographer and his subject. Careful posing and lighting are essential, because the good and bad points in a close-up are equally apparent.

For close-ups taken with Kodacolor film in bright sunlight, avoid side lighting or back lighting unless the shadow areas are illuminated by a reflecting surface or a flash lamp, as described below. Note the angle of the sun and pose the subject to obtain the best modeling and shadow effects. When you are ready to shoot, ask your subject to look away from the sun for a few minutes to rest his eyes. He cannot help squinting if he must face the sun for a long time.

**SUPPLEMENTARY LIGHTING.** In nearly all cases, supplementary lighting will improve close-ups taken in bright sunlight. It is particularly essential when side lighting or back lighting is employed. Its object is to "fill in" shadow areas with light and thus soften harsh facial shadows.

Natural surroundings often afford a satisfactory light-reflecting surface. In winter, snow-covered ground makes other reflectors unnecessary. In summer, a sidewalk, a white wall, or the light-colored sand on a beach may provide adequate shadow illumination. Colored reflecting surfaces must be avoided, because their color will affect the rendering of shadow areas. In the absence of natural reflecting surfaces, "fill-in" illumination can be obtained with special reflectors or by means of synchronized flash exposures. Before you load up on flash apparatus, try simple reflectors.

A large white card, photographic blotter, or even a newspaper is a suitable reflector. It can be placed on the ground, in the lap of the subject, or held at one side by an assistant. It must be outside the picture area and should be placed carefully to obtain the best effect.

Synchronized flash exposures with No. 22B or 5B flash lamps provide a second method of filling in shadows in close-ups. These lamps can be used to supplement daylight because they are coated with a blue lacquer, causing the light to approximate daylight in color quality. To avoid overexposure of flesh tones, observe exposure recommendations carefully and do not concentrate the flash on the face of the subject. Synchronizing equipment is necessary because open-flash exposures in sunlight are impractical.

Supplementary lighting techniques are recommended for close-ups only. As subject distance increases, "fill-in" illumination is less important, because shadow areas are smaller and less noticeable.

#### KODACOLOR PHOTOFLASH EXPOSURES INDOORS

*One No. 22B photoflash lamp in reflector—open flash (set shutter for time or "bulb")*

<i>Lamp Distance in Feet</i>	<i>5</i>	<i>7</i>	<i>10</i>	<i>14</i>
<b>1 No. 22B (no filter)</b>	<i>f/11</i>	<i>f/8</i>	<i>f/5.6</i>	<i>f/4</i>

**EXPOSURE GUIDE NUMBERS FOR USE WITH KODAK SENIOR OR JUNIOR SYNCHRONIZERS**

<i>Photoflash Lamp</i>	<i>Open Flash <math>\frac{1}{2}</math> or <math>\frac{1}{60}</math> Second</i>	<i><math>\frac{1}{100}</math> Second</i>	<i><math>\frac{1}{200}</math> Second</i>
No. 5B	50	40	25
No. 22B	55	45	28

These guide numbers are for average-size rooms with light-colored walls and ceilings. Divide the guide number by the distance in feet from lamp to subject to determine the recommended lens opening or *f*-number.

*Note* For correct synchronization with the No. 5B lamp in a Kodak Junior Synchronizer, shutter speeds faster than  $\frac{1}{60}$  second must not be used.

**ARTIFICIAL LIGHT.** Kodacolor film is designed primarily for sunlight exposure, and best results will not be obtained with any form of artificial light used independently of sunlight. When it is necessary to make Kodacolor pictures indoors, only blue-bulb flash lamps (Nos. 22B and 5B) should be used. Never use regular or daylight flood lamps or clear-bulb flash lamps, since the pictures will be orange in color.

A common fault of Kodacolor pictures by photoflash is a rather flat and washed-out appearance in the face of the subject, caused by overexposure of flesh tones. It can be avoided by the use of lamp and reflector combinations that produce even, diffuse illumination, such as the No. 22B lamp and a Kodaflector (matte side). If the light is not evenly distributed and well diffused, the reflector should not be pointed directly at the face of the subject.

Better lighting effects are obtainable when two or more lamps are used instead of one lamp at the camera. This is possible by means of extension flash holders such as those supplied for the Kodak Senior Synchronizer. With one lamp at the camera and a second lamp higher and at an angle of about 45° to the camera axis, the exposure required is about half that for a single lamp.

For most consistent results in making photoflash pictures with Kodacolor film, the camera should be used on a tripod with the

shutter set on "bulb," so that the entire period of the flash will be used. When it is necessary to make synchronized flash pictures, the camera shutter must be synchronized accurately with the peak of the flash, because the light changes in both color and intensity during the flash. Inaccurate synchronization may cause variation in the color balance of the Kodacolor prints.

As in getting acquainted with all other color films critical as to exact exposure, the photographer will save money, time, and disappointment if he will expose a roll or two under various conditions of shutter speed, lens opening, exposure-meter setting, etc., keeping careful record of all such exposures including the condition and direction of the illumination and the subject matter. In this manner he can determine for his own equipment the best possible settings.

There is every reason to believe that Kodacolor has not reached its peak of perfection and that further improvements will be made in the materials and processes as time goes on. The war interfered with much research and development ordinarily taking place in the manufacturers' laboratories with the result that some of the color processes have not moved forward with the speed that would have occurred otherwise.

### *Home-Processed Kodacolor*

In the October, 1943, *American Photography*, C. Howard Schofer gave formulas and procedure for processing Kodacolor films at home, producing either the usual color negative or, by a reversal process, a positive transparency. Since Kodacolor processed to a colored negative is of no value except for the purpose of making prints, there seems little need for the photographer to do his own processing unless he is in a great hurry to see what he is getting or unless he is a born experimenter. On the other hand, the larger sizes of Kodacolor compared with Kodachrome make it attractive as a means of making large transparencies for projection

or for print making by the usual separation negative methods. The author has not had any experience with Mr. Schotofer's recommended formulas or practice and sees little to be gained by attempting the processing of Kodacolor film unless the photographer really likes to experiment with complex methods. His feeling about Kodacolor is the same as his feeling about processing color film at home—unless the worker delights in doing the work, unless time is of great importance, it is better to let a professional laboratory do it.

## Separation Negatives

**A**LTHOUGH THERE ARE other ways to make color prints, the best ones produced today by professionals or by amateurs are made by the process that requires separation negatives. In this method, the original scene can be impressed on a color film first, or it can be photographed directly without the transparency. But when made either directly from the original subject or through the intermediate step of making a transparency, separation negatives are necessary. These negatives are required for the simple reason that the picture must first be taken apart—analyzed is the technical word—and then, after certain complex processes, the individual pieces are put back together—synthesized.

In this separation process, often called “breaking down the picture,” certain colors are impressed on one film, other colors on another film, and all that remains on the third film. It is possible to make a color picture in this manner for the simple reason that any color can be simulated by building it up out of three elementary colors—blue-green (cyan), blue-red (magenta), and yellow. Thus you can make up any one of a dozen shades of green by juggling the amount of the individual components cyan and yellow plus dashes of magenta. In the separation process, therefore, what you are doing is recording photographically the amounts of these elementary colors from which the original colors can be reconstructed.

The process consists in photographing the scene three times on three films or plates, once each through a red, a green, and a blue filter. These particular colored filters are employed because there is a reversal of all tone values when a negative is made of a scene,

the light parts of the scene becoming dark in the negative. When these negatives are printed onto positive material, there is another reversal of tone values, and the light portions become light again in the print.

If you wish to record the blue-green (cyans), you must make the negative through a filter that actually records "minus" blue-green or everything that is not blue-green. If you subtract blue-green from white light, you get red. The filter necessary to record the blue-greens on the negative must be red in color. Similarly, the green filter makes a negative that produces a print recording the colors that are nongreen; such a color is magenta. To record the yellows in a print, the negative from which that print is made must be made through a filter that passes nonyellow, and this color is blue. The individual prints, therefore, recorded through the red, green, and blue filters, record, respectively, the cyans, the magentas, and the yellows of the original scene.

These negatives can be made directly from the subject or, as mentioned before, they can be made from a colored transparency that was exposed to the original scene. It is better from the color accuracy standpoint to operate directly from the subject; the best color prints are made that way. It is the easiest way to get started toward the goal of producing beautiful color prints.

### EQUIPMENT FOR COLOR SEPARATIONS

What apparatus is necessary?

**A CAMERA.** Any camera that will produce high-quality black-and-white negatives can be used for making separation negatives. A high-grade miniature, a hand camera with good lens and focusing arrangement, or a roll-film camera can be used.

The lens should be as good as the amateur can afford. It must be remembered that, not only must his images be sharp, but also the three separation, or partial, images must be of the same size. This means that the lens must have good color correction; other-

wise the red image will not focus at the same plane the blue image does, and one will be larger than the other. This will cause out-of-register troubles later on.

The shutter of the camera should be accurate and dependable. High-speed shutters are rarely needed or usable. If the shutter can be accurately timed, it is a better shutter for color than one that will expose a film for  $\frac{1}{1000}$  second. The Compur type of shutter produces good results; so does the focal-plane shutter used in miniature cameras.

Although separation negatives and prints can be made with inexpensive roll-film cameras, the amateur will find himself somewhat handicapped if he cannot focus his images accurately upon the plane of the film. This can be done either by the reflex type of camera, by a ground glass, or by the range-finder principle. The author has made good prints from 35-mm separations made in a camera of the Leica or Contax type.

The ideal camera, probably, is a 4 by 5 or 5 by 7 studio type mounted on a really rigid tripod. With such a camera the photographer can see his picture on the ground glass, full size although upside down. He can arrange his composition and determine the desired point of view and the depth of focus as he stops down the lens. A 4 by 5 studio camera will not cost the amateur very much, since he needs something that is sturdy and not fancy. He can dispense with trick swings and other devices that he will probably never use. The main thing is that it must not wobble all over the lot when a plate or film holder is changed and that, once the image is properly focused, nothing will move to destroy this image position.

**A TRIPOD.** This must be sturdy. Metal tripods of the amateur variety can be used, but they will probably drive the photographer mad before he gets very far. They simply are not steady enough. Remember that three shots are to be made, that three films or plates are to be used, and that the filter is to be changed three



times. Each of these operations involves the opportunity for moving the camera slightly. All three of the negatives must be exactly alike with respect to the point of view of the camera. Otherwise it will not be possible to get good register of the final prints, and fringes of color around the outlines of various objects will result.

The tripod will certainly cost more than \$10 and may easily cost more than the camera (not including the lens). Even the best tripod is inclined to be a bit rickety in some part or other, and every means should be taken to tighten it up so that the camera and the tripod are absolutely immovable once the desired focus is obtained. This means, also, that the ends of the legs should "grip" the floor and not tend to slide. The author has wasted film more than once, after two of three separations were properly made, when one of the tripod legs shifted position in removing the film holder in preparation for taking the third exposure, thereby necessitating starting all over from the beginning.

As far as rigidity is concerned, the small cameras have an advantage. It is easier to clamp them tightly to something. Roll-film cameras have an advantage in that there is no shifting of film or plateholders. But for really serious work a 4 by 5 studio camera can be beaten only by a 5 by 7 studio camera!

**FILTERS.** Photographers have accepted the Wratten A25 (red), B58 (green), and C5-47 (blue) filters as standard for separations made from the original subject. If transparencies are to be separated, other filters are used although those mentioned above may be suitable. For these special filters, see section dealing with separations from transparencies. There are numerous combinations of filters and films or plates that photographers have used to produce separation negatives, and the literature contains many references to such combinations.

An ideal set of filters and film would be one that would provide equal exposures for the three negatives. Defender has made an important step in this direction by supplying two sets of filters for

use with X-F pan film. Thus, the table below summarizes Defender's filters for separation work.

DEFENDER FILTERS FOR USE WITH X-F PAN

Standard Tricolor A	40-R	40-G	50-B	Correspond to Wratten A, B, and C5
Tricolor D	40-R	50-G	100-B	Provide 1:1:1 exposure ratios with daylight or daylight fluorescent illumination
Tricolor M	50-R	50-G	50-B	Provide 1:1:1 exposure ratios with Mazda illumination

Recommended filter factors are to be found with each batch of X-F pan film purchased. It must be noted that in all three cases above, the blue-filter negative must be developed longer than the other two to attain the same contrast. In general, this is true of all panchromatic emulsions. The additional development is of the order of 25 to 50 per cent.

Filters can be purchased in several forms. The simplest is sheets of gelatin. Such filters will cost about 10 cents per square inch or 40 cents each for a 2- by 2-inch filter. On the other hand, the manufacturer will also supply filters mounted between glass sheets or even between optical flats if the photographer wishes to have a deluxe set. There are certain advantages to working with raw filters—and, of course, there are disadvantages. One of the advantages is that there are no glass surfaces to reflect light, no chance of distorting the image because of the glass plates. Mounted filters, however, are not ruined by greasy fingers. Gelatin filters can be obtained with lacquered surfaces that resist finger marks and abrasion. (See the remarks on filters in Chapter III.) Lacquered gelatin filters can be wiped with a damp cloth or a water-alcohol solution (90 per cent water, 10 per cent alcohol) to clean them of fingerprints or other dirt. Strong solvents will damage the lacquer and must be avoided.

Whatever the filters the amateur buys, he must respect them, treat them with care. The whole process of making a fine color print by use of separation negatives starts with the proper use of proper filters, and there is no use in handicapping oneself at the start by attempting to use filters that have been smeared with finger marks or ruined by moisture.

**FILMS OR PLATES.** Although it is possible to use three different types of film for the three separations and although many photographers do so, the author strongly encourages the beginner to choose one good panchromatic film and to stick to it until he has failed or mastered the technique of making negatives for color printing. The author has used standard 35-mm film of all the manufacturers and has used standard sheet films such as Kodak Portrait pan, Kodak Super-XX, Kodak Tri-X, Ansco Isopan, and Defender X-F pan, plus some others, probably, whose names he has forgotten. Good separations can be made on any of them. In addition, he has used Wratten pan and Kodak Tri-X pan Type B plates. Each type of film must be mastered all by itself; experience with a different type is not of much help. This is a fact because each film has its own characteristics, some being more red-sensitive than others, some developing to a higher contrast than others. Some have a matte surface, which is a help when the time comes for spotting up small holes in the emulsion.

A good film or plate for separation work should have a long linear part to its characteristic curve; this means that it will not be one of the very contrasty emulsions. When exposed to a particular light source and developed in a certain way, the three tricolor curves of density versus exposure should match. At the time of writing, Kodak Super-XX sheet film and Kodak Tri-X pan Type B plates are specially adapted for separation negatives when processed as recommended by the manufacturer. See data to follow.

Film packs are not recommended in spite of the fact that some photographers use them. The author has found it too difficult to

get accurate register of the three images in the final stages of the color-print process when packs were employed. Note, however, that packs are employed successfully in the Curtis "One-shot" cameras. Special film holders make this possible.

There are many arguments pro and con on the question whether films or plates should be used. The author holds no brief for either; he has used both. Films are definitely easier to handle, the emulsions seem more uniform, because they are made in tremendous batches, all from the same chemical hopper, while fewer plates are made, and each plate must be carefully coated individually. If the films are handled with care (more care than is usually accorded black-and-white negatives) and with uniformity, there should not be the slightest trouble with them. Films are more readily obtainable, weigh less, and take up less room. After one has been in the color business for a year or so and has exposed several hundred sets of separation negatives (none of which he will ever throw away, no matter how poor they are), weight and storage space become matters of moment.

The preference of films over plates can be summed up as follows. Practically all films today are double-coated and have non-halation backing, giving great latitude in exposure. This means that the film has a long straight characteristic ideally made for color separation. It is worth noting that many of the leading color photographers and photomechanical workers (engravers) of the country use plates for making separations. Films do change size in processing and plates do not, but if the films are treated alike in all respects, even to hanging them from the same corner or edge in drying, they will change size uniformly.

**EXPOSURE METER.** The author could not get along without a good photoelectric exposure meter. It is granted that if the photographer makes his separations under identical conditions each time he goes to his studio, he may get along without the meter; but even those hard-boiled professionals who were very snippy about

exposure meters when they first became available now thank their stars that such instruments are available. Don't try color photography without one.

**GRAY SCALE.** Another vital accessory to color photography, one which can be made at home or which can be bought very cheap is a "gray scale." Briefly, this is simply a series of colorless or neutral gray sheets of cardboard ranging from pure white to jet black. One of these should be placed in every scene photographed if color prints are to be made later. Often this is difficult, especially when transparencies are made of landscapes, but on all studio setups there is little reason why a gray scale should not be included. It is of great help in judging success or failure in making the separation negatives. Eastman has them in several sizes, and the amateur should have several of each. Ask the dealer for Eastman Color Separation Guides.

A set of three color patches showing yellow, red, and blue, as well as black and white, is also helpful, especially in identifying the negatives and in judging the fidelity of the final color print. They are also useful if masking is employed, a method of correcting negatives and prints for color inaccuracies caused by the dyes employed in making transparencies or in making prints.

**ILLUMINATION.** Either daylight or artificial light can be employed, but it is not wise to mix them in the same scene. Artificial light is to be preferred to daylight since it can be directed and controlled in intensity. Daylight from a north window or from a skylight that does not admit the direct rays of the sun is excellent, but unless the negatives are developed a bit longer than usual the negatives and the prints tend to be a bit flat. This is because there are none of the small spots of bright color that are created by the direct rays from the sun or from an artificial lamp. On the other hand, flat lighting such as is produced by north light produces very light shadows, if any at all, and if the colors themselves are strong, excellent prints will result.

Direct sunlight can be used, but the photographer must learn to work very fast in changing films and filters, since each minute that transpires gives the sun time to change its position. Thus the illumination is not steady, the shadows increasing on one side of the picture and the illumination changing on the other. A gray, overcast day is excellent. The main trouble with daylight is simply this: the spectral composition of the illumination varies from moment to moment and from condition to condition. Thus a gray day differs from a day in which the sky is pure blue; direct sunlight is something else again. Thus it is most difficult to hit the proper exposures correctly for the three negatives. The author, however, has made some of his best color prints from subjects arranged in direct sunlight. The print of October Apples in this book was made this way.

**TIMER.** Modern panchromatic films are so fast that it is difficult to get exposures long enough to time accurately. If one uses a film with a meter setting of 100 and if he has a brightness reading of 13 on the scene, the basic exposure without filter at  $f/32$  is  $\frac{1}{2}$  second. If the proper filter exposure factor (filter factor) is 6, the exposure is only 3 seconds. An error of  $\frac{1}{2}$  second is not difficult to make with such a short exposure. This  $\frac{1}{2}$  second represents an error of about 15 per cent. Out of doors where there is much more light, or in the studio under illumination, the problem is enhanced.

The author has found that the electric timer he employs in making prints is useful in making negative exposures to artificial light. The timer is employed to turn the lights on and off. It must be admitted that some time is required for the lamps to light up and to die out, but the same time is required for each of the three negatives so that an unbalance does not occur from this situation.

One solution would be to use a neutral density filter—i.e., a filter neutral in color that merely attenuates the illumination. If this has a density of 1.0, it will cut out 90 per cent of the light so that the exposures can be increased by a factor of 10. Such a filter will make

a normal no-filter 3-second exposure require 30 seconds, a time duration that can be read accurately on a watch with a sweep second hand. Neutral density filters having densities of 0.7 (5 times exposure) and 1.0 (10 times exposure) are readily available. The electric timer will not work, however, out of doors, since it cannot be hitched to the shutter or to the sun!

One other point that is useful: speed ratings given by the manufacturers for their films can be halved without much chance of overexposure. Thus a film with a speed of 100 can be exposed at a speed of 50. As a matter of fact, it is more dangerous to underexpose separation negatives than to overexpose them.

The 3200°K lamps can be used for separations as well as for making transparencies.

### MAKING SEPARATIONS

Once you have a well-anchored camera, filters, film, and a scale of grays, you can get to work. As a starter, pick out a subject with definite and distinct colors. The old stand-bys are fruit and vegetables. Carrots are yellow and red, beets are red and blue, lemons are very yellow, oranges are red and yellow, carrot tops are green and yellow and blue. Choose a bowl with distinct colors; a background of a strong color is a good idea. A good blue will about complete the color range. Fruits are better than flowers because they are heavy and won't move in the wind if the work is being done out of doors—and they don't wilt!

Backgrounds can be cloth, sofa cushions, or cardboard (black, white, or gray). A good trick is to go to a store catering to artists and to buy a dozen sheets of colored paper. They cost about a nickel a sheet and a good assortment will always be useful. Remnants of silk, velvet, or other cloths can often be bought cheap.

Arrange the material so that the scale of grays and the color-separation guide (or some similar device) are in focus along with the fruit—or whatever the picture is to be. These accessory objects

should be at an edge of the picture so they can be removed from the print without damaging the image of the desired object. The scale of grays and the color chart can be stuck on a piece of wood with pins, stood up against some device, or stuck between the leaves of a book that is pushed into the scene.

Illuminate the scene with a lamp or two, having the source of light not far from the plane of the camera. See whether all parts of the scene are well illuminated, no deep shadows appearing anywhere. If deep shadows are present, they should be removed by spotlights or by reflectors. If several lights are used, it is a good plan to turn on one of them at a time to make sure that each contributes to the illumination. Do not, however, use sources of different spectral characteristics—daylight and Mazda, for example. With two lamps, have one close to the camera, the second having about twice the output of the first placed at the same distance from the subject but at an angle of 45 degrees to a line from the camera to the subject.

Now with the exposure meter explore the several parts of the scene and determine an average basic exposure. Write it down.\* If the exposure meter shows that various parts of the scene require widely different exposures, stop and reconsider. A photoelectric exposure meter is not uniformly sensitive to all colors and, therefore, will not give a uniform response, but if the exposure required for one portion of the scene is more than four to five times that required for another, the scene should be rearranged. More light should be brought to bear on the darker parts until the exposure is more uniform over the entire scene. A ratio of illumination of 3 to 1 is enough contrast, and although it might produce a flat monochrome, it will make a good color picture.

\* Right here is a good place to emphasize very strongly the desirability of keeping a good notebook. Write down everything you do—the kind of film, the exposures, the diaphragm opening, the kind and quantity of illumination—absolutely everything. Later you will learn how much to put down, but at the start it will pay to make notes on everything.



Now focus the camera (the entry into the making of separation negatives should be by means of a focusing type of camera), and arrange it with respect to the scene and to the lights so that a pleasing composition results. Use only one kind of light. Get the scale of grays and the color separation guide in the picture and be sure that it can be seen clearly in the ground glass or in the view finder. If the light reflects off it so that the individual steps cannot be seen, move it slightly until each step is clear. Try to use a scale large enough so that each step on the negative will be  $\frac{1}{4}$  inch wide.

Suppose, as a matter of illustration, that you are using photoflood light and a film for which the filter factors are approximately 5, 9, and 6 for the A, B, and C5 filters. Estimate the exposure required without the filter and multiply it by the filter factor. Make a test negative through the A filter, develop it, and fix it. The exposure should be such that details are present in both shadows and high lights. In order words, it should be a good negative.

As an example, suppose your exposure meter indicates 13 units of illumination, that the film has a rating of 100. Without the filter, this film will require an exposure of  $\frac{1}{6}$  second at  $f/16$ . Give the test A-filter negative an exposure of 1 second. If this is satisfactory, you know that the A-filter negative should be exposed, henceforth, at a meter setting of 20 rather than 100. This can be considered as its "speed" to the A filter. Whatever the meter indicates is the correct exposure for the A-filter negative; give the B and C5 negatives 1.8 and 1.2 times this exposure. These figures are arrived at simply. If the respective filter factors are 5, 9, and 6, divide all by 5, securing 1, 1.8, and 1.2. Now at a meter setting of 20, the filter factors are 1, 1.8, and 1.2, or at a meter setting of 100, the factors are 5, 9, and 6.

If you have a densitometer, try to get the minimum densities to have values of approximately 0.3. Remember that close-ups in which the subject is nearer than 8 times the focal length of the lens require longer exposures as indicated by the table on page 100.

**SMALL SIZE**

### **EASTMAN COLOR PATCHES**

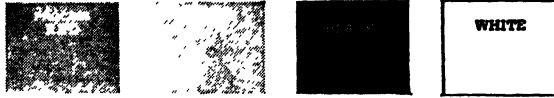

**SMALL SIZE**

### **REGISTER MARKS**



**SMALL SIZE**

### **EASTMAN GRAY SCALES**



Kodak accessories used as controls in color photography—gray scale, color patches, and register marks. They are made in several sizes, the largest being 15 inches long. Color patches are useful in identifying separation negatives. On the red-filter negative, the blue patch will be light, the others dark; on the green-filter negative, the red or magenta patch will be light; and on the blue-filter negative, the yellow patch will be light and the blue patch will be dark.



Decide on the order in which the films are to be exposed. It is a good plan always to use the same order; for example, let the red filter (A) be followed by the green (B) and then by the blue (C5). Sometimes you will forget which film is which and you may be able to distinguish the negatives by remembering the order in which you always work. Make the three exposures, noting down carefully the time. Change films and filters between each exposure. Be careful not to move the lights, the camera, or the subject during these exposures. If you use roll film, note down the number of the exposure on the film that corresponds to the A filter, the B filter, etc. If you use cut film, mark the placeholders on the outside "A," "B," and "C5."

If you use the Kodak Color Separation Guide with color patches of red, yellow, and blue, you can identify the negatives after they have been processed by the fact that the lightest patch on any negative will finally be printed in that color. Thus a negative in which the yellow and blue patches are dark and the red patch is light will be printed in red (magenta).

Another method of identifying the three negatives is to insert along an edge of the picture a black paper on which white, red, and yellow bars have been marked. When using this method, you will note that the red-filter negative will show three bars, the green-filter negative will show two bars, and the blue-filter negative one bar.

It is very important to establish a working routine and to stick to it. Remember that much of the work must be done in absolute darkness. There must be no question about which film is which, or what time is it and how long have the films been in the developer, or has the developer temperature changed, or where is this or that. There should be a place for everything and that place should always be used.

Now assume that the three films or plates have been exposed. The next job is to process them.

## *Development*

It is usually a good evening's work to arrange the scene and to make the three exposures. If only a few hours are available, the amateur should not try to expose and develop the films the same night. He should put off development until he is fresh and has thought out exactly what he is going to do once he gets into the darkroom and has turned out the lights. It is a good plan to rehearse with dummy films before the lights are out. Then any hitches in the procedure will have been worked out before the films have been removed from their protective holders.

It is a good axiom never to work with color processes when tired. There are too many things to go wrong, too much at stake. One small mistake and three films are ruined, three hours (probably) gone, and only a state of nerves left as the end product.

Separation films can be developed like any other negatives except that greater care must be exercised. The time and temperature must be under control. Any good developer can be used and it can be compounded at home or purchased in photographic supply houses. The author has used D-76, DK-50, DK-60a, 6-D, A-47, A-17, and other developers with complete success with larger films; and any of the fine-grain developers can be used with miniature films. Good negatives with little fog can be made with DK-50; D-76 will give finer grain. The formulas for these developers will be found below. The developers given here have been used with films of other makes than Eastman. The author recommends DK-50.

Miniature or roll films must be given identical development because they cannot be cut apart. Cut films and plates, however, can be given different development. The blue-filter negative should be developed about 25 to 50 per cent longer than the red- and green-filter negatives. This is because it takes this much longer to reach the same degree of contrast. The reason for this difference is the fact that the silver emulsion is somewhat more opaque to blue and violet light than to other colors. The author has made good

## NEGATIVE DEVELOPERS—AVOIRDUPOIS SYSTEM

<i>1 Quart (32 Ounces) Ounces and Grains</i>	<i>Eastman Kodak</i>			<i>AnSCO</i>		<i>Defender</i>	<i>Du Pont</i>
	<i>D-76</i>	<i>DK-50</i>	<i>DK-60a</i>	<i>A-47</i>	<i>A-17</i>	<i>6-D</i>	<i>ND-2</i>
Metol or Elon	29	37	37	22	23	29	36
Sodium sulfite	3 oz. 145 gr.	1 oz.	1 oz. 290 gr.	1½ oz.	2¾ oz.	3¼ oz.	2½ oz.
Hydroquinone	73	37	37	45	45	75	44
Sodium bisulfite	—	—	—	15	—	—	—
Sodium carbonate monohydrated	—	—	—	88½	—	½ oz.	—
Borax granular	29	—	—	—	45	29	73
Kodalk	—	145	290	—	—	—	—
Potassium bromide	—	7	7	12	7½	—	—

## NEGATIVE DEVELOPERS—METRIC SYSTEM

<i>1 liter (1,000 cc) Grams</i>	<i>Eastman Kodak</i>			<i>AnSCO</i>		<i>Defender</i>	<i>Du Pont</i>
	<i>D-76</i>	<i>DK-50</i>	<i>DK-60a</i>	<i>A-47</i>	<i>A-17</i>	<i>6-D</i>	<i>ND-2</i>
Metol or Elon	2	2.5	2.5	1.5	1.5	2	2.5
Sodium sulfite	100	30	50	42	80	91	75
Hydroquinone	5	2.5	2.5	3	3	5.75	3
Sodium bisulfite	—	—	—	1	—	—	—
Sodium carbonate monohydrated	—	—	—	5.75	—	14	—
Borax granular	2	—	—	—	3	2	5
Kodalk	—	10	20	—	—	—	—
Potassium bromide	—	0.5	0.5	0.75	0.5	—	—

prints from 35-mm film in which, perforce, each frame had as much development as the others; but the slight difference produced by developing the blue-filter negative a bit longer is worth it when possible.

The negatives can be developed in tray or tank. The main thing is to give them the required treatment, no more and no less than the times required at the proper temperature and with the proper agitation. If the darkroom has the proper temperature, say 68°F,

then the problem of development is greatly simplified, since the solutions will not tend to lose heat or to gain heat during the period in which the films are in the solution.

**EFFECT OF TEMPERATURE.** Temperature is most important. All developers speed up their job when the temperature is raised. The amount of the speed-up is a function of the developer formula and

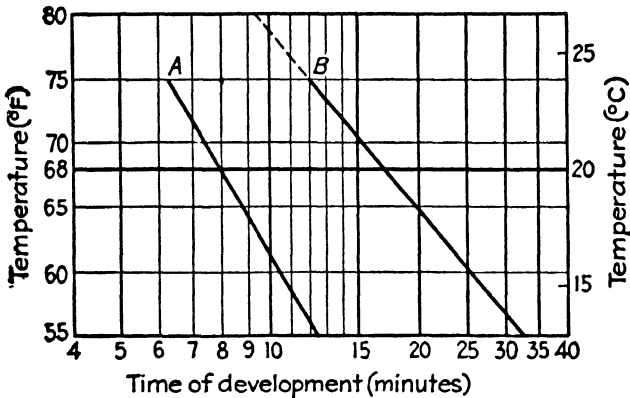

Time of development to produce a given contrast as a function of developer temperature. A — DK-50. B — DK-20, D-76, Microdol.

not a function of the film. Thus a curve can be plotted, or a table made, showing just how the time of development must be changed for each temperature. For example, from the time-temperature curve for DK-50 (see above), note that if 8 minutes are proper at 68°F, about 6¼ minutes are required at 75°F. Suppose, however, that you want the contrast produced in 5 minutes at 68°F and that the temperature is 75° F. What will the correct time be?

If 5 minutes is correct at 68°F, it will be less at 75°F in the same ratio that 6¼ is less than 8. Actually 6¼ is 78 per cent of 8, so the required time of development at 75°F, when the normal time is 5 minutes at 68°F, will be 78 per cent of 5, or 3.9 minutes, or 3 minutes 54 seconds.

If the temperature of the darkroom is above or below that at which the solution is to be used, it is necessary to work with large amounts of developer, so that a long time is required for the solution to change its temperature in accordance with that of the surrounding air, or to immerse the developing trays or tank in larger trays or tanks filled with water at the required temperature.

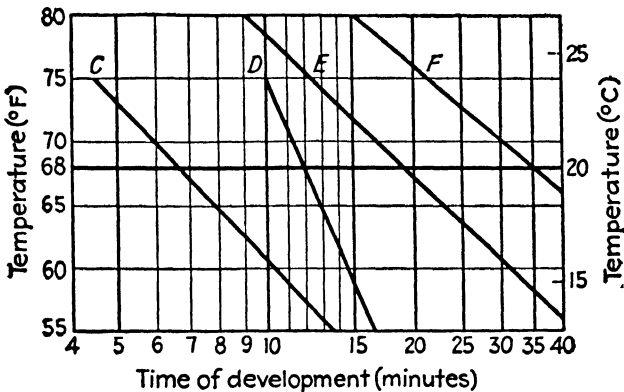

Development required at various temperatures to produce a given contrast. C — DK-60a. D — DK-50 (1:1). E — D-23. F — D-25.

In general, it is better to develop separation negatives one at a time in individual trays. In this manner the tray of the required size can be placed in a larger tray that is filled with water of the required temperature. If the whole setup is covered with a cardboard during the developing period, the solutions will lose or gain temperature more slowly since they will not be in contact with the room air.

Three 5 by 7 trays can be placed side by side in an 11 by 14 tray or one somewhat smaller. Another method of maintaining trays at the required temperature is to cut in a board holes large enough for the bottom of a tray to fit into. This board is floated in a sink full of water at the required temperature. Whatever the



method employed, it is essential that the temperature be maintained constant during the period the films are in the solution.

Of course, all three films can be developed in one tray, the photographer removing one from the bottom and putting it on top constantly during the development period. This method is acceptable provided the films do not get gouged full of small holes or scratched during the process. These holes or scratches will harass the life out of the worker later on in the print-making routine. Perfect negatives are the photographer's great aim, since he knows that poor negatives only result in future troubles.

If separate trays are employed, place the same amount of fresh developer in each tray, say 8 ounces for a 4 by 5 or 5 by 7 film. If only one film is to be developed in a single tray, use fresh solution and the same amount of it for each succeeding film. After the films have been removed from the developer, throw the solution away. Don't try to save money or solution by retaining used developer. This is one of the virtues of tray development. Just enough solution to cover the film is necessary.

Some workers tape the individual negatives to a glass plate that has about the same dimensions as the bottom of the tray. If two of the films can be pried loose easily in the darkness and in the developing solution so that the third can be given longer development, the method should work out quite well.

**LABEL THE FILMS.** It is most essential that the three films be marked so they can be identified both before they have gone into the developer and after they are dried and ready for printing. Some color workers clip the corners off the films with shears, one corner off for the red-filter negative, two corners off for the green-filter negative, and three corners off for the blue-filter negative. The author prefers to make small slits along one edge of the film to serve the same purpose. Fishing around in absolute darkness for the corner of a film, inserting this corner between the blades of the shears so that just enough and no more of the film is removed,

actually performing the cutting operation without taking a nick out of a finger—all this taxes the author's ability a bit too much. Small slits placed along one edge are much simpler to effect.

If an ordinary card punch with a circular or triangular hole is fixed in some way that makes it possible for the edge of the film to be placed within the punch jaws so that half circles or half triangles are made, a neat and effective identification is provided. In all such systems the author prefers to mark definitely each film—i.e., not mark two and leave one unmarked. A positive identification of some sort leaves no doubt at any time which film is which. The emulsion of a plate may be scratched in one corner or along one edge as a means of identification. The best method is to employ a color guide and to include it in every setup to be photographed.

Suppose, now, that you are ready to develop the films. You are in the darkroom, the shears are handy, the film holders are stacked up in the order you wish, so that you know which film is which, a film box is near by into which the films can be placed. Remove the red-filter negative, make a mark along one edge, place it in the empty box. Remove in succession the other two films, placing the blue-filter negative (which is going to require longer development) on top of the pile of three films. Close the box. Turn on the lights and bring the developer to the proper temperature. Place a tray of rinse water where it can be reached quickly when the films are removed from the developer. Beside it have a tray of fresh fixer.

Now comes the question of properly timing the development. The best way is to have an assistant. Stationed outside the darkroom he (or probably she) can advise when the required period is approaching an end so that the next move can be anticipated and prepared for.

Turn out the lights, uncover the film box, ask the assistant to tell you when 5 seconds before the beginning of a minute on his (or her) watch is reached. When this signal comes, get hold of the blue-filter negative by one corner, and when the next signal arrives, immerse

it quickly in the developer. After it is covered, lift it out of the solution so that it does not stick to the bottom of the tray. Lift it out once each minute and let it drain a second or two—or, if the system you prefer is to agitate the films constantly, begin the motion of the tray as soon as the film is properly covered and floating.

Suppose that the three films are to be developed as follows: the red- and green-filter negatives are to get 8 minutes, the blue-filter negative is to have 12 minutes. At the end of the fourth minute, after the blue-filter negative has been in the solution, immerse the other two films and continue the agitation decided upon.

Five or ten seconds before the end of the 12 minutes, the assistant should give warning. At that time you should locate the rinse tray and get hold of one of the films. When the time arrives, remove the films quickly one at a time from the developer and place them in the rinse. After a 10-second rinse, place them in the fixer and move them about for 5 minutes. Agitation in the fixer is important. Curb your curiosity until 10 minutes are up with an ordinary acid hypo bath or 5 minutes in a rapid fixer such as Kodak F-7. By this time the films should have cleared completely and you can take a look.

The fixing period is a good time for you to reload the film or plateholders, being sure that your hands are really dry and that there is no chance of your dropping some water or developer or fixer on the new films.

The films should be washed 20 minutes in an adequate supply of water. A half-dozen or so changes of water in a tray will do if running water is unavailable. Wipe off the backs and image sides of the films with a clean wet chamois or something similar, being careful not to scratch the film or to leave bits of the wiping agent on the surface. Dry them in a clean place and in a clean atmosphere. Every mechanical flaw that results from any of the processing steps will cause the photographer large doses of anguish later and will make him swear that he will take more care with the next batch of separations he has to develop.

Three 4 by 5 films can be developed in a single 8 by 10 tray by placing the films side by side and being careful that they do not wander over on top of each other. Once each minute each film should be lifted free from the developer and permitted to drain for a second or two.

In case no timekeeping assistant is available, some means must be handy within the darkroom for accurately timing the development. The author has found that a flashlight, the business end of which is covered with black paper in which a very small hole has been punched, can be used for looking at a clock or watch under the darkroom table where the direct rays of the light will not fall upon the developer tray. Another trick is to cover the developer tray with another and larger tray upside down so that an effective light trap is produced by the opposing sides of the two trays.

**TANK DEVELOPMENT.** If a tank is used for development, the technical details will differ. The films must be removed from their holders, marked for identification, placed in the developing hangers, lifted out of the developer at regular intervals, removed at the proper time, rinsed, and fixed. If only one tank is available, the films must be removed from their holders and rinsed and fixed in a tray or trays. The photographer can save himself some money in the purchase of tanks if he can get hold of glass battery jars or kitchen utensils of the proper dimensions. Three tanks will save much time, eliminate many chances of scratching or gouging the films, speed up the whole processing, and probably make it possible to get negatives that are in better balance, since the time of insertion into the developer and out of it may be controlled more accurately.

There is one great virtue in tank development. A tank holding a gallon of solution will hold its temperature much longer than 8 ounces of solution in a broad, flat tray. If the temperature varies during the development period, negatives are almost certain to be out of balance, a matter that will call for compensating adjustments later—adjustments that are a headache and a perpetual source of prints that miss the chance of being “perfect.”

Films up to 5 by 7 in size can be dried by hanging them from one corner by a clothespin. Larger films should be hung from two supports. It is rather important to hang all three films from the same corner or from the same edge, so that they dry alike. Similarly, if a developing tank is used, place the films in their hangers with the same orientation, preferably with the sky (in a landscape) downward. The films should not be dried in a vigorous blast of air at any temperature, and heat in drying is dangerous. A slow cool draft, absolutely clean, may be employed, but unless there is a great urgency to get the films ready for printing in the shortest possible time, give them 24 hours in a quiet, dust-free, cool room.

### *Notes on Processing Separation Negatives*

Making a color print is such a long process with so many individual steps, each of which may introduce small errors that only show up when the final print is made, that every part of the procedure must be carried out with great care. Since the separation negatives are the starting point of the process, troubles start with those that are almost impossible to discover visually. Some of the later faults in prints can be traced to the following errors, which occurred in making the separations.

1. Unevenly developed negatives.

These will cause streaks of color in the print. Uneven agitation and insertion of warm film holders or plates into cold developer, producing greater densities around the edges where the holders heated the developer, are two causes of uneven development.

2. Insufficient washing between development and fixation.

3. Insufficient agitation during fixation.

4. Use of exhausted fixer.

5. Exposure of the negatives to light before they are thoroughly fixed.

6. Insufficient or improper washing.

Panchromatic films and plates have dyes in them that may wash out unevenly unless plenty of washing is done. Bathing the films in wood alcohol for a few minutes will get rid of this dye quickly.

### 7. Improper drying.

Films should be hung from the same corner—*i.e.*, the images of all three negatives should face the same direction. Tendency to form drying marks can be minimized by bathing the films for 2 minutes in Kodak Photo-Flo after washing and before drying.

The color photographer must remember that he must use three negatives, all of which must be processed alike, whereas the black-and-white worker has only one negative to contend with. Every step in the color process has but one aim—to produce color. One bad negative out of the set of three makes all worthless.

The contrast (density range) of negatives, as well as the absolute values of densities, is controlled by the time of immersion in the developer, by the degree of agitation of the film during this time, and by the temperature of the developer. Old developer, which has been used before or which may never have been used but which has been allowed to sit around in a bottle, a tray, or a tank for some time, also controls negative densities; but in all color-separation work it is assumed that the developer is fresh or, if it has been used—in a tank, for example—that only a limited number of films have gone through it.

With a given developer and with given agitation, temperature and time are the controlling factors. Each of the three negatives must have the proper time in the developer and during this time the temperature must remain constant.

## REQUIREMENTS FOR SEPARATION NEGATIVES

All separation negatives possess two characteristics in common—the absolute densities and the density range. Both are important. The density range of the negatives must be within the limits of the printing process to be employed. The negative material employed should have a long straight characteristic expressing the relation between exposure and density. This calls for one of the fast panchromatic emulsions. Only the densities that fall on the straight-

line portion of the curve should be utilized if true representation of the originating light reflections is to be secured.

The lowest density that falls on the linear or straight part of the characteristic varies with different films but in general is of the order of 0.25 to 0.4. Thus the exposure of the negative to the subject must be such that a minimum density of, say, 0.30 should be attained. This density will represent the darkest shadow that is to be faithfully reproduced. All other negative densities, representing parts of the subject reflecting more light than the shadows, will be higher.

Suppose the printing medium requires that the negative density range be about 1.0—i.e., if the lowest density is 0.30, the greatest density (representing the brightest high light in which detail is to be reproduced) must be 1.30. If the negative material has a linear region to its characteristic that is greater than from 0.30 to 1.30, then the whole density range may be maintained at 1.0, but the absolute values of density may be increased, extending from 0.50 to 1.5 instead of from 0.3 to 1.3. The only difference will be that longer times will be required to expose these negatives to the printing medium for the same result. If one's printing light is such that very short exposures are required to properly expose the printing material, then the greater densities may be an advantage, since long exposures may be timed more accurately than short exposures. Aim for a minimum density of 0.3 to 0.4.

In any color process, it is a tremendous advantage for all three separation negatives to have the same absolute values of densities and the same density range when a neutral gray series of steps (gray scale) is photographed. Very few color photographers attain this ideal, but all wish they could. There is no doubt that many successful color prints are made from negatives that are out of balance, but more work is required and the chances of success are severely lessened by having to print from negatives that are not made as nearly alike as possible.

### *Separations for Dye Transfer Process*

In the Curtis Orthotone process and the Kodak Dye Transfer process (both of which are imbibition with variations) compensation can be made for negatives that are somewhat out of balance in density range. This is accomplished in developing the matrices. To the developer is added a contrast control solution, which affects the contrast of the matrices in accordance with the contrast of the negatives and the operator's wishes. Since contrast can be controlled in this manner, one need use only one set of dyes with a fixed amount of acid and adjust the matrices to fit the dyes.

This technique added to the straight imbibition method is a distinct asset. It is extremely difficult to make separation negatives that are in exact balance unless one has his work systematized and under complete control. This is especially true of the amateur who does not make negatives every day but only occasionally when he has the time or inclination.

This does not mean that you should not take every possible care to produce good negatives, well balanced with respect to each other and of proper contrast to fit the dyes. But the inevitable factors that affect negative contrast are always working against the happy situation of exactly correct records. Temperature changes, aging developer, variations in the time of development and in the amount of agitation during development, the scene that is being photographed—all these factors enter into the business of making separations.

### *Separations Direct from Subject*

In any separation process, no matter how the negatives are to be used, the scene should be well and rather evenly lighted. The illumination range should not be over 3 or 4 to 1. This is accomplished by having one light close to the camera and another about twice as strong placed at the same distance from the subject but at an angle of 45 degrees to a line running through subject and camera.



Having lighted the scene, anchored the camera, and composed the picture, you should proceed as follows. Expose a negative through the A filter using your best judgment as to exposure. After processing it, determine if it has the proper details in both shadows and high lights. It is recommended by Kodak that the minimum density of the negative, registering the deepest shadow of the subject, should be of the order of 0.3. This should be one point to aim at. The next point is to develop the negative so that the maximum density, representing the high light of the scene, should not be higher than about 2.0. This maximum value of density depends on the length of development, but it also depends on the scene and the manner in which it is illuminated.

For example, if you are photographing a single-plane black-and-white scene, illuminated as described above so that the maximum illumination is three times the minimum, and if you develop the negatives to a gamma of 0.9 (see table below), and if the minimum density is to be 0.3, what will be the maximum density?

The fundamental formula to solve all such problems is: negative density range = gamma times the logarithm of  $E_2/E_1$  or

$$\Delta D = \gamma \log_{10} E_2/E_1$$

where  $\Delta$  indicates "a change in" or the maximum density minus the minimum density.

$\gamma$  is gamma.

$E_2$  and  $E_1$  are, respectively, the greatest and least illumination on the scene.

In this case the situation works out as follows:

$$\begin{aligned} \Delta D &= 0.9 \log_{10} 3 \\ &= 0.9 \times 0.477 \\ &= 0.43 \\ D_{max} &= 0.43 + D_{min} \\ &= 0.43 + 0.3 \\ &= 0.73 \end{aligned}$$

This would be a soft negative by any standards.

In an actual scene, however, which is to be translated to a color print, there will undoubtedly be distinct planes, some of which may shade others, so that the minimum amounts of light sent to the camera by the scene will be considerably less than one-third the amount of light transmitted to the camera by the brightest part. Furthermore, there is the effect of color and the effect of filters on the colors. Some films will register a particular color quite strongly, whereas the other separations may have almost no deposit of silver in the portions represented by these colors.

The actual density range of a separation negative made under these conditions and developed to a gamma of 0.9 will probably be considerably beyond the 0.43 range indicated by the calculation shown above.

The point of the discussion is that if the scene is to be copied on separation negatives directly and not through the intermediate step of making a transparency, it should be softly lighted so that the density range finally produced on any one of the three separations will not exceed the maximum of about 2.0 minus the minimum of 0.3 even if part of that scene is shielded from the direct rays of any of the illuminating sources.

At any rate, after the illumination and development are such that the minimum density is of the order of 0.3 and the maximum is not over 2.0, then you may proceed to make the complete set of three separations. This does not mean that the density range should be 2.0 minus 0.3, but that, all things considered, these two extremes of density should not be exceeded in either direction. For carbonyl the density range should be about 1.0 or 1.2; for dye transfer it can be anything between 0.8 and 1.8. The following table from the bulletin *Separation Negatives for the Kodak Dye Transfer Process* gives the proper exposure ratios for the three negatives based on a 60-second exposure through the A filter.

## RECOMMENDED DEVELOPMENT

*Approximate gamma = 0.9*

Negative Material	Developer	Method	Approximate Development Time in Minutes at 68°F (20°C)		
			Red-filter Negative	Green-filter Negative	Blue-filter Negative
Super-XX Pan Sheet Film	DK-50 (1:1)	Tray*	6	6	8
		Tank†	8	8	11
Tri-X Pan Type B Plates	DK-50 (1:1)	Tray*	6	7	11
		Tank†	8	9	14

\* Continuous agitation.

† Agitation at 1-minute intervals during development.

## APPROXIMATE EXPOSURE RATIOS FOR COLOR-SEPARATION NEGATIVES

*Based on 60 seconds' exposure through the Wratten A Filter (No. 25)*

Negative Material	Tungsten*			Photoflood			White Flame Arc†		
	A	B	C5	A	B	C5	A	B	C5
Super-XX Pan Sheet Film	1.0	2.0	2.0	1.0	1.8	1.1	1.0	0.8	0.3
Tri-X Pan Type B Plates	1.0	2.9	2.0	1.0	2.1	1.1	1.0	1.3	0.3

\* Clear bulb, high efficiency.

† With anode in lower position.

In other words, you should illuminate the scene so that the A-filter negative will have a minimum density of about 0.3 when given a 60-second exposure. Then the other two negatives will require exposures 1.8 and 1.1 times this exposure if Super-XX film is used and if the scene is illuminated with flood lamps. If the scene cannot be so illuminated, either because there is not enough illumination available or because it is difficult to cut it down, then

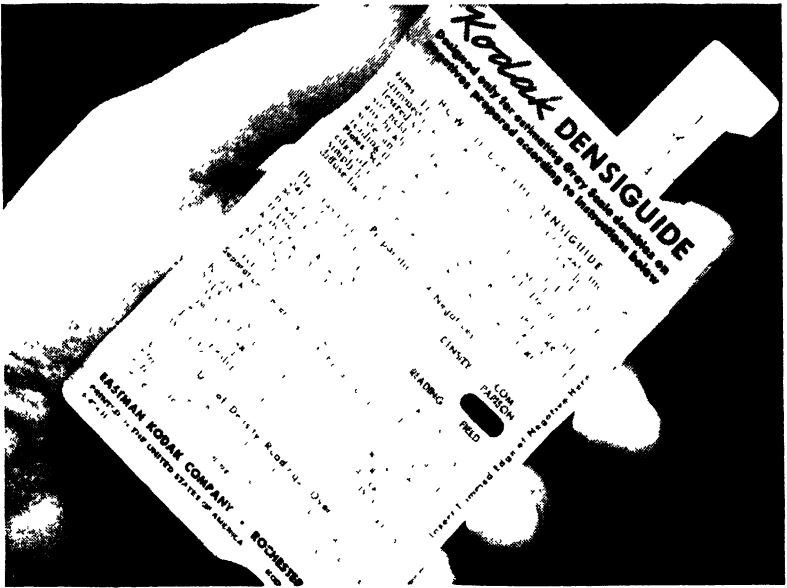

With a little practice, this simple densitometer device will enable the color photographer to reduce wastage and to produce better results when making prints from separation negatives. (Now called the Kodak Densiguide)



An example of the results produced by the Stripmeter. Several exposures are made on a single piece of film or paper and all, naturally, are developed exactly alike.



the exposure ratios will differ somewhat (due to what is known as "reciprocity failure") and the photographer must determine them for himself by one of the processes described below. These exposure ratios will provide a good jumping-off-place, at any rate. The author strongly recommends that the photographer procure from Eastman Kodak Company the bulletin *Color-Separation Negatives for the Kodak Dye Transfer Process* and get his start in making separation negatives by the methods recommended there. If other sensitive materials are to be employed, then the worker must find out much for himself.

### *Filter Factors*

Although each manufacturer gives multiplying factors for the tri-color separation filters, these are only approximate, and each photographer really must determine for himself the factors he must use. The table on page 168 gives certain data that will be helpful in getting started. After the first set of negatives is made, the worker can determine what must be done to perfect his technique and thereby obtain balanced negatives.

### *Are the Negatives Balanced?*

It is a good idea to curb one's natural impatience to look at the three films until they are thoroughly dry. Otherwise a bit of water under a film hanger may dribble over the film surface to cause a water spot in an important part of the picture.

Suppose, however, that everything is all right—films developed, fixed, washed, and dried. Now we can look them over. Take any two of them and inspect the scale of grays. Place one adjacent to the other and compare them. Is each step on one film as dark as it is on the other film? Do the two ends of the scale of gray for the two films correspond in density—i.e., is the light end the same density in the two films and, at the same time, has the dark end the same density? Do the same with the third film,

## FILTER FACTORS FOR SEPARATION NEGATIVES

Sheet Film	Filter Factor						Exposure Index	
	Sunlight			Tungsten			Day-light	Tungsten
	A	B	C5	A	B	C5		
Kodak Tri-X	6	10	5	3	10	10	200	160
Kodak Super-XX	8	8	5	4	8	10	100	64
Kodak Panatomic-X	1.0	1.8	1.1*	1.0	2.0	2.0†		
Kodak Plus-X (35 mm)	8	8	5	4	8	10	32	20
Kodak Portrait Pan	8	8	5	4	8	10	50	32
Defender X-F Pan	9	8	5.6	4	5	6	50	32
Anso Isopan‡	9	15	7	6	8	8	50	32
Defender X-F Pan§	9	9	9	13	13	13	50	32
<i>Plates</i>								
Kodak Tri-X Type B	8	8	4	5	8	8	160	100
	1.0	2.1	1.1	1.0	2.9	2.0¶		
Kodak Panchromatic	8	8	5	4	8	10	16	10
	1.0	1.2	2.0**	1.0	1.6	3.4††		

*Note.* These are manufacturers' ratings and where noted take into account the fact that all negatives of a set may have to be developed for different times to secure equal contrast. In the other cases it is not known if this has been taken into account in estimating the exposure ratios.

\* Photoflood. For other conditions see Note †.

† Clear bulb, high efficiency. Based on 60-second exposure through A filter. Develop in DK-50 (1:1) in tray 6, 6, and 8 minutes at 68°F. In tank agitated once each minute develop 8, 8, and 11 minutes.

‡ These factors are intended specifically for separation negatives developed in trays in Anso 17 at 68°F for the following times: A, 7¼ minutes; B, 7½ minutes; C5, 8½ minutes.

§ Defender 40-R, 50-G, 100-B filters for daylight or daylight fluorescent lamps; 50-R, 50-G, 50-B for Mazda lighting. Develop blue-filter negative 25 per cent longer than the others.

|| Photoflood. See Note ¶.

¶ Clear bulb, high efficiency. Develop in DK-50 (1:1) in tray with continuous agitation, 6, 7, and 11 minutes at 68°F; in tank with agitation at 1-minute intervals, 8, 9, and 14 minutes.

\*\* Photoflood. See Note ††.

†† Clear bulb, high efficiency. Develop in D-11 (1:1) in tray with continuous agitation 2½, 2½, and 3 minutes at 68°F; in tank with agitation at 1-minute intervals 3, 3, and 4 minutes.

If all three correspond, you have met the requirement for properly matched negatives. No amount of inspection of parts of the negatives corresponding to colored portions of the original scene will tell you whether you have used the proper filter factors or not, because each filter will affect each color in the scene differently. Here is the reason for using a neutral gray; all the color filters act upon it alike, the red filter no more and no less than the blue.

If the films have been developed to the same degree of contrast and if the exposure has been proper, taking into account the filter, film, and the source of light, then Step 1 of any one of the scales will look like Step 1 of the other two negatives; so will each of the other gray-scale steps. If the scales do not match, something went wrong. If the individual steps of one negative are each darker than those of another negative, that film got more exposure than was desired. Either the filter factors were not quite right for the films being used or the assistant got confused in his (or her) timekeeping. If, however, the light end of the two scales is the same while there is a progressively greater departure from similarity as you look at the darker ends of the scales, then the darker film had a too-long development—or the developer warmed up when this film was in it. It has a higher contrast.

It is difficult to judge the scales of gray by looking at the negatives, and there is always the chance of injuring the negatives with fingerprints or by scratching them. The way to handle this difficulty is to make contact or projection prints of the scales, giving them exactly the same exposure and development. The prints can then be laid alongside each other and can be studied at leisure and in safety.

It is somewhat more important for negatives to match in the more dense portions, since these represent high lights in the final print and color unbalances are more important in these lighter print portions. But the more dense ends of the scales of gray on the negatives are more difficult to match, visually, because less light



gets through and the eye is not so sensitive. The solution is to print the scales on contrast paper, giving each exactly the same exposure and development as the others. Now these positive prints can be laid alongside each other for visual inspection. The high-light portions of the gray scales now will be light instead of dark, so that they may be matched much more easily.

If it is found that they do not match, then try printing the denser negative a bit longer and experiment in this manner until the three prints on contrast paper do match. Then the exposure times required to bring about this match are a very good measure of the relative exposure times that will be required when printing these negatives on the color material. If the scales of gray on the first attempt match pretty well, all is well. You can write up your notes and go back to them later when you are about to "separate" again.

Suppose the first negatives come out well. Make black-and-white prints from them. Study them closely. See what the red, the green, and the blue filters did to the picture. Note how the three negatives differ; get used to looking at separation negatives and to seeing that a red filter will cause the negative to be denser in the red portion of the scene, lighter in the others. Remember that in the subsequent positive process the complementary color will be used. Then the red-filter negative will be printed blue-green and the parts of the scene where there was little red will be light in the negative, dark in the positive. Thus if the positives are dyed, dark positive portions will take more blue-green dye. If there was much red in the original, the negative will be dark, the positive light, and the A-filter positive will not take up much blue-green dye.

It must be borne in mind that few colors are pure. What looks to be a good healthy red may turn out to have both yellow and green in it. Therefore, looking at the separation negatives, one might assume that no separation had taken place. All three negatives look alike. This is particularly true of scenery and is the reason

for starting with a subject having definite colors. The separation negatives of some subjects may look alike, but each will have certain definite differences, perhaps imperceptible to the eye. When printed, each positive will contribute some color to the final picture and a good print will be obtained when the contributions made by each negative are exactly correct. This is the reason for the insistence on matched scales of gray.

Remembering that in making prints from negatives, there is a reversal of the light and dark portions, one may look at the red filter as the device that makes it possible to record blue-green, at the green filter as the device that makes it possible to record magenta, and at the blue filter as the device that enables the photographer to impress on his sensitive materials the yellows of the original subject. Looked at in this manner, the negative is merely a necessary but bothersome step that, because of certain natural phenomena, seems to have its light and dark parts reversed when compared to the original scene.

The author does not wish to overwork his advice to the photographer that he learn how to make the best possible negatives. Color prints can be made from negatives that are far from perfect, but it is much more difficult to make a good print from passable negatives than from perfect negatives. As a matter of fact, very good prints can be made from negatives that do not match, and this is fortunate, since the average photographer's first efforts are most likely to be produced from negatives that are far from ideal. Some professionals have never learned how to make matched sets of separations, but their technicians have produced quite salable prints from them.

Do not worry too much about perfection at the beginning. The thing to do is to make a start but not to make the same mistakes twice. As one's critical judgment grows and he realizes that what looked like a perfect print at the beginning now looks pretty bad, his technique should improve simultaneously.

### AIDS TO SEPARATION MAKING

A densitometer is very useful to the color photographer, but such an instrument is beyond the financial means of many amateurs. Fortunately Eastman Kodak has brought out a simple and inexpensive (\$1) aid that helps out very much if a densitometer cannot be purchased or built. This is the device called a Density Kodaguide, and it is made up of a calibrated density strip that is movable across half of a slit in a piece of cardboard. Across the other half of the slit can be placed the densities of a gray scale occupying one edge of a separation negative. The desired step of the negative gray scale is made to occupy its half of the slit; then the calibrated gray scale of the density guide is adjusted until, visually, the two densities match. The unknown density can then be read from the guide.

The author has used such a guide with good results. It is not too easy to read the higher densities, but even at that, he has found that his readings with the density guide will check those of a Capstaff-Purdy density guide with considerable accuracy. Thus for \$1 the photographer can measure the densities of his films—provided the desired densities are along one edge of the film or plate—with sufficient accuracy for all except the most precise work.

Eastman has another useful gadget—the Kodak Print-exposure Computer. This is a circular slide rule correlating such factors as degree of enlargement or reduction, negative density, exposure, and lens aperture. The computer can be employed in making monochrome prints or in color printing. The combination of density guide and exposure computer eliminate all need for density-opacity tables, logarithms, and all such confusing apparatus.

The exposure computer will be useful if separation negatives of varying degrees of enlargement are to be made. Thus, if it is decided to make a set of negatives enlarged, say, three times, and if correct exposure has been obtained for such an enlargement, any other degree of enlargement will necessitate some adjustment in the printing times. While one can calibrate his enlarger, as

described under the chapter on print making, a computer will do all of the work for him.

Another device that became available late in 1946 is the Stripmeter (Ciné-Pro Corporation), a means for producing five test strips side by side on a single piece of paper or film  $2\frac{1}{4}$  by 5 inches in size, each test being made from the same portion of the negative and each step having a number automatically printed on it so that the individual strips can be identified. In operation, a portion of the negative is selected that has a high light or other portion that is considered as critical. This part of the negative is focused on the slit in the Stripmeter by projection. Then the paper or film is inserted and an exposure made that one guesses is correct.

Pushing a button automatically brings the next test strip into place, whereupon an exposure somewhat different from the first can be given. In all, five tests are possible. When the  $2\frac{1}{4}$ -by 5-inch film or paper is processed, the correct exposure can be selected. This device will save a great amount of time both in determining correct filter factors and in printing on the final color material from one of the separation negatives. By use of the Stripmeter one is sure that all tests have exactly the same processing and end point, which is not at all certain when the individual tests are developed separately.

Although densitometers are rather out of reach, economically, of the average amateur, a serious color photographer will find them to be of great value. Two general types are available, one operating on purely optical principles, the other operating on electronic principles.

The first instrument consists of a light source, a circular gray scale with a continuously varying density instead of the variations of density being arranged in steps. The negative to be measured is placed over the light source so that the amount of light that gets through the negative is less than what shines on the negative. Part of the illumination from the lamp is arranged to be brought to the

eye in such a way that the circular gray wedge can be interposed between the light source and the eye. At the same time the illumination that gets through the unknown density of the negative is brought to the eye. By rotating the circular calibrated gray wedge, an adjustment of the latter will be obtained in which the illumination that gets through the negative is exactly equal to that which gets through the calibrated wedge. At this point the two densities—i.e., that of the negative and that of the gray wedge—are equal. The Eastman Capstaff-Purdy densitometer is of this type.

Weston Electrical Instrument Company placed an electronic densitometer on the photographic market in 1947 that makes it possible to measure densities without any of the light-balancing technique that characterizes the visual or optical instruments. In using the Weston densitometer, the negative to be measured is placed between a light source and a photoelectric cell. The amount of current passed by the cell under the stimulation of the light getting through the negative is read directly on a meter scale.

Either of these instruments will cost as much as a good camera, but both are very valuable aids to color photography. It is probable that they will pay for themselves through savings in time and materials.

Another inexpensive and very useful instrument is the enlarging photometer, a modern version of the grease-spot light-measuring instrument employed in every high-school and college course in physics. Haynes Models J-3 and K-2 are equipped with a density scale, which makes them useful as direct-reading densitometers. *The Enlarging Photometer Handbook* by A. J. Haynes (Peerless Photo Products, Inc.) gives very useful information on the use of these devices both in color and in black-and-white photography.

### A Homemade Densitometer

Few photographers will be able to consider the densitometer as anything but a complete luxury. If, however, you can get hold of a common light meter, say one that has a maximum scale reading

of 50 lumens and is designed for measuring room illumination, you can make a device that will help materially in getting better color results. Not only will you be able to make better negatives but also you will arrive at proper printing exposures from these negatives much more quickly and more accurately than by any other means.

With such an illumination meter, make a mask with a square hole  $\frac{1}{4}$  inch on a side and mount it over the light-sensitive surface of the meter. If the meter is held a foot or so from a 60-watt lamp, the meter needle should read full scale. Interpose a negative between the lamp and the meter. You will note that the reading will decrease.

The gray-scale steps on the negatives should be  $\frac{1}{4}$  inch or a little wider in dimension, and means should be provided for maintaining the relative positions of the lamp and the meter accurately. The worker must be certain that the hole in the mask is completely covered by the density to be measured.

If the meter reads 50 full scale, when no density is between meter and lamp, then any other reading when doubled will give directly the percentage transmission. Thus if a gray-scale step interposed between the light source and the mask causes a reading of 30, the amount of light getting through the film is  $\frac{30}{50}$  of the light that gets through in the absence of any density. A ratio of  $\frac{30}{50}$  is the same as  $\frac{60}{100}$ , or in this case the percentage transmission is 60 per cent. A trial set of separation negatives might give a set of figures as follows.

PERCENTAGE TRANSMISSION

<i>Step</i>	<i>A Negative</i>	<i>B Negative</i>	<i>C Negative</i>
1	70	74	60
2	56	56	40
3	39	37	28
4	18	21	16
5	9	10	7
6	5	6	4
7	4	4.5	3

These figures should be plotted on paper that has a logarithmic scale vertically as shown, or if paper in which both scales are linear is available, the figures in the table must be divided into 1, the logarithms of the resulting numbers must be looked up in a log

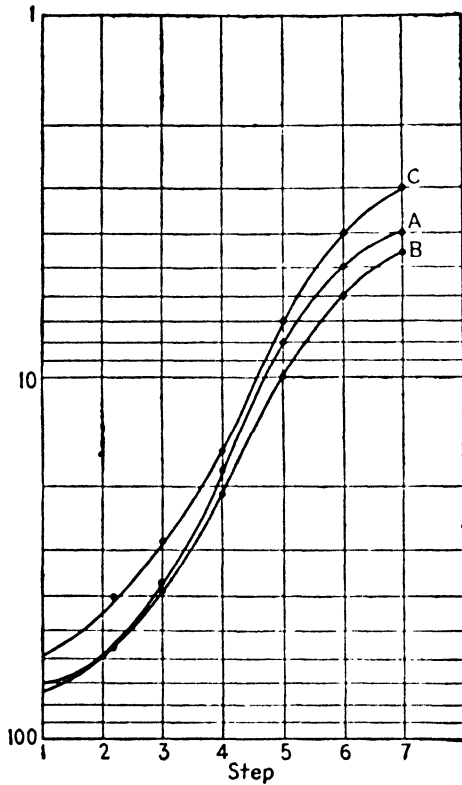

Typical curves obtained by use of an illumination meter as a means of measuring percentage transmission (vertical scale) of negatives.

table, and these figures plotted. Remember that 70 per cent transmission is actually a transmission of 0.70, that density is the logarithm of the opacity, which is equal to  $1/T$ , where  $T$  is the transmission. At any rate, from such a meter and such a set of figures a

curve can be drawn in which the vertical scale represents density directly or something proportional to density.

The 1946 General Electric Photo Data Book gives directions for using a GE exposure meter as a means of measuring negative densities. A mask is made for the meter having a hole  $\frac{1}{4}$  inch in diameter in it. The meter with mask in place is located under a lamp at such a distance that full-scale reading of the meter is secured. This will be 70 foot-candles. Now the negative is interposed between the mask and the light source and a new reading is obtained. The following table gives the densities in terms of the readings obtained in the manner described above.

<i>Meter Reading with Mask</i>	<i>Density</i>	<i>Meter Reading with Mask</i>	<i>Density</i>
0.5	2.14	15	0.67
1	1.84	16	0.63
2	1.54	17	0.61
3	1.36	18	0.57
4	1.23	20	0.55
5	1.14	25	0.44
6	1.07	30	0.37
7	1.00	35	0.30
8	0.93	40	0.23
9	0.88	45	0.17
10	0.84	50	0.14
11	0.81	55	0.07
12	0.76	60	0.04
13	0.75	65	0.01
14	0.69	70	0.00

The GE meter has a linear scale, so it is easy to estimate the number of foot-candles of illumination entering the sensitive surface when the needle falls between scale markings.

Once one has such a set of measured transmissions or densities and has plotted a curve, what can he learn from the data?

First of all, if the separation negatives were perfect, the three curves representing the percentage transmission of each step of



the three negatives would lie on top of each other, indicating that corresponding steps of the negatives had exactly the same density. This would mean that the exposure for the three negatives had been correct and, furthermore, that the individual negatives had been correctly developed.

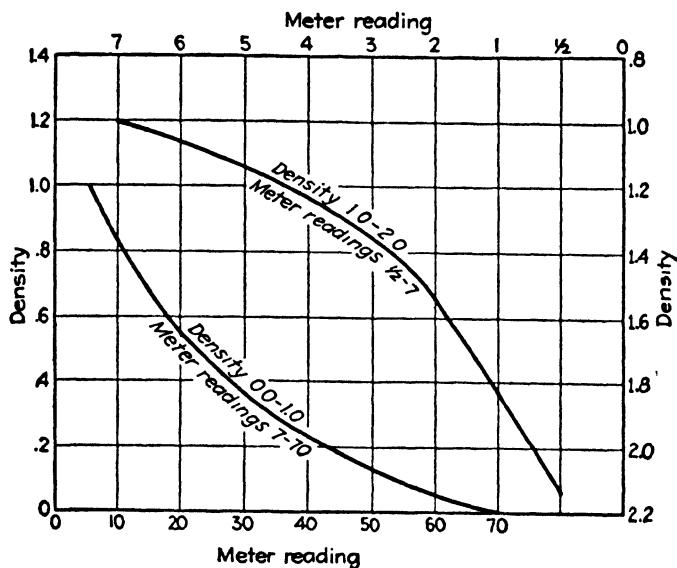

Calibration of the General Electric exposure meter used as a densitometer. The right-hand vertical scale corresponds to the upper curve.

If the curves do not overlap but are parallel, the exposures were incorrect with respect to each other. If the curves are not parallel, the development was incorrect. Use of this data for correcting the faulty practice is described later.

### A Homemade Gray Scale

Although gray scales can be purchased, there is no reason why the amateur cannot make his own. In fact, it is useful to have a number of them in different sizes. If he is to take a picture of a

house, the gray scale he uses for small still-life setups will be invisible in his negatives. He must have a good big scale of grays, and this he must make for himself.

Any bromide or contact paper can be used, even if old. As long as it will turn black on exposure and development, it will make a good scale of gray. Take a small sheet of paper and by test determine how much exposure it requires to turn it good and black. Say it is 60 seconds. Place a large sheet, say 8 by 10 inches, with respect to the source of light, which may be a 40-watt lamp, so that about this value of exposure will turn it black. Cover the paper with some sort of protection against the light, say a sheet of cardboard or black paper. Remove the cardboard from the first 1 or 1½ inches of the bromide (or contact paper). Give it 10 seconds exposure. Then uncover the next inch or so and give 10 seconds more. Continue until you have six or seven steps. Do not expose the last portion but develop the entire sheet without further exposure. The final inch will have no exposure and should be white, the next portion will have 10 seconds, the next 20 seconds, and so on. The other end of the sheet will be fully exposed and should turn out black. The definite boundaries between each step are an aid in lining up the scales on negatives later on. The 8- by 10-inch sheet can be cut into strips 2 inches wide for use in a setup.

If a large object, such as a house, is to be photographed by color separation, much larger scales are necessary. Here it is a good plan to use pieces of 4- by 5-inch paper for each step, finally mounting the six or seven steps on cardboard or tacking them on a board that can be placed somewhere in the scene to be photographed.

If transparent scales of gray are required, as they will be when making separation negatives from transparencies, it is probably easier to photograph a scale made in the manner outlined here than to attempt to make it directly on the film to be used.

As will be seen later, it is wise to use as large scales of gray as possible. If, on a 9- by 12-cm film, or larger sizes, the individual

steps of the gray scale can be  $\frac{1}{4}$  inch wide, it will be easier to compare them. If actual quantitative measurements are to be made by some sort of densitometer, these larger steps will be a distinct aid. With small film it will not be possible to make the individual steps so large, and they may have to be printed by projection up to a size that enables comparison to be made easily.

For making separations from transparencies, a transparent gray scale is necessary. This is a film with steps of increasing density from clear film to whatever maximum density is required. A slow negative material, such as a process film, should be employed. For example, a test piece of Ansco Process film may be exposed to a 10-watt lamp about 15 feet distant for the proper time to produce a very light fog on development. Using this as a basis, arrange a new film so that additional exposures, each double that of the preceding exposure, can be made until about eight or ten steps have been exposed. Develop in Ansco 17 for 8 minutes at 68°F with regular agitation of 30 rocks per minute. If an entire 4 by 5 or 5 by 7 sheet is exposed in this manner, strips of whatever width is required can be cut. If the gray scale is to be used with 35-mm transparencies, greater mechanical precision will be required to produce the final film within the required small dimensions.

Since film gray scales cost so little, it is much better to buy them than to go to the bother of making them. Such scales can be purchased in several sizes and density ranges.

### *Densitometry*

A color photographer need not have much knowledge about density and gamma and other matters of rather high technicality, but it helps. At least if he has a knowledge of such matters and has some means of measuring the density of his negatives, he will be in much better condition to remedy things if his prints are not so good as he thinks they should be. Such knowledge, gathered by means of a densitometer, can save him endless time in cut-and-try methods of

finding sources of trouble by pointing directly to possible sources and eliminating others.

Density (and what it is) has already been discussed, but it will not hurt to review it briefly.

When photographic material is exposed to light, something happens to the emulsion so that when it is developed, a deposit of silver exists where the light struck the material. Furthermore, the more light for a given length of time or the longer the exposure to a given light source, the greater will be the deposit of silver. In addition, the developing conditions under which the material was processed have some bearing on the amount of silver deposited.

Wherever there is silver, the material, a film perhaps, will look darker than where there is no silver. The more silver there is, the less light gets through the film when it is viewed against a light source, and the less light that gets through, the darker the film looks. It is said to be "denser." It prevents more of the light from getting through an otherwise transparent film. Density is a technical term and is a measure of the amount of silver and hence of the light-stopping power of the silver image.

Suppose a given exposure and development produce such an amount of silver that only one-tenth of the incident light gets through the processed film. Nine-tenths of the light is absorbed by the silver. If you expose another piece of film in exactly the same way, develop it exactly the same way, and then superimpose the two films, how much light will get through the combination? The first film stops all but one-tenth, or stated in another way, it transmits 10 per cent of the light. The second film also transmits only one-tenth, or 10 per cent, of the light that may be incident on it. When the two films are placed together and viewed against the light, only 10 per cent of what the first film passes will get through the second film. This is only 1 per cent of the amount of light that falls on the first film, because one-tenth of 10 per cent is 1 per cent.

Now, for matters of convenience, it can be stated that a film that passes 10 per cent of the light that falls on it has a density of 1. Each piece of film, therefore, has a density of 1, and the combination of the two has a density of 2. Therefore it can be stated that a film with a density of 1 passes 10 per cent of the light and that a film with a density of 2 passes 1 per cent of the light. All the rest is absorbed by the silver in the photographic image. A density of 2.0 means that 99 per cent of the light is absorbed by the silver.

Now note that the percentages of transmission must be multiplied to determine the final amount of light getting through the combined films; whereas, the densities can be added. This is an advantage of speaking in terms of densities rather than in percentages of light transmitted or absorbed. Densities can be added or subtracted; transmission percentages must be multiplied or divided.

If a given exposure produces a density of 1, the exposure to produce a density of 2 must be increased, naturally; but one cannot know the required increase until he knows how both exposure and development control density.

Now look at the matter in a slightly different way and all the facts will be in front of you. The exposure that produces a density of 1 produces enough silver in the film so that 10 per cent of the light falling on one surface gets through to the other surface. All the rest is stopped by the film. It may be said that the film is rather opaque or that it has a certain "opacity."

Technically the opacity is the ratio between the incident light and the light that gets through; in this case the opacity is 10, since the incident light is ten times greater than the light that gets through. On the other hand, the "transmission" of the film is the ratio the other way around—i.e., the ratio of the light that gets through to the light that falls on the film. Opacity values are always greater than 1; transmission is always less than 1; percentage transmission is simply the actual transmission multiplied by 100 per cent and is always less than 100.



*A full-fledged optical densitometer. In practice, the photographer matches the density of a negative to a known density quickly and easily.*



Since, in the case of an average film, very long exposures may be necessary to produce densities of 1, 2, or more and since the values of opacity can be between 1 and perhaps 100 or 1,000, it has been found easier to use the term density in place of opacity and to use the logarithm of exposures rather than the exposures directly. When density and log exposures are employed, it will be found that most films have certain portions of their characteristic curves that are linear, and these parts of the curves are employed in making separation negatives.

Density, as a matter of fact, is the logarithm to the base 10 of the opacity. The values in the table below are close enough to exact values to be useful.

<i>Number</i>	<i>Logarithm</i>	<i>Number</i>	<i>Logarithm</i>
1.0	0.0	8.0	0.9
2.0	0.3	9.0	0.95
3.0	0.5	10.0	1.0
4.0	0.6	30.0	1.5
5.0	0.7	60.0	1.8
6.0	0.8	100.0	2.0
7.0	0.85	200.0	2.3

The table shows the relation between numbers from 1 to 10 and their logarithms and then a few larger numbers to indicate how this logarithm business works. The color photographer will seldom have to worry about densities (logarithms of opacities) greater than 2 (opacities greater than 100 or percentage transmission less than 1). Thus, if he can memorize or make a table of the logs of numbers up to 10, he can handle all numbers he is likely to have to deal with.

Since all numbers between 10 and 100 have logs between 1 and 2, just as all numbers between 1 and 10 have logs between zero and 1, it seems that there is some recurrent set of values that indicates the logs of numbers between these two sets of limits.

This is a fact. For example, the log of 4 is 0.6 and the log of 40 is 1.6. The 1 indicates that the number (40) is between 10 and 100



and the 0.6 indicates where in this region the number lies. Another way of looking at the matter is that when one multiplies two numbers, he adds their logarithms. Thus 40 is equal to 10 times 4, and the log of 40, therefore, is the log of 10 plus the log of 4, or 1 plus 0.6, or 1.6. On the other hand, if the number is 400, the log will be 2.6, since the log of 100 is 2 and the log of 4 is 0.6.

To get the ratio of two numbers—i.e., to divide one by the other—you subtract their logarithms and then look up the result to see what number this new log corresponds to.

How are you to use such a set of data?

Suppose that you have made a set of separation negatives and that prints on any medium are to be made from these negatives. If the negatives are "balanced," a certain gray part of the original subject should have equal densities on each negative and thus will require equal printing exposure to the printing material. If, however, the negatives are not balanced—and this is usually the case—then how are you to know how to expose the printing material to them? Suppose that on one negative the density corresponding to the given gray portion of the original subject is 1.3 and that on another of the negatives the density is 1.6. By trial and error it is determined that the negative with a density of 1.3 in the selected portion requires an exposure of 18 seconds to the printing medium. Since the second negative is denser than the first, it will require greater exposure.

What you want is the ratio between amounts of light that get through the two films. From this you can calculate the two exposures. Remembering that the ratio between two numbers can be represented by the difference of their logs, you subtract 1.3 from 1.6, getting 0.3. Looking this number up in your table, you find that it is the log of 2. The ratio between the two required exposures is, then, 2, and so the denser negative must be exposed to the printing medium twice as long as the less dense negative to achieve the same result.

Why should this be so? Remember that the density is the log of the opacity, that opacity is a measure of the light-stopping power of the silver, and that the opacity is actually the ratio between the amount of light falling on one surface of a film and the light that gets through it. A density of 1.3 corresponds to an opacity of 20—i.e.,  $\frac{1}{20}$  of the light gets through the film—and a density of 1.6 represents an opacity of 40. If the film having an opacity of 20 requires an exposure of 18 seconds, it is obvious that a film with twice the light-absorbing power will require twice 18, or 36, seconds to produce the same result.

It really matters little how you calibrate your device for measuring film light-stopping power—whether it is calibrated in opacity, light transmission, or density. It is customary in the photographic field to use densities, and after you get used to the manner in which the set of values is employed, you can forget all about the whys and wherefores.

Knowing the densities of two films, to determine the ratio of exposures required to produce equal effects from them you subtract the densities, look up the result in a table, and multiply this result by the exposure required for the less dense negative to find the time of exposure required for the dense negative.

These various factors of opacity, transmission, percentage transmission, and density are related as follows:

$$\text{Opacity: } O = \frac{\text{light on film}}{\text{light getting through film}} = \frac{1}{T}$$

$$\text{Transmission: } T = \frac{\text{light getting through film}}{\text{light on film}} = \frac{1}{O}$$

$$\text{Density: } D = \log_{10} O \\ = \log_{10} 1/T$$

$$\text{Percentage transmission} = T \times 100 \text{ per cent}$$

Opacity is always greater than 1.

Transmission is always less than 1.

Percentage transmission is 100 or less.

Density has values from 0 to 3 or higher.

CONVERSION TABLE

<i>Opacity</i>	<i>Density</i>	<i>Opacity</i>	<i>Density</i>
1,000	3.0	10	1.0
900	2.95	9	0.95
800	2.9	8	0.9
700	2.85	7	0.85
600	2.8	6	0.8
500	2.8	5	0.7
400	2.6	4	0.6
300	2.5	3	0.5
250	2.4	2.5	0.4
200	2.3	2.0	0.3
150	2.18	1.8	0.25
100	2.0	1.6	0.2
90	1.95	1.5	0.18
80	1.9	1.48	0.17
70	1.85	1.45	0.16
60	1.8	1.4	0.15
50	1.7	1.35	0.13
40	1.6	1.3	0.11
30	1.5	1.26	0.10
25	1.4	1.2	0.09
20	1.3	1.1	0.05
15	1.18		

### A SERIOUS APPROACH TO SEPARATION NEGATIVES

If you have a densitometer of sorts and wish to tackle the business of making separation negatives seriously—i.e., if you wish to standardize your procedures so that you are always assured of making the best possible negatives—then you can proceed in the following manner. Having established your technique, you can spend your time on making prints from the negatives and not be bothered by continually having to remake negatives or by having to worry whether your negatives will make good prints, or by cut-and-try exposures with each new set of negatives you make.

You must standardize completely your darkroom technique. You must decide on the developer you will use, the temperature at which you will work; you must have a foolproof method of timing

exposures and developing times; you must use the same amount of fresh developer for each film and must maintain the temperature throughout the development period. Having determined these matters and having nailed them down so that they are no longer sources of worry, you can proceed to learn the characteristics of the film you will employ. A full knowledge of the film will include complete comprehension of the effect of exposure, of developing time, and of developing temperature.

If most of your negatives will be made directly from original copy—still life, for example—you should illuminate a paper gray scale with the amount of light you will ordinarily use. Make several identical exposures; then make several exposures, giving one about one-half the normal, one two times normal, and another four times normal. The Stripmeter described under AIDS TO SEPARATION MAKING will be useful here.

Now take the identical exposures and develop them for different times, say 4, 6, 8 and 10 minutes, in a tray of DK-50, if Kodak Super-XX film is to be employed. Make these exposures and carry out the processing with all the care to be exercised in making an actual set of separation negatives. Plot the densities resulting against the steps of the original gray scale and study the curves. From such data you can learn the effect of development time and how to make more or less contrasty negatives if a situation requires it. Choose one of the developing times and process the other films that have various exposures and again plot the results. From such curves you can determine the effects of exposure and development.

It will be seen at once that developing identical exposures for longer and longer periods results in curves that are steeper. This means that the higher densities are increased at a faster rate per unit of exposure with longer development—in other words, the contrast is greater.

If the minimum density is of the order of 0.30 or thereabouts, depending on the film, increasing exposure increases maximum and

minimum densities approximately the same amount. A longer developing time results in a greater density range. Moderately increased or decreased exposures will not affect the density range appreciably but will merely change the actual density values.

The curves produced as described above will have the horizontal data plotted as Steps 1, 2, 3, etc. instead of log exposure, since the actual exposure values corresponding to the individual steps of the gray scale will not be known. The curves may be somewhat distorted, too, because of the fact that the gray-scale steps may not be an equal distance apart on a log scale. The data will be available in the form of curves, however, from which you can find out just about all you need to know about the film you are going to use.

### EFFECT OF THE SEPARATION FILTERS

The first step in using the data produced is to determine the correct exposure factors for the three color separation filters to be employed. As a first approximation, use the factors given by the manufacturer. Thus for Isopan exposed to tungsten illumination, give to the A-filter negative a trial exposure six times the exposure by which the best-looking gray-scale negative was procured by the process outlined above. After processing it, measure the densities or transmissions, plot the curve, and see how near (or how far!) the nonfilter curve and the A-filter negative are. Similarly expose two other films under identical conditions, except that the B and then the C5 filter are employed, for which the recommended exposure factors are 8. Develop these films as recommended (see the table on page 168). If a film other than Isopan is employed, use the factors shown in this table, develop the A and B negatives alike (say 5 minutes in DK-50), and develop the C5 negative about 50 per cent more.

Suppose that plotting the results of exposing two films to a given gray scale, one film getting twice the exposure of the other, looks like that in the figure. As expected, the film with the greater expo-

sure has greater densities throughout its curve. Since the two films were developed alike, the contrast of the two negatives is the same. Taking any point along the straight part of the two curves, note that doubling the exposure produced an increase in density of approximately 0.26—i.e., taking Step 6, the density of this step on the 10-second exposure film is 1.36; the density of the same step on the 20-second film is 1.62. If, then, you consider this small bit of evi-

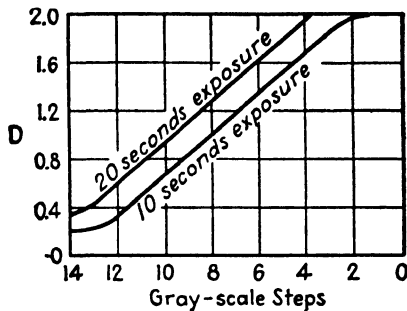

Idealized representation of the result of making two test exposures to a gray scale.

dence as conclusive, you can construct a curve for the film exposed and processed as these negatives were that will tell a great deal. Since the curves are parallel, you know that doubling the exposure adds 0.26 to all densities on the linear part of the curve.

You can replot the curves as follows. Note that the straight part of the 10-second film extends between Steps 3 and 11. You can then state that Step 11 corresponds to one unit of exposure producing a density of about 0.48. Now mark off along the horizontal scale of the paper equal distances in steps representing exposure units, and arbitrarily state that Step 2 represents twice the exposure of Step 1, Step 4 represents twice the exposure of Step 2, Step 8 twice the exposure of Step 4, and so on. Since doubling the exposure increases the density (over the straight part of the curve) by a matter of 0.26, Step 2 will have a density of 0.48 plus 0.26, or

0.74, Step 4 will have a density of 0.74 plus 0.26, or 1.00, and so on. The whole curve can be plotted between densities of 0.48 and 2.0, which is the limit of the straight-line region for an exposure of 10 seconds and for a development such as was given the 10-second film.

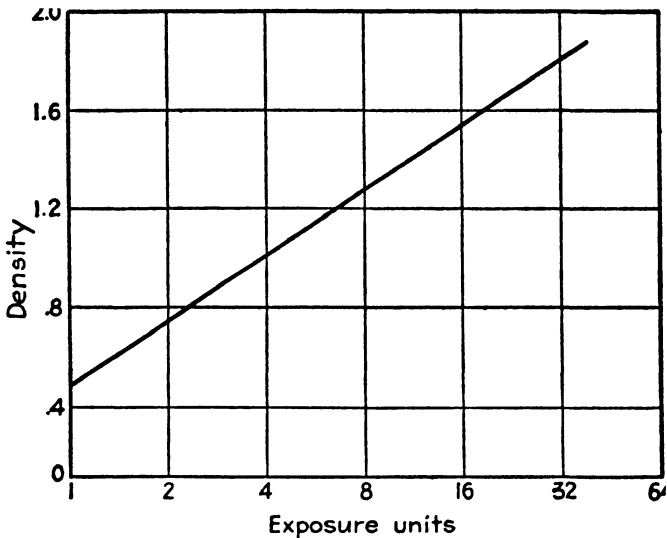

Translation of the data in the previous illustration to show the relation between exposure and density for the film under test.

If an A-filter negative has values that are somewhere near the 10-second exposure film, but the B-filter negative has densities near the 20-second exposure film, you will know at once that your exposure factor for the B filter was off by a factor of about 2. If the densities lie somewhere between the 10- and the 20-second exposure film, you know that another try giving somewhat less than 20 seconds will give you densities approaching the desired values. The effect of doubling the exposure is a useful thing to know and should be recorded.

It is realized by practicing photographers that it is virtually impossible to get separation negatives that are much closer together,

step by step, than 0.1 in density without the most rigorous precision in all phases of exposure and processing. Thus, if the photographer determines his filter factors in the way described above and can produce separation negatives that are within 0.1 in density, step for step, of each other, he is doing quite well and should not worry about getting greater precision. He must remember that the slightest change in his processing conditions will produce changes in density values and in the slope (contrast) of the negative curves. Furthermore, the age of the film, the particular batch of it he is employing, the manner in which it is stored—all have some controlling effect on the densities to be secured by a particular exposure and a particular development.

From the curve in the figure the photographer can determine the total range in light values that will produce densities on the straight-line part of the film curve; and from the curve he can calculate the gamma to which his films are developed. Neither of these quantities, however, is of much value to the photographer in his color work. He will always try to keep the total light-intensity range down to a ratio of not over, say, 4 to 1 for the parts of the subject in which he is most interested, letting the shadows fall as they may, and he will strive to keep the density range of the negatives within the range of values that can be adequately handled by the printing medium employed. With the Eastman Dye Transfer process, negatives of wide range of densities can be printed.

If instead of using a paper gray scale the photographer has a transparent scale, he will be able to measure the densities of the individual steps of the transparent scale. By making contact or projection prints of this scale onto the negative material he will use, he will be able to plot the resulting densities against the original densities. Such a set of data will be of greater value than the data collected by photographing the paper scale.

An example of the use of a calibrated gray scale and densitometer will be taken from the author's notebook. These data were obtained



by means of an Eastman transmission densitometer. The gray scale used in the original exposures was part of an Eastman Color Separation Guide set, whose reflection densities were as shown on the horizontal axis of the graph. The densities of the three films corresponding to these gray-scale densities are used as the vertical scale.

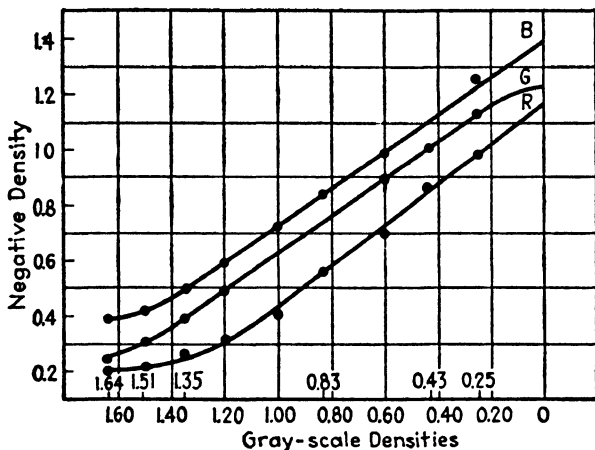

Typical separation-negative curves. These represent actual measurements on the negatives from which the color print of the basket of apples was made.

Note that the three curves do not overlap and that the red-filter negative has somewhat greater slope than the other two. This indicates that the exposures were wrong and that the red-filter negative was in the developer a bit too long (or that the developer was warmer than when the other two films were developed).

Now it remains to determine how much the exposures were off. First, remember that higher reflection densities are actually darker steps on the gray scale. Thus a reflection density of 0.60 reflects less light than a step that has a reflection density of 0.40. Note that the red-filter negative (blue printer) has a density of 0.72, corresponding to a gray-scale density of 0.60. The green-filter negative

(magenta printer), however, has a higher density corresponding to this gray-scale step. It has a density of 0.72, corresponding to a gray-scale density of about 0.88. Similarly, the blue-filter negative (yellow printer) is still more dense and has a density of 0.72 at a point on the original gray scale that has a reflection density of 1.00.

The density difference between the red- and the green-filter negatives is such that the red negative should have had an exposure of about 1.9 times that actually given it to secure equal densities in the red and green negatives. Thus

$$D_2 - D_1 = 0.88 - 0.60, \text{ or } 0.28. \text{ Antilog } 0.28 = 1.9$$

Similarly, the density difference between the green- and the blue-filter negatives is  $1.00 - 0.9$ , or  $0.1$ , and the antilogarithm of this number is  $1.26$ , indicating that the blue-filter negative was exposed about 25 per cent longer than was desired to bring it into line with the green-filter negative.

These negatives were exposed in a 9- by 12-cm camera in bright sunshine with exposures of 6, 5, and 5 seconds with the shutter on "bulb." Obviously no exposures closer to the required values could be obtained by the method employed, and, as a matter of fact, these negatives are about as good as anyone can expect to make under the conditions. Prints made from them are excellent in every respect save one: the negatives are slightly out of register at the corners, indicating that the lens was not fully corrected, or that the film holders did not place the individual films in exactly the same place with respect to the lens, or that the films changed size slightly in processing. The out-of-register is scarcely discernible in a 4-time enlargement. As a matter of fact, the color print of the basket of apples reproduced in this book was made from these negatives.

The greater contrast of the red-filter negative is a slight annoyance in printing, but with the Dye Transfer process the difference can easily be compensated.

In actually printing from the negatives, the maximum density of each negative was measured. This was at a point on one of the apples where the sunlight was particularly bright. This would be the lightest point in the final picture, almost pure white. The densities were respectively 1.25, 1.35, and 1.5 for the red-, the green-, and the blue-filter negatives. By trial it was determined that an exposure of 2.5 seconds produced the correct result from the red-filter negative. The exposures for the other negatives were calculated as follows.

The difference between the densities of 1.35 and 1.25 is 0.1, and the antilogarithm of this number is 1.26. Multiplying 2.5 by this factor gives 3.15, the correct exposure to be used when printing the green-filter negative. Similarly, the difference between densities of 1.5 and 1.25 is 0.25, and this is the logarithm of 1.78, so that 2.5 multiplied by this factor becomes 4.5. An actual exposure of 5 seconds to the blue-filter negative was given because this negative had less contrast than the other two negatives. The result was that, while the shadows were black as desired, the high lights were slightly yellow. This was corrected by washing down the yellow wash-off printer slightly.

### SPECIAL FILMS FOR SEPARATIONS

Mention has already been made of the use of X-F pan film with special Defender filters that equalize the exposures so that a 1 to 1 ratio exists if the proper filters are used with a given light source. Numerous special combinations of films and filters have been utilized by photographers with one idea or another in mind. Sometimes the object is to secure shorter exposure times, sometimes to bring the exposures more nearly alike, etc. The one trouble with such methods is the fact that two different kinds of film may not process alike—i.e., one may change size more than another with resultant out-of-register difficulties.

The following material is taken from the *Defender Trade Bulletin* and was written by L. L. Perskie under the subject "Natural Color Separations."

One of the annoying problems in the making of separation negatives, for natural color photography, is arriving at the exposure time for each of the negatives to be exposed through the A, B, and C5 filters, since each of these filters requires a different exposure factor.

It is often quite difficult to use these factors satisfactorily when exposures of short duration are being considered. Different light sources require different exposure factors, which add perplexity. As an example, the T-20 type of Mazda lamp emits different color radiations of light than does the pear-shaped Mazda lamp and the photoflood lamp differs slightly from the movie-flood. The result is that each source of

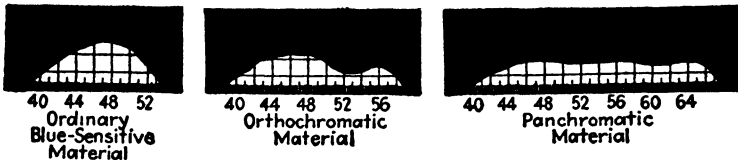

Spectral characteristics of three types of film emulsion in common use. The values along the bottom of the charts are wave lengths in tenths of a millimicron.

light will cause a variation in the actual filter factor. Due to these variables, the photographer who is not doing color as a daily diet finds his results inconsistent or downright bad.

The following system has its merits and is being used successfully by many photographers. It simplifies the making of separations, in that filter factor considerations are eliminated. The three exposures are all the same. The exposure is determined by reading the subject matter with a Weston meter set at an emulsion speed of 8. The filters are the Wratten, gelatin or glass, No. 32, No. 5, and No. 25. The light source may be either No. 2 or No. 4 photoflood lamps. The films are X-F ortho and X-F pan.

The X-F ortho film is exposed through the No. 32 filter. The combination gives the blue recording, which ultimately yields the yellow printer. The second film exposed is likewise an X-F ortho, but exposed through the No. 5 filter. This combination gives the green recording and later yields the magenta printer. The third film, the X-F pan, is exposed through the No. 25 filter and gives the red recording, which evolves the cyan printer. As stated previously, all the exposures are identical.

The 6-D formula is recommended. The time of development for a set of negatives suitable for either carbro or wash-off relief is:

X-F ortho exposed through No. 32 filter—9½ minutes development.

X-F ortho exposed through No. 5 filter—9 minutes development.

X-F pan exposed through No. 25 filter—11 minutes development.

These stated times are for tray development at 70°F, constantly agitated during development.

The system outlined is intended for the photography of still objects in natural colors, indoors. It can be used for outdoor photography, but since the color radiations of daylight are constantly changing from sunrise to sunset, no attempt to arrive at filter factors has been made. Suffice to say that the system cannot be used on an equal exposure basis outdoors. Since the greatest portion of still-life photography is done indoors, the method suggested has definite value, is simple and efficient.

Whatever films or plates the photographer uses, he must remember that underexposure is to be avoided like poison as it will upset the color balance much more than overexposure. Such errors can be avoided if the worker will strive to get the minimum densities, shadows, up on the straight-line part of the negative curve. This minimum density should be of the order of 0.3 to 0.6, depending on the material employed. When viewed against a clear light, such as the sky or a sheet of white paper, the negatives should show detail in the shadows in which correct color is desired. The color photographer's axiom is "expose for the high lights and light the shadows." This means that the shadows should be adequately illuminated to produce details in the negatives in those regions and that the high lights under these conditions should not be excessively bright compared to the shadows. Flat, even illumination will produce the best color pictures.

Another important note is the fact that out-of-focus backgrounds are more disturbing in color than in black-and-white pictures. If it is not possible to stop down enough to get the background sharp, then this background will have to be made of some even material without pattern. In outdoor photography this is difficult and the

trick then is to get far enough away from the subject so that both subject and background come more nearly into focus.

### TRIPAC

Before the war Defender manufactured an assembly of three films exposed as a unit so that a single exposure produced the color separation negatives. The three films were placed in a special holder behind a pressure glass and were exposed to artificial illumination at a Weston speed of 3. Since the red-filter negative had its sensitive surface separated from the lens by the thickness of the other two films, the blue image in the final print was inclined to be slightly diffused or out of focus. If the enlargement employed in printing was no greater than three, this diffusion was not noticeable. For this reason, however, Tripac was not recommended in sizes smaller than 4 by 5. It was excellent material for portraits where the diffusion was an advantage. (See the final chapter for a modern version of Tripac.)

### ONE-SHOT CAMERAS

Prior to the development of color transparency materials such as Kodachrome, Ektachrome, or Ansco color, professional photographers used a type of camera known as a one-shot for making color separation negatives. In such a camera, all three negatives are made with one push of the shutter button. Even today, when a color print is the desired end, a one-shot camera is likely to produce better results than those obtained by making color transparencies from which prints are made. This is due to the fact that a transparency is an approximation of the original, the color print is an approximation of the transparency. Two sources of error exist.

The present trend is toward professional use of transparency methods of making color photographs instead of toward furnishing clients with color prints. A transparency will cost the client less money—something he is vastly interested in—but he will eventually

pay out the same amount or more if the print or transparency is to be reproduced by any printing process. If the engraver is furnished with a transparency, he must do considerable more hand-work on his copper plates than if he is furnished a good carbro or wash-off print. For this reason he has to charge more for engravings made directly from transparencies than he does for those from

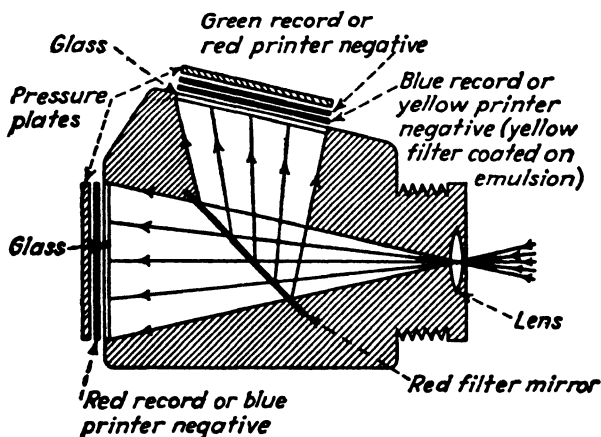

Single-mirror one-shot camera for making separation negatives for color printing.

prints. These costs seem hidden, however, and if the client can get a transparency for, say, \$100 while a print will cost him \$200, he is likely to go for the transparency. He should know, however, that the engraver will charge him at least \$100 more for his engravings.

The one-shot camera is a necessity if separation negatives are to be made from a setup in which any motion is likely to occur. Thus with living models a one-shot is a necessity. One-shots, however, are no faster than transparency materials.

While these cameras are beyond the means of the average amateur, the principle upon which they work should be known. It is quite possible that cameras less expensive than those existing before

the war will come on the market; and, of course, one may always chance upon a secondhand outfit at fairly low cost.

A one-shot has a single lens, but by means of mirrors or a prism or other ingenious methods, the light picked up by the lens is

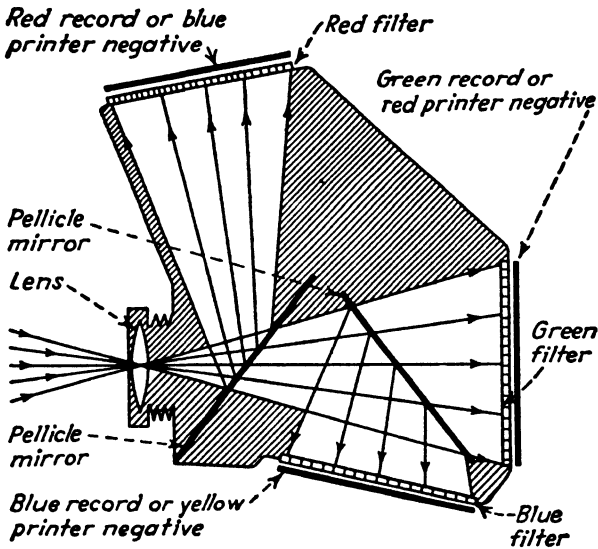

The aristocrat of the one-shot cameras using two mirrors with the negative material at three separate positions.

divided and routed through filters to the required three films or plates. There are two general types of such cameras, each a precision instrument. One employs a single mirror, which is semi-transparent, passing part of the light directly to a film or plate and reflecting the rest to the other film position. At this point two films are employed in contact with each other, one registering one of the primary colors and the other registering the third color. Such cameras use what has come to be known as a "bipack and single" film arrangement. The single-mirror camera is fairly fast, since the light is divided into only two parts and its simplicity makes it less



expensive than the two-mirror units. One film will have a reversed image.

Since two of the films are exposed emulsion to emulsion, the light must go through one of the film bases before it hits either emulsion. A slight diffusion of the image on one of the negatives results, but in general this lack of extreme sharpness of image is no detriment. The simplicity of the one-mirror type of construction makes it possible to construct a "color back," which may be attached to a conventional studio camera.

The two-mirror camera is the aristocrat of the one-shots. Where the utmost in registration and image sharpness is required, as in making big blowups for national advertising campaigns, the two-mirror camera is a necessity. While cameras of this type were made in prewar days for negatives as small as 6.5 by 9 cm or 2¼ by 3¼ inches, professional photographers seemed to prefer 5 by 7 units, which cost them in the neighborhood of \$1,000 to \$2,000. Curtis Laboratories now produce one-shots in the 2¼- by 3¼-inch and 4- by 5-inch sizes at approximately \$500 and \$1,000, respectively. They employ new means of beam splitting and operate at Weston speeds of 16 to 20, which are much faster than present transparency materials.

Where negatives are to be made from subjects that do not move, the one-shot is not necessary provided one has a good sturdy studio camera of such construction that the film or platemakers always occupy the same position to a high precision, so that the three negatives will be in exact register when prints are made. The acme of elegance in separation making, however, comes from the use of a one-shot camera.

### OUT-OF-REGISTER NEGATIVES

If, when printing time comes, it is found that the negatives are indeed of different size (out of register), then the photographer is in a dilemma. The best thing to do is to make a new set of nega-

tives, but this may be impossible—perhaps the models have gone home or the flowers have wilted. In the final print he will have to make the best compromise possible.

It is said that dilute carbinol acetate will shrink films, but the author has had no personal experience with this method of adjusting out-of-register negatives.

Negatives that are in register will produce out-of-register prints if they are overheated in the enlarger during the focusing, composing, and actual exposure of the negative to the final printing material. Not only can negatives be thrown out of kilter temporarily by too much heat for a short period of time, but also they can be given a permanent distortion by protracted exposure to moderate heat. Dr. Thomas F. Curtis of the Curtis Laboratories, Los Angeles, cites an example in which the conventional diffuser-enlarger using a 250-watt bulb, operated in an air-conditioned room, had a temperature of 70°F in the negative plane at the start of a test, but this temperature had risen 8° in 30 seconds, and after 6 minutes the temperature had become 99°F. A negative placed between glass plates and inserted in the usual position had fine scratched lines on it. These lines were marked on the easel. After a period of 1 minute, the lines of the easel were  $\frac{1}{32}$  inch away from the first marks, indicating that the negative had increased in size. At the end of 6 minutes the marks were  $\frac{1}{8}$  inch larger than the original. Since the enlarger was set for an enlargement of  $2\frac{1}{2}$  times, it can be seen that the negative had expanded  $\frac{1}{20}$  inch.

All of this means that focusing should be done with another negative, that the actual composition should be done by means of a dummy image penciled on frosted celluloid or by means of a positive on film made from the separation negative. Exposures should not be unduly long, and this means that the enlarger should be so constructed and operated that it is not necessary to stop it down to small lens apertures to get the whole image in focus at once.

All three negatives should be placed in the same position in the negative carrier so that the image on the printing material will occupy the same position. To avoid a long lapse of time while this positioning takes place, the three separation negatives can be superposed and brought into fairly good register, after which two adjacent edges can be trimmed on a trimming board. Placing them in the negative holder, thereafter, merely requires that the trimmed edges be butted up against one corner of the negative holder or moved up to a pair of right-angle lines traced on a mask placed in the negative holder.

These are small points, but they spell the difference between a passable color print and one that is "professional." As far as the professional photographer is concerned, these small points may mean much to his economic success. A color print that is in exact register, that is in the correct colors, that is not overexposed or underexposed, and that requires an absolute minimum of spotting is a print that will cost the client little money for further work.

In relation to the subject of heat in enlargers, here are a few other pointers that may be helpful. A sheet of heavy plate glass above the ground-glass diffuser and not in contact with this latter glass will attenuate the heat rays to some extent, and if this glass has a greenish appearance when viewed through the edge, still further heat filtering will result. A flat glass tray of distilled water in which a few crystals of copper sulfate have been dissolved makes a very effective heat filter.

Cooper-Hewitt and other vapor lamps are ideally cool and produce white light of high value—but they also are prone to cause a trouble known as Newton's rings when the negatives are on film and when the film is placed between glass plates under pressure in the negative holder. If the pressure plate is abraded with a fine material, some relief will be secured, but then there enters the trouble of preventing the grain of the pressure plate from showing in the final print.

## SEPARATION NEGATIVES FROM TRANSPARENCIES

After you have made transparencies of which you are proud, you can show them to your friends by asking them to hold them up to the light, one at a time, or you can look at the picture through a small viewing arrangement by pointing the latter at a source of light, or the transparency can be projected on a screen. In the latter case, the house lights have to be darkened, a projector must be set up, and a screen must be placed in position much as if you were to display a motion picture.

What the average photographer desires is a paper print which can be passed around to be viewed in ordinary light or which can be hung on the wall as evidence of his photographic skill, or as a reminder of an enjoyable occasion in the out-of-doors, or as a permanent record in color of the beauty of his children. To make such a print, he must proceed with separation negatives—if the best possible reproduction is desired. To date the processes that, at one exposure, make a print on a specially coated white base do not provide as good color reproduction as those methods that depend on separation negatives.

It must be understood at once that the color print will not be as beautiful as the transparency. In the first place, as stated before, the transparency is only an approximation of the original. The print is one step further removed from the original; it is still more inaccurate. Furthermore, it will not be as bright as the transparency. This is inherently true because of the very nature of the photographic materials developed to the present time. On the other hand, color prints made from transparencies may be intrinsically beautiful, and since the photographer has many means of control, he may even improve, artistically, upon the transparency by distorting or correcting the colors more to his taste.

It is also a fact that the cheapest way to get color prints of fast action is to use a transparency as an intermediate step between the original exposure and the final print. One-shot cameras are expen-

sive, and most of them are slow. Remember that no more than half the light coming through the lens can arrive at any one film, that the filter transmitting the least amount of light of its own color governs the over-all speed of the whole arrangement of lens, filter, and film. A miniature camera with a wide-aperture lens and a color film having a speed rating of 8 to 12 will enable you to shoot horse races or active children or animals with the certainty that sharp images will result.

To make a color print from a transparency by the separation-negative technique requires several steps described below.

Separation negatives from transparencies can be made in one of several ways. Contact-size negatives are made in a printing frame just as though you were making a black-and-white print on paper from a negative; negatives larger (or smaller) than the transparency can be made in an enlarger; or you can illuminate the transparency and then copy it by means of a camera with a long bellows and short focal-length lenses. In any case, three negatives are required, and they must be made with all the precision with which any separations are made.

One of the virtues of making color prints from transparencies is the fact that you need not carry heavy cameras to the field; the scene from which the print is to be made can be impressed on color film, which is brought to your darkroom for all subsequent work.

### *Separations by Contact*

Separation negatives by contact are easily made. The requirements are a light source, filters, and a printing frame. There is one great advantage in making the separations in this manner: the lens employed, if any, need not be color corrected since it serves merely as a source of light and is not called upon to focus a colored image on the negative material. On the other hand, contact negatives are the same size as the transparency, and when working with 35-mm film, the negatives are small and must be processed with greater

care than is required when working with 4 by 5 or 5 by 7 film. Contact separations, therefore, can be sharper than negatives made by projection and can have better shadow contrast because of the lack of lens flare.

To make contact negatives from transparencies, proceed as follows. The printing-frame glass must be carefully cleaned of all dust and fingerprints. On one corner of the glass and about  $\frac{1}{4}$  inch out from one of the right-angled corners the transparency is mounted with Scotch tape or gummed paper. Alongside the transparency is mounted a transparent gray scale, which will serve as the control for the following processing.

As a light source you can use a vertical or horizontal darkroom lamp with the safelight replaced with a mask having a  $\frac{3}{4}$ -inch hole in the center and with means for mounting the proper filter over this hole. Filters 2 inches square mounted in cardboard holders will be quite satisfactory.

Another light source is the enlarger. The intensity of the light and therefore the length of exposure can be closely controlled, and as a further advantage, the relative position of printing frame and light source can be held strictly uniform for the three exposures.

If the final prints are made by a wash-off process, the negative material must be placed in contact with the base side of the transparency if contact prints are to be made. If the prints are to be blown up from the negatives, the emulsion of the transparency can be placed either up or down with respect to the light source, but the preferable way is for the image side of the transparency to be facing the emulsion of the separation film. These measures insure proper orientation of the image in the final print.

Whether the enlarger or another light source is employed for making the exposure, all stray light should be eliminated so that it cannot fog or streak the negatives; the distance between light source and printing frame should be great enough to insure even illumination over the whole frame.

Suppose that the enlarger or a vertical darkroom lamp is employed and that contact negatives are to be made. Clean the printing-frame glass carefully, wipe the surfaces of the transparency with a fine camel's-hair brush to remove dust and lint, mount the

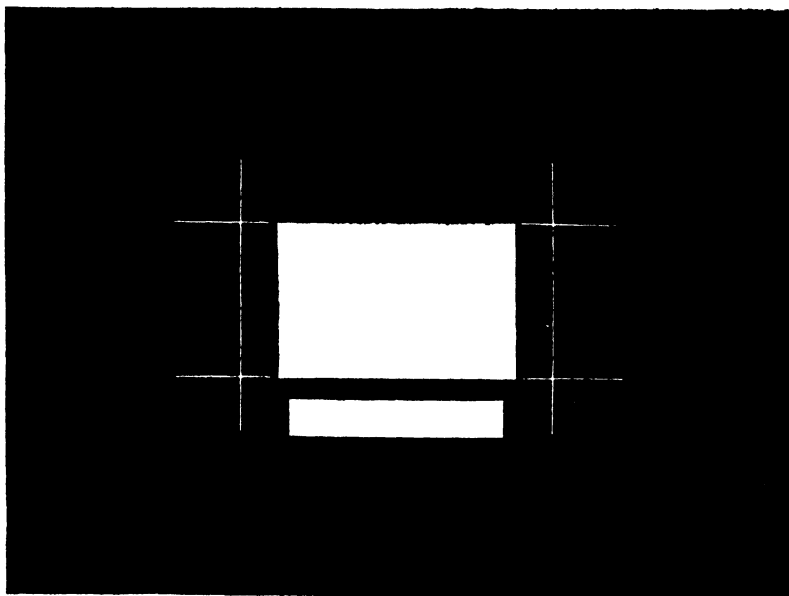

Mask useful for making separation negatives from 35-mm transparencies on a process plate. In the emulsion, scrape register marks where the white lines cross and mount the transparent gray scale over the white rectangle shown below the larger cutout.

transparency on the glass beside the gray scale, and make some mechanical arrangement so that the printing frame will be located correctly when the lights are turned out and the exposure is to be made.

The film should be one of the fast panchromatics with a long linear characteristic curve and should be at least one size larger than the finished negative. The filters should be the Wratten Nos. 29

(F, red), 61 (N, green), and 49 (C4, blue), obtainable in sets from camera stores.\* Handle them only by the edges, and when through with them, return them to their original paper protectors and their envelopes. Do not mount them in glass.

Select a transparency with some white in it—a cloud or a white

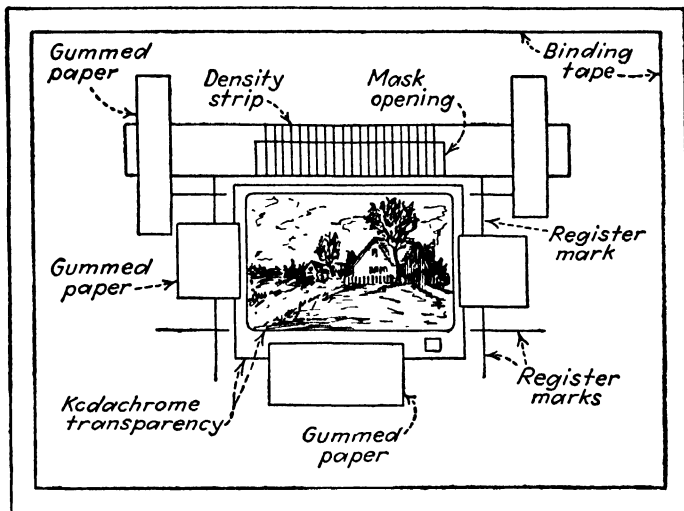

Method of mounting transparency on the mask for making separations by projection in an enlarger or for copying, through tricolor filters, by illuminating the transparency and by photographing it three times.

dress or a man's collar. The transparency should be clear and sharp and one of the best you have made. Fix the red (29) filter over the light source, arrange the film box where it can be reached in the darkness, and have handy an empty box large enough to contain the exposed film. Decide on an exposure that seems reasonable (see below for the author's experience), set the timer, turn out the lights, and place a sheet of the negative material over the transparency, close the frame and invert it, placing it so that it will be in the center of the illumination from the light source.

\* For Ektachrome, use Nos. 25 plus 66 or 72A, 61, and 35 plus 38A or 35A.



After exposure, this film should be developed at once. If you do not have a densitometer, a visual inspection of the processed negative must determine if the exposure has been correct. There should be details in the shadows. If you possess a densitometer, measure the portion of the negative corresponding to the white portion of the transparency. This density should be of the order of 1.5 to 1.7 with the usual fast panchromatic film.

### *Newton's Ring Troubles*

Sometimes when the base of the transparency is in contact with the glass of the printing frame, a pattern of small concentric markings resembling a weather map will be found on the processed negative. These annoying and unwanted marks are known as Newton's rings and may prove to be difficult to prevent. If the clear glass of the frame is replaced with finely ground glass with the ground side in contact with the base of the transparency, the trouble may be eliminated. With this method, however, the graininess of the glass will often be found impressed on the negative image, giving it the appearance of high grain. A sheet of flashed opal glass an inch or so above the printing frame may get the worker out of this trouble. The glass can be replaced by a matte plate, such as Kodak Tri-X Panchromatic, Type B, matte plate, or Kodak 33 matte plate, that has not been exposed but that has been fixed, washed, and dried.

### *Separations by Projection*

In making separation negatives by projecting the transparency on the negative material, care must be taken to see that the projection lens is properly corrected for work of this type. Lateral color aberration is the troublesome characteristic here, one of those faults that do not show up in ordinary black-and-white enlarging. Because of this aberration, images by red, green, and blue light do not have the same size and therefore will not register exactly when

the final print is finished. A test for this trouble is outlined below.

If the lens is known to be good for the purpose, the transparency is mounted on a single sheet of glass, or between cover glasses, together with the transparent gray scale. The image is blown up to the desired size and critically focused. If the enlarger employs a high-wattage bulb, it will be wise to do all of this preliminary work of focusing and masking with a dummy film so that the transparency is not subjected to undue heat. All light leaks should be plugged or a box must be made to fit, at the top, tightly around the lens and filter and, at the bottom, tightly around the film holder, which can be a printing frame or an ordinary easel with the negative material held down flat by a sheet of glass, carefully cleaned.

A trial exposure should be made through the red (29) filter and when this negative is processed, inspection either by eye or by means of a densitometer will determine if the exposure needs to be changed.

If the final print is to be a wash-off and is to be made by contact with the negatives, the transparency should go into the enlarger with the emulsion side toward the lamp. If the print is to be made still larger than the separation negatives, the transparency can go into the enlarger with either side toward the lamp. It is good practice, however, to place the image side toward the lamp; then the print can be made by contact if desired or by projection.

The author has found that a 4 by 5 image placed in the center of a 5 by 7 film or plate makes an excellent negative with which to work. There is plenty of room for the blown-up image of the gray scale and plenty of finger room around the edges of the image. If the photographer has no big enlarger, then his negatives must be the size of the final print. A good 35-mm transparency can be enlarged 8 to 10 times without lack of sharpness; in fact, the author has made 11 by 14 prints from 35-mm Kodachromes without trouble. The size of the negatives will be determined, then, by the maximum degree of enlargement his enlarger can produce. If this is a matter

of, say three, and if the largest print likely to be wanted is 11 by 14, then the image on the negative should be 11 divided by 3, or approximately 4 inches. Thus a 4 by 5 image is about correct. This represents a magnification from transparency to negative of about 4 times, or a total magnification of 12.

The author strongly recommends that the photographer decide on the desired negative image size and that he never vary it except for some special occasion. With this image size fixed, the position of light source, aperture opening in the enlarging lens, and time of exposure can be closely tied down to fixed quantities. The only variable will be the actual amount (time) of exposure required for transparencies of varying degrees of density. Read carefully the material following on making separations for Kodak Dye Transfer printing.

### *Making Separations in a Copying Camera*

In the third method of making separations, the transparency is mounted in front of an illuminated white cardboard and the camera is placed in front of the transparency and arranged so that an image of the desired size is focused on the ground-glass screen. If much separation work is to be done, this is probably the best method, since everything but the copying camera can be fixed in position and not moved.

This method requires a camera of long bellows extension or a lens of short focal length or both. To copy an image "same size" requires a bellows of "double extension"—i.e., twice the focal length of the lens. Everything about the setup must be rigid: the lens must be color-corrected, negative holders must hold the film firmly, and the holders themselves must be set firmly against the camera. These requirements are no different from those for making separation negatives directly from any sort of copy.

The author has seen perfectly good prints made from Kodachrome transparencies in the following way. A sheet of white cardboard was illuminated by photoflood lights (No. 4) in reflectors,

one on each side. About 18 inches in front of this illuminated background was placed another cardboard with a hole in it large enough for the Kodachrome frame to be mounted over it. Thus the trans-

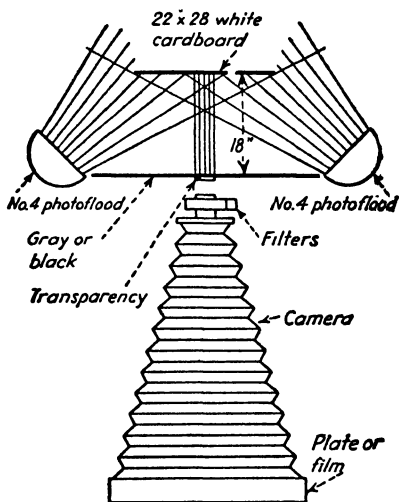

Method of copying transparency on separation negatives by illuminating the transparency from the rear.

parency was illuminated from the back. A copying camera with triple-extension bellows was used. The conventional tricolor filters, A, B, and C5, were used with Defender X-F pan film, exposed with factors of 4, 6, and 9 with a basic black-and-white exposure of 5 seconds. The negatives were developed in D-76 for 8, 8, and 11 minutes and masked with weak positives made on Seed 23 plates by contact and developed to a low gamma.

If a 9- by 12-cm camera with a 13.5-cm lens with a Proxar 2 accessory lens is used, the camera can be placed about  $7\frac{1}{4}$  inches from a 35-mm transparency and will then give an image about  $1\frac{7}{8}$  by  $2\frac{1}{2}$  inches in size. With good sunlight (in January) shining on a white piece of cardboard about 18 inches back of the transparency, a basic black-and-white exposure of  $\frac{1}{2}$  second was required with a film that had a speed rating of 32.

The great advantage of this method of making separations is the fact that everything except the developing can be done in full daylight or artificial light. You are really taking a picture of a picture, which in this case happens to be a transparency. The films for the separations are loaded into plateholders or film holders as usual. You can see what you are doing at all times, there is no danger of fogging the films, and you do not need a darkroom until developing time comes.

The trouble with the system is that great care must be taken to see that the film and the transparency are accurately parallel, that the camera is level, etc. An optical bench is really required to do a perfect job. Furthermore, to get a large image one must use a short focal-length lens or a camera of very long bellows extension. With larger transparencies, this difficulty is not so serious. The Curtis Enlarging Printer described on page 228 was developed specially for making separations from 35-mm transparencies.

### *Checking the Lens for Lateral Aberration*

Unless the lens used for projecting transparencies for enlarged negatives is known to be free of lateral aberration, a test can be made as follows. Thoroughly expose a plate to uniform light, such as the sky, and process it to produce a dense black. When it is dry, scratch a series of lines in the emulsion parallel to the edges of the plate. Place in the enlarger and blow up to the size the separation negatives will be. Now copy these lines onto panchromatic plates through the separation filters. From one of these negatives make a contact positive, also on a plate. Place this positive in contact with either of the other negative plates and determine if the lines register or not. If they do not, then the separation-negative images will not register properly when separated by the tricolor filters and the lens will have to be discarded or corrected. It is probable that the manufacturer of a good lens will be able to make the necessary corrections at a reasonable cost to the owner.

### *Films to Use*

Practically any good pan film can be used; but since transparencies have a wide density range (they are contrasty) and since the available printing materials will not reproduce a very wide density range, the negatives must be soft. One way to effect the desirable degree of contrast is to use the fastest films, since they are inherently less contrasty than the slow, fine-grain films. Then these films should be developed to less contrast than separations made directly from the subject or negatives made for conventional black-and-white printing. The author has used practically every pan film made and several kinds of plates. Good negatives have been obtained on all of the films and plates, but each must be studied by itself to determine the appropriate exposure and developing conditions.

Defender supplies special filters for X-F pan film, 40-R, 60-G, 100-B that give a 1 to 1 to 1 ratio of exposures when a GE 211 or 302 enlarger lamp is employed as light source.

### KODAK SEPARATION TECHNIQUE

Kodak's recommended technique for making separation negatives from Kodachrome and Ektachrome is based on certain standard darkroom conditions—conditions which you may adapt to your own equipment or which you may follow directly if you use the apparatus (Kodak Precision Enlarger) around which the methods were worked out.

**ILLUMINATION.** The first of these standard conditions is that of illumination. This calls for a measured illumination on the easel of 3 foot-candles or an illumination-meter reading of 4 foot-candles when the meter is placed on top of a printing frame placed on top of the easel. You arrive at this condition as measured by a GE exposure meter by opening the enlarger lens to  $f/4.5$  and, keeping the lens focused on the easel, adjusting the height of the lens above the easel until the proper meter reading is attained.

As an example, this illumination is attained when the Kodak Precision Enlarger A is used with a No. 212 Mazda enlarger lamp (150 watts), condenser, normal heat-absorbing glass, and a 4-inch Projection Ektar when the lens is approximately 20 inches from the easel and is focused on it, or when the 105-mm Projection Anastigmat  $f/4.5$  lens is in focus and about 23 inches from the easel.

A method of checking the illumination is as follows. Expose a piece of Kodak Super-XX film in contact with a transparent gray scale in a printing frame on the easel of the enlarger through a Wratten No. 61 filter. At some value of magnification a 15-second exposure at  $f/5.6$  will produce a negative density of 0.3 corresponding to a density of 3.0 in the gray scale when the negative is developed for 4 minutes in a tray of DK-50 (1:1) at 68°F. Use this setting of lens-to-easel distance. If the negatives are to be made by enlargement, then, obviously, this position of the lens cannot be held fixed but must be changed with the degree of magnification. The lens opening corresponding to the chosen magnification can be determined by using the Kodak Print Exposure Computer or can be figured out from the method explained under CALIBRATE THE ENLARGER. If the negatives are made by contact, the "standard" lens-easel distance can be used each time separations are to be made.

**MINIMUM DENSITY.** The Kodak method of making separations from transparencies is based not only on the standard illumination but also on the choice of a standard minimum negative density of 0.3. In this method described above for attaining standard illumination, it was stated that the degree of magnification of the enlarger should be adjusted until a 15-second exposure through a density of 3.0 would produce a negative density of 0.3 when the No. 61 filter was employed and at a certain degree of development.

Now suppose that the transparency you wish to print has a maximum density less than 3.0. Without changing the lens-easel distance, you must either use a shorter exposure or a smaller lens opening. Kodak recommends that the lens opening be changed, not

the time of exposure. There is one great virtue in this method. Once the proper exposure ratios for the three filters have been determined and once the proper exposure for one of them, preferably the red filter, has been determined, all adjustments for transparencies of varying maximum or minimum densities can be made by changing the lens opening of the enlarger.

Except where the density range of the transparency is high (greater than 2.4) Kodak recommends that the exposure in making the separations be governed by the shadow density of the transparency. The deepest shadow in which detail is to be retained should have a density of 0.3 in the negative.

Now suppose that with given equipment, at a given degree of enlargement, which will provide "standard illumination" at the easel with a lens opening of  $f/4.5$ , the desired minimum negative density of 0.3 is attained when it represents a transparency density of 3.0, if the lens is actually opened to  $f/5.6$  when the exposure was made. What should the lens opening be if the transparency maximum density is not 3.0 but some other value?

The table below gives the required lens opening, and the values are plotted in the figure so that they can be used for ready reference.

LENS OPENING REQUIRED TO REPRODUCE CERTAIN DENSITIES AS 0.3 IN THE NEGATIVE IF TRANSPARENCY DENSITY RANGE IS 2.4 OR LESS

<i>Maximum Density of Transparency</i>	<i>Lens Opening</i>			
	<i>f/4.5</i>	<i>f/5.6</i>	<i>f/6.3</i>	<i>f/8.0</i>
3.0	<i>f/4.5</i>	<i>f/5.6</i>	<i>f/6.3</i>	<i>f/8</i>
2.8	<i>f/5.6</i>	<i>f/7</i>	<i>f/8</i>	<i>f/10</i>
2.6	<i>f/7</i>	<i>f/9</i>	<i>f/10</i>	<i>f/12.5</i>
2.4	<i>f/9</i>	<i>f/11</i>	<i>f/12.5</i>	<i>f/16</i>
2.2	<i>f/11</i>	<i>f/14</i>	<i>f/16</i>	<i>f/20</i>
2.0	<i>f/14</i>	<i>f/18</i>	<i>f/20</i>	<i>f/25</i>
1.8	<i>f/18</i>	<i>f/22</i>	<i>f/25</i>	<i>f/32</i>
1.6	<i>f/22</i>	<i>f/28</i>	<i>f/32</i>	



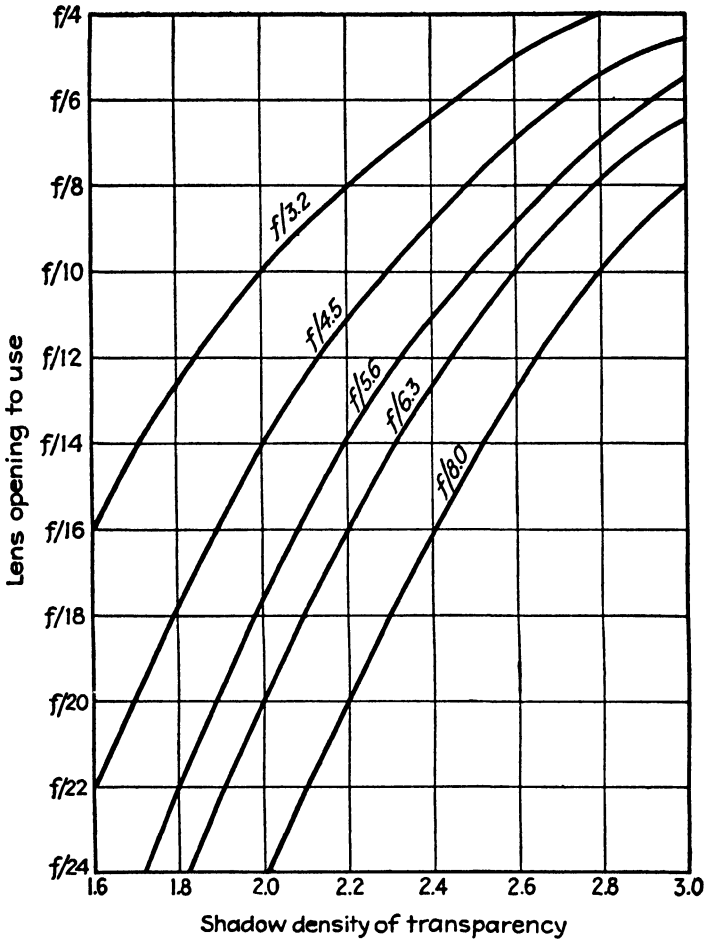

If, by a test, a given exposure through a density of 3.0 produces a given density on a negative at a given lens opening, then the curves will show the lens aperture required to produce the same density when the transparency density is some value other than 3.0.

If the density range of the transparency is greater than 2.4, then the negatives should be made so that the brightest high light in which detail is required has a negative density of approximately 2.0. In other words, the exposure is now controlled by the high light of the transparency instead of by the shadow. This method insures that detail will be retained in the high lights by avoiding overexposure of the negatives, although it may result in some loss in deep-shadow details. The table below is based on the same conditions as the table above—i.e., standard illumination, etc.

LENS OPENING REQUIRED TO PRODUCE CERTAIN DENSITIES AS 2.0 IN THE NEGATIVE IF THE TRANSPARENCY RANGE IS GREATER THAN 2.4

<i>Minimum Density of Transparency</i>	<i>Lens Opening</i>			
	<i>f/4.5</i>	<i>f/5.6</i>	<i>f/6.3</i>	<i>f/8</i>
0.8	<i>f/3.5</i>	<i>f/4.5</i>	<i>f/5</i>	<i>f/6.3</i>
0.6	<i>f/4.5</i>	<i>f/5.6</i>	<i>f/6.3</i>	<i>f/8</i>
0.4	<i>f/5.6</i>	<i>f/7</i>	<i>f/8</i>	<i>f/11</i>
0.2	<i>f/7</i>	<i>f/9</i>	<i>f/11</i>	<i>f/12.5</i>
0.0	<i>f/9</i>	<i>f/11</i>	<i>f/12.5</i>	<i>f/16</i>

To use these exposure tables, remember that they are based on the fact that certain densities are found to reproduce as certain negative densities. Thus in the first table it can be found, by trial, that a given lens opening at a certain degree of enlargement will produce a density of 0.3 through a transparency density of 3.0. If this lens opening is  $f/5.6$  and if the maximum transparency density is some value less than 3.0, then the lens will have to be closed down to the value indicated in the table. With a particular enlargement or a particular enlarger, the value of lens opening to produce a negative density of 0.3 through a transparency density of 3.0 may not be  $f/5.6$  but some other value. The first table gives values from  $f/4.5$  to  $f/8$  as the lens openings producing the given negative densities. The same values are plotted on page 216.

The second table works as follows. It is based on the fact, found by trial, that certain densities in the transparency representing the high light, say 0.6, produce a negative density of 2.0 when the lens openings are at the values shown in the table. If the minimum density of the transparency is some other value, then the lens must be opened up (if the density is greater than 0.6) or closed down (if the density is less than 0.6). Suppose that with a given setup and a given exposure time, the lens opening is found to be  $f/6.3$  when a transparency density of 0.6 produces a negative density of 2.0. If the minimum transparency density of a particular transparency turns out to be 0.2, the lens should be stopped down to  $f/11$  when the separations are made.

#### APPROXIMATE EXPOSURE AND DEVELOPMENT TIMES

*For Kodak Super-XX Panchromatic Sheet Film*

<i>Film</i>	<i>Wratten Filter</i>	<i>Approximate* Exposure in Seconds</i>	<i>Tray Development† DK-50 (1:1) at 68°F (20°C) in Minutes</i>
Kodachrome	Red No. 29 (F)	25	4
	Green No. 61 (N)	15	4
	Blue No. 49 (C4) plus No. 2A	40	6
Ektachrome	Red No. 25 (A) plus No. 66	50	4
	Green No. 61 (N)	15	4
	Blue No. 35 plus No. 38A	60	6

\* These figures are based on the Kodak Precision Enlarger A adjusted for "standard" illumination; other light sources may require different exposure times.

† Continuous agitation; approximate gamma = 0.7.

With standard illumination, Kodak Precision Enlarger, and the proper lens opening, the approximate exposure and development times will be found in the table on page 218.

### *Typical Example*

Now you can see how all this works out in practice.

As a starter choose a 35-mm Kodachrome with a maximum density of approximately 2.9, a minimum of 0.8. The enlarger is a Leitz Valoy with an  $f/3.5$  coated Elmar 50-mm lens about 10 inches from the top of the easel. The image on the easel is 4 inches in its small dimension, amounting to an enlargement of about  $4\frac{1}{2}$  times. A Weston meter with cap open reads about 3.2 when placed as close to the easel as possible without covering a mirror on the easel. The meter reading is taken by observing the mirror. The lens is opened to  $f/4.5$ ; the lamp is a GE 211 enlarger (75-watt) and voltage is 110.

Using a Tri-X pan Type B plate, a trial exposure through the green filter (Wratten No. 61) of 10 seconds looks good, but the densities are a bit high. Actual and final exposures of 8, 7, and 11 seconds at  $f/11$ , 110 volts through the Nos. 29, 61, and 49 plus 2A filters produce the densities shown below when the plates are developed individually in 4 ounces of DK-50 diluted with 4 ounces of water in trays at  $68^{\circ}\text{F}$  with continuous agitation.

<i>Filter</i>	<i>Exposure in Seconds</i>	<i>Development in Minutes</i>	<i>Maximum Density</i>	<i>Minimum Density</i>	<i>Density Range</i>
29	8	$4\frac{1}{4}$	1.6	0.4	1.2
61	7	$5\frac{1}{2}$	1.6	0.4	1.2
49 plus 2A	11	9	1.5	0.5	1.0

Now it can be seen that the blue-filter negative (49 plus 2A) was slightly overexposed (the minimum density is a bit higher than that of the other two negatives) and was somewhat underdevel-

oped compared with the other negatives. The fact that this negative has less contrast than the other two is fairly characteristic but can be remedied when the next batch of separations is made; and it can be compensated when the matrices are made by dye transfer. This sort of compensation is a nuisance, however, and you can save time and often save a picture by having the three negatives closer in balance than this.

### *Technique without Densitometer*

If you do not have benefit of a densitometer, then you must proceed as best you can. The inclusion of a transparent gray scale with the transparency and the use of the Density Kodaguide described before will enable you to make good negatives. A test exposure to the red No. 29 filter should be made, including those portions of the transparency containing the densest shadow and the brightest high light that are to be reproduced. Here is where the Stripmeter described under AIDS TO SEPARATION MAKING comes in handy. Expose and process the film as described in the Kodak table on page 218. If this negative seems satisfactory, proceed to test through the other two filters until satisfactory curves made by the density guide are obtained. Duplicate these conditions when actual separations are to be made. The enlarging photometer already mentioned will be very useful if a full-fledged densitometer is too expensive.

### *Use of Other Films for Separations from Transparencies*

The conditions outlined above are for the Kodak Precision Enlarger and deal with contact-size negatives only unless the enlarger setting producing standard illumination produces enlarged negatives of the desired dimensions. Other conditions, other apparatus, other films and developer will require different techniques. The data which follow will provide a start in the right direction; but the real data will have to be determined in the worker's own darkroom.

<i>Film</i>	<i>Filter Exposure Factors</i>			<i>Developing Data in Minutes</i>
	<i>No. 29</i>	<i>No. 61</i>	<i>No. 49</i>	
Isopan	2	1	5	8½, 8, 8; A-17, 68° *
Isopan	3.2	1	4	6½, 6½, 7; A-17, 68° †
Kodak Pan Plates	1.5	2	7	6, 6, 9; DK-50, 1-1, 70° ‡
X-F Pan	1	2	4	8, 8, 10; 6-D, 70° §

\* Manufacturer's data: GE No. 212 enlarger at 110 volts, based on correct exposure through No. 61 filter. Tray development, 30 rocks per minute. Ansco recommends factors of 8, 15, and 7 for daylight and 6, 8, and 8 for tungsten when Isopan is developed in Ansco 17 at 68°F as follows: A, 7¾, B, 7½, and C5, 8½ minutes when separation negatives are made directly from copy, not from transparencies.

† Same as above except with Ansco heat-absorbing glass filter.

‡ Plates developed to gamma = 1.0.

§ Leitz enlarger, 75-watt Osram bulb.

### *Good Negatives—the Key to Good Prints*

In all this separation business remember that the utmost care must be taken to produce good negatives, since all the rest of the techniques involved in making a good color print depend on these negatives. Not only must they be correctly exposed and developed, but also they must be clean and not scratched or covered with dust or lint, must be evenly developed and not streaked—even so slightly as to appear unstreaked to the eye—must not be light-struck or fogged. There is no dodging in making color prints; filling up dust holes in negatives with retouching goo is bad practice, since it is practically impossible to match the density of the negative. It simply does not pay to go into the darkroom and dash off a set of separations with the careless abandon commonly practiced in making black-and-white negatives. The time saved here will be lost later on.

You should develop pride in turning out a superb set of separations, and although those who view the final print made from such negatives may never know of the precision you have attained

in separation making, you will know it. Not only will you appreciate the fact that you have become an excellent technician, but perfect techniques in this first step toward a color print will pay dividends in better prints and saving of time and materials.

### *How to Determine Correct Exposures*

The ideal set of separation negatives made from transparencies will have the same characteristics as the ideal set made directly from the subject—i.e., the density range (contrast) of the negatives will be alike in each negative and will be suitable for the printing process to be employed; and corresponding steps of the gray scales on each of the negatives will have equal densities. This is too much to hope for unless the photographer has everything much better standardized than is the usual case and unless he is making separations day after day to get "his hand in" thoroughly.

If the negatives do not differ too much from each other and if none of the densities representing parts of the subject to be correctly printed are off the straight part of the negative-emulsion characteristic curve, proper compensation can be made in printing from the negatives so that a good print will be secured. With the new Kodak Dye Transfer process, the negatives can be quite different from each other in contrast and yet a good print can be obtained.

There are two ways for determining exposure times for making negatives from any transparency. If there is a white or other neutral-colored object in the transparency, you may work from this minimum density, determining the proper exposure to reproduce this density near the upper limit of the straight-line portion of the curve of the negative material. In other words, the critical part of the transparency is the minimum high-light density. On the other hand, you may work from the other end of the scale—i.e., from the maximum shadow density—endeavoring to bring it to a density of about 0.3 on the separation negatives. As far as the author has been

able to determine, it matters little which way you work provided you learn the two techniques so that your negatives are well matched. He endeavors to keep the maximum negative density no higher than 1.7, letting the shadow densities fall where they will on the negative curve.

The Kodak method of using the transparency shadow density as the critical point of departure has been described. Now observe a method by which the minimum transparency density can be employed. It is desired to represent this shadow density in the negatives with a density of, say, 1.5. Set up the transparent gray scale in the enlarger (or printing frame) and, making the best possible guess at the proper exposures, make negatives through the three separation filters. Develop them, again using the best possible guess and, after they are dry, measure the densities of the gray-scale steps on each negative, plotting them against the densities of the original transparent gray scale. If you are lucky and have made good guesses, your three curves will overlap.

Suppose that you guess that the exposures are 6, 12, and 24 seconds through the filters Nos. 29, 61, and 49. The curves when plotted look like those in the figure. Obviously the guesses at the proper exposures were not correct since the curves do not overlap; the red- and green-filter negatives needed more exposure compared with the blue-filter negative. Now what are the facts?

Select some density that is on the straight-line part of the curve, say a density of 1.0. Determine the original gray-scale step that produced this density of 1.0 in each of the negatives and translate these densities into opacities as follows.

<i>Filter</i>	<i>Gray-scale Density</i>	<i>Gray-scale Opacity</i>	<i>Actual Exposure</i>	<i>Correct Exposure</i>
29	0.77	5.9	6	6
61	0.63	4.27	12	16.6
49	0.89	7.76	24	18.3



Now, remembering that the greater the density of the original gray-scale step, the less is the exposure given the negative, you see that if the red-filter (29) negative is assumed to be correct, proper

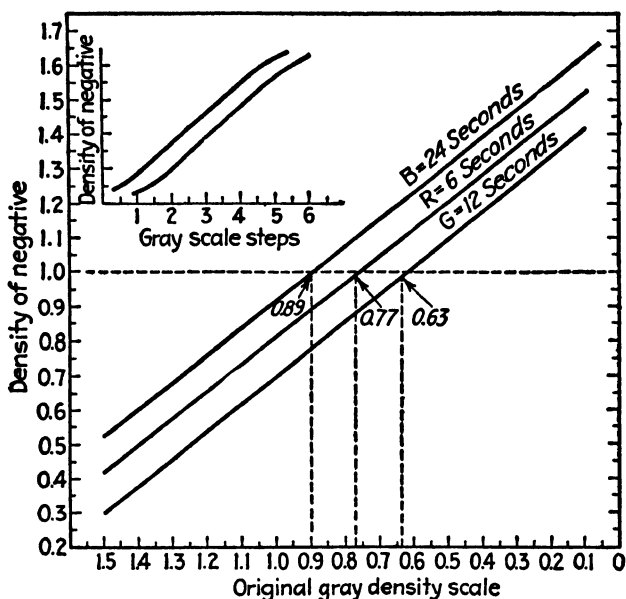

Results of tests through the separation filters showing that the development was correct (curves are parallel) but that the blue-filter negative had too much exposure, the green-filter negative had too little, both with reference to the red-filter negative. If the densities of the original gray scale are not known, the result of the test will have to be plotted as shown in the insert.

exposures to the blue and green filters will not be 12 and 24 seconds but some other values.

The first thing to do is to translate the original gray-scale densities into opacities (see the table on page 223). This shows that an exposure of 12 seconds through the No. 61 filter and through an opacity of 4.27 produced the same resulting density as an exposure of 6 seconds to the No. 29 filter through an opacity of 5.9. But

what you want is an exposure time for the No. 61 filter that will produce the same density on the negative through the same density on the original gray scale—i.e., through an opacity of 5.9. Since the green-filter negative curve is below the red-filter curve, this negative needed more exposure by the ratio of the opacities of the original gray scale, which produced the density of 1.0 in the negatives. On the other hand, the blue-filter negative has too-great densities and, therefore, its exposure of 24 seconds was too great. It needed less exposure by the ratio of the red to the blue opacities, which produced the density of 1.0.

These opacity ratios are R to G, 5.9 to 4.27, or 1.38; R to B, 5.9 to 7.76, or 0.76. Therefore, when making a new set of negatives, give the red-filter negative 6 seconds, give the green-filter negative  $12 \text{ seconds} \times 1.38$ , or 16.6, seconds, and give the blue-filter negative  $24 \times 0.76$ , or 18.3, seconds. These are now the relative factors for the filters, film, and light source employed—i.e., 6, 16.6, and 18.3. If the transparency has a key high-light density of 0.1, this high light will be represented on the negatives by a density of about 1.5.

Most transparencies, however, have their brightest high lights with densities of the order of 0.3 to 0.6 or so. Therefore, greater absolute exposures will be required than those used above.

If the required density of 1.5 will be attained by 6 seconds' exposure through a density of 0.1, what will be the required exposure to produce the same density through a density of, say, 0.6? Obviously more exposure will be required, but how much?

Again translate the densities to opacities and get the ratio. Multiply the 6 seconds required for the red-filter negative by this ratio. In this case, the density of 0.1 represents an opacity of 1.26; a density of 0.6 represents an opacity of 4 (approximately). The ratio is  $4 \div 1.26$ , or 3.15, and thus the red-filter negatives should have an exposure of  $6 \times 3.15$ , or approximately 19 seconds. The other two negatives will require exposures of  $19 \times 2.8$ , or 53, seconds and  $19 \times 3.1$ , or 61, seconds approximately.

There is another method of attaining the same end—i.e., getting the difference in the gray-scale densities that produce identical results. In this case the difference between the red and green records is  $0.77 - 0.63$ , or  $0.14$ . Look up the antilogarithm of this number. This turns out to be  $1.38$ , which is exactly the same value obtained by getting the ratio (R to G) of the opacities.

One more juggling of figures may be found a help in determining the correct exposure when separating transparencies having a key high light that can be measured. This high light is to have a density of  $1.5$  in the negative. Now to produce this density through a given opacity will require a certain number of seconds' exposure—taking everything else into account and standardizing on these conditions. Whatever makes up the additional factors, such as light source, the film used, the development, etc., may be represented by a "bugger factor" ( $k$ ) in the following formula, which relates exposure time ( $t$ ) required to produce a given density through a given opacity ( $O$ ).

$$t \text{ (seconds)} = k \times O$$

As an example; assume that a gray scale has been copied through each of the separation filters, that 3, 4, and 15 seconds exposure were used, as a first guess. When the three negatives have been processed and the resulting gray-scale densities measured, it is found that to produce a density of  $1.5$  on each of the three negatives it is required that the exposing light go through densities of  $0.62$ ,  $0.58$ , and  $0.62$ , respectively. Now you have enough data to determine the correct exposure for any given transparency key high light. Put down the data as follows.

<i>Filter</i>	<i>Exposure Time in Seconds</i>	<i>Original Density D Giving 1.5 in Negative</i>	<i>Opacity O Corresponding to the Density D</i>
No. 29	3	0.62	4.17
No. 61	4	0.58	3.80
No. 49	15	0.62	4.17

Now solve for  $k$  in the above expression.

$$\begin{aligned}
 k &= \frac{\text{time in seconds}}{\text{opacity}} = \frac{3}{4.17} = 0.72 \text{ for the No. 29 filter} \\
 &= \frac{4}{3.80} = 1.05 \text{ for the No. 61 filter} \\
 &= \frac{15}{4.17} = 3.60 \text{ for the No. 49 filter}
 \end{aligned}$$

Now suppose you have a transparency with a white cloud in it representing the brightest spot in the picture. On the densitometer this measures 0.29. From a table of logarithms or a slide rule you can determine that this density corresponds to an opacity of 1.95. Substituting this and the proper value of  $k$  in the original expression, since you know  $k$  for each of the three filters, you obtain

$$\text{No. 29 filter, } t = 0.72 \times 1.95, \text{ or } 1.4 \text{ seconds}$$

$$\text{No. 61 filter, } t = 1.5 \times 1.95, \text{ or } 2.05 \text{ seconds}$$

$$\text{No. 49 filter, } t = 3.60 \times 1.95, \text{ or } 7.03 \text{ seconds}$$

These figures can be smoothed off to 1.5, 2, and 7 seconds, respectively, with the certainty that each negative exposed to the transparency will have a maximum density fairly near the required 1.5.

### *Additional Notes*

If the enlarger has a pressure plate that holds the negative flat against the aperture above the lens, the transparency need be mounted only on a sheet of glass and not covered with another glass plate. In this manner, one chance of producing flaws due to imperfections in one sheet of glass can be avoided. If the easel will hold film flat against the base, you need not cover the negative material with a glass plate. Each worker must determine for himself the best procedure.

There is one great advantage in blowing up the negatives so that the images are larger than those on the transparency, especially if the transparency is small in size, say 35-mm to  $3\frac{1}{4}$  by  $4\frac{1}{4}$  inches.

It nearly always happens that some slight spotting of the negatives is necessary because of flaws in the transparency, dust on the negative film or on the pressure glass plate, or minor imperfections that occur in the exposing and developing process. Spotting on small negatives is difficult; such spotting is much easier if the negatives are of good size, say occupying the middle of a 5 by 7 or 4 by 5 film.

### *The Curtis Enlarging Printer*

Another aid to separation making is a recent addition to the Curtis line of color materials and processes. This is a printer that makes it possible to enlarge 35-mm transparencies up to 4 by 5 inches with considerable precision. It consists of a transparency carrier on a movable microstage, a source of light, heat-absorbing and separation filters, a mount for a 2-inch lens (supplied by the manufacturer or by the amateur if he has a regular Leica lens), and a means for holding the separation negative material. All parts are mounted on an optical bench so that the position of each part with respect to the others is rigidly maintained, even though the instrument as a whole may be subject to vibration.

With this instrument it is possible to make negatives from transparencies, selecting any portion of the transparency that is to be reproduced in a paper print, to make positive prints from negatives (such as monochrome paper prints from 35-mm negatives), to make contact prints, and to make masks for lowering contrast and for improving color in separation making.

Anyone having an appreciable number of prints to make from 35-mm color films would find this instrument a good investment even at its price of approximately \$150.

### MASKING

By a process called "masking" reproductions made from color transparencies or made directly from the original subject can be improved, but masking is only an added fine point and is some-

thing for the advanced amateur to do when his critical viewpoint has reached the place where the ultimately perfect print is desired. There are various degrees of complexity of the masking processes that the photographer can employ; the simplest can be used in making a print from any transparency. First the general methods will be described and then the technical reasons why masking helps will be covered.

Briefly, masking consists of one of two methods. In one system a low-contrast negative of the transparency is made, usually through a filter. This negative is bound up in register with the transparency. Separation negatives are made from the combination of positive transparency and negative mask by the customary techniques. The combination of positive and negative has less contrast than the transparency alone, since the lighter (high-light) portions of the positive now have bound up with them the darker portions of the negative. The shadow parts of the transparency are not so much affected as the high-light portions, since the densities in the negative representing these shadows are quite thin.

The first effect of the mask, therefore, is to lower the contrast of the transparency so that a print more nearly representing the original subject can be made. Suppose that the high-light portion of a given transparency has a measured density of 0.5 and that the shadows have a density of 2.3. The density range of the transparency, therefore, is  $2.3 - 0.5$ , or 1.8. Since the color-printing material may have a useful density range of only 1.0, it is apparent that the full range of the transparency cannot be reproduced. Either the high lights will turn out to be blank white without details or the shadows will be completely black without details. Suppose that a negative is made of the transparency so exposed and developed that the 0.5 density of the transparency is represented in the negative by a density of 1.0 and that the transparency density of 2.3 is represented in the negative by a density of 0.3. Since the negative and positive are mounted together and in register, the correspond-

ing densities add so that the high-light density now becomes  $0.5 + 1.0$ , or  $1.5$ , and the shadow density becomes  $2.3 + 0.3$ , or  $2.6$ . The combined density range has now become  $2.6 - 1.5$ , or  $1.1$ , instead of a range of  $1.8$  considering the transparency alone. In this manner the density range can be reduced as little or as much as desired, depending on the contrast of the negative mask.

In addition to reducing the density range or contrast of the transparency, the mask can improve the color relations of the final print since, if the negative is made through a blue-green filter, the blues and greens will be reduced in contrast while the reds in the transparency will be affected much less. In the final print, therefore, the reds will gain in brilliance. If the filter through which the mask is made is of another color, the effect in the print will take place in colors other than red. In this manner the photographer can control the brilliance of the print in practically any way he desires.

Similar results can be obtained after the negatives are made by the following procedure. The negatives should be developed to somewhat greater contrast than if they are not to be masked, although good prints can be made from a set of separations which are not intended to be masked but which, later, are masked. By this plan, a positive transparent print (on film or plate, preferably the latter) is made from the red-filter negative. This positive is developed to a low contrast and, when dry, is bound in register with the negatives in turn as they are printed. The positive material need not be panchromatic. When the prints are made, the mask not merely reduces the contrast of the red-filter negative but, in addition to the reduction of contrast, effects some color correction.

This method entails much precision optical work, registering the positive three times, once with each of the negatives. To get out of some of this work, three masks can be made exactly alike and bound up, once and for all, with the negatives. In general, the simplest plan is to make the negative mask directly from the transparency

and to bind it up with the transparency before the separation negatives are made.

A vast amount of theoretical and experimental work has been done on the general subject of masking as a means of correcting color errors caused by the fact that the dyes employed in making transparencies and prints are not perfect. A list of references to the subject will be found at the end of this chapter.

### *Masking Techniques*

The big trouble with masking is the difficulty of accurately registering the negative mask with the transparency, especially if 35-mm transparencies are used as the original material from which a print is to be made. It can be done, however, and the first method to be described follows the older practice in which this registration problem is rather serious. Then will follow a more modern development in which the registration difficulty has been lessened.

### *How to Make a Mask*

Suppose, then, that a transparency is to be used as the basis of a color print and that a mask is to be made for it. This mask is to be made by contact and on a panchromatic plate somewhat larger than the transparency, so that there will be finger room around the image by which to handle the mask and, later, on which to mount the transparency.

The author has used Wratten and Wainright plates, now called Kodak pan plates, vest-pocket size ( $1\frac{5}{8}$  by  $2\frac{1}{2}$ ) for 35-mm transparencies and 5 by 7 plates for 9- by 12-cm and 4 by 5 transparencies.

Mount the transparency in one corner of the glass of a printing frame so that it will be in the center of the masking plate when the latter is placed in the frame. Be sure that the glass is perfectly clean and that there are no pieces of lint or other dirt on the transparency or the glass plate. If you are careful and can place the masking plate



in the printing frame in absolute darkness without disturbing the position of the transparency, then no actual mounting material (such as mounting tape) need be employed, and better contact between the transparency and the negative material will result. The transparency is to be placed with the glossy side next to the glass. Alongside the transparency mount or place a transparent gray scale, preferably having about the same density range as the transparency, say with minimum and maximum densities of 0.5 to 3.0.

As a light source, an enlarger can be employed or a simple light box in which is placed a 10-watt incandescent lamp. An ordinary safelight can be used if means are provided for mounting, between the light and the printing frame, the filter through which the mask is to be made. If the safelight or light box is used, a mount can be made over the aperture so that the filter can be held during the exposure. Similarly, if the enlarger is employed, the filter should be mounted in exactly the same manner as when separation negatives are to be made.

As a general practice, a red or magenta filter should be used, since the blues and greens seem to suffer most in making prints without a mask. By the use of a red filter, such as Wratten No. 25 or Defender 50-P, which is magenta, reds are held back from portions of the subject matter in which they might degrade the blues and greens.

In darkness the negative masking material (panchromatic) is placed over the transparency in the printing frame and the frame back is locked tight and then placed in position with respect to the exposing light and an exposure is made. The first exposure will be a test to get some idea of how much exposure is required. This test should probably be made with a transparency that the photographer does not care much about, since in the ensuing process he may get finger marks on it or otherwise spoil it before his technique is thoroughly worked out.

The negative is developed for  $2\frac{1}{2}$  or 3 minutes in a soft working developer, such as D-76, fixed, washed, and thoroughly dried. This

will produce a weak negative in which the denser portions correspond to the high lights of the positive transparency and in which the less dense portions represent the shadows of the transparency.

The mask should have a maximum density of 1.0 or less and should be so exposed that there is little detail in the deeper shadows and not much in the high lights. The middle tones should be well exposed. As an example, the author finds that an exposure of 5 to 10 seconds is about correct under the following conditions: a 35-mm Leitz Valoy enlarger is used with the light box elevated to the top of the vertical post, a lens aperture of  $f/12.5$ , Kodak panchromatic plates, a No. 25 filter, and a 3-minute development in D-76. Since much depends on the lamp and the voltage at which it is operated, every man must determine the exposure for himself.

Now comes the troublesome job of registering mask and transparency. If a light box is made out of wood or any other material, with the top covered with an opal glass or with two sheets of plain glass with a few sheets of typewriter paper between, then the mask can be mounted image side up to the top glass with tape so that it cannot move around. Affix a small piece of tape along the edge and on the glossy side of the transparency. Bend the tape so that it does not make contact with the mask until the correct moment has arrived. With the naked eye effect a partial register, and then by use of a magnifying glass perform the best register that is possible along the edge to which the mounting tape is attached. Press down the tape lightly and then see if the opposite edge of transparency and mask are in register.

The process now becomes one of slowly getting two edges in absolute register, and when this has been accomplished, one of these edges can be taped down to the negative or mask. If the photographer is myopic (nearsighted), he can remove his spectacles, whereupon he will find that he can bring his eye very close to the transparency and in effect secure the advantage of a magnifying lens without the actual bother of using one.

All during this period of moving the transparency about there is every chance in the world of getting finger marks on the transparency. This is the reason for advising that a preliminary test be made with a transparency that is not highly valued. After the mechanical details have been worked out so that the actual registry process can be carried on without damage to the transparency, then the photographer can proceed to the serious business of making a mask and a print of an actual subject.

It is advisable to tape the transparency to the mask only along one edge, leaving the other free to move, so that when the sandwich is placed in the printing frame or in the enlarger in preparation for making the separation negatives, the transparency will not bulge in the middle but will find its normal position without trouble.

The author has found that this registry business is nerve-racking and that there is little fun attached to it to compensate the work involved. If, however, a piece of blotting paper or other protection is placed over the transparency so that the fingers can touch it only along the edges and if a sheet of glass is placed over this protective material, then the whole affair can be pushed around with the certainty that the transparency is not only protected from fingerprints but that it is in good contact with the negative over its whole surface and not bulging somewhere. In this manner it is practically certain that when one edge is finally taped down tightly to the mask, register will not be disturbed when the sandwich is placed in the enlarger or printing frame in preparation for making the separation negatives.

Every man must work out his own technique, of course, but these suggestions will provide a starting point.

### *Unsharp Masks*

The registry problem can be alleviated to a very great extent by a most ingenious development involving masks, which in themselves are not sharp. There are no sharp edges that must be brought into

alignment with each other, and since misalignment does not show up in the separation negatives or in the final print, the whole bugaboo of making masks is relieved.

In general, there are two methods of making unsharp masks. One involves physically separating the transparency and the negative-mask material when making the exposure, for example, by several sheets of transparent film base, or by the use of one or more sheets of ground celluloid or other fine-grain diffusion material such as Adlux or the material often bound up with transparencies for viewing purposes. A variation of this method of making diffused or unsharp masks simply places the transparency and the masking material back to back instead of emulsion to emulsion and places a sheet of glossy printing paper next to the emulsion of the masking material when the exposure is made.

The following description is taken from Defender publications. The transparency is placed on the glass of the printing frame so that the glossy side will face the light source; next a sheet of  $\frac{1}{16}$ -inch glass is laid over the transparency and covered with one or more sheets of the diffusing material. Then comes the negative material, which may be a film instead of a plate in this case since registry is not such a problem as with sharp masks. The negative material is placed so that its emulsion faces the diffusing sheets. Thus the two film emulsions, transparency and negative, will face each other. The exposure is made through a 50-P filter and is sufficient so that with X-F pan film developed in 6-D for 3 minutes at 68°F, the finished mask shows just perceptible detail in the shadows.

When the mask has been processed and is dry, it is registered emulsion to emulsion with the transparency and is taped to the transparency along one edge. The actual registry process can be done without the aid of a magnifying glass.

The optimum degree of diffusion varies directly with the size of the original transparency, and experimental trials have shown that one sheet of Adlux is sufficient for miniature films; two sheets of

Adlux are proper for  $2\frac{1}{4}$  by  $3\frac{1}{4}$  to 4 by 5 films; and three sheets can be used for larger transparencies. The 50-P filter is magenta in color and the author has found that color rendition is definitely improved by the use of masks made in this manner.

Mere separation of transparency and masking material will cause sufficient diffusion. Ansco recommends the following procedure. Four sheets of ordinary clear-base film are fixed out without exposing or developing the film. This gets rid of the emulsion so that only the clear-base material remains. These sheets of film are placed between the transparency and the masking material, which may be any good panchromatic emulsion. An opal glass between the light source and the transparency increases the diffusion. With a 10-watt lamp in an ordinary safelight housing 4 feet from the color transparency, the exposure on Isopan film will be about 4 to 8 seconds when the film is developed in Ansco 17 for 3 minutes at 68°F. A Wratten No. 67 blue-green filter is recommended for improving the reds in the print. The mask will have a maximum density of from 0.5 to 0.6, which are the recommended values. The processed negative is mounted in contact with the transparency, emulsion to emulsion, as described above. If no filter is used, the only effect will be to reduce the over-all contrast of the transparency and of the final print; no color correction will be produced.

Masks must be made on panchromatic material and so processed that a black image results. If film material or developer produces a colored mask, this color will be added to the transparency and the end point may be anything but what the photographer wishes.

The second general method for making unsharp masks is quite different and requires—of all things!—a phonograph turntable. By this technique, the transparency is mounted in a printing frame, over it is placed a spacer and then the masking film or plate, whereupon the printing frame is closed and turned over so that the glass side faces upward. The frame is now placed on the turntable. The light source with filter is mounted at an angle with respect to the

center of the printing frame and turntable and about 6 feet above it. The turntable is rotated during the exposure.

More details of this interesting modification of the unsharp mask technique will be found in a Kodak pamphlet, *Kodak Fine Line Process* and in the *Eastman Bulletin for the Graphic Arts*, No. 8, 1946, as well as in the items noted in the bibliography at the end of this chapter.

### *Use of Kodak Masking Film*

In a communication from the Kodak Research Laboratories, No. 1042, reproduced in *The Journal of the Photographic Society of America*, November 1945, Robert P. Speck describes another masking method that has certain advantages.

In this method two masks are made, but since only one is necessary to achieve marked improvement, it will be described first. A special film known as Kodak Masking Pan film is employed as the negative material. This film was originally produced for use in a method of masking that involved cementing a thin film to the transparency before exposure and maintaining it in contact with the transparency throughout the process of making the separation negatives. In this manner the register problem simply does not exist, since the two films are cemented together before the masking image is created.

In Mr. Speck's system the transparency is placed on the glass of the printing frame so that the emulsion faces the light source. The support side of the masking film is placed in contact with the support side of the transparency. Next to the emulsion side of the masking film is placed a sheet of glossy bromide or imbibition paper. A No. 25 (red) filter is used, and with a light box in which there is a 500-watt 3200°K PS-25 Mazda lamp 20 inches from the transparency and with a sheet of opal glass between filter and light source, a trial exposure of about 10 seconds is recommended.

After the mask is processed, it is registered with the transparency

emulsion to emulsion (and not back to back, as it was made). Since the masking film is really designed to be stripped from its base when it is cemented to a transparency, care must be taken to see that this stripping does not take place when the mask is to be made as described above. (Also see page 247.)

The mask is developed in DK-50, to which has been added a 0.2 per cent solution of benzotriazole in a ratio of 8 parts of developer to 1 part of the benzotriazole. Development for 3 minutes at 68°F gives the correct contrast. Rinse in water or SB-1a stop bath, fix in nonhardening fixer, such as F-24, for 3 minutes, wash 10 minutes, and dry. The image will be dead black.

The exposure should be such that it will reproduce a density of 3.0 in the transparency (or gray scale) as 0.1 above the film fog (which is very slight). The development recommended will then reproduce a gray-scale (or transparency) density of 0.05 as a density of 1.3 in the mask. Since the minimum density of most transparencies will be of the order of 0.5, the maximum density of the mask made in this way will be less than 1.3.

The author has found this method of making masks very effective, and until someone comes up with much better methods than the last two described, he will probably make all prints by the use of one or the other of the two systems.

### *Other Advantages of the Mask*

If the transparency is extremely contrasty and it is desired to reproduce most or all of the density range, the mask can be made by giving only part of the exposure through the filter and making the rest of the exposure without benefit of filter. In this manner, the contrast of the transparency will be reduced without danger of over-correction of color. Defender recommends that two-thirds of the total exposure be given without filter as a trial.

Mr. Speck, in his communication describing the use of the masking film, states that a

. . . surprising amount of retouching can be done on the mask with a black retouching pencil. In portraits, especially, skin blemishes in the high-light areas can be filled in. Harsh face lines can be softened by grading the "darkness" of the line out from both sides until it is toned into the surrounding areas. Dark lines or areas cannot be remedied by this method, but all areas lighter than their surroundings can be blended in and made to disappear. Complete correction requires retouching the separation negatives.

Communication No. 1042 (*The Journal of the Photographic Society of America*, November, 1945) describes a further refinement of the masking procedure in which a mask of high contrast is made on Kodalith Orthochromatic film and is bound up with the transparency before the color correcting mask is made. This auxiliary mask is designed to overcome the defects caused by high lights falling on the toe of the transparency material characteristic curve and being flattened in contrast by so doing. The auxiliary mask opens up these high-light details.

Mr. Speck states that the use of both masks gives an increase in contrast in the high lights that is the principal part of the scale from which the eye derives its sense of sharpness or unsharpness. The eye may see a slight improvement in the middle tones by the use of the unsharp mask, but the principal advantage, aside from color correction and general decrease in density range, is in the high lights.

When the mask is made through a red filter, such as the No. 25, the masked transparency will have its densities increased in the regions of red, yellow, and white, but little density will be added to the blue and green areas. Thus the red, yellow, and white areas may be said to be "held back" when the separation negatives are made, since these densities have been increased by the mask, whereas the blue and green densities have not been so increased. The correction filter, therefore, helps to restore the relative brightness of the colors of the transparency to their proper relation to the colors of the original subject.



For a general description of the application of unsharp masks to ordinary black-and-white print making, the reader should see "Print Control with Blurred Positive Masks," by Marvin J. Johnson.\* Another good article on the subject is to be found in *The Journal of the Photographic Society of America*, March, 1945, by J. A. C. Yule. This is Communication No. 956 from the Kodak Research Laboratories. In these articles it is shown how the use of such masks actually gives the visual impression of greater detail in the final print.

Apparently what happens is something like this: the mask reduces the large-scale contrast, and it is the small-scale contrast that gives the appearance of sharpness of detail. Consider a negative (the subject being considered is that of making a positive mask to be bound up with a negative for the purpose of making a black-and-white print, but the same consideration is true of the effects of a negative mask bound up with a positive transparency for the purpose of making a color print) containing fine but not perfectly sharp details that are totally lost in the diffused mask. It is known that an increase in contrast by increasing the density difference at the edge of a detail will increase its apparent sharpness. Since the mask does not resolve or contain the fine details, it has no effect on them, but it does reduce the general contrast of the negative. If this reduction in density range is such that the negative has only half its original contrast, the contrast of the fine details can be doubled in making the print, provided the print overcomes the over-all flattening effect of the mask—by using a more contrasty paper, for example.

### *Other Masking Methods*

Numerous methods have been worked out for improving color rendition in making prints from transparencies. Not all of them

\* *American Photography*, March, 1943, p. 14.

require a mask for the transparency. For example, separation negatives made in anticipation of print production can be masked, especially if they happen to turn out too contrasty for good print reproduction. In this case, a positive mask can be made on practically any film or plate material, panchromatic or not, and bound up with the corresponding separation negative. Such a mask reduces the contrast of the negative and brings the density range within the limits of good reproduction, considering the printing medium to be employed.

In this manner, color correction, too, can be effected even after the separation negatives have been made. The negatives should have greater contrast (density range of about 1.3) than will be the case if they are to be printed unmasked—at any rate, the density range after masking should be within the range of the printing material. Developing the negatives 50 per cent longer than is customary will bring the contrast to approximately the correct value.

The simplest method of attaining some color correction in this manner is to make a positive mask from the red-filter negative. This positive can be bound up with the individual negatives in turn when the prints are made from the negatives. As in any other masking method, the mask should be developed to low contrast. The registration problem is no worse than it is when masking a transparency and, in fact, may be somewhat simpler since both negative and positive are black—*i.e.*, neither is colored. The mask can be made on film, but the registration problem is simplified if plates are employed. For example, Kodak 33, Seed 23, or any similar emulsion is satisfactory.

There is one great virtue in making the masks after the negatives have been made, especially if miniature transparencies are the material to be printed. This advantage lies in the fact that the negatives can be larger than the transparency, thus simplifying the registration problem. The author usually makes separation negatives

from 35-mm transparencies on 5- by 7-inch film, the actual image being of the order of 4 by 6 inches. Registering a mask with one of these negatives represents a much simpler job than registering a sharp mask with the transparency.

It is quite possible that the unsharp-mask method can be employed in masking negatives and, if so, the registry difficulty would be still further simplified.

### *How Masks Improve Color*

What you are trying to do with masks is twofold: first, you are trying to reduce the contrast of the transparency or the separation negative, and second, you are trying to effect some color correction. This correction is necessary because the dyes or pigments or inks used in color printing are imperfect—i.e., an ideal blue-green dye should reflect back to the eye about equal parts of blue and green light, a perfect magenta dye should reflect almost equal quantities of blue and red, a yellow dye should reflect equal amounts of green and red. These ideal color materials would absorb completely the colors they did not reflect. The table below indicates the ideal situation.

<i>Dye Color</i>	<i>Should Reflect</i>	<i>Should Absorb</i>
Blue-green	Blue and green	Red
Magenta	Blue and red	Green
Yellow	Green and red	Blue

The yellow dyes obtainable are quite good, but the magentas and cyans (blue-greens) are not so good. The magentas absorb too much blue and, therefore, reflect too little blue; the cyans reflect too little green. These deficiencies are such that when they occur only once, as in making a transparency, they may not be serious. The reproduction is not exactly like the original, but the difference can be discovered only by critical comparison of the transparency

with the original subject matter. On the other hand, when the transparency is to be employed as an original from which a color print is to be made, then the dye deficiencies occur twice, once in making the transparency and again in making the print. This double degradation may make the final print look quite unlike the original subject from which the transparency was made. As a matter of fact, when blues and greens are the important colors in a print, masking will help accentuate them even if the separation negatives are made directly from the original copy and not through the intermediate step of making a transparency.

The effect of these deficiencies in magenta and cyan printing materials is to make prints that are dark in greens and blues. Since yellow and orange are combinations of red and green, they can be degraded, too, since the greens are deficient.

Now the question arises, how does a mask help the situation?

Copy on a transparency material, such as Kodachrome or Ansco color film, three color patches, blue, green, and red. Since the transparency component colors are magenta, cyan, and yellow, the three original colors must finally be represented by varying amounts of magenta, cyan, and yellow dyes. Assume further that the original colors are such that if the transparency dyes were perfect, the blue would be represented or made up of only magenta and cyan dye (no yellow), that the red would be represented only by magenta and yellow dye (no cyan), and that the green would be made up only of cyan and yellow (no magenta). The transparency dyes, however, are not perfect and, instead of the magenta reflecting equally well the blue and red, it reflects, say, only 20 per cent blue and 70 per cent red; the cyan reflects 70 per cent blue and 20 per cent green instead of 50 per cent of each. The yellow dye, you can assume, is correct.

The ideal situation and that which might actually take place can be summarized as follows:

<i>Transparency Dyes</i>	<i>Original Colors</i>					
	<i>Blue</i>		<i>Green</i>		<i>Red</i>	
	<i>Ideal</i>	<i>Actual</i>	<i>Ideal</i>	<i>Actual</i>	<i>Ideal</i>	<i>Actual</i>
Magenta	50	(20)	0		50	(70)
Cyan	50	(70)	50	(20)	0	
Yellow	0		50		50	

Now it can be seen that in the transparency the original blue color will lack magenta and will be too cyan or greenish; the green will be deficient in cyan and will be too yellowish; the red will have too much magenta. Even though the yellow dye is perfect, none of the three original colors will be reproduced correctly in the transparency. If you attempt to copy this transparency, using dyes of the same general sort, the deficiencies noted above will be further increased; and it is then no wonder that prints from transparencies are not always what the photographer wishes and expects.

To the transparency must be added something that compensates the lack of certain colors. Thus if the blues are represented by too much magenta and too little cyan so that the blues are too red, then to the transparency must be added some *minus* red. If you make a negative of the transparency through a red filter that passes red but no blue or green, then the dark portions of this negative will represent red and, when bound up in register with the transparency, these dark portions will register with the red parts of the transparency. The negative will be light where green or blue exists in the transparency and so there will be nothing added to these portions of the transparency when the negative is registered with it.

When separation negatives are made, the red parts of the transparency will be denser by the amount of silver in the negative mask, so that the separation negative made through the red filter will be less dense than it would be if the mask were not present. Since the

positive made from the red-filter negative is printed in cyan (blue-green), it is seen that the blues and greens have been improved by the amount that has been subtracted from the red. In other words, superimposing on the transparency a mask made through a red filter is equal to adding blue-green to the transparency. This mask affects all colors in the proportion that red exists in the original scene. Since it is the blues and greens that suffer most in making prints from transparencies, this single mask bound up with the transparency produces a good average color correction. If greater accuracy is desired, then more than one mask will be required or a single mask made in such a manner that part of the exposure is through a filter of one color and the remainder of the exposure is through a filter of another color. Similarly, when positive masks are made from a red-filter negative and are bound up in register with each of the separation negatives, blues and greens are improved.

### *Masking the Negatives*

In a *Defender Trade Bulletin* (Winter Issue, 1941) the following recommendation was made to overcome some of the deficiencies of dyes employed in making prints from separation negatives made directly from original copy, not from transparencies. Three positive masks are to be made, one from the green-filter negative and two from the red-filter negative. The green-filter mask is bound up with the blue-filter negative; one red-filter mask is bound up with the red-filter negative and the other red-filter mask is bound up with the green-filter negative. The density range of each mask (Seed 23 plates were recommended) should be about one-third the density range of the negatives. By registering all three masks together and comparing their combined density with one of the negatives, a check can be made of the approximate correctness of the densities.

Many other systems of multiple masks have been worked out and have been published. All of them are complicated, since they require very accurate exposures and development so that the required

densities are produced. These more complex corrective measures are quite out of the amateur class.

As proof of this statement, consider the following suggestions from J. S. Friedman for making color-correcting masks and separations from Kodachrome as published in *American Photography*, August, 1943. Dr. Friedman outlines the following procedure:

For the green-filter separation, the mask to be registered with the transparency is exposed through a Wratten filter No. 32 and developed to a gamma of 0.65. The separation negative is made from the masked Kodachrome by exposing through a Wratten filter No. 61 and developing to a gamma of 1.00, or whatever gamma is required by the printing process. For the blue-filter separation, the mask is exposed through a Wratten filter No. 61 and developed to a gamma of 0.60. The separation negative is made from the masked Kodachrome by exposing through a Wratten filter No. 47 and developing to a gamma 1.15 times that of the green-filter negative. For the red-filter separation, the mask is exposed through a Wratten filter No. 44 and developed to a gamma of 0.44. The separation negative is made from the masked Kodachrome by exposing through a Wratten filter No. 29 and developing to a gamma of 0.70, that of the green-filter negative. Alternatively, the green separation mask may be exposed through the No. 29 filter and developed to a contrast of 0.5, and the red separation mask may be exposed through the No. 61 filter and developed to a gamma of 0.36.

It should be noted that none of the methods described involve any deficiencies in the transmission bands of the separating filters, the spectral characteristics of the light by which the separation negatives are made from the transparencies, or anything but the inherent lack of perfect absorption and reflection characteristics of dyes. It must also be noted that one set of masks (or one mask) will only correct for the deficiencies in dyes used in making the transparency. Another set of masks may be required to correct the imperfections in the dyes with which the final print is made.

One of the virtues of masking the original transparency with a negative, or negatives, is that the separation negatives can then be

masked to overcome the imperfections in the dyes, pigments, or inks with which the final print is made.

For ordinary amateur efforts, no masking whatever is recommended until the amateur begins to look at his prints with an eye that has become quite critical. If he does not show his friends his prints alongside the transparencies from which they were made, the color defects are not likely to be noted. As a matter of fact, his own techniques will have to be letter-perfect before lack of color balance due to his own efforts will be much greater than any lack due to the dyes he may employ.

The next step, after making prints without any mask, is to make a single positive mask by the methods described above. This is quite likely to satisfy his critical eye completely, especially when he considers the law of diminishing returns plus a short contemplation of the bother and trouble he is likely to get into when he studies the more complex masking methods.

### *Masking Ektachrome Transparencies*

The following notes are taken from experience with printing by the Dye Transfer method from Kodachrome and Ektachrome transparencies and from Eastman Kodak literature.

Making a single mask on Kodak Pan Masking film by the diffusion method materially aids in getting the best possible color rendition from Kodachrome; two masks are required when working from Ektachrome. Neither the single- nor the double-mask method is difficult; nor is either necessary for a good print especially when red, orange, or yellow is the principal color. When blue or green is important, a mask will help greatly.

In the single-mask method a magenta (Wratten No. 33) filter is required (Wratten F, No. 29, will produce brighter blues); in the two-mask system one mask is made through a Wratten F (red) and the other through a Wratten X1 (No. 11, green) filter. The one-mask method will improve reproduction from Kodachrome; the



two-mask method will add another degree of perfection—and it is a must when masking Ektachrome.

Separation negatives are made in the usual way after the transparencies have been masked, with the exception that they are developed a bit longer to increase the contrast. For example, instead of developing to a gamma of approximately 0.7, as is the case with negatives made from unmasked transparencies, the author finds it necessary to increase the gamma to approximately 0.9 when the transparencies are masked. The same development is employed under these conditions as is used when separation negatives are made direct from the subject (not from transparencies).

### PROPER ORIENTATION OF MASKS AND TRANSPARENCIES

Early in his work with color printing, the photographer should determine the proper orientation of transparencies with respect to the printing light and the separation material so that he will not be embarrassed by having produced a good color print with the expectation that it is reversed right to left. This orientation problem comes up again when masks are to be registered with the transparency before the separations are made.

**MATRICES BY PROJECTION.** Register the mask on the base side of the transparency. Place the transparency so that its emulsion faces the emulsion of the separation material no matter whether the separations are made by contact or by projection. Place negatives in enlarger with emulsion facing the light source.

**MATRICES BY CONTACT.** In this case register the mask on the emulsion side of the transparency; place the emulsion sides of mask, transparency, and separation-negative material so they face the light source. In exposing matrices, place the emulsion side of the negative in contact with the base side of the matrix material.

**ORIENTATION IN MAKING THE MASKS.** Whether the one- or the two-mask method is employed, place the transparency, the diffusing

medium (Kodapak Diffusion Sheet, 0.003 inch), and the Pan Masking film so that all three emulsion surfaces face the exposing light—the matte side of the diffuser being considered as its emulsion surface.

### *Exposure and Development of Masks*

The masks should have sufficient exposure so that they register the full density range of the transparency, i.e., there should be sufficient exposure so that the details in the deepest transparency shadow are just perceptible.

In the two-mask system, the red and green separations are made through the red-filter mask, the blue separation through the green-filter mask.

Development of Pan Masking film in DK-50 diluted 1 to 4 for about 2½ minutes at 68° will produce the proper contrast. Rinse in water, fix in an acid hardening bath, wash and dry as usual.

### *Masking Direct-separation Negatives*

Again, if greens and blues are the important colors to be reproduced, it pays to mask separation negatives made direct from the original copy. While the author has made such masks on film and on plate and has employed several types of film, he finds that a non-pan film or plate serves very well; for example, Kodak Commercial film or Kodak 33 plates make good masks when exposed properly and when developed in DK-50 diluted 1 to 4 for 2½ to 3 minutes at 68° F. The negatives made direct from copy should be developed somewhat longer when they are to be masked.

For best possible results, make three masks, two from the red-filter negative and one from the green-filter negative. Register the red-filter negative masks with the red- and the green-filter negatives, and register the green-filter mask with the blue-filter negative when printing. These masks may be made by the diffusion method, or

they may be made by contact, *i.e.*, sharp masks. If the separation negatives are on film, it is easier to register the masks if they are diffuse. If, however, both negative and mask are to be on plates, then the registration problem is simplified and diffuse masks are not necessary.

The author has found that this masking method utilizing Kodak's special masking film is not difficult in any way. The film is thin, it dries flat, has a dead black image color and processes simply. There is no doubt that a proper mask made by the diffusion or unsharp manner described will definitely improve the color rendering of any transparency, not only because the mask lowers the contrast and enables the photographer to reproduce more details both in shadows and in high lights, but the mask made through the proper color of filter provides better colors in the final print.

## BIBLIOGRAPHY ON MASKING

- CENTA, J. M.: "Color Printing with Pan-Chroma Relief Film," *The Journal of the Photographic Society of America*, 11:22-28 (January, 1945); 11:77-80 (February, 1945).
- COLTON, HOWARD C.: "Accuracy of Color Reproduction," *Photography Principles and Practice* (C. B. Neblette and Collaborators), 4th ed., Chap. 34, pp. 815-845, D. Van Nostrand Company, Inc., New York. "Masking for Color Correction," *Complete Photography*, 7:2470-2478 (Issue 38, 1942).
- FRIEDMAN, JOSEPH S.: "The Kodachrome Image," *American Photography*, 37:42-43, 54 (June, 1943). "Color Correcting Masks for Kodachrome Transparencies," *American Photography*, 37:46-47, 54, 56 (August, 1943). "The Kodachrome Image," *American Photography*, 37:42-43, 54 (June, 1943). "Masking," *History of Color Photography*, Chap. 19, pp. 273-295, American Photographic Publishing Company, Boston, 1944. "Separations from a Color Transparency," *American Photography*, 38:37, 50 (November, 1944). Anyone making a serious study of color reproduction should see the numerous contributions of Dr. Friedman to *American Photography* published during recent years.
- JOHNSON, MARVIN V.: "Print Control with Blurred Positive Marks," *American Photography*, 37:14-16 (March, 1943).
- "Kodak Pan Masking Film," an instruction sheet of Eastman Kodak Company, packed with the film.
- KURTZNER, H. A. and M. W. SEYMOUR: "Color Prints on Paper from Kodachrome Films," *American Photography*, 31:229-242 (1937).
- McMASTER, JOHN: "Color Photography—Masking Separation Negatives," *Complete Photography*, 3:867-872 (Issue 14, 1942).
- "Masking Ansco Color Transparencies for Higher Quality Color Prints," *The Ansonian*, November-December, 1945.
- MILLER, CARL W.: "The Precision Reproduction of Color Masking," *Principles of Photographic Reproduction*, Chap. 25, pp. 313-323, The Macmillan Company, New York, 1942.
- MURRAY, A.: "Masking Method of Color Correction Applied to Three and Four Color Reproduction," *Photo-Engraver's Bulletin*, 23:13-21 (January, 1934). *The Modern Masking Method of Color Reproduction*, Eastman Kodak Company, Rochester, N. Y., 1936 (now out of print).
- Photomechanical Reproduction from Kodachrome*, Eastman Kodak Company, December 5, 1941.
- SELMAN, R. F. W.: "Some Masking Methods of Color Correction and Their Practical Application to the Kodak Wash-off Relief Process," *Photographic Journal*, 80:375-379 (September, 1940).

- SPECK, ROBERT P.: "An Improved Masking Method for Color Transparencies," *The Journal of the Photographic Society of America*, 11:461-466 (November, 1945). This is Communication No. 1042 from the Eastman Kodak Research Laboratories.
- TRITTON, F. J.: "A Survey of Photographic Masking Methods of Color Correction for Three- and Four-color Printing," *Photographic Journal*, 78:732-738 (December, 1938).
- WILSON, JAMES E.: "Mask Making for Prints from Kodachrome," *Photo Technique*, Vol. 2, September, 1940.
- YULE, J. A. C.: "Unsharp Masks," *The Journal of the Photographic Society of America*, 11:123-132 (March, 1945). This is Communication No. 956 from the Eastman Kodak Research Laboratories. See also YULE, *Photographic Journal*, 84:321-327 (November, 1944).

## Imbibition Color Prints

**I**T is in color printing that the amateur gets into the most interesting and the most productive branch of color photography. It has been the dream of photographers for years to make color prints, and while there have been many processes that have worked, only recently have they been within the reach of the better-equipped amateur.

To make color prints one must enhance the equipment of his darkroom considerably. He must buy more chemicals—most of which are useful in other branches of photography—he should possess a good enlarger and a good place to work; he should have running water, hot and cold, in or near his darkroom; and he should have a good store of patience and willingness to study and to learn.

If he goes slowly and methodically and reasons out what he is doing, he will save materials, time, and energy and can show good results almost from the start. But if he has only odd moments to work at any color process, a poor place to work, insufficient funds for equipment and materials, he will store up a series of disappointments that seem to be decidedly insurmountable.

### NECESSARY EQUIPMENT

Certain pieces of equipment will be useful in all color processes; others will be used in only one process. First make a list of what is necessary to get a start in color-print making.

**SCALES.** Eastman and others make good photographers' scales. If a set is to be purchased new, get one with metric weights. Avoir-

dupois is a most awkward system of weights; the metric is much better. Having a set of weights in ounces, grains, etc., however, it is entirely feasible to carry on with them. These scales should be sensitive enough to measure 5 grains, or  $\frac{1}{2}$  gram. One or two ounces, or 50 grams, is about the maximum weight that must be measured out.

Present trends, with Eastman Kodak at least, are to refrain from publishing formulas for color processes. The photographer, in this case, buys the materials from his dealer and makes up the solutions according to the labels on the bottles or packages. Since complete kits or chemicals for processing Ansco color film, Kodak Ektachrome film, and Kodak Dye Transfer prints are available, scales and raw chemicals are not necessary. By and large, however, the photographer who is seriously in the business of making color pictures wishes to know the formulas so that he can keep his solutions fresh, so that he is independent of his dealer except for raw chemicals, and so that he runs no chance of finding the dealer out of some particular bottle or package just at the time he needs it.

Scales, therefore, are not necessary; but they are desirable. Having purchased them, keep them clean and away from fumes that may tarnish or rust them.

**ENLARGER.** If the amateur proposes to make some 8- by 10-inch color prints, he must blow up his smaller negatives to this size. A good enlarger is necessary, but it will be useful in making black-and-white blowups, too.

**TRAYS.** Glass trays are probably best because there is so little danger of contamination of solutions by metal rust. Enameled trays are usable provided they have not been dropped and chipped so that underlying metal shows through. A good half-dozen trays of the sizes of prints to be made should be on hand. Remember that 8- by 10-inch prints can be made in 11- by 14-inch trays, but not vice versa! The amateur can get along with fewer trays, but it is difficult to get too many.

**PRINTING FRAME.** An 8- by 10-inch frame for making contact prints from separation negatives will be necessary. This can be used for black-and-white photography, too. It will come in handy in making contact-size negatives and masks.

**CHEMICALS.** The following list will be useful for nearly all color processes and for black and white, too. The lists found with the descriptions of the individual processes are more or less special and need not be purchased unless that particular process is to be used. Chemicals should be bought in fairly large units, say pounds, for the cheaper materials.

The following quantities are suggested as being economical:

Metol or Elon	$\frac{1}{4}$ pound
Hydroquinone	1 pound
Hypo	5 pounds
Sodium sulfite	1 pound
Sodium carbonate	1 pound
Potassium bichromate	1 pound
Borax crystals	1 pound
Potassium bromide	$\frac{1}{4}$ pound

Fortunately, all present color-printing materials are of fairly slow speed—about the speed of bromide paper, or somewhat less. This means that when the separation negatives have been developed and fixed, nearly all of the remainder of the business of making prints can be carried out in subdued yellow or full light.

Only in very recent years have color prints been made directly from transparencies without the trouble of making intermediate negatives and positives. Ansco Printon makes this possible. There is certainly no simpler method of making a color print than by use of Printon at the present time. It must be said, however, that more accurate color prints can be made by the use of separation negatives, once one has mastered the processes. This chapter will deal with one of the processes using separation negatives. Printon and other direct-printing systems will be described later.

At the present time (1947) there are two general methods of making prints from separation negatives. Both are subtractive



processes. They use dyes (wash-off or dye transfer) or pigments (carbonyl) as the final color images. The red-filter negative is printed onto a positive stock that later produces a color that absorbs the color transmitted by the red filter—i.e., it reflects cyan. The green-filter negative is the basis of a positive that produces the final color (magenta), which absorbs green. Finally, the blue-filter negative forms an image that absorbs the colors passed by this filter and reflects the rest, viz., yellow.

The whole subtractive process can be summarized as follows. Since the negatives are only a necessary evil, serving as a means of recording in silver the original colors, only the positives printed from those negatives will be considered. The purpose of each tri-color filter is to record the colors that the positive made from that filter will finally reflect to the eye.

<i>Filter Color</i>	<i>Transmits</i>	<i>Absorbs</i>	<i>Records on Negative</i>	<i>Records on Positive</i>	<i>Positive Is Printed in</i>
Red	Red	Green and blue	Red	Green and blue	Cyan
Green	Green	Blue and red	Green	Blue and red	Magenta
Blue	Blue	Red and green	Blue	Red and green	Yellow

<i>Dye Color</i>	<i>Absorbs</i>	<i>Reflects</i>
Cyan Magenta Yellow	Red Green Blue	Green and blue Blue and red Red and green

Cyan dye is blue-green in color; magenta is a sort of bluish red; and while one cannot imagine a red-green, such a color is actually yellow.

The final printing colors employing dyes, pigments, or printing inks are cyan, magenta, and yellow.

## PRINTING PROCESSES

Having separation negatives, one may proceed in any of several ways to produce a color print on paper. The photoengraver uses the negatives to make positive printing engravings. With these engravings, usually on copper, printing inks impress on paper the separate images secured from the separation negatives. The engraver also makes a fourth negative, often through a K2 (yellow) filter, which produces a plate that forms a black impression on paper.

The photographer has, at the moment, only two working methods by which he can produce a paper print. From the negatives he can make positives on ordinary bromide paper. These black-and-white prints are employed to selectively harden pigmented gelatin, the photographic positive made from the red-filter negative producing a pigmented gelatin image in cyan, the positive from the green-filter negative producing a pigmented gelatin magenta in color, and the blue-filter print forming a yellow gelatin image. These partial images are finally assembled, one on top of the other, to form a tricolor print. Such a process is known as a pigment or carbro method.

In another process, the separation negatives are printed on a film stock that is so made that the gelatin in it can be hardened in proportion to the strength of the positive image. The unhardened gelatin is washed off in warm water and the remaining gelatin is dyed, the amount of dye taken up depending on the strength of the positive image. After three such positives in dyed gelatin have been made, the dyed images are transferred, one at a time, to a mordanted paper base forming the final tricolor picture. This method is variously known as an "imbibition" or "wash-off" process. The Curtis Orthotone process and the Kodak Dye Transfer process follow this general plan.

In another method available before the war, thin films were toned in the three printing colors and were then stacked up one

on top of the other in register to form the final color print. This process, known as Chromatone, has been discontinued.

The author has no advice to offer the amateur that will help him make a choice between carbro and wash-off. Each has its advantages; each its drawbacks. If you can make accurately balanced negatives, carbro has the advantage, since printing from these negatives is no more difficult than making black-and-white prints from any negative. After this step, all else is pure mechanical labor. On the other hand, if your negatives are likely to be out of balance, wash-off provides much more possibility of compensating controls. Carbro requires fewer chemicals. The formulas are very old and well known. Professionals generally employ this method, but the reason may lie more in the fact that it is older and better known than in any supposition that carbro produces better results. Both carbro and wash-off require a supply of clean hot water. There is some question regarding permanence of prints. Dyes are not permanent and it is likely that pigment images will fade less.

By the wash-off process, any number of prints can be made from one set of gelatin positives, known as "reliefs" or "matrices." On the other hand, only one carbro print can be made with certainty from a single set of bromides; although, with care and provided the picture does not contain much delicate high-light structure, several prints can be produced without the bother of making new bromides. The new Eastman Dye Transfer process is definitely the fastest method of making color prints; and in any wash-off process, there is more room for adjustments to be made as one goes along to compensate unbalanced negatives, for overprinting of one or more of the positives, or for changing the color balance to suit the taste of the photographer.

The density range of the negatives for carbro and Curtis Orthotone should be approximately 1.0 to 1.2; Dye Transfer can use negatives having density ranges as high as 1.8. Considerable latitude is available by the Orthotone method.

### *Imbibition or Wash-off Printing*

In this elegant process, first offered in this country by Eastman Kodak under the name of Wash-off Relief and by Curtis under the name of Orthotone, positive prints are made on a special film in which the gelatin is unhardened so that it melts easily. The Kodak process has now been superseded by the Dye Transfer process; but the basic features are the same. The film has a speed about like that of enlarging paper; can be used under an OA safelight. It can be fogged; the photographer should not fool himself on this score. Much of the author's early troubles were due to unsafe safelights.

The film is exposed through the base—*i.e.*, the light from the negative passes through the base of the relief film before it strikes the sensitized emulsion. This is most important; if the exposure is made in the usual manner, the whole image will float off in the hot water leaving the photographer with a nice sheet of clear acetate or nitrate base but with no relief image. Since the image lies next to the support, it is barely visible from the emulsion side of the film but is clearly visible through the support. After development and a wash in cool water, the image is bleached in a solution that not only gets rid of much of the silver image but “tans” or hardens the gelatin where there was a silver image.

After the hardening bleach, the film is placed in hot water, whereupon the nonhardened portion of the gelatin melts and floats away. The end point is a gelatin positive image, whose thickness is proportional to the exposure each portion received. Thus, where the negative is thin (shadow), the positive will have much exposure, much silver halide, and finally much gelatin. In the negative high lights, however, where the negative density is high, the positive image will be weak, and in the hot water most or all of the gelatin will be removed. This final gelatin image is in fact a “relief” image, the portions of greatest thickness representing the portions of greatest exposure. The films are now fixed and dried.

Then the films are dyed, each in a color complementary to the color of the filter used to make the negative from which the positive relief film was printed. After dyeing, the dye images are transferred in turn to a final support paper, which is merely a paper with a good coating of mordanted gelatin. Special paper for this purpose is available; but many bromide or contact papers, glossy or semiglossy, which have been placed in a plain fixer for 10 minutes or so (under a safelight, of course) and then washed thoroughly, can be used when properly mordanted. Velvet Velox, Azo E or PMC No. 10 (double weight), Velour Black, and other photographic papers have been used successfully.

The emulsion contains a yellow dye for the following purpose. Ordinary film is fairly transparent to white light. Therefore, the exposing light penetrates easily through the film emulsion depth. What is desired in a relief film is that the longer exposures build up greater depths of relief, short exposures producing only thin reliefs. If ordinary film were used for a relief image, an image of harsh gradient between the various tones of the picture would result. It would be very contrasty and would have a short scale.

If, however, a dye placed in the emulsion has a color such that it absorbs light of the wave lengths to which the film is sensitive, the distance into the emulsion to which the exposing light penetrates is more closely related to the amount of the exposure. Thus, as the negative density decreases, the exposing light will have more action on the relief film printed from it; but because of the dye, the distance to which the light penetrates increases more gradually than if the dye were not present.

The relief film is sensitive to blue-violet only; the dye must absorb this color. A yellow dye has this property. Thus the dye tends to make the distance to which the light penetrates much more linear with respect to the densities of the negative. The effect of the dye is to make a positive image in which the depth of the image is

inversely proportional to the density of the negative to which the relief film was exposed.

The process gets its name "Wash-off Relief" from the fact that the unexposed, untanned gelatin is literally washed off in the warm water; the source of the "relief" portion of the name is obvious from the above description. The dyed "reliefs" are also called matrices.

There are several very desirable points about this method of making color prints. One is the fact that duplicate prints can be made simply and cheaply after the matrices (reliefs) have been made. Another is the fact that the paper upon which the dyed images are transferred can be any one of many surfaces. Another good point is the fact that there are several places in the process where control can be exercised. Thus the color balance of the final print is under the control of the photographer more, perhaps, than in any other printing medium. There are several places where the processes can be interrupted and the remainder put off until a later period.

This general method, therefore, consists in printing the separation negatives onto a special film by making the exposure through the film base. The film is developed, washed, bleached, rinsed in hot water until all the soluble gelatin melts, fixed in hypo, washed, dried, and dyed. Finally, the dyed images are transferred in register to a mordanted paper. And here is where the process gets the "imbibition" part of its name—imbibition being a high-powered name for the phenomenon whereby the mordanted gelatin coating of the paper imbibes the dye from the gelatin of the relief film.

Since it is necessary to tan or harden the gelatin in the areas where development takes place; and since certain developers like pyro tan or harden gelatin, many workers have experimented with pyro as the actual developing agent in the hope that one or more of the wash-off steps might be eliminated. Curtis has offered chemicals

for this purpose, and the new Kodak Dye Transfer process is based on this modification of the original imbibition or wash-off principle.

In this modern method, the films are exposed as in the older wash-off technique, then developed in a special tanning developer, which not only develops the image to a silver picture but tans or hardens the gelatin at the same time. After a 2-minute development, the films are rinsed, placed in a stop bath, placed in the hot water to dissolve the unhardened gelatin, and then dried. This method saves much of the processing time, since the developing period is shorter, there is no wash between developer and bleach, and there is no bleach or hypo.

A comparison of the processing periods is as follows.

	<i>Wash-off in Minutes</i>	<i>Dye Transfer in Minutes</i>
Develop	5	2
Wash	5	1
Bleach	4	—
Stop bath	—	1
Hot water	4	2
Fixer	1	—
Wash	5	½
<b>Total</b>	<b>24</b>	<b>6½</b>

These are minimum times per film. Some people can hustle three wash-off matrices through simultaneously (remember that every color print is made up of three of these films) so that some time can be saved. But it will take the average photographer at least 1 hour to make the three wash-off matrices even if he doubles up or dovetails his work to some extent, perhaps exposing the second film while the first is developing or developing two or three at a time in a single tank or tray. Any attempt to hurry the process, however, is



WRATTEN COPY BOARD CHART.



*A*



WRATTEN COPY BOARD CHART.

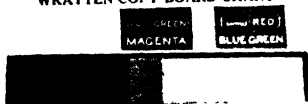

*B*



WRATTEN COPY BOARD CHART.



*C*

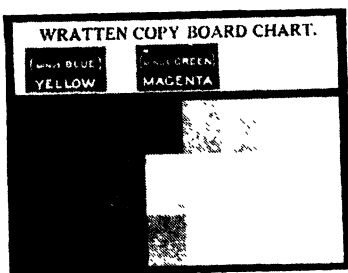

*D*

Appearance of prints made from separation negatives. *A*, red-filter negative. *B*, green-filter negative. *C*, blue-filter-negative. *D*, method of comparing positive prints made from gray scales of negatives. This represents a bad mismatch, but a reasonably good print may be made. Negatives made on SS pan pack, 9 by 12 cm.





fraught with danger and should not be attempted until the technique of making a single relief is down pat.

It can be seen immediately that the great advantage of the Dye Transfer process is in saving time. It will require just as much time, however, to get the individual films out of their wrappings, to expose them one at a time, to change negatives in the printing frame or the film holder, to change the exposure timer if the negatives are not exactly balanced, to get out the solutions, to clean up, etc., etc.

The saving of processing time, however, cannot be laughed off, especially if the photographer has to work at night after his money-making job for the day is done. The solutions for the newer process are a bit trickier to get ready and the developer temperature must be within two degrees of 68°F.

### *Dye Transfer vs. Wash-off Relief*

As indicated before, the Kodak Dye Transfer process is a modernization of the wash-off principle. It is a tanning system in which the matrices are selectively hardened at the same time that the image is developed. Every step in the wash-off system has been overhauled by Kodak in an endeavor to speed up the process, to make it easier and more sure-fire, to improve the colors, and in general to make a simple and effective means of making excellent color prints.

The two systems can be compared somewhat as follows. Dye Transfer is faster and more expensive since the chemicals must be purchased ready to dissolve. Since time has a certain money equivalent, the saving of time in the Dye Transfer process compared to the older wash-off system probably brings the costs of the two methods in line. Film recommended and sold for Dye Transfer has an acetate safety base and is quite a bit thicker than the film supplied for wash-off relief, which is on a nitrate base.

This older film is highly inflammable and for that reason a large no-smoking sign should be hung conspicuously in the darkroom.

When either Kodak Matrix film or Wash-off Relief film is developed (DK-50) and bleached by the older method, the final image is made up of gelatin only. It can be seen, when wet, in the form of a definite relief. After the matrices are dyed, they can be stacked up in register and placed upon a white surface so that the color picture, almost exactly as it will appear when transferred, can be seen. At this stage any corrective measures can be taken, reducing one color or increasing it to produce the correct balance. This is a distinct advantage not possessed when the films are developed and tanned at the same time. In using a tanning developer, as in Kodak Dye Transfer, a brown-black image remains in the reliefs so that it is not possible to see the color picture by superimposing the three partial images. It is necessary to transfer all three images before the color balance can be determined. This is a definite disadvantage for the average amateur who does not make prints every day and who, therefore, is not so adept at judging the correct exposure to get the result desired. Adjustments in color balance must be done after a print has been transferred. Since the images transfer quickly, not much time is lost by making a first print, then performing the necessary corrective operations and making the second print. But it would be helpful if the three matrices could be superimposed so that the colors could be seen before transfer. With the Curtis tanning-developer process the images can be bleached out and, in fact, the manufacturer so recommends. The gelatin images produced by DK-50 or by the tanning developer are fragile but definitely stronger with the tanning developer. In the transfer process, they are much less likely to be damaged, thus necessitating subsequent color spotting.

These are the only essential differences between wash-off relief and dye transfer. New dyes have been developed and a new method of making the transfer, but these need not be employed if the

color worker prefers other dyes or the older methods of transfer. The tanning developer will work with either Kodak Matrix or Wash-off Relief film; the dyes and transfer methods will work with either.

Since both Curtis and Eastman Kodak believe the tanning-developer system is to be preferred, it will be described first.

### *Kodak Dye Transfer Process*

All the chemicals are made up in containers by Kodak and must be purchased individually or in a kit. The manufacturer does not supply the formulas, so the photographer cannot make up his own solutions.

The films are exposed through the base and through a Wratten No. 2A filter. They are developed for 2 minutes, washed briefly, placed in a stop bath for a minute, washed down in hot water, and dried. All this requires not over 10 minutes. When the films are dry, they are dyed. Then they are registered carefully by a process to be described and trimmed along two edges while in register. After that the images can be transferred to their final support—a mordanted gelatin-surfaced white paper.

The matrices dye up quickly, in 5 to 10 minutes. Then they are rinsed in dilute (1 per cent) acetic acid, whereupon they are ready for transfer.

### *Minor Contrast Control*

After the matrices have been made and a first print transferred, it may be found that one of the colors is too weak or too strong. If the calculations for exposing the matrices are correct and if the actual exposure time is correct to 5 or 10 per cent, color control can be exercised as follows. If the exposures are in error more than 10 per cent, it is probably better to make new matrices. This will be absolutely necessary if the matrices are badly underexposed, since there will be no details in the high lights at all.

To increase one color, dye the matrix as usual but transfer it without draining to a tray in which the usual acetic acid rinse (150 cc for an 8 by 10 print) has been fortified with 3 cc of 28 per cent acetic acid. Agitate the matrix for 1 to 5 minutes, depending on the amount of additional dye you wish the matrix

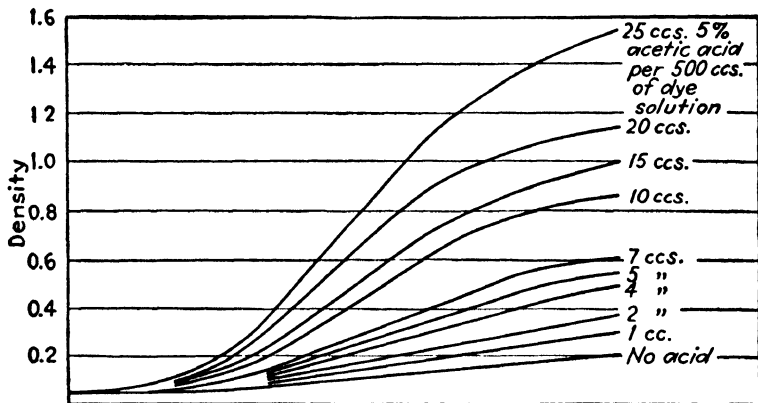

Effect of adding acetic acid to blue dye used in Kodak Wash-off Relief. Note how the image density builds up as the amount of acid is increased.

to absorb. If still greater contrast is desired, an extra dye bath can be made up as described in the Kodak Matrix dye kit. The author has found the first of these methods not to be very powerful—in other words it is useful for minor changes.

If one color is too strong, it can be reduced by adding 1 to 5 cc of 5 per cent sodium acetate to the first acid rinse. Agitate the relief for 1 to 5 minutes, depending on the reduction desired. It is easier to reduce color than to increase it—give full exposures when in doubt.

The 2A filter recommended increases contrast. Omitting it will produce softer matrices; a Wratten No. 35 filter used instead of the No. 2A filter will produce softer reliefs.

If the matrices are somewhat overexposed so that the high lights are too gray, correction can be secured by use of the Kodak high-light reducer as described in the dye transfer booklet.

### REGISTERING AND TRANSFERRING DYE TRANSFER IMAGES

After the matrices have been dyed, rinsed in acetic acid, and dried, they can be registered by a process outlined in the kit instruction booklet. Briefly, this process is as follows:

Clean the surface of a sheet of plate glass, making sure there is no grit or any abrasive material left on it. Choose either the upper left corner or the lower right corner of the cyan matrix—whichever has the greatest safe edge—lay it, emulsion-side down, on the glass plate with about  $\frac{1}{8}$  inch protruding over the edges of the glass. Tape down securely the other two edges. Place the glass over an illuminator.\*

Now place two pieces of tape on the support side of the magenta relief and bring it into register with the cyan image. Do this carefully, choosing bright points of light at widely separated points. Use a magnifying glass and effect the best possible register. Tape down the magenta relief and, placing a clear sheet of glass over the magenta matrix, press down to get the two surfaces into intimate contact and check the register again. Repeat with the yellow relief.

Now place the glass plate with its three reliefs on a trimming board, reliefs down. Applying some pressure to the glass, trim the reliefs close to the glass edge. Here is where the plate glass proves its value. It is heavy enough to flatten the reliefs, and little additional

\* A retouching desk or something similar will do. For example, artists' supply firms sell for \$10 to \$15 an arrangement containing sockets for two lamps, a ground glass plate, and a holder for this material. The lamps do not give even illumination over the whole glass (which is about 2 feet square), but the device serves well for this registration purpose. Something with better ventilation would be helpful. And do not try to use thin picture-framing glass in this procedure.

pressure need be applied. If a thin piece of glass is used, one is almost certain to crack it either with the applied pressure or by cutting too close to the glass edge. Use a heavy piece of glass.

Now two edges of the reliefs should be in accurate register with each other so that when these edges are butted up against the raised disks on the transfer blanket, the images should register. As a matter of cold fact, one is still not too certain that the transferred images will be in exact register, and the greatest care must be taken to place the reliefs in turn on the blanket exactly alike. The author has found that it pays to provide large safe edges on his reliefs so that the edges can be recut if exact register is not attained in transferring the first print. And in making the finest possible print the old method of registering each image just before transfer is indicated. This is another reason for leaving large safe edges on the matrices.

You must be careful not to trim the edge of the matrix that bears the marks identifying the color in which it is to be dyed. Thus the identifying marks should be placed on the right edge looking at the relief with the image-side up.

After the registration and trimming steps have been completed, return the matrices to a 1 per cent solution of acetic acid, prepare the mordanted paper, and proceed to transfer the images. There are two general methods, one employing finesse and the other using main strength and awkwardness. The former method uses the Kodak Transfer blanket, a sheet of plastic in which have been pressed several registration disks. This blanket is mounted on a flat surface as recommended by the manufacturer; on this surface is placed a sheet of plate glass or something similar; on this glass is placed the mordanted transfer paper. The cyan matrix is transferred first. It is lifted from the acid bath and placed on the blanket so that the trimmed edges butt up against the registration disks. Now with a heavy roller squeegee, the matrix and blanket are rolled into contact with the mordanted paper.

Transfer requires only a few minutes. When complete, the matrix is removed and laid aside for further dyeing and printing. Now the magenta matrix is placed on the blanket and is transferred, followed by the yellow image. The entire transfer process takes not more than a half hour, including preparation of the transfer paper and washing and hanging up the matrices.

The heavy print roller sold for this purpose is a great help. It is expensive—so is any good print roller—but worth it. One swipe of this roller effects complete contact between matrix and transfer paper. The roller should be somewhat longer than the widest print to be made. Only a single roll should be made in transfer, thus eliminating the opportunity for movement of the matrix, which sometimes occurs when repeated motions of a small squeegee are necessary to get all portions of the relief in contact with the transfer paper.

The method of transfer without benefit of the blanket is described under the wash-off techniques outlined below. Judging correct exposure and other techniques common to dye transfer and wash-off will be described after a brief summary of the latter process has been given.

### *Wash-off Process*

The making of a print by the process in which matrix development and bleaching are carried out in separate steps starts exactly like that in which these two steps are combined. The films, either Kodak Matrix or Kodak Wash-off Relief films, are exposed through the base of the film and are developed in DK-50 for 5 minutes. Then they are washed for 5 to 10 minutes and bleached and washed off in hot water. The lights may be turned on after the hot-water step has begun. After a minute or two in a fixing bath, the films are again washed for 5 minutes and are hung up to dry. After these steps the entire process can be carried out exactly as recommended for Kodak Dye Transfer.



It is advisable to buy Kodak Matrix film since the manufacturer packs thirteen sheets of film to the dozen, thus giving the photographer one extra for making test exposures. Wash-off Relief film will probably be discontinued. It is highly inflammable.

### *Necessary Equipment*

Obviously, you will need the regular darkroom equipment—trays large enough to handle the films, timer, etc., and in addition, developer DK-50, R-10 bleach, F-24 or F-5 fixer, glacial or 28 per cent acetic acid, aluminum sulfate paper-mordanting solution, sodium acetate.

**FINAL SUPPORT PAPER.** It is better to get the paper recommended for Kodak Dye Transfer process known as Dye Transfer paper and also to get Kodak Paper Conditioner. This material makes unnecessary any mordanting of paper and eliminates the need for aluminum sulfate. A small supply of sodium acetate (4 to 8 ounces) will be useful. If there is a good supply of old printing paper on hand in the sizes you wish to use for color prints, it may be fixed out, washed, mordanted, and used for final supports for dyed color prints. But it is far easier and simpler to purchase paper already mordanted plus the paper conditioner mentioned above.

**DYES.** Available from Kodak, Defender, Curtis, and others. Some transfer more quickly than others; some have better color values than others. Some keep well; others don't. Kodak Dye Transfer dyes will work with matrices made by the DK-50 developer system, but it may be necessary to adjust the dye contrast somewhat for this purpose. They transfer very quickly and have excellent color value. More data on dyes will be found later in this chapter.

**SQUEEGEE.** Get a roller somewhat larger than the largest print to be made. One or two flat types will be useful too.

**GRADUATES.** Get 10-cc, 4-ounce, and 16-ounce graduates.

**LABELS.** Get the drugstore variety or the decalomania labels now advertised in photographic magazines.

**BOTTLES.** You will need about a dozen before you get through. Drugstore 16-ounce and 32-ounce bottles will do; so will grocery-store pint or quart fruit jars. Kodak Dye Transfer dyes are to be diluted to 1-gallon quantities, but the dye can be divided and kept in smaller containers. Widemouthed jars are better where material must be replaced in them after use; metal jar caps may be corroded by some of the solutions.

**TRANSFER MATERIAL.** By all means purchase and set up the Kodak blanket arrangement for transfer. Have on hand, in addition, the following material for use when it is necessary to transfer the images "by hand": two good-sized and strong paper clamps, several sheets of Kodaloid  $\frac{5}{1000}$ -inch thick and as large or larger than the prints to be made. The Celluloid Company makes a  $\frac{3}{1000}$ -inch celluloid known as Lumarith. This will serve as well as the Kodaloid. It can be obtained from artists' supply houses. A sheet of wash-off relief film, from which the emulsion has been washed off in warm water, will serve just as well.

The chemicals that are not ordinarily on hand are below, together with economical quantities to buy.

Ammonium bichromate	1 pound
Sulfuric acid, C.P.	$\frac{3}{4}$ pound
Sodium chloride	1 pound
Strong ammonia water	1 pound
Sodium acetate	$\frac{3}{4}$ pound
Aluminum sulfate	1 pound

Since the developer and bleach are used only once, they go down the drain pretty fast. Therefore, make up plenty of each. The author makes a gallon of DK-50 at one time, placing the mixed developer in quart bottles, full to the cork. The bleach solutions, two of them, can be made up a pint at a time, but a quart is better.

Dyes can be purchased in powder form or in liquid form. It is much easier to get the second form ready to use. Follow the directions of the manufacturer. If he says that distilled water should be used (and they all do), telephone the drugstore and get 3 quarts.

The containers can be employed as the dye containers after the mixing up has been completed. If the manufacturer states that citric acid instead of acetic acid is to be used to make the dyes work properly, get citric acid. If he advises the use of sodium acetate to make dyes less peppery, use sodium acetate and not ammonia. At the start, do not try to improve on the manufacturer's instructions!

### *Stages in the Wash-off Process*

There are several natural stopping places in the process where the photographer can relax and clean up the darkroom, his trays, and himself to await another time to finish off the job. On the other hand, there is little reason, aside from the time and fatigue, why a color print can't be made all at one sitting, provided the separation negatives are ready and have been measured for the printing times necessary to properly expose the film to them.

The making of separation negatives is a good evening's work, when all goes well. Then the printing of the reliefs from the negatives provides another good stopping point. The third step is to dye the reliefs, and the fourth can be the transfer to the final paper support. It is possible to print the reliefs, dye them, and "put them down" on paper in one evening, after one has his system well worked out and there are no hitches. At the start, however, it is best to go slow and not to bite off too much at once.

Suppose, therefore, that the negatives are made and ready to print; the developer is at 68°F; the bleaching solutions are ready; a good supply of clean water at 125°F is available; the fixer is prepared. In the darkroom have the developer (4 ounces will do for a 4 by 5-inch print), a tray of water (or running water, preferably), and a tray for bleach. Into this tray put 1 ounce each of the two bleach solutions and add 6 ounces of water. This makes 8 ounces of solution, which is plenty for an 8- by 10-inch if the amateur is adept at tilting the tray so that the relief print is quickly and evenly covered with bleach.

A good size with which to test is a 4- by 5-inch, and four of these will come out of each 8- by 10-inch sheet. If the amateur is sure that all three negatives can take the same printing time, an 8- by 10-inch sheet with one corner cut out will make all three reliefs, and they can be made in this form. They can be kept together until the time comes to dye them and then they can be cut apart.

There are numerous ways to get started, some scientific and some more fun. Using the latter method, select a set of negatives in which there is a density representing something white—say a white cloud, a white collar or dress, or a white house. This density will be the maximum density on the negatives, which it is assumed are balanced as to density values and contrast (density range). This means simply that the spots on each of the three negatives representing this white object have the same density and, therefore, the three negatives will require the same printing time in making the exposure onto the wash-off film.

Remember that the film is to be exposed through the back or support. Place the negative in the printing frame, if contact prints are to be made, or in the negative carrier, if enlarged prints are the desire. If the negatives were made from the original subject (not from a transparency) place them so that image side faces the wash-off film.

Turn out the house lights; focus the enlarger properly; mark on the easel with a soft pencil or crayon the spot on which the white object is focused. Place over this spot a small piece of wash-off film, and over this film place a paper clip so that some part of it is exactly over the spot representing the greatest negative density. Stop down the enlarger lens to some reasonable value; give what seems to be a reasonable exposure.

Insert the test piece in the developer, emulsion-side up; make sure that it is well covered with solution; and then turn the film over on its face, support-side up. The film will float and will not tend to stick to the bottom. Keep the tray moving for 5 minutes,

and if the darkroom is cold (or hot), place the tray in a larger tray of warm (or cold) water so that the solution remains at its required temperature of 68°F. Watch the image come up. If it rushes up

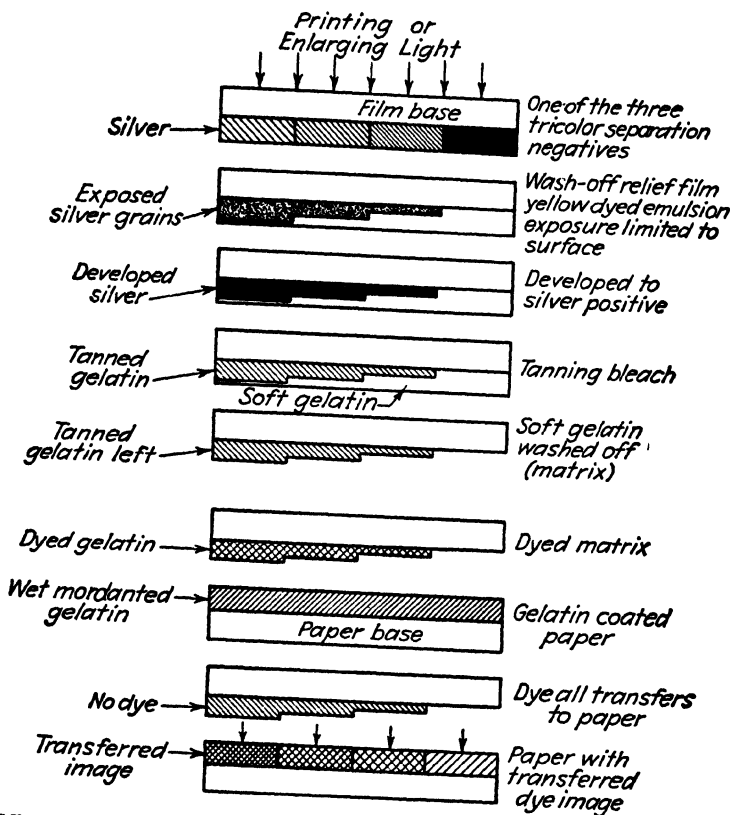

Effect of the several steps in the imbibition or wash-off relief method of making color prints.

and turns black, the exposure was too long. Under any conditions the paper clip will show up as a white curlicue. Wash the film for 5 minutes, bleach it until the image practically disappears (4 minutes or so), then wash in hot water until no milky water runs off.

The house light may be turned on after the film is in the bleach and the washing-off process can be watched. At this point the gelatin is exceedingly fragile and can easily be damaged. Therefore the film should be in the tray support-side down. Placed in the tray in this manner, the film will stick to the bottom and will not fall out if the water in the tray is changed by dumping it out.

The correct exposure is that which results in a just perceptible deposit of gelatin in the brightest high-light area. The paper clip prevents any exposure being given the film under it so that the washed-down test strip will exhibit clear film. Compare the surrounding gelatin. There should be neither too much nor too little—only experience will tell the exact thickness of gelatin at this critical high-light point.

This method is the surest way to get started. It can be pursued a bit farther with benefit. Once having secured a test strip that has the qualities mentioned above, fix it, wash it, dry it, and then dye it in the cyan dye. Transfer to a piece of mordanted paper, just as though you were going to make a serious print. On this mordanted paper there should be a faint suggestion of blue surrounding the image of the paper clip.

It is here, at the very start of one's adventure into color printing, that the Stripmeter mentioned before comes in handy. Locate the device so that the slit covers the brightest high light (the white collar or house), insert into it a piece of wash-off film of the proper size, and make a series of five exposures ranging from the longest you think necessary to the shortest you think possible. After processing this piece of film, you should have at least one test that is nearly correct. The paper-clip trick won't work if you are making contact prints by means of a printing frame; but it will still be possible to choose a portion of the negative with a white object and to make the first tests on that portion.

Inspection of the washed-down test (unfixed) strip is facilitated by looking across it by reflected light rather than through it,

especially when backed by complete darkness. Now the "relief" will show up, the high-light portion being very thin and the shadows having appreciable depth or thickness. A high light in the original subject will produce a high density in the negative, and the small amount of light passed by this high density penetrates the wash-off relief emulsion only a short distance. A shadow in the original subject produces a thin negative density, through which the printing light penetrates deeply into the emulsion.

Development is carried to completion so that practically all the exposed silver halide grains are developed to silver. The depth from the support of the resulting silver image (black area in the diagram) is greater wherever there are greater densities.

Having come as close as possible to the ideal positive print, the next thing to do is to actually make all three prints and to dye and transfer them. Only by so doing can you tell whether your best exposure is too much or too little. If it seems correct, you are all set. You should jot down the printing time, the degree of enlargement, and the density of the negative producing the "just perceptible" deposit of gelatin. These data will serve as starting points for future prints from other negatives with other degrees of enlargement.

### *The First Print*

Now that the test is out of the way and the proper exposure determined, the first print can be made.

Make sure that the negatives and glass plate in the printing frame or the plates between which the negative rests in the enlarger are clean, free from dust or lint. Make sure that the glass sheet (if any) laid over the wash-off film on the easel to hold it down perfectly flat is clean and similarly free from lint or dust. Every flaw that appears from now on will be costly.

Mask off the negative or the easel so that a safe edge or white border of at least  $\frac{1}{2}$  inch (it is better to have a larger safe edge) appears around the final processed positive. On the easel place a

sheet of clean white paper. Outline the image with a pencil so that the next negative and the easel can be placed properly with respect to each other. Otherwise you may find that you have lost  $\frac{1}{4}$  inch from one of colored images with the result that your final picture must be trimmed more than you may wish.

If the negatives are balanced so that they require equal exposures, you are lucky; but if they are not, the means for determining the correct relative exposures is at hand, once one correct positive is made.

Mark the first sheet of film by clipping off one corner or by using any of the methods outlined for labeling separation films. Make the exposure. If the positives are small—say no larger than 5 by 7—all three can be developed at once if you are careful, if you use an 8 by 10 tray or larger, and if you use plenty of solution. Insert the films one at a time face up, making sure that the support side is well covered before the next film is inserted. Remove the film on the bottom of the pile, handling it carefully by the extreme edge, place it on top, push them all down into the solution, and keep this up until 5 minutes are gone.

Preferable, and safer, is the longer method of developing one film at a time or of doing each of the three films in its own tray. A scratch in the emulsion means a spotting job later. The hot-water treatment must be done with one film at a time. At this stage extreme care must be taken not to touch the emulsion side. Any grit in the hot water will make a wavering line across the print, usually through the middle of the face if the picture is to be a portrait.

The washing-off step can be carried out in one of several ways. One of the best is to place the film, emulsion-side up, on the outside bottom of a tray to which it will adhere and to hose off the melting emulsion with a gentle stream of water.

Dry the matrices in a dust-free location, hanging each matrix with the same side or corner of the image up. Drying before dyeing toughens the reliefs and lessens the risk of damage in subsequent



handling. Still more toughening will be produced if the reliefs are bathed for 5 minutes in a solution of 10 cc of formaldehyde per liter (quart) of water.

A faint image is still visible; it can be removed by letting the films remain in the fixer for 20 minutes or more or by bathing them in a solution made up as follows:

Stock solution A	Potassium permanganate	1 oz.; water 32 oz.
Stock solution B	Potassium ferricyanide	1 oz.; water 32 oz.
Stock solution C	Sulfuric acid	1 oz.; water 32 oz.

Use  $\frac{1}{2}$  ounce of each in 32 ounces of water; do not rinse but insert at once in hypo; then wash as usual.

Removal of this image is not at all necessary. The color, however, which is a faint brown stain, may make it a bit more difficult to judge color balance when the matrices are dyed and then viewed in register.

### *Dye and Examine for Color Balance*

After the films are dry, they are dyed. While this is taking place the trays containing the dye solutions should be agitated frequently to make sure that the gelatin surface is covered evenly. During this period prepare the acetic-acid rinse solutions as required by the particular dyes being used.

Since the matrices have no color themselves, or very little, they can be superimposed after dyeing to see the completed image. This technique is as follows. After a sufficient time in the dye bath, remove the films one at a time, allowing the dye to run off until it leaves the matrix in drops. Place in a tray and cover with the acetic acid of proper strength. Swish the rinse over the film for 1 minute and then transfer the film to another tray well filled with acidified water of the proper strength. When all three films have been so treated, lay them down one at a time on the bottom of an enamel tray, on a white Carrara glass, or on a sheet of white glossy paper. Place the first film, dye-side up, on the white support, then place

the second film on top of the first, using plenty of the acidulated water to provide lubrication so that the film can be moved about easily without scratching the surface beneath it. Effect the best register possible and then superimpose the third film. This is an exciting time; the color picture now appears much as it will look after transfer to its final support.

At this moment you learn that you have correctly made the matrices or that you have underexposed or overexposed them. If they were correctly made, the white collar, dress, or house, or whatever the lightest uncolored object is, will appear without color and will have practically no dye at all. In other words, there will be only the white paper (tray or Carrara glass) appearing through the clear supports of the three films in the spots representing white subjects. In areas less bright than these pure whites there will be details.

If the films were underexposed, too much of the lighter areas will be pure white; there will be no details in these high lights. If the films were overexposed, the high lights will be too dark; white areas will appear gray, since they are made up of equal deposits of all three dyes and such equality produces a gray of varying darkness depending on the amount of dye.

### *Corrective Measures*

If the films were underexposed, nothing much can be done about the matter except to make them over. If they were slightly overexposed, they should be washed in a tray of water until dye is seen to leave the matrix. This will take only a few seconds. The difficulty with this density reduction is that of maintaining color balance, since some of the dyes may wash out faster than the others and since the amount washed out increases with the time the films stay in the water. After a wash-down of this sort, return the matrix to the acid bath to stop further loss of dye.

If the picture is weak—i.e., if the high lights seem to be correct but there is too little color in the shadows and middle tones—the

matrices can be placed in dye baths having more acid in them. This will increase contrast—i.e., the shadows will become darker while the high lights will remain about the same. On the other hand, if the tricolor image is too dark in the shadows—blocked up, without detail—then the dye baths were too strong in acid and redyeing the films in baths having less acid will remedy this trouble.

By having dye solutions of three different amounts of acid, you can compensate for the use of negatives of greater or less contrast. Thus if the negatives are too contrasty, producing a very contrasty color picture, too dark in the shadows, the positive matrices made from them should go into baths comparatively weak in acid. Weak negatives will require that the positives be dyed in baths having comparatively large amounts of acid in them. If the three negatives do not have equal contrast, then the positives made from the strong (contrasty) negative can be dyed in a weak dye bath. But it is much, much better to make negatives that are well balanced not only in absolute values of density but also in identical density ranges.

It is much easier to compensate, in printing, for negatives which do not have identical density values but which do have equal density ranges than to compensate for negatives that are out of balance from the standpoint of density difference (contrast). The wash-off system, however, has remarkable flexibility; the fine degrees of control give it a very great advantage over carbro where one's final picture is determined when the positive prints are made, since there is not much chance to compensate errors later on.

### *Making the Transfer*

Once the three matrices have been adjusted so that, when superimposed, the picture looks correct, then the three images can be transferred to the final support paper. This can be special imbibition paper purchased from the dealer or it can be any smooth or fine-grained photographic paper from which the light-sensitive

chemicals have been removed by soaking in plain hypo (8 ounces to 32 ounces of water), washed, and mordanted. It is now possible, and a better plan, to purchase imbibition paper ready to use; but you may also buy gelatinized paper to mordant yourself.

Mordanting is tedious but not difficult. It consists in bathing the imbibition paper (or fixed-out photographic paper) in the M-1 solution for 5 minutes, washing the paper for 5 minutes, bathing it in 5 per cent sodium acetate for 5 minutes, and washing for 5 minutes—about a half hour in all. Quite a few sheets can be run through this process at one time, removing the sheet at the bottom and placing it on top of the pile in the tray to make sure that all are evenly mordanted. Running water should serve as the rinses, or the tray may be filled several times during the 5-minute wash period. After the final wash, the paper can be used at once or it can be dried and stored. It should be soaked 10 to 20 minutes before using, however, so that it is fully expanded and limp.

Taking a sheet of the mordanted and soaked paper,\* lay it face up on a sheet of glass and squeegee it down to the glass with light strokes at first and then with considerable pressure. This is to stretch the paper to its maximum size so that it will not change its dimensions during transfers.

Except for a 1/2-inch strip along the bottom edge, cover the paper with a sheet of 5/1000-inch Kodaloid or a sheet of wash-off film from which the gelatin has been removed in hot water, remove the first matrix (usually the magenta or cyan) from its acid bath, and let some of the acid fall on the Kodaloid so that it will provide lubrication. Place the safe edge of the matrix flush with the edge of the support paper where it is not covered by the Kodaloid. Let the matrix fall on top of the Kodaloid, squeegee the safe edge to the support paper or place a heavy paper clamp along this edge, pick up the far edge of the matrix, and, holding it between the teeth,

\* At this point the instructions may be used with film processed by DK-50 and separately bleached or with film processed in Kodak Dye Transfer solutions.

remove the Kodaloid. Let the matrix come down on the support so that it makes good contact over the entire surface.

If any air bubbles appear, showing that good contact has not yet been secured, carefully work them out with the squeegee. Unless good contact between matrix and support paper is secured, the image will not transfer evenly.

Cover the matrix with the Kodaloid and place over the assembly a sheet of plate glass. Pressure and heat will aid the transfer. The heat can be applied by soaking a towel in hot water and laying it over the glass plate. Pressure can be furnished by any weight, such as a brick or flatiron placed on the glass pressure plate. If the cover glass is held over a tray of hot water for a few minutes before transfer, the underside will be covered with drops of water, the glass itself will be warm, and the combination will aid transfer. The glass plate on which the support paper rests may be placed over the tray full of hot water.

After a few minutes, remove the pressure plate or heating material and peel off one corner of the matrix to see if transfer is taking place properly. Note particularly the shadows, since it requires more time for the dye to transfer from the points where there is a quantity of it. If it is seen that good contact has not been secured or that some parts of the image are not transferring, douse the support paper with warm water and promptly squeegee down the matrix again.

If there is a spot of dust or rust or any other foreign material on the matrix or imbedded in it, there may be quite an area surrounding this material in which the dye will not transfer. This is another reason why the matrices must be made with great care, especially during the stages after the gelatin has been softened by hot water. Smoking in the darkroom is absolutely taboo for this reason. The merest fleck of ash will imbed itself in the soft gelatin and will prevent dye transfer later. This ash, or whatever the foreign material is, must be dug out of the gelatin with a knife or other sharp tool

thus leaving a bad hole in the picture, which will be spotted in the final print.

**Warning!** Kodak Wash-off Relief film is nitrate film, not acetate. It is highly inflammable and dangerous because of its speed of combustion and because of the fumes given off in burning. This is another reason why there should be no smoking in the darkroom. Waste wash-off film should be burned out of doors—not dumped in the garbage can. Otherwise one may be responsible for a bad fire. The newer Kodak Matrix film is on safety (acetate) base and so this danger is not present.

After the first color has been transferred, the matrix can be returned to the dye bath or hung up to dry. Cover the support paper now containing a color image with the Kodaloid, again leaving  $\frac{1}{2}$  inch at the bottom edge free. Again allow some of the acid bath to drop on the Kodaloid, lower the second matrix (cyan) on this Kodaloid, and under a good light register the two images. A 6- to 10-power achromat magnifying glass will help. If you are nearsighted, remove your spectacles and approach the matrix very closely with your eyes, thus securing the effect of a magnifying lens without actually using one.

During the registration process, select sharp outlines in opposite corners to look at. Naturally it is easier to register large images than small ones, since the details will be larger. When registry is complete, clamp the bottom edge of the matrix to its support paper and glass plate or hold the matrix tightly with one hand. Holding the unclamped edge of the matrix in the teeth, remove the Kodaloid and let the matrix fall back on the support paper, squeegeeing it down tightly at once.

When the third (yellow) image has been transferred, the picture is complete. Its surface should be wiped free from moisture, and the print can then be dried between blotters or hung from a line with clothespins at the bottom corners to prevent too serious curl. Spotting can take place while the print is still wet.

### *After Transfer*

While the matrices can be placed in their respective dyes again immediately, it is better to soak them briefly in a 0.1 per cent ammonia solution\* (0.5 cc strong ammonia water to 500 cc of water), then rinse them in warm water to remove the ammonia. If transfer goes through without trouble, however, there should be very little dye left in the matrix.

#### SUMMARY OF WASH-OFF PROCESS

1. Make three separation negatives.
2. Print by contact or by projection onto three wash-off relief films, exposing through the film support. Expose so that a bright part of the picture has a slight veil of gelatin over it after the film has been developed in warm water.
3. Develop 5 minutes in DK-50 at 68°F.
4. Wash 5 minutes in running water at not more than 70°F or in a half-dozen changes of water.
5. Bleach in R-10a for 4 minutes.
6. Turn lights on. All following processes can be handled in full light.
7. Wash off in warm water (110 to 125°F). Use four or five changes of 1 minute each. Film now very easily damaged.
8. Fix 1 minute.
9. Wash 5 minutes in running water or in several changes of water.
10. Dry. This is a good stopping place.
11. Dye in cyan, magenta, and yellow solutions 5 to 30 minutes. Tip tray occasionally.
12. Rinse in dilute acetic acid of proper concentration.
13. Superimpose reliefs on tray bottom for inspection.
14. Give corrective treatment if necessary. This is a second good place to interrupt the process.
15. Prepare mordanted paper for transfer. Soak reliefs in acetic-acid solution while preparing paper.
16. Stretch support paper.
17. Squeegee magenta relief to wet stretched mordanted paper.

\* Or the solution furnished with the Kodak Dye Transfer kit for this purpose.

18. Allow magenta relief to remain in contact until transfer is complete.

19. Remove magenta matrix, splash water over magenta image, cover with Kodaloid, register blue relief.

20. Remove Kodaloid, allow cyan relief to transfer.

21. Remove cyan relief, cover image with water, and then with Kodaloid.

22. Transfer the yellow relief.

23. Dry print.

24. Dry matrices, or redye for another print.

#### WASH-OFF FORMULAS

##### *Plain hypo for fixing out paper*

Water	32 ounces	500 cc
Hypo	8 ounces	240 grams

##### *Developer DK-50*

<i>Dissolve chemicals in the order given</i>	<i>Avoirdupois</i>	<i>Metric</i>
Water, about 125°F (50°C)	64 ounces	500 cc
Elon	145 grains	2.5 grams
Sodium sulfite, desiccated	4 ounces	30.0 grams
Hydroquinone	145 grains	2.5 grams
Kodalk	1 oz. 145 gr.	10.0 grams
Potassium bromide	29 grains	0.5 gram
Cold water to make	1 gallon	1.0 liter

Use without dilution and develop 5 minutes at 68°F (20°C).

##### *Bleaching Solution R-10a*

##### *Stock Solution A*

	<i>Avoirdupois</i>	<i>Metric</i>
Water	16 ounces	500 cc
Ammonium bichromate	290 grains	20.0 grams
Sulfuric acid, C.P.	1 dram	4.0 cc
Water to make	32 ounces	1.0 liter



*Stock Solution B*

Water	32 ounces	1.0 liter
Sodium chloride	1½ ounces	45.0 grams

For use, take 1 part of A, 1 part of B, and 6 parts of water.

*Fixing Bath F-5*

<i>Dissolve chemicals in the order given</i>	<i>Avoirdupois</i>	<i>Metric</i>
Water, about 125°F (50°C)	80 ounces	600 cc
Sodium thiosulfate (hypo)	2 pounds	240.0 grams
Sodium sulfite, desiccated	2 ounces	15.0 grams
Acetic acid 28 per cent*	6 fl. oz.	48.0 cc
Boric acid, crystals†	1 ounce	7.5 grams
Potassium alum	2 ounces	15.0 grams
Cold water to make	1 gallon	1.0 liter

\* To make approximately 28 per cent acetic acid from glacial acetic acid, dilute 3 parts of glacial acetic acid with 8 parts of water.

† Crystalline boric acid should be used as specified. Powdered boric acid dissolves only with great difficulty and its use should be avoided.

Dissolve each chemical completely before adding the next one.

Discard the bath after eighty to one hundred 8 by 10-inch films, or their equivalent in other sizes, have been fixed per gallon (4 liters).

*Mordanting Solution M-1**Stock Solution A*

	<i>Avoirdupois</i>	<i>Metric</i>
Water	32 ounces	1.0 liter
Aluminum sulfate	6¾ ounces	200.0 grams

*Stock Solution B*

Water	16 ounces	500 cc
Sodium carbonate, desiccated	1 oz. 145 gr.	40.0 grams

Add B slowly to A, stirring well while mixing. A white precipitate is formed at first, but this dissolves upon further stirring. If a trace should remain, it can be filtered out with a rapid filter paper.

*5 Per Cent Sodium Acetate Solution*

Dissolve sodium acetate, anhydrous, 50 grams in 750 cc of water and add water to make 1 liter; or dissolve sodium acetate, anhydrous,  $1\frac{3}{8}$  ounces in 24 ounces of water and add water to make 32 ounces.

*Notes on Wash-off Process*

The following notes have been gathered from many sources, including the personal experience of the author.

If the matrices are rinsed briefly in water before impressing them on the final support paper, the transfer will be hastened. This water rinse removes some of the acid and enables the mordanted and buffered paper to take up the dye more rapidly. Too much rinse will cause running of the dye (bleeding), however.

If one color of a completed print seems too weak, the matrix can be re-dyed, and this dye can be transferred before the print dries out too much.

You must learn to know how the print will look finally from studying the superimposed matrices on a tray bottom. These images are wet and will be somewhat brighter than when transferred to paper. All of the dye may not leave the matrices, and consequently, the final picture may not be exactly the way it looks on the tray bottom. Some magenta dyes have a bad habit of intensifying in transfer—i.e., the final print may be much pinker than was expected from an inspection of the three superimposed matrices before transfer. You must learn by experience how much to compensate this difficulty by making the superimposed print slightly olive green in color—i.e., lacking in magenta.

Liberal wetting of the support paper with dilute acetic acid, say a 0.1 per cent solution, or warm water before transfer, gets rid of air bubbles, which will cause spots on the final print. Quicker and easier transfers will result if the mordanted paper is soaked in a sodium acetate solution just before transfer. Start with 0.5 per cent solution; if the dyes tend to run or "bleed" on transfer, reduce the strength to 0.25 per cent or to 0.125 per cent.

Another presoaking solution is as follows:

Diethelene glycol	100 cc
Water	700 cc
Sodium acetate	10 grams
Acetic acid, 28 per cent	5 to 20 cc

The amount of acid depends on the tap water used. If bleeding occurs, increase the amount of acid.

If the negatives are placed between glass in the enlarger, the glass must be clean. Dust spots on any of the four surfaces of the glass are either on the same plane as the image or very close to it and will be enlarged by the same magnification by which the image is enlarged. They will require some fancy spotting after the print is completed.

A good safe edge is a necessity, particularly along the edge that is to be held tight to the support paper when transfer is to be made. This edge should be at least  $\frac{1}{2}$  inch wide and wider in larger pictures. There must be a good "biting" edge here so that the matrix will not slip after registry has been attained. Paper clamps tend to corrode or to rust and in so doing tend to pollute the surface of the matrix with minute rust particles. These are certain to cause trouble.

In squeegeeing the matrices to the support paper, start off lightly to get rid of the surplus water, then press harder, working from the center outward. Heavy pressure at the beginning may force the matrix to move, thus destroying register and making a double or offset image.

In the hand-transferring method, not using the Kodak blanket, the following technique may be found useful. After the matrix is properly placed over the support paper and has been clamped to the support paper so that it cannot move, hold the free end and remove the Kodaloid sheet, placing it on the support side of the matrix while still holding the latter away from the mordanted paper. Now using a heavy roller squeegee, roll the matrix and Kodaloid down on the support paper in much the same fashion employed with the Kodak blanket. Only one swipe of the roller is necessary. If the support paper has been properly conditioned, the

images will transfer quickly and without application of heat or pressure.

In all these color processes, remember that chemistry is the manufacturer's problem; the mechanics is your problem. The manufacturer tries to think of all the tricks you are likely to attempt and he tries to circumvent you before you start. But he can't think of all of them. Until you are certain of your own technique, follow directions.

Exposure of the negatives to the wash-off film should be within 5 per cent of the exact best possible exposure. It is much better to hit it right than to depend on compensations for underexposure (impossible) or overexposure later. To make the exposure correct within 5 per cent requires rather long exposure times so that this accuracy can be attained. If the correct exposure is 30 seconds, 5 per cent will be  $1\frac{1}{2}$  seconds. A good photo timer should be at least this accurate. A watch or clock with a sweep hand making one rotation per minute will enable you to come within 5 per cent of the correct time. As a matter of fact, you can hit an exposure within about 1 second, estimating an error or time lag of  $\frac{1}{2}$  second in turning it on and off. If the estimated exposure is 10 seconds and if there is a 1-second cumulated error, the exposure may be 10 per cent over or under the proper exposure value. If it is over, the error can be corrected later; if the matrix is underexposed, the high lights will be blank and nothing can be done about it except to remake the matrices.

Too much heat applied to the transfer process may cause the matrix to stick to the transfer paper. Chunks of gelatin often come off the matrix, perhaps due to contamination of the surface prior to or during processing. For example, tiny drops of hypo prior to the bleach step will affect the gelatin so that it is destroyed during the later transfer operation.

Wash-off film has a natural curl. If a sheet of film from which the emulsion has been washed off in hot water is squeegeed over the matrix being transferred so that the natural curl of this film is

down, then it will hold the colored matrix tightly to the transfer paper, will retain the moisture of the mordanted paper, and will materially aid the transfer. This extra sheet of washed-off film can be the material used to isolate the mordant paper from the matrix during the registration process.

To determine if the dye baths are in balance, prepare a wash-off gray scale, dye it in each of the colors, and transfer the parts one at a time to a piece of mordanted paper. This scale should be definitely colorless. Another way is to select one of a set of matrices, to dye it in one color, transfer this color, then dye it in the second color and transfer this image, finally putting on the third color. This should result in a well-modulated, good-looking black-and-white print. If the print, or gray scale, has color, the dyes are out of balance. Either reduce the acid in the offending dye or bring the other two up to the concentration of the third. The end point should be a colorless image.

If the transfer blanket is not used, safe edges should be at least 1 inch wide so that good gripping contact can be made between matrix and the transfer paper. The dye-transfer paper is slippery (which is one reason why it should be squeegeed before transfer), and a good wide safe edge is a help in preventing lack of register due to slippage of the matrix during the transfer. Use a roller, not a flat squeegee.

### *Judging Correct Exposure*

The method described above of determining correct exposure is only one method. It calls for a test of a critical high light to determine the exposure that will allow a faint but perceptible amount of gelatin to remain after the hot water treatment and after fixing. This gelatin will soak up a faint but perceptible amount of dye. Select the red-filter negative and make the test from that. Process it all the way through, dyeing it cyan and transferring it to the mordanted paper.

If the picture contains no white or neutral color, then more judgment is required to hit the exposure correctly. Again choose the red-filter negative and select a critical portion, a part of the picture that is important. Make a test, using a larger sheet of film than would be required if a white object formed the test image. Process this test and transfer it to paper. View it through a red filter such as the Wratten No. 25. A cyan image through a red filter will appear black. Here your experience at making black-and-white pictures will come in handy. If the image looks as good as one you could make of a similar picture by ordinary monochrome technique, then the correct exposure has been found. Experience is a great teacher.

Once you have learned the relation between the best possible black-and-white print and the appearance of a cyan image through a red filter, then you can start to make a color print by making a monochrome on, say, a No. 2 enlarging paper first. When the high lights are slightly darker than a clear unexposed part of the paper print, then the exposure required bears some relation to the exposure required to produce a color print of the same quality.

To learn the relative exposures of wash-off film and a No. 2 paper, proceed as follows. Make an exposure of the paper to a gray scale having a density range of about 1.0 or a little more. Now make the best guess at the correct wash-off exposure, process it, and transfer the cyan image to the support paper to be used in the color prints. Now, compare the two scales, one of which is blue but will appear gray through a red filter. If they are alike, then the relative printing exposures for the paper and the film have been determined. For example, if 10 seconds were required to make the black-and-white picture and 20 seconds to make the wash-off that looks like the monochrome, then the relative speeds of the two emulsions is 1 to 2. Now you can make a good print from one of the negatives, usually the red-filter negative, on the No. 2 paper and determine the best exposure. Whatever this turns out to be, the wash-off film should be given twice the exposure.

If Kodabromide N2 is employed, it may be processed in DK-50 for 5 minutes. Then the wash-off exposure will be very close to that given the Kodabromide. Curtis recommends the use of Defender Velour Black BT-2 developed exactly 2 minutes in Curtis developer CD-128.

Whatever paper and developer are employed, remember that manufacturers have "bred" great latitude into their papers, so photographers have become quite careless in making their black-and-white prints, guessing at the exposure and relying on the change of color in the developer to protect them against errors of judgment in exposure. Develop the test black-and-white print for exactly 2 (or some other chosen value) minutes in a fresh developer. Fix and rinse the print. Look at it in good light very critically. The paper-clip method described before will aid in producing a good monochrome. There should be a just perceptible density in the high lights compared to the clear area under the paper clip.

With any color-printing system the criterion for correct exposure to the separation negatives is the high light. If this is white, there should be just enough exposure so that the merest trace of dye is transferred. This can be determined by exposing a test piece of matrix film to a step tablet (gray scale) and by determining the density of the step that gives this faint image. If the illumination at the easel is 5 foot-candles as determined by an exposure meter, the test exposure at  $f/11$  should be about 10 seconds.

As a concrete example, consider the negatives mentioned in the previous chapter, which had densities as follows.

<i>Negative</i>	<i>Maximum Density</i>	<i>Minimum Density</i>	<i>Contrast Control in cc per 6 Ounce Developer</i>	<i>Exposure in Seconds</i>
Red filter	1.60	0.4	6	10
Green filter	1.60	0.4	6	10
Blue filter	1.60	0.5	11	10.8

The enlarger was an Elwood, 5 by 7, the lens an Eastman Anastigmat  $7\frac{1}{2}$  inch opened to  $f/8$ , the lamp a GE 211 operating at 110 volts, the enlargement about 1.7 times; a 2A filter was employed. The resulting print was perfectly satisfactory.

In the Kodak Dye Transfer process, the silver-halide images are not removed from the matrices. Therefore the black image prevents one from seeing the dye images. A first print must be transferred to determine if the colors are correct or not. It is much more important, for this reason, to make good, well-balanced negatives, to calculate carefully the proper exposures to the matrix film, to control these exposures, and to process the matrices carefully.

Since the entire processing up to dyeing the matrices takes only a few minutes, you will probably save material and time by making an actual print of the critical part of the picture. If it is a portrait, make three test matrices of the face, dye and transfer them. Thus, before the entire picture is made, adjustments can be calculated so that the three final matrices are much closer to the required densities. This method is virtually a necessity unless the transparency or the original scene contains a white element. If the brightest part of the picture is a blue sky, or a red dress, for example, the densities representing these subjects in the negatives will differ widely among themselves. If the blue sky is the brightest high light, then the red-filter negative (which will print blue) will have a low density in the sky; the green-filter negative (which will print magenta) will have a higher density; and the blue-filter negative (printing yellow) will be quite dense. How under these circumstances are you to tell how to expose the negatives to the matrix film? The only way the author knows is to make a small-scale test or to test a critical part, say a 4 by 5 piece of an 8 by 10 print, using the best judgment you can develop by experience.

If the subject is a portrait, you can remember that the cyan printer only gives definition and detail to the final print. The face in the final print will be made up very largely of yellow and



magenta dye. In this case, a test of the cyan print only may suffice to tell you whether your guess at the correct exposure is good or bad.

### *Use of Densitometer to Determine Exposure*

If you have a means of measuring densities, a systematic method of starting your experience with imbibition printing is as follows. If the prints are to be made by projection, decide on the degree of enlargement. Try to make it some round number, say 2 or 3 times. Adjust the enlarger to this point. If contact prints are to be made, determine a fixed position of the printing frame and the light source. Using the Stripmeter, expose a test piece of film to a transparent gray scale whose densities are known. Process this film all the way through, dyeing it cyan and transferring it to mordanted paper. Now select the gray-scale step that gives a just perceptible deposit of cyan dye.

It is known that a given exposure, say 20 seconds, through a density of 1.7, as an example, with the light source and film at certain fixed relative positions produces the desired result. It is not difficult to calculate from these data what exposure will be required through some other density or with some other degree of enlargement. Either determination can be made by means of the Kodak Print-exposure Computer, or the exposure required as a function of the degree of enlargement can be calculated as described under CALIBRATE THE ENLARGER in Chapter VII, and the exposure required through densities differing from the test density can be determined from the following table. All you need to know is the test density and the density of the actual negative to be printed. The difference between these two densities is the required figure to determine the exposure multiplying factor.

Suppose the test density that produced the desired result was 1.7 with a 20-second exposure at some fixed degree of enlargement and at some lens opening. It is desired to produce the same result through a negative whose maximum high-light density is 1.5. What

<i>Density Difference</i>	<i>Exposure Multiplying Factor</i>
-0.7	0.2
-0.5	0.3
-0.4	0.4
-0.3	0.5
-0.2	0.63
-0.1	0.8
0.0	1.0
+0.03	1.08
+0.04	1.1
+0.06	1.15
+0.08	1.2
+0.10	1.26
+0.15	1.4
+0.175	1.5
+0.20	1.6
+0.3	2.0
+0.4	2.5
+0.5	3.15
+0.6	4.0
+0.7	5.0
+0.8	6.3
+0.9	8.0
+1.0	10.0

will be the necessary exposure? Obviously it will require a shorter exposure to produce the result through a lower density.

The difference between the two densities is 0.2 and it is negative, meaning that the negative density is less than the test density. Therefore the table says that 20 seconds should be multiplied by 0.7. In other words, 70 per cent of the test exposure will be needed. Suppose that the negative density is greater than the test density. If it happens to be 2.0 (a dense negative), the difference between this value and the test density is 0.3. The table tells you that it will take twice the test exposure, or 40 seconds.

One thing to remember is that it is not too difficult to remedy a matrix that has been somewhat overexposed but that it is impossible to do anything with one that is seriously underexposed. Therefore, it is wise to make the best possible calculation, then add about 5 per cent.

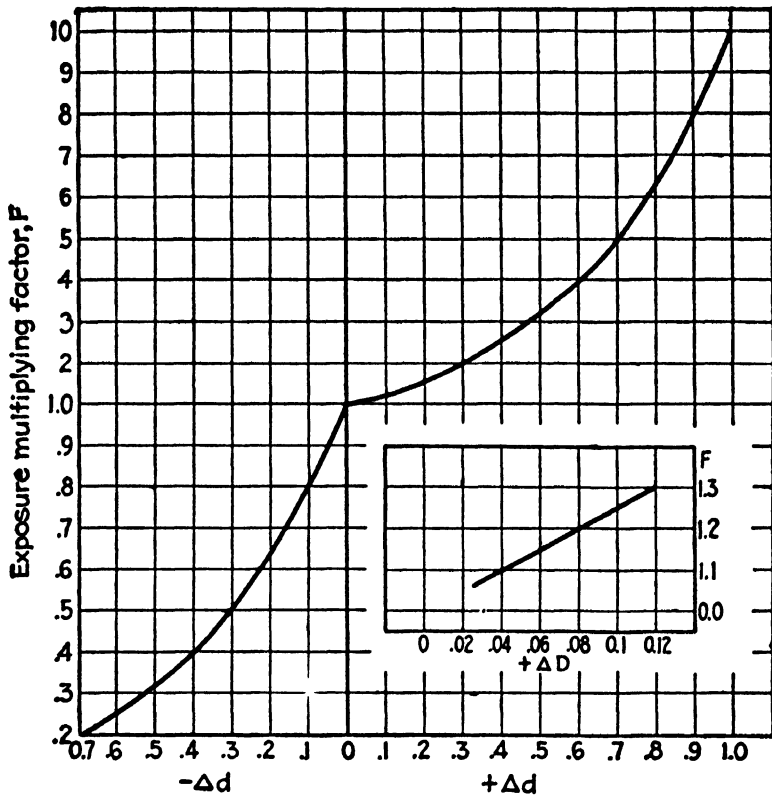

If the correct exposure is known for one negative density, the multiplying factor for another density is obtained from these curves. Thus, if the new negative density is less than the standard by 0.1, multiply the standard exposure by 0.8—i.e., take 80 per cent of the standard exposure.

## Contrast Control

In the Kodak Dye Transfer method as well as in Curtis Orthotone it is possible to adapt the matrices to the negatives so that only one set of dyes is necessary. In the example cited on page 292, note that, although the maximum density of the blue-filter negative was less than that of the other negatives, the exposure of the matrix film to this negative was greater. This was due to the fact that the minimum density of this negative was greater than that of the others. More contrast-control solution was added to the developer than to the matrices exposed to the red- and green-filter negatives to increase the contrast of the yellow printer matrix. When printed, the whites were slightly grayed over, indicating that an exposure somewhat shorter could have been used; but neutral objects in the transparency were reproduced as neutral in color.

## OTHER TANNING DEVELOPERS

It has been known for a long time that certain developing agents "tan" or harden gelatin as they develop the image. Many workers have used pyro for this purpose, and while Eastman Kodak does not tell what is in the developer employed in its new Dye Transfer process, it is certain that some developing and tanning agent is in the solution.

Processing the matrices in a tanning developer is a much faster process than that followed by conventional wash-off techniques. If you use Curtis tanning developer TD-142, the films are given a 2-minute development and are then flooded with 0.5 per cent acetic-acid solution shortstop. The white lights may now be turned on. The films are given the usual hot-water treatment at this point, whereupon a black silver image becomes clearly visible. This image looks like a straight black-and-white print and can be critically observed at this point. What is seen now in monochrome will appear later in color. If the high lights are washed out because of

underexposure, they will not show up in the final color print. If the image is dull, dark, and muddy, the final print will show the cause to be overexposure.

The silver image can be eliminated by use of Curtis clearing bath; then a rinse in cold water and a few seconds in a plain 20 per cent hypo bath complete the processing.

The following formula (E. M. Symmes) may be tried by those who wish to save time by the tanning method.

#### TANNING DEVELOPER

Sodium sulfite	3 grams
Pyro	5 grams
Potassium bromide	3 grams
Sodium carbonate, monohydrate	50 grams
Water to make	1,000 cc

Develop for 5 minutes; place the film in the hot water (still under safelight), dry, and dye.

In this case the silver image remains, so it will not be possible to determine the color balance of the picture until it is finally transferred.

Another tanning process used during the war is as follows.

The films are developed for 4 minutes at 68°F in G-992, rinsed one minute in 0.5 per cent acetic acid, washed 2 minutes in running water, bleached 2 minutes in 5 per cent potassium ferricyanide, washed 1 minute, fixed 4 minutes in 20 per cent hypo, washed 2 minutes in running water, washed 15 seconds in hot water, dried, and dyed.

#### TANNING DEVELOPER G-992

Citric acid	3.2 grams
Pyro	128 grams
Sodium sulfite	32 grams
Ammonium chloride	24 grams
Potassium bromide	24 grams
Water to make	1 gallon

Use 1 part of this stock solution to 10 parts water, and add 15 cc of 10 per cent sodium hydroxide to each liter (quart) of working solution.

None of the pyro developers keeps well once it is exposed to the air. G-992 is stated to keep well in stock solution, but like all pyro formulas it oxidizes rapidly in a tray. Thus when you use a pyro tanning developer, you must work fast, getting the matrix into the solution quickly once the working solution is mixed, timing the process accurately, keeping the temperature uniform. Use a developer only once.

The tanning developers require that the dyes be stronger than when a developer like DK-50 is employed. You must determine the acid concentrations for yourself.

## DYES

Various manufacturers have supplied dyes for wash-off relief printing. The requirements are very severe. They can be summarized briefly as follows:

1. They must be reasonably permanent to light. Remember that no dyes are absolutely permanent.

The author has prints on a wall facing a north sky that have completely lost their color in a matter of three years. No direct sunlight illuminates them.

2. The colors should be correct—i.e., they should absorb certain portions of the visible spectrum and reflect the rest. No dye is perfect from this standpoint.

3. They must be capable of complete transfer from the matrix to the mordanted paper.

4. In combination they must be capable of producing a neutral gray without too great dissimilarities in other characteristics.

5. They should not bleed or diffuse. In other words, they should make a sharp picture.

6. The tendency of the dyes to change visual hue, depending on the quality of illumination in which they are viewed, should be minimized.

7. They should transfer rapidly, go into the gelatin relief image easily, be capable of making a reasonable number of prints before they are exhausted.

8. They should respond to variations of acid content so that varying contrasts are possible.

Thus it is seen that one cannot go into the drugstore, purchase some dyes made for cloth and expect to get perfect prints at very low cost. Some dyes transfer easily but have poor hues. Others have one good quality and several bad ones. Years of research and testing have gone into the production of sets of dyes now available.

Eastman put the first dyes on the market. They have excellent color, are slow to dye the gelatin, and transfer slowly; heat and pressure, however, materially aid in the transfer process. These dyes are available in powder form and are to be dissolved in boiling distilled water; the contrast is controlled by use of 5 per cent acetic acid solution. Citric acid can be used in the magenta dye only, twice as much being required as acetic acid of the same strength (5 per cent). A 500-cc cyan dye bath is good for ten to twelve 8 by 10 prints; the magenta is good for a somewhat larger number of prints; the yellow will last quite a bit longer. For contrast control, start with about 5 cc of 5 per cent acetic acid in each dye bath, more acid producing greater contrast. To reduce the contrast of a dye bath, add 5 per cent ammonia, 1.5 cc neutralizing about 5 cc of either 5 per cent acetic or citric acid. The matrices should be rinsed in 0.5 per cent acetic acid (2.5 cc of glacial acetic per liter or quart) and then in 0.1 per cent acetic (0.5 cc glacial acetic per quart) just before transfer.

Kodak dyes for use with the newer Dye Transfer process are in liquid form and are to be diluted with distilled water. No acid is to be added to these dyes since contrast is controlled in making the matrices. They dye fast and transfer fast. The matrices are to be rinsed in 1 per cent acetic acid (10 cc glacial acetic acid per liter or quart). After four 8 by 10 prints or the equivalent area of prints of other sizes have been made from a liter (quart) of solution, the dye baths are replenished by adding dye concentrate according to a schedule provided by the manufacturer.

If the dyes are found to be out of balance—i.e., they will not produce a neutral gray scale when a step tablet or gray scale is printed onto matrix film and dyed and transferred—the dyes that lack color can be pepped up by adding 1 to 10 cc of 28 per cent acetic acid.

### *Curtis Dyes*

Curtis dyes are liquid in form and are to be diluted with cold distilled water. Acetic acid, 5 per cent in strength, is used as contrast control, about 5 cc being used per pint of working dye as a starter. Each pint will make about ten to fifteen 8 by 10 prints. The matrices are rinsed in 0.5 per cent acetic acid. These dyes go into the gelatin quickly and transfer quickly.

### *Defender Dyes*

These dyes are taken up by the gelatin quickly and transfer quickly. They come in liquid form and, like the other dyes, must be mixed with distilled water. Citric acid, 10 per cent in strength, is used as contrast control. About 20 cc per liter are needed for a print of normal gradation from average separation negatives. As little as 5 cc or as much as 80 cc per liter of the citric acid can be used, depending on the contrast of the prints that is desired. The matrices are rinsed in 0.5 per cent acetic acid. The dyes have excellent color.

### *Other Dyes*

Although the simplest possible method of getting dyes for wash-off processes is to purchase them ready-made from the manufacturers, some photographers prefer to make up their own. Some amateurs have used ordinary household dyes, but since this book is written for those who are interested in making photographs of best quality, it is believed desirable to use dyes compounded for this purpose. The following data have been assembled from various sources.



In an article on the subject in *Photo Technique*, November, 1940, Howard C. Colton and Silas M. Thronson advised the use of the following dyes:

Cyan: Acid Anthraquinone Blue AB, made by Du Pont

Magenta: Anthraquinone Rubin R. Conc., made by Du Pont

Yellow: F. D. & C. Yellow No. 5 (Tartrazine) made by General Aniline

The dye solutions are prepared by dissolving the dye in hot distilled water and then adding the prepared buffer solution. The quantities used in making up one liter of working solution are as follows:

Cyan dye	1.3 grams
Monosodium phosphate ( $\text{NaH}_2\text{PO}_4 \cdot \text{H}_2\text{O}$ )	7.5 grams
Borax ( $\text{Na}_2\text{B}_4\text{O}_7 \cdot 10\text{H}_2\text{O}$ )	7.0 grams
Magenta dye	3.0 grams
Monosodium phosphate	12.5 grams
Borax	5.0 grams
Yellow dye	2.0 grams
Monosodium phosphate	20.0 grams
Borax	2.2 grams

The weights of dye can be dissolved in half the liter of water and the buffer dissolved in the other half, whereupon the two solutions can be combined. Addition of 10 cc of formaldehyde per liter of solution will prevent formation of mold in stored solutions. The dye solutions should be filtered before using.

As compounded, the dye solutions will give low contrast reliefs. To enable or force the reliefs to take up more dyes, the solutions can be acidified by the addition of equal amounts of 5 per cent acetic acid. The purpose of the buffer is to extend the range of contrast control. Without the buffer, addition of only a small amount of acid will cause the gelatin reliefs to take up all the dye possible; so that the actual control of contrast is rather ticklish.

The dye solutions compounded according to the formulas will require from 10 to 50 cc of 5 per cent acetic acid per liter of solution.

Colton and others have mentioned dyes other than those indicated above as being satisfactory or at least useful. These dyes are as follows:

Cyan: Alizarine Astrol N; General Dyestuff Corporation.

Magenta: Alizarine Rubinol R; General Dyestuff. Erio Anthracine Rubine B; Geigy Dyestuff Corporation.

Yellow: Tartrazine for Lakes; Du Pont. Almost all dye manufacturers make tartrazine dyes.

### *Color Prints by Dye Mordanting*

Several processes have been described for making prints by dye-mordanting methods using acid dyes. In *American Photography*, June, 1947, E. M. Symmes describes one such process—known as Neotone. Kodalith Stripping Film is employed to make black-and-white positive prints from the separation negatives. After development they are fixed, bleached, and dyed. Then the separate positive images are mounted together—and in register—to make the final print. The author has had no experience with this method and, therefore, can only offer it for the color photographer inclined to experiment.

The bleach solution is made up of 20 gm of copper sulfate, 10 gm of potassium bromide, 2 gm of chromic acid, in 1000 cc of water. The dyes are made up of Carmoisine C, Neptune Blue, Royal Yellow, Azo Rubine and Pure Red CA, one part of dye and one part of sodium acetate to 1000 parts of water.

## Carbro Pigment Printing

**I**N WASH-OFF and dye transfer color printing, the final color is made up of dyes. In the Defender Chromatone process in use before the war, the images were "toned"; in the carbro process the images are pigments.

Carbro is the oldest color-printing process now in use. Professional photographers doing most of the color work still employ carbro, perhaps because they are familiar with it and see no reason to change to a process with which they have had no experience. So prejudiced are purchasers of color photographs (prints) that all color prints, no matter by what process they were made, should be sold as "carbros." There is no doubt that carbro makes very beautiful prints, perhaps the most beautiful and most permanent of all.

It is a longer process than wash-off; it is much more time-consuming to make multiple prints of the same subject; but there is one great advantage—carbro starts with good bromide black-and-white prints. Having such good prints, one is sure of a successful print if he manipulates the rest of the work properly.

Carbro can be practiced by anyone who is good at processing, no matter whether he is interested in full-color prints or not. The amateur may wish a print of a fire to be red; or a water scene may be printed in a green or blue. Carbro lends itself to monochrome in color that may be any one of many hues.

### MONOCHROME CARBRO

The amateur getting started in carbro for color work could do no better than to make a few carbro prints in a single color. Thereby

he will learn the method and the troubles. He will be better prepared to tackle the more difficult job of printing three carbros, in the colors complementary to those of the filters through which separation negatives are made, and then of superimposing these three images.

For a start, suppose you are to make a carbro of a single color. First you print your negative on bromide paper, usually by projection, although contact printing may be done, too. This bromide print will not differ from those you regularly make, except that it must be fully exposed, but not overexposed. A white margin of  $\frac{1}{2}$  inch should be left around the print. This print can be on any matte or semimatte bromide paper, although some are better than others. The print should be fully developed and fixed in a non-hardening fixing bath. Then it should be thoroughly washed and dried, or it can be used immediately for the carbro if desired.

Suppose the bromide print is ready for the carbro process. Carbro paper\* comes in many colors, including the proper blue, red, and yellow for three-color prints. It consists of a rather heavy paper support with a heavy deposit of solid pigmented gelatin on one surface. To get ready the carbro material, known as tissue, place it in two solutions in turn or in a single solution. This is known as sensitizing. Actually, the solutions make the pigmented gelatin soluble in water after it comes in contact with silver. After sensitizing the tissue, place it in contact with the bromide (which has been soaked in water for a time) and squeegee it to the bromide. After about 15 minutes strip the bromide and the tissue apart.

Now it will be found that the image of the bromide has practically disappeared. Actually it has been bleached by the carbro sensitizing solutions; it is a dirty yellow-brown in color. It can be washed and redeveloped in any good MQ or other developer. This will bring back the image, and the bromide can be used again although it is desirable to use a fresh bromide for a second print.

\* Obtainable from George Murphy Inc., New York.

Now squeegee the carbro tissue in contact with a support paper on which the final image is to appear. After about 15 minutes place the support paper and the carbro tissue in warm water for "development." This warm water gets in between the tissue and the support paper, soon causing them to separate, and dissolves away the pigment that has not become insoluble by being in contact with the silver image of the bromide.

Thus the final support has on it an image in the color of the carbro pigment paper chosen. This image is not a silver image at all but is a pigment image. As already stated, the color of this print can be any one of many hues available from the manufacturers.

Now it will be seen that to make a fully colored print, three carbros would have to be made, in the complementary colors, and on the final support these three colored images would have to be transferred in register. This is the three-color (trichrome) carbro process as actually practiced at the present time. It is a bit more complicated, however, since there is an additional step or two and there are actually three prints made to produce the final single-colored print.

### TRICHROME CARBRO

Prewar carbro suffered from several faults, which made it very difficult to get good color prints and often necessitated much expensive color retouching. Often the final print was (practically) painted by an artist who used the photographer's carbro merely as a base upon which to put his colors. The greatest difficulties were known as "frilling"—i.e., part of the image would leave the support so that one or more colors would be lacking in the final print, giving it a very spotty appearance. It was difficult to retain detail in high lights where the pigment was exceedingly thin. For this reason it was easier to make prints that were very strong in color. In addition, the high lights tended to become cloudy, veiled over

with a deposit of each of the colors, the combination making high lights that should have been white actually gray in color.

In recent years much improvement has been effected not only in solving the fogged appearance of the prints but also in retaining high-light details. The cause of the grayish overcast was fog—i.e., the pigment paper developed a thin layer of insoluble pigment on the outer surface where it came in contact with the air. This problem has been solved by forming the image on the surface of the pigment paper that has not come into contact with air—i.e., on the surface next to the support paper. In addition, the spectral characteristics of the pigments have been improved so that they are nearer the ideal from the standpoint of reflection and absorption of light.

You start with separation negatives, of course. Since there is less opportunity for contrast control in carbro than in wash-off, you should start with the best possible negatives, well balanced as to contrast or density range. Negatives made from subjects lighted for color—i.e., fairly flat—should have a density range of 1.0 to 1.2. These negatives will be about as contrasty as would be recommended for wash-off and are well within the range suggested for dye transfer.

### THE MCGRAW COLORGRAPH METHOD

Pigment papers bearing the three tricolor pigments obtainable from the McGraw Colorgraph Company are designed to be stripped—i.e., the actual layer of pigment is removed from the paper on which it is purchased and is remounted on a transparent plastic. In this manner the layer of pigment that has come in contact with the air is placed next to the plastic support, the image being formed in the layer that previously was protected from the air by being cemented to the support paper. This method gets around the fog problem. It does, however, add one step to the carbro process—a step not required in the older methods. This step consists in remov-

ing the pigment from the paper support and transferring it to the plastic.

The following steps are required:

1. Make bromides. These are ordinary black-and-white prints made by contact or enlargement from separation negatives. These prints should be made on paper specially made for carbros—i.e., without a hardened gelatin supercoating.

2. Transfer the pigment from the paper support, the form in which it is purchased, to the transparent plastic.

3. Sensitize the pigment. In this process the gelatin-bearing pigment is affected so that, where it comes in contact with the silver halide image of the bromides, the gelatin will be hardened. In a subsequent warm-water wash, this hardened gelatin will remain while the remainder of the gelatin will melt and wash away carrying with it the pigment contained in it.

4. Bring the bromides in contact with the sensitized pigments. In this process the bromide images are bleached, and the gelatin is differentially hardened in proportion to the amount of silver present in the silver bromide image.

5. Attach the pigment to another support known as the registration plastic.

6. Develop the image in warm water. At the end of this step, each of the three separation images in its final colored form will reside on a transparent plastic support.

7. Transfer each of the separate images to a soluble support. This involves registering the magenta and the yellow images to the cyan, which is transferred first.

8. Transfer again. In this final step the three-color image is really seen for the first time. Up to this point the yellow image, which is not too transparent, is on top and one can see through it to a small extent only.

Since the several transfers require that the images dry before the next step is undertaken, it is seen that quite a bit of time can transpire between the start and the end of the process. This has the disadvantage of requiring appreciable time; but the advantage is that there are many stopping places where one may sign off tem-

porarily to resume the remaining steps at a later time. This feature is valuable to an amateur who may not have the consecutive time to push his print all the way through at one session.

### *What Is Needed*

The McGraw Colorgraph Company sells everything necessary for its version of carbro except the chemicals and such mechanical gear as a print wringer, trays, etc. It will supply the pigment paper, Eastman Kodabromide 1013 printing paper, soluble and final support paper, and the several sets of plastics needed.

You should start with a dozen each of the Kodabromide, the pigment colors (four of each color), and the soluble and final support papers, three each of the grained plastic supports and the registration plastics, and one combining blanket (if you use a wringer for "combining"). The smallest bromide paper sold by McGraw is 8 by 10, and the support papers and plastics are somewhat larger than the bromides. Thus for each size of bromide, there is a desirable size of support papers and plastics.

The following chemicals are required in addition to those necessary to make up ordinary developing, stop bath, and fixing solutions:

- Concentrated hydrochloric acid
- Magnesium sulfate crystals (Epsom salts)
- Isopropyl alcohol, 99 per cent
- Potassium ferricyanide
- Ammonium bichromate
- Chromic acid flakes
- Formaldehyde
- Distilled water

### *Making the Bromides*

The Kodabromide paper recommended does not have any protective overcoating. For this reason it must be handled more carefully than ordinary printing paper so that abrasion marks are



avoided. The bromide prints are developed in Kodak D-11 developer diluted 1 to 2 for 1½ to 3 minutes at 70°F, the longer developing times giving greater contrast.

As usual, it is the high-light areas that control the exposure to the separation negatives. Make the first test on a critical portion of the cyan-printer negative (red-filter negative). If the subject is a portrait, there should be just enough exposure for the cyan printer to show modeling of the features. If the subject is not a portrait but there is some white object in the scene, print this so that it has a faint gray tone compared to the white margin of the print. Without such a white object, use your best judgment.

It is here that the Stripmeter mentioned before is a help. By its means a portion of the negative can be selected and successive exposures made on a single strip of bromide paper, some obviously too great and some too short. The Stripmeter makes it possible to make five different exposures on a single test piece. These are all developed together, exactly alike, and can be examined with the certainty that the only variable has been the exposure.

If the negatives are well balanced, then equal exposures can be given the three bromides to the three separation negatives. The final color print may be too dark or too light, but the color balance will be correct. If the cyan printer has been correctly exposed and if the photographer has a densitometer, the identical areas in the three negatives can be measured and the exposures of the magenta and yellow printers can be determined from the densitometer readings as described earlier in this book. If no densitometer is available, then the photographer must make a series of tests to each negative, using the same areas and being sure to develop all tests exactly alike. When the same tone of gray is attained in each print as the bromide paper is exposed to a white or gray portion of the subject, then the exposure times required to produce these identical grays will be the exposures to be used when the entire negative is exposed to the bromide paper.

A good safe edge at least  $\frac{1}{2}$  inch wide is desirable. Develop only one set of bromides (three) through a given developer solution, then throw away the developer. Do not use it again.

Time the prints in the developer exactly and maintain the temperature exactly. Put the prints, one at a time, through the developer, then into the stop bath, and then into the fixer where they can remain 5 minutes if the bath is fresh. If it is not fresh, do not use it. Wash the prints 20 minutes in running water. Use no acid in the fixer.

The bromides can be used at once, wet, or they can be dried by squeegeeing the water from the backs and fronts and placing them face up on blotters or cheesecloth stretchers. They will curl up, but the curl will be taken out when they are soaked in water in preparation for the following steps.

### *Stripping the Pigment*

Use a sheet of stripping pigment paper  $\frac{1}{2}$  to 1 inch larger all around than the bromide, placing the pigment and one of the grained plastics in the weak hydrochloric-acid bath. Place the plastic in the solution first, grained surface up. Then place the pigment face up in the bath, rub over it gently with the fingers to remove any air bells, and then turn it face down. At 45 seconds after the solution first touched the gelatin, lift the two materials from the solution, allow them to drain briefly, and at 50 seconds run the pair of sheets through a print wringer or squeegee them together with a roller squeegee, using quite a bit of pressure to remove all air. The paper should not be allowed to overlap the edges of the plastic. Wipe off the back of the pigment paper and the plastic with a towel to remove excess moisture.

At the end of 3 minutes, strip off the pigment support leaving the pigment attached to the plastic support. Allow the three transferred pigments to dry for at least 3 hours. This is a good place to end the day's operations. As a matter of fact, the pigments

may be allowed to stand for several days after they have been transferred to the plastic support.

### *Forming the Pigment Images*

The next step is to bring the pigments in contact with the bromide prints. This involves sensitizing the pigments according to an exact time schedule, each pigment getting the same treatment as the others, each bromide being soaked in water for the same time as the other bromides. Use new sensitizer for each pigment.

Always use the same amount of solution. This means that if the proportions are changed, the bath should be brought up to the final amount, say 500 or 1,000 cc, by adding water. For normal prints, use

- A solution—200 cc
- B solution—110 cc
- C solution—20 cc
- Water to make 1,000 cc

If B solution is decreased to 95 or 100 cc, the picture will be darker, since more of the pigment will transfer; if B solution is increased to 120 to 130 cc per liter, the picture will be lighter. Contrast can be increased by increasing the amount of A solution. The maximum contrast will be achieved if the normal amounts of the three solutions are used with 750 cc of water instead of the usual 1,000 cc. Do not combine the three solutions until 15 or 20 seconds before they are to be used.

Place the A solution in enough water (28 ounces if the full amount is to be 1,000 cc) to bring the volume of the combined bath to the required amount, say a total of 1,000 cc for a 16 by 20 tray or 500 cc (16 ounces) for an 11 by 14 tray. Put this A solution in the tray; measure out the required amounts of solutions B and C in graduates and have them handy.

Now place the cyan pigment in the presoak bath for 1 minute, rubbing the surface gently to insure uniform wetting. Stand the

plastic on edge to dry for 2 minutes. While the pigment is draining, place the cyan printer (red-filter print) in distilled water face down. Although distilled water is recommended, the author has had no trouble with tap water at this step.

As the 2-minute draining period is ending, say 15 to 20 seconds before the end, combine the B and C solutions with the A solution plus water in the tray. At the end of the 2-minute period, insert the cyan pigment into the tray, gelatin up, and rub the surface gently with the hand or with a tuft of cotton to remove air bells. The temperature of the solution should be between 60 and 70°F and should be the same for all three pigments. After 2 minutes 45 seconds, the plastic bearing the pigment should be lifted out of the sensitizer in which it was inserted, and at exactly 3 minutes it should be brought in contact with the face of the cyan printer bromide. This process is touchy and the exact details depend on whether a wringer or a squeegee is used. Details on the wringer method will be described later.

### SQUEEGEE METHOD

Although the wringer is highly recommended, the author has made perfectly good carbros by the hand-squeegee method. The only critical part is combining the bromide with the sensitized pigment. The method is as follows. At the end of about 2 minutes and 30 seconds lift the pigment from its bath and, after draining for a few seconds, place it on a sheet of plate glass with one edge flush with an edge of the glass. Over this place a sheet of thin celluloid or wash-off film—anything that will prevent the bromide from coming in contact with the pigment until this step is desired. On top of the celluloid place the bromide, face down, with one edge flush with the edge of the glass. Make sure that the celluloid is not flush with the glass edge—in other words, that there is a safe edge of about 1 inch.

Now position a paper clamp to hold the bromide tightly to the pigment-bearing plastic and the glass plate. Lift the bromide with

the left hand, remove the celluloid insulator, and using a heavy print roller with the right hand roll the bromide into tight contact with the pigment.

All this operation will require about 30 seconds once it has been rehearsed a bit. It is important that each color gets exactly the same treatment—i.e., the same time in the sensitizer, the same time from immersion to actual contact with the bromide.

It will take about 5 minutes for the bleaching process to take place. Since it can be watched through the transparent plastic, you can tell when the action is complete. There is no harm in leaving the pigment and bromide in contact longer, however. Thus the next logical step is to combine the other two bromides with their corresponding pigments.

### *Transfer of Pigment to Registration Plastic*

The next step is to remove the bromides by simply peeling them from the surface of the pigment and to transfer the pigment, now bearing an image in hardened pigmented gelatin, to the registration plastic. This, too, can best be done by employing a print wringer; but it can be accomplished by squeegee. Swab the registration plastic with a damp cloth, rinse it, and squeegee it dry. Immerse the plastic bearing the cyan image in the mounting solution for 1 minute, place it face down on the registration plastic, and either run it through the wringer or squeegee it down.

Now the bleached bromide can be placed in a tray of water to wash thoroughly, whereupon it can be redeveloped and another print made. For top-notch prints, however, no carbonyl worker will use a set of bromides more than once. The bromides need not be placed in a fixing bath but should be washed and then dried.

After the cyan pigment and the registration plastic have been in contact for 5 minutes, place the combination in a tray of water at 110°F. The gelatin will begin to melt and ooze out around the edge of the pigmented plastic and in about 1 minute the plastic can be removed gently to avoid scraping the pigment, which has

now been transferred to the registration plastic. Swish the warm water over the pigment for a few minutes and then transfer to a tray of clean hot water 110°F. When one corner of the plastic is held and moved rapidly through the water in a motion parallel with the bottom of the tray, the loose (unhardened) pigment will float away leaving, finally, the complete cyan image. Douse the image with cool water to set the image and set it aside to dry.

Repeat with the other two images. Do not use heat to aid drying. Air from a fan may be used if the air is free of dust. Wipe the backs of the plastic thoroughly dry.

### *Soluble Support*

The next step is to combine all three images on a sheet of soluble support paper. Transfer the cyan first. Soak a sheet of support paper, 1 inch larger all around than the picture, for 3 minutes in cool water with the plastic bearing the cyan image beneath it in the water. Withdraw the two materials, face to face, and squeegee them together on top of a sheet of plate glass. Wipe the front and back perfectly dry, set aside to dry in front of a fan. After a few minutes some heat may be applied to hasten drying. Do not, however, apply heat without the fan to keep the air in motion. When the support paper is thoroughly dry, it will peel away from the plastic of its own accord. It has on it the cyan image.

Now the magenta image is to be transferred to the soluble support, on top of the cyan image. Immerse the magenta-bearing plastic and the cyan-bearing support in cool water and after 5 minutes lift them out together. Bring into partial register by viewing through the plastic. Placing the sandwich on the plate glass, squeegee lightly to remove most of the water and pick it up with the plastic facing up. Moving the plastic with respect to the soluble support and its cyan image until the best possible register is attained, squeegee the combination lightly together and allow it to set for a few minutes, then squeegee more tightly together. Use cool air from a fan for 5 minutes and then warm air until the

soluble support again peels off. Now the support paper contains both the cyan and the magenta images. The yellow image is now transferred and when the soluble support finally peels off, all three images are on it. The final step is to transfer this image to its final support.

### *Final Transfer*

The picture is now in this condition: the cyan is next to the soluble support, the magenta is on top of the cyan, and finally lies the yellow image. The picture is reversed right to left. If one could see through the yellow layer and if the bromide prints had been reversed when printed, right to left, there would be no need to make a final transfer and reversal. But this is not the case. One more transfer must be made.

If desired, the edges of the soluble support may be trimmed flush with the picture. Now soak a piece of final support paper, larger than the picture area (several inches larger if a nice white margin is desired on the final color print), in hot water (120°F) for 3 to 5 minutes, place on top of a glass plate, gelatin-side up, and, if desired, squeegee. As soon as it feels sticky, place it and the soluble paper in cool water, face to face for a minute or two, at least until the soluble paper flattens out. Now withdraw the two sheets, place them on the glass plate, and thoroughly squeegee them together. All water must be excluded. Wipe the front and back and lay aside for a few minutes on a clean blotter.

When it is certain that the soluble and the final supports are thoroughly stuck together, insert them in hot water (120°F) until the soluble begins to loosen. It can be stripped off and thrown away. The picture is now on its final support.

Place the picture on a sheet of plastic and, holding it at a slant, dash it (carefully, since the image is soft and easily damaged) with warm water to remove the last vestige of gelatin. This operation must be thorough to prevent streaks in the final picture from the

gelatin. Pull the print through cool water, hang it up to drain for a minute or two. It will begin to shrink very soon and at this point it should be placed on a flat surface, such as a piece of masonite or beaverboard or glass, and taped down all around the edges with heavy gummed tape. Several hours will be required to dry the print completely. During this period the pigment image is soft and easily damaged. If the workroom is not too dry, the print may be hung up with two clothespins and allowed to dry in this way. Any curl that remains will be taken out when the print is dry mounted.

### Spotting

While the print is taped to its solid support, if it is dried in this manner, it can be spotted. It is a rare print that does not have some flaws, such as places where one of the three images did not transfer properly or minor (or major) scratches that need filling up with one of the three colors.

Places where the images may be much too heavy can be etched out when the individual color images are placed on the soluble support. These dark spots may be caused by pinholes in the negatives or by gobs of gelatin not washed away in the hot-water step. When the cyan image, the first to go on the soluble support, is dry, it can be etched; then when the magenta and yellow are transferred to the soluble support, they, too, can be cleaned up.

This technique will take care of dark spots. But points where the colors are lighter than required or where one color is missing can be repaired in the final print by use of retouching colors. A small sharp-pointed spotting brush, kept as dry as possible, can be employed to fill up small holes. You must learn which color is required by experience. If the spot is greenish, magenta is missing; if it is purple, yellow is lacking; if it is brown, the spot needs cyan. You must also learn by experience how strong to use the spotting colors and when to dilute them or to blend two or three colors.



## COLORGRAPH FORMULAS

Numerous one- and two-solution sensitizing solutions have been published, but basically all use the same materials. Older methods required that the pigment tissue be placed in the A solution first for a specified time, drained, and then placed in the B solution for another period. Contrast was controlled to some extent by the time of immersion. Without an exact routine, carefully worked out and practiced, it was difficult for the operator to keep the contrast of the three images the same. The single-solution method has helped in this difficulty. It is still necessary, however, to time the period of immersion in the sensitizing bath carefully and to have everything on an exact schedule between immersion of the pigment and combination with the bromide. One can soon perfect his technique so this is possible.

### BROMIDE PAPER DEVELOPER—KODAK D-11

Distilled water (125°F)	16 ounces	500 cc
Metol or Elon	15 grains	1.0 grams
Sodium sulfite	2½ ounces	75.0 grams
Hydroquinone	130 grains	9.0 grams
Sodium carbonate, monohydrated	1 ounce	30.0 grams
Potassium bromide	73 grains	5.0 grams
Cold distilled water to make	32 ounces	1,000 cc

Use 1 part developer; 2 parts water.

Develop 1½ to 3 minutes at 70°F.

### SOFT DEVELOPER FOR CONTRASTY NEGATIVES

Distilled water (125°F)	16 ounces	500 cc
Metol or Elon	180 grains	13.0 grams
Sodium sulfite	1 oz. 80 gr.	38.0 grams
Sodium carbonate, monohydrated	1½ oz. 70 gr.	53.0 grams
Potassium bromide	30 grains	2.1 grams
Cold distilled water to make	32 ounces	1,000 cc

Use 1 part developer, 2 parts water.

Develop 1½ to 2 minutes at 70°F.

## NONHARDENING FIXING BATH—KODAK F-24

Water (125°F)	16 ounces	500 cc
Hypo	8 ounces	240.0 grams
Sodium sulfite	145 grains	10.0 grams
Sodium bisulfite	365 grains	25.0 grams
Cold water to make	32 ounces	1,000 cc

## STOCK STRIPPING SOLUTION

Water	19 parts
Concentrated hydrochloric acid	1 part

Always pour acid into water, not vice versa.

To use, take 1 part stock solution and 9 parts water.

Use at 72°F.

## PRESOAK SOLUTION

Water	32 ounces	1,000 cc
Epsom salts	2¼ oz. 32 gr.	80 grams
Isopropyl alcohol 99 per cent	1 ounce	30 cc

Alcohol preserves this solution against mold. The presoak solution can be used over and over again.

## BLEACH SENSITIZER

*Solution A*

Potassium ferricyanide	1½ oz. 73 gr.	50.0 grams
Potassium bromide	1½ oz. 73 gr.	50.0 grams
Ammonium bichromate	½ ounce	15.0 grams
Distilled water to make	32 ounces	1,000 cc

*Solution B*

Chromic acid flakes	146 grains	10.0 grams
Distilled water to make	32 ounces	1,000 cc

*Solution C*

Formaldehyde (U.S.P. 37 per cent)	1½ fl. oz.	50.0 cc
Distilled water to make	32 ounces	1,000 cc

See text for quantities to be used.

## MOUNTING SOLUTION

Water	24 ounces	740 cc
Epsom salts	2¾ oz. 32 gr.	80 grams
Isopropyl alcohol	8 ounces	250 cc

Prepare ahead of actual use so that it will cool.

Use for four or five sets of pigments only. Keep stoppered to prevent loss of alcohol; strain out foreign matter.

## SHORT STOPS

Water	1.0 liter	Water	32 ounces
Glacial acetic acid	13.0 cc	Acetic acid 28 per cent	1½ ounces

## USE OF COMBINER

Professionals have settled upon the name "combiner" for a print-wringer arrangement for combining the pigment paper after sensitization with the bromides. With the wringer goes a device known as a "blanket." This is a hinged set of two celluloids or plastics. The wringer should have rolls 2 inches longer than the widest blanket to be made and can be operated by hand, although for steady professional use an electric motor is desirable. In professional workrooms the wringer is firmly attached to a sink or to a table with means for draining the liquids to the sink. A feeding platform is placed at the front at a height of the contact between the rollers and a delivery platform is built at the rear and at the same height.

The blankets are made of plastic 2 inches wider and longer than the largest sheet of pigment to be run through. The blanket plastics are preferably about  $\frac{25}{1000}$  inch thick and should be impervious to moisture without tendency to warp or buckle. At one end they are attached together with strong waterproof adhesive. At the opposite end holes are punched through both sheets about midway along the edge.

With conventional prewar pigment sheets or tissues, the combiner is employed to bring into contact the sensitized pigment and

the bromide. With Colorgraph pigments, the combiner is also employed to strip the pigment and to remount it on the plastic sheet, thus reversing the pigment so that what was formerly the surface in contact with air is now next to the plastic, leaving the protected surface available for forming the image.

The blanket and wringer are used to combine the pigment and the bromide as follows. The blanket is wet and placed on the feeding platform, its hinged end started through the rollers. Then the top half is curved back over the wringer and held there by a hook inserted into the hole punched in the outer end of the blanket. At the required time, the bromide is removed from its tray of water and placed on the top blanket. It is so positioned that when the pigment is placed on the lower half of the blanket, the pigment and the bromide will come into the proper position with respect to each other. During the critical procedure of running the blanket through the wringer, the bromide-bearing celluloid or plastic is held with the left hand so that the bromide does not touch the pigment until it is about to go between the rolls. The pressure of the rollers must be even, end to end.

For prints up to 8 by 10 a less expensive combining method can be used as described in a Devin-McGraw booklet published in 1940. One end of a thin ( $\frac{1}{100}$ -inch) celluloid is fastened to one end of a board with thumbtacks or to a glass plate with adhesive. The board or glass plate should be 3 to 4 inches larger all around than the celluloid. The other end of the celluloid is attached to a similar sheet with adhesive. When ready to combine, the blanket is opened like a book, the bromide is placed on the free celluloid, and the pigment is placed on the end of the blanket tacked down to the board. With a roller squeegee the two ends of the blanket are rolled into intimate contact. Care is taken not to drop the bromide on the pigment before the roller begins to apply pressure. After combining, the upper part of the blanket is peeled off slowly. The blanket is rinsed to remove any of the pressed-out liquids.

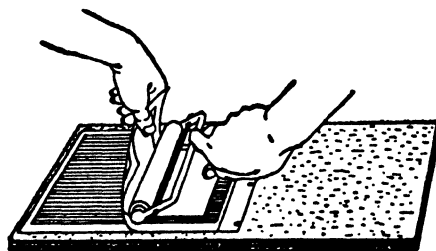
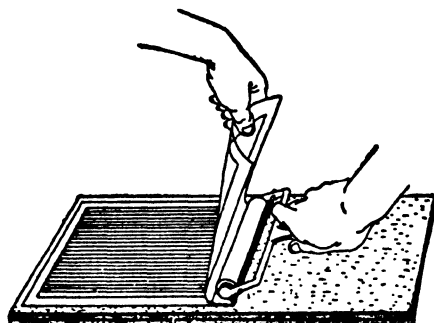
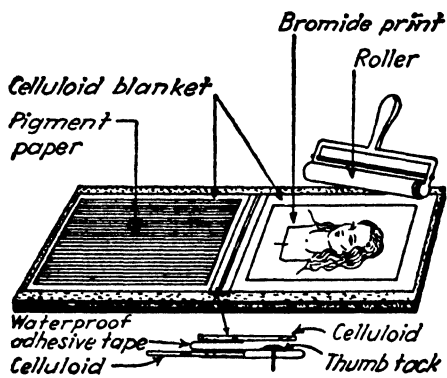

Simple, homemade "blanket" for use in the carbonyl pigment process.

## NOTES ON CARBRO

**CHEMICALS.** Use only chemicals you can trust—i.e., those made by companies whose names are well known. Take no chances on impure chemicals. Eliminate this worry completely. Weigh them out carefully. The ammonium bichromate should be "A.R.," analytical reagent, grade. The chromic acid should be U.S.P. XI. Use distilled water where stated in the formulas. All other solutions can be made up of tap water.

A water filter placed over the tap is a good idea since it gives a cleaner solution, removes any small bits of rust from the pipes or other dirt that can scratch the delicate pigment-gelatin images. The best is probably made up of diatomaceous earth. The least you can do is to tie over the tap a cloth to remove gross impurities.

Tracing-cloth on which draftsmen make their inked drawings makes good filter cloth provided all of the sizing and whatever else is in the material is thoroughly washed out in hot water. The weave is fine and a filter made of this material will remove practically all particles of dirt, gelatin, or other material that may find its way into solutions.

**BROMIDES.** The exposure of the bromides is most important since the entire picture depends on the silver image in these black-and-white prints. If you think that the correct exposure is, say, 22 seconds, tests should be made from about 15 to 28 or 30 seconds, each test differing from the previous one by about 3 seconds. Then the final selection of 22 seconds as the proper exposure has plenty of basis.

If Defender bromide for carbro is used, it should be developed in 55-D diluted with 2 parts of water to 1 of stock solution. Additional contrast will be secured if the dilution is reduced to 1 to 1 or if the developer is used straight. Still greater contrast is possible by using 14 grams of potassium bromide instead of the 8.5 grams recommended.

After the gelatin images have been developed on the celluloids or plastics, be sure to wipe the backs thoroughly. A drop of water will cause the gelatin image to dry more slowly and will produce a water spot on the finished print.

**REFRIGERATION.** In the past, carbro workers have found it necessary to operate in air-conditioned rooms where the temperature was kept low. Gelatin in its semimelted state has only limited tensile strength, which decreases rapidly with increase in temperature. Ice baths in which the several trays could be placed have saved many a picture in hot weather. More recent pigments, however, are less troubled with frilling, and if the workroom can be maintained at 70°F, little trouble should be experienced. In hot weather tissues and bromides can be soaked in ice water; bleach bath can be made with ice water; and the combined bromides and pigments can be placed in an icebox or refrigerator.

Even though you start your carbro print by making an ordinary black-and-white print—a process at which you may feel quite expert—you should remember that only perfect bromides can make perfect color prints. You should not depend on varying the time of development, as you do in monochrome printing, to get good blacks. You should develop each print exactly like the other two unless you know exactly what you are doing. Short development will produce a less contrasty print. The paper characteristic, density plotted against exposure, will have a shorter linear region; it will distort color values more.

**VOLTAGE CONTROL.** You should also realize that the voltage on your printing lamp is important; not only will low voltage produce low illumination output and cause longer exposures, but the color characteristic of the lamp will change, becoming more yellow at lower voltages. Although you may give the correct exposures, measured in seconds, to each of your three bromides, if the voltage is 110 for one of them and 115 for the other two, you will be in trouble. As much as 30 per cent more exposure, in seconds, may be

required at 110 as is necessary at 115 to produce the same result. If the house voltage is likely to vary, a voltmeter and some means of controlling lamp voltage, such as a Variac, are indicated or one of the several forms of automatic voltage controls now available.

### A SCHEDULE FOR PIGMENT PRINTING

The author has found that the new McGraw Colorgraph material works very satisfactorily. Like all pigment prints, carbros are not made at high speed. Furthermore, to make more than one print of high quality requires that you make as many sets of bromide prints as are required—one set for each color print. The facility with which duplicate prints are made by dye transfer is simply impossible by pigment printing. On the other hand, and highly in favor of carbros, there is the fact that if you can make superb black-and-white enlargements or contact prints, you can make superb color prints—and there is no getting away from the fact that the pigment images are beautiful. The final image is built up layer by layer so that there is definite thickness to the color, a relief that lends depth and beauty.

In light of the author's experience, about an hour is required to make the necessary test bromide prints to determine correct exposures and to make the final bromides. This is a good place to stop. If time remains before it is necessary to sign off, you can strip the pigmented gelatin from the paper base and remount it on the grained plastics. If all goes well, this will require about  $\frac{1}{2}$  hour. Thus in 2 hours you can make your bromides, get the pigments ready for the succeeding operations, and clean up the workroom. The pigments should now dry and this will take several hours. The author has found that the bromides and the pigment-stripping operations can take place one evening; the final steps can occur on the following day or several days later if desirable. The manufacturer states that the pigments should be used within three or four days after the stripping has taken place.



The next day's operations go something like this—somewhat as Samuel Pepys (or F.P.A.) would describe them.

Arose at 6 A.M., made coffee and toast.

At 6:30 got things under way in the darkroom.

By 6:55 the cyan and magenta bromides had been combined with the sensitized pigments.

At 7:04 all three images had been combined, the bromides had been removed from the plastics bearing pigment and had been placed in cold water to wash.

At 7:15 the cyan went into hot water.

At 7:30 all three images had been developed in hot water and the image-bearing plastics were hanging up to dry.

At 7:45 the workroom was cleaned up; all trays and the wringer were washed, the lights turned out.

By 8 A.M. had shaved, washed, and properly dressed; took the train to town and the day's work.

If the schedule above is carried out on Saturday (or Sunday), the images will be dry by noon or earlier if some heat is applied. The cyan can be transferred to the temporary support in about 10 minutes; then it will take about an hour to dry and peel off—without the aid of additional heat. Hanging the sandwich of plastic and the temporary support in a sunshiny window will hasten the drying, but the author does not like to hasten matters at this stage. Another hour will see the magenta properly registered, dried, and the yellow image on top of the cyan and magenta. At the end of the third hour, you are ready to transfer the image from its temporary support to the final sheet of paper. At this point the white sheet carrying its three-color image in pigmented gelatin is mounted on a stiff sheet of masonite or something similar or on a sheet of glass. Several hours will be required for the print to dry.

Thus it will be seen that quite a time is required to process a print completely. There are several periods, however, in which you can do other chores, weed the garden, or read a book. You are not busy all this time with the carbro—in fact, most of the time the

print is off by itself drying in readiness for the next step. The longest period in which you must be on the job is that following the making of the bromides. Then you must combine the bromides with the sensitized plastics and must develop the images in hot water. Once they are on the plastics, properly washed down and dried, you can leave them for several days. Furthermore, as soon as one of the images has been transferred to the temporary support, you can go away and pick up the next step several days later.

### TECHNICAL NOTES

The author has not found that the time of contact between the bromides and the sensitized pigment is critical. He has not found it necessary to soak the bromides in distilled water prior to combining. A half-dozen washes of 5 minutes each in cool water are all his prints get. He finds it possible to sensitize all three pigments in the same batch of A, B, C solution by working fast. He places 6½ ounces of A, 3½ ounces of B, and 20 cc of C in individual graduates. The A solution is dumped into a 32-ounce graduate, which is filled to the 28-ounce mark with tap water. When the cyan pigment is ready to be sensitized, the clock is started at zero, the cyan is soaked in a presoak for 1 minute and hung up by a clothespin, the B and C solutions are dumped into the graduate with the water, and the A solution and this mixture is poured into the tray. At the end of the second minute the cyan is placed in the sensitizer, where it stays for 3 minutes, and the cyan bromide is placed on the wringer. At 4½ minutes the pigment is removed from the sensitizer and placed on the blanket; at 5 minutes the blanket is rolled through the wringer.

At 6 minutes the magenta is started in the presoak, and the routine carried out for the cyan is repeated. Thus in about 20 minutes all three images are combined, the sensitizer is put down the drain, the trays are cleaned, the mounting solution is placed in the tray, and the bromides are removed from the pigments and

placed in cold water, later to be redeveloped. In about 15 minutes the three pigments can be combined with the plastics ("celluloids" in the older carbro process), where they remain in contact until the hot-water treatment begins.

After the cyan is transferred to the temporary support, it is a good plan to compare it visually with the bromide (redeveloped) from which it came. To do this, place them side by side in good light and look at them through a red filter. As seen through this filter, the cyan image looks like a black-and-white print and can be compared directly with the cyan bromide. This test is a good one to determine if the process is going according to Hoyle.

With the McGraw Colorgraph materials there is no waxing of celluloids, no washing the wax off the print by means of benzine; there is no dullness to the high lights, and there is no frilling or mottling. With any carbro process, use fresh pigment papers only.

High-light loss and mottle have long been troubles to which carbro has been prone. Use of ordinary bromide paper is one source of trouble. It has an overcoating to protect the surface, which, when used for carbro, prevents the bleach solution from getting at the silver image. Since carbro bromide is obtainable, there is no need for getting into this kind of trouble.

It seems to the author that modern postwar materials are much easier to work with than those that existed some years ago. He has had none of the conventional troubles and, except for his memory of previous difficulties or the books he has read, he would not know that such ailments existed.

### *Duplicate Prints*

Although professionals do not like to use bromides for more than one print, it is a fact that if they are thoroughly washed—quite a bit after the yellowish stain is removed—they can be redeveloped and reemployed. If the picture is full of high-light detail, as in a high-keyed portrait, a new set of bromides had better be made.

### Nonspoiling Bleach

One of the most critical parts of the pigment printing process is the timing of the pigment papers in the sensitizer or bleach. This solution deteriorates rapidly, and for good color balance each pigment should remain in the bleach for the same length of time as the other pigments.

In *American Photography*, August, 1947, Ernest M. Symmes describes a formula that does not deteriorate rapidly—in fact, it can be used repeatedly. The pigments are immersed in it for 3 minutes, then squeegeed to the wet bromides, and allowed to remain for 5 minutes. Then the pigments are stripped from the bromides and mounted on the celluloids in the conventional manner. Mr. Symmes's formula follows.

Potassium bichromate	170 grains	11 grams
Potassium ferricyanide	115 grains	7.5 grams
Potassium bromide	115 grains	7.5 grams
Potassium bisulphate	10 grains	0.625 grams
Chrome alum	25 grains	1.6 grams
Water	32 ounces	1,000 cc

### CARBRO VARIATIONS

Anyone who likes to experiment can indulge his hobby in several variations of pigment (carbro) printing. The starting point is a set of silver images—separations. These images ordinarily are made on bromide paper in the same manner (only with more care) that a monochrome black-and-white print is made. But the images need not be made on bromide paper. They can be made on stripping film; they can be made on wash-off film.

Stripping film is employed in the graphic arts as a means of assembling parts of several pictures into one composite. The Chromatone process of making color prints, available before the war from Defender, used stripping film that had an emulsion like Velour Black and was exposed and developed in the same way.

Suppose, as an experiment, that the three separation negatives are exposed to stripping film. After development and fixation in a nonhardening hypo bath, you have three silver separation images. Now sensitize three carbonyl pigment papers, squeegee them to the stripping films, and, watching what goes on through the back of the stripping film, note that the image seems to disappear. When this bleaching process has gone to completion, evidenced by complete lack of black silver image, place the sandwich in warm water and swish it around.

Soon the pigment will begin to melt; the paper on which the pigment originally was attached can be pulled away and discarded. Continue to wash the unhardened pigment away, change the water once or twice, and when no more color will dissolve, place the stripping film, now colored, in cold water and repeat the same performance with the other two images, remembering to use the cyan pigment with the red-filter positive, the magenta pigment with the green-filter image, and the yellow pigment with the blue-filter positive. Remember, too, that the stripping films are extremely thin and that they will tear very easily.

Now you have three separation positives in color. Squeegee one to a sheet of gelatinized support paper and after it is thoroughly adherent, squeegee one of the remaining pigmented films in register, and after a slight wait to permit the two to become well stuck to each other, squeegee down the third film on top of the other two. The next step is to anchor the color print to a glass plate or sheet of pressboard by using strong tape around the edges. When thoroughly dry, the print can be cut loose from the glass plate, its edges trimmed square—and you have a color print. This is only one of several possible variations.

Ernest M. Symmes, writing in *American Photography*, states that the McGraw pigment tissues will stand higher temperatures than the Autotype pigments, up to 80°F. He also states that he has employed, with the McGraw pigment papers, heavy sheets of cellu-

lose acetate, safety-base film from old sheet film, and the backs of wash-off relief film in place of professional celluloids. He removes gelatin from old film by means of Clorox. The newer matrix film for use with Kodak Dye Transfer should be useful as a substitute for celluloids since it is much heavier than the other wash-off film.

Mr. Symmes has also found that if he first transfers the yellow image from the celluloid to a final support paper followed by the magenta and then the cyan images, he does not need to reverse the entire image by still another (ordinarily called the final) transfer. The chief difficulty with this single-transfer method is that of registering the magenta image on top of the yellow image, since there is not much contrast between them.

In another substitution, he employed glossy Kodabromide F No. 2 paper for the bromide specially made for carbro. He had no difficulty. When he tried Brovira No. 2 velvet and Kodabromide No. 3 matte, however, the experiment was a failure.

### CARBRO AND WASH-OFF COMBINED

There is undeniably something exciting about a carbro—something that other forms of color prints do not have. This something is probably from the fact that the images have distinct thickness; after all, they are relief images in color. This relief effect lends a third dimensional effect, which is quite apparent.

Since the "depth" of a color picture comes largely from the cyan image, there is no reason why you cannot use pigment for the cyan image and dyes for the magenta and yellow images. You go about this marriage between pigment and dye printing in the following manner. Make the magenta and yellow images on wash-off film in the customary manner, dyeing the matrices as usual. Make a pigment cyan image by means of a bromide print (or a wash-off print) in the conventional fashion. Transfer the cyan image to a sheet of carbro support paper, immediately mordanting the paper by use of the wash-off mordant technique, and transfer the magenta

and cyan images. Don't forget that the cyan image will be reversed right and left compared with the dye images, and so the cyan image must be reversed at the beginning. If you use films for negatives, this reversal will not cause any trouble, since the thickness of the film will not cause out-of-register troubles when the negative is reversed in the enlarger. If, however, plates are employed for making separations, then you have to be a bit more careful. Stop down the enlarger lens to the limit and hope that the two images on the easel, one with the negative right side up and the other with the wrong side up, will be of the same size.

If there is any point to it, you can transfer the magenta and yellow images to the mordanted sheet of support paper first and then before the paper dries out transfer the cyan pigment image to it. It seems, however, that the pigment will stick to the support paper better if it is put down first.

For final support paper in the stripping-film method, you may retain one of the backing papers on which the stripping film was originally mounted. It will have enough gelatin—or whatever the adhesive is that holds the film to the paper when manufactured—remaining to hold the final sandwich of three colored films.

### CALIBRATE THE ENLARGER

If you standardize your work, always blowing up your negatives to a given size of enlargement (who is willing to do this?), always using the same lamp voltage (every one should do this), always employing the same lens opening or the same exposure time (whichever is easier as a means of varying the exposure), then you will eliminate many of the variables that can sneak in and spoil a picture. No photographer, however, is likely to be so reasonable in his desires or so methodical in his work.

If varying degrees of enlargement are to be used, then the Kodak Print-exposure Computer will be very valuable. Even if you use this handy device, you should calibrate your enlarger.

The exposure required to produce a certain result when the enlarger is set for a given magnification increases if the magnification is increased. How much should it be increased? This should be known exactly. As a matter of fact, it varies as this expression:

$$E_2 = \frac{(M_2 + 1)^2}{(M_1 + 1)^2} \times E_1$$

. . . where  $E_2$  corresponds to  $M_2$ , the greater magnification, and  $E_1$  and  $M_1$  correspond to the lower magnification. It is on this equation that the Kodak Print-exposure Computer is designed. While it may look formidable, it is very easy to use, as is shown below.

The first thing to do is to attach to some part of the enlarger a pointer that moves as the degree of magnification changes. This pointer should be aimed at a meter stick or yardstick immovably fixed to the enlarger. For example, when the bellows is changed to allow the lens to approach the easel, as when the magnification is decreased, the pointer may indicate the height of the lens above the easel or it may merely point to some arbitrary number.

Now place a sharp and not-too-dense negative in the enlarger and focus it on the easel at the greatest magnification ever to be used. Record the number on the meter stick or yardstick to which the indicator points, measure the length, say, of the enlarged image, and from the same dimension of the negative, calculate the degree of magnification,  $M$ . Change the position of the lens, determine the new value of  $M$ , and find the new position of the pointer corresponding to it. Finally, make up a table that states that the enlargement is, perhaps, two times when the pointer is aimed at position B, it is three times when the pointer is at some other position, and so on. Now, in the darkroom, when the image of a color print has been blown up to the desired degree of enlargement, note the pointer and, from your previously calculated table, calculate the exposure factor (or use the Kodak Print-exposure Computer).



In starting your work with color printing, it is wise to choose some fixed degree of enlargement, say two or three times, for making the standardizing exposures on the bromides (for carbro or

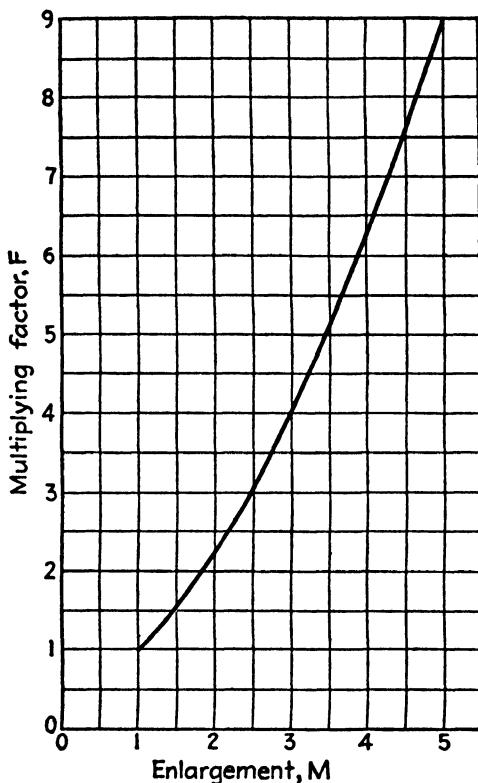

Curve showing how printing exposure is related to the degree of enlargement. If an exposure of 20 seconds is required at an enlargement of 3 times, for which the factor is 4, it will be  $20 \times 6.25 \div 4$  at an enlargement of 4 times.

pigment printing) or on the film used for dye transfer or wash-off. Whatever the degree of enlargement, mark it down in your notebook or put it in big letters near the enlarger. Then when some other magnification is employed, the necessary calculation will make

unnecessary preliminary tests to determine the required exposure.

If the formula given above for the exposure factor  $F$  is calculated with unity magnification ( $M_1 = 1$ , or same size picture as the negative) as the basis, the data will look like this, since  $M_1 = 1$  and  $(M_1 + 1)^2 = 4$ :

$M_1$	$M_1 + 1$	$(M_1 + 1)^2$	$F$
1	2	4	1
2	3	9	2.25
3	4	16	4
4	5	25	6.25
5	6	36	9

But, since it may be impossible to adjust the enlarger to zero magnification, start with it adjusted so that a negative will be blown up three times. Now the table will look like this, since  $M_1 = 3$ ,  $(M_1 + 1)^2 = 16$ :

$M_1$	$M_1 + 1$	$(M_1 + 1)^2$	$F$
1	2	4	0.25
2	3	9	0.56
3	4	16	1.0
4	5	25	1.56
5	6	36	2.25

Note how this formula and the tables work. Suppose that the preliminary standardization has been carried out at a three-times enlargement, that 20 seconds' exposure at  $f/8$ , 110 volts on the enlarger lamp through a density of 1.4 produces the desired result. Now a set of negatives is to be printed and blown up four times through a maximum high-light density of 1.6. What should be the exposure?

First assume that the degree of enlargement is to remain at three and that all other conditions, except the density to be printed, are to remain the same. How much should the exposure be increased?

The difference between densities of 1.6 and 1.4 is 0.20. Looking at the table on page 295, note that when the density is greater by a difference of 0.2, the increased exposure is 60 per cent—or the standard exposure must be multiplied by 1.6. Note that it makes no difference whatever from what standard density you start—it is the difference between this density and the density through which the actual exposure must be made that counts. Thus, if the test density is 1.0 and the negative density to be printed is actually 1.2, the exposure multiplying factor is 1.6. Similarly, in this particular case, where the standard exposure is 20 seconds through a density of 1.4, to print through a density of 1.6 requires that the 20-second exposure be increased by 60 per cent or multiplied by 1.6. Therefore, if the enlargement is to remain at three times, the actual exposure will be 20 times 1.6, or 32 seconds.

The picture, however, is to be blown up four times instead of three. The exposure must be greater, but by how much? The table just calculated, based on a standard enlargement of three, indicates that the exposure will have to be increased by a factor of 1.56, or approximately another 60 per cent. In this case the actual exposure will be 32 times 1.56, or about 51 seconds. If the lens opening is to remain at  $f/8$ , this is the required exposure. If, however, it is desirable to use a shorter exposure—perhaps the timer will not operate for an exposure of this length—then the lens can be opened up one stop, whereupon the exposure will be halved, or brought to about 26 seconds.

The author operates in this manner; but he still makes a test of the high-light area just to make sure that everything is working properly. This test is especially important when a new supply of printing material is to be used, when the developer has been compounded some time before the actual day of printing, although it has not been used in the interval. This sort of calculation, and the use of the Kodak Print-exposure Computer, gives one an excellent place to start on the way toward a good print. Any other method

is sure to lose time and materials. Guessing does not count for much in the color-print business unless the conditions are rigidly standardized and unless the photographer is making prints practically every day.

### COST OF MAKING PRINTS

The following figures are approximate. They are figured on the current cost of the materials, on the fact that three sets of separations can come from one dozen negatives and similarly that four prints can come from one dozen matrix films, and on the fact that the permanent equipment is at hand and can be used for any number of prints. Second prints from a given set of matrices will cost much less than the figure covered here; but a second carbro will cost approximately as much as the first.

#### DYE TRANSFER

<i>Print size</i>	<i>.5 by 7 inches</i>	<i>8 by 10 inches*</i>	<i>11 by 14 inches</i>
Material cost per dozen			
Separation negatives	\$1.00	\$1.00	\$1.00
Matrix film	1.70	3.73	7.19
Dyes	4.50	4.50	4.50
Transfer paper	0.30	0.75	1.35
Chemicals	4.00	4.00	4.00
Cost for 4 prints	5.00	7.00	10.00
Cost per print	1.25	1.75	2.50

#### CARBRO

<i>Print size</i>	<i>8 by 10 inches</i>	<i>11 by 14 inches</i>
Material cost per dozen		
Separation negatives	\$ 1.00	\$ 1.00
Bromides	0.75	1.40
Pigment paper	5.50	10.00
Support paper	3.95	4.85
Chemicals	1.00	1.00
Cost for 4 prints	10.20	15.00
Cost per print	2.55	3.75

## ADDITIONAL NOTES ON CARBRO

In *Amateur Photography* (British), January 8, 1947, T.T. Baker gives a few pointers that may be useful to the carbro worker. Abrasion marks on paper made without an overcoating may be removed in a few seconds by treatment with a ferri-cyanide-hypo solution. Spots on the final carbro print are often due to dust or other solid particles, which get between the bromide print and the sensitized tissue, thus preventing proper bleaching and hardening. The surfaces must be clean. There should be enough water in the bromide and the tissue to ensure good contact, but they should not be soft enough to spread when squeegeed together.

Mr. Baker suggests that wiping the surfaces of the bromide and tissue with a wad of cotton wet with the sensitizing solution will help remove minute air bubbles. He has a rather unconventional proposal after the tissue and bromide are stripped apart. At this stage he states that the tissue can be squeegeed down to the plastic immediately, developed in warm water, and dried—as is customary. On the other hand, he states that the tissue may be washed and dried before transfer to the plastic. In this manner a natural stopping place in the process occurs; and according to the writer, the tissues are tougher and easier to handle if dried before being developed on the plastic in hot water. The water can be warmer (110°F) if the tissue has been dried, whereas a temperature of 100° to 105°F is recommended if transfer to plastic and development takes place immediately. A one-solution sensitizer formula will be found in the article.

## AnSCO Printon; Recent Developments

**BY ALL ODDS**, the ideal solution to the color printing problem is the ultimate development of a single sheet of paper (or other support) containing the necessary three emulsions which can be exposed to a transparency by contact or by projection and which can then be processed in much the same manner used to carry a color film through to the finish. The nearest approach to this ideal, and one that is in steady use today by professional color-print concerns, is AnSCO Printon. Here, indeed, is the single material needing but a single exposure and but a single series of processing steps to produce the final three-color picture. Separation negatives are not required.

Printon has a safety base that is rather heavy and opaque and as white as modern science can make it. Since the colors of the final print are made by a subtractive process, it is important that the base material be of the correct color—white. Much research has gone into this phase of print making. Naturally the emulsion is panchromatic and must be handled in darkness. Printon is not inexpensive: a 4x5 print costs about 25 cents and an 8x10 about a dollar (exclusive of chemicals, etc.). Since Printon, like any other printing medium of the tripac type, requires the exposing light to have a certain color temperature, voltage regulation of the enlarging lamp, or whatever the exposing light may be, is a very good idea.

The individual batches of Printon vary among themselves as to the correct color temperature required to produce proper color balance, and so one of the first steps in the process is to determine the filter to be used with the exposing light. The manufacturer helps in this test by giving a filter number on the outside of the

box containing the paper—but this is only a start. The photographer must finally determine for himself the proper filters to use; the selection depends on the emulsion used, the age of the exposing lamp, the voltage at which it is run, and the other characteristics over which he has little control. Fortunately the manufacturer provides additional test material so that these preliminary steps may be carried out without wastage of full-size sheets. The first print, however, is likely to be expensive.

At least two filters are required in the enlarger—one to remove the long-wave rays from the lamp (a heat-absorbing glass such as Aklo filter glass or Corning No. 3962) and one to remove ultraviolet rays (the UV-16P or Corning Noviol No. 3060). The enlarging lamp should be a GE No. 212 or a Wabash Superlite E11. Some directions state that the lamp should be operated at 110 volts, others state 115 volts. Whatever you decide to use, stick to it. Eliminate this one variable, at least.

### PRINTON TECHNIQUE

Having purchased the Printon sheets in the size of picture you are to make, a set of the required filters, the heat-absorbing glass and the UV filter, plus a chemical kit, you are ready to make a trial run. Since the author's experience with Printon is not extensive, he can do little here except give an outline of the procedure, cite certain points he or his friends have discovered and recommend that the directions of the manufacturer be followed as closely as possible.

The first delicate operation is to select the transparency. Like all printing media, Printon cannot reproduce both high-light and shadow details of a high-contrast transparency. Pick out a colorful transparency, one in which the colors are correct and not too warm or too blue, one which is sharply focused, and, finally, one in which the contrast is not great. That is, do not pick out one in which you expect at the same time fine details of a brightly

lighted blue sky and details in the shadows under the old apple tree. A transparency made in the studio with adequate and full-front lighting or one made out of doors on a rather hazy day will be best.

Since there is no reversal of the image, right to left, in using Printon, the transparency should be placed emulsion down in the enlarger just as you would make a black-and-white print from any negative. Focus it critically on the easel and select a portion in which the more important colors plus a white object, if any, exist. Using the filters recommended on the box, make test exposures on a piece of Printon—using, if possible, the Stripmeter (mentioned earlier in this book). To make a test of a larger portion of the transparency, make the first essay into Printon by making a contact print; *i.e.*, place the transparency in a printing frame, place over it the test piece of Printon, and expose at the easel by using the lens opening and lens-to-easel distance that will be employed when the enlarged print is finally made. Give exposures of 2, 4, 6, and 16 times, those you would ordinarily give a sheet of bromide paper under the same conditions. Process this test strip and note the results. Data is now at hand to determine the final exposure and, possibly, the correct filters.

### *Color Compensation*

The object of the filters is to adjust the color temperature of the light source to that required by the printing paper. If the print test is too blue, the light source was too blue. Then you need a filter that will subtract blue; *i.e.*, you must use a filter that is more yellowish than the one you employed in the test. Another method of determining the correct filter, after the test has indicated that something must be done, is to look at the result through several filters and attempt to find the one that makes the result look best. Here is where the value of reproducing a white object comes into plain view: if a white cloud is bluish, obviously the exposing light



was too blue. Compare the test result with the original transparency, illuminating them by the same viewing light.

The most difficult part of the whole process is to select the proper filter (or filters), and your first print is likely to be expensive in this respect: you may have to make several tests to get your bearings and to learn the effect of the filters. The Ansco book *Color Photography Made Easy* gives a very useful summary of this part of the process.

### *Improvements in Printon*

Color materials do not have the latitude of black-and-white films or plates. The exposure has to be much more correctly judged. Furthermore, they are inclined to be contrasty—which really amounts to the same thing as low latitude. Printon is not unlike other color materials in this respect. But within recent months great changes have been made in the medium; hence the gradation is much softer (less contrasty) and, going hand in hand with this advantage, the newer Printon has a longer exposure scale, thus enabling the photographer to select transparencies with a little less attention to the contrast.

Early Printon suffered from other faults; for example, the whites of a picture were inclined to be yellowish. With the new material, clouds come out white, shadows are deeper black, there is better color rendition throughout the scale, and, due to the longer exposure scale, there is more latitude in processing. Thus the photographer has an added degree of control: he can vary the development time appreciably to effect changes in contrast. Furthermore, the time in the first and color developers may both be changed to produce the desired results. At the start, however, the amateur must standardize his processing conditions—especially time, temperature, and degree of agitation—otherwise he will not know what went wrong and what to change if the first print (or two) does not turn out as he had hoped.

Masking the original transparency does not seem necessary with the new Printon unless the transparency is exceptionally contrasty or unless details are desired in strong high lights and in deep shadows.

Since Printon is, like black-and-white enlarging or contact paper, a single-exposure proposition, there is no reason why dodging cannot be employed. The difficulty is to determine how much to dodge and to remember that Printon is processed to a positive print from a positive original. Holding back a portion of the print, therefore, will make it dark and not light as would be the case in printing from a negative to a positive. Dodging in printing from separation negatives is just about hopeless. It is in this respect that Printon has one very great advantage over the more complex processes.

There is another possibility of color control in the simple expedient of binding up with the transparency a sheet of dyed film. Thus if the sky is dull blue and you want a good healthy color, tape a piece of clear film to the transparency, apply the dye (Anso Colorline dyes come in six colors) to the sky with a brush until the color seems somewhat exaggerated. Since this handwork is done on a separate piece of film and not on the transparency, if the work is underdone or overdone, the dyed film may be thrown away and another attempt made. The transparency has not been damaged or changed in any respect.

### *Aids to Successful Printon Pictures*

In any color process every trick one learns about photography will come in handy. All tools that one can obtain should be useful. A densitomer will help but will probably be too expensive for the average amateur. One of the simple photometers used so successfully for ordinary enlarging will be a help in using Printon. Any exposure meter that can measure the illumination that gets through critical parts of a transparency can be employed.

In using any of these tools, the first thing to do is to make a successful Printon, recording all the conditions, and standardizing the processing very carefully—time in solutions, temperature of solutions, degree of agitation. Now use the photometer, the densitometer, or the exposure meter to learn the amount of light that gets through the critical part of the transparency—a white cloud preferably. Now, having these data, any other transparency can be printed successfully without tests. But a white object is really necessary; there should be a standard lens opening and lamp voltage; and the degree of enlargement should be standard or else the amount by which the exposure must be varied for the particular magnification must be accurately known. The use of a densitometer is explained in the chapters dealing with separation negatives and with imbibition and carbonyl printing. The technique of using the photometer or the exposure meter for the same purpose is fairly obvious.

Since a Printon is a negative after it comes from the first developer, one can employ a negative bromide print made from the transparency to judge correct exposure. Thus, make several prints from the transparency under exactly the same conditions that will be employed for Printon, varying the exposure so that a fairly extensive range is available. Develop these tests in Printon first developer for 1 minute with constant agitation and rinse in the shortstop. Now make a successful Printon, and after it has got to the negative stage, compare it with the bromides. Suppose you find that a 10-second exposure on bromide produces the same result (a negative image, of course) as a 20-second exposure on Printon. Now the relation between the bromide and the color material is known. When another transparency is to be reproduced, make a series of negatives on bromide paper from the color original, select the best-looking one, and note the exposure time. Double it when exposing Printon to the same transparency.

All in all, Printon offers the amateur and the professional much in the way of a versatile single-exposure color-printing medium. The chief difficulty as this book goes to press is that the commercial printers need so much Printon for making inexpensive prints for the photo trade that the amateur has little chance of getting his hands on supplies.

### RECENT DEVELOPMENTS

Two new materials for the color photographer had been described although not made available at the time this book was in proof stage. Both are meritorious technical achievements and materially supplement the color photographer's box of tricks.

#### *Ektacolor*

Kodak has developed another color film, this one specially adapted for color printing. It is similar to Kodacolor in that the film results in a negative in colors complementary to the final printing colors. There is a deep yellow overcast, however, which is the result of the automatic masking involved in making and processing the material.

Ektacolor will probably not be offered in small sizes or in rolls. Early indication points to a speed about the same as Ektachrome, i.e., an index of 8 indoors or an exposure index of 5 outdoors with a No. 85B filter. It is to be processed by the photographer.

After exposure in the camera, the film is developed in darkness for about 15 minutes, with the rest of the processing taking place in normal illumination. About an hour is required for complete processing. The next step is to make separation positives on a panchromatic type of wash-off or matrix film that can be dyed and transferred in the normal fashion. Since the film is automatically masked with two masks, very good color fidelity is obtained in the prints.

Since the film has a deep yellow overcast, proper exposure to the Dye Transfer panchromatic film creates a problem; at the time of writing the author does not know how this is to be solved. Surely it will be necessary to have some reference object in the subject, since a gray scale will turn out yellow.

Ektacolor will get around the entire separation-negative process completely. Instead, one makes directly on the final printing films the separation positives.

Defender also offered panchromatic wash-off film for a time with a method of making prints directly from transparencies by an etching process, but this material is no longer available.

### *S-T Tripac Negatives*

As has been described in a previous chapter, the making of separation negatives from an original subject is not too simple. One must make the three exposures—with proper regard to each other, with regard to the light source, and with regard to the filters employed. Unless the negatives are made in a one-shot camera (which exposes all three negatives at the same instant), the subject being “separated” must not move. And the best of photographers has difficulty in making a portrait by the straight separation method, since there is an irreducible minimum time required to change films, filters, and exposures.

Before the war a useful set of films, known as Tripac, was available. This consisted of three films exposed in a special holder that kept them together under some pressure. The exposing light penetrated one film after the other, and all were exposed with a single push of the shutter lever. Since the third, or red-recording (blue-printer), film was reached by the exposing light only after traversing the other two films, the blue record tended to be a bit fuzzy or diffused. Unfortunately, it is a fact that the blue printer is just the one that gives definition to a color picture. For this reason Tripac

was recommended only in the larger sizes and only for medium enlargements.

A new development along the line of Tripac has been made by the Du Pont research workers and promises to aid materially the color worker who makes separation negatives direct from the original subject matter and not through the medium of a transparency. This product is called S-T Tripac. As this book goes to press, none of the materials are available to the trade; however, demonstrations of the new product have been made. The following description, therefore, is based on that of the manufacturer's data and on the article in the *Journal of the Photographic Society of America*, January, 1948.

S-T Tripac consists of two films exposed as a unit, again in a pressure-type plateholder. The front film has an emulsion both on the front and on the back. The front film records blue, the back film green, and the emulsion on the second film records red. All three films are processed and then, by some new necromancy of the researchers, the first film is pulled apart so that the two color records are separated. One of these records is now remounted on another base forming the third separation negative.

The exposure latitude of this new adjunct to color techniques approaches that of black-and-white film; it is balanced for 3200°K and may be used in daylight with an 85B filter; the exposure index is 12 for 3200°K lamps and 8 in daylight (with filter). About 25 minutes, not counting washing and drying, is required to process one set of negatives—although there is no reason why several sets cannot be run through at the same time.

The actual processing is as follows: after exposure the films are developed in a conventional solution (PD-5) for 10 minutes; then they are rinsed for 30 seconds in a sodium sulfate-borax solution, fixed for 8 to 10 minutes in a conventional hypo solution, immersed for 2 minutes in a transfer solution, rolled into contact with the

new support, and stripped. In this process the green-filter image and the blue record are separated as they are mounted on separate supports. The red record, of course, does not go through this transfer process.

The films should, preferably, be exposed in a special holder in which the films are held between a pressure plate in the back of the holder and a thin glass plate in front. This technique maintains good contact between the two films. It is possible that smaller sizes of S-T Tripac may be held in ordinary film holders in close enough contact to preserve fine detail.

A summary of the processing steps and the formulas to be used are given below.

#### S-T TRIPAC PROCESSING STEPS

<i>Operation</i>	<i>Time in Minutes</i>	<i>Solution</i>
Development	10	A
Rinse	½	Water
Fixation	10	Acid hypo
Hold (optional)	0-30	B
Transfer	2	C

#### S-T PROCESSING SOLUTIONS

<i>Solution A, Developer</i>		<i>Solution B, Holding Bath</i>	
Methol	1.5 grams	Sodium sulfate	120 grams
Hydroquinone	15.0 grams	Borax	10 grams
Sodium sulfite	60.0 grams	Water to make	1000 cc
Potassium carbonate	64.0 grams		
Potassium bromide	4.5 grams	<i>Solution C, Transfer Bath</i>	
Water to make	1000 cc	Alcohol (70 per cent)	800 cc
		Aluminum chloride (32° Be)	7 cc
		Acetic, glacial	20 cc
		Water to make	1000 cc

# Index

## A

- Aberration, lens checking for lateral, 212
- Achromatic colors, 11
- Additive analysis filters, 25
- Additive color process, 18-20
  - comparison with subtractive, 21-25
- Anso color film, 54
  - compensating for underexposure and overexposure of, 123
  - daylight exposure table of, 74
  - photoflash guide numbers of, 75
  - processing of, 105-117
    - formulas for, 110-113, 119-123
  - tungsten type, 80
    - exposure guide for, 80
- Anso Color Printon, 42, 124, 339-345

## B

- Background, importance of, 59
  - color and clothing in, 70
- Beach scenes, 63-64
- Black-and-white prints from color transparencies, 94-96
  - by reversal, 96-97
- Bleach formula, nonspiling, for carbro, 329
- Blue shadows, 82
- Brightness range, 32-33
- Bromides for carbro, 309-311, 323-324

## C

- Calgon, use of, 112
- Calibration, enlarger, 332-337

- Camera, one-shot, 197-200
- Carbro, 256, 257, 304-338
  - bromides, 309-311, 323-324
  - chemicals, 323
  - combiner in, 320-321
  - cost of, 337
  - duplicate prints, 328
  - final transfer, 316-317
  - formulas, 318-320
  - high-light loss, 328
  - method, 41
    - McGraw Colorgraph, 307-309
    - monochrome, 304-306
    - mottle, 328
    - nonspiling bleach formula, 329
    - pigment images, 312-313
    - pigments, 256
    - refrigeration needed in use of, 324
    - soluble support, 315-316
    - spotting, 317
    - squeegee method, 313-314
    - Stripmeter use for, 310
    - stripping the pigment, 311-312
    - transfer of pigment to registration plastic, 314-315
    - variations, 329-331
    - voltage control in use of, 324-325
    - and wash-off combined, 331-332
- Chromatic colors, 11
- Chromatone, 41
- Close-up exposures, 98-101
  - table of, 100, 101
- Clothing and background color, 70
- Color, correct exposure for, 50
  - definition, 11
  - density range for, 51-53
  - effect of prism on, 10
  - equipment, 5-6
  - experience needed for work in. 6-8



Color, exposure, 50, 58-66  
 latitude for, 51-53  
 voltage control in, 97-98, 324-325  
 Color-compensating filters, 90  
 Color film, cost per exposure, 128  
 processing of, 104-130, 137-138  
 Color method, Maxwell's, 18-19  
 Color portraits, 71-72  
 Color printing, density range for, 51  
 Color process, additive, 18-20  
 comparison with subtractive, 21-25  
 carbro, 41  
 Chromatone, 41  
 Dye Transfer, 41, 51, 253-303  
 Printon, 42, 124, 339-345  
 (See also Printon)  
 subtractive, comparison with additive, 21-25  
 wash-off, 41, 253-303  
 Color processes, 17-25  
 Color-processing solutions, keeping properties of, 117-118  
 Color reducers, 125  
 Color sensations of eye, 13  
 Color separation, effect of underexposure and overexposure in, 49-50  
 (See also Separation negatives)  
 films for, 48-49, 144-146, 194, 197  
 Color spectrum, 9-12  
 Color temperature, 83-86  
 table of, artificial light, 84  
 daylight in °K, 86  
 Color temperature conversion filters,\* 91  
 Color transparencies (see Transparencies)  
 Colors, achromatic, 11  
 chromatic, 11  
 complementary, 12-14, 16  
 primary, 12-14  
 Combiner, in carbro, 320-321  
 Complementary colors, 12-14, 16  
 Computer, print-exposure, 172  
 Contact separations, 204-208  
 Contrast, 36

Contrast, and density, meaning of, 33-38  
 effect of development on, 35  
 effect of temperature on, 154-156  
 Contrast control, in dye transfer, 267, 297  
 Copying camera separations, 210-212  
 Correction filters, 42  
 Cost per exposure, color film, 128  
 Curtis enlarging printer, 228

## D

Defender tricolor filters, 48  
 Densitometer, 172  
 GE exposure meter as, 177  
 homemade, 174-178  
 use of, to determine exposure, 294-296  
 Weston, 174  
 Densitometry, 180-186  
 Density, 29  
 and contrast, meaning of, 33-38  
 filters, neutral, 47-48, 148  
 Kodaguide, 172  
 range for color, 51-53  
 Density-opacity conversion table, 186  
 Developer, tanning, 264, 297-299  
 Development, effect of, on contrast, 35  
 purpose of, 34  
 of separation negatives, 152-160, 166, 218  
 tank, 159-160  
 Direct-separation negatives, masking of, 249-250  
 Driffield and Hurter, 29  
 Dye mordanting, 303  
 Dye Transfer (wash-off), 41, 257-303  
 dyes, 256, 270, 299-303  
 images, registering and transferring of, 267-269  
 making transfer, 280-283  
 process, separations for, 163  
 vs. wash-off, 263-265

Dyes, for wash-off and dye transfer,  
256, 270, 299-303

## E

Ektachrome, 54, 80-82  
 basic exposures for, 78  
 exposure table, for daylight, 73  
 for photoflash, 79  
 for 3200° lamps, 81  
 transparencies, masking, 247-248  
 type B film, photoflash guide numbers, 82  
 (See also Exposure; Film; Filters; etc.)  
 Ektacolor, 345-346  
 Enlarger calibration, 332-337  
 Enlarging printer, Curtis, 228  
 Equipment for color, 5-6  
 Exposure, basic, for Kodachrome and Ektachrome, 78  
 close-ups, 98-101  
 color, 50, 58-66  
 compensating for underexposure and overexposure in Ansco color, 123  
 correct, for wash-off, 273-276, 290-294  
 and development, table for separations from transparencies, 218  
 Pola-screen, 91  
 use of densitometer to determine, 294-296  
 Exposure Computer (see Print-exposure Computer)  
 Exposure factor, 45  
 for separation negatives, 221  
 Exposure guides, 4  
 (See also Ansco; Kodachrome; etc.)  
 Exposure meter, 4  
 as densitometer, 177  
 use of photoelectric, 60, 69  
 Exposure meter settings, artificial light table, 66  
 color film tungsten type, 78  
 daylight table, 62

Exposure ratios, for color-separation negatives, 166

Exposure table, Ansco daylight film, 74

tungsten, 80

Kodachrome and Ektachrome daylight film, 73

photoflash, for Kodachrome and Ektachrome, 74-82

with still cameras, 68

photoflood with still cameras, 67  
 for 3200° lamps, Ektachrome, 81

Exposure tables, Kodacolor, 132, 136

Exposure test, Type B Kodachrome Professional film, 77-78

Exposures, in daylight, synchronized, 75

photoflash, 75, 81-82

tropic, 64-65

## F

Film, brightness range of, 32-33  
 characteristic, 27, 39

light-intensity range of, 32-33

ordinary, 38-39

orthochromatic, 38, 40-41

overexposure of, 30-31

panchromatic, 38-39, 41

processing of color, 104-130, 137-138

purpose of fixing bath, 27

tone range of, 31-32

underexposure of, 30-31

(See also Ansco; Ektachrome; Ektacolor; Kodachrome; Kodacolor; etc.)

Film contrast, definition of, 36

and density, meaning of, 33-38

Film development, effect of, on contrast, 35

purpose of, 34

and separation negatives, 152, 160, 166

Film latitude, 31

Films, color separation, 48-49, 144-146, 194, 197

how to label, 156-157

Films, nonpanchromatic, 49  
 special, 194-197  
 separation negative (*see* Films,  
 color separation)  
 Filter factors, 45-47  
 for separation negatives, 168  
 Filter transmission curves, tricolor, 43  
 Filters, 42-48  
 absorbing, 90-91  
 additive analysis, 25  
 Ansco color, 92-93  
 color compensating, 90-93  
 for color films, 82-83, 89-93  
 correction, 42  
 Defender tricolor, 48  
 effect of separation, 188-194  
 Ektachrome, 92  
 forms of, 44  
 Kodachrome, 89-92  
 and light sources for daylight color  
 film, table, 86-87  
 neutral density, 47-48, 148  
 separation, 42, 142-144  
 Fireworks, photographs of, 71  
 Fixing, purpose of, 27  
 Flash, and synchronized exposures in  
 daylight, 75  
 synchronized, 65-66  
 use of handkerchief with, 65-66  
 Flood lamps to supplement daylight,  
 76  
 Flower photography, 62  
 "Frilling," 306

## G

Gamma, 36  
 calculation of, 37  
 Gray scale, 146  
 homemade, 178-180

## H

H & D curve, 29  
 Handkerchief, use of, with flash, 65-  
 66  
 Hue, 11  
 Hurter and Driffield, 29

## I

Image, latent, 27  
 Imbibition (*see* Dye Transfer; Wash-  
 off)  
 Imbibition color prints, 253-303  
 Imbibition paper, final support, 260  
 Imbibition printing process, 259-263

## K

Kodachrome, 54  
 how it works, 103-104  
 filters, 89-90  
 35-mm type A, filters, 92  
 (*See also* Exposure; Filters; etc.)  
 Kodachrome Professional Film, basic  
 exposure for, 78  
 daylight type, 77  
 exposure table for, 73  
 photoflash guide numbers, 74  
 Type B, photoflash exposure table  
 for, 79, 80  
 exposure test for, 77-78  
 Kodacolor, 54, 130-138  
 exposure tables, 132, 136  
 home-processed, 137-138  
 lighting, 133-137  
 Kodak masking film, 237-238  
 separation technique, 213-220

## L

Labeling of films, 156-157  
 Lamps, blue-bulb flood, 76  
 flood, with daylight, 76  
 3200° K, 84  
 "Latent" image, 27  
 Latitude, film, 31  
 for color, 51-53  
 Lens checking for lateral aberration,  
 212  
 Light, properties of, 14-16  
 refraction of, 15  
 sources and filters of, for daylight  
 color film, table of, 86-87  
 Light-intensity range, 32-33

Lighting, contrast of, for color film,  
57-58  
for Kodachrome, 133-137  
for separation negatives, 149  
value of flat, 52  
Luminosity, 11

## M

McGraw Colorgraph carbro, 307-309  
Masking, 228-252  
  bibliography on, 251-252  
Masking direct-separation negatives,  
249-250  
Masking Ektachrome transparencies,  
247-248  
Masking film, Kodak, 237-238  
Masking negatives, 245-247  
Masks, how they improve color, 242-  
245  
  and transparencies, orientation of,  
248-249  
  unsharp, 234-250  
Maxwell's color method, 18-19

## N

Negatives, out-of-register, 200-202  
  separation, 139-251  
Newton's ring troubles, 208  
Nighttime shots in color, 71

## O

One-shot camera, 197-200  
Opacity-to-density conversion table,  
186  
Orthochromatic film, 38  
  sensitivity of, 40-41  
Orthotone, Curtis, 163, 257  
Overexposure, 30-31

## P

Panchromatic film, 38-39, 41  
Pan Masking film, 237-238  
Paper, final support for wash-off or  
  imbibition, 260, 270

Photoflash exposure table, for still  
  cameras, 68  
  Kodachrome Professional and Ek-  
  tachrome type B, 79  
Photoflash exposures, with type B Ek-  
  tachrome film, 81-82  
Photoflash guide numbers, 68  
  Anso daylight type color film, 75  
  Ektachrome type B film, 82  
  Kodachrome Professional daylight  
  film, 74  
  Kodachrome type B film, 80  
Photoflood exposure table, still cam-  
  eras, 67  
Photographic process, 26-30  
Photometer, enlarging, 174  
Photomicrography, stained slides, 98  
Picture-making process, 39-41  
Pigment, carbro, 256, 257  
  images for, forming, 312-313  
  stripping for, 311-312  
  transfer of, to registration plas-  
  tic, 314-315  
Plates for separation negatives, 144-  
  146  
Pola screen exposure, 91  
Portraits, color, 71-72  
Primary colors, 12-14  
Print-exposure Computer, 172  
Printing process, carbro, 257  
  Dye Transfer, 257  
  imbibition, 253-303  
  Orthotone, 257  
  wash-off, 253-303  
Printon, 42, 124, 339-345  
  and color compensation, 341-342  
  and dodging, 343  
  improvements in, 342-343  
  successful use of, 343-345  
  technique of, 340-341  
Prism, effect of, on color, 10  
Processing, 104-130, 137-138  
Projection, separations by, 208-210

## R

Reducers, color, 125  
Reducers, proportional, 124

- Reducing solutions, for Ansco color transparencies, 123-125
- Refraction of light, 15
- Reversal, black-and-white prints by, 96-97
- S**
- S-T Tripac (*see* Tripac)
- Saturation, 11
- Sensitivity (*see* Film)
- Separation films, color, 48-49  
(*See also* Films; Negatives; etc.)
- Separation filters, 42
- Separation negatives, 139-251  
 developers of, 153  
 exposure factors for, 221  
 exposure ratios for, 166  
 films or plates for, 48-49, 144-146  
 special films for, 194, 197  
 filter factors for, 168  
 filters for, 142-144  
 effect of, 188-194  
 lighting for, 149  
 requirements for, 161-162  
 from transparencies, 203-228  
 troubles in processing, 160-161
- Separation technique, for Kodak, 213-220
- Separations, by contact, 204-208  
 by copying, 210-212  
 in a copying camera, 210-212  
 development of, 152, 160  
 direct from subject, 163-167  
 for Dye Transfer Process, 163  
 effect of overexposure and underexposure on, 49-50  
 by projection, 208-210  
 from transparencies, exposure and development table for, 218
- Shadows, blue, 56, 82
- Sheet color film (*see* Film)
- Slides, stained, photomicrography of, 98
- Snow scenes, 63-64
- Soluble support, carbro, 315-316
- Solution formulas, for Ansco color film, 119-123
- Solutions, capacity of transparency, 128-129  
 for transparencies, keeping properties of, 127
- Spectrum, color, 9-12  
 visible portion of, 11
- Spotting of carbro, 317
- Squeegee method for carbro, 313-314
- Stage scenes, 71
- Store windows, at night, 71
- Street scenes, at night, 71
- Stripmeter, 173  
 use of, for carbro, 310
- Subtractive color process, 20, 256  
 advantage of, 24-25  
 comparison with additive, 21-25
- Sunsets, exposure for, 63
- T**
- Tank development, 159-160
- Tanning developer, 264, 297-299
- Temperature, effect of, on contrast, 154-156
- Tone range, 31-32
- Transfer, carbro final, 316-317  
 in wash-off or Dye Transfer, 280-283
- Transparencies, Ansco color, 54  
 black-and-white prints from color, 94-96  
 capacity of solutions for, 128-129  
 cost of color, 3  
 defects in, 129-130  
 duplicating of, 98  
 Ektachrome, 54  
 masking of, 247-248  
 equipment for, 118-119  
 exposure and development table for separations from, 218  
 keeping properties of solutions for, 127
- Kodachrome, 54  
 making of, 54-138  
 and masks, orientation of, 248-249  
 processing of, 126  
 reducing solutions for, 123-125  
 by reversal, 96-97

- Transparencies, separation negatives  
from, 203-228
- Tricolor filters, Defender, 48  
transmission curves for, 43
- Tripac, 197, 346  
S-T, 347-348
- Tropic exposures, 64-65
- U
- Underexposure, 30-31
- V
- Voltage control in color, 97-98, 324-  
325
- W
- Wash-off (Dye Transfer), 41, 237,  
253-303
- Wash-off (Dye Transfer), and car-  
bro combined, 331-332  
corrective measures in, 279-280  
determining correct exposure in,  
273-276  
vs. Dye Transfer, 263-265  
final support paper for, 260, 270  
formulas for, 285-287  
image removal formula for, 278  
judging correct exposure for, 290-  
294  
time for, compared with dye trans-  
fer, 262
- Wash-off dyes, 256, 270, 299-303
- Wash-off transfer, making, 280-283
- Y
- Young-Helmholtz theory of vision,  
13-14



