

BIRLA CENTRAL LIBRARY

PILANI (RAJASTHAN)

Class No ^R 621.18

Book No 690F

Accession No. 31867

FUELS, COMBUSTION, AND FURNACES

*The quality of the materials used in
the manufacture of this book is gov-
erned by continued postwar shortages.*

McGRAW-HILL CHEMICAL ENGINEERING SERIES

Texts and Reference Works Outlined by the Following Committee

- | | |
|---|--|
| H. C. FARMELER, <i>Chairman</i> · Editor Emeritus
Engineering and Mining Journal | ALBERT E. MARSHALL · President, Rumford
Chemical Works |
| S. D. KIRKPATRICK, <i>Consulting Editor</i> · Editor,
Chemical & Metallurgical Engineering | R. S. McBRIDE · Consulting Chemical Engineer |
| HARRY A. CURTIS · Dean of Engineering, Uni-
versity of Missouri | C. M. A. STINE · Vice President, E. I. du Pont
de Nemours & Co. |
| J. V. N. DORR · President, The Dorr Company | E. R. WEIDLEIN · Director, Mellon Institute of
Industrial Research |
| A. W. HIXSON · Executive Officer, Department
of Chemical Engineering, Columbia University | M. C. WHITAKER · Vice President, American
Cyanamid Company |
| J. H. JAMES · Professor Emeritus of Chemical
Engineering, Carnegie Institute of Technology | A. H. WHITE · Professor Emeritus of Chemical
Engineering, University of Michigan |
| W. K. LEWIS · Professor of Chemical Engineer-
ing, Massachusetts Institute of Technology | WALTER G. WHITMAN · Professor of Chem-
ical Engineering, Massachusetts Institute of
Technology |
-

THE SERIES

- BADGER AND BAKER—*Inorganic Chemical Technology*
BADGER AND McCABE—*Elements of Chemical Engineering*
DAVIS—*Chemical Engineering Nomographs*
DODGE—*Chemical Engineering Thermodynamics*
EDWARDS, FRARY AND JEFFRIES—*The Aluminum Industry (in Two Volumes):
Aluminum and Its Production; Aluminum Products and Their Fabrication*
GRISWOLD—*Fuels, Combustion, and Furnaces*
GROGGINS—*Unit Processes in Organic Synthesis*
LEWIS AND RADASCH—*Industrial Stoichiometry*
MANTELL—*Adsorption*
MANTELL—*Industrial Electrochemistry*
NELSON—*Petroleum Refinery Engineering*
PERRY (EDITOR)—*Chemical Engineers' Handbook*
PIERCE—*Chemical Engineering for Production Supervision*
RHODES, F. H.—*Technical Report Writing*
RHODES, T. J.—*Industrial Instruments for Measurement and Control*
SHERWOOD—*Absorption and Extraction*
SHERWOOD AND REED—*Applied Mathematics in Chemical Engineering*
SHREVE—*The Chemical Process Industries*
TYLER—*Chemical Engineering Economics*
VILBRANDT—*Chemical Engineering Plant Design*
WALKER, LEWIS, McADAMS AND GILLILAND—*Principles of Chemical Engineering*
-

CHEMICAL ENGINEERING SERIES

Fuels, Combustion and Furnaces

BY

JOHN GRISWOLD

Professor of Chemical Engineering

University of Texas

First Edition

Second Impression

New York

McGraw-Hill Book Company, Inc.

London

1946

FUELS, COMBUSTION, AND FURNACES

COPYRIGHT, 1946, BY THE
MCGRAW-HILL BOOK COMPANY, INC.

PRINTED IN THE UNITED STATES OF AMERICA

*All rights reserved. This book, or
parts thereof, may not be reproduced
in any form without permission of
the publishers.*

PRINTED BY THE MAPLE PRESS COMPANY, YORK, PA.

PREFACE

The book was written to satisfy the need for an up-to-date chemical engineering text in this important field. It is the first attempt since that of Haslam and Russell twenty years ago to bring together an essentially complete fundamental background with current developments in both theory and practice.

The major problem was of judgment as to what should be included and how much space could be afforded each topic. As may be seen from the references, one or more large volumes have already been or could easily be written under each of the sixteen chapter headings.

So rapid and varied have been the developments in the art and science of fuel technology, of combustion mechanism, and of furnace practice that the modern fuel, combustion, or furnace engineer must be well versed in certain phases of physics, of physical chemistry, and of the chemical engineering unit operations as well as with structural design.

The book assumes, as prerequisite, a knowledge of chemistry, mathematics, and physics equivalent to that of the third year of a university chemical engineering curriculum. Thorough study of all chapters with use of the references would require more than two semesters of university work. Since this will seldom if ever be attempted in a school, the topics are segregated insofar as possible, with a minor amount of overlapping material purposely left where needed to maintain continuity within a chapter. This enables the text to be used either for an introductory or for an advanced course without attempting to cover the entire book. For example, a junior-senior course may take up Chaps. I to V with selected parts of Chaps. VIII to XVI. It will usually be found advantageous to start such a course with Chaps. I and IV taken up simultaneously. A senior-graduate course may omit Chap. IV, include Chaps. VI and VII and whatever of the later material is of greatest interest.

The "Chemical Engineers' Handbook" will prove a valuable adjunct. References to the technical literature have been discriminatingly selected with due consideration to general availability. Practicing engineers should find the text useful as a source book and as a convenient review of fundamentals.

Many engineers and scientists in industry, in research institutions, and in universities gave generously of their time and effort in reviewing first drafts of the various chapters.

Although it is not permissible to acknowledge every individual, some of those who made substantial contributions are R. C. Anderson, University of Texas, who composed most of Chap. VI; M. S. Agruss, Pure Oil Co.; W. L. Badger, Dow Chemical Co.; G. C. Bergtholdt, Webster Engineering Co.; C. F. Geiger, Carborundum Co.; E. B. Guenther, Harbison-Walker Refractories Co.; W. A. Leech, Jr., Koppers Co.; W. E. Lobo, the M. W. Kellogg Co.; W. H. McAdams, Massachusetts Institute of Technology; L. S. Kassel and L. A. Mekler, Universal Oil Products Co.; R. N. Pease, Princeton University; H. H. Power, University of Texas; T. W. Rea, Detroit Stoker Co.; F. B. Schilling, Nichols Engineering and Research Corp.; F. J. Schwenk, Hauck Mfg. Co.; F. W. Hartzel and C. G. Segeler, American Gas Association, J. D. Sullivan, Battelle Memorial Institute; K. M. Watson, University of Wisconsin; and the engineering staffs of United Engineers & Constructors, Inc., and of the Babcock & Wilcox Co.

JOHN GRISWOLD.

AUSTIN, TEX.,
August, 1945.

CONTENTS

	PAGE
PREFACE	v
CHAPTER I. COAL AND COKE	1
II. PETROLEUM AND NATURAL GAS	
Part 1. Occurrence and Constitution	29
Part 2. Oil-field Operations	34
Part 3. Petroleum Refining	42
Part 4. Evaluation of Fuel Gases	45
Part 5. Evaluation of Crude Oil and Petroleum Fuels	50
Part 6. Elements of Conversion Processes	60
III. MIXTURE PROPERTIES OF PETROLEUM FRACTIONS	74
IV. COMBUSTION STOICHIOMETRY	96
V. TEMPERATURE, ENTHALPY, AND HEAT OF COMBUSTION	117
VI. EQUILIBRIUM AND KINETICS	
Part 1. Thermodynamic Equilibrium	145
Part 2. Chemical Kinetics	152
VII. THE COMBUSTION PROCESS	
Part 1. Mechanism of Reactions	181
Part 2. Engineering Properties	191
VIII. MANUFACTURED GAS	216
IX. GAS BURNERS	250
X. OIL BURNERS	278
XI. STOKERS AND PULVERIZED COAL BURNERS	297
XII. INTRODUCTORY HEAT TRANSMISSION	316
XIII. FURNACE REFRACTORIES	333
XIV. FIREBOX AND CHIMNEY CONSIDERATIONS	358
XV. TUBE HEATERS	377
XVI. PROCESS FURNACES AND KILNS	407
APPENDIX OF DATA	443
LIST OF VISUAL AIDS	473
AUTHOR INDEX	479
SUBJECT INDEX	483

FUELS, COMBUSTION, AND FURNACES

CHAPTER I

COAL AND COKE

For the United States as a whole, approximately as much of the total generated and harnessed energy is obtained from coal as from all other sources combined. The present *distribution* among the various sources is the result of relative costs, abundance, convenience of handling, and consumption. Coal reserves are adequate for many centuries to come and, except for temporary abnormal conditions such as are brought about by war and labor troubles, this distribution should not change greatly during the next few years. The division among the principal sources in the United States (expressed in terms of heat units) is roughly as follows:

<i>Source</i>	<i>Per Cent</i>
Coal.....	50
Petroleum.....	30
Natural gas.....	10
Hydroelectric power.....	10

Until the past decade the percentages of the major sources other than coal showed an irregular but continuing rise. Although the totals have all increased since then, by 1937 the percentages had become fairly constant. Trends in the future are difficult to predict with any degree of certainty.¹ Annual statistics on these and certain of the minor solid fuels are given in the U.S. Bureau of Mines "Minerals Yearbook."

ORIGIN OF COAL

Petrographic examinations of many samples indicate conclusively that coal is formed from vegetal materials such as trees, vascular plants, peat, spores, and algae. The larger remains, such as tree trunks, bark, branches, leaves, and some plant residues, can be seen with the naked eye, whereas small shapes such as wood cells, spores, and algae are discernible in prepared specimens under a magnifying glass or microscope. The residues of small plants and seeds predominate in most samples.

¹ FIELDNER, A. C., Recent Developments in Fuel Supply and Demand, *U.S. Bur. Mines Inf. Circ. 7261*, November, 1943.

The vegetal material grew in various geologic ages under conditions that can best be described as similar to those of present marshes, bogs, and peat beds. Some of the material remained where it grew, while other material appears to have been transported (as by flowing water) and accumulated in natural reservoirs existing at the time.

Studies of the evolution of coal from vegetal matter indicate two distinct periods in its formation. The *initial transformations* consisted chiefly of decay and kindred degradations. The *secondary transformations* that finally resulted in coal were much slower processes of aging under substantially anaerobic conditions, higher earth pressures, and sometimes elevated temperature; they usually extended over much longer periods of time than were available for the primary transformations.

Although various coal beds were undoubtedly formed under widely different conditions and of different vegetal materials, it seems that in the usual case the original plants grew, died, and fell into or were soon submerged in water. Peat beds accumulated and were eventually buried by earth movements such as earthquakes, glacier drift, or silt from floods.

The initial transformations of vegetal material probably included several different types of degradation and decay. There was some bacterial action and fungi were certainly active. Slow atmospheric oxidation also occurred.* Although the speed and course of this phase depended upon local conditions, the indications are that the original peat bed was formed during a period of a few centuries whereas the secondary transformations extended over hundreds or thousands of centuries. Shifts of the earth's surface eventually covered the peat beds, many of which have been buried for millions of years. Ages of time were then available for the secondary transformations, which resembled very slow carbonization. Finally produced were the dense carbonaceous products we know as coal. Factors of time, pressure, and temperature determined the extent to which the "coalification" reactions proceeded.

RANK

The degree to which the coalification reactions have taken place in a given sample determines its *rank* (the basis of the general classification of coals given later in this chapter).

* The course and rapidity of vegetal decay are both determined by local conditions. Decay is fastest in a warm, damp climate with the material exposed to the air. Dry rot will also occur under suitable conditions. Decay is retarded and its nature altered when a plant is submerged in water. Material in various states of degradation can be found in individual peat beds and swamps. Certain old and deep peat beds show progressive alteration with increasing depth, the peat being darker and more compact near the bottom of the bed. Decay eliminates carbon, hydrogen, and oxygen in various proportions, chiefly in the forms of carbon dioxide, methane, and water.

The following are clearly distinguished materials resulting from progressive metamorphism or increase in rank:

Peat → lignite → bituminous → anthracite → graphite

Although some samples of each of these have distinct physical and chemical characteristics, border lines between the first four are purely arbitrary. A series of samples of the first four ranks can be assembled in which the individuals have a nearly continuous gradation of a given physical or chemical property.

It is probable that higher pressures and temperatures were required to produce anthracite than existed in the bituminous beds. It is safe to assume that at least some of the natural graphite has been produced from coal by the effects of extremely high temperatures. ✓

PHYSICAL CHARACTERISTICS

Commercial Varieties—Ranks. The appearance and physical properties of coal are but vaguely related to its chemical analysis. Peat is insufficiently transformed to be regarded as coal. *Brown coal* is the lowest in rank and is readily identified by its color and texture. It is soft, has a woody structure, and disintegrates on drying. *Lignite* may be dark brown or black, with either a woody or an amorphous texture. On weathering, it tends to break into slabs. Brown coal and lignite contain high percentages of moisture with even higher percentages of total oxygen. Black lignites grade into subbituminous coals of lower oxygen content and correspondingly higher heating value.

Subbituminous coals are not distinguishable as a class by appearance or physical properties. They are intermediate between black lignite and bituminous products. Subbituminous coals are relatively high in oxygen and they all "weather" or slowly disintegrate upon continued exposure to the atmosphere.

Different bituminous coals vary widely in appearance, physical and chemical properties. In general, they are harder than subbituminous samples and most frequently exhibit a cubical fracture. Anthracite coals are harder than bituminous, usually having an amorphous texture and a conchoidal fracture. Anthracite is relatively nondusty and burns with a smokeless flame. Anthracites are characterized by high carbon content and low volatile matter and oxygen.

Commercial Varieties—Types. The rank of coal has little if any relation to the type of vegetal materials from which it originated. As previously noted, residues of plant structures can be detected in most samples. The type of vegetal material is to some extent related to the petrographic structure of the coal.

Thiessen² applied the term *anthraxylon* to the shiny black, relatively homogeneous structure, concluding that it was formed from the woody tissues of plants including the bark. He designated the duller gray-black structure as *atritus*, since many samples contained a wide variety of botanical residues. The dull, friable, charcoal-like material was called "charcoal" or "mother of coal," later "fusain."

Stopes³ differentiated four structures in European banded coals:

1. *Vitrain*.—The relatively homogeneous, lustrous black ingredient having a conchoidal fracture.

2. *Clarain*.—The bright ingredient with a streaked or silky luster. It is not so homogeneous nor so glossy as vitrain and does not have the characteristic fracture of vitrain.

3. *Durain*.—The hard, dense ingredient having little or no luster. The fracture is irregular.

4. *Fusain*.—The dull, friable, somewhat porous ingredient having the fibrous texture characteristic of charcoal.

When microstructures in vitrain can be identified, they are those of woody tissue. Hence vitrain is closely identified with anthraxylon. It is sometimes difficult to distinguish clarain from vitrain. However, clarain samples may reveal macerated plant residues (macerals) such as spore exines, which are very rare in vitrain. Durain has a higher specific gravity on the average than vitrain or clarain. It is characterized by a high proportion of macerals (chiefly spores exines) and is lower in *ulmins** than the preceding types. Fusain is relatively low in ulmins and in volatile matter and high in ash. Fusain seems to have been formed by quite different conditions than were responsible for the other structures, possibly by dry rot or surface fires during the initial transformations. Stopes later enlarged upon her original classification, and other attempts have been made to adopt comprehensive systems of petrographic nomenclature based upon rock and maceral types. None of these has as yet been universally accepted.

The structures just discussed are most clearly differentiated in bituminous samples although they also appear in subbituminous and to a lesser degree in anthracite coals. *Banded* bituminous and subbituminous samples are very common. The bands are lenticular to nearly flat layers of the several structures, each of which may vary in thickness from a fraction of an inch to a foot or more. The boundaries of the bands occur roughly parallel to the plane of the seam bedding.

² THIESSEN and SPRUNK, *U.S. Bur. Mines Tech. Paper* 573 (1937) and earlier publications.

³ STOPES, M. C., *Proc. Roy. Soc. (London)*, **90B**, 479 (1919).

* Amorphous substances, relatively high in volatile matter and low in ash. Peat ulmins and a portion of the coal ulmins are soluble in caustic. Slow, prolonged oxidation increases the solubility of coal ulmins in caustic.

The American Society for Testing Materials (ASTM) defines some commercial varieties of bituminous and subbituminous coals:⁴ *common banded*, *splint*, *cannel*, and *boghead*. From the description of banded coal, the bands are identified as vitrain, clarain, and fusain. Durain is not a common ingredient of American banded coals. Splint coal is principally durain but may contain thin bands of vitrain and clarain. The ASTM definitions of cannel and boghead coal are

“*Cannel Coal*.—A variety of bituminous or subbituminous coal of uniform and compact fine-grained texture with a general absence of banded structure. It is dark gray to black in color, has a greasy luster, and is noticeably of conchoidal or shell-like fracture. It is noncaking, yields a high percentage of volatile matter, ignites easily, and burns with a luminous, smoky flame.

“*Boghead Coal*.—A variety of bituminous or subbituminous coal resembling cannel coal in appearance and behavior during combustion. It is characterized by a high percentage of algal remains and volatile matter. Upon distillation it gives exceptionally high yields of tar and oil.”

OCCURRENCE OF COAL

Coal seams nearly always lie adjacent to and are often interspersed with strata of clay, shale, sandstone, and sometimes limestone. Although at least some of the minerals of the original plants remain in the coal, most of the mineral matter is extraneous or brought in at various times during the transformations.

Although thicknesses of different coal seams range from a few inches to more than 40 ft, the average thickness of workable beds in the United States is only about 4 ft. The individual seam also varies in thickness and contains *faults*, *folds*, and igneous *intrusions*. These irregularities resulted from earth movements and other geologic phenomena.

An entire seam may be pictured as having the general form of a gigantic basin or a portion of one. The rim is a surface outcrop by which many seams were originally found and at which the workings sometimes start. The depth of overburden varies with the location. The *pitch* or slope may be very small in some places and very great in others. An entire basin may extend over thousands of square miles, but only a small portion of it may be profitable to mine.

Although nearly every country of the world has at least some coal, its distribution as to both abundance and rank on the several continents is irregular. Among the different ranks, the higher are the less abundant. The only important workings of anthracite at present are in the state of

⁴“ASTM Standards on Coal and Coke,” test designation D 493—39. Bold-face numbers prefixed by D are ASTM test designations.

Pennsylvania and in parts of the British Isles; China and Russia have workable anthracite measures.

MINING

Only a few of the more common generalities in the art of mining can be given here. When a coal seam of sufficient thickness and value is not buried too deeply, it may be *strip-mined* by removing the overburden and recovering the exposed seam. With the development of larger and more efficient power shovels, this type of mining is increasing in importance in the United States as a whole. The economical limit of the depth of overburden that can be removed depends upon local conditions, but

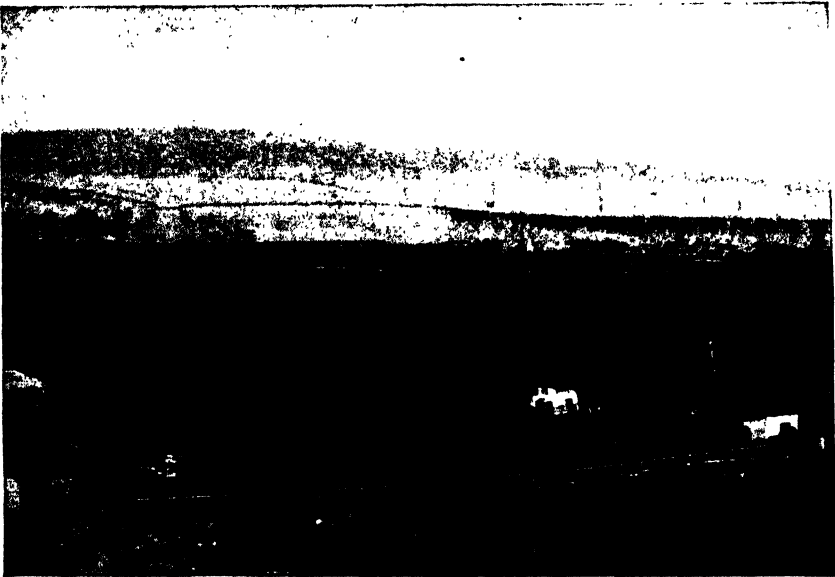

FIG. 1.—A strip mine in Wyoming. (Courtesy of U.S. Bureau of Mines.)

workable depths may reach 50 ft or even more in exceptional cases (Fig. 1).

Openings to underground mines include drifts, slopes, and shafts. A *drift* or *adit* (tunnel) may start on a hillside at the outcrop and follow a horizontal seam underground, or it may be the most convenient approach to a buried seam. A *slope* usually follows the natural dip of the coal seam (Fig. 2). A *shaft* is a vertical passage from the surface to the underground seam.

Quite a number of different methods and patterns are used in underground workings, depending upon the dip and the pitch (slope) of the seam, the thickness of the seam, and the characteristics of adjacent strata.

General patterns used in the workings are most easily visualized by

considering a seam that lies nearly horizontally. A large pillar of coal is allowed to remain around a shaft or slope opening of a mine where it penetrates a seam to be worked. Through this pillar, a few *main entries* or *gangways* are driven and are used for access to the *rooms* or *chambers* from which the coal is removed at the working *face*. The main entries are lighted, equipped with air ducts and frequently with tracks for mine cars and other utilities. *Cross headings*, *cross entries*, *butts* or *roads* are driven from the main entries. There are many variations of pattern of the cross headings and subsidiary workings. The two general patterns or systems are *room-and-pillar* and *longwall*.

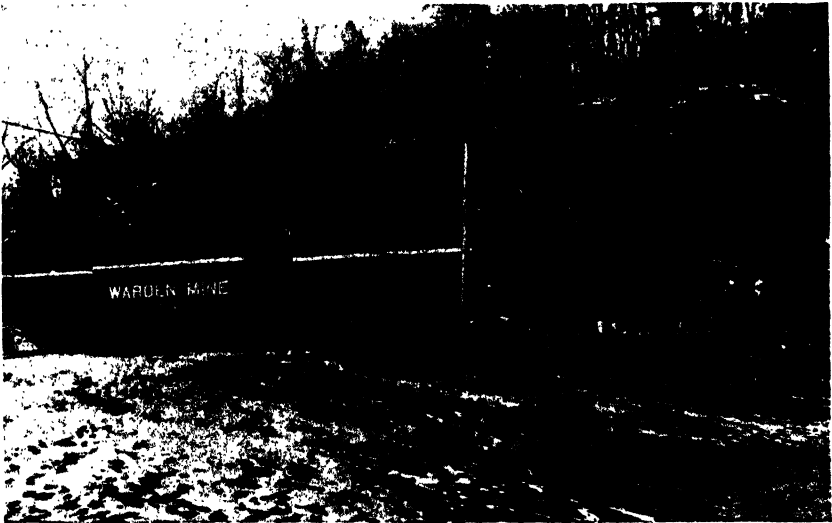

FIG. 2.—Slope opening to a Pennsylvania mine. (Courtesy of U.S. Bureau of Mines.)

In the room-and-pillar method, the coal is worked out to leave long, parallel rooms which open into cross entries. The pillars between the rooms serve to support the roof and are left intact until the desired depth of the rooms is attained. The pillars are then partly or almost completely removed, allowing the roof to cave. This operation is known as *robbing the pillars*.

In the longwall method, many subsidiary entries and roads are driven from the cross entries. The principal entries radiate from the shaft somewhat like the spokes of a wheel and subsidiary roads radiate from main and cross entries on a pattern similar to a fern leaf. Substantially all the coal is removed from the working area, and the roadways are maintained by *pack walls* built of rock loosened along with the coal or, less frequently, *stowage* brought into the mine for the purpose.

The exact pattern of both room-and-pillar and longwall workings is influenced by the dip or pitch of the seam. Pitching seams are always

worked in a direction such that the floor slopes upward toward the face so as to provide natural drainage and facilitate movement of the coal away from the face.

Methods of loosening coal from the seam include manual and machine cutting and blasting. The seam is usually undercut and the coal is then blasted down or, in the case of longwall mining and steeply pitching seams, it is allowed to loosen and fall by earth pressure.

In mines whose seams have a steep pitch, the loosened coal is sent down chutes or *batteries* to mine cars in the entries. Where seams are nearly horizontal, the coal is loaded manually or mechanically directly into cars or onto conveyors. With a conveyor system, it is not necessary for the cars to leave a main entry, and tracks may be laid, on which large cars or a train can be run. The cars are moved to the shaft or out of a slope opening by rope haulage, mules, or mine locomotives, and dumped directly into or conveyed to the *tipple* or surface works. Some *skip hoists* are in use, in which the cars are dumped into the skips at the entry so that the cars need not be hoisted.

The larger pieces of rock, slate, or shale ("gob") are left underground. In longwall mining, this material is essential to the construction and maintenance of the roadways and for filling the spaces from which coal has been removed.

PREPARATION

The greatest tonnage of coal mined is of bituminous rank, but anthracite is a very desirable domestic fuel and commands a high price. It is also relatively hard and tough. Because of these two factors, much more extensive *preparation* of anthracite than of bituminous coals is the rule. This may include breaking, sizing, and the removal of impurities.

A complete preparation plant for anthracite is known as a *breaker* and may serve more than one mine. The usual plant has many breaking, screening, and cleaning units to handle simultaneously the various sizes of coal. Pieces of slate and "bone" are picked out by hand from the coal as it passes along a conveyor or chute. It is first given a preliminary screening, a picking, and/or mechanical *tabling*; then the larger pieces are broken with toothed rolls, put through a series of smaller screens, and washed in a *jig* or *up-current classifier* which removes slate and other high-gravity impurities. The amount of breaking and screening done depends upon the demand for the various commercial sizes of the product.

Bituminous coal is much more friable than anthracite, and breaking operations produce unwanted fines. Much bituminous coal is marketed as "run-of-mine," which includes all sizes from large lumps down to fines. The preparation of bituminous coal at many of the smaller mines consists merely of hand picking and screen sizing in a *tipple* located

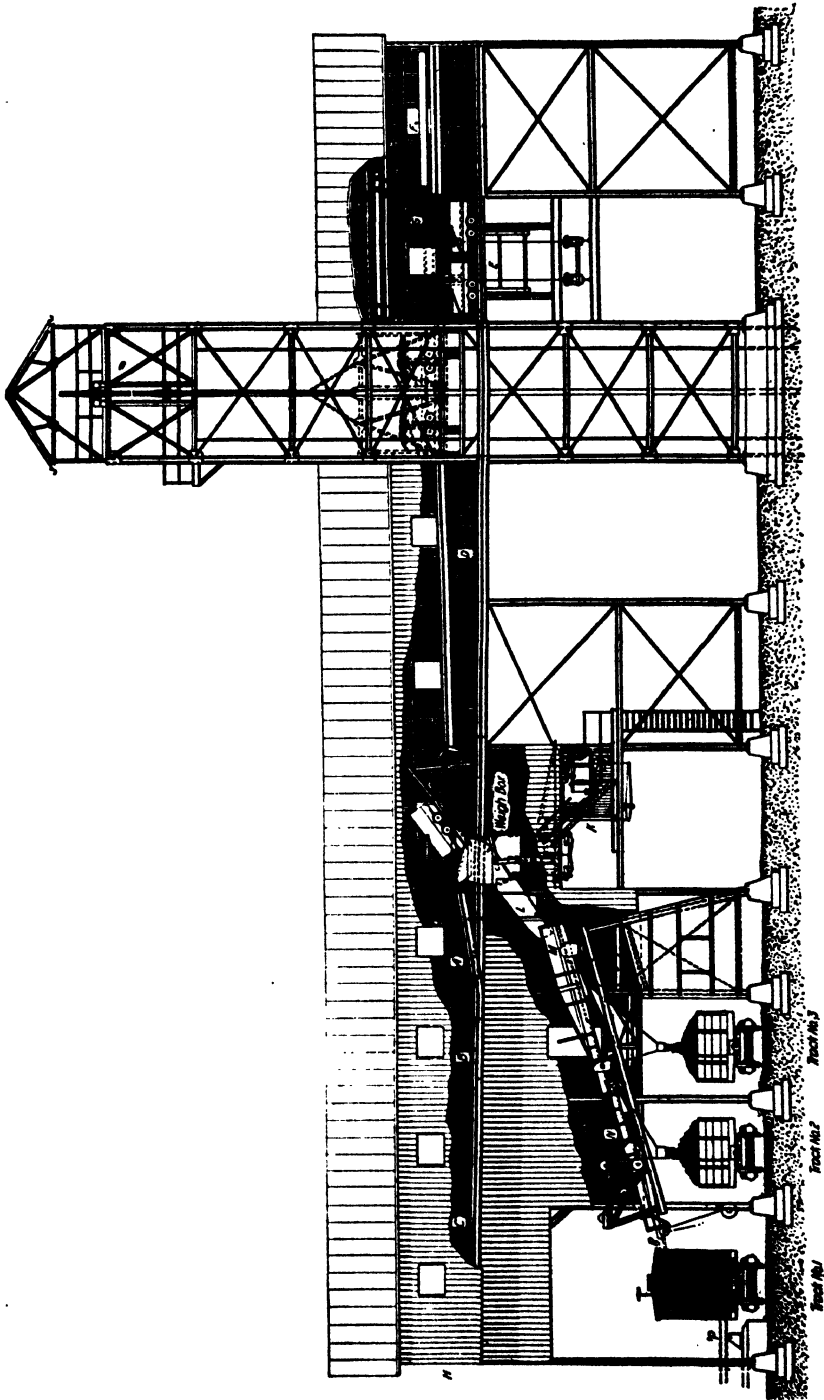

FIG. 3.—A tippie over a bituminous shaft mine. (Courtesy of E. A. Holbrook.)

directly over the mineshaft. From the tippie, the coal is usually loaded directly into railroad cars for shipment, or merely for convenience in moving it to local storage (Fig. 3).

Cleaning of bituminous coal is practiced at some mines, the most extensive operations being in the states of Pennsylvania, Virginia, Illinois, and Alabama. Cleaning reduces the ash content, and with it much of the pyritic sulfur. Wet methods of cleaning also remove soluble

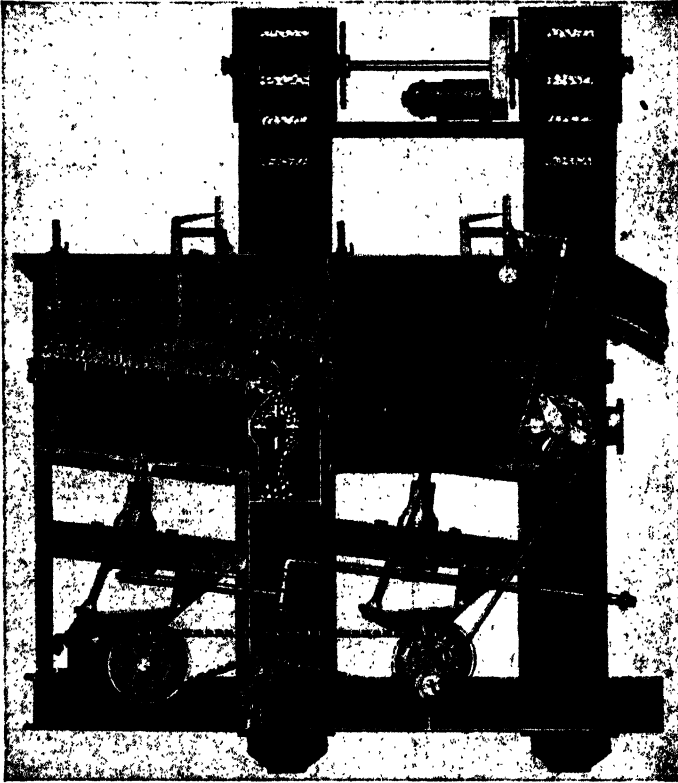

FIG. 4.—Diaphragm jig with automatic regulation. (Courtesy of Jeffrey Manufacturing Company.)

salts, and this treatment may raise the fusing point of the ash as well as reduce the percentage of ash. More than 80 per cent of the bituminous coal cleaned is washed. Hydraulic jigs and launders are used for this purpose.

The jig is a classifier which maintains a *suspension* of material in water so that the solid particles are free to move about. It has a heavy screen which forms a bed for the solids, and along which the fuel passes while separation of the coal from impurities takes place. In one type of jig, the *screen* is given a controlled reciprocating motion, whence its

name. In another type, a power-driven plunger or diaphragm imparts a pulsating movement to the water which is transmitted through the screen, thus maintaining the suspension. As the material moves along the screen, segregation of coal and impurities occurs, fine impurities passing through the screen and settling out so that they can be removed. Larger particles of impurities are removed from above the screen but below the layer of coal (Fig. 4).

The intensity of the jiggling action is so regulated that the high-density particles settle out as though the suspension had a specific gravity between 1.4 and 1.6. The specific gravity of the coal is about 1.3, whereas that of the mineral impurities is over 2.0. Particles of coal have impurities attached to and included within them, preventing complete separation of impurities and causing the loss of some coal.

Dry tabling and pneumatic cleaning are done at a few mines. The dry methods are at present suited only to small sizes, $\frac{3}{4}$ in. or less. Float-and-sink methods of separation with heavy liquids are used for laboratory studies and are in the development stage for possible commercial application. Froth flotation as is practiced in metallurgy can be used to separate coal and impurities in the size range of "fines." This method is used to some extent in Europe.

ANALYTICAL TESTS

Tests performed upon coal and coke have to do with the commercial value, burning properties, and other criteria related to the suitability of the fuel for certain purposes. Many of these tests are not chemical analyses and do not give fundamental physical constants. It is nevertheless essential that different laboratories be able to obtain consistent and reliable test values on any given sample. To achieve this, the ASTM has developed very rigidly detailed apparatus and procedures for the sampling and testing of coal and coke.⁵

Samples for testing must first of all be representative and must also be properly handled and cared for. "Free moisture" is determined by air drying; the sample is then ground to pass a 60-mesh sieve and is thereafter kept in an airtight container. From the percentage of moisture lost by air drying, subsequent analyses may be calculated back to the "as-received" basis of original moisture content.

Proximate Analysis (D 271). For heating, steam generation, and other uses, several simple and rapid tests have been devised whose values are related to the performance of the fuel upon heating and burn-

⁵ "ASTM Standards on Coal and Coke."

Certain ASTM tests are summarized as to significance and general procedure in this chapter. Treatment here is not complete as to details given in the original source. These sections are intended for the convenience of those readers unfamiliar with the tests.

ing. From these is calculated the "proximate analysis" as summarized below:

1. *Moisture (M)*.—The loss in weight on heating of a 1-g sample in an oven at 104° to 110°C for 1 hr.

2. *Volatile Matter (VM)*.—The loss in weight of a 1-g sample heated in a covered crucible at 950°C for 7 min, with item (1) deducted.

3. *Ash*.—The residue from item (1) which remains after all the combustible material is burned out in a muffle furnace at 700 to 750°C.

4. *Fixed Carbon (FC)*.—Items (1) to (4) are all expressed as percentages, and the fixed carbon is the difference between 100 and items (1) + (2) + (3).

Other common analytical tests include sulfur content, fusibility of the ash, calorific value (heating value) of the fuel, and, less frequently, phosphorus in the ash.

Ultimate Analysis. Users of large quantities of coal desire more complete analytical information than is to be had from the above tests, for use in comparing and correlating properties of different coals. This takes the form of a chemical analysis with respect to carbon, hydrogen, oxygen, nitrogen, sulfur, and ash. The ASTM specifies the determinations carbon, hydrogen, and nitrogen under *ultimate analysis* and gives procedures for calculating oxygen by difference.

The *range* of values which includes most coals is shown in the accompanying table.⁶

PER CENTS BY WEIGHT
(As received)

Proximate analysis		Ultimate analysis	
Moisture.....	3-30	Carbon.....	50-95
Volatile matter.....	3-50	Hydrogen.....	2-5.5
Fixed carbon.....	16-93	Oxygen.....	2-40
Ash.....	2-30	Sulfur.....	0.5-7
		Nitrogen.....	0.5-3
		Ash.....	2-30

CLASSIFICATION OF COAL AS TO RANK

During the past century, many attempts were made to obtain a classification of coals according to geologic metamorphism (rank), in terms of certain numerical values from proximate and ultimate analyses. Proposed classifications have used volatile matter, fixed carbon, total carbon, hydrogen, and oxygen in various combinations. Although each system of classification placed samples of certain ranks in proper order,

⁶HASLAM and RUSSELL, "Fuels and Their Combustion," p. 24, McGraw-Hill Book Company, Inc., New York, 1926.

some systems would fail properly to classify high-rank coals and others failed when applied to low-rank samples. It finally appeared that two separate factors would be needed to classify properly all ranks. The system developed by Parr is quite satisfactory in the above respects, and the ASTM classification developed from it is in general use for North American coals.

Parr Classification of Coal.⁷ After extended study, Parr observed that mineral matter (Mm) had little if any relation to the rank of coal, hence a classification is best made on a *mineral-matter-free basis*. The moisture of the proximate analysis is also an extraneous variable. The remainder after subtraction of these items is the *dry, mineral-matter-free basis*. This residue is designated *pure* or *unit coal*, and on this basis the volatile matter and fixed carbon add up to 100 per cent. This is the basis of Parr's unit coal. High-rank coals were found to be well distinguished by either *volatile matter* or *fixed carbon*. On the other hand, low-rank coals were best distinguished according to the per cent of inert or *nonheating volatile* material. The latter is closely related to the oxygen content and to the heating value, which are inverse to each other.

On a plot of volatile matter against heating value (both on the unit-coal basis), data from hundreds of samples formed a narrow band along which boundaries of the various ranks could be located. This plot is Parr's classification.

Mineral Matter-Ash Relations. To obtain the *unit-coal* basis, Parr made the following approximations, which are justified by tests on many samples:

1. The mineral matter is composed of salts, iron pyrites (FeS_2), and hydrated clay or shale.
2. A fixed percentage may be assigned to the water of hydration in the mineral salts, clay, and shale.
3. Nearly all of the sulfur is present in the form of pyrites.

In the proximate analysis, the water of hydration is driven off and the pyrites burns to a residue of Fe_2O_3 . Using an average value for the water of hydration and item (3), the approximate relation may be derived,

$$\% \text{ Mm} = 1.08A + 0.55S \quad (1)$$

where A and S are percentages of ash and total sulfur, respectively. The per cent of *unit coal* or dry, mineral-matter-free material is then,

$$\% \text{ unit coal} = 100 - (M + 1.08A + 0.55S) \quad (2)$$

where M is the per cent of moisture of the proximate analysis.

⁷ PARR, S. W., The Classification of Coal, *Univ. of Ill. Exp. Sta. Bull.* 180 (1928). See also *U.S. Bur. Mines Rept. Investigation* 3572, June, 1941; *U.S. Bur. Mines Inf. Circ.* 7193, December, 1941.

Unit Volatile Matter. In the proximate analysis determination of volatile matter, the water of hydration of the mineral constituents is driven off and the pyrites decompose into FeS, with volatilization of half of the sulfur. This water and half of the pyritic sulfur are included in the figure for volatile matter. To convert the proximate analysis figure to the unit-coal basis, the relation is

$$\% \text{ dry, Mm-free VM} = \frac{\text{VM} - (0.08A + 0.4S)}{100 - (M + 1.08A + 0.55S)} \times 100 \quad (3)$$

ASTM Classification of Coals by Rank (D 388—38). The ASTM utilizes Parr's general method of classification in modified form. The physical tests designated as *agglomerating* and *weathering indices* and the

TABLE 1.—CLASSIFICATION OF COALS BY RANK
(Conforms to ASTM D 388—38)
All values reported on mineral-matter-free basis

Fixed carbon ^a (Dry basis) %	Volatile matter (Dry basis)	Numerical designation: (x—y)
98	<i>m</i> -Anthracite	2
	Anthracite	<i>x</i> = nearest whole % fixed carbon <i>y</i> = nearest whole Btu per lb/100
92	Semianthracite (Nonagglomerating)	8
86	Low-volatile bituminous	14
78	Medium-volatile bituminous	22
69	High-volatile bituminous <i>A</i>	31
	High-volatile bituminous <i>B</i>	14,000
	High-volatile bituminous <i>C</i> (either agglomerating or nonweathering)	13,000
	Subbituminous <i>A</i> (both weathering and non-agglomerating)	11,000
	Subbituminous <i>B</i>	9,500
	Subbituminous <i>C</i>	8,300
	Lignite (consolidated)	
	Brown coal (unconsolidated)	

^a Samples having borderline values are classed in higher bracket.

condition of *consolidation* were added to differentiate between samples of adjacent ranks and subgroups that sometimes overlap in the numerical classification of lower-rank materials.

The *agglomerating index* is obtained by examination of the coke button obtained from the volatile matter determination. The *weathering* or *slacking index* is summarized in a later paragraph.

By means of Eq. (3), since

$$\% \text{ dry, Mm-free FC} = 100 - (\% \text{ dry, Mm-free VM}),$$

it may be shown

$$\% \text{ dry, Mm-free FC} = \frac{100 (\text{FC} - 0.15S)}{100 - (M + 1.08A + 0.55S)} \quad (4)$$

The ASTM uses the calorific value calculated to the *moist*, mineral matter-free basis for its classification. Thus,

$$\text{Moist, Mm-free Btu} = \frac{100 (\text{Btu} - 50S)}{100 - (1.08A + 0.55S)} \quad (5)$$

The term 50S is a correction for the heat of combustion of pyrites. The variables (other than Btu) in the right-hand sides of Eqs. (4) and (5) are percentages on the *as-received* basis, as commonly reported. The ASTM classification is summarized in Table 1.

ASTM Classification of Coals by Grade (D 389—37). Other tests which are unrelated to the rank of coal have to do with its *furnace quality*. These tests include size designation, calorific value, per cent ash, ash-softening temperature, and per cent sulfur. Note that these are dependent upon mine and preparation operations: breaking and sizing, removal of extraneous rock, shale, and clay, air cleaning or washing, tabling, jigging, and flotation treatments.

EXAMPLE OF NUMERICAL GRADE DESIGNATION*

Size	Calorific value, Btu per lb per 100	Ash, max %	Ash-softening temp, min, °F per 100	Sulfur, max %
2-4 in.	132	A-8	F-24	1.6

* Reprinted from Sec. 3a of designated test.

NOTE: The above example of grade classification indicates a coal of 2 to 4 in. size designation, having a calorific value of approximately 13,200 Btu, an ash of 6.1 to 8.0 per cent, an ash-softening temperature of 2400 to 2590F, inclusive, and a sulfur content of 1.4 to 1.6 per cent.

These designations, including the ranges of values, are summarized in Table 2. When the numerical values of classifications by both rank and grade are reported, the two values of the *classification by rank* are always given first.

SUMMARY OF CERTAIN OTHER TESTS ON COAL AND COKE

There are a number of other ASTM tests which were developed for making purchasers' specifications on fuels to be used for certain purposes. Most of these others are of physical characteristics related to the service properties required of the fuel. Several are summarized in the following paragraphs.

Agglutinating Value (D 547—39T). This test gives information about the caking and coking properties of the coal. A small sample is mixed with silicon carbide and carbonized to give a button which is then subjected to a compression test. The results are reported in terms of kilograms crushing strength.

Weathering or Slacking Index (D 388—38, Sec. 8). A screened sample is air-dried, immersed in water, and air-dried a second time. The disintegration is computed from a second screen test. The results are given as *per cent undersize material formed*.

TABLE 2.—CLASSIFICATION OF COALS BY GRADE
(Conforms to ASTM D 389—37)

All values reported on as-sampled basis

1. *Size Designation (y X x in.):*

y = upper limit (large size): The smallest screen which retains less than 5% of total sample.

x = lower limit (small size): The largest screen which passes less than 15% of total sample.

Large screens: Plates containing round holes of designated size, 8 in. max., 3/8 in. min.

Small sieves: Woven-wire cloth, square openings. Size of opening [(1/sieve No.)—wire dia], in. No. 4 max, No. 200 min.

(Surface moisture dried off coal before screen tests, if present.)

2. *Ash-content Designation (value to nearest 0.1%):*

% Ash ^a	0	4.05	6.05	8.05	10.05	12.05	14.05	16.05	18.05	20.05
Symbol.....	A 4	A 6	A 8	A 10	A 12	A 14	A 16	A 18	A 20	A 20+

3. *Softening Temperature of Ash (value to nearest 10°F):*

°F ^a	2000	2195	2395	2595	2795
Symbol.....	F 20—	F 20	F 22	F 24	F 28

4. *Sulfur Content (value to nearest 0.1%):*

% S ^a	0	0.75	1.05	1.35	1.65	2.05	3.05	5.0
Symbol.....	S 0.7	S 1.0	S 1.3	S 1.6	S 2.0	S 3.0	S 5.0	S 5+

5. *Calorific Value^a (nearest whole Btu per lb divided by 100).*

^a Samples having borderline values are classed in higher bracket.

Grindability (D 408—37T, D 409—37T). These tests give figures related to the grinding energy required to pulverize coal. Two methods are in use: In the *ball-mill method*, a sample is ground in a ball mill until 80 per cent passes a No. 200 sieve, the mill revolutions required being calculated from several trials. In the *Hardgrove method*, a prepared sample is given 60 revolutions in a miniature pulverizer, and the amount passing a No. 200 sieve determined. The results of the tests are reported as arbitrary indices:

$$\text{Ball-mill grindability index} = \frac{50,000}{\text{av no. of revolutions}}$$

Hardgrove grindability index

$$= 13 + 6.93 (\text{wt sample minus wt retained on No. 200 sieve})$$

There is a uniform relation between numerical values of the two methods for a given sample.

Drop-shatter Tests (for coal, D 440—37T; for coke, D 141—23). These tests give an index of the stability or resistance to breakage of the fuel. Breakage occurs in ordinary handling such as loading, unloading, and shipping.

Prepared samples are dropped from a height of 6 ft onto a steel plate according to specified procedures. Coal is dropped twice, coke four times. Screen tests are made on the dropped samples. In the case of coal, a *size-stability index* is computed—a value of 100 indicating no breakage.

Tumbler Tests (for coal, D 441—37T; for coke, D 294—29). These tests give values of relative friability. Smaller lumps are used than in the drop-shatter tests. Prepared samples are tumbled by rotation in a standard jar or drum apparatus, and screen analyses are made upon the tumbled samples. In the test on coal, a *friability factor* is computed—a value of zero indicating no breakage. In the test on coke, the percentage of the total tumbled sample retained on the 1.06-in. sieve is designated as the *stability factor*, and the percentage of total tumbled sample retained on the 0.265-in. sieve is designated as the *hardness factor*. Thus, the hardness factor is always larger than the stability factor.

GENERAL REQUISITES FOR THE MAJOR USES

Many furnaces can burn coals of a rather wide range of ranks and grades. As a consequence, efficient combustion and convenience of firing are often compromised in order to use a low-grade low-priced fuel. The small consumer too often considers little else than the price per ton. The result of failing to consider quality is that the cleaning of coal at the mine is not practiced to the extent it might be.

Domestic Applications. Most domestic furnaces have hand-fired grates, and most of these are not continuously attended. All varieties

and grades of fuel are used, but the consumer prefers a fuel that does not tend to smoke. Caking coals which can be banked to burn slowly over a period of several hours without attention are also convenient. No single fuel is both entirely smokeless and caking. Also, if the ash-softening temperature is below F22, some trouble will be experienced with clinkering.

In certain urban areas, smoke and soot have become such nuisances that antismoke ordinances have been passed. Although care in firing can greatly reduce smoke, the domestic user who does not have a fireman or janitor in constant attendance is then virtually faced with the choice of installing a domestic stoker or using a low-volatile fuel. There are, however, other factors besides per cent volatile matter and care in firing a grate that determine the amount of smoke produced—both in fuel characteristics and in grate and furnace design.

Domestic stokers can burn a lower *rank* coal more efficiently than is possible with a hand-fired grate. However, the stokers require a sized fuel of somewhat higher *grade* and are sensitive to low-fusing ash.

Anthracite coal is an excellent domestic fuel, but its premium price, localized occurrence, and limited production restrict its use. A recent symposium gives present practices and late developments in special methods of converting bituminous coals into low-volatile, smokeless fuels.⁸ High-temperature coke is used for domestic heating chiefly in the vicinities of coke-oven plants.

Industrial Furnaces. Industrial furnaces are generally larger and more closely attended than domestic units. They may be designed for burning any rank and grade of fuel. Large industrial stoking furnaces are designed for the particular rank of fuel most readily available. For a properly designed installation, efficient smokeless combustion is a matter of intelligent firing.

Pulverized-coal units are susceptible to low-fusing ash, which may accumulate on boiler walls and cause trouble. Almost any pulverized-coal furnace can be fired to a higher capacity with fuel having a high-fusing ash than is possible with fuel having a low-fusing ash. High per cent volatile is desirable for use in these units (see Chap. XI).

Coking and Gas Making. The overall requirement of a coking coal is that it make a satisfactory coke by conventional coking processes. Requisite properties of coke are strength, cell structure, and a minimum of impurities. Troublesome impurities are chiefly sulfur, ash, and, for metallurgical coke, phosphorus. ASTM specifications for coking coal are given in Table 3.

Fuel gas made from coal includes "coal gas" and "water gas." Most of the coal gas comes from *byproduct coke ovens*, although some small

⁸ *Ind. Eng. Chem.*, **33**, 835-864 (1941).

ovens and *gas retorts* were installed for the primary purpose of making gas. The latter installations must also market the coke to be financially successful. Water gas to be used as city supply is made from coal or coke, or a mixture of the two. Coal used as water-gas generator fuel makes richer gas than does coke, since coal releases methane and higher hydrocarbons into the gas. Hence a minimum percentage of volatile matter is specified for gas coal.

TABLE 3.—SPECIFICATIONS ON COAL AND COKE FOR CERTAIN USES
(Conforms to ASTM D 166—24)

	Volatile matter, dry basis	Ash	Ash-fusion temp	Sulfur in dry coke	Sulfur in gas from	Coke from coal
Gas coal. . . .	35% min ^a	9% max ^b	Over 2300	1.5% max	30 grains per 100 cu ft max ^c	Suitable for domestic use or manufacture of water gas
Coking coals.	Subject to agreement	9% max ^b	2200 min	. ^d	30 grains per 100 cu ft max. ^e	Size, strength, and structure subject to agreement ^f

^a On moisture- and ash-free basis. Also moisture, 4% max.

^b On dry basis.

^c In gaseous compounds other than H₂S. (Applies only to gas for domestic use.)

^d For foundry coke, 1.0% max. For blast-furnace coke, 1.3% max.

^e Also, max % phosphorus, subject to agreement.

Only a small amount of sulfur is permissible in city gas supplies, since cookstoves and certain small heaters release the combustion gases indoors. Sulfur in the gas occurs principally in the form of hydrogen sulfide. Gas plants remove the hydrogen sulfide, but elimination of other sulfur compounds is more difficult and requires a special process. This is the reason for the specification *applied to gas coal* that the gas made from it must not contain more than 30 grains of organic sulfur (in compounds other than H₂S) per 100 cu ft (see Chap. VIII).

Mobile Power. Although many locomotive and marine power plants burn oil, sizable quantities of coal are still consumed by trains and ships. Since it is important that dead weight and space be kept to a minimum here, an extra price premium is justified on coals low in oxygen plus ash for these uses.

Storage and Spontaneous Combustion. Coal oxidizes slowly when exposed to air. If heat from oxidation is generated more rapidly than it is dissipated, the temperature rises, oxidation accelerates, and spontaneous combustion occurs.

Porous and high-sulfur coals give the most trouble, particularly when damp. Since oxidation occurs principally at particle surfaces, *pulverized coal* having these characteristics is very susceptible to oxida-

tion and will usually ignite if allowed to stand undisturbed for two or three days.

A number of methods for preventing spontaneous combustion of stored coal have been tried, and all are usually successful.⁹ The more common methods are to keep the piles small or to store the fuel under water, in pits or in bins and silos that are substantially airtight at the bottom and sides. However, if the coal is spread and rolled as horizontal layers rather than dumped into conical or wedge-shaped piles, segregation of large and small particles does not occur. Irregular passages allowing "chimney effects" by which air and gases can travel up through a pile are substantially eliminated, and danger of spontaneous combustion is greatly reduced. Coals that have given trouble when dumped into piles have been successfully stored over long periods when laid down as flat layers. This does not limit the height of the pile.

COKING OR CARBONIZATION

The purposes of coking operations are

1. To make metallurgical coke (by-products may or may not be recovered).
2. To make fuel gas.
3. To make gas, domestic coke, or smokeless fuel, and to recover liquid by-products.

Not all coals are suitable for coking and, if the coke is not of marketable quality, coking operations are not feasible. By far the greater portion of the coal coked is by the high-temperature beehive and byproduct-oven processes. Byproduct ovens handle more than 90 per cent of the total of these two. Of the total high-temperature coke, about 65 per cent is consumed by blast furnaces, somewhat less than 15 per cent goes to domestic uses, and miscellaneous metallurgical processes consume most of the remainder.

Coking Mechanism. As coal is heated above 100°C, moisture and adsorbed gases are driven off. Decomposition of the coal substance starts at about 200°C, with loss of oxygen in the form of water, CO, CO₂, and organic compounds. Partial or complete fusion accompanies decomposition, the entire mass becoming plastic in the case of coking coals. Hydrogen, carbon monoxide, and methane are formed at 700 to 750°C. About half of the total nitrogen escapes as elementary nitrogen, ammonia, and ammonium compounds. Half of the pyritic sulfur is released and is immediately reduced to hydrogen sulfide. Other sulfur compounds are found in the gas, chiefly carbon bisulfide. Twenty-five to 40 per cent of the total sulfur comes off in the gas, the rest staying in the coke, which often has about the same sulfur percentage as the

⁹ BARKLEY, J. F., *U.S. Bur. Mines Inf. Circ. 7235*, February, 1943.

original coal. The gas consists chiefly of hydrogen and methane with small amounts of higher hydrocarbons (illuminants) and various other substances as discussed later.

The gas formed in the early stages of coking has a higher heating value than the gas formed during the late stages, and formerly the rich and lean gases were sometimes segregated. This practice has been discontinued. A publication concerning the general mechanism of coal pyrolysis has appeared.¹⁰

The mass swells as it becomes plastic, then slowly solidifies. To make uniform coke of the required characteristics, high- and low-volatile coals are broken to small size (80 per cent under $\frac{1}{8}$ in.) and mixed in controlled proportions. Low-volatile coal usually swells excessively but gives a high yield of coke. The coals must be selected and blended with great care so that the charge will not exert dangerous pressure on and damage the oven walls during carbonization. Small coal-expansion test ovens are used for control testing of the mix. These considerations set compositional limits to the oven charge. Relative costs of the various coals, yields, and value of the products then determine the most desirable proportions. An oven charge often tests about 33 per cent VM.

There are two general temperature *ranges* used in coking or carbonization processes. In *low-temperature coking*, the product is heated to a final temperature between 450 and 700°C. In *high-temperature coking*, the final temperature is between 1000 and 1200°C. The quantity and character of products from the two operations are quite different. *Metallurgical coke* can be made only by a high-temperature process. *Low-temperature coke* is used as smokeless fuel.

Beehive Ovens. Beehive ovens are the simplest and were the first type to be developed. They are used solely for the manufacture of metallurgical coke. All of the gas formed is burned inside the oven and furnishes heat for the coking process. These ovens are built in circular and also in rectangular shapes of fireclay or other refractory brick. The oven of typical size is charged with 5 to 6 tons of coal, which is spread on the hearth as a bed 24 in. in depth. Residual oven heat initiates decomposition and ignition of the charge and the gas is burned immediately above the bed of coal by admission of a controlled amount of air. The heat slowly travels downward through the bed, and coking is completed on a 48- or a 72-hr schedule. When coking has been completed, quenching water is sprayed on the coke while still in the oven; then the quenched coke is "drawn." Circular ovens are hand-raked, while rectangular ovens (built in a battery) usually have doors at either end and are discharged by a traveling mechanical pusher. Beehive coke is hard and has

¹⁰ FUCHS and SANDHOFF; *Ind. Eng. Chem.*, **34**, 567 (1942).

a silvery luster, but the yield is 5 to 10 per cent lower than that obtained from the byproduct ovens in which the charge is heated indirectly.

Combustion gases from some beehive-oven batteries are collected into a common flue and passed through a waste-heat boiler to generate steam. About 1800 Btu/lb of coal coked are recovered as steam by this means.

Beehive ovens are cheap and easy to construct, but their low yield of coke and inability to recover by-products cause them to be used chiefly for meeting peak and seasonal demands for metallurgical coke. When the demand is slack, they fall into disuse; almost all of the coke is then made in byproduct ovens. During the 1930 business depression, beehive ovens were used as houses by unemployed workers. Owing to recent heavy wartime demands for metallurgical coke, new beehive-oven batteries have been built for the first time in more than twenty years.

Byproduct Ovens. In byproduct ovens, the coal is coked by heat transmitted through the oven walls. The heat is furnished by burning 35 to 40 per cent of the total oven gas. The yield of coke is about 5 per cent higher than the (FC + ash) values of the proximate analysis of the charge.

The typical byproduct-oven battery contains 30 to 90 ovens (constructed of silica brick in the United States, firebrick in Europe). In a number of the new units, the oven proper is about 40 ft long, 13 ft high, 16 in. wide at the pusher end, and tapered slightly so that it is about 3 in. wider at the discharge end. It is charged to within a foot of the top with about 18 tons of a crushed and sized mixture of high- and low-volatile coal. Earlier ovens were built both larger and smaller.¹¹ The battery is constructed as alternate ovens and heating flues. The flues heat the side walls of the oven to a temperature of about 2200°F (1200°C). Carbonization starts at the walls, progresses toward the center, and is complete in about 17 hr. Since there is considerable thermal expansion or contraction of a long oven battery upon heating or cooling, the ovens must be kept hot to avoid damage. When the coke demand is slack, the throughput of the battery is reduced by allowing the coke to remain in the oven for a longer period.

The charging and discharging are done on a regular schedule, so that all ovens are of the same coking age at the time they are discharged. A traveling mechanical pusher discharges the oven, the hot coke falling into a car, where it is quenched by a water spray, then dumped from the car onto an inclined "wharf" where it is allowed to cool. From the wharf it is conveyed to screens. Five to ten per cent of the material is less than ½ in. in size. This is known as coke breeze. It may be burned in the plant boilers or used for fuel in gas producers.

The gas is cleaned and debenzolized, and part of it is usually con-

¹¹ "Koppers-Becker Coke Ovens," Koppers Co., Pittsburgh, Pa., 1944.

sumed as fuel for firing the ovens. The remainder is marketed or consumed elsewhere in the plant. It is profitable to market as much of the coal gas as possible. When a sufficient demand exists, coke ovens that are equipped with regenerators to preheat air and fuel can be fired with low Btu *blast furnace gas* (where available) or *producer gas* made in the plant for this purpose.

BYPRODUCT RECOVERY

A flowsheet of a byproduct oven and recovery plant is shown in Fig. 5.*

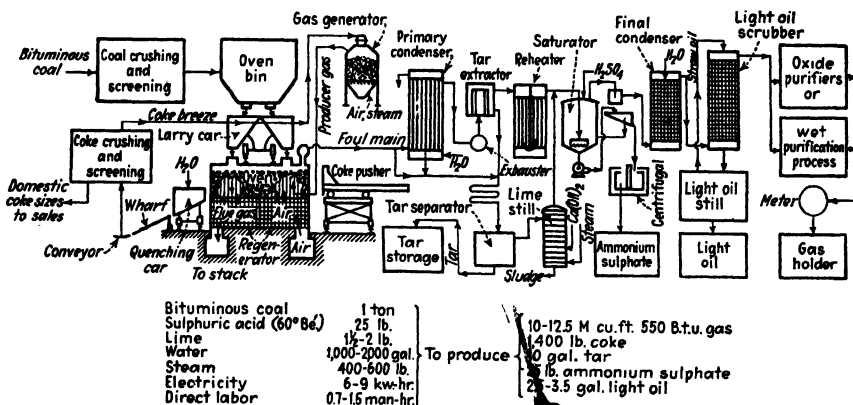

FIG. 5.—Flowsheet of typical byproduct coke-oven operations. (Courtesy of Chemical Metallurgical Engineering.)

Ammonia.—The oven gas contains water vapor, ammonia and other nitrogen compounds, sulfur compounds, volatile hydrocarbons, suspended tar, coal dust, and soot. The take-off or “ascension pipe” from the top corner of each oven opens into a large pipe or main, designed as the *collecting main*. The gas in the main is cooled by heat loss from the main and also by internal sprays of ammoniacal liquor. This washes out dust and suspended tar. As the gas cools, tar and water condense, and ammonia dissolves in the liquor. The collecting main ends in a sump from which a portion of the aqueous liquor is recirculated to the sprays. The gas take-off from the sump is designated as the *suction main* and leads to the *primary cooler*, which in some plants is a direct-contact scrubber and in others is a vertical shell-and-tube heat exchanger. (In plants that make aqua ammonia the scrubber is a direct-spray tower circulating dilute ammonia liquor.) The gas enters the cooler at about 75°C and is cooled to about 30°C.

A centrifugal exhauster has drawn the gas from the ovens up to this point, and furnishes a 65 to 70 in. H₂O pressure differential as required

* A detailed elevation flowsheet is given facing p. 442 (Folder A).

to move the gas through the entire system. Tar fog is still present in the gas through the exhauster pump and is finally eliminated by a high-voltage electrical precipitator. The cleaned gas is passed through a "saturator" which is fed with 60°Bé sulfuric acid. The gas is bubbled through the acid bath liquid which absorbs the ammonia as ammonium sulfate. The bath liquid is actually a saturated ammonium sulfate solution containing about 5 per cent acid and 45 per cent ammonium sulfate. The sulfate crystallizes out and the crystals are removed, drained, centrifuged of liquor, and stored.

Ammoniacal liquor from the mains, sump, and primary cooler is treated with milk of lime. The free NH_3 is distilled out and added to the gas stream entering the saturator.

Hydrocarbon Recovery. The gas leaving the saturator is cooled to about 25°C and passed through the *benzol scrubber*. This absorbs the heavier hydrocarbons from the gas in *straw oil*. The straw oil is debenzolized in a steam stripping still and recirculated. The light oil is condensed and may be treated in various ways depending upon whether pure benzene, toluene, and xylenes are to be manufactured, or the oil is to be used for "motor benzol." About 95 per cent of the total light aromatic hydrocarbons are recovered from the gas, and only about 5 per cent are found in the tar.

The tar is often burned as fuel. Several of the larger plants distill the tar and manufacture additional by-products. The principal products obtained from tar distillation and subsequent treatment of the products are summarized in Table 4.

Until very recently, the byproduct coke industry furnished practically the entire supply of benzene, toluene, and xylenes. During the war, the supply of coke-oven toluene was inadequate to meet the heavy wartime demand and was supplemented from petroleum sources.

Coal tar contains innumerable individual hydrocarbons, organic acids, and nitrogen bases. Quite a number of important chemical industries recover a few pure compounds from coal tar and use them as chemical intermediates for synthetic products.

LOW-TEMPERATURE COKING

Carbonization of coal by low-temperature processes results in a lesser degree of decomposition of the coal substance, with resulting differences in the quality and quantity of products obtained. The solid residue is often termed *semicoke*. It contains a considerable amount of volatile matter, is unsuitable for metallurgical purposes, but is an excellent smokeless fuel.

Operating costs of low-temperature carbonization processes are higher than for the high-temperature operation, and the value of the products

TABLE 4.—DISTILLATION OF HIGH-TEMPERATURE COAL TAR

	Distillates, °C				Residue	
	To 170	70-235	235-270	270-355	From 270	From 355
Primary fraction.....	Light oil (and water) 0-3%	Middle oil (carbolic oil, naphthalene oil) 5-15%	Heavy oil (creosote oil) 8-12%	Green oil (anthracene oil) 16-20%	Soft pitch	Hard pitch
Composition of primary fractions	Aromatic hydrocarbons, phenol, cresols, pyridine	Phenol, cresols, naphthalene	Phenol, cresols	Anthracene, phenanthrene, carbazole		
Principal products by redistillation, blending, and/or other treatments	Motor benzol, solvent naphthas, benzene, toluene, xylenes, phenol, pyridine	Naphthalene, creosote, phenol, cresols	Creosote, phenol, cresols	Wood preservative, anthracene, phenanthrene, carbazole	Paving, waterproofing compounds, etc.	Protective coatings, electrical insulation, binding compounds, etc.

obtained has not permitted extensive use of low-temperature coking in the United States.

In England, much higher prices of petroleum and natural-gas fuels have permitted a slow but steady growth of low-temperature carbonization by the *Coalite process*. In this process, the fuel is carbonized in small vertical cast-iron-pipe retorts, to a temperature of about 600°C during a period of 4 to 6 hr.

A comparison of products from the high- and low-temperature coking of a ton of coal is summarized in Table 5.

TABLE 5.—A. PRODUCTS FROM COKING 1 TON OF COAL^a

	High temp	Low temp
Temperature ranges, °C.....	900–1,200	450–700
Coke yield, %.....	60–70	70–80
VM in coke, %.....	1–2	7–15
Total gas, cu ft.....	10,000–12,000	3,000–5,000
Surplus gas, %.....	55–65	
Heating value of gas, Btu per cu ft.....	520–580	800–900
Tar, gal.....	8–12	20–30
Sp. gr. of tar.....	1.2	1.1
Light oil, gal.....	2.5–3.0	2.5–3.0
Ammonium sulfate, lb.....	20–25	10–12

B. TYPICAL ANALYSIS OF GAS FROM HIGH- AND LOW-TEMPERATURE PROCESSES

	CO ₂	O ₂	CO	N ₂	H ₂	CH ₄	Unsat as C ₂ H ₄	C ₆ H ₆	Btu, approx
High-temp ^b	1.6	0.5	7.8	9.0	51.5	27.0	1.6	1.0	530
Low-temp (not de- benzolized) ^c	8.2	0.2	6.2	2.0	17.5	49.4	4.2	12.3	860

^a U.S. Bur. Mines Tech. Paper 396 (1926).

^b Koppers Co., private communication, 1943.

^c U.S. Bur. Mines Tech. Paper 512 (1932).

CONVERSION OF COAL INTO LIQUID FUEL

Coal and coal tar are hydrogenated in European plants for the purpose of producing gasoline (the Bergius process). Essentially, the operation consists of drying and pulverizing the fuel, dispersing it in heavy "cycle oil" from the process, mixing with a catalyst, and then hydrogenating at 300 to 450°C under 200 to 700 atm pressure. The hydrogen is often obtained by conversion of hydrocarbon gas formed in the reaction.

An oil of wide boiling range is produced, which contains 15 to 30 per cent of material boiling within the gasoline range. The oil is fractionated to separate the light gasoline, and the higher boiling fractions are cracked, reformed, and/or destructively hydrogenated to increase the ultimate

yield of gasoline. The residual high-boiling oil with any other tar is returned to the process for further hydrogenation. Thus the coal substance of the charge is converted almost quantitatively to gasoline and gas.

Gasoline is also manufactured on the Continent by the Fischer-Tropsch process. This involves converting the coal into water gas, which is then catalytically converted into a mixture of hydrocarbons. These processes require somewhat more than 2 tons of brown coal or about half of this amount of high-grade bituminous coal per barrel of motor fuel produced. The Fischer-Tropsch process operates at low pressure and does not require heavy-pressure equipment. However, the light oil is of very low octane number and must be further converted for use as motor fuel.

In the United States, neither process has been able to compete with petroleum financially. The U.S. Bureau of Mines has maintained a Bergius-type pilot plant so that up-to-date information for the construction of full-scale plants will be available whenever needed.

Supplementary References

General:

1. LOWRY, H. H., editor: "Chemistry of Coal Utilization," Vols. I and II, National Research Council Committee, John Wiley & Sons, Inc., New York, 1945.

On occurrence and mining:

2. MOORE, E. S.: "Coal," 2nd ed., John Wiley & Sons, Inc., New York, 1940.

On coal tar:

3. DODGE, F. E.: "Rogers' Industrial Chemistry," 6th ed., Vol. I, Chap. 16, D. Van Nostrand Company, Inc., New York, 1942.

On coal gas:

4. "Gas Engineers' Handbook," Sec. V, 8-15, Pacific Coast Gas Association, McGraw-Hill Book Company, Inc., New York, 1934.

On analysis and testing:

5. PARR, S. W.: "The Analysis of Fuel, Gas, Water and Lubricants," 4th ed., McGraw-Hill Book Company, Inc., New York, 1932.

Exercises

1. a. What are the ranks of coal? How are they differentiated?
 b. Name the petrographic structures of coal, with their distinguishing characteristics.

2. Tests on a coal sample "as received" are

Moisture.....	3.4%	S.....	1.0%
VM.....	15.4%	H.....	4.4%
FC.....	75.5%	C.....	81.7%
Ash.....	6.1%	N.....	1.3%
Ash-softening temp.....	2590°	O.....	5.4%
		Dtu.....	14,240

- a.* What is the ASTM rank of the coal?
- b.* Give its ASTM grade classification.

3. What additional tests would have to be made on the sample of exercise 2 to determine its suitability for making metallurgical coke? Explain in detail, giving the reasons for the specifications.

4. Discuss briefly the effects of washing and jigging upon the analysis and properties of coal. Give the reasons for these treatments.

- a.* What are the principal differences in equipment and operating conditions for low- and for high-temperature carbonization?

- b.* What are the essential differences in the purposes of the two operations, and the differences in yield and properties of the coke and tar obtained?

6. Draw a block flowsheet of a byproduct coke-oven plant showing the principal units.

CHAPTER II

PETROLEUM AND NATURAL GAS

PART 1. OCCURRENCE AND CONSTITUTION

The great convenience of ashless fluids as fuels for both heat and motive power has given petroleum products an indispensable place in present-day civilization. However, the utilization of petroleum has gone far beyond the manufacture of conventional fuels and lubricants by standardized refining processes. The successful refinery of today must keep abreast of current developments in processes and products or it soon becomes obsolete and its operation unprofitable. New chemical and physicochemical processes for the manufacture of special fuels such as aviation gasoline, and for the production of individual hydrocarbons such as toluene, butadiene, and styrene are appearing at frequent intervals. Synthesis of organic chemicals from natural gas and petroleum hydrocarbons is of prime and growing importance.

SUPPLIES—PRESENT AND FUTURE

The amount of recoverable petroleum in the earth appears to be very small in comparison with the coal resources. Many of the earth's oil pools are not yet located, and estimates of oil reserves change considerably from year to year as affected by new discoveries, rates of withdrawal, and current methods of production, upon which depends the *ultimate recovery* of oil from a given pool.

During 1940, world production of petroleum was somewhat more than *2 billion barrels*, over 60 per cent of which was produced in the United States. As of Jan. 1, 1941, this country had an estimated reserve of *19 billion barrels*. Annual estimates of the United States reserves have increased since then but include upward revisions of recoverable oil from known fields as well as estimates from newly discovered pools. However, *consumption has steadily increased while the annual quantity found in new pools has decreased since 1937*. At the time of writing, reserves were decreasing. Unless an unexpectedly large amount of oil in new fields is found, the *highest ultimate recovery* of oil from existing pools can be obtained only if United States production is curtailed. The supply of oil may decrease, but it will not suddenly dry up. Petroleum and hydrocarbon products will be available for *centuries* to come. As flush oil production decreases, the price of crude oil and petroleum products must rise. This will stimulate further prospecting, increase the appli-

cation of secondary methods of oil recovery, and cause oil shale to be worked much more extensively. Gasoline and other hydrocarbon products will be made by synthesis from natural gas and eventually from coal. The 1942 reserve of natural gas was roughly equivalent (in terms of energy) to the reserve of petroleum, and gasoline may be manufactured at reasonable cost by conversion of the gas.

CONSTITUTION OF PETROLEUM

Petroleum is a highly complex mixture of hydrocarbons with lesser amounts of certain organic compounds of sulfur, oxygen, and sometimes nitrogen. Crude oils range from thin, almost water-white liquids (from "distillate pools") through liquids of various bodies and darker colors, to natural asphalts. The great majority of crude oils are dark liquids of intermediate properties whose color may be any shade from yellow through green, brown, and black (by reflected light). The color of a crude oil is due chiefly to small amounts of *color bodies*, although the opacity and blackness of a crude are a rough index of the amount of asphalt it contains. Color is only vaguely related to the *base* or general structure of the crude.

Structure of the Natural Hydrocarbons. There are three *structural types* of hydrocarbons present in all crude oils: paraffins, naphthenes, and aromatics.

The *paraffins* have the general formula C_nH_{2n+2} . Except in the lower members of the series, branched isomeric rather than straight-chain compounds predominate. All the isomeric paraffins through the hexanes (C_6H_{14}) have been isolated, as well as a number of heavier paraffins.¹

The *naphthenes* (cycloparaffins) have the general formula C_nH_{2n} . These contain only saturated ring linkages and have either five or six carbon atoms in each ring. The simplest members, cyclopentane and cyclohexane, have been isolated as well as some of the simpler alkyl naphthenes.

The *aromatics* contain benzene ring nuclei. A general formula may be written C_nH_{2n-x} , in which x varies with both structure and molecular weight. Benzene and a number of alkyl benzenes have been isolated from petroleum.

The heavier fractions which compose the bulk of crude oil contain certain amounts of paraffins but are chiefly molecules containing one or more rings having attached alkyl side chains. The rings may be connected to each other through one or more carbon atoms, such as in diphenyl, or in naphthalene or anthracene.² All types of rings and

¹ ROSSINI, F. D., *Proc. API*, **18**, III, 36 (1937); *Oil Gas J.*, **36** (26), 193 (1937); *Refiner Natural Gasoline Mfr.*, **16**, 545 (1937).

² ROSSINI, F. D., *Petroleum Eng.*, February, 1943, p. 43.

linkages may occur in a single molecule of sufficiently high molecular weight.

With the exceptions of *n*-paraffins and the lowest members of the other types, all molecules contain alkyl side chains. Most of the side chains are probably methyl groups, but it is certain that longer side chains exist. Possibly some rings are connected by chains. Molecules composing the bulk of *paraffin wax* contain one or two naphthene rings and long side chains. A class of compounds known as *asphaltenes* occurs in the higher boiling fractions of crude oil.* This material is unstable toward heat and oxygen, is highly unsaturated and very low in hydrogen content, but is not well understood as to exact structure.

Methane gas is the most abundant natural hydrocarbon and, with some exceptions, the abundance of the individual petroleum hydrocarbons decreases as the molecular weight increases. This is the result of two factors: the lower members of a hydrocarbon series are the more stable, and with increasing molecular weight the number of possible *structural isomers* increases extremely rapidly. In the range of high molecular weights, individual hydrocarbons exist only in very minute proportions.

Sulfur Compounds. All crudes contain a certain amount of sulfur in the form of organic compounds. *Elementary sulfur* and *hydrogen sulfide* are sometimes present. Types of sulfur compounds known to occur are *mercaptans*, *aliphatic* and *aromatic sulfides*, *thiophene* and *thiophane derivatives*.

The range of sulfur content of *crudes* is from a few tenths to several per cent of sulfur by weight. The corresponding percentages of the actual *sulfur compounds* are of course much greater. The sulfur contents in the *fractions from a given crude* generally increase with the molecular weight or boiling range of the fraction.

Sourness of a crude oil or a natural gas refers to its odor and corrosiveness due to sulfur compounds. It is a property of some types of sulfur compounds but not of others. Hydrogen sulfide and the lower mercaptans are chiefly responsible for sourness. High-sulfur crudes and natural gases are usually "sour," whereas low-sulfur oils and gases are almost always "sweet." (Sourness in gasoline and kerosine is detected by the *doctor test*, which is not closely related to odor or to corrosiveness.)

* One of the first and most important steps in the evaluation of a crude petroleum is to separate a sample into a series of narrow-boiling fractions or "cuts" by means of fractional distillation. The series of samples so obtained from any given crude oil shows a regular increase in boiling point, molecular weight, and specific gravity, all in the same order.

Since *boiling point* is closely related to *molecular weight* for fractions from a given crude, it is a convenience to use these two properties somewhat interchangeably in discussions of how a specific property changes with the various fractions. The foregoing applies to certain descriptive material in this chapter only.

Oxygen. Crude oils usually contain less oxygen than sulfur, although the two are unrelated. Oxygen appears chiefly in the form of organic acids. Although traces of aliphatic acids have been isolated, nearly all of the oxygen occurs in kerosine and heavier fractions as naphthenic acids. Heavy fractions may contain oxygen combined in the structure of resinous substances.

Nitrogen. Certain crudes (chiefly from California) contain minor amounts of a variety of *nitrogen bases*. Traces of other elements can be detected in some samples.

CHARACTERIZATION OR BASE OF A CRUDE OIL

The three structural types of hydrocarbons and nearly all the individual compounds (at least those which have been isolated) may be found in any sample of crude oil, irrespective of its source. That is, every crude contains paraffins, naphthenes, and aromatics. However, their *proportions* differ greatly in crudes from different sources. Several rather arbitrary designations used to distinguish the various types of crudes express *comparative* rather than *absolute* characteristics.

Paraffin-base crudes are composed principally of paraffins in the lighter fractions and of alkyl naphthenes in the heavier fractions. They always contain "paraffin wax," which is not, however, composed only of paraffin hydrocarbons. The asphalt content may range from a mere trace to an appreciable quantity. The sulfur content is relatively low. The specific gravity and viscosity are both relatively low, and the proportions of straight-run gasoline and of kerosine are usually high. These crudes occur chiefly in the Eastern parts of the United States. Pennsylvania and West Virginia crudes are all of this type.

Mixed-base crudes are lower in normal paraffins and higher in naphthenes than are the paraffin-base oils. Sulfur and asphalt contents are higher on the average. Mixed-base crudes contain wax, but their specific gravities and viscosities of the corresponding fractions are higher than for paraffin-base materials. Mid-Continent crudes are of the *mixed-base type*.

Naphthene-base crudes are characterized by a high percentage of naphthenes, a relatively high specific gravity and the virtual absence of wax. They may be subclassified into light and heavy groups, the light crudes containing a relatively high proportion of gasoline and little asphalt while the heavy ones contain little gasoline and are high in asphalt. Distillate from a heavy naphthenic crude is very similar or identical in general properties to that from a light crude. Various naphthenic crudes have widely different sulfur contents. They occur in Central, South Central, and Southwestern areas of the United States.

The term *asphalt base* is very indefinite and is not recommended for classifying crudes.

Aromatic crudes contain a relatively high percentage of the lower aromatic hydrocarbons. This type occurs chiefly in the state of California, and often has a fairly low specific gravity because of a high proportion of material in the lower molecular weight or gasoline range.

The U.S. Bureau of Mines procedure for testing crude oils includes a Hempel distillation upon the sample which is then classified as *paraffin*, *naphthene*, or *intermediate base* according to the specific gravities of fractions of designated boiling ranges.³

UOP Characterization Factor. The most useful characterization of crude oils and their various fractions is afforded by the Universal Oil Products Company's *Characterization Factor (UOP K value)*.⁴ This is defined as the *ratio of the cube root of the average boiling point in degrees Rankine to the specific gravity at 60°F*. Numerical values of the factor obtained from many samples range from about 12.5 for paraffinic stocks down to about 10.0 for aromatic materials. (The methods of obtaining the factor for a given sample and the uses of the factor are given in Chap. III.)

OCURRENCE OF PETROLEUM

The theory is generally held that petroleum was formed from vegetal material by certain metamorphic processes. There is a likelihood that the vegetal material and early stages of its transformation were similar to those which later resulted in coal. Petroleum is found in *geosynclines* of basin-shaped strata of sandstone, conglomerates, shale, or limestone. (Oil-bearing "sands" are porous. Studies of cores from drilling operations show porosities ranging from zero to about 40 per cent of total voids, with most samples having between 10 and 25 per cent of voids.)

Petroleum was not *formed* in the pools in which it is *found*. Geologic studies indicate that it migrated or was transported from the source bed or point of origin through porous strata. The migration resulted from the action of water in front of and behind the oil, and the movement was slow, extending over a period of many years. The oil finally accumulated in a slightly elevated structural trap or pocket, such as an anticline, dome, or faulted monoclinical structure (Fig. 1).

An oil reservoir is always overlain by dense, impervious *cap rock*, and in most pools, the reservoir contains gas in its upper portion. "Edge water" occurs in the same stratum at irregular distances from the structural crest of the reservoir, but in contact with the oil. "Bottom water" frequently occurs directly below the oil, and the oil-bearing portion of the sand often contains both water and oil in the same pores.

The initial pressure on an oil sand and on its connate water (with a few exceptions) is approximately equal to the hydrostatic head corre-

³ LANE and GARTON, *U.S. Bur. Mines Rept. Investigation 3279* (1935).

⁴ WATSON, NELSON, and MURPHY, *Ind. Eng. Chem.*, **27**, 1460 (1935).

sponding to the difference in elevation between the formation outcrop and the oil reservoir in the same stratum. Thus the initial pressures in deep pools are much greater than in shallow pools.

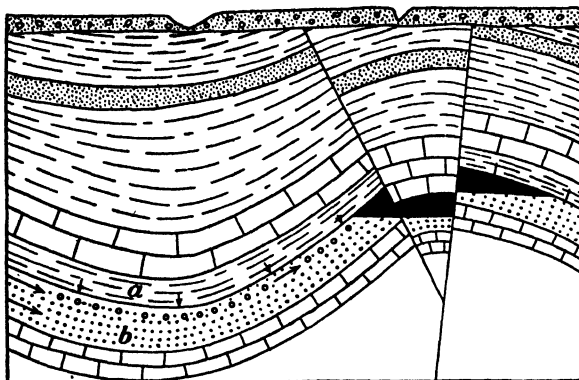

FIG. 1.—Hypothetical section through a faulted oil structure showing by arrows the supposed direction of migration and position of the oil pool, which is shown in solid black. *a*, source bed where oil originated; *b*, water sand through which oil migrated. (Courtesy of F. B. Plummer.)

PART 2. OILFIELD OPERATIONS

PETROLEUM PRODUCTION

To obtain oil, wells are drilled in the earth where its existence is suspected. Geologic data are employed to indicate suitable strata and structures where oil could accumulate. There are also newly developed and valuable *geochemical* and *geophysical* methods of prospecting which have greatly reduced the proportion of “dry holes” drilled in seeking new pools.

Both prospecting and drilling for oil have become comprehensive arts. After a drill has entered a productive horizon, several important *completion operations* must be attended to before normal production from the well is under way. The attempt is made to set the bottom entrance to the well at the richest part of the oil stratum—below the gas and above the water. The exact location may to a great extent determine the gas-oil ratio and the amount of water produced with the oil. The hole is cased with steel pipe, the bottom needs special preparation, and the well head or “Christmas tree” must be affixed. A string of smaller pipe (the tubing) is often run down inside the casing, and the oil produced through it.

At high pressures such as are often encountered in oil sands, the oil holds large amounts of gas in solution. At pressures over 1,000 psia, *hydrocarbon gases hold appreciable quantities of oil in the vapor phase also*. Thus there may only be a liquid phase in the sand, there may be both

When the case contains a gas, the gas density and hence the buoyancy on the bulb increase with the pressure of the gas, in accordance with Boyle's law. By adjusting the gas pressure in the case, a pressure is found at which the bulb and arm are balanced. A "balance pressure" is obtained with air in the case, and another with gas in the case. Using the laws of Boyle and Charles,

$$\text{Gas gravity} = \frac{\text{density of gas}}{\text{density of air}} = \left(\frac{P_g}{P_a}\right) \left(\frac{T_a}{T_g}\right) \quad (2)$$

where P_g and P_a are *absolute pressures* usually expressed in millimeters of mercury, and obtained by adding the pressure in the case (read from an attached mercury manometer) to the existing barometric pressure. T_a and T_g are absolute temperatures, both expressed in the Rankine or

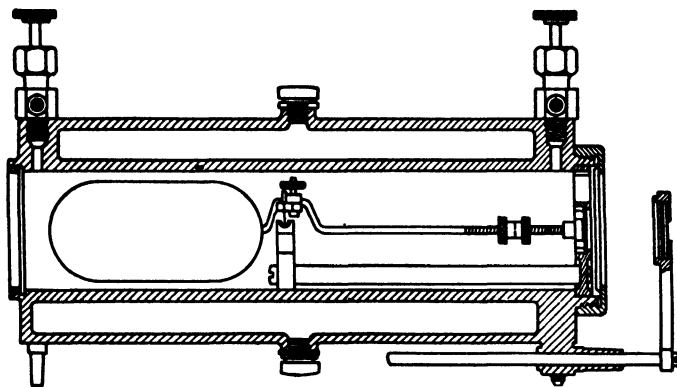

FIG. 6.- Gas balance. (Courtesy of Central Scientific Company.)

the Kelvin scale. Equation (2) assumes dry, CO_2 -free air and no liquefaction of hydrocarbons while the gas is being tested.

✓ **Low-temperature Distillation Analysis.** The percentages of the various hydrocarbons present in natural and refinery gases are determined by condensing them out of a sample of the gas at low temperature, then fractionating the condensate while recording distillation temperatures at increments of gas volumes distilled. The detailed method and apparatus most widely used were developed by Podbielniak.⁸ An illustration of an early form of the apparatus which was selected to show the essential features is given in Fig. 7. A summary of its construction and operation follows:

A small glass bulb which may be immersed in liquid nitrogen serves first to collect a sample of condensate and later to distill it. The bulb or still is connected to a glass distilling tube or column which contains

⁸ PODBIELNIAK, W. J., *Ind. Eng. Chem., Anal. Ed.*, **13**, 639 (1941) and earlier articles.

wire packing. The top of the column is equipped with a thermocouple by means of which the temperatures are measured as millivolts, and also with a liquid-nitrogen cooling chamber to provide liquid hydrocarbon reflux (as required for any fractional distillation). The tube and head are mounted in a shielded vacuum jacket to prevent heat absorption from the room.

The vapor as distilled is collected in a gas receiver consisting of a large bottle of accurately known volume, which is mounted in a water

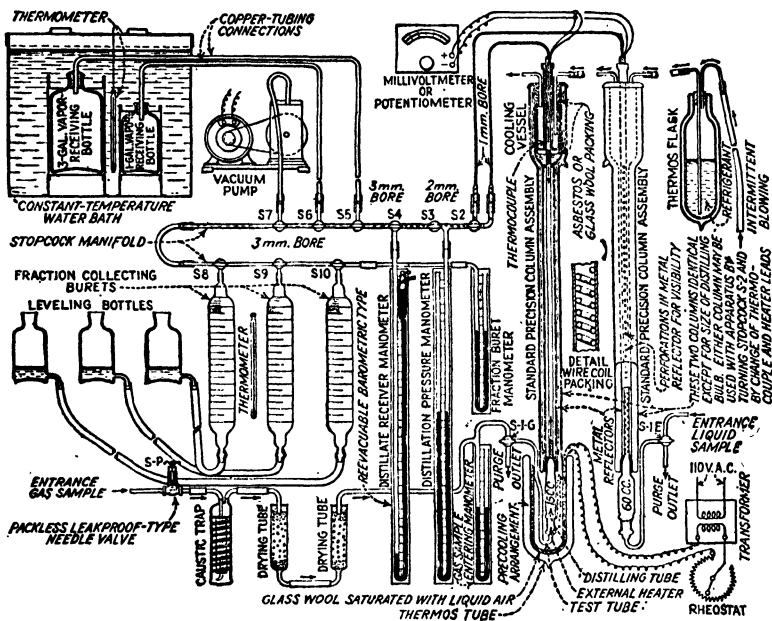

Fig. 7.—Two-unit low-temperature fractional distillation analysis apparatus. (Courtesy of W. J. Podbielniak.)

bath to maintain a constant temperature during an analysis. A mercury manometer is attached to each side of a flow-regulating stopcock in the vapor line. An open manometer on the *column side* indicates the pressure at which the distillation is being conducted, while a *closed-end manometer* on the receiver side indicates the absolute pressure on the gas receiver.* Before and at intervals during an analysis, the gas receiver is evacuated, so that its pressure is always below that of the column. Since the distillate is removed and maintained in the gas phase, its volume is computed from increases of pressure as read from the receiving bottle manometer.

A "wet" natural gas contains methane and inerts, ethane, propane,

* The distillation is conducted at atmospheric pressure except while pentanes and hexanes are distilled, when the pressure is reduced so that these hydrocarbons may be collected in the gas phase.

butanes, pentanes, and heavier hydrocarbons. For an analysis, a dried sample of the gas is slowly passed through the apparatus while both distilling bulb and column head are maintained cold with liquid nitrogen. This condenses part of the methane and substantially all the heavier hydrocarbons. The uncondensed gas passes into the receiving bottle and is measured in terms of bottle pressure as described. When enough condensate for the analysis has accumulated in the bulb, the distillation is begun. This is accomplished by slowly lowering the liquid-nitrogen

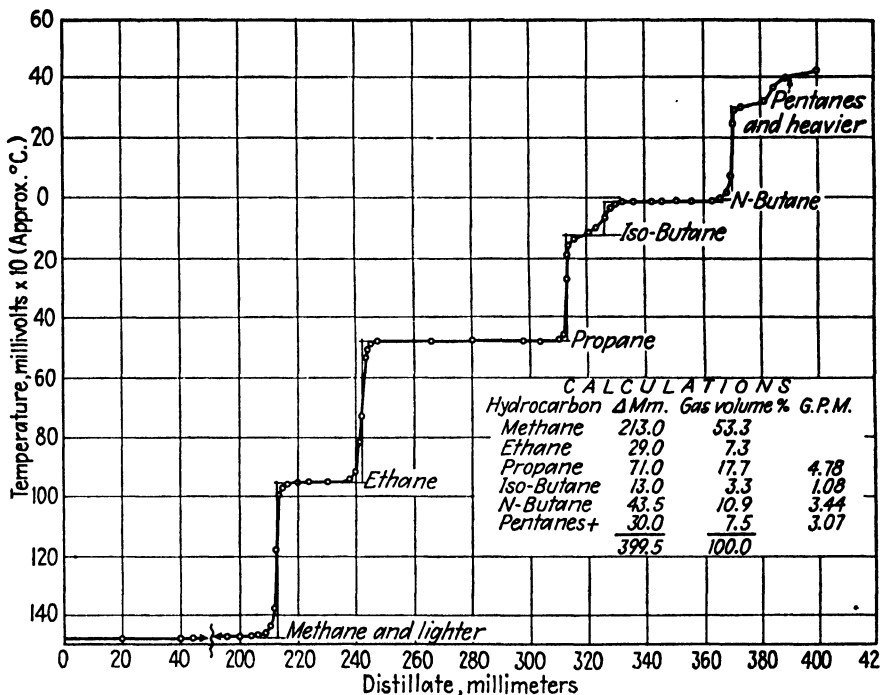

FIG. 8.- Low-temperature distillation analysis of a wet natural gas. (Courtesy of W. J. Podbielniak.)

bath from around the distilling bulb so that the bulb slowly warms owing to heat received from the atmosphere.

Methane (nbp = $-161.5^{\circ}\text{C} = -258.5^{\circ}\text{F}$) is the lowest boiling hydrocarbon and distills out first, during which the overhead temperature (observed as thermocouple millivolts emf) remains constant. When methane has been eliminated, the temperature rises to the boiling point of ethane where it remains until the ethane has distilled out. This operation is continued through propane, iso- and *n*-butane and the pentanes, which is as far as the low-temperature analysis is usually carried. For distillation of pentanes, a small electric heater is provided at the base of the distilling bulb. Liquid residue left in the distilling bulb is

removed, measured, and its specific gravity determined. (This enables an estimation of the molecular weight of the residue.)

A plot of the receiver pressure–millivolt emf data forms a series of “steps” as shown in Fig. 8, whose “plateaus” occur at the boiling points of the individual hydrocarbons. From these data, the gas analysis is calculated as *volume per cent* of each hydrocarbon present and, from the analysis, the gallons of liquid hydrocarbons (or natural gasoline) per 1,000 cu ft of gas may be computed.

The same apparatus is also used for analysis of refinery gases and for the determination of the light hydrocarbons in gasolines. Refinery samples may contain olefins, diolefins, and a few paraffins which do not occur or are not common in natural gas and natural gasoline. Such samples cannot always be completely analyzed by low-temperature distillation and, when necessary, special chemical and spectrometric methods are used.

Other Tests on Gas.⁹ Sulfur compounds are objectionable in gas used for domestic and certain other purposes. Maximum concentrations of hydrogen sulfide and also of total sulfur content are often included in purchasers' specifications.

Hydrogen sulfide is determined by the *Tutwiler apparatus*. The H_2S carried by a 100-ml gas sample is absorbed and titrated with standard iodine solution. Test results are expressed as *grains of H_2S per 100 cu ft of gas*. Total sulfur may be determined with the *Referee's apparatus*. The test procedure is to burn a measured volume of the gas, absorbing the SO_2 and SO_3 in ammonium carbonate. This reagent oxidizes and converts the SO_2 to ammonium sulfate and absorbs SO_3 as the same final compound. The compound is then converted to barium sulfate for determination of total sulfur.

The *heating or calorific value of a fuel gas is very important*. Its determination is discussed in Chap. V. The heating value of natural gas is of the order of 1000 Btu cu ft, depending upon its composition.

PART 5. EVALUATION OF CRUDE OIL AND OF PETROLEUM FUELS

Boiling range is the principal distinguishing or characterizing property of the lighter *primary fractions* from crude oil and also of the lighter finished products. Heavy or viscous oils are difficult to distill without degradation and are differentiated by the properties of gravity and viscosity. However, there is no sharp line of distinction between *light* and *heavy* oils.

Each of the various petroleum fuels may be consumed under a rather wide range of operating conditions. Specification tests are well established for each major product and cover the principal requirements

⁹ ALTIERI, V. J., “Gas Analysis and Testing of Gaseous Materials,” American Gas Assoc., New York, 1945.

imposed by consuming equipment and local conditions of use. The ASTM gives more than 50 standardized tests for this general purpose.¹⁰ The collected manual of tests is revised annually, with changes in some of the existing tests and new tests added. Discussions of some of them are given later in this chapter and in Chaps. III and V.

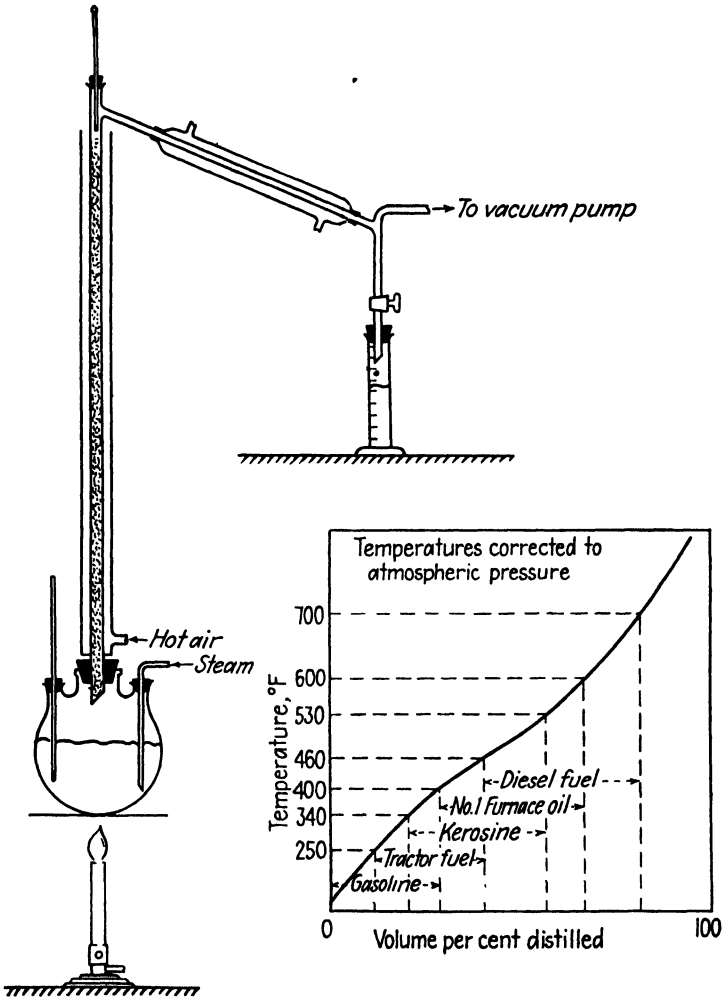

FIG. 9.—“True-boiling-point” analysis of crude oil.

True-boiling-point Evaluation of Crude Oil. The true-boiling-point analysis and evaluation is a laboratory method of determining the proportions of the various straight-run fractions that a crude oil contains. It is often extended to laboratory treating and blending of the small frac-

¹⁰ “ASTM Standards on Petroleum Products and Lubricants,” current ed.

tions to obtain samples of finished products. This gives information on the applicability of various refining methods as well as on the quality and quantity of products obtainable from the particular sample of crude oil.

One of the common types of true-boiling-point apparatus is shown in Fig. 9. It is constructed largely of glass and consists of a distilling flask, jacketed fractionating column, condenser, receiver, and accessories. The smallest satisfactory charge is 2 or 3 liters of crude oil. The charge is distilled slowly, using adequate reflux. Small "cuts" or measured portions of distillate are collected, and the distillation temperatures recorded.

The distillation is conducted at atmospheric pressure until the temperature of the liquid in the flask exceeds 600°F. The operation is then interrupted while the flask cools, the pressure on the system is reduced to and held at some convenient value (usually 10 mm Hg), and the distillation is resumed under reduced pressure. This procedure permits much higher boiling fractions to be distilled at temperatures of 650°F or less. At higher oil temperatures, thermal decomposition or cracking begins to affect the properties of the oil. If lubricant fractions are to be distilled, steam may be bubbled through the oil in the flask while the pressure on the system is maintained at 10 mm or somewhat higher.

The observed distillation temperatures are converted to 760 mm by a hydrocarbon boiling-point correction or vapor-pressure chart (see Chap. III) and these temperatures are plotted against per cent of the crude distilled, as indicated on Fig. 9. From the true-boiling-point curve, the percentages of the various untreated products in the crude may be approximated. The small cuts are blended to give products of specification boiling range, gravity, or viscosity, and may be laboratory-treated or refined by the same general processes and conditions that correspond to refinery operations.¹¹ The boiling ranges of various petroleum products overlap and, should the maximum quantity of one product be desired, the yields of products having overlapping ranges will either be greatly reduced or cannot be made at all.

ASTM Distillations (D 86, 158, 216).* The boiling ranges of the lighter distillates and gasoils are determined with the ASTM apparatus (supersedes *Engler* distillation). The apparatus consists of a distilling flask (heated by a gas burner or electric heater), condenser, receiver, and mountings. Figure 10 shows the apparatus used for gasoline, kerosine, and No. 1 fuel which require a sample of 100 ml. The apparatus used for heavier oils employs a larger flask and charges a 200-ml sample. When the specified procedures are followed, the tests give reproducible *temperatures at various percentages distilled for a given sam-*

¹¹ MITHOFF, MacPHERSON, and SIPOS, *Proc. API*, **22**, III, 25 (1941).

* Bold-face numbers prefixed by D are ASTM test designations.

ple. When plotted, the data form smooth curves having the general shapes and relative positions shown in Fig. 11.

Gasolines containing butanes and pentanes show a *distillation loss* of 1 per cent or more, since these highly volatile hydrocarbons are not completely recovered in the condensate by the standard procedure. There is always a *distillation residue*, since the vapor in the distilling flask at the end of the test recondenses upon cooling. *For the gasoline and kerosine tests, temperatures at various percentages evaporated are often*

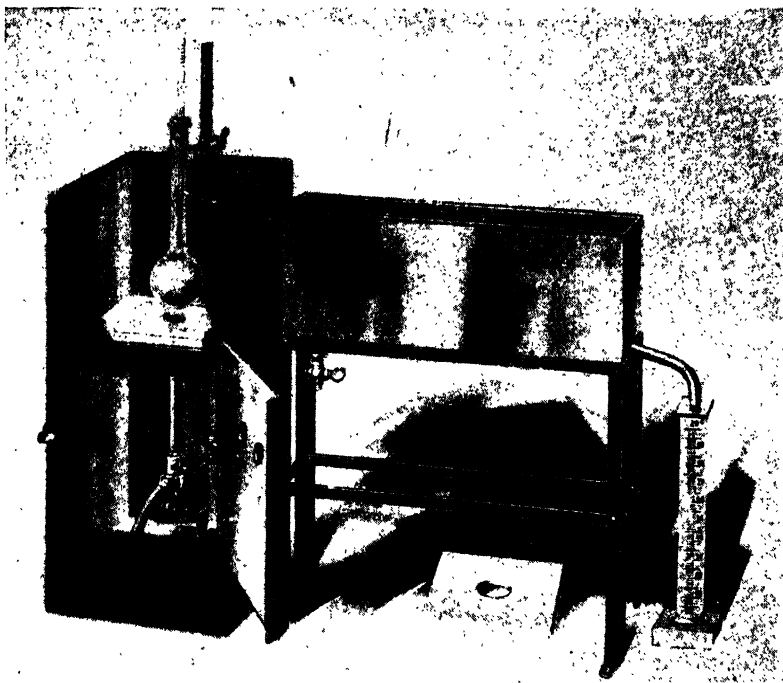

FIG. 10.—Apparatus for ASTM gasoline distillation. (Courtesy of C. J. Tagliabue Manufacturing Company.)

reported. The per cent evaporated is the per cent recovered in the receiver plus the distillation loss. The loss is calculated as the difference between 100 per cent and the per cent recovered plus residue.

The initial boiling point (ibp), the end point (ep), and as many intermediate temperatures as desired may be recorded. However, the 10, 50, and 90 per cent points are of greatest significance for specification purposes.

The ASTM distillation temperatures of a sample from a true-boiling-point analysis do not coincide with the true-boiling-point temperatures, but the two are not greatly different. In general, the ASTM initial boiling point is somewhat higher and the end point somewhat lower than

the corresponding section of the true-boiling-point curve which the sample represents. The midpoints of the two are quite close and may coincide.

API Gravity (D 287). Oil gravities are rapidly and accurately determined by means of a standard hydrometer. The *American Petroleum Institute (API) gravity* scale is a modification of the Baumé scale for light liquids and API gravities are always reported as at 60°F. API gravity is related to specific gravity [see Eq. (6) in Chap. III].

Flash Point (D 56, 93). The flash point is the lowest temperature at which an oil will generate enough vapor to form an inflammable mixture with air under specified test conditions. It is therefore an indi-

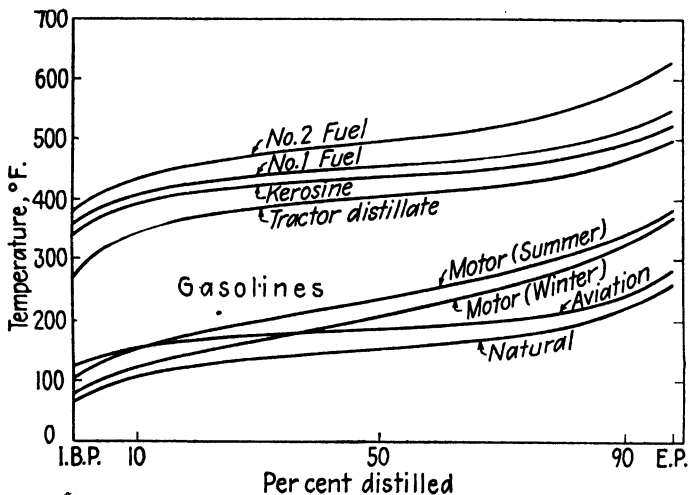

Fig. 11.—Typical ASTM distillations.

cation of the ease of ignition or of the fire hazard encountered in the handling and use of the oil. The flash points of kerosine and fuel oils are determined with a closed cup type of apparatus containing quiescent air above the oil. (A similar condition exists during the storage and use of these products.)

Reid Vapor Pressure (D 323). The vapor pressure (VP) is closely related to the tendency of gasoline to “vapor-lock” or generate vapor bubbles in the gasoline line or carburetor bowl of an engine in hot weather. The Reid test (RVP) is made only at 100°F and its value is an *absolute* pressure, as pounds per square inch (see Chap. III).

Interjacent Summary. The foregoing are commonplace tests on light oils. The approximate overall ranges of numerical test values are given in Table 2.

✓ **Knock Characteristics of Motor Fuels.** Efficient, smooth operation of an internal-combustion engine is characterized by a rapid though steady combustion of the air-fuel mixture. Certain conditions (of which *high-compression pressure* is the most important) cause another and

TABLE 2.—RANGE OF SOME TEST VALUES ON LIGHT PETROLEUM PRODUCTS*

Fuel	API grav	Flash point, °F	Reid VP, lb	% distilled at t°F				
				IBP	10	50	90	EP
Natural gasoline..	75-90	12-30	68-90	85-150	125-185	275 max	375 max
Motor gasoline....	58-66	8-11	80-105	125-140	220-250	330-360	385-437
Aviation gasoline..	7.0 max	150-158	176-212	230-257	311 max
Tractor distillate..	30-48	110 min	225-250	276-375	464-540
Kerosine.....	41-44	110 min	340	510-540
Diesel fuel.....	16-45	140-195	350-400	450-510	580-700	650-725

* Should not be construed as specifications. Ranges include all grades of each fuel.

undesirable mechanism known as *preignition* to appear. This is accompanied by audible knocking, loss of power, and possible engine damage if the knock is severe. The tendency toward knocking exhibited by individual gasoline hydrocarbons varies tremendously. This property has been correlated with molecular structure.¹²

High *antiknock* properties are required of gasolines. Of the various hydrocarbon structures present in gasolines, normal paraffins are the poorest in this respect. The antiknock property improves with isomerization or branching of the chain, and paraffins having highly branched structures (particularly with methyl side chains) have exceedingly good antiknock properties. Long-chain olefins have better antiknock properties than the corresponding paraffins, but this parallelism fades out, disappears, and is in some cases reversed as structural branching increases. Naphthenes are intermediate in antiknock properties. Aromatic hydrocarbons are generally superior in antiknock properties, although the property is greatly influenced by the number, position, and size of alkyl side chains on the ring.

Ethyl fluid (the active ingredient of which is tetraethyl lead) is very effective and widely used to increase the antiknock properties of gasolines. It is added in small amounts (up to 3 or 4 cc/gal of gasoline).

A measure or numerical value of the antiknock property known as *octane number* is determined by a single-cylinder test engine (the CFR engine) developed for this purpose (D 357) (Fig. 12). Pure normal heptane is arbitrarily assigned an octane number of zero, and pure 2,2,4-trimethylpentane (isooctane) is assigned an octane number of 100. Motor gasolines fall between these extremes of knock properties, and a mixture of these two hydrocarbons can be found whose knock test matches that of any motor gasoline, when both are tested according to a specified procedure. The *percentage of standard isooctane by volume with n-heptane in the matching blend is designated as the octane number*. Thus

¹² LOVELL and CAMPBELL, *Chem. Rev.*, **22**, 159 (1938).

an octane number of 70 designates a matching blend containing 70 per cent iso-octane.* A similar test applied to aviation gasoline is conducted with a somewhat different engine and procedure.

Carbon Residue (D 189, 524). When the heavier oils are heated and vaporized at atmospheric pressure, a certain amount of thermal decomposition occurs and some nonvolatile, carbonaceous material forms. Two sets of apparatus and procedures are used for determining



FIG. 12.—Determining the octane number of motor gasoline. (Courtesy of The Texas Company.)

“carbon residue” by heating and vaporizing an oil in the absence of air. Test values obtained by the two methods on the same sample are not necessarily the same.

The test values on illuminating and heating oils furnish an index of the tendency of “carbon” formation on and about burner wicks, vaporizers, and nozzles. Test values on diesel fuels increase with their tendency to form carbon deposits in the engine combustion chamber.

Viscosity (D 88, 341, 445, 446, 567, 666). The viscosity or *resistance to flow* of an oil determines its resistance to being pumped through lines

* Because of the high cost of the pure hydrocarbon “primary fuels,” most octane number determinations are actually made by using calibrated “secondary” or “reference fuels.”

and burner passages, and is also related to the fluid energy required for atomization in burner nozzles.

There are two basic types of oil viscosimeters used in the United States: the glass capillary-tube types and the Saybolt instruments. All depend upon the force of gravity to flow the oil through the instrument, while the time for flow of a definite volume of the oil is measured. The test values therefore have *kinematic dimensions*, that is, they depend inversely upon the specific gravity of the oil, whereas absolute viscosities are not related to specific gravity.

ASTM viscosity determinations are made at oil temperatures of 100, 122, 130, and 210°F. Viscosity-temperature charts are available on which the viscosity-temperature relation of an oil plots as a straight line. From determinations at two temperatures, the charts enable a close estimation of the viscosity at other temperatures (see Chap. III).

The glass capillary-tube instruments must be individually calibrated. Their viscosity determinations are reported as *centistokes* (the cgs unit of kinematic viscosity).

The Saybolt instruments consist of a metal oil tube at the bottom of which is a capillary or outlet tube. The assembly is mounted vertically in a bath maintained at a constant temperature. The time required for the oil to fill a 60-ml receiver is measured.

Two sizes of outlet tubes are specified; the smaller of the two is designated *Saybolt Universal* and the larger is the *Saybolt Furol*. Test results are reported as *Saybolt Universal seconds (SUS)* or *Saybolt Furol seconds (SF'S)* at the temperature of test. ASTM tables are provided for interconversion of Universal seconds, Furol seconds, and centistokes at the same temperatures (see Appendix Table 11).

Pour Point (D 97). The temperature below which an oil will not flow under specified conditions of testing is designated as the *pour point*. Oils will not flow satisfactorily at temperatures below their pour points.

The pour point of a mineral oil containing wax depends primarily upon the amount and character of the wax present, and to a lesser extent upon the thermal history and certain other characteristics of the oil itself.

REQUISITES OF PETROLEUM FUELS¹³

✓ **Gasoline.** The ASTM distillation test is in reality a measure of the *volatility* or vaporization temperatures of gasoline, and as such provides indices of how readily the fuel will burn in spark-ignition engines under various operating conditions. It is assumed that the gasoline must

¹³ For additional information, see "The Significance of Tests of Petroleum Products," ASTM, Philadelphia, Pa.

vaporize completely and be thoroughly mixed with air to give satisfactory engine performance.

During and immediately after starting a cold engine, the fuel is incompletely vaporized. The 10 per cent point of the distillation provides an indication of the lowest temperature at which enough vapor will form to permit the engine to start without difficulty. The 50 per cent point is related to the engine manifold temperature at which the fuel is completely vaporized by the carbureted air. The 90 per cent point gives an indication of the temperature at which heavy fractions of the fuel may condense in the combustion chamber during starts in cold weather. When this occurs, the gasoline condensate works past the piston rings and down into the crankcase where it thins and contaminates the lubricating oil.

The *Reid vapor pressure* is closely related to the tendency of a gasoline to generate vapor. At high altitudes and in hot weather, high-vapor-pressure gasolines show excessive losses from the vents of the carburetor bowl and fuel tank. A more serious consequence is "vapor lock," in which bubbles form in the gasoline line. This occurrence may result in the carburetor bowl becoming empty, and stopping of the engine.

The trend in engine design has been for many years to increase *compression ratios*, which results in higher *compression pressures* in the combustion chamber. The fuel economy of an engine improves rapidly as the compression ratio is increased. However, higher compression ratios require fuels having higher volatilities (lower *50 per cent* and *90 per cent* points) and also higher octane numbers. The refining industry has provided fuels of adequate volatility and antiknock properties even in advance of heightened engine requirements. Gasoline specifications which are satisfactory for engines of current design are given in Table 3. These specifications will undoubtedly need revision from time to time.

TABLE 3.—DETAILED REQUIREMENTS FOR GASOLINE^a

Gasoline type	ASTM distillation, min % evaporated at temp. °F shown					Reid VP max			Octane No, min
	10			50	90				
	W	F	S			W	F	S	
Normal volatility	140	149	158	284	392	13.5	11.5	9.5	70 or 77
High volatility	140	149	158	257	356	13.5	11.5	9.5	70 or 77
Low volatility	167	167	167	284	392	13.5	11.5	9.5	50

^a Conforms to D 439—40 T. W, F and S refer to United States geographical seasonal variations. Also specified: distillation residue 2% max, corrosion passes, gum max, 7 mg/100 ml. Sulfur content and other requirements subject to specification.

Other qualities used for specifications are color, doctor test, gum stability, gum inhibitor content, tetraethyl lead content, sulfur content, and API gravity.

Specifications for *aviation gasolines* are in general more rigid than those for motor fuels. Aviation gasolines generally require higher octane numbers. Aviation fuels are rated by the "aviation" test (D 614), which is considerably different from the motor-fuel test. Aviation-fuel distillation ranges are narrower and have lower 50 per cent points than motor gasolines. The Reid vapor pressure must also be lower, and there are other special requirements.

✓**Kerosine and Burning Oils (D 187, 219, 239).** Kerosine and burning oils are intended primarily for illumination in wick-type lamps. Probably the most important requirement is a satisfactory burning test in the standard test lamps. Paraffinic materials are the most generally satisfactory type of stocks from which to refine illuminating oils.

Kerosine and mineral seal oils are actually used for several purposes other than illumination. Quantities of kerosine are consumed as tractor fuel. Probably because of these other uses, standard specifications have not been completely defined. Color, flash point, distillation, sulfur content, and minimum API gravity are included in most kerosine and burning oils specifications.

✓**Diesel Fuels.** The operation of diesel engines depends upon auto-genous ignition of the fuel as it is sprayed into the combustion chamber and mixes with the air heated by the piston compression. The fuel must ignite and burn quickly and completely. A number of tests and calculated factors have been devised to measure or give an index of *ignition quality*, but only one had been included in the "ASTM Standards on Petroleum Products and Lubricants" by 1945 (cetane number, D 613).

There are great differences in the design, operation, and fields of application of various diesel engines. There are corresponding differences of requirements as to minimum fuel standards.¹⁴ In general, high-speed engines require higher grade fuels than those which operate at lower speeds.

Manufacturers' specifications for fuel to be used in particular engines usually include viscosity (SUS at 100°F), API gravity, sulfur, carbon residue, flash point, ASTM distillation, and cetane number.

Fuel Oils. The ASTM has developed specification grades of fuel oils which are designated by number (see Table 4). In addition to the ASTM requirements, color, gravity, sulfur content, ash content, and sediment may be used as specifications, and adjustments to the standard

¹⁴ "A Study of Diesel Fuel Specifications," Universal Oil Products Co., Booklet No. 228, 1939.

values given in Table 4 may be made as individual agreements between buyer and seller.

TABLE 4.—SPECIFICATIONS FOR FUEL OILS^a

Grade No.	Flash point, °F		Pour point, °F	Water and sediment, vol %	Carbon residue, ^b wt. %	Distilled at t°F				Saybolt viscosity, sec.			
						10 %		90 %		EP	Universal at 100°F		Furol at 122°F
	Min	Max	Max	Max	Max	Max	Min	Max	Max	Min	Max	Min	Max
1	100 or legal	165	0	Trace	0.05 on 10 % residue	410	560				
2	110 or legal	190	10	0.05	0.25 on 10 % residue	440	...	600					
3	110 or legal	230	20	0.10	0.15	...	600	675	45		
4	Use and classification of No. 4 fuel discontinued												
5	130 or legal	1.0	50	40
6	150	2.0	45	300

^a Conforms to ASTM Designation D 396--39 T. Not complete fuel specifications, however.

^b ASTM D 189.

Grades 1, 2, and 3 are known as *heating oils* since their greatest consumption is in domestic and light industrial heating furnaces. *Range oil* is somewhat lighter than No. 1 fuel, and *furnace oil* is similar or identical to No. 1 fuel. Grades 1, 2, and 3 are loosely referred to as *distillate* and as *gasoil*. Grade 3 is sometimes referred to as *recycle*, connoting its removal from a refinery cracking unit. Grades 5 and 6 correspond to *Bunker B* and *Bunker C* designations, respectively. The source of No. 5 fuel is usually cracking-still tar; No. 6 fuel is a straight-run residual, a cracked residual, or a blend of a residual with enough cracking-still tar to reduce the viscosity to a specified value.

Fuel oils are sold by the gallon at decreasing prices for the higher grade numbers. Hence consumers use the heaviest grade their equipment or process will conveniently permit. The heaviest grade of fuel that can be satisfactorily used depends chiefly upon the type of burner (see Chap. X). The relative tendency of a fuel oil to smoke increases with its carbon-hydrogen ratio, and the tendency to deposit carbon on and around the burner is a function of both its molecular weight and its molecular structure.

PART 6. ELEMENTS OF CONVERSION PROCESSES

Purposes. The quantity demand for the various petroleum products does not correspond to the amounts of straight-run fractions in crude oil.

Neither do the available straight-run fractions have the most desirable properties for all applications. In order to balance supply and demand as well as to furnish better fuels for specific purposes, the proportion of straight-run fuels is diminishing and that of converted and processed products is steadily increasing. Oil refineries are becoming synthetic chemical industries whose principal raw material is crude oil and whose principal products are hydrocarbon mixtures of controlled molecular weights and molecular structures.

The quantity of straight-run gasoline available is less than half of the total motor-fuel demand, and much of the straight-run product is unsuitable for motor-fuel blending stock. Consequently, the bulk of the conversion operations are for the purpose of making motor and aviation gasolines. Thermal cracking is the most widely used, although catalytic processes are rapidly gaining in relative importance. The octane number of cracked and synthetic gasolines is considerably higher than that of the straight-run product from the same crude.

GENERAL MECHANISM

Thermal cracking operations subject the oil to temperatures of the order of 1000°F. At cracking temperature, partial decomposition, structural rearrangements, and recombination or polymerization of the hydrocarbons and certain types of the fragments occur, so that the cracked material has very little resemblance to the original stock. For various straight-run fractions of the same general structure, the ease of cracking increases with the molecular weight of the fraction. However, the various hydrocarbon structures decompose at different rates. Certain of the initial decomposition products undergo secondary reactions.

Type Reactions. Paraffin molecules *split* into lower molecular weight paraffins and olefins:

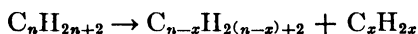

Splitting may occur between any two carbon atoms, but splitting near the center of the molecule predominates; that is, x is about half of n . The lower paraffins formed split again in the same manner, although not so rapidly. If the cracking were carried far enough, the only paraffin remaining would be methane. Some methane is undoubtedly formed directly from the original paraffins, but it is probable that most of it comes from splitting of the secondary smaller paraffins and olefins.

Olefins decompose more slowly than do paraffins, the predominant reaction being the formation of two smaller olefin molecules.

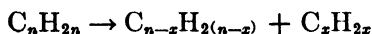

Subsequently, condensation between two olefin molecules may occur, forming a higher molecular weight olefin. The result is a series of olefins

of a wide range of molecular weights: ethene and heavier. Some cyclization may occur to produce naphthenes. Another reaction that becomes important in the higher temperature ranges is dehydrogenation of an olefin to a diolefin. Diolefins readily polymerize or condense with themselves and with olefins. They may also react with olefins to give unsaturated naphthenes.

Naphthenes decompose less rapidly than do paraffins. Long alkyl side chains attached to naphthene rings decompose just as do paraffins, leaving naphthene rings with short side chains. Some dehydrogenation of naphthene rings occurs in thermal cracking, which may produce aromatics. Dehydrogenation seems to occur more readily in polycyclic molecules than in those having but a single ring.

Alkyl side chains on aromatic rings behave similarly to those attached to naphthene nuclei. The long side chains split, yielding paraffins, olefins, and aromatics with short side chains. Aromatics having short side chains are relatively stable under cracking conditions.

High-molecular-weight petroleum fractions having more than 20 carbon atoms per molecule consist principally of *polycyclic* compounds with two or more six-carbon rings per molecule. In most of such fractions, both naphthenic and aromatic rings exist in the same molecule, and many of the rings are condensed or connected by two or more carbon atoms. Some molecules (as in paraffin wax) contain only naphthene or saturated rings.

Polycyclic hydrocarbons containing three or more rings crack very easily. Under cracking conditions, long alkyl side chains split off, and dehydrogenation of the naphthenic rings also occurs. The polyaromatic hydrocarbons thus formed condense readily with others. Further dehydrogenation and condensation take place, producing coke as the end product.

Resins and asphaltenes are dehydrogenated and condensed into coke very readily.

Kinetics. It is well established that the primary or decomposition reactions are unimolecular; their rates follow the general equation for first-order chemical reactions. Splitting of paraffins and alkyl side chains proceed at much faster rates than the dehydration reactions, and comparative free-energy changes are in the same order. Polymerization and condensation reactions are principally bimolecular and, other things being equal, they proceed much more slowly than do the primary reactions. Many of the secondary reactions cannot start until the primary or decomposition reactions have formed polymerizable hydrocarbons.

The usual range of commercial cracking temperatures is 850 to about 1125°F. The rate of cracking doubles with an increase in temperature of about 20°F at the lower temperature levels, and with an increase in

temperature of about 30°F at the higher temperature levels (see Chap. VI). Pressure decreases the *apparent* rate somewhat, possibly owing to the shifting of equilibria. The temperatures and pressures used also have a major influence upon the character of the cracked products.

COMMERCIAL CRACKING

General Results. The cracking of petroleum fractions produces gas, cracked distillate, tar, and coke. The gas contains methane, gaseous paraffins, and olefins. It may contain from a trace to a considerable quantity of hydrogen, depending upon the extent to which dehydrogenation reactions have occurred.

The *cracked distillate* contains paraffins in its lower boiling fractions, although usually in lower concentration than were present in the original

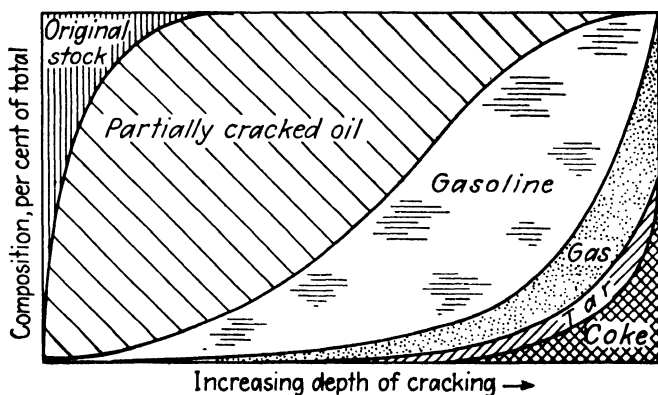

FIG. 13. - Qualitative results of cracking. (After A. L. Strout.)

cracking stock. *Normal paraffins* remain in only insignificant proportions. A large amount of olefins is present, largely in the form of isocompounds. The other constituents are mono- and bicyclic naphthenes and aromatics, most of which have short alkyl groups attached to the rings. As an approximate average, gasoline from the mixed-phase cracking of a mixed-base gasoil contains about a third paraffins, a third olefins, and a third naphthenes plus aromatics.

The cracked tar consists chiefly of condensed polycyclic aromatic compounds, with short alkyl groups. The "coke" is really a hydrocarbon material of very highly condensed aromatic structure, containing 1 or 2 per cent of hydrogen by weight.

Depth of Cracking. The *degree* or *depth* of cracking determines the relative amounts and character of the cracked fractions. For thermal processes, depth of cracking is a function of *time and temperature*. Pressure has little effect upon the primary decomposition reactions, but has a

profound effect on the final products, as will be discussed later. Figure 13 illustrates the qualitative results of cracking.¹⁵

Decomposition of the original stock begins as soon as the oil has attained a high temperature, producing partly cracked oil and then gasoline. As the cracking proceeds, more gasoline appears and gas formation becomes appreciable. Condensation and dehydrogenation reactions set in, and tar appears. Coke is the end product of condensation and dehydrogenation, but plant operations are carefully regulated to keep coke formation to a minimum.

Prolonged cracking decomposes the gasoline into gas and tar, then the tar into gas and coke. The end products are gas and coke. Gasoline concentration reaches a maximum, and this maximum point has been

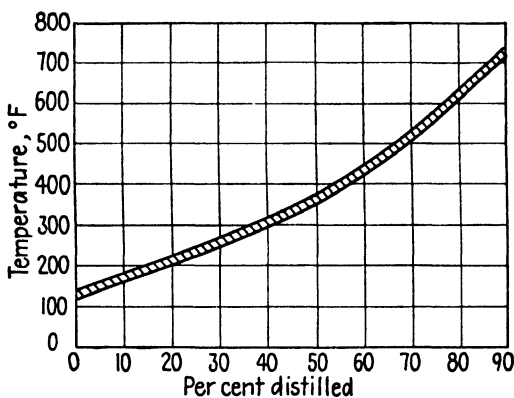

Fig. 14.—“Limiting band” in products from hydrocarbon conversion processes.

successfully predicted by the application of kinetic equations to cracking under controlled conditions.

In commercial operations, cracking is always stopped before the maximum percentage of gasoline is formed. The cracking coil product has a very wide boiling range, even after the separation of gas and tar. Figure 14 is a hypothetical “assay distillation” curve (such as obtained from ASTM distillation apparatus), which was derived from tests on quite a variety of petroleum-cracking and other conversion products.¹⁶ Many such products have a very similar or common boiling range. The more drastic the conversion treatment, the closer the assay distillation curve approaches this “limiting band,” provided only that dehydrogenation occurring during the conversion was not too severe. Figure 14 may therefore be regarded as a reference to be used for obtaining a rough comparison of depth or degree of cracking or conversion as effected by different processes and operating conditions.

¹⁵ STROUT, A. L., *Proc. API*, **10**, III (1929).

¹⁶ FERRIS, S. W., *Ind. Eng. Chem.*, **33**, 752 (1941).

Effects of time, temperature, and pressure on the thermal cracking of two virgin (straight-run) stocks and on a recycle (combined feed) stock have been presented in a recent article.¹⁷ The results are correlated in terms of decomposition and polymerization rate constants, and general summaries are given of the effects of the operating variables on yields of the various cracked products. Kinetics of the cracking reactions are taken up in Chap. VI.

✓ THERMAL CONVERSION PROCESSES

Thermal cracking is conducted at pressures from substantially atmospheric up to about 1,500 psi. Even higher pressures are used in thermal polymerization processes.

Low-pressure cracking at pressures only slightly above atmospheric (0 to 75 psi) is conducted with all the material in the vapor phase. High temperatures are used, 1000 to 1125°F. Cracking reactions are very rapid under these conditions.

High temperatures and low pressures favor decomposition and dehydrogenation reactions over polymerization. Hence *vapor-phase cracking* produces a relatively large amount of gas ($\frac{1}{3}$ to $\frac{1}{2}$ lb of gas per gallon of cracked gasoline). The gas contains hydrogen and a high proportion of olefins, ethene and higher as well as considerable methane. The gasoline is also highly unsaturated. In order to obtain a high ultimate yield of gasoline, the crack-per-pass (*as gasoline formed*) is kept down to about 10 per cent of the charge, and the cracked gasoil is partly or entirely recycled. Low-pressure vapor-phase cracking is not in extensive use for motor-gasoline manufacture since the gasoline yield is lower than is obtainable by pressure processes.

Pressure cracking is conducted at temperatures from 850 to 1050°F and pressures from 200 to about 1,500 psi. Such operations are referred to as "mixed-phase" cracking, for even at the highest pressures, the oil under cracking conditions is partly liquid and partly gaseous. The pressure used is chosen primarily by the characteristics of the cracking stock and secondarily by the depth of cracking to be accomplished. The general effect of pressure is to suppress dehydrogenation and to promote polymerization of olefins. Gas formation averages about $\frac{1}{6}$ lb/gal of gasoline formed, and gasoline formation is sometimes as high as 30 per cent of the cracking stock per pass through the unit. The ultimate yield of gasoline depends upon a number of factors, chiefly cracking stock characteristics, depth of cracking, and whether or not recycle gas oil is removed from the system to be made into heating oils. (Each 3 per cent of recycle oil so removed reduces the ultimate gasoline yield by about 2 per cent.)

¹⁷ SUNG, BROWN, and WHITE, *Ind. Eng. Chem.*, **37**, 1153 (1945).

Reforming refers to mild cracking of naphtha for improvement of octane number and lowering of the boiling range (increasing the volatility). High pressures, relatively high temperatures, and short times of exposure are the general practice. Gasoline yields are high, 70 to 95 per cent or even higher.

Pressure cracking of straight-run and recycle gasoil fractions includes the greatest volume of conversion operations. There are many commercial processes, each having individual features of equipment and flow of materials. Cracking temperatures are most frequently between 900 and 1025°F and pressures between 500 and 1,500 psi.

A relatively new pressure process introduces refinery gases with the oil being cracked, so that the whole mixture exists in the vapor phase under cracking conditions. Advantages of the process are better yields of gasoline, and higher octane number of the gasoline than is obtained from comparable mixed-phase operations. Also a much higher crack per pass is obtainable without coke formation, so that less recycling of cracked gasoil is required.¹⁸

Viscosity breaking is a light cracking operation performed on straight-run *residues*. Temperatures of the operation are from 850 to 900°F, and the pressure may be from slightly above atmospheric to 500 psi. Certain amounts of cracked naphtha and gasoil are produced.

Long alkyl side chains of the high-molecular-weight hydrocarbons are responsible for the high viscosity of heavy oils. In a "vis-breaking" operation, these chains are greatly shortened. The reduction in viscosity is brought about both by shortening of the side chains and by simultaneous formation of low-viscosity decomposition products in the oil. The cracked residue is used for fuel oil.

Cracking Equipment. Oil to be cracked is heated first by heat exchange or by direct mixing with hot oil streams from the process, then is brought up to cracking temperature in a tube heater quite similar to a crude oil heater (see Chap. XV). In the processes using relatively low temperatures and long cracking periods, the heater stream discharges into one end (preferably the top) of a high-pressure vessel ("soaking drum" or "reaction chamber") which provides the necessary detention time, or time-temperature factor. This soaking drum discharges into an evaporator or flash chamber, in which separation of vapor from the cracked tar occurs. The vapor is then fractionated in a second tower into raw cracked gasoline (pressure distillate) and recycle gasoil bottoms. The recycle oil may be cooled and withdrawn, or be continuously returned to the furnace. Coke accumulation in the soaking drum is inevitable,

¹⁸ BOGK, OSTERGAARD, and SMOLEY, *Proc. API*, **21**, III (1940); *Refiner National Gasoline Mfr.*, Reprint, September, 1940.

The liquid volume of natural gasoline hydrocarbons in 2.66 mols of gas is then

$$\left(\frac{2.66}{100}\right) \left(\frac{436}{5.12}\right) = 2.26 \text{ gal}$$

VAPOR PRESSURE

The Clapeyron equation is a thermodynamic relation between temperature and vapor pressure of a pure liquid compound,

$$\left(\frac{\partial P}{\partial T}\right)_v = \frac{L}{T(V_g - V_L)} \quad (11)$$

where P = vapor pressure

T = absolute temperature

V_g = specific or molar volume of material as vapor

V_L = specific or molar volume of material as liquid

L = specific or molar latent heat of vaporization, in *work units* consistent with P , V , and T

The Clausius-Clapeyron equation is the classical integrated form of Eq. (11) usable over a *range* of pressure and temperature,

$$2.3 \log \frac{P_2}{P_1} = \frac{M_r}{R} \left(\frac{1}{T_1} - \frac{1}{T_2} \right) \quad (12)$$

where M_r = molar latent heat of vaporization, in heat units

R = molar gas constant, in units consistent with M_r and T .

To obtain the relatively simple integrated Eq. (12) from Eq. (11), it is necessary to assume the ideal-gas law, a constant latent heat of vaporization, and a negligible volume for the liquid in comparison to that of the vapor.

By choosing a reference condition of temperature and pressure (fixing P_1 and T_1) for a particular substance, Eq. (12) may be given the form

$$\log P = -\frac{A}{T} + B \quad (13)$$

where A and B are constants for the particular compound over some definite range of pressure and temperature. Accordingly, a plot of vapor pressure on a logarithmic scale against reciprocal absolute temperature results in a straight line over the range for which the constants are valid.

Although the simplifying approximations noted above are not negligible, their variations tend to offset each other. (With increasing temperature and pressure, the latent heat decreases, V_g has an increasing negative gas-law deviation, and V_L increases.) Logarithmic plots of hydrocarbon vapor pressures against reciprocal absolute temperatures give lines that are but slightly curved over very wide ranges up to the

critical points.* A survey of available hydrocarbon vapor-pressure data has been made,⁴ and the hydrocarbon vapor-pressure chart plotted on these scales is given in Fig. 1. It is to be noted that the hydrocarbons form a fairly regular family of curves whose spacings and slopes are closely related to the normal boiling points. This suggests the valuable use of such charts for constructing synthetic vapor-pressure curves of unknown hydrocarbons from a known boiling point or vapor pressure at some given temperature.

Generalized hydrocarbon vapor-pressure charts have been available for a number of years, modified in detail and improved in accuracy from time to time. Cox⁵ discovered that when the vapor-pressure curve of water was drawn as a straight line and used to lay off a temperature scale against $\log P$ for hydrocarbons, the curves were substantially straight and they also extrapolated to a common intersection. Cox's procedure was found to introduce an empirical constant into the temperature scale such that the equation

$$\log P = - \frac{A}{T^{\circ}\text{R} - 79} + B \quad (14)$$

fits the vapor-pressure lines.⁶ A later type of chart which has found wide usage⁷ is constructed on rectangular coordinates. One coordinate is used as a linear temperature scale, and straight lines to represent hydrocarbons are drawn on the other. Smooth curves of constant vapor pressure are then drawn in by interpolation of data on pure hydrocarbons. It was found that the data for many, but not all, hydrocarbons could be represented by straight and parallel lines.

Maxwell⁸ presented a chart which was developed using hexane as a vapor-pressure-temperature reference substance to fix both scales. A later revision⁹ is given in Fig. 2. This chart is recommended for estimating vapor-pressure-temperature relations of hydrocarbons which do not appear on Fig. 1 and also of narrow-boiling petroleum fractions. When used for petroleum fractions, it must be remembered that inaccuracy or uncertainty increases both with *width of boiling range* of the fraction, and with extension of the pressure-temperature extrapolation. For a fraction whose boiling range covers more than a few degrees, a

* However, extrapolation over wide ranges gives inaccurate results.

⁴ SMITH, R. V., *U.S. Bur. Mines Inf. Circ.* 7215 (1942); *Petroleum Refiner*, **22**, 19 (January, 1943); *Petroleum Eng.*, February, 1943, p. 88.

⁵ COX, E. R., *Ind. Eng. Chem.*, **15**, 592 (1923).

⁶ CALINGAERT and DAVIS, *Ind. Eng. Chem.*, **17**, 1287 (1925).

⁷ COATS and BROWN (1928), BROWN and BADGER (1933), University of Michigan.

⁸ MAXWELL, J. B., *Ind. Eng. Chem.*, **24**, 502 (1932).

⁹ MAXWELL, J. B., private communication, 1941.

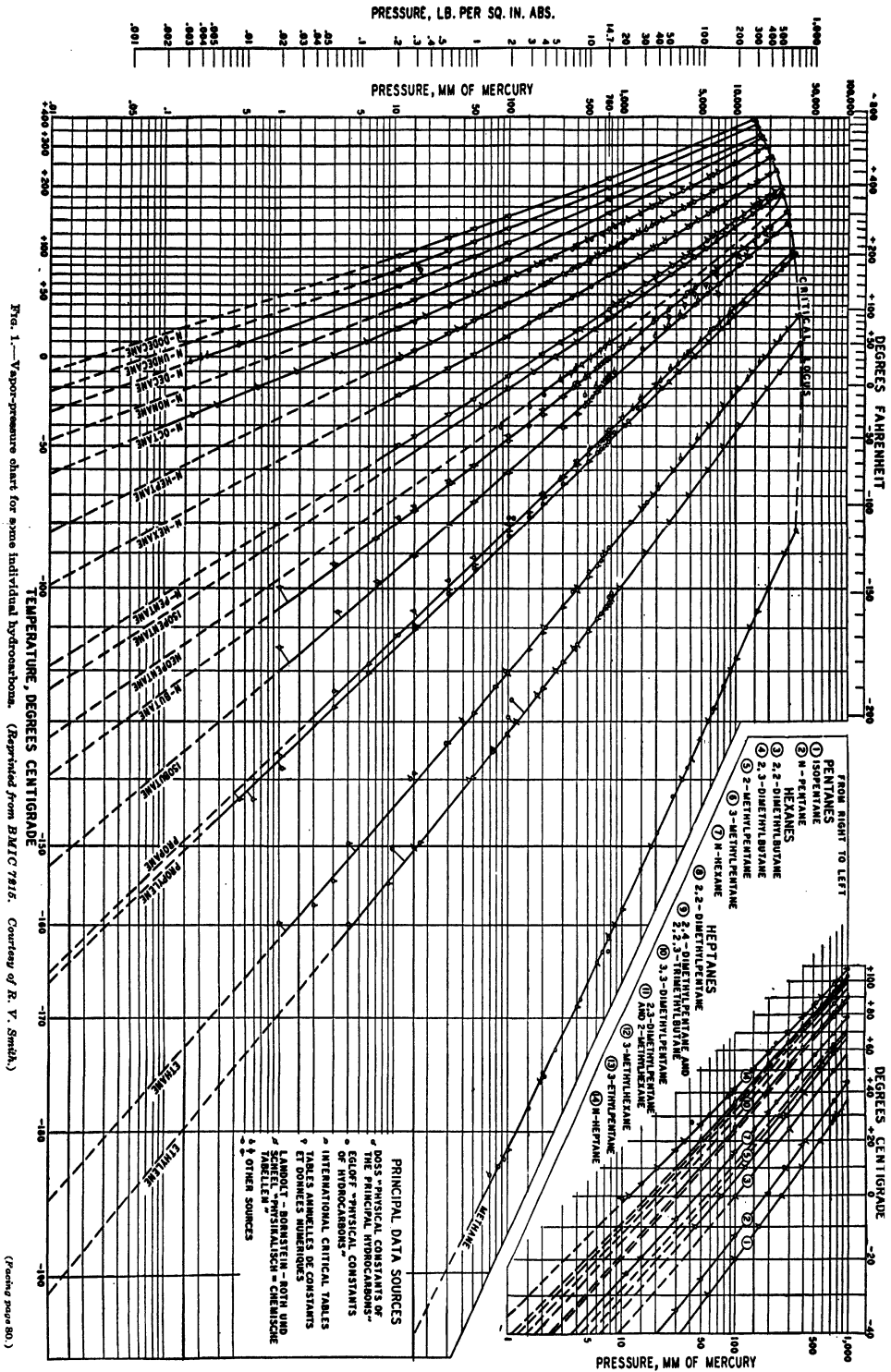

PRINCIPAL DATA SOURCES
 DOSS "PHYSICAL CONSTANTS OF THE PRINCIPAL HYDROCARBONS" OF "HYDROCARBONS" - CONSTANTS
 INTERNATIONAL CRITICAL TABLES
 TABLES ANNEXELLES DE CONSTANTES ET DONNEES NUMERIQUES
 LANGOET - BORNSTEIN - BOTH UND SCHREIER "PHYSIKALISCH - CHEMISCHE
 1. OTHER SOURCES

Fig. 1.—Vapor-pressure chart for some individual hydrocarbons. (Reprinted from *DMIC 1916*. Courtesy of R. V. Smith.)

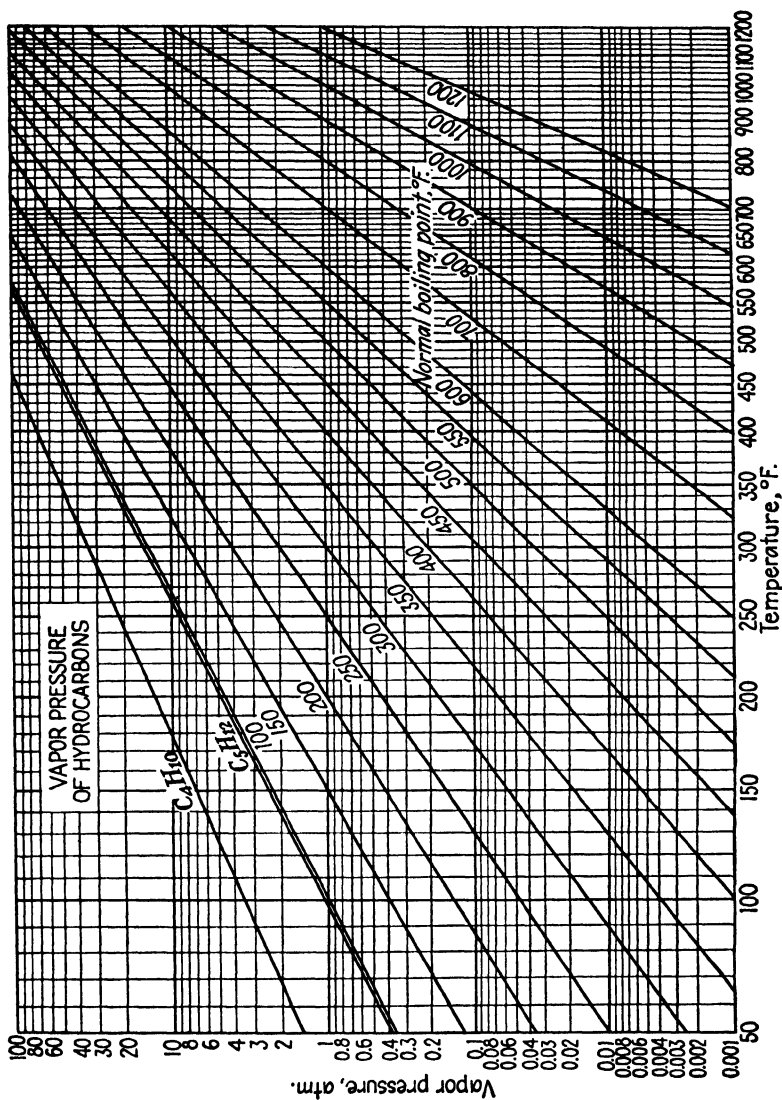

Fig. 2.—Vapor-pressure chart for narrow-boiling hydrocarbon fractions. (Courtesy of J. B. Maxwell.)

chart may not be expected to give accurate conversions over wide temperature-pressure ranges.

Illustration 3

For a true-boiling-point distillation conducted at 10 mm pressure, what are the boiling points at 1 atm when the column thermometer reads 250, 300, 400, and 600°F?

Solution: Ten millimeters is $\frac{1}{760} = 0.013$ atm. By locating the points for the temperatures given at 10 mm or 0.013 atm on Fig. 2, and interpolating between the curves, the atmospheric boiling points are 490, 550, 675, and 925°F, respectively.

Vapor Pressures of Hydrocarbon Mixtures.

At pressures up to several atmospheres and at temperatures below the critical temperature of each of the components, mixtures of hydrocarbons obey Raoult's law, Dalton's law, and the ideal-gas law closely enough so that these relations may be used for many engineering calculations.

Let p = partial pressure of a component over a liquid mixture

P = vapor pressure of a pure liquid component at the mixture temperature

π = total pressure of vapor over the mixture

x = mol fraction of a component in the mixture

Raoult's law,

$$p_a = P_a x_a$$

Dalton's law,

$$p_a + p_b + p_c + \dots = \pi$$

combining,

$$P_a x_a + P_b x_b + P_c x_c + \dots = \pi \quad (15)$$

Equation (15) may be used to calculate the vapor pressure of gasolines when the mol fractions of their volatile components (hexane and lighter) are known, since these hydrocarbons are responsible for almost the entire vapor pressure of liquid gasoline at ordinary temperatures. Equation (15)

may also be applied to heavier oils when the true-boiling-point curve is available. The procedure in the latter case is to divide the curve into a number of small fractions of equal *boiling range*, say every 10°F or less, reading off the size of each fraction. The vapor pressure of each fraction is 1 atm at its midpoint temperature. Vapor pressures of the fractions at any desired temperature may be obtained by the use of

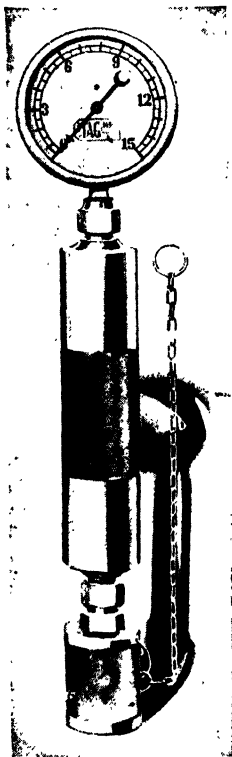

FIG. 3.—Reid vapor-pressure apparatus. (C. J. Tagliabue Manufacturing Company.)

the charts of Figs. 1 and 2. The vapor pressure of the mixture at the desired temperature is then calculated by Eq. (15).*

✓**The Reid Vapor Pressure (D 323).** The vapor pressure of gasoline is determined by the standardized Reid test at 100°F. The apparatus consists of a gasoline chamber, an air chamber, and a pressure gauge, all of which can be readily connected together and disassembled (Fig. 3). The test is conducted with air in the vapor chamber. The charge apparatus is placed in a water bath at 100°F, and the test value is an *absolute* vapor pressure at 100°F.

The volume of the vapor chamber is four times that of the liquid chamber and, under conditions of the test, a portion of the more volatile hydrocarbons in the gasoline is vaporized. The result is that the Reid vapor pressure is somewhat lower than the “bubble-point” pressure, or pressure obtained under conditions in which no vaporization occurs.

If a gasoline contains propane, much of this hydrocarbon vaporizes and the Reid value is considerably lower than the bubble-point pressure. For gasolines containing insignificant amounts of propane, calculated differences between Reid and the true or bubble-point pressures are as shown in the accompanying table.

	Vapor pressure of gasoline, 100°F	
	10 lb	25 lb
Mol % gasoline vaporized in Reid apparatus	1.5	3.3
Difference between Reid and bubble-point pressure, lb.	0.3	0.4

The vapor pressure of a gasoline *calculated* by the method of the preceding section [using Eq. (15)] is the *bubble-point pressure*. For propane-free gasolines, the Reid vapor pressure may be estimated by subtracting the correction above from the calculated bubble-point pressure at 100°F, and conversely.

Illustration 4

For the natural gasoline composition of Illustration 2, what is the true or bubble-point pressure at 100°F? What is the approximate Reid vapor pressure?

* Substitution of liquid volume fractions for mol fractions in Eq. (15) introduces the approximation that the molar volumes of all fractions are equal. The error due to this approximation is small for narrow-boiling oils but increases with width of boiling range. When a gravity curve is available, the volume fractions may be converted to mol fractions by means of the correlation given on pages 86-93.

Solution: According to Eq. (15), the total or bubble-point pressure is the sum of the vapor pressures of the components onto their respective mol fractions. The hydrocarbon vapor pressures are obtained from Appendix, Table 7.

	Mols	Mol fraction = x	P_{100°	$p = Px$
Isobutane.....	1.4	0.222	74	16.4
<i>n</i> -Butane.....	1.6	0.254	52	13.2
Isopentane.....	1.1	0.175	20.3	3.6
<i>n</i> -Pentane.....	0.5	0.079	15.5	1.2
Hexanes.....	1.7	0.270	5.0	1.3
Total.....	6.3	1.000	35.7

The bubble-point pressure at 100°F is *35.7 psia*. The Reid vapor pressure is about 0.5 lb lower, or *35.2 lb*. (This vapor pressure exceeds the maximum vapor pressure specified for *commercial* natural gasoline, and it would not be marketed without stabilization to remove part of the isobutane.)

VISCOSITY

The viscosity (resistance to internal shear) of liquids is a function of intermolecular forces. Adequate theoretical treatment of the viscosity of mixtures has not been developed, and when worked out will probably be quite complex.

The *temperature coefficient of viscosity* of any liquid varies with temperature. Since it is a variable, the temperature coefficient as such is not conveniently used in petroleum technology. Nevertheless, petroleum fractions show regularities in viscosity-temperature relations and also in the viscosities of mixtures or blends.

ASTM Viscosity-temperature Charts (D 341). Viscosity-temperature charts for oils may be obtained from the ASTM. These charts are available with viscosity scales in Saybolt seconds and also in centistokes (Fig. 4). The temperatures are in degrees Fahrenheit. The charts were developed from viscosity-temperature data on a number of different oils by laying off arbitrary viscosity and temperature scales upon which the data for each oil plotted as a straight line. With these charts, the viscosity-temperature curve for an oil may be closely approximated from viscosity determinations at two temperatures, since it may be assumed that viscosities of all oils will plot as straight lines.

It has been observed that when data for different straight-run fractions from the same crude oil are plotted on such a chart, extrapolations of the lines tend to converge at a common point. The viscosity given by the point of convergence depends chiefly upon the character of the crude and, when the data on fractions from a given crude are plotted as viscosities in centistokes and temperatures in degrees Kelvin, the point

of convergence is designated *pole height*. This furnishes a method of characterizing oils that has found extensive use in Germany.¹⁰

The viscosity of a mixture of two oils (at the same temperature) may be estimated from the ASTM charts. The procedure is to use the zero to 100° portion of the temperature scale as per cent of the heavier component in the blend. A straight line drawn between the viscosities of the

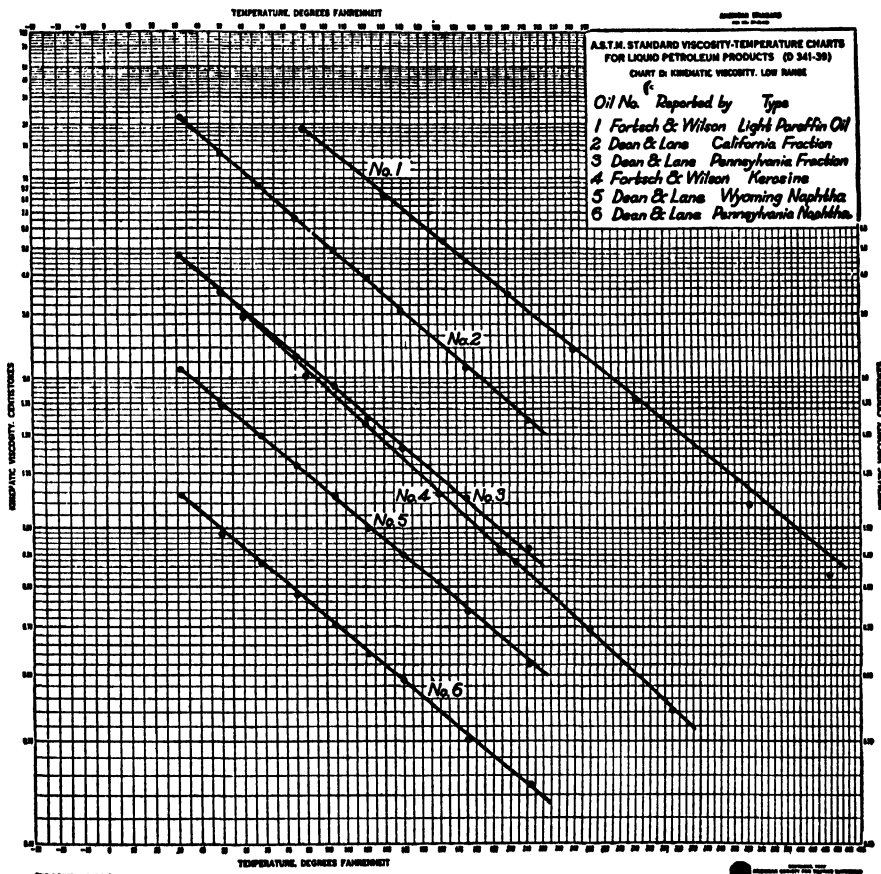

Fig. 4.—Facsimile of kinematic viscosity-temperature chart D, low range, on which several typical experimental curves have been plotted.

two components scaled in this way gives a reasonably good approximation of the viscosities of their mixtures.

The two most common methods of evaluating viscosity-temperature characteristics of various oils are calculation of the *viscosity index* (D 567), and correlations involving the *UOP Characterization Factor* (see next section).

¹⁰ KURTZ, S. S., *Ind. Eng. Chem.*, **34**, 770 (1942).

CHARACTERIZATION OF PETROLEUM FRACTIONS

Ever since the advent of petroleum technology, trends, regularities, and interrelations of properties have been observed between various petroleum fractions. Watson, Nelson, and coworkers¹¹⁻¹⁴ have established general correlations between many of the more common physical and physicochemical properties of petroleum fractions. It may be concluded from the results of their work that each of these properties is a unique function of any two of the others. In other words, any two of these properties may be used as independent variables to correlate a third as the dependent variable and the correlation so obtained is general for hydrocarbon mixtures. A fundamental requirement of any one of these interdependent variables is that it be a property of the bulk hydrocarbon material and distinct from, or of basically different nature from, any other such property. (The effect of variations of sulfur content and other nonhydrocarbon impurities is not accounted for, but the errors so introduced are apparently minor.)

In analyzing a mass of true-boiling-point-gravity data on fractions from many crudes it was observed that the factor

$$K = \frac{\sqrt[3]{T_b^{\circ}R}}{S_{60}}$$

where ($T_b^{\circ}R$) is the mid-boiling point of the fraction, is *nearly constant for all fractions from the same crude oil.*

K is designated *UOP Characterization Factor*. Its numerical value depends primarily upon molecular structure and to a slight extent upon molecular weight, as may be deduced from its values for several pure hydrocarbons (see accompanying table)

	<i>K</i>		<i>K</i>
<i>n</i> -Hexane.....	12.8	Hexene-1.....	12.5
2-Methylpentane.....	12.8	3-Methylpentene-1.....	12.45
3-Methylpentane.....	12.65	Heptene-1.....	12.4
<i>n</i> -Heptane.....	12.7	Octene-1.....	12.4
<i>n</i> -Octane and heavier <i>n</i> -paraffins.....	12.65	Benzene.....	9.75
Cyclopentane.....	11.15	Toluene.....	10.15
Methylcyclopentane.....	11.35	Xylenes.....	{ 10.3 10.45
Cyclohexane.....	11.0		
Methylecyclohexane.....	11.3		

¹¹ *Ind. Eng. Chem.*, **25**, 880 (1933) (UOP Booklet No. 127).

¹² *Ind. Eng. Chem.*, **27**, 1460 (1935) (UOP Booklet No. 196).

¹³ Article presented before World Power Conference, 1936, (UOP Booklet No. 186).

¹⁴ *Ind. Eng. Chem.*, **29**, 1408 (1937) (UOP Booklet No. 222).

It is evident that the greatest differences occur in going from paraffins to naphthenes to aromatics. Thus the Characterization Factor is uniquely suited to characterizing crude oils and their fractions according to *base* or *type*. The Characterization Factor has also proved to be a valuable key or tool to correlate many properties of petroleum fractions.

In order to correlate the properties of mixtures, an additive basis for each property must be known so that the proper method of averaging may be used. As noted earlier in the chapter, specific gravity is additive with volume fractions, and API gravity is additive with weight fractions. K is the cube root of the boiling point divided by the specific gravity. It may be shown algebraically that the K value of a mixture is the sum of its component K 's onto their *respective weight fractions*. Thus,

$$K_{\text{mix}} = K_1w_1 + K_2w_2 + K_3w_3 + \dots \quad (16)$$

where w is a fraction by weight. In the derivation of Eq. (16) it is also seen that K is the sum of the volume fractions *onto the cube roots of their respective boiling points* and divided by the specific gravity of the mixture. A boiling point of a mixture obtained by this method of averaging is designated *cubic average boiling point* and is inherent in all correlations involving either K or viscosity.

Average Boiling Points. The *boiling range* of an oil possesses the highest degree of individuality of any of its common properties and is indispensable for accurately correlating *wide-boiling fractions*. Fortunately, the boiling range is frequently available from routine laboratory tests. The normal or atmospheric boiling temperature is used in all correlations. (For an oil distilled under vacuum, the observed temperatures are converted to their atmospheric pressure equivalents by a vapor-pressure chart.)

In laboratory distillations of petroleum, boiling temperatures are recorded at various percentages or fractions *by volume*. An average boiling point calculated from these data is then the *volumetric average boiling point*. It has been noted that the volumetric average is not the correct basis for averaging and correlating all properties of an oil. The following kinds of average boiling points are distinguished: *volumetric average*, *weight average*, *true molal average*, *cubic average*, and *mean average*. The *true molal average boiling point* is

$$(T_b)_{\text{tm}} = x_A(T_b)_A + x_B(T_b)_B + x_C(T_b)_C + \dots \quad (17)$$

where x is the mol fraction of a compound or a narrow-boiling component, and T_b is its normal boiling point. The *cubic average boiling point* is

$$(T_b)_{\text{cu}} = [v_A(T_b)_A^{3/2} + v_B(T_b)_B^{3/2} + v_C(T_b)_C^{3/2} + \dots]^2 \quad (18)$$

where v is the fraction by volume of a compound or a narrow-boiling component and T_b is in °R or °K throughout. The mean average boiling point is the arithmetic mean of true molal and cubic averages.

A pure hydrocarbon has no boiling range and only one normal boiling point. Narrow-boiling fractions (spreading 50°F or less) show such slight differences in the various average boiling points that the midpoint or 50 per cent temperature may be used as any average. Wider boiling fractions have greater differences between the various average boiling points, which differences should not be neglected. For wide fractions,

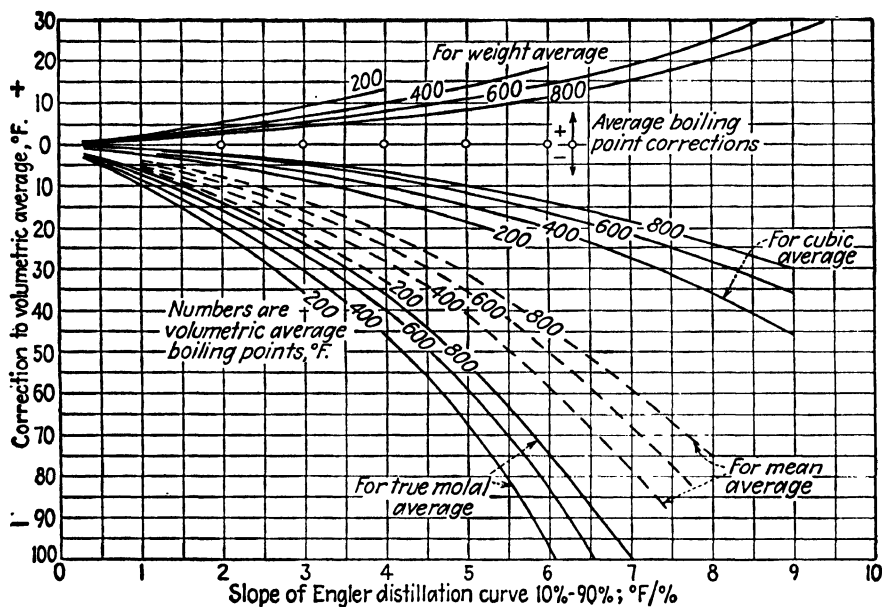

FIG. 5.—Interconversion of the various average boiling points. (Courtesy of Universal Oil Products Company.)

a graphical method of converting the volumetric average to other average boiling points is more convenient than the above equations. The volumetric average boiling point is first computed from ASTM or Engler distillation data. It is defined as the average of the 10, 30, 50, 70, and 90 per cents distilled (recovery plus loss).

The width of boiling range is measured by the slope of the distillation curve, computed as follows:

$$\text{Slope} = \frac{90 \text{ per cent temp} - 10 \text{ per cent temp}}{80} \quad (19)$$

Figure 5 gives the differences between the volumetric and other average boiling points in terms of this slope. The other boiling points

are obtained by adding the temperature correction from Fig. 5 to the volumetric average. (The weight average boiling point is higher, but the others are all lower than the volumetric average.)

In the development of correlations, it was found that K and viscosities are each additive with the cubic average boiling point.¹⁴ All other cor-

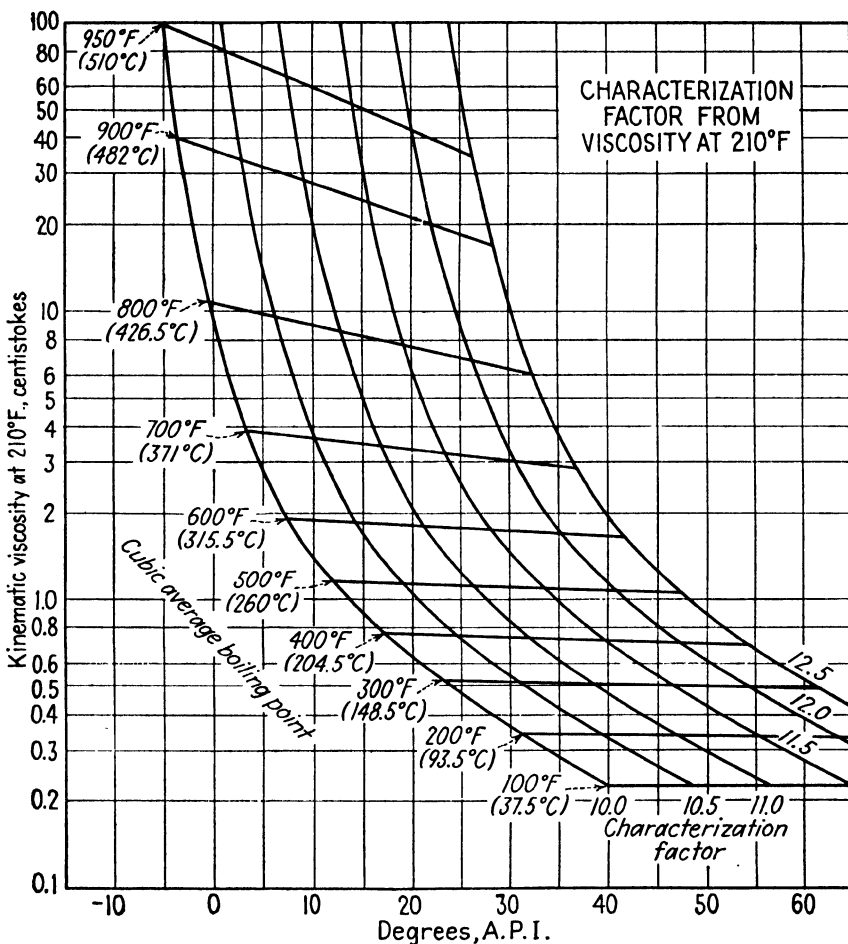

FIG. 6.—(Courtesy of Universal Oil Products Company.)

relations given in this chapter and in Chap. V that involve boiling point are based upon the mean average.

Since the distillation of heavy oils is not a routine laboratory test, K values for such oils are often obtained from the correlation of K with viscosity. The viscosity correlations are given in Figs. 6 to 8 with

viscosity units in centistokes at 210, 122, and 100°F, respectively. (Conversions of viscosity units are given in Appendix Table 11.)

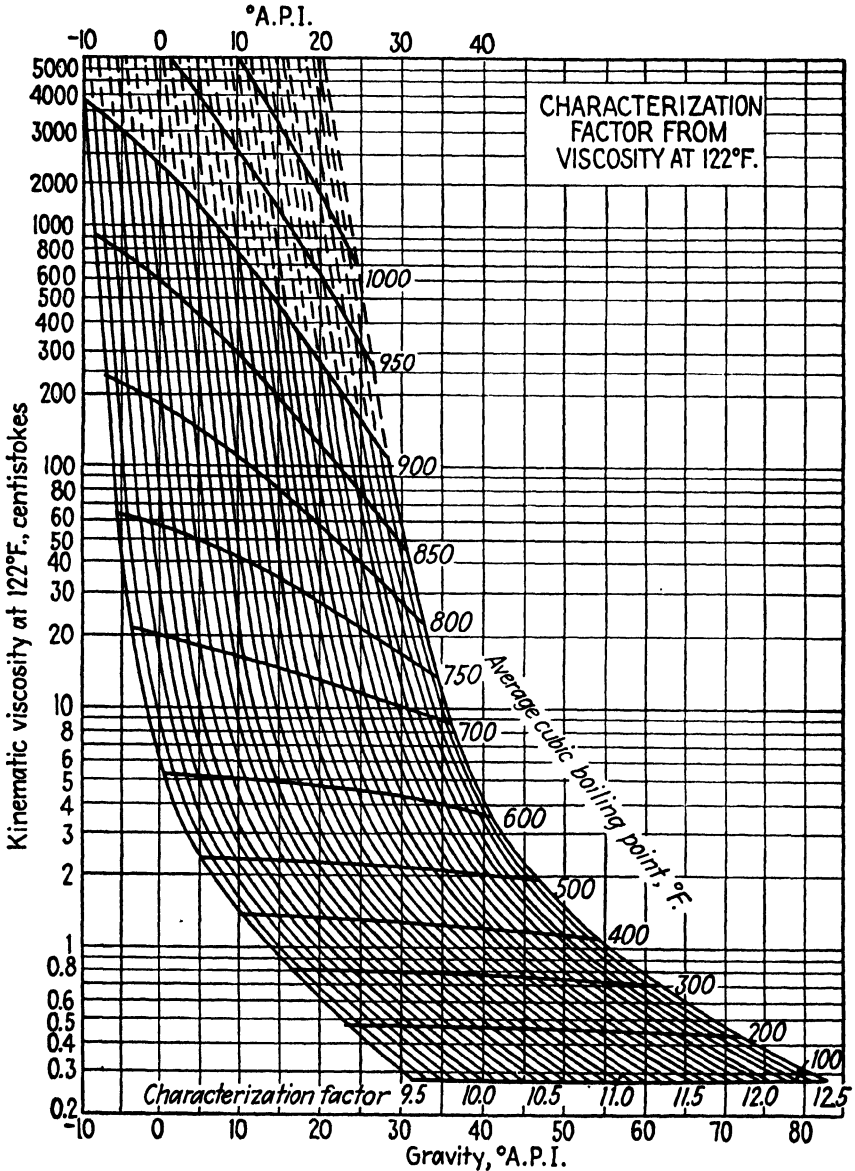

FIG. 7.—(Courtesy of Universal Oil Products Company.)

Viscosities at 210°F give more dependable K values than do viscosities at lower temperatures.

The molecular weight correlation is given in Fig. 9 in terms of *mean average boiling point*, with K in terms of *cubic average boiling point*.*

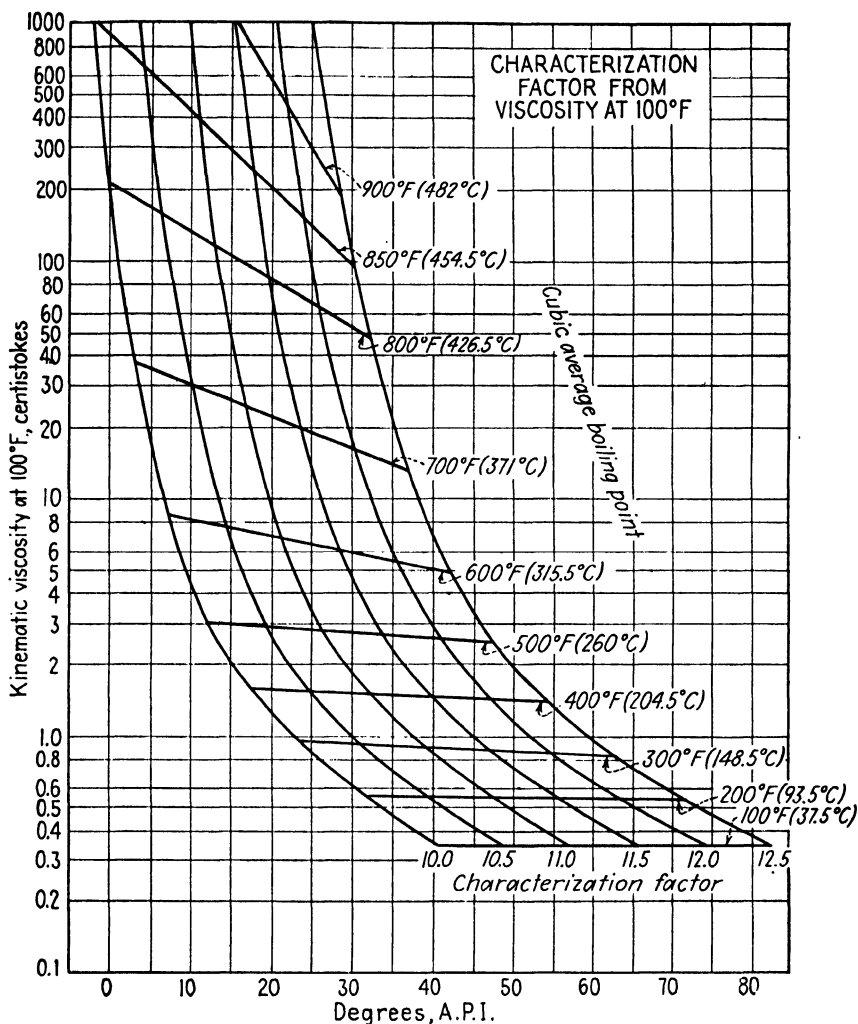

FIG. 8.—(Courtesy of Universal Oil Products Company.)

Illustration 5

The 10, 30, 50, 70, and 90 per cent temperatures on the ASTM distillation of a straight-run gasoline sample are 148, 200, 244, 294, and 352°F respectively. Its API gravity is 61.3.

* Wide-boiling fractions have cubic average boiling points significantly higher than their mean averages, and their molecular weights obtained directly from K are somewhat higher than the true values. This source of error is inherent with the use of

- a. What are its volumetric, cubic, mean, and molar average boiling points?
 b. What is its average molecular weight? its K value? What type of crude did it come from?

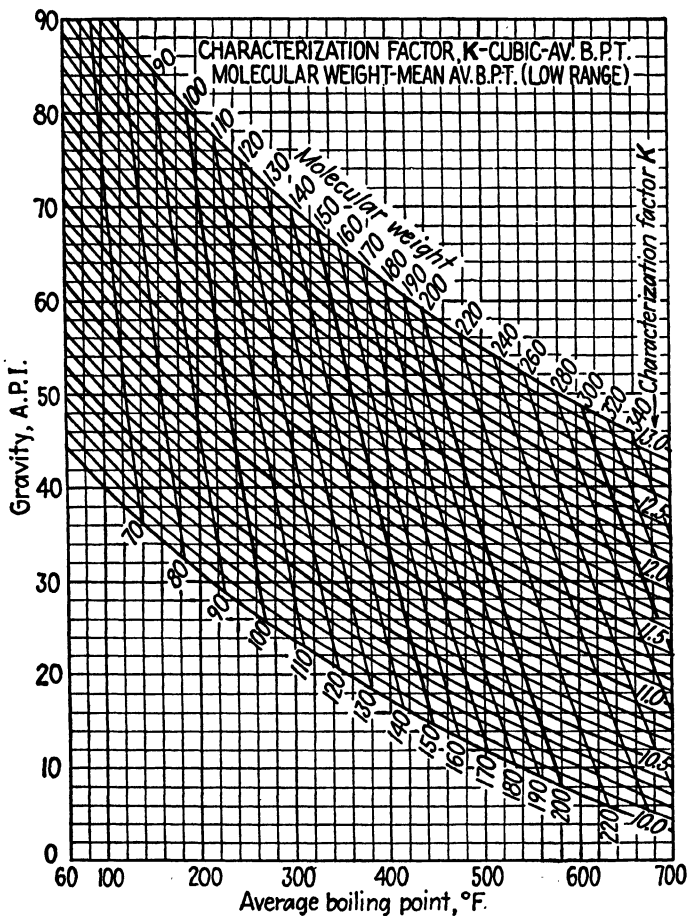

Fig. 9.—(Courtesy of Universal Oil Products Company.)

Solution: a. The volumetric average boiling point is

$$\frac{148 + 200 + 244 + 294 + 352}{5} = 248^{\circ}\text{F}$$

The slope is $(352 - 148)/80 = 2.55^{\circ}\text{F}/\text{per cent}$.

From Fig. 5, the correction for the cubic average boiling point is -6° , the correction for the mean average boiling point is -17° , and the correction for the molar

variables having disproportionate bases in the same correlation. A similar error occurs when K is used to correlate any property that is not additive with the cubic average boiling point.

average boiling point is -27°F . The cubic, mean, and molar averages are then $248 - 6 = 242^{\circ}$, $248 - 17 = 231^{\circ}$, and $248 - 27 = 221^{\circ}\text{F}$, respectively.

b. From Fig. 9, the molecular weight is 106 and the K value is 12.1. The K value is that of a paraffin-base crude.

HYDROGEN CONTENT OF PETROLEUM FRACTIONS

The hydrogen content is closely associated with a number of the important properties of oils and is also needed for combustion calculations. Nevertheless the determination of hydrogen is not a routine petroleum test, and it is rather infrequently made in most refinery laboratories. A correlation of hydrogen content in terms of K and *average boiling point* has been reported¹² and was later improved with the substitution of *API gravity* in place of K .¹⁵ The later unpublished correlation is satisfactorily approximated by the relation

$$\text{Wt per cent } H = 14.2 + 0.173 ({}^{\circ}\text{API}) - \frac{7250}{T_b^{\circ}\text{R}} \quad (20)$$

where $T_b^{\circ}\text{R}$ is the *mean average boiling point in degrees Rankine*.

When the boiling point of a sample is not known, T_b may be eliminated in terms of K and S_{60} , using the definitions of K and of the API gravity. The resulting equation is

$$\text{Wt per cent } H = \left(\frac{24.5}{S_{60}} \right) - \left(\frac{19.4}{S_{60}K} \right)^3 - 8.6 \quad (21)$$

These equations are useful for estimating the hydrogen content of oils when direct determinations have not been made. When they are applied to pure hydrocarbons, Eqs. (20) and (21) give accurate values for paraffins and for aromatics, but for olefins and naphthenes they give scattered values that are sometimes in error by as much as 2 weight per cent hydrogen. However, positive and negative errors are about equal in number and magnitude, when all hydrocarbons are considered. Applied to the highly complex petroleum fractions, the correlation values are usually within 0.2 or 0.3 weight per cent hydrogen of the true values.

Refinery Operations. The K value and *hydrogen content* are among the properties of oils affected by refining operations. Most crude oils have K values between 10.0 and 12.5, and hydrogen contents between 11 and 15 weight per cent.

K values of straight-run fractions are about the same as those of the parent crude oils. K values of fractions from some crudes increase slightly with the boiling point of the fraction, whereas the opposite is true of fractions from other crudes. The hydrogen content of successive fractions always decreases as the boiling point increases. Hydrogen

¹⁵ WATSON, K. M., private communication, 1941.

content of straight-run gasoline is usually 14.5 to 15.5 weight per cent and that of kerosine is very slightly lower. The hydrogen content of heavier fractions varies rather widely between different types of crudes. Straight-run residua from various crudes contain anywhere from 10 to 14.5 weight per cent hydrogen.

Thermal cracking operations produce methane and other gaseous hydrocarbons that contain relatively high percentages of hydrogen, and liquid products correspondingly poorer in hydrogen. *K* values of cracked oils range from a high of about 11.8 for cracked gasolines to a low of about 9.8 for cracked residua. The hydrogen contents are about 14 to 8.5 weight per cent, respectively.

Catalytic conversion processes are highly selective as to the types of reactions that occur. Where considerable dehydrogenation occurs, the *K* value of the products may be lower than that of the charge. Condensation processes (such as polymerization and alkylation) do not affect the hydrogen content but often give products having higher *K* values than part or all of the reactants. Hydrogenation usually increases the *K* value. Treating operations in general remove highly unsaturated, low-hydrogen, highly condensed compounds. The raffinates have higher hydrogen contents and higher *K* values than the untreated stocks. Dewaxing is the exception.

The petroleum refiner must blend or proportion refinery stocks into finished products that meet certain specifications. "Specifications" are maximum or minimum values or permissible ranges of values of various tests, as agreed upon by buyer and seller or as listed by some agency. Three or more specification tests are required on most petroleum products. Where the specification test values are additive on known bases, the proportions of the various stocks required to make a specification product may be determined by the use of the equations of this chapter. General simultaneous equations for blending calculations have been published.¹⁶

Supplementary Reference

DEANESLY and CARLETON: *J. Phys. Chem.*, **46**, 859 (1942).

Exercises

1. Calculate the API gravity at 60°F, and the Reid vapor pressure at 100°F of a natural gasoline of the following analysis:

	<i>n</i> -Butane	Isopentane	<i>n</i> -Pentane	<i>n</i> -Hexane and heavier ^a
Mol %	23	13	56	8

^a Sp gr of the 8 per cent fraction = 0.732, and its av MW = 102.

¹⁶ LUKOFSKY, S. S., *Ind. Eng. Chem.*, **36**, 1085 (1944).

2. A "wet" gas from a well separator has the following composition:

	Mol %		Mol %
Methane.....	63.2	<i>n</i> -Butane.....	7.0
Ethane.....	6.0	<i>n</i> -Pentane.....	10.2
Propane.....	2.1	<i>n</i> -Hexane.....	11.5

Calculate (a) the gallons of natural gasoline in 1,000 cu ft of this gas, measured at 60°F and 1 atm, (b) the API gravity of this gasoline.

3. The Reid vapor pressure of the gasoline of Exercise 1 is to be reduced to 18 psia at 100°F by fractionation in a highly efficient stabilizer. Calculate the composition of the 18-lb gasoline, the mol per cent loss, and the volume per cent loss (of butane).

4. It is desired to make a "tender" of 50,000 bbl (42 gal/bbl) of gasoline by blending proper proportions of refinery gasoline and the natural gasoline of Exercise 1 so that the blend will have an API gravity of 60.5°. The refinery gasoline tested as follows: gravity = 56.8, Reid vapor pressure at 100°F = 7.5 lb, av MW = 114.

Calculate (a) the number of barrels of each gasoline stock required and (b) the Reid vapor pressure at 100°F of the finished gasoline.

5. For a mixture of 50 gal of benzene with 50 gal of *n*-octane, calculate,
- Molecular weight; volumetric and molar average boiling points.
 - Cubic and mean average boiling points, °API, *K* value.
 - Using the appropriate charts and the calculated average boiling points, read off *K*, average molecular weight, slope of ASTM distillation curve.

Data	MW	°API	<i>S</i> ₆₀	<i>T</i> _b °F
Benzene.....	78	28.5	0.8844	176
<i>n</i> -Octane.....	114	68.6	0.7072	258

CHAPTER IV

COMBUSTION STOICHIOMETRY

The two fundamental laws most frequently used by the engineer are conservation of matter and conservation of energy. These are the bases of *material balances* and of *heat balances* around industrial processes.

These balances are of the greatest helpfulness when applied to *continuous* operations. Most furnace operations are or can be treated as continuous or as semicontinuous, with respect to air, fuel, and flue gases. Since both chemical reactions and conversion of chemical energy into heat are involved, combustion problems are excellent examples of the utility of both types of balances.

A material balance gives a clear and concise overall picture of a process. It enables a certain amount of missing information to be computed. When data are complete, it often permits checks upon their accuracy so that confidence may be placed upon the final results.

Although simple in principle, a material balance around a combustion operation often involves considerable detail. It must also be completed before a heat balance can be made. Mastery of the material balance is therefore prerequisite to the development of the heat balance as well as to further process calculations. This chapter is confined to the principles and methods of calculation used in making the combustion material balance. The overall heat balance is formally introduced in Chap. V.

USE OF MOLAR UNITS

The proportions of the various materials entering into any chemical reaction must obey the law of combining weights: *Different elements combine in fixed and definite proportions by weight.* However, it is but seldom that these weight ratios are simple whole numbers although the numerical ratios of atoms and molecules reacting are always integers.

It is clear that a tremendous amount of time and arithmetic will be saved if in such calculations, a *unit is used that represents a definite number of atoms or molecules* (see accompanying table).

	CH ₄	+	2O ₂	→	CO ₂	+	2H ₂ O
Atomic wt.....	12 1.008		16		12 16		1.008 16
Molecular wt.....	16.032		32		44		18.016
Total wt.....	16.032		64		44		36.032
No. molecules.....	1		2		1		2

A *molar unit* having this advantage is very simply obtained by expressing the atomic or molecular weight of substances in grams or in pounds (weight). Thus, a gram atom or a pound atom of carbon weighs 12 g or 12 lb, respectively. A gram mol or a pound mol of oxygen weighs 32 g or 32 lb. (A gram atom or gram mol of *any substance* contains 6.02×10^{23} atoms or molecules, and a pound atom or pound mol contains 2.7×10^{26} atoms or molecules. The value for the gram atom or gram mol is called *Avogadro's number*.) The important fact is that the molar ratios involved in any quantitative chemical reaction are always simple integers or fractions: *e.g.*, 1 mol of carbon reacts with $\frac{1}{2}$ mol of oxygen to form 1 mol of carbon monoxide, or with 1 mol of oxygen to form 1 mol of carbon dioxide.

Liquid and solid materials are measured by weight, and weights may be directly converted to mols whenever the molecular weight is known. Gaseous materials are measured by volume. Conversion of gas volumes to mols is more complicated since the pressure and temperature of measurement must be known as well as the behavior of the gas with respect to the *ideal-gas law*.

Molar Volume of Ideal Gases. Avogadro was the first to recognize that at the same temperature and pressure all materials in the gaseous state have nearly the same number of molecules per unit volume. "Standard conditions" of temperature and pressure are *chosen* as 0°C and 1 atm. At standard conditions (SC), 1 g mol of an ideal gas occupies 22.4 l, and 1 lb mol occupies 359 cu ft.

IDEAL-GAS LAWS

The experimental gas laws of Boyle, Charles, and Gay-Lussac, and of Avogadro combine into the *ideal gas law*, which was later deduced from kinetic theory:

$$pv = nRT \quad (1)$$

where p = pressure

v = volume

n = number of mols

R = ideal-gas constant

T = temperature, °K or °R

The numerical value of the gas constant (R) depends only upon the units in which the variables are expressed. For the purposes of this chapter, Eq. (1) may be converted into a more convenient form in which the gas constant need not be evaluated. Dividing Eq. (1) by itself and solving for v_1 , we obtain

$$v_1 = v_0 \left(\frac{p_0}{p_1} \right) \left(\frac{T_1}{T_0} \right) \quad (2)$$

With Eq. (2), volumes of *individual gases* and *gas mixtures* may be converted from one condition of temperature and pressure to any other condition. The pressure and temperature terms appear as separate ratios, and so each term is independent of the units employed in it. However, each pressure and each temperature must be expressed in the same unit and the unit must be of an absolute scale. In engineering work, the most common units for Eq. (2) are

$$\begin{aligned}v &= \text{cu ft} \\p &= \text{psia} = (14.7 + \text{psig}) \\T &= \text{°R} = (460 + \text{°F})\end{aligned}$$

Although subscript 0 commonly refers to standard conditions of temperature and pressure, it may apply to other specified sets of conditions.

Laws of Dalton and of Amagat. For ideal gases under conditions in which they do not react with one another, it follows from Avogadro's law that there should be no change in total volume on mixing at the same temperature and pressure. This is formally stated as the law of Amagat: *The total volume of a gas mixture is the sum of the volumes of its constituents, all at the same temperature and total pressure.* For gases A, B, C, etc.,

$$v_{\text{total}} = v_A + v_B + v_C + \dots \quad (3)$$

In a mixture, v_A , v_B , v_C , etc., are designated *partial volumes*.

In a mixture that obeys the gas law, the *partial pressure* of a pure constituent may be defined as *that pressure which the constituent alone would exert in the same total volume.* It follows that the *sum of the partial pressures equals the total pressure.* This relation has also been confirmed experimentally and is known as Dalton's law. Algebraically

$$p_A + p_B + p_C + \dots = p_{\text{total}} = \pi \quad (4)$$

(The symbol π is used hereafter to designate the total pressure of a gas or a vapor mixture.)

As applied to mixtures, the gas laws may be written in several forms:

$$\begin{aligned}\pi(v_A + v_B + v_C + \dots) &= (n_{\text{total}})RT & (1a) \\(p_A + p_B + p_C + \dots)(v_{\text{total}}) &= (n_{\text{total}})RT & (1b)\end{aligned}$$

and of course,

$$n_A + n_B + n_C + \dots = n_{\text{total}}$$

The *mol fraction* of gas A, (y_A in a mixture) is $y_A = \frac{n_A}{n_{\text{total}}}$, and it may be seen from Eq. (1a) that the partial pressure of one component is equal to its mol fraction times the total pressure;

$$p_A = \pi \left(\frac{n_A}{n_{\text{total}}} \right) = \pi y_A$$

Note also that the *ratios* of partial pressures, of volumes, and of mol fractions of two components of a gas mixture are all equal;

$$\frac{p_A}{p_B} = \frac{v_A}{v_B} = \frac{n_A}{n_B}$$

Validity of the Gas Laws. No actual gas exactly obeys the ideal-gas law. Under most conditions encountered in practice, the actual volume is smaller than the ideal-gas law volume. According to the *theorem of corresponding states*, this *negative deviation* increases (becomes greater) as the critical pressure and temperature of the substance are approached, and is greatest at the critical conditions.

For the fixed gases of air and combustion or flue products, the ideal-gas law is a good approximation at the usual pressures and temperatures. The gas law is also satisfactory for water vapor at the low partial pressures in which it occurs in humid air and in flue gases. On the other hand, gas-law deviations for hydrocarbon gases are appreciable. In general, the deviations increase with molecular weight of various substances, although exceptions may be found.

Hereafter, Eqs. (1) to (4) are assumed valid for the constituents of air and of flue gases in combustion calculations.

ESSENTIAL CONSTANTS AND CONVERSION FACTORS

The following quantities are used so frequently that all should be committed to memory. No more than three significant figures are given in any case, since calculations are to be made with an engineer's slide rule.

Atomic Weights:

$$C = 12, \quad H = 1.01, \quad O = 16, \quad N = 14, \quad S = 32$$

Weights and Measures:

1 inch = 2.54 centimeters

1 pound = 454 grams = 0.454 kilogram

1 kilogram = 2.2 pounds

1 cubic foot of water (60°F) = 7.48 gallons = 28.3 liters = 62.3 pounds

1 gallon of water (60°F) = 231 cubic inches = 3.78 liters = 8.33 pounds

Pressures:

1 atmosphere = 0 pounds per square inch gauge = 14.7 pounds per square inch absolute = 29.9 inches Hg = 760 millimeters Hg

1 pound per square inch = 16 ounces (gas pressure) = 27.7 inches water

Temperatures:

Water freezes at $\begin{cases} 0^\circ\text{centigrade} = 273^\circ\text{Kelvin} \\ 32^\circ\text{Fahrenheit} = 492^\circ\text{Rankine} \end{cases}$

Water (at 1 atmosphere) boils at $\begin{cases} 100^\circ\text{centigrade} = 373^\circ\text{Kelvin} \\ 212^\circ\text{Fahrenheit} = 672^\circ\text{Rankine} \end{cases}$
 T (degrees Rankine) = $1.8 \times T$ (degrees Kelvin)

Latent Heat of Vaporization of Water (at 212°F) = $\begin{cases} 970 \text{ Btu per pound} \\ 540 \text{ calories per gram} \end{cases}$

Standard Conditions of Gas:

1 atmosphere and freezing point of water

Molar Volume of Gases:

1 pound mol *ideal gas* occupies 359 cubic feet at standard conditions

(Use 359 for air and flue gases)

1 pound mol *fuel gas* occupies 356 cubic feet at standard conditions

Composition of Dry Air. The minor constituents of dry atmospheric air are 0.94 per cent argon, 0.03 per cent CO_2 , traces of other rare gases, of ozone, and of hydrogen.

For purposes of combustion stoichiometry, the *molecular weight of dry air is 29.0*, and it is commonly assumed to consist of 21.0 per cent oxygen and 79.0 per cent nitrogen. The true oxygen content is between 20.9 and 21.0 per cent.

As discussed later, Orsat analyses for oxygen are frequently low by 0.1 per cent or more. Any analytical error in oxygen content is greatly magnified in stoichiometric values derived from Orsat analyses, particularly where the oxygen concentration is low as in flue gases. *The effects of slight errors in Orsat analyses are appreciably reduced by taking the composition of air as 20.9 per cent O_2 and 79.1 per cent N_2 , and these values are therefore employed throughout this text.*

Illustration 1

A fuel oil contains 86.0 per cent carbon, 12.0 per cent hydrogen, and 2.0 per cent sulfur (wt). If, for 100 lb of the oil, the carbon is converted to CO_2 , the hydrogen to H_2O (vapor), and the sulfur to SO_2 , calculate,

- The pound mols of each gas formed.
- The total volume of these gases at 600°F and 1 atm.
- The total volume of these gases at 500°F and 740 mm.
- The partial volume of each gas in (c).
- The partial pressure of each gas in (c).

Solution (basis, 100 lb oil):

a.

	Wt % = lb	Mol. wt	Mols = (lb)(mol. wt)
Carbon, C.....	86.0	12.0	7.16
Hydrogen, H_2	12.0	2.02	5.94
Sulfur, S.....	2.0	32.0	0.06
Total.....	13.16

b. The molar volume at 600°F and 1 atm is

$$\frac{359(460 + 600)}{492} = 773 \text{ cu ft}$$

The total volume of gas is $(13.16)(773) = 10,170 \text{ cu ft}$

c. The total volume at 500°F and 740 mm is

$$(13.16)(359) \frac{(460 + 500)(760)}{(492)(740)} = 9,450 \text{ cu ft}$$

d. Since the partial volume is equal to the mol fraction times the total volume,

$$\text{Partial volume of CO}_2 = (9,450)(7.16/13.16) = 5,145 \text{ cu ft}$$

$$\text{Partial volume of H}_2\text{O} = (9,450)(5.94/13.16) = 4,262 \text{ cu ft}$$

$$\text{Partial volume of SO}_2 = (9,450)(0.06/13.16) = 43 \text{ cu ft}$$

e. Since the partial pressure is equal to the mol fraction times the total pressure,

$$\text{Partial pressure of CO}_2 = 740(7.16/13.16) = 403 \text{ mm}$$

$$\text{Partial pressure of H}_2\text{O} = 740(5.94/13.16) = 333 \text{ mm}$$

$$\text{Partial pressure of SO}_2 = 740(0.06/13.16) = 4 \text{ mm}$$

COMPOSITION OF FUELS AND THEIR COMBUSTION PRODUCTS

The principal constituents of commercial fuels are *carbon* and *hydrogen*. Smaller amounts of other substances are usually present. Fuel oils contain sulfur compounds and may contain minor amounts of oxygen, traces of nitrogen, and sediment or dirt. Coal contains all of these as well as iron compounds and other minerals which are usually designated more specifically than as merely *dirt*.

Of the *total* hydrogen and oxygen in fuels, part of each may be chemically combined with carbon and part exist as moisture. Most of the hydrogen is usually in combination with carbon. Commercial fuels always contain more total hydrogen than the chemical equivalent of the total oxygen. In combustion stoichiometry, this *oxygen equivalent* is subtracted from the total hydrogen, the remainder being designated as *net hydrogen*. Then, all of the carbon plus the net hydrogen in a fuel may be considered as available for burning and producing heat.

In most cases of furnace operation, the carbon burns almost quantitatively to carbon dioxide and the hydrogen to water vapor. Sulfur and iron burn chiefly to sulfur dioxide and to ferric oxide, respectively. Oxygen for combustion is supplied by the air, and ordinarily an excess is admitted to a furnace. When the excess is too low or nonexistent, carbon monoxide appears in the flue gas; when the carbon monoxide content of the flue gas is appreciable, free hydrogen will also be present.

Overall combustion reactions that apply to any fuel may be written

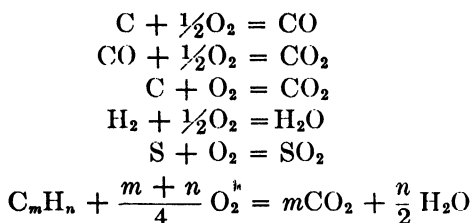

Each term in the above equations represents a mol or fraction of a mol as the case may be. Then from the analysis of the fuel with respect to carbon, hydrogen, oxygen, and sulfur, the amount of air necessary to burn it to CO_2 , H_2O , and SO_2 may be calculated. This quantity is known as *theoretical air*.

Illustration 2

A coal contains 78.0 per cent carbon, 3.6 per cent hydrogen, 1.2 per cent nitrogen, 0.7 per cent sulfur, and 4.9 per cent oxygen.

What is the per cent net hydrogen? How many mols of (theoretical) air are required to burn 100 lb of the coal?

Solution: 100 lb of coal contains 4.9 lb or $4.9/32 = 0.153$ mols of oxygen. This oxygen requires $(0.153)(2) = 0.306$ mols or $(0.306)(2.02) = 0.618$ lb of hydrogen to combine with it. The *net hydrogen* is then $3.6 - 0.618 = 2.98$ per cent.

To burn 100 lb of the coal:

	Lb	Mols	Mols O ₂ for theoretical combustion
Carbon.....	78	6.5	6.5
Net hydrogen.....	2.98	1.48	0.74
Sulfur.....	0.7	0.02	0.02
Total O ₂ required from air..	7.26

The theoretical air is then $(7.26)(100/20.9) = 34.7$ mols.

THE ORSAT ANALYSIS

The analysis of flue gas with respect to CO_2 , O_2 , and CO is readily obtained with the *Orsat apparatus*, which consists of a gas-measuring burette (usually of 100 cc capacity) and three absorption pipettes, each containing a chemical solution that absorbs one of the gases (Fig. 1). Starting with a 100-cc sample of the flue gas, the carbon dioxide is first absorbed by passing the gas sample back and forth between the absorption pipette and the measuring burette until no further absorption occurs. The shrinkage in gas volume is then the percentage of CO_2 in the sample. This procedure is repeated to determine the oxygen and finally the carbon monoxide, using the separate pipettes provided for each. The gas remaining unabsorbed is considered to be nitrogen.

Water Vapor and the Orsat. The gas in the measuring burette is in contact with water. Aqueous solutions or mercury with a few drops of water on its surface are used as confining liquids. *The gas rapidly becomes saturated with water vapor at the temperature of the instrument.* As long as the instrument temperature does not change, the *partial pressure* of water vapor is the same at each reading, and the *percentages* of gas absorbed are the same as though the system were entirely dry from start to finish. The Orsat analysis is therefore numerically on the dry basis and gives no information as to the water-vapor content of the original gas. The latter value must be determined by some other means such as by the wet- and dry-bulb thermometer (see next section).

Excess Air. Knowledge of the amount of excess air being admitted to a furnace is very important. Excess air reduces the furnace temperature, which in turn reduces the rate of heat transfer. Furthermore, since all of the air that passes through the furnace must leave at the flue temperature, the excess carries out additional heat in the flue gases. An insufficient quantity of air results in incomplete combustion with the appearance of carbon monoxide and sometimes smoke in the flue gases.

Theoretical air is the calculated quantity which contains just sufficient oxygen to combine with the carbon, net hydrogen, and sulfur of the fuel to form carbon dioxide, water vapor, and sulfur dioxide. Any additional quantity is the excess. *Per cent of excess air* is numerically equal to per cent of excess oxygen from air and can be calculated by several different but equivalent expressions:

$$\begin{aligned}
 \text{Per cent excess air} &= \text{per cent excess } O_2 \text{ from air} \\
 &= \frac{(100)(\text{excess})}{(\text{theoretical})} \\
 &= \frac{(100)(\text{excess})}{(\text{total} - \text{excess})} \\
 &= \frac{(100)(\text{total} - \text{theoretical})}{(\text{theoretical})}
 \end{aligned}$$

Note that all expressions are actually based upon *theoretical oxygen*.

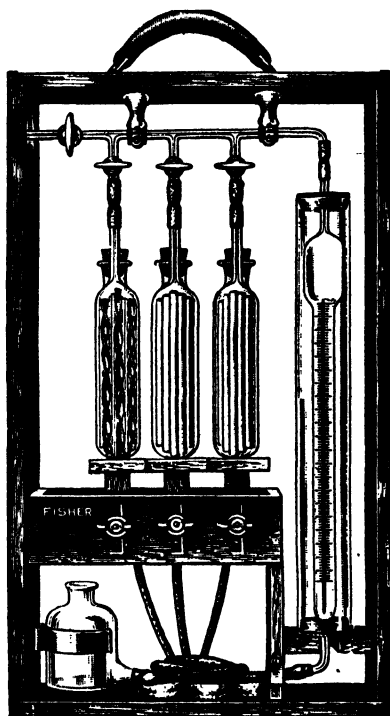

FIG. 1.—Orsat apparatus.

Excess air may be readily calculated from the Orsat analysis. The free oxygen found by the Orsat is not entirely excess oxygen if the gas contains carbon monoxide. When carbon monoxide is present, enough oxygen is deducted from the total oxygen from air to burn the carbon monoxide to dioxide, according to the definition of theoretical air.

Illustration 3

A furnace is fired with a natural gas that consists entirely of hydrocarbons (negligible inert gases and sulfur compounds). The flue gas analysis (Orsat) is 9.5 per cent CO_2 , 2.0 per cent O_2 and 1.8 per cent CO .

a. What is the molar ratio of net hydrogen to carbon in the fuel?

b. What per cent of excess air is being used?

Solution: The most convenient basis for the calculation of quantities from an Orsat flue-gas analysis is 100 mols of dry flue gas, tabulated and broken down into mols of the elements.

	Orsat % = mols	Mols C	Mols O_2
CO_2	9.5	9.5	9.5
CO	1.8	1.8	0.9
O_2	2.0	2.0
N_2	86.7 (balance)		
Total	100.0	11.3	12.4

Since the fuel contains no inert gases, all of the nitrogen in the flue gas came from air. The oxygen accompanying it is

$$86.7 \left(\frac{20.9}{79.1} \right) = 22.9 \text{ mols}$$

The total free and combined oxygen appearing in the dry flue gas is 12.4 mols, and that which *disappeared* is

$$22.9 - 12.4 = 10.5 \text{ mols}$$

This oxygen was consumed in burning net hydrogen of the fuel, and the mols of net hydrogen or water vapor are

$$10.5(2) = 21.0$$

a. The molar ratio of net hydrogen to carbon is

$$\frac{21.0}{11.3} = 1.86$$

(The atomic ratio is twice this value, and can be written $\text{CH}_{1.72}$.)

b. The excess oxygen is the free oxygen left after complete combustion. Burning the CO requires $1.8/2 = 0.9$ mols, and the excess oxygen is

$$2.0 - 0.9 = 1.1 \text{ mols}$$

The excess air is $(100) \left(\frac{1.1}{22.9 - 1.1} \right) = 5.05 \text{ per cent}$.

NOTE: The above flue-gas analysis is not typical.

HUMIDITY OF AIR AND OF FLUE GAS

Water vapor in flue gas comes from (1) water vapor in the combustion air, (2) moisture in the fuel, and (3) hydrogen in the fuel. In some cases, there is a fourth source of water vapor, such as from a steam-atomizing oil burner or steam injected into a gas producer.

Knowledge of the amount of water vapor in air and in flue gas is useful and sometimes necessary for furnace calculations. This information is essential to the proper operation of certain units such as gas producers.

Humidity may be determined with fair accuracy from *wet- and dry-bulb temperatures*.

Humidity Terms and Definitions. Water exerts a definite vapor pressure at a given temperature, and when the partial pressure of water vapor in a gas is equal to the vapor pressure of water at the same temperature, the gas is *saturated*. No additional water can be held in the gas *as vapor* at that temperature and total pressure. Any increase in total pressure or decrease in temperature will cause condensation. The saturation pressure of water vapor is designated p_s and will be used in the units of millimeters of mercury in this chapter.

Relative Humidity. Let p = actual pressure of water vapor in a gas.

Then p/p_s is the amount of water vapor present compared to the total which can be held, or the fractional saturation. $100p/p_s$ is commonly referred to in weather reports as the *per cent relative humidity*. Note that when the temperature of a gas having a definite water-vapor content is changed, p_s changes while p remains constant, and the *relative humidity* changes inversely with p_s . Engineering calculations are more convenient with humidity expressed as an absolute quantity independent of p_s than in terms of relative humidity.

Absolute Humidity. Let: H = weight humidity, as *pounds of water vapor per pound of dry air*.

H_m = molar humidity, as *mols of water vapor per mol of dry air*.

Either H or H_m may be used for hygrometric calculations. The former is the more common but the latter is more convenient where applied to flue gases. Flue-gas calculations are made on the mol basis and also the *composition* of the flue gas with respect to CO_2 must be taken into account for accurate calculation of humidity from wet- and dry-bulb temperatures.

The relations between partial pressure of water vapor and the two absolute humidities at one atmosphere pressure are

$$H_m = \frac{p}{760 - p} \quad (5)$$

$$H = \frac{18p}{29(760 - p)} \quad (5a)$$

The ratio of actual to saturated humidities for either H_m or H is a "relative humidity" similar to that given by the corresponding ratio of partial pressures, but the partial pressure ratio is not numerically equal to the absolute humidity ratio.

Humid Volume. The humid volume is the volume of some unit of dry air plus the volume of water vapor it carries (at the specified temperature and 1 atm pressure). By definition and Amagat's law,

$$\begin{aligned} V_{H_m} &= (\text{molar vol of air}) + (\text{vol of water vapor carried}) \\ &= (1 + H_m)(359) \left(\frac{T^\circ\text{R}}{492} \right) \text{ cu ft} \end{aligned} \quad (6)$$

$$\begin{aligned} V_H &= (\text{vol of 1 lb dry air}) + (\text{vol of water vapor carried}) \\ &= \left(\frac{1}{29} + \frac{H}{18} \right) (359) \left(\frac{T^\circ\text{R}}{492} \right) \text{ cu ft} \end{aligned} \quad (6a)$$

Humid Heat. The humid heat is the *heat capacity* or the specific heat of the unit of dry air plus that of the water vapor carried. The *molar heat capacity* of dry air ($M C_p$) near room temperature is approximately $7.0 \text{ Btu}/(\text{lb mol})(^\circ\text{F})$ and that of water vapor is approximately 8.1 in the same units. Hence the humid heats are

$$s_m = 7.0 + 8.1(H_m) \text{ Btu}/(\text{lb mol dry air})(^\circ\text{F}) \quad (7)$$

and

$$\begin{aligned} s &= \frac{7.0}{29} + \frac{8.1}{18} (H) \\ &= 0.241 + 0.45(H) \text{ Btu}/(\text{lb dry air})(^\circ\text{F}) \end{aligned} \quad (7a)$$

Specific Heat and Latent Heat of Vaporization of Water. The specific heat of water may be taken as $1 \text{ Btu}/(\text{lb})(^\circ\text{F})$ or $18 \text{ Btu}/(\text{lb mol})(^\circ\text{F})$.

The latent heat of vaporization (r) changes with temperature, and so must be read from a chart or table for the temperature in question.

Dew Point. As damp air or other gas containing water vapor is cooled, the *relative humidity* increases until the partial pressure of water vapor carried equals the vapor pressure of water. At that point the gas is saturated and

$$p = p_s; \quad H = H_s; \quad H_m = H_{m,s}$$

A further decrease in temperature results in condensation of enough of the water to maintain the gas in saturated condition.

Note that at 1 atm or any other constant pressure, the *dew-point temperature* depends only upon the amount of water vapor present.

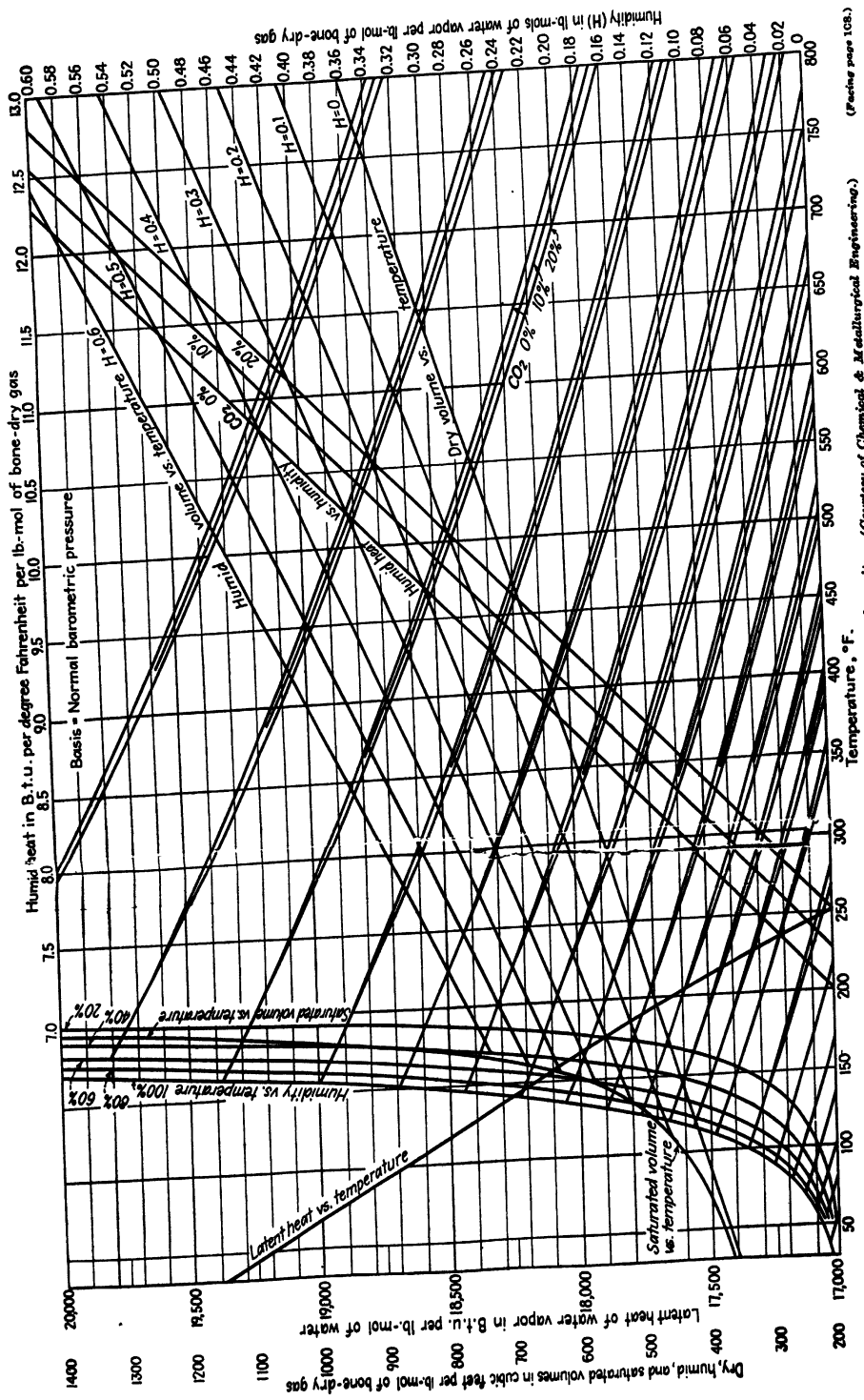

FIG. 8.—High-temperature psychrometric chart for air and combustion gases, in molar units. (Courtesy of Chemical & Metallurgical Engineering.) (Facing page 108.)

Adiabatic Humidification. Suppose that a quantity of air and a quantity of water at some lower temperature than the air are confined together in a space or zone which is thermally insulated from the surroundings, so that the enthalpy (or total heat content) of the system is constant. Heat is transferred from the air to the water and if allowed to remain in contact long enough, they will finally attain the same temperature. Also, enough water evaporates finally to saturate the air.

Now if by previous experiment the final or equilibrium temperature is known, the water may be *introduced* at that temperature. The amount of heat necessary to cool the air must then exactly balance the latent heat of the water evaporating. Such a process is called *adiabatic humidification*, and the final or equilibrium temperature of the process is called the *adiabatic saturation temperature*.

The operation is seen to involve exchange of sensible heat of the air for latent heat of vaporization of water, with water being transferred from the water phase to vapor in the air. It need not be continued to complete saturation of the air; in fact air is frequently given a definite or controlled humidity. In any case, the water-vapor content of the air increases and *adiabatic humidification temperatures are always higher than the dew points of the original air*.

Temperature-humidity Relations. For adiabatic humidification in an air-water system at 1 atm pressure, a convenient basis of calculation is 1 mol of dry air at t_1 , containing H_{m_1} mols of water vapor. If the water temperature does not change, the heat-vaporization balance is

$$\begin{aligned} (\text{Mols water evap})(\text{molar latent heat}) &= (\text{molar humid heat})(t_1 - t_2) \\ (H_{m_2} - H_{m_1})(18r_2) &= s_{m_1}(t_1 - t_2) \end{aligned} \quad (8)$$

or, for a basis of 1 lb of dry air,

$$(H_2 - H_1)(r_2) = s_1(t_1 - t_2) \quad (8a)$$

where r_2 is the latent heat of vaporization of water at temperature t_2 .

If the water temperature changes, an additional term must be included in the equation. The water vaporizing may have an initial temperature T but is properly considered to attain temperature t_2 and vaporize at t_2 . Since the sensible heat of water is unity, Eqs. (8) and (8a) become for this case,

$$18(H_{m_2} - H_{m_1})(t_2 - T + r_2) = (s_m)_1(t_1 - t_2) \quad (9)$$

$$(H_2 - H_1)(t_2 - T + r_2) = s_1(t_1 - t_2) \quad (9a)$$

When adiabatic humidification is continued until the air is saturated, t_2 , H_{m_2} and H_2 become t_s , H_{m_s} and H_s , respectively, in Eqs. (8), (8a), (9), and (9a).

Illustration 4

Air at 100°F and 1 atm has a partial pressure of water vapor of 30 mm.

a. What is its dew point?

b. What is its wet-bulb temperature?

Solution: a. The temperature at which water has a vapor pressure of 30 mm is 84°F which is its dew point.

b. From Eq. (5a), $H_1 = 0.0255$. From Eq. (7a) $s_1 = 0.252$. Since the wet-bulb temperature t_2 is interrelated with r_2 and H_2 , t_2 must be found by trial solutions of Eq. (8a).

By arbitrarily choosing a trial t_2 of 87°F, r_2 becomes 1046 and H_2 becomes 0.0281. Solving Eq. (8a) for t_2 ,

$$\begin{aligned} t_2 &= t_1 - (H_2 - H_1) \left(\frac{r_2}{s_1} \right) \\ &= 100 - (0.0281 - 0.0255) \left(\frac{1046}{0.252} \right) = 89.2^\circ\text{F} \end{aligned}$$

If r_2 and H_2 are taken at 88°F, Eq. (8a) gives $t_2 = 85.5^\circ\text{F}$. Therefore the correct temperature is between 87 and 88°F. By interpolation, $t_2 = 87.4^\circ\text{F}$. *Ans.*

Humidity Charts. Humidity computations are greatly expedited by the use of a graph of Eqs. (6) to (8) or (6a), (7a), and (8a). Figure 2 is a plot of the former set of equations (basis, 1 lb of dry air) for air-water at 1 atm. The chart is constructed as follows: The curve labeled "Humidity vs. temperature . . . 100%" is calculated from the vapor pressures of water and Eq. (5a). The family of curves below it represent the relative humidities noted. The curves sloping downward to the right and ending at the 100 per cent or saturation curve (those nearly straight and parallel) are plots of Eq. (8a). The curve labeled "Humid Heat vs. Humidity" is a plot of Eq. (7a). The curves for specific, humid, and saturated volumes versus temperature are calculated with Eq. (6a). Lastly, the latent heat of vaporization (r) is also plotted. Note that the volume curves and the latent heat curve have separate ordinate scales at the left-hand border of the plot.

Illustration 5

For air at 100°F and humidity (H) = 0.0255 (as in Illustration 4), read from Fig. 2 the relative humidity, the dew point, the wet-bulb temperature, the humid heat, and the humid volume.

Solution: The point 100°F, $H = 0.0255$ is located. Its position between the relative-humidity curves corresponds to a relative humidity of approximately 59 per cent. $H = 0.0255$ intersects the saturation curve at 84°F, which is the dew point. By moving from the original point parallel to the adjacent adiabatic humidification curves to an intersection with the saturation curve, the adiabatic saturation or wet-bulb temperature is found to be approximately 87°F. The humid heat read from the appropriate curve is 0.252. By interpolating between the curves for $H = 0.02$ and 0.04, the humid volume at 100°F is found to be 14.7 cu ft.

For flue gases, a humidity chart calculated on the mol basis is given in Fig. 3. The basic construction is the same as for Fig. 2, except that

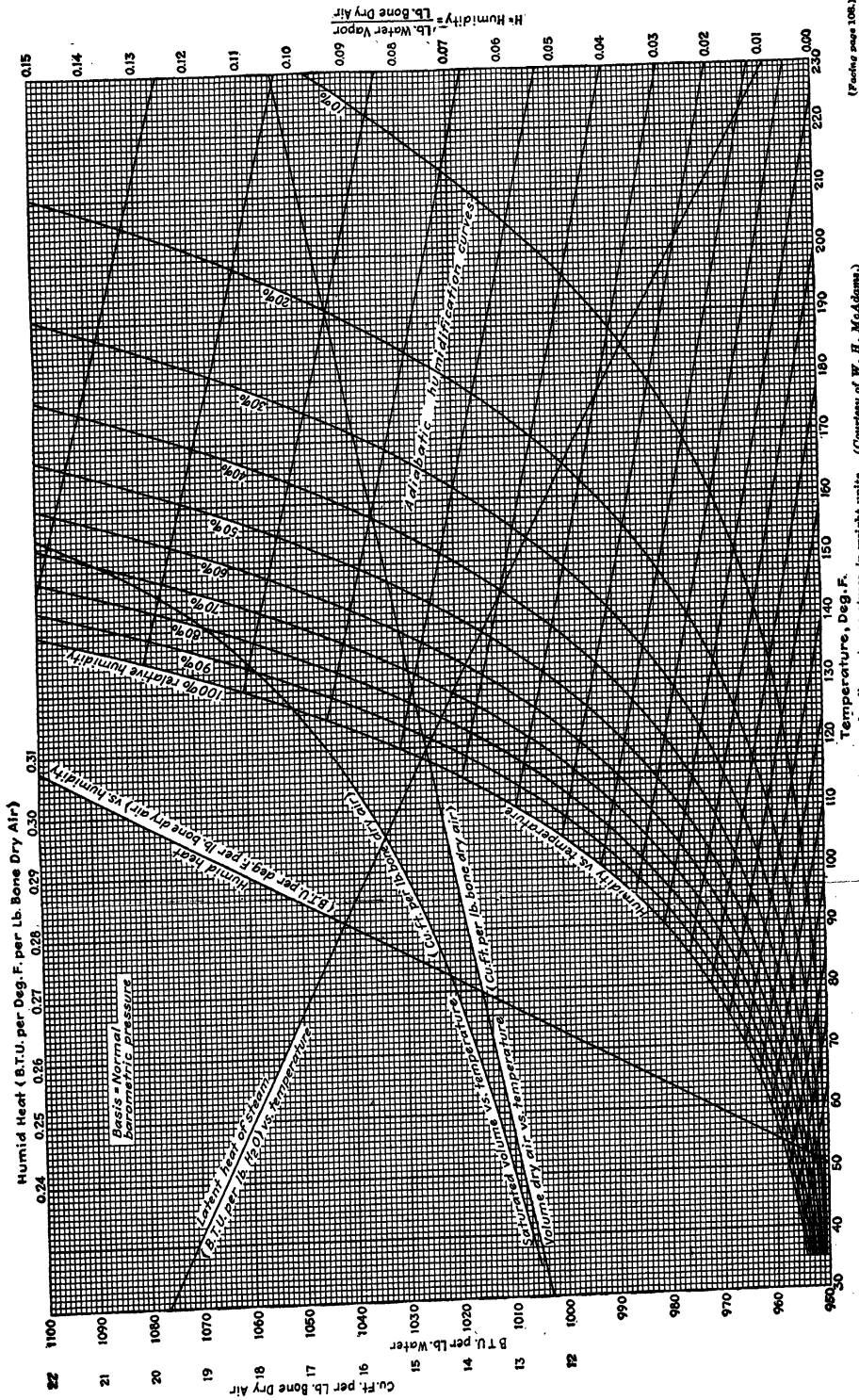

FIG. 2.—Psychrometric and humidity chart for air at 1 atm and ordinary temperatures, in weight units. (Courtesy of W. H. McAdams.)

FIG. 2.—Psychrometric and humidity chart for air at 1 atm and ordinary temperatures, in weight units. (Courtesy of W. H. McAdams.)

molar equations are used and the temperature-humidity range is extended to much higher levels. Plotting Eqs. (5) to (8) gives the curves labeled "CO₂ . . . 0%." Since flue gases contain carbon dioxide which has a higher heat capacity than air, the specific heat terms in Eqs. (7) and (8) were raised to the proper values for flue gases containing the designated amounts of CO₂. The adiabatic humidification curves are seen to be slightly affected and the humid heat curves are markedly affected by the presence of CO₂. Figure 3 is used in exactly the same manner as Fig. 2.

WET- AND DRY-BULB THERMOMETRY

When a thermometer whose bulb is kept wet with water is placed in a current of air or other gas, the water evaporates into the gas and cools the thermometer bulb. As soon as the temperature of the bulb has fallen below that of the gas stream, the bulb begins to receive heat from the gas. This effect limits the temperature decrease or "wet-bulb depression" to some definite value. When the bulb is maintained wet and the gas current is steady, the thermometer will finally indicate a constant "wet-bulb temperature." Since no water would evaporate if the gas were initially saturated, the wet-bulb depression is related to the initial humidity of the gas. If certain other variables are fixed, a relation involving only the initial gas temperature and humidity and the wet-bulb temperature is obtained. A number of psychrometric charts and tables have been prepared for determining humidities from wet- and dry-bulb temperatures.

This psychrometric mechanism is well understood. The psychrometer equation can be put into a form in which the temperatures and humidities appear exactly as in Eq. (8a). By a curious coincidence of properties of the air-water system at atmospheric pressure, ordinary temperatures, and with air velocities between 15 and 25 ft/sec, the other variables in the psychrometer equation correspond numerically to (s_1/r) of Eq. (8a). The significance of this observation is that Eq. (8a) as well as the adiabatic humidification lines on Figs. 2 and 3 may be used to determine humidities from wet- and dry-bulb temperatures, with an accuracy sufficient for most engineering purposes.*

The Sling Psychrometer. Atmospheric humidity may be readily determined with the sling psychrometer, which consists of a wet- and a dry-bulb thermometer mounted so they can be swung manually. The wet-bulb thermometer has its bulb enclosed in a wick that is dipped

* The humidity of air is also determined by methods of chemical absorption of the water vapor, and by direct observation of the dew point with apparatus developed for the purpose. The dew-point apparatus when used on flue gas does not give reliable values unless all traces of SO₂ and of dust are first removed from the gas.

into water. Trial "swings" are made to determine the approximate wet-bulb temperature, then the water is adjusted to this temperature before the final dip and swing are made.

GENERAL APPROACH FOR THE SOLUTION OF PROBLEMS

The combustion material balance involves three streams: air, fuel, and flue gas, when the fuel is gas or oil. It involves a fourth stream when the fuel contains a nonvolatile residue such as ash or cinder. The objective is to relate the quantities of these streams to their compositions.

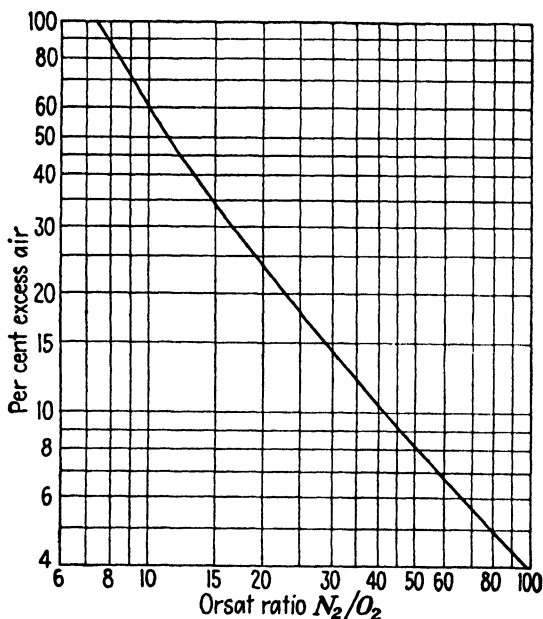

FIG. 4.—Chart for determining per cent excess air from Orsat analysis, applicable for complete combustion of hydrocarbons:

$$\text{Per cent excess air} = \frac{100}{0.2642(N_2/O_2) - 1}$$

Pure Hydrocarbon Fuels. Some fuel oils and natural gas supplies consist of substantially pure hydrocarbon material. Upon burning, all of the nitrogen and oxygen present in the flue-gas constituents come from air, which has the ratio of 3.78 mols of nitrogen per mol of oxygen. Excess air and the hydrogen-carbon ratio of the fuel may then be calculated from the Orsat analysis alone, as was done in Illustration 3. When combustion is complete (as indicated by no carbon monoxide in the flue gas), excess air and weight per cent hydrogen in pure hydrocarbon fuels can be represented in terms of the Orsat figures by single curves. These curves are given in Figs. 4 and 5, respectively.

The relation is readily established between mols of carbon plus hydrogen in the fuel, the dry air entering the furnace, and the combustion gases in the stack. To complete the material balance, the additional water vapor as humidity of the air and any water admitted with the fuel

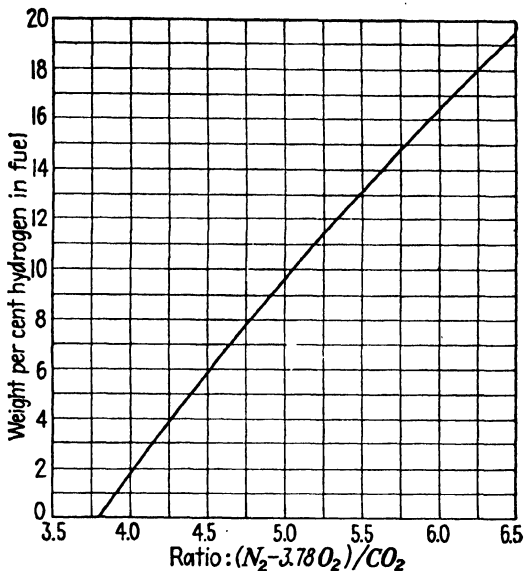

FIG. 5.—Chart for estimating hydrogen content of fuel from Orsat analysis, applicable for complete combustion of hydrocarbons:

$$\text{Wt per cent H} = 100 - \frac{1126}{\left[\frac{N_2 - 3.78 O_2}{CO_2} \right] + 7.48}$$

may be included, although water vapor as humidity in the air is relatively small in comparison to that from the total hydrogen of the fuel.

Illustration 6

Referring to Illustration 3, calculate

- a. Weight and volume at 100°F and 750 mm of dry air entering per pound of fuel burned.
- b. Volume of dry flue gas at 500°F and 750 mm per lb of fuel burned.
- c. Volume of water vapor in the flue gas per pound of fuel, assuming that the air is dry.

Solution: The ratio or proportionality of weight of fuel to mols of flue gas must first be found. In this and most other problems, it is simplest to retain the working basis of 100 mols dry flue gas until the final steps.

Weight of fuel per 100 mols dry flue gas,

$$\begin{aligned} \text{C: } (11.3)(12) &= 135.6 \text{ lb} \\ \text{H}_2: (21.0)(2.02) &= 42.4 \\ &\underline{178.0 \text{ lb hydrocarbon}} \end{aligned}$$

a. Dry air entering = $(86.7)(100/79.1)/(178) = 0.616$ mols

Its weight is $(0.616)(29) = 17.9$ lb/lb fuel

Its dry volume (100°F, 750 mm) is

$$\frac{(0.616)(359)(460 + 100)(760)}{(492)(750)} = 255 \text{ cu ft/lb fuel}$$

b. Volume of dry flue gas (500°F, 750 mm),

$$\frac{(100)(359)(460 + 500)(760)}{(178)(492)(750)} = 398 \text{ cu ft/lb fuel}$$

c. Volume of water vapor in flue gas,

$$\frac{(21.0)(359)(460 + 500)(760)}{(178)(492)(750)} = 83.6 \text{ cu ft/lb fuel}$$

If the entering air had a relative humidity of 50 per cent instead of being dry,

$$P_w \text{ at } 100^\circ\text{F} = 49.1 \text{ mm}$$

$$\text{Partial pressure of water in the air} = (49.1)(0.50) = 24.6 \text{ mm}$$

$$\frac{(0.616)(24.6)}{750 - 24.6} = 0.021 \text{ mols water vapor in air per pound of fuel}$$

or 17.8 per cent as much as from the hydrogen of the fuel.

Fuels of Complex Composition. In the general case, the fuel contains compounds of oxygen, nitrogen, and sulfur in amounts too great to neglect. With the necessary analytical data on the fuel, the quantities of fuel and of flue gas are related by a carbon balance, and the air is related to the flue gas and then to the fuel by a nitrogen balance.

The general procedure utilizes the principle employed in Illustration 6. For the Orsat analysis, a convenient basis is 100 mols of dry stack gas. A tabulation is made of the mols of total carbon and total oxygen appearing and the nitrogen. Next, a molar tabulation of the same elements is made for a convenient unit of fuel, such as 100 lb of coal or oil, or 1,000 cu ft of fuel gas (under specified conditions). Since all the carbon in the flue gas came from the fuel, the quantitative relation between fuel and dry flue gas is established. With this done, it is simple to calculate the amounts of water vapor, nitrogen, and sulfur *from the fuel* which are present in the flue gas. The flue-gas tabulation may then be extended to show the split of the total oxygen and nitrogen as quantities brought in by the fuel and by the air.

A residue of ash or cinder often contains a certain amount of unburned combustible. In the case of coal ash, the unburned combustible is essentially coke or carbon. This of course must be deducted from the carbon in the fuel in making the carbon balance between fuel and flue gas. About half of the sulfur in coal exists as iron pyrites (FeS_2). Oxygen is consumed in converting pyrites to Fe_2O_3 and SO_2 , although the oxygen combining with the iron is a minor quantity and is usually neglected. For further illustrations, the supplementary references may be consulted.

INTERPRETATION AND RELIABILITY OF THE ORSAT ANALYSIS

In the combustion of fuels, sulfur burns principally to SO_2 . The Orsat absorption pipette for CO_2 contains KOH solution which absorbs both CO_2 and SO_2 . The actual Orsat value is then $\text{CO}_2 + \text{SO}_2$. The two may be separated by calculation if the sulfur and carbon percentages in the fuel are known. Methods are available for removing the SO_2 from a sample of flue gas before an Orsat analysis, although it is usually not necessary to do so.

When carbon monoxide is present in a flue gas, a certain amount of free hydrogen will also exist, although usually to a much smaller percentage than the CO . Hydrogen is not absorbed by the Orsat and, when present, is included in the figure for nitrogen.

The chemically combined nitrogen in fuels is released almost quantitatively as free nitrogen in the combustion gases.

Although the Orsat apparatus is capable of CO_2 , O_2 , and CO analyses accurate to 0.1 per cent, many if not most analyses do not attain this precision. To obtain greatest accuracy, the instrument must be carefully calibrated, the reagents must be properly prepared and renewed at frequent intervals, and the analyst's technique must be adequate. An error that does not seem to be generally recognized may occur when potassium pyrogallate is used as the oxygen reagent. Water vapor in the gas samples is also absorbed by the strong alkali of this solution, which thereby becomes slightly diluted. If the solution is not maintained in substantially saturated condition with respect to KOH , complete oxygen absorption will not be obtained.¹

Slight errors in the Orsat analysis are greatly magnified when the analysis is used to calculate the carbon-hydrogen ratio of fuels, and a ratio so calculated must be regarded as an approximate value only.

Supplementary References

1. ARNOLD, J. HOWARD: "Chemical Engineering Stoichiometry," University of Iowa, 1941.
2. HOUGEN and WATSON: "Chemical Process Principles," Part I, John Wiley & Sons, Inc., New York, 1943.
3. HASLAM and RUSSELL: "Fuels and Their Combustion," Chap. X, McGraw-Hill Book Company, Inc., New York, 1926.
4. LEWIS and RADASCH: "Industrial Stoichiometry," Chaps. I, II, McGraw-Hill Book Company, Inc., New York, 1926.
5. WALKER, LEWIS, McADAMS, and GILLILAND: "Principles of Chemical Engineering," 2d ed., pp. 219-223, McGraw-Hill Book Company, Inc., New York, 1937.

Exercises

1. Tabulate the theoretical mols of air required for and total gases resulting from complete combustion of 1 mol of each of the following gases: H_2 , CO , methane, acetylene, ethane, propane, a hydrocarbon gas of composition C_nH_{2n} .

¹ GRISWOLD and MORRIS, *Refiner Natural Gasoline Mfr.* **20**, (January, 1941).

2. Calculate the cubic feet of air (dry, 60°F and 1 atm) necessary to burn
 - a. 1,000 cu ft of dry methane, measured at 60°F and 1 atm.
 - b. 1 lb of fuel oil containing 13 per cent hydrogen and negligible sulfur.
 - c. 1 lb of coal of the following analysis:

	C	H	O	N	S	Ash
Wt, %.....	78.3	5.3	7.6	1.4	1.2	6.2

3. The fuels of Exercise 2 are burned in a furnace and the gases enter the flue at 600°F and 740 mm. With theoretical air and complete combustion, what are the volumes of the flue gases?

4. Solve Exercise 3 assuming that 40 per cent excess air was used.

5. Solve Exercise 3 assuming that 25 per cent excess air was used and that 15 per cent of the total carbon burned to CO only.

6 and 7. Calculate the Orsat analyses that would be obtained by analyzing the burned gases in Exercise 1.

8, 9 and 10. Calculate the Orsat analyses that would be obtained by analyzing the flue gases in Exercises 2, 4, and 5, respectively.

11. The Orsat analysis of flue gas from a furnace burning a low-sulfur oil shows 10.4 per cent CO₂, 6.8 per cent O₂, and no CO. Calculate

- a. Per cent of excess air.
- b. Weight per cent of hydrogen in the oil.

12. Flue gas from a furnace firing coal tests 11.0 per cent CO₂, 1.0 per cent CO, and 6.7 per cent O₂ by the Orsat apparatus. The coal contains 74 per cent carbon, 8 per cent ash, and negligible nitrogen and sulfur. The refuse from the furnace contains 15 per cent by weight of carbon as coke due to incomplete burning of the fuel. The air is substantially dry and enters the furnace at 80°F. Barometer = 750 mm. Calculate

- a. Pounds of carbon lost in ashes per 100 lb of coal fired.
- b. Mols of dry flue gases per 100 lb of coal fired.
- c. Mols of net hydrogen in fuel, per 100 lb of coal fired.
- d. The composition of the coal, as percentages of carbon, net hydrogen, water, and ash.
- e. Cubic feet of flue gases at 600°F per pound of coal fired.
- f. Cubic feet of air entering furnace per pound of coal fired.
- g. Per cent of excess air.

13. A boiler is fired with natural gas which enters the furnace at 70°F. The flue gas enters the stack at 450°F. Average analyses of fuel and stack gases follow:

Fuel	%	Stack gas (Orsat)	%
CH ₄	88.2	CO ₂	8.04
C ₂ H ₆	6.7	CO.....	1.52
H ₂	2.3	O ₂	4.54
N ₂	2.8	N ₂	85.90

Both air and fuel are substantially dry. The barometer is 745 mm and the fuel is measured at 760 mm. Calculate

- a. Mols of dry stack gas per mol of fuel.
 - b. Mols of water vapor in flue per mol of fuel.
 - c. Cubic feet of flue gases per cubic foot of fuel.
 - d. Cubic feet of air at 90°F entering furnace per cubic foot of fuel.
 - e. Per cent of excess air.
- 14.** For air at 110°F and 1 atm with a relative humidity of 40 per cent, calculate
- a. H , H_m , V_H , V_{H_m} , s , s_m .
 - b. The wet-bulb temperature.
 - c. Read the weight values for (a) and the wet-bulb temperature from the chart.
- 15.** Air entering a furnace has a wet-bulb temperature of 72°F and a dry-bulb temperature of 84°F. Calculate
- a. The molar humidity.
 - b. The partial pressure of water vapor, as millimeters Hg.
 - c. Per cent of relative humidity.
 - d. The dew point.
 - e. The values for (a), (c), and (d) read from the chart.
- 16.** For the flue gas of Exercise 11 at 600°F, determine
- a. The partial pressure of water vapor.
 - b. The dew point.
 - c. The humid volume
 - d. The wet-bulb temperature.
- 17.** Hot gas from a water-gas set in passing through the wash box is cooled from 1260 to 165°F by evaporation of water in the box. The water remains at a temperature of approximately 165°F. Calculate the humidity of the gas leaving the box,
- a. The partial pressure of water (mm Hg).
 - b. Pounds of H₂O per 1,000 cu ft gas (dry, SC°).

Data:

<i>Dry Gas</i>	<i>Water Vapor</i>	<i>r at 165°</i>	<i>Gas Entering</i>	<i>Total Pressure</i>
$MCp = 7.2$	$MCp = 8.7$	1002 Btu/lb.	$p_w = 60$ mm Hg.	800 mm Hg.

CHAPTER V

TEMPERATURE, ENTHALPY, AND HEAT OF COMBUSTION

NATURE OF INTERNAL ENERGY

All matter in a given state or condition possesses *energy* or *capacity to affect other portions of matter* in the immediate vicinity. This energy is made up of several interrelated components of molecular, atomic, and subatomic *motion* and *position* or *arrangement*.

Heat is energy of molecular and atomic motion. The energy of a monatomic gas consists almost entirely of *molecular translation*. The energy of diatomic gases also includes molecular spin and interatomic vibrations. Polyatomic gases have these three components as well as other complex rotations and vibrations of larger portions of the molecule. At extremely high temperatures, gaseous molecules and atoms also store energy by internal rearrangements: *activation* (change in atomic electron orbits) and *dissociation* (ionization and reversal of certain elementary combustion reactions).

Molecules of a gas are free to move about, and their translational movement is restrained only by collision with other molecules or with the walls of a confining vessel. When a gas condenses to a liquid, it releases energy in the form of heat. The process takes place under atmospheric or other pressure. The atmosphere closes in, doing work on the system as the volume shrinks, and the heat of condensation is partly from loss of internal energy and partly from work done by the atmosphere. Heat of fusion is almost entirely an internal energy effect since the change in volume is small.

Molecules of a liquid or a solid are relatively close together and their motions are restrained by intermolecular forces somewhat similar to, although usually much weaker than, the interatomic or valence forces that hold a molecule together.

The energy effects accompanying chemical reactions are due to rearrangements of certain species of molecules into other more stable molecules. In the case of combustion reactions, molecules containing carbon and hydrogen in various forms rearrange with gaseous oxygen into CO_2 and water vapor as the most stable products.

Temperature is the intensity scale of molecular motion, since heat always tends to flow from a higher to a lower temperature. For ideal gases, temperature is directly related to molecular energy of translation.

The absolute energy content of a system or discrete portion of matter is not definitely known and is not required since *energy changes* can be readily and accurately determined, from and at a convenient reference state. Although energy may be transferred by a number of mechanisms—heat, mechanical work, electricity, and several types of radiation—this chapter is concerned only with heat.

In most practical cases, heat is transferred to or from gases at a pressure not far from atmospheric. Furthermore, heat exchange is usually at constant pressure. Under the latter condition of restraint, change in energy content of a gaseous system is equal to the heat absorbed or given off only at constant temperature. If the temperature changes, the volume also changes and the atmosphere receives energy from or gives energy to the system in the form of work. The measure of this work is the change in the *pressure-volume (PV) product*. It is now clear that atmospheric energy is nearly always involved between changes of internal energy and heat effects.

Enthalpy (pronounced *enthal'py*) is a thermodynamic function consisting of the sum of internal energy and *PV* product or potential external work function. Algebraically,

$$H = E + PV \quad (1)$$

where H = total enthalpy of a system

E = total internal energy of the system

PV = pressure-volume product or potential external work function of the system

Since we are concerned with energy changes or transfers rather than with absolute energy contents, Eq. (1) is written,*

$$\Delta H = \Delta E + \Delta(PV) \quad (1a)$$

where ΔH = enthalpy *increase* of the system

ΔE = *increase* in internal energy of the system

$\Delta(PV)$ = decrease in pressure-volume product (in energy units)

For energy transfers in the form of heat, change in enthalpy is equal to heat added in the case of ideal gases under constant pressure. Stated in a slightly different way, the heat absorbed by surroundings from a system at constant pressure is equal to the enthalpy decrease of the system.

$$Q = -\Delta H \quad (2)$$

* Here as in common usage, the sign of an enthalpy and of an internal energy change for an *exothermic reaction* is negative while that of the *PV* product of an expanding gas is positive. Usage of plus and minus signs causes great confusion if not kept clearly in mind.

where Q = heat absorbed by surroundings

$-\Delta H$ = enthalpy (in heat units) given up by system

Equation (2) and the definition preceding it are so commonly used in engineering that the distinction between enthalpy and change in heat content is often lost sight of.

Use of the term enthalpy in the text hereafter refers to change in heat content at constant pressure, so that Eq. (2) applies.

TEMPERATURE AND HEAT UNITS

The common temperature scales (Fahrenheit and centigrade) are defined in terms of the freezing and normal boiling points of water and have illogical minus values at low temperatures. Negative temperature values are obviated by thermodynamic or absolute temperature scales. The Rankine and Kelvin temperature scales are absolute, although the single degrees are of the same size as the Fahrenheit and centigrade units, respectively. Equivalent temperatures at absolute zero, ice, and steam points are given in the accompanying table.

	Fahrenheit	Rankine	Centigrade	Kelvin
Absolute zero.....	-460	0	-273	0
Ice point.....	32	492	0	273
Steam point.....	212	672	100	373

From the table,

$$T^{\circ}\text{R} = 460 + t^{\circ}\text{F}$$

$$T^{\circ}\text{K} = 273 + t^{\circ}\text{C}$$

$$T^{\circ}\text{R} = (1.8)(T^{\circ}\text{K})$$

The last relation furnishes a rapid means of conversion of absolute temperature. The formula

$$t^{\circ}\text{F} = \frac{9}{5}T^{\circ}\text{C} + 32$$

may be used for Fahrenheit-centigrade conversions, but for convenience a temperature conversion table is given in the Appendix, Table 3.

The common *heat units* are

1 *British thermal unit* (Btu) = heat to raise the temperature of 1 pound of water from 60 to 61°F.

1 *gram-calorie* (cal.) = heat to raise the temperature of 1 gram of water from 15 to 16°C.

1 *kilogram-calorie* (kg-cal) = 1,000 calories.

1 *pound-centigrade unit* (Pcu) = heat to raise the temperature of 1 pound of water from 15 to 16°C.

The temperatures 15 and 16°C, 60 and 61°F were arbitrarily selected on the basis of convenience. (The pound-centigrade unit or centigrade heat unit is a definition of convenience, in which *heats of reaction* and *heats of vaporization* have the same numerical values when defined in terms of *Pcu* as when defined in terms of *calories*. It thus avoids multiplying or dividing by 1.8 in certain cases.)

SPECIFIC HEAT AND MOLAR HEAT CAPACITY

The definition of specific heat is suggested by the definition of a heat unit, *i.e.*, the quantity of heat required to raise the temperature of a substance one degree compared to that required for the same weight of water. The specific heat of water between 15 and 16°C or 60 and 61°F is taken as unity.

The common units of specific heat (*C*) are *Btu/(lb)(°F)* and *cal/(gm)(°C)*. The numerical values are the same in both units for any given substance; the specific heat of water is one calorie per gram per centigrade degree and one Btu per pound per Fahrenheit degree. When working in molar quantities as is usually done with gases, molar heat capacities (*MC*) are used; *Btu/(lb mol)(°F)* and *cal/(g mol)(°C)*.

Specific heats and molar heat capacities at *constant pressure* (*Cp*, *MCp*) are higher than the values for the same substances at *constant volume* (*Cv*, *MCv*). The constant-pressure quantities are much more frequently used than the constant-volume quantities, and notations of specific heats and molar heat capacities as used hereafter refer to the constant-pressure quantities unless otherwise designated.

Water has a higher *specific heat* than most other substances, but this is not true of its *molar heat capacity*. These constants for water vary so slightly between 0 and 100°C, that, for engineering calculations, *Cp* = 1.0 and *MCp* = 18.0 are used over this temperature range. In other cases the effect of temperature on specific heat must usually be taken into account.

HEAT CAPACITY OF GASES

The heat capacity of monatomic and diatomic gases is chiefly due to the molecular energy of translation. Since different types of molecules have the same energy of translation at the same temperature, *molar heat capacities* of different gases having simple molecules are numerically closer than are their *specific heats*. According to classical kinetic theory, gaseous heat capacities due to *translational energy only* are

	<i>MCp</i>
Monatomic gases.....	$\frac{5}{2}R$
Diatomic gases.....	$\frac{7}{2}R$

where R is the gas constant in heat units; $1.985 \text{ cal}/(\text{g mol})(^\circ\text{C})$. Accordingly, the molar heat capacity of all monatomic gases is approximately 5, and that of diatomic gases is approximately 7. At high temperatures, other forms of molecular energy become significant for diatomic and more complex gases.

The heat capacity-temperature relation for any gas may be expressed by an equation of the type,

$$MCp = a + bT + cT^2 + \dots \quad (3)$$

where a , b , and c are constants characteristic of the particular gas. The form of Eq. (3) is purely arbitrary, but it will fit the data for any gas to any desired degree of accuracy with a sufficient number of terms. It is very convenient for mathematical manipulations.

Calculation of Enthalpy Change. Practical combustion problems are concerned with the heat given up or absorbed by gases (sensible heat) between two temperatures that are often widely different. The simplest form of equation for calculating the heat effect is

$$Q = n(MCp)_{av}(t_2 - t_1) \quad (4)$$

where n = number of mols

$(MCp)_{av}$ = average, or mean molar heat capacity of the gas between t_1 and t_2

In order to use Eq. (4) values of $(MCp)_{av}$ must be available. The relation for $(MCp)_{av}$ in terms of MCp , t_1 , and t_2 is obtained as follows: In Eq. (4) $(MCp)_{av}$ becomes MCp over a differential temperature interval, and

$$Q = n \int_{t_1}^{t_2} (MCp) dt \quad (5)$$

Combining Eqs. (3) and (5),

$$Q = n \int_{t_1}^{t_2} (a + bt + ct^2 + \dots) dt$$

Integrating,

$$Q = n \left[at + \left(\frac{1}{2}\right)bt^2 + \left(\frac{1}{3}\right)ct^3 + \dots \right]_{t_1}^{t_2} \quad (6)$$

Eliminating Q between Eqs. (4) and (6), inserting limits, and solving for $(MCp)_{av}$:

$$(MCp)_{av} = a + \left(\frac{b}{2}\right)(t_2 + t_1) + \left(\frac{c}{3}\right)(t_2^2 + t_2t_1 + t_1^2) \quad (7)$$

Equation (7) thereby gives the proper value of $(MCp)_{av}$ to use in Eq. (4). This development is shown graphically in Fig. 1.

By choosing a lower or datum temperature of 60°F for t_1 , Eq. (7) may be written

$$(M Cp)_{\text{av}} = a' + b'(t + 60) + c'(t^2 + 60t + 3,600) \quad (8)$$

where t is the upper temperature in degrees Fahrenheit. Note that, for any single gas, $(M Cp)_{\text{av}}$ and t are the only variables in Eq. (8). This permits values for pure gases to be calculated and plotted. Calculated curves for the common combustion gases and for methane are given in Fig. 2. The data from which Fig. 2 was constructed are among the latest to be obtained by the modern spectrometric method. (This method is generally considered to give more accurate results than the calorimetric method for gaseous heat capacities at high temperatures.)

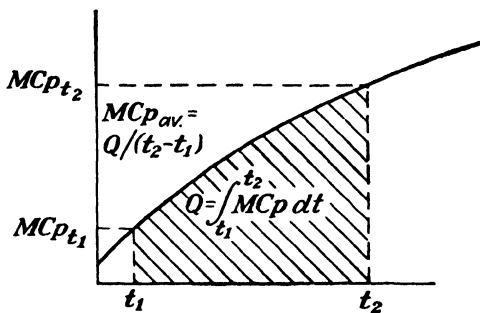

FIG. 1.

Figure 2 may be used to compute enthalpy changes between *any two* temperatures within the range of the chart:

$$Q_{60 \rightarrow t_1} = (M Cp)_{\text{av}60 \rightarrow t_1} (t_1 - 60)$$

$$Q_{60 \rightarrow t_2} = (M Cp)_{\text{av}60 \rightarrow t_2} (t_2 - 60)$$

hence,

$$Q_{t_2 \rightarrow t_1} = Q_{60 \rightarrow t_2} - Q_{60 \rightarrow t_1} \quad (9)$$

Point values of heat capacity may also be calculated from Fig. 2 by the relation

$$(M Cp)_t = (M Cp)_{\text{av}} + (t - 60) \left[\frac{d(M Cp)_{\text{av}}}{dt} \right] \quad (10)$$

The bracketed term of Eq. (10) is the *slope* of the curve at temperature t on Fig. 2.

Heat capacities of gases are independent of pressure at low pressures, and an enthalpy change for a gas mixture is the sum of the values for its constituents.

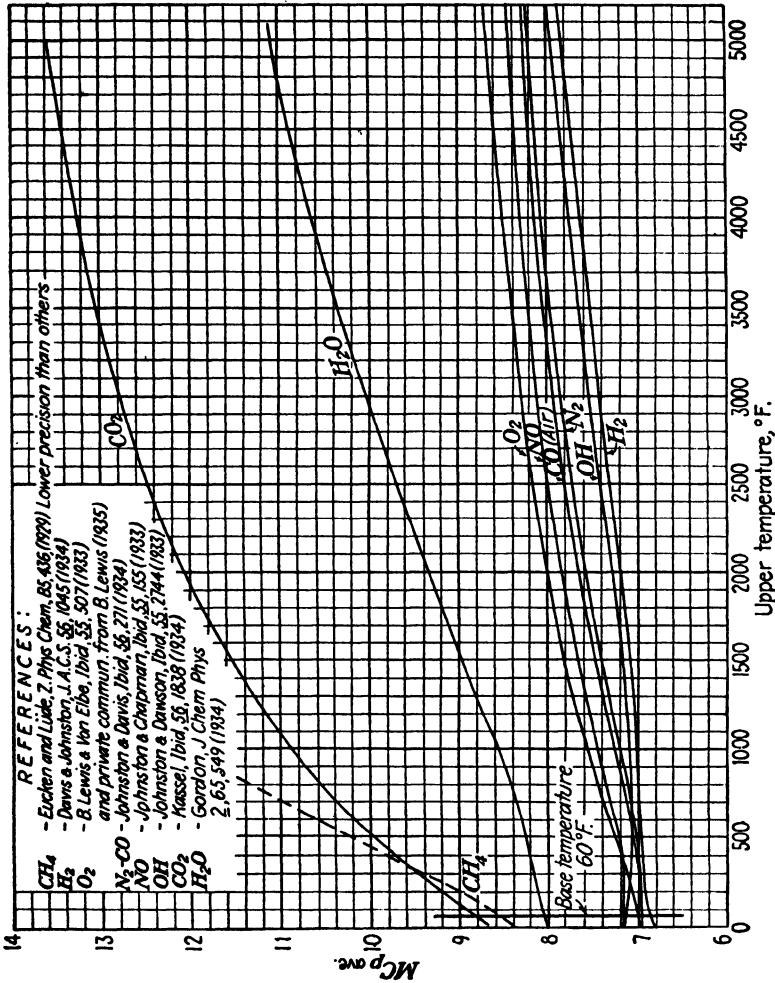

REFERENCES:
 - Eucken and Lide, *Z. Phys Chem*, 55, 436 (1929) Lower precision than others
 - Davis & Johnston, *J. A.C.S.* 55, 1045 (1933)
 - B. Lewis & Van Eibe, *ibid.*, 55, 507 (1933)
 and private communi. from B. Lewis (1935)
 - Johnston & Davis, *ibid.*, 56, 271 (1934)
 - Johnston & Chapman, *ibid.*, 55, 155 (1933)
 - Johnston & Dawson, *ibid.*, 55, 274-4 (1933)
 - Kassel, *ibid.*, 55, 1838 (1934)
 - Gordon, *J. Chem Phys* 2, 65, 349 (1934)

Fig. 2.—Mean molar heat capacities of gases at constant pressure, between 60°F. and abscissa temperature. (M. W. Kellogg Company.)

Illustration 1

How many Btu are required to heat 100 mols of air from 60 to 1060°F? from 560 to 1060°F? What is the heat capacity of air at 1060°F?

Solution: Referring to Fig. 2, the mean molar heat capacity of air between 60 and 1060°F is 7.26 and between 60 and 560°F is 7.07. The sensible heat of 100 mols of air between 60 and 1060°F is

$$100(7.26)(1060 - 60) = 726,000 \text{ Btu}$$

The sensible heat between 60 and 560°F is

$$100(7.07)(560 - 60) = 353,500 \text{ Btu}$$

and the sensible heat between 560 and 1060°F is

$$726,000 - 353,500 = 372,500 \text{ Btu}$$

The slope of the curve for air at 1060°F is 4.2×10^{-4} Btu/mol, and by Eq. (10)

$$(MCp)_{1060^{\circ}\text{F}} = 7.26 + (1060 - 60)(4.2)(10^{-4}) = 7.68.$$

HEAT CAPACITY OF HYDROCARBON VAPORS

A number of correlations have been developed by which the heat capacity of organic vapors may be calculated from available spectroscopic data. The results of a comprehensive critical survey for the most dependable values of heat capacities of fuel and combustion gas constituents and of many individual hydrocarbons have been presented.¹

As for complex molecules in general, the *specific heats* of various hydrocarbons are numerically much closer together than are the *molar heat capacities*. Hence in working with petroleum fractions, specific heats are used in preference to molar heat capacities. In terms of specific heats, Eq. (4) becomes

$$Q = n(MCp)_{av}(t_2 - t_1) = (nM)Cp_{av}(t_2 - t_1) = WCp_{av}(t_2 - t_1) \quad (4a)$$

where W is the weight in pounds.

Watson and Fallon² found that specific heats of *petroleum vapors* (consisting of hydrocarbons above pentane) are correlated in terms of *temperature* and *UOP K value*:

$$Cp_v = (0.045K - 0.233) + (0.44 + 0.0177K)10^{-3}t - (0.153)10^{-6}t^2 \quad (11)$$

where Cp_v = specific heat at $t^{\circ}\text{F}$ and 1 atm,

$$K = \sqrt[3]{T_b^{\circ}\text{R}/S_{60}} \quad (\text{see Chap. III})$$

It should be noted that Eq. (11) has the same form as Eq. (3). Hence the *mean* or *average* specific heat between two temperatures is given by the relation

$$Cp_{av} = a + \frac{b}{2}(t_2 + t_1) + \frac{c}{3}(t_2^2 + t_2t_1 + t_1^2) \quad (12)$$

where $a = 0.045K - 0.233$

$$\frac{b}{2} = (220 + 8.85K)10^{-6}$$

$$\frac{c}{3} = (0.051)10^{-6}$$

Cp_{av} is then used in Eq. (4a) for calculating sensible heat changes for petroleum vapors.

For convenience of use, Eq. (11) has been plotted in Fig. 3. A plot of *average specific heats* of petroleum vapors over a range of temperatures

¹ Selected Values of Hydrocarbons, *API Research Project 44*, (1942-1946), *Nat. Bur. Standards*.

² *Nat. Petroleum News*, June 7, 1944, p. R372.

(similar to Fig. 2 for gases) is not yet available. However, average specific heats may be obtained from Fig. 3 by the approximation formula:

$$C_{p_{av}} = \frac{1}{6}(C_{p_{t_1}} + 4C_{p_{t_{av}}} + C_{p_{t_2}}) \tag{13}$$

where $C_{p_{av}}$ = average specific heat for use in Eq. (4a)

t_1 = lower temperature, °F

t_2 = upper temperature, °F

$$t_{av} = \frac{t_1 + t_2}{2}$$

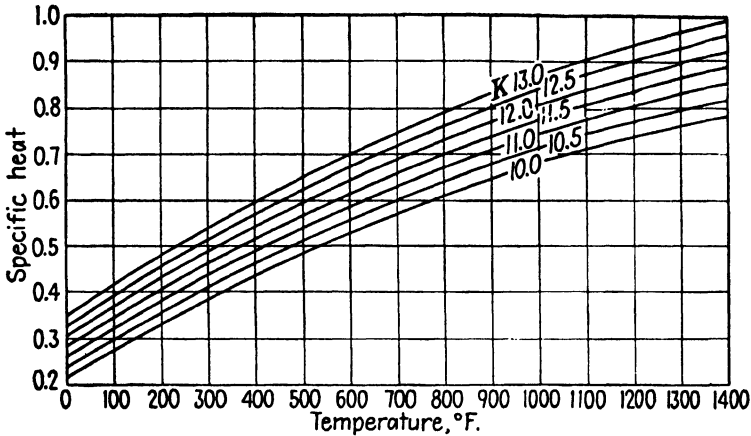

(Courtesy of K. M. Watson.)

FIG. 3.—Specific heat of petroleum vapors. Approximate average specific heat between t_1 and t_2 :

$$C_{p_{av}} = (\frac{1}{6})(C_{p_{t_1}} + 4C_{p_{t_{av}}} + C_{p_{t_2}}), \text{ where } t_{av} = (t_1 + t_2)/2.$$

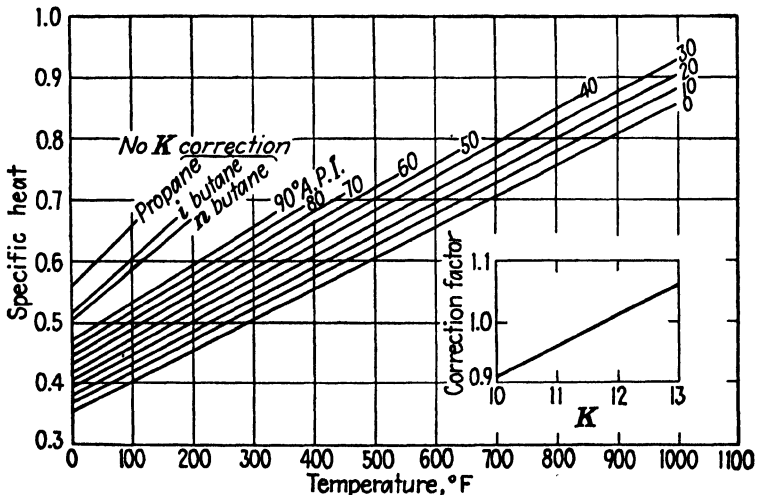

FIG. 4.—Specific heat of petroleum oils: $C_{p_{av}} = C_{p_{t_{av}}}$. (Courtesy of K. M. Watson.)

SPECIFIC HEAT OF PETROLEUM OILS

The specific heat of petroleum oils is correlated² in terms of *temperature*, *API gravity*, and *K*:

$$Cp_L = [0.355 + (1280)(^\circ\text{API})10^{-6} + (503 + 1.17(^\circ\text{API}))10^{-6}t] \times (0.05K + 0.41) \quad (14)$$

A plot of Eq. (14) is given as Fig. 4. *Specific heats of petroleum oils are substantially linear with temperature.** For this condition it may be shown that

$$(Cp)_{av} = \frac{Cp_{t_1} + Cp_{t_2}}{2} = (Cp)_{t_{av}} \quad (15)$$

$$t_{av} = \frac{t_1 + t_2}{2}$$

HEAT CAPACITY OF SOLIDS

When data are lacking, rough values of the heat capacities of solids may be obtained by Kopp's rule, and the law of Dulong and Petit.

According to Kopp's rule, the heat capacity of a *solid compound* is the sum of weighted values of its constituent elements. *Values assigned to several elements to be used with Kopp's rule* are C = 1.8, H = 2.3, O = 4.0, S = 5.4, Si = 3.8, others (with the exceptions of B, F, and P) are taken as 6.2.

Dulong and Petit's law requires that the *atomic heat capacity of solid crystalline elements be 6.2*. This is approximate for the heavier elements.³

LATENT HEAT OF VAPORIZATION

Pure Compounds. The latent heat of vaporization of any pure liquid compound is a function of its temperature, vapor pressure, and specific or molar volumes of vapor and of liquid (see Chap. III). Many correlations between these properties have appeared in recent literature.

To be of engineering importance, a correlation must require only data that are readily available or can be easily computed. Meissner correlated latent heats of vaporization with vapor pressure, critical temperature, and critical pressure.⁴ Since critical temperatures and pressures are not always available, Meissner and Redding developed a correlation or method of predicting the needed critical constants.⁵

* The effect of pressure becomes appreciable at temperatures above the normal boiling point of an oil, and becomes large as the critical temperature is approached.

³ PERRY, J. H., "Chemical Engineers' Handbook," 2d ed., p. 634, McGraw-Hill Book Company, Inc., New York, 1941.

⁴ *Ind. Eng. Chem.*, **33**, 1440 (1941).

⁵ *Ind. Eng. Chem.*, **34**, 521 (1942).

The correlations in these two articles enable latent heats of vaporization to be estimated for all common liquid compounds of known boiling point or vapor pressure, for any desired vaporization temperature.

Petroleum Fractions. The molar heats of vaporization at atmospheric pressure of nonpolar liquids such as hydrocarbons are approximated by the Kistiakowsky equation:

$$Mr = (T_b^\circ\text{R})[7.58 + 4.57 \log (T_b^\circ\text{R})] \quad (16)$$

where Mr = latent heat, Btu/lb mol
 $T_b^\circ\text{R}$ = normal boiling point, $^\circ\text{R}$

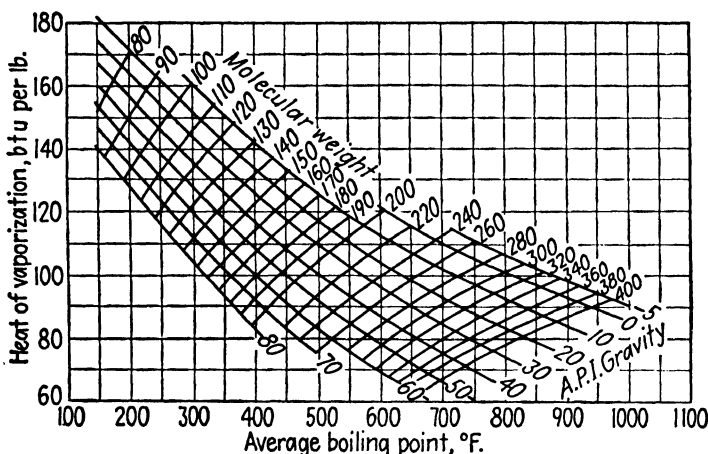

FIG. 5.—Heat of vaporization of petroleum oils at 1 atm. (Courtesy of K. M. Watson.)

Equation (16) may be satisfactorily applied to light petroleum fractions, using the *mean average boiling point* for T_b (see Chap. III). Watson finds that Eq. (16) gives low values for heavy petroleum fractions.² His correlation as developed from data on a wide variety of fractions is given in Fig. 5. In using Fig. 5, molecular weight should be used in preference to API gravity whenever possible.

Illustration 2

The gasoline of Illustration 5 in Chap. III is to be used as fuel in a gasoline stove. The oil is vaporized and preheated to a final temperature of 700°F before it burns. Calculate the required preheat from liquid at 70°F to vapor at 700°F per pound of gasoline.

Solution: For calculating enthalpy change in going from an oil to a superheated vapor, the procedure is to heat the oil to its molar average boiling point, vaporize it at that temperature and atmospheric pressure, and superheat the vapor to the final temperature.

Properties of gasoline:

$$\begin{aligned} \text{Gravity} &= 61.3^\circ\text{API}, & K &= 12.1, & \text{MW} &= 106 \\ & & \text{ASTM slope} &= 2.55 \\ & & \text{Volumetric av bp} &= 248^\circ\text{F} \\ & & \text{Mean av bp} &= 231^\circ\text{F} \\ & & \text{Molar av bp} &= 221^\circ\text{F} \end{aligned}$$

a. The average temperature of the *liquid* between 70 and 221°F is 145.5°F. From Fig. 4

$$C_{p_{av}} = (1.01)(0.52) = 0.525$$

To heat the oil to 221°F requires

$$(0.525)(221 - 70) = 79 \text{ Btu/lb}$$

b. From Fig. 5, the heat of vaporization is 133 Btu/lb.

c. The average temperature of the vapor between 221 and 700°F is 461°F. From Fig. 3, the specific heats of the vapor at 221, 461, and 700°F are 0.45, 0.575, and 0.695, respectively.

$$C_{p_{av}} = \frac{1}{6}[0.45 + 4(0.575) + 0.695] = 0.574$$

To superheat the vapor to 700°F requires

$$(0.574)(700 - 221) = 275 \text{ Btu/lb}$$

The total heat requirement is then

$$79 + 133 + 275 = 487 \text{ Btu/lb}$$

ENTHALPY CHARTS

The *heat content* of pure compounds such as flue-gas constituents and light hydrocarbons, and also of liquid and vapor petroleum fractions, may be calculated and plotted. The usual coordinates are *Btu per mol or per pound versus temperature, at 1 atmosphere and above a datum temperature of 32 or 60°F*. These charts are great timesavers where many heat content calculations are to be made; it is merely necessary to read off the heat contents of each substance at the temperatures concerned and multiply the difference by the number of mols or pounds. Although enthalpy charts that embody the latest specific and latent heat data have not been published at the time of writing, charts constructed from earlier data are available.⁶⁻⁸

HEATS OF COMBUSTION AND OF FORMATION

Gas Calorimetry. The heating value (calorific value, heat of combustion) of a fuel gas is usually determined with a Junkers-type, con-

⁶ For flue gases see Haslam and Russell, "Fuels and Their Combustion," p. 210, McGraw-Hill Book Company, Inc., New York, 1926.

⁷ For light hydrocarbons see Holcomb and Brown, *Ind. Eng. Chem.*, **34**, 590 (1942); **36**, 384 (1944).

⁸ For petroleum fractions see Shell Development Co., *Petroleum Refiner*, **24** (April, 1945).

tinuous-flow calorimeter. The calorimeter proper is essentially a bunsen-type burner mounted in a water jacket (Fig. 6). The gas is metered, burned, and the heat is absorbed by water passing through the jacket. The water rate is experimentally determined and the air rate is estimated. These rates with temperatures, gas pressure, and air humidity enable calculation of the heating value. The heat of combustion of a given sample may be reported on any of several bases, each having a somewhat different numerical value.⁹

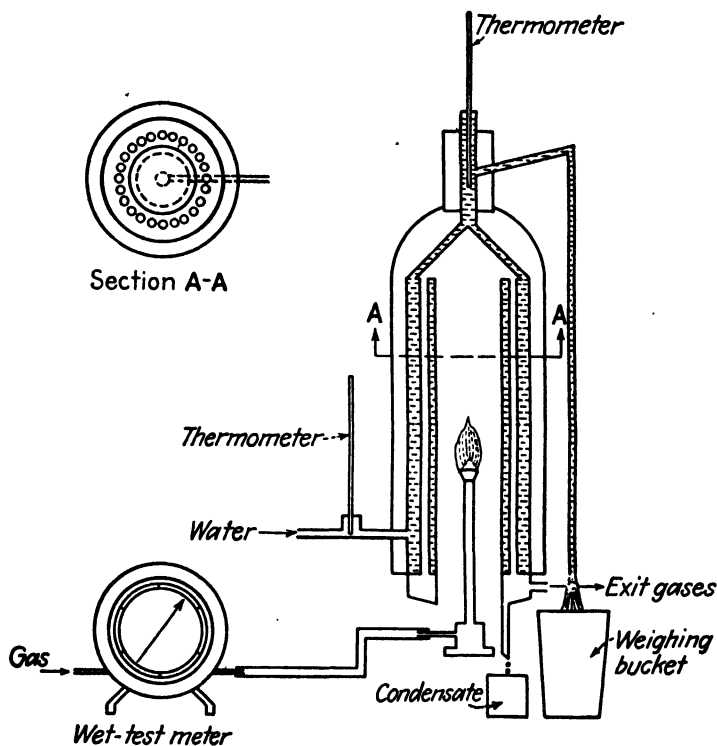

FIG. 6.—Diagrammatic sketch of gas calorimeter.

The calorimeter is open to the atmosphere, hence the experimental value is *heat of combustion at constant pressure*. The most common basis for reporting gas heating values is *gross or total Btu per cubic foot of fuel gas, measured at 60°F, 30 in. Hg, saturated with water vapor at 60°F ($p_w = 0.52$ in. Hg)*. Most of the water vapor formed from burning hydrogen condenses in the calorimeter, releasing its latent heat. However, all of the water vapor must be accounted for to obtain accurate values.

⁹ *Nat. Bur. Standards, Circs. 48, 417.*

Oxygen Bomb Calorimetry. Heats of combustion of solid and liquid fuels are determined by igniting and burning weighed samples in an atmosphere of oxygen in a metal bomb. The bomb is set in a metal pail containing water, and the whole assembly is mounted in an insulated jacket (Fig. 7). The heat of combustion is absorbed by and raises the temperature of bomb, water, and pail by a few degrees. The weight of sample, temperature rise, and known heat capacity of the assembly enable calculation of the heat of combustion (see ASTM D 240—39).

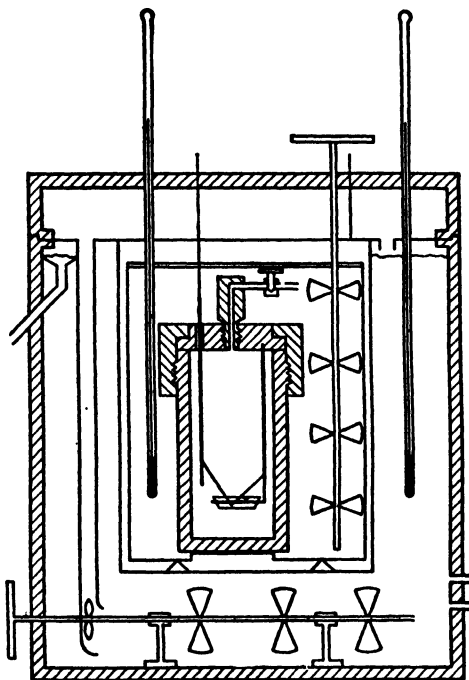

FIG. 7.—Diagrammatic sketch of oxygen bomb calorimeter.

The heating value determined in this way is the *gross or total heat of combustion at constant volume*. The water vapor formed condenses in the calorimeter bomb.

CONVERSION OF HEATING VALUE BASES

Heats of combustion of the more common pure compounds occurring in fuels are given in Table 1, as *gross kilogram-calories per gram mol at 25°C and one atmosphere*. Standard determinations are reported in the literature in these units. For engineering calculations, the customary units of heating values are *gross and net Btu per pound*. The heating values of gases are also expressed as *Btu per cubic foot at designated temperatures and pressures*.

TABLE 1.—GROSS HEATS OF COMBUSTION
 $-\Delta H_c = \text{kg-cal per g mol.}$ 25°C and 1 atm

H ₂	68.3	Isopentane.....	843.2
S → SO ₂	69.3	<i>L</i> 837.3	
H ₂ S → H ₂ O + SO ₂	132.8	Neopentane.....	840.5
Thiophene.....	<i>L</i> 667	<i>L</i> 835.2	
C, graphite.....	<i>S</i> 94.05	<i>n</i> -Pentane.....	845.2
Coke.....	<i>S</i> 97.0	<i>L</i> 838.8	
CO.....	67.6	Methylcyclopentane.....	948.7
Methane.....	212.8	<i>L</i> 941.1	
Acetylene.....	310.6	Benzene.....	789.1
Ethylene.....	337.2	<i>L</i> 781.0	
Ethane.....	372.8	Cyclohexene.....	<i>L</i> 892
Propene.....	492.0	Cyclohexane.....	944.8
Propane.....	530.6	<i>L</i> 936.9	
<i>L</i> 526.8		Hexene-1.....	964.3
Isobutene.....	646.1	<i>n</i> -Hexane.....	1003
<i>L</i> 641.2		<i>L</i> 995	
Butene-1.....	649.7	Toluene.....	943.6
<i>L</i> 644.8		<i>L</i> 934.5	
Isobutane.....	686.3	Methylcyclohexane.....	1099.6
<i>L</i> 681.6		<i>L</i> 1091.1	
<i>n</i> -Butane.....	688.0	<i>n</i> -Heptane.....	1160
<i>L</i> 682.8		<i>L</i> 1151	
Pentene-1.....	806.9	Xylenes (av).....	<i>L</i> 1088
Cyclopentane.....	793.4	Naphthalene.....	<i>S</i> 1233
<i>L</i> 786.5		Diphenyl.....	<i>S</i> 1494
		Anthracene.....	<i>S</i> 1685
		Benzoic acid.....	<i>S</i> 771.2

Values for combustion from gaseous state unless designated *L* = liquid or *S* = solid. Principal sources of data, Nat. Bur. Standards publications and *Chem. Rev.* **27** (1940).
 To convert gross kg-cal/g mol to

1. Net heat of combustion; Subtract 10.5 kg-cal/mol hydrogen.
2. Btu/lb: Multiply by (1800/mol wt).
3. Btu/cu ft dry, 60°F, 30 in. Hg: Multiply by 4.77 (gaseous state only).
4. Dry to saturated at 60°F: Multiply by 0.983 (gaseous state only).

The relation between *kilogram-calories per gram mol* and *Btu per pound* is

$$\text{Btu/lb} = (1,800) \frac{(\text{kg-cal/g-mol})}{M}$$

where M is molecular weight.

Gaseous Fuels. Conversion of gaseous heating values from kilogram-calories per gram-mol to *Btu per cubic foot, 60°F dry, and 30 in. Hg* may be accomplished with engineering accuracy by multiplying by 4.77.*

At 60°F the vapor pressure of water is 13.2 mm or 0.52 in. Hg. The *dry heating value* is converted to the *60° saturated value* by multiplying by $(30 - 0.52)/30 = 0.983$.

The heating values (HV) as Btu per cubic foot may be converted from a basis of any given temperature, pressure, and humidity to any other specified basis by dividing the heating value by the relative volume calculated for the new basis. Algebraically,

$$(\text{HV})_{t_2, P_2, p_{w_2}} = (\text{HV})_{t_1, P_1, p_{w_1}} \left[\frac{V_{t_1, P_1, p_{w_1}}}{V_{t_2, P_2, p_{w_2}}} \right]$$

or for 1 cu ft on the original basis, the conversion is

$$(\text{HV}) = (1) \frac{(\text{HV})_{t_1, P_1, p_{w_1}}}{V_{t_2, P_2, p_{w_2}}}$$

Net Heating Values. Fuel is burned in a furnace under conditions of constant pressure, and any water in the fuel as well as that formed by combustion of hydrogen is usually carried out the stack as water vapor. The heat of condensation of the water (which is included in the gross heat of combustion) is therefore not recoverable by the furnace. Other things being equal, a fuel low in hydrogen shows a higher efficiency than a fuel high in hydrogen when burned in the same furnace, since *the gross heating value* is not 100 per cent available.

To adjust this inequity, the *net heating value* is sometimes used. The essential difference between the gross and the net heating values is the heat of vaporization of the water equivalent to the *combustible hydrogen* in gaseous fuels, and to the *total hydrogen* (which includes mois-

* This factor is 4.76 calculated from the ideal-gas law, assuming the heat of combustion to be the same at 60°F as at 25°C. Error resulting from the latter approximation is small, but gas-law deviations are appreciable and increase with molecular weight of the compound. The factor 4.77 applies to manufactured and natural gas fuels, and is an average value that includes both gas-law deviation and temperature level corrections. For the most accurate individual values as Btu per cubic foot, see Appendix, Table 7.

ture) in liquid and solid fuels. For calculation of net heating values, the value for the latent heat of vaporization of water is 1050 Btu/lb (as at 25°C). This is equivalent to $10.5 \text{ kg-cal/g mol}$ of hydrogen or 94 Btu for each 1 per cent of hydrogen per pound of fuel. These figures apply to heating values reported as at constant pressure, as in Table 1.

Oxygen bomb determinations are at constant volume, and the water vapor is condensed under conditions of constant volume rather than of constant pressure. The correction for constant volume to constant pressure is $(+30 \text{ Btu/lb of water})$ or $(+0.3 \text{ kg-cal/g mol of total hydrogen})$. For converting *bomb heating values from gross Btu at constant volume to net Btu at constant pressure*, the two factors above are combined, giving $1020 \text{ Btu/lb of water}$, $10.2 \text{ kg-cal/g mol of hydrogen}$, or 91 Btu for each 1 per cent of total hydrogen per pound of fuel.*

Gas heating value determinations:

$$\begin{aligned} \text{Net kg-cal/g mol} &= \text{gross kg-cal/g mol} - 10.5(\text{mols H}_2) \\ \text{Net Btu/lb} &= \text{gross Btu/lb} - 94(\text{per cent H}) \\ &= \text{gross Btu/lb} - 1050(\text{lb H}_2\text{O formed}) \end{aligned}$$

An empirical correlation that applies to natural gases containing only hydrocarbons and inerts is¹⁰

$$\text{Net HV} = 0.933(\text{gross HV}) - 0.317(100 - \text{per cent inerts})$$

Bomb heating value determinations (reported as at constant volume):

$$\begin{aligned} \text{Net Btu/lb} &= \text{gross Btu/lb} - 91(\text{per cent total H}) \\ &= \text{gross Btu/lb} - 1020(\text{lb total H}_2\text{O}) \end{aligned}$$

Illustration 3

A natural gas consists of 85 per cent methane, 7 per cent ethane, 3 per cent propane, and 5 per cent nitrogen. Calculate its gross and net heating values as kilogram-calories per gram mol, Btu per pound, Btu per cubic foot dry and saturated at 60°F and 30 in. Hg.

Solution (basis, 100 mols gas):

	Mols	MW	Lb	Mols H ₂	$-\Delta H_c$ (Kg-cal per g mol)
Methane.....	85	16	1,360	170	212.8
Ethane.....	7	30	210	21	372.8
Propane.....	3	44	132	12	530.6
Nitrogen.....	5	28	140		
Total.....	1,842	203	

* ASTM practice (D407-44) is to report heating values as at 20°C and deduct 1030 Btu/lb of water to convert gross to net values.

¹⁰ HEADLEE and HALL, *Ind. Eng. Chem.*, **36**, 953 (1944).

The gross heating value is

$$\frac{(85)(212.8) + (7)(372.8) + (3)(530.6)}{100} = 223 \text{ kg-cal/g mol}$$

$$\frac{(1800)(223)(100)}{1842} = 21,800 \text{ Btu/lb}$$

$$(223)(4.77) = 1065 \text{ Btu/cu ft } 60^\circ \text{ dry, } 30 \text{ in. Hg}$$

$$(1065)(0.983) = 1045 \text{ Btu/cu ft } 60^\circ \text{ sat, } 30 \text{ in. Hg}$$

Since 100 mols of the gas contains 203 mols of hydrogen, the deductions to obtain net heating values are

$$(2.03)(10.5) = 21.3 \text{ kg-cal/g mol gas}$$

$$\frac{(2.03)(18.02)(1050)}{1842} = 2090 \text{ Btu/lb}$$

and the net heating values are

$$223 - 21.3 = 201.7 \text{ kg-cal/g mol}$$

$$21,800 - 2090 = 19,710 \text{ Btu/lb}$$

$$(201.7)(4.77) = 962 \text{ Btu/cu ft } 60^\circ \text{ dry, } 30 \text{ in. Hg}$$

$$(962)(0.983) = 945 \text{ Btu/cu ft } 60^\circ \text{ sat, } 30 \text{ in. Hg}$$

HEAT OF FORMATION

A heat effect accompanies any chemical reaction. The heat effect accompanying the formation of a compound from its elements is designated *heat of formation*. The heats of formation of hydrocarbons and fuels substances (containing no combined oxygen) are small compared to their heats of combustion but are nevertheless appreciable. The heat of formation of a compound is obtained by calculation from its heat of combustion and those of its elements. (The *heats of formation* of CO₂ and of H₂O are equal in numerical value but opposite in sign to *heats of combustion* of carbon and of hydrogen, respectively.) The heats of combustion of carbon (as graphite) and of hydrogen have been determined very accurately to serve as bases for calculation of heats of formation.

For hydrocarbons,

$$\begin{aligned} \text{Heat of formation} &= -(\Delta H)_f \\ &= (\text{heat of formation of equivalent CO}_2 \text{ and H}_2\text{O from} \\ &\quad \text{C and H}) - (\text{heat of combustion of hydrocarbon}) \\ &= (94.05)(\text{mols C}) + (68.3)(\text{mols H}_2) - (-\Delta H_c) \quad (17) \end{aligned}$$

Equation (17) is in the units of *kilogram-calories per gram mol*. A few heats of formation calculated from the heats of combustion are given in Table 1.

		-(ΔH) _f			
Methane.....	+17.8	Propene.....	-4.9	Cyclohexane (L).....	+37.2
Acetylene.....	-54.2	Propane.....	+24.8	Benzene (L).....	-11.8
Ethylene.....	-12.5	n-Butane.....	+29.7	Toluene (L).....	-2.9
Ethane.....	+20.2	n-Pentane.....	+34.9	Xylenes (L).....	+5.9

Inspection of the above values shows that the heat of formation of petroleum fuels may amount to several per cent of their heat of combustion.

CORRELATIONS OF HEATING VALUES OF FUELS

Means of estimating heating values of fuels from known or easily determinable properties are of great importance, since direct calorimetric data are not always available. Chemical analyses furnish the most reliable basis for such estimations when they are to be had. Lacking chemical analysis data, calorific values may still be satisfactorily approximated from various *physical properties*.

Hereafter, all heats of combustion are gross values unless otherwise designated.

Gases. The heating value of a fuel gas is readily calculated from its analysis, as in Illustration 3. The calculated value is as accurate as the analysis, since the heats of combustion of all normal constituents of gaseous fuels are available.

The *oxygen required for combustion* of a fuel gas furnishes an approximation of its heating value:

$$\text{Btu/cu ft, 60}^\circ\text{dry, 30 in. Hg} = 96(\text{theoretical cu ft air/cu ft gas}) + 96 \quad (18)$$

Equation (18) is not valid for fuel gases that contain free oxygen, such as from air infiltration. However if the oxygen content is known, it may be corrected for and the equation applied to the oxygen-free residue. Measurements of air or flue-gas rate and the fuel rate during a test on a furnace enable use of the correlation.

Hydrocarbon gases are correlated in terms of gas gravity:

$$\text{Btu/cu ft 60}^\circ\text{ dry, 30 in. Hg} = 1500(\text{gravity}) + 185 \quad (19)$$

Equation (19) gives good results for most fuel gases. The calculated value for hydrogen is high, and the values for hydrocarbons above methane are somewhat low. For the many gases that contain both hydrogen and hydrocarbons, these errors largely offset each other.

The equation is invalid for gases containing inerts but may be applied if the gas analysis with respect to inerts is known, by first calculating the gravity for the inert-free material in the fuel. Hydrogen sulfide is not correlated by either Eq. (18) or Eq. (19).

Fuel Oils. When the heating value of a fuel oil is calculated as the sum of the heats of the constituent carbon, hydrogen, and sulfur, the value so obtained is several per cent high owing to neglect of the heat of formation.

The calorific values of a wide variety of gasolines (hydrocarbon mixtures containing only traces of sulfur) have been published.¹¹ The plot of these data with a number of pure hydrocarbons, as *gross Btu per pound versus weight per cent of hydrogen*, is given in Fig. 8. The straight line on the plot is represented by the equation,

$$\text{Btu/lb} = 323.5(\text{per cent H}) + 15,410 \quad (20)$$

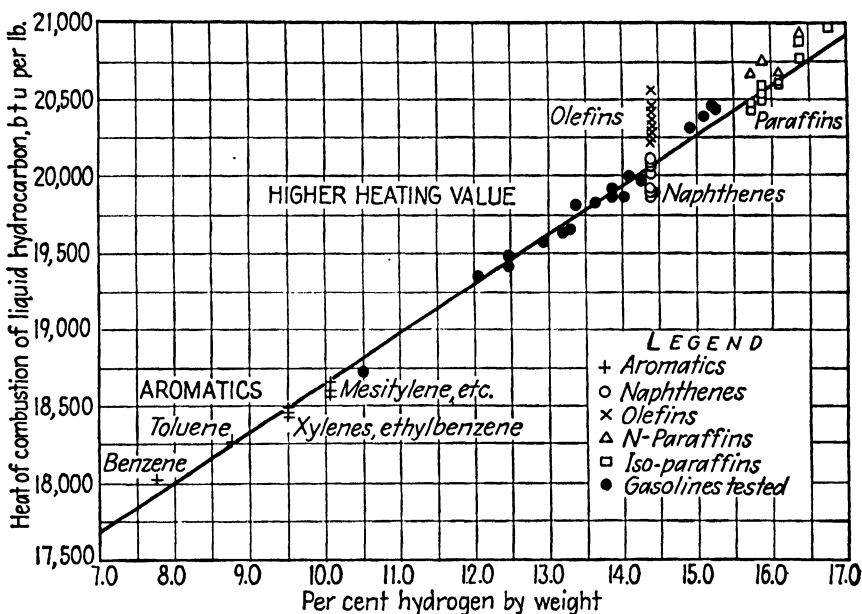

FIG. 8.—Correlation of heat of combustion with per cent hydrogen, applicable to petroleum fuels. (Courtesy of Jones and Starr.)

If a term for sulfur is included (using $69.3 \text{ kg-cal/g mol}$ as its heat of combustion), the formula becomes

$$\text{Btu/lb} = 323.5(\text{per cent H}) - 115(\text{per cent S}) + 15,410 \quad (21)$$

Calorimetric data obtained in the author's laboratory indicate that Eq. (21) applies to all grades of fuel oil with accuracy equal to that for gasolines. The hydrogen content may be calculated by the equations given in Chap. III. The sulfur correction is small, and the sulfur content need not be known with high precision; as an estimate, 0.5 per cent sulfur may be used for light fuels and 1 per cent or more for heavy fuels, depending upon the parent crude oil.

¹¹ JONES and STARR, *Ind. Eng. Chem., Anal. Ed.*, **13**, 287 (1941).

When no tests except gravity are available, the heat of combustion of fuel oils may be estimated by the formula,¹²

$$\text{Btu/lb} = 22,320 - 3780(S_{60})^2 \quad (22)$$

where S_{60} is the specific gravity at 60°F.

Equations (21) and (22) were developed for water- and sediment-free oils. If the water content of a heavy fuel is known, the necessary constants for use in these equations may be calculated for the dry oil, and allowance made for the weight of nonheating impurities present.

Solid Fuels. The *proximate analysis* has been correlated with the heating value of certain coals. The *heating value of anthracite* is given by the formula,¹³

$$\text{Btu/lb} = 14,803 + 75.8(\text{VM}) - 167.4(\text{A}) \quad (23)$$

The heating value of bituminous coals containing more than 10 per cent and less than 40 per cent volatile matter is correlated by the author's equation,

$$\text{Btu/lb} = 147.5(\text{FC}) + 255(\text{VM}) - \frac{270(\text{VM})^2}{\text{FC} + \text{VM}} \quad (24)$$

In Eqs. (23) and (24) VM, FC, and A are *per cents of volatile matter, fixed carbon, and ash*, respectively, on the dry basis. Neither equation is accurate for weathered samples. Equation (24) is not accurate for lignites, boghead, and cannel coals.

When the ultimate analysis is available, the heating value of a coal may be approximated by a modification of the Dulong formula,

$$\text{Btu/lb} = 145.4\text{C} + 620 \left(\text{H} - \frac{\text{O}}{8} \right) + 41\text{S} \quad (25)$$

in which C, H, O, and S are weight per cents of carbon, total hydrogen, oxygen, and sulfur, respectively. The original form of Eq. (25) was a summation of the heats of combustion of carbon as coke, net hydrogen, and sulfur as iron pyrites. A compilation of the numerous heating value formulas for coal has appeared.¹⁴

Equation (25) can be converted into another useful form. On the basis of *1 lb of carbon in coal*,

$$\text{Btu/lb carbon} = 14,540 + 62,030 \left(\text{net } \frac{\text{H}}{\text{C}} \right) + 4050 \left(\frac{\text{S}}{\text{C}} \right) \quad (26)$$

¹² CRAGOE, C. S., *Nat. Bur. Standards, Misc. Pub.* 97 (1929).

¹³ SCOTT, JONES and COOPER, *Ing. Eng. Chem.*, **31**, 1025 (1939).

¹⁴ SELVIG and GIBSON, "Chemistry of Coal Utilization," Vol. I, Chap. 4, John Wiley & Sons, Inc., New York, 1945.

H, C, and S are weight percentages of hydrogen, carbon, and sulfur, respectively. Equation (23) or (24) with Eq. (26) may be used to estimate the *hydrogen/carbon ratio* from the proximate analysis of a coal.

For convenience, a summary of the more commonly used of Eqs. (13) to (26) is given as Table 2 at the end of this chapter.

EFFECT OF TEMPERATURE LEVEL

The effect of temperature level on the heat of a chemical reaction or a change of phase may be visualized by a four-step cycle on temperature-energy coordinates, as in Fig. 9:

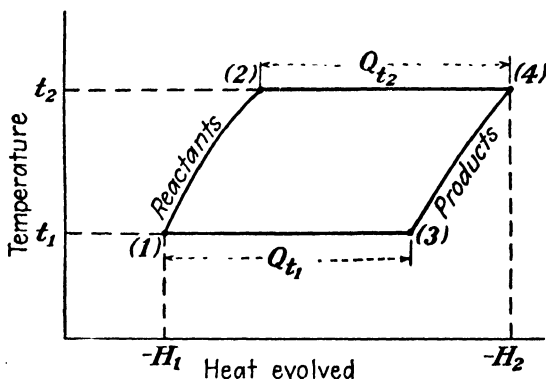

Fig. 9.—Effect of temperature level on heat of reaction and/or heat of vaporization.

To go from (1) to (4), there are two routes on the diagram.

(1)–(2). Heat added to initial system, raising its temperature from T_1 to T_2 .

(2)–(4). An isothermal chemical reaction or change of phase at T_2 . Alternately,

(1)–(3). An isothermal chemical reaction or change of phase at T_1 .

(3)–(4). Heat added to *reacted system*, raising its temperature from T_1 to T_2 .

For combustion or other chemical reaction at constant pressure:

$$\begin{aligned} (MCp)_{\text{reactants}}(T_2 - T_1) + Q_{T_2} &= Q_{T_1} + (MCp)_{\text{products}}(T_2 - T_1) \\ Q_{T_2} &= Q_{T_1} - [(MCp)_{\text{reactants}} - (MCp)_{\text{products}}](T_2 - T_1) \end{aligned} \quad (27)$$

For a vaporization process at constant pressure:

$$\begin{aligned} (MCp)_{\text{liq}}(T_2 - T_1) + (Mr)_{T_2} &= (Mr)_{T_1} + (MCp)_{\text{vapor}}(T_2 - T_1) \\ (Mr)_{T_2} &= (Mr)_{T_1} - [(MCp)_{\text{liq}} - (MCp)_{\text{vapor}}](T_2 - T_1) \end{aligned} \quad (28)$$

The effect of temperature level on Q or Mr is seen to be determined by the difference in heat capacities of the initial and final components of the system. Heats of combustion are affected only slightly by *temperature level* in most cases.

Heats of vaporization decrease with increasing temperature, approaching and becoming zero as the temperature approaches and attains the critical temperature, where the distinction between vapor and liquid disappears.

ADIABATIC COMBUSTION TEMPERATURES

If a fuel could be burned under conditions in which no heat was lost by conduction, convection, or radiation, all of the heat of combustion of the fuel would go to increasing the sensible heat of the combustion gases. The temperature *calculated* for such a condition is designated *adiabatic combustion temperature* and is the highest temperature that any part of a furnace may have to withstand.

Adiabatic combustion temperature is computed by a heat balance, in which the net heat of combustion of the fuel is set equal to the sensible heat gained by the combustion gases. For a pound or a mol of fuel burned with a definite per cent of excess air,

Let n = mols of a combustion gas product

MCp = mean molar heat capacity between the initial and final temperatures t_1 and t_2

Then,

$$(-\Delta H_c)_{\text{net}} = [(nMCp)_{\text{CO}_2} + (nMCp)_{\text{H}_2\text{O}} + (nMCp)_{\text{CO}} + (nMCp)_{\text{O}_2} + (nMCp)_{\text{N}_2} + (nMCp)_{\text{SO}_2}](t_2 - t_1) \quad (29)$$

Since t_2 is the unknown to be solved for and the molar heat capacities depend on t_2 , Eq. (29) must be solved by successive approximations. This is readily accomplished since the heat capacities change only slowly with temperature. In most cases, the amount of excess air is of greater influence on the adiabatic combustion temperature than are the characteristics of the fuel. The principal exceptions are acetylene and fuel gases containing large amounts of inerts, such as producer gas.

When t_1 is taken as $60^\circ F$, molar heat capacities for use in Eq. (29) are read from Fig. 2. As a first approximation, molar heat capacities may be taken as at $4000^\circ F$ for no excess air; as at $3000^\circ F$ for 50 per cent excess air; or as at $2500^\circ F$ for 100 per cent excess air. A second solution of Eq. (29) using mean heat capacities at the trial value of t_2 usually gives results within the precision of reading Fig. 2.

Flame Temperatures. The term *flame temperature* is indefinite. It has been used to denote *maximum* temperature occurring in a flame, and also as the *overall* temperature (that of the combustion products if no heat were removed from them). Since neither air-fuel mixing nor combustion processes are instantaneous, the local temperature at various points on a flame varies greatly (see Chap. VI). In the case of gas-burner flames, the highest local temperature occurs at the center of the flame

envelope (or on the axis of a burner port) at a short distance beyond the point at which ignition takes place, *i.e.*, a short distance beyond the inner cone of a bunsen-type flame. Under some conditions, the actual temperature at this point is higher than the adiabatic combustion temperature. Experimental flame temperatures are in fairly good agreement with adiabatic combustion temperatures for gases when burned with high percentages of primary or premixed air.

The adiabatic combustion temperature with theoretical air is designated *stoichiometric maximum flame temperature* in this text and has been designated elsewhere as *theoretical maximum flame temperature*. Stoichiometric maximum flame temperatures are usually 50 to 300°F higher than actual maximum flame temperatures. The highest actual temperatures occur when a fuel is burned with a slight deficiency of air. Actual maximum temperatures for pure combustible gases burned in air that is not preheated range from 3400 to 3800°F, with a principal exception of acetylene, whose maximum temperature is much higher.

At temperatures above 3000°F, combustion reactions are not quantitative (see Chap. VI), the heat capacities given in Fig. 2 may not entirely account for energy stored by atomic activation, and it is virtually impossible completely to eliminate radiation of heat from a flame in an experimental apparatus.

HEAT BALANCE ON INDUSTRIAL FURNACES

Before making an experimental heat balance, it is well to enumerate first the measurements required for a complete material balance: the quantities or average flow rates of all streams entering and leaving the process and chemical analyses where needed. These data with temperatures of the streams and heat of combustion of the fuel enable calculation of the heat balance.

Preliminary study of an operating unit reveals what quantities and temperatures are obtainable with existing plant equipment. It is often necessary to install some thermometers and to devise means and sometimes apparatus for obtaining flow rates of material. Continuous processes are always subject to certain degrees of fluctuation of operating conditions. When *flow rates* rather than *absolute quantities* are measured, instantaneous data are not dependable. Accordingly, the magnitudes of flow rate and temperature fluctuation should be ascertained and a test extended over a sufficient time interval to yield data whose averages give the desired accuracy.

To make a heat balance around a furnace, the sensible heat of all streams entering it—air, raw material, and fuel, plus the heat of combustion of the fuel—is equated to the total heat content of all streams leaving it—flue gas, product (ash, plus undeveloped heat as unburned combustible

in ash), and carbon monoxide in the flue gas. If chemical reactions occur in the material being processed, their heat effects must be accounted for.

When the results are compiled, total *heat output* is normally somewhat less than *total input*; the *difference* consisting of heat losses from the outside of the furnace walls and the net of all accumulated errors. The difference between total input and total output is designated *radiation and unaccounted-for*.

Equations are given in Chaps. XII and XIII whereby the heat loss from furnace walls may be calculated if wall surface temperatures and wind velocity are known. This completes the heat balance and, if data on any one stream are incomplete, its heat content may then be calculated by difference.

An experimental heat balance on a steam superheater is given in Illustration 4, and heat balances on other units are given at the ends of Chaps. XV and XVI.

Illustration 4

A small furnace unit is superheating steam used in a bubble tower in an oil refinery. The superheater is fired with refinery gas which has a gross heating value of 1740 Btu/cu ft, 60° dry, 30 in. Hg. The fuel gas contains 27 mol per cent air and 73 per cent hydrogen and hydrocarbons. The flue gas from the superheater is at 1350°F and is fed into a large tube heater so that its heat is not lost.

The superheater is constructed of a single course of firebrick, and heat loss to the atmosphere is unusually high. The following data are average figures obtained on a 24-hr test:

Fuel gas: 2,285 cu ft/hr, 60°F, dry, 30 in. Hg
 Air in: 91°F, wet-bulb = 71°F, dry-bulb = 81°F
 Steam in: 270°F, 5,850 lb/hr, assumed dry, saturated
 Steam out: 706°F, pressure = 16 psig.

Orsat analysis of flue gas: CO₂ = 9.8 per cent, CO = 0, O₂ = 6.2 per cent
 Make the heat balance around the superheater by the following calculations:

- The net heat input to the steam.
- The hydrogen/carbon ratio of the fuel gas.
- The gravity of the combustible portion of the fuel using Eq. (19). Then with (b), evaluate m and n in the empirical formula for the combustible: $m(CH_n)$, and the hourly mols of carbon and hydrogen in the fuel fired.
- The hourly mols of combustion air and the water vapor it contains.
- The hourly mols of dry flue gas and total water vapor.
- The hourly heat balance: *Heat input* as sensible heat of combustion air and heat of combustion of the fuel; *heat output* as net heat into steam, sensible heat in flue gases, radiation and unaccounted-for.

Solution: a. From Appendix, Table 5, the heat content of dry saturated steam at 270°F is 1170.6 Btu/lb and, by interpolation, that of superheated steam at 706°F and 16 psig (= 30.7 psia) is 1385.4 Btu/lb. The net heat into steam is then

$$5850(1385.4 - 1170.6) = 1.26 \times 10^6 \text{ Btu/hr}$$

- b. On the basis of 100 mols of dry flue gas,

$$\text{O}_2 \text{ entering as air} = (84)(20.9/79.1) = 22.2 \text{ mols}$$

$$\text{O}_2 \text{ disappearing to burn hydrogen} = 22.2 - 9.8 - 6.2 = 6.2 \text{ mols}$$

$$\text{Hydrogen/carbon ratio} = \frac{(6.2)(2)}{9.8} = 1.265 \text{ mols/mol}$$

c. The heating value of the combustible portion of the fuel gas is

$$\frac{1740}{0.73} = 2380 \text{ Btu/cu ft.}$$

From Eq. (19),

$$\text{Gravity} = \frac{\text{Btu} - 185}{1500} = \frac{2380 - 185}{1500} = 1.465$$

From (b), the empirical ratio of hydrogen to carbon may be written $(\text{CH}_{2.53})$, whose molecular weight is $12 + (2.53)(1.008) = 14.55$.

The value of m necessary to give the calculated gravity of 1.465 is

$$(29) \left(\frac{1.465}{14.55} \right) = 2.92$$

and the empirical formula for the combustible is $2.92(\text{CH}_{2.53})$.

The carbon in the fuel fired is

$$(2285_{356})(49\frac{2}{520})(2.92)(0.73) = 12.9 \text{ mols/hr}$$

and the combustible hydrogen is

$$(12.9) \left(\frac{2.53}{2} \right) = 16.3 \text{ mols/hr}$$

d. The air in the fuel gas is

$$(2285_{356})(49\frac{2}{520})(0.27) = 1.6 \text{ mols/hr}$$

and the total air entering the furnace is

$$(12.9) \left(\frac{84}{9.8} \right) \left(\frac{100}{79.1} \right) = 140 \text{ mols/hr}$$

Hence the combustion air is $140 - 1.6 = 138.4 \text{ mols/hr}$.

By Fig. 2 in Chap. IV, air having wet- and dry-bulb temperatures of 71 and 81° has a humidity of 0.013 lb/lb or $(0.013)(29\frac{1}{3}) = 0.0209 \text{ mols H}_2\text{O/mol dry air}$.

The water vapor brought in by the combustion air is

$$(138.4)(0.0209) = 2.9 \text{ mols/hr}$$

e. The dry flue gas is $(100)(12.9/9.8) = 131.6 \text{ mols/hr}$ and the total water vapor in the flue is $16.3 + 2.9 = 19.2 \text{ mols/hr}$, or 14.6 mols per 100 mols dry flue gas.

f. The heat of combustion of the fuel is

$$(2285)(1740) = 3.98 \times 10^6 \text{ Btu/hr}$$

The molar average heat capacity of air between 60 and 91° from Fig. 2 is 7.05, and that of water vapor is 8.07. The heat input from combustion air above 60°F is then

$$[(139.8)(7.05) + (2.9)(8.07)](91 - 60) = 31,200 \text{ Btu/hr}$$

The calculation of sensible heat above 60°F in 100 mols of dry flue gas and its water vapor is

	Mols	$MCp_{60 \rightarrow 1350}$	(Mols)(MCp)
CO ₂	9.8	11.35	111.2
O ₂	6.2	7.73	48.0
N ₂	84.0	7.32	61.5
H ₂ O.....	14.1	8.83	124.6
Total.....	898.8

The net sensible heat output in the flue gases above 60°F is

$$\left(\frac{131.6}{100}\right) (898.8)(1350 - 60) = 1.53 \times 10^6 \text{ Btu/hr}$$

Basis: 1 hr; datum temp = 60°F.

Heat in			Heat out		
	Btu	%		Btu	%
Air.....	31,200	0.8	To steam.....	1.26×10^6	31.4
Combustion of fuel...	3.98×10^6	99.2	Net in flue gas.....	1.53×10^6	38.2
			Radiation and unaccounted for.....	1.22×10^6	30.4
Total.....	4.01×10^6	100.0	4.01×10^6	100.0

TABLE 2.—SUMMARY OF HEAT CORRELATIONS

Gross Calorific Value of Gases (Dry, 60°F, 1 atm):

Natural gas (hydrogen-hydrocarbon mixture) free from inerts,

$$\text{Btu/cu ft} = 1500 (\text{gravity}) + 185$$

Fuel gas, O₂ free: Btu/cu ft = 96 (theoretical cu ft air/cu ft gas) + 96

Petroleum Fractions:

UOP Characterization Factor = $K = \sqrt[3]{T_b^\circ\text{R}/S_{60}}$

$$Cp_v = (0.045K - 0.233) + (0.44 + 0.0177K)10^{-3} t - (0.153)10^{-6} t^2$$

$$Cp_L = [0.355 + (1280)(^\circ\text{API})10^{-6} + (503 + 1.17(^\circ\text{API}))10^{-6}t] \times (0.05K + 0.41)$$

$$Mr = (T_b^\circ\text{R})[7.58 + 4.571 \log (T_b^\circ\text{R})], \text{ as Btu/lb mol at 1 atm}$$

Gross Calorific Value of Oils:

$$(a) \text{ Btu/lb} = 22,320 - 3780(S_{60})^2$$

$$(b) \text{ Btu/lb} = 323.5(\%H) - 115(\%S) + 15,410$$

$$\text{Wt. \%H} = 14.2 + 0.173(^\circ\text{API}) - 7250/T_b^\circ\text{R}$$

Gross Calorific Value of Coal:

From proximate analysis,

$$\text{Anthracite: Btu/lb} = 14,803 + 75.8(\text{VM}) - 167.4(\text{A})$$

$$\text{Bituminous: Btu/lb} = 147.5(\text{FC}) + 255(\text{VM}) - 270(\text{VM})^2/(\text{FC} + \text{VM})$$

TABLE 2.—SUMMARY OF HEAT CORRELATIONS.—(Continued)

(A, FC, and VM are per cents of ash, fixed carbon, and volatile matter, on dry basis. Correlations from proximate analysis are not accurate for weathered samples, lignites, boghead, and cannel coals.)

From ultimate analysis,

$$\text{Btu/lb} = 145.4C + 620 \left(H - \frac{O}{8} \right) + 41S$$

(C, H, O, and S are total weight per cents.)

$$\text{Btu/lb C} = 14,540 + 62,030 \left(\frac{\text{net H}}{C} \right) + 4050 \left(\frac{S}{C} \right)$$

(Correlations from ultimate analysis may also be used for low- and high-temperature coke.)

Net Btu/lb, coal and oils = (gross Btu/lb) - 91 (wt % total H)

Supplementary Reference

HOUGEN and WATSON: "Chemical Process Principles," Part I, John Wiley & Sons, Inc., New York, 1943.

Exercises

Temperature Enthalpy

- Calculate molal heat capacities of nitrogen: (a) between 15.5 and 600°C., (b) at 600°C.
- Using Fig. 2, calculate the molal heat capacity of CO₂ at (a) 1500°F, and (b) 3000°F. (c) How many Btu are required to cool 100 mols of steam from 2500 to 1000°F?
- Calculate the heat of combustion at 2500°F of (a) 1 mol of carbon as coke and (b) 1 mol of hydrogen. Assume that the reactions are quantitative. Take the average atomic heat capacity of carbon from 60 to 2500°F as 5.0.
- Calculate the adiabatic combustion temperatures with theoretical air, for (a) coke to CO, (b) coke to CO₂, (c) CO to CO₂. The reactants are initially at 60°F.
- Calculate the adiabatic combustion temperatures with theoretical air, for (a) hydrogen, (b) methane, (c) acetylene. The reactants are initially at 60°F.
- Solve Exercise 4 using 40 per cent excess air.
- Solve Exercise 5 using 40 per cent excess air.
- Calculate the gas temperature at which 50 per cent of the heat of combustion of coke will be lost in the flue gases, (a) with 40 per cent excess air and (b) with 100 per cent excess. The reactants are at 60°F initially, and combustion is complete.
- Calculate the gas temperature at which 50 per cent of the gross heat of combustion of methane will be lost in the flue gases, (a) with 40 per cent excess air and (b) with 100 per cent. The reactants are at 60°F initially, and combustion is complete.
- A refinery cracking stock has an API gravity of 30, an average boiling point of 530°F, and an average molecular weight of 210. Calculate the heat required to produce 1 lb of vapor at 530°F from oil at 60°F.

Heat of Combustion

- A coke-oven gas has the following analysis: H₂, 57; CO, 6; CH₄, 30; C₂H₄, 2.5; C₂H₆, 1.5; C₃H₈, 0.5; balance inerts.
 - What is its heating value as gross Btu/cu ft, dry, 60°F, 1 atm?
 - What is its net heating value for the same conditions?

12. By what per cent is the net heating value lower than the gross value for
- Methane?
 - A low-sulfur fuel oil containing 12.1 per cent hydrogen?
 - A bituminous coal having the analysis: C, 78; H, 5.2; O, 7.5; N, 1.2; S, 1.0 per cent?
13. A natural gas has a heating value of 1010 Btu cu ft dry, measured at 32°F and 760 mm.
- What is its heating value under *standard test conditions* (which are 60°F, 30 in. Hg and saturated with water vapor) as Btu/cu ft?
 - What is its heating value under *delivery conditions* of 14.4 psia and 60°F if its dew point is 30°F at this pressure?
14. A dry natural gas tested: gravity, 0.764; H₂S, 1.2; N₂, 4.3; O₂, 0.1 per cent. Estimate its heating value as gross Btu/cu ft, 60°F, dry, 1 atm.
15. A carbureted water gas gave the following partial analysis: gravity, 0.578; H₂S, 0.0; N₂, 5.2; O₂, 0.7; CO, 16.2; CO₂, 3.4 per cent. Estimate its heating value as gross Btu/cu ft, 60°F saturated, 1 atm.
16. The Orsat analysis of flue gas from a refinery cracking unit showed 8.7 per cent CO₂, 0.0 per cent CO, and 6.0 per cent O₂. The unit was burning a dry refinery gas which was found to contain no H₂S, and only small amounts of inert gases. Operating figures showed that 21.3 cu ft of air were being admitted to the furnace for each cubic foot of fuel, corrected to the same temperature and pressure.
- Calculate the molal H₂/C ratio of the fuel.
 - What per cent excess air is used?
 - Estimate the gross Btu/cu ft of the fuel.
17. A furnace oil being used to fire a pottery kiln had an API gravity of 30.6, a 50 per cent distillation temperature of 565°F, and negligible sulfur. Estimate
- The weight per cent hydrogen.
 - The net Btu/lb of the fuel.
18. The flue gas from a small power plant burning lignite tested 9.6 per cent CO₂, 0.2 per cent CO, and 8.2 per cent O₂. The fuel contains 46.3 per cent carbon, 6.3 per cent ash, and negligible nitrogen and sulfur.
- Complete the analysis of the lignite with respect to net hydrogen and water.
 - Estimate the heating value of the lignite as net Btu/lb on the "as-received" basis.

CHAPTER VI

EQUILIBRIUM AND KINETICS

PART 1. THERMODYNAMIC EQUILIBRIUM

LAW OF MASS ACTION

The cornerstone of the science of equilibrium and kinetics is the *law of mass action*, which was first clearly enunciated by Guldberg and Waage. Their statement is essentially: *The rate at which a chemical reaction proceeds is proportional to the active masses of reactants present.* "Active masses" were assumed to be molecular concentrations of the reagents or reacting substances. A chemical reaction conducted batchwise (as by simply mixing the reactants) normally proceeds fastest at first, continually slows down, and eventually ceases with certain concentrations of the reagents still present. This condition at which reaction seems to stop is designated *equilibrium*, and the concentrations of reactants and products at this point are the *equilibrium concentrations*. Many reactions satisfy these general conditions.

The *active mass-law concentration* of a substance, however, is often significantly lower than its actual molecular concentration. Investigations during the past two decades have made great progress on relations between *active* and *molecular* concentrations of many substances under various conditions. Gas-law deviations and their effect on equilibria can be accurately predicted in most cases by the use of *fugacities*. The applicability of the mass law is greatly extended when *active* rather than *total* concentrations are used in it.

Any chemical reaction in which all reactants and products are stable (or undergo no changes other than those of the principal reaction itself) is a *reversible reaction*. That is, it reverses in direction under suitable conditions.* It follows that no reaction is absolutely quantitative, and it is also proper to assume that a reversible reaction proceeds simultaneously in both directions.

For reversible reactions in general,



* *Reversible reaction* should not be confused with *reversible thermodynamic process*. The former is a property of certain chemical reactions whereas the latter is the most efficient path of a thermodynamic process.

Let k_a = a proportionality constant for the rate at which A reacts with B
 k_y = a proportionality constant for the rate at which Y reacts with Z
 Then according to the mass law,

$$\begin{aligned}\text{Rate}_{\text{left} \rightarrow \text{right}} &= k_a(A)(B) \\ \text{Rate}_{\text{right} \rightarrow \text{left}} &= k_y(Y)(Z)\end{aligned}$$

(Parentheses around capital letters denote *concentrations* of the substances so enclosed.)

Take, for example, the burning of a stoichiometric mixture of hydrogen and oxygen. Definite and determinable concentrations of these elements exist in equilibrium with water vapor at flame temperatures. When the mixture is cooled to room temperature, residual hydrogen and oxygen may not be detectable although, according to theory, definite albeit minuscule quantities must remain. The reaction can be reversed (water dissociated into hydrogen and oxygen) by the application of extremely high temperature, or by electrolysis of an aqueous solution.

Equation (1) assumes that the molecules must collide or at least approach each other very closely in order to react. Consequently when *two* molecules of A are necessary for a reaction,

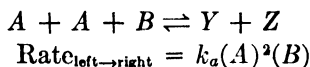

In the general case, the concentration of each component must be raised to a power equivalent to the number of molecules reacting. Thus,

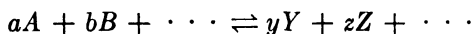

and

$$\text{Rate}_{\text{left} \rightarrow \text{right}} = k_a(A)^a(B)^b + \dots \quad (2)$$

When a reacting system is at *equilibrium*, the rates in both directions must be equal, and

$$\frac{(Y)^y(Z)^z \dots}{(A)^a(B)^b \dots} = \frac{k_a}{k_y} = K \quad (3)$$

Equation (3) defines the equilibrium constant K . The relation may be applied to both liquid and gaseous systems using appropriate units for expressing concentrations. When a reactant is present in the pure solid state, its concentration is constant and is taken as unity.

For a given system, the value of K depends upon temperature. Equation (3) is exact only in terms of fugacities, but may be used in terms of partial pressures or of concentrations with sufficiently accurate results for many important applications, *i.e.*, gas reactions at low pressures.

Except for the important case of internal-combustion engines, industrial combustions are usually conducted at a constant pressure of 1

atm and, for equilibrium calculations, *combustion gases* may be assumed to be ideal gases under furnace conditions. In this event, concentrations are directly proportional to *partial pressures*, and Eq. (3) is used in terms of partial pressures with the equilibrium constant K_p . Thus,

$$\frac{(p_Y)^y (p_Z)^z \cdots}{(p_A)^a (p_B)^b \cdots} = K_p \quad (3a)$$

By convention, the left-hand terms of a reaction as written are always put in the denominator of the equilibrium equation.

FREE ENERGY

A *driving force* or *thermodynamic potential* must be available to cause any reaction to proceed spontaneously. This driving force also determines the degree of completion or point of equilibrium to which the reaction will proceed. It is designated the *free energy change of the reaction* and obviously must be quantitatively related to K . *The free energy change of a reaction may be visualized as the theoretical maximum energy evolved or available for effective work, other than that equivalent to work done by the system expanding against an atmosphere or other resisting pressure.* The formal definition of free energy is

$$F = H - TS$$

and for a free-energy transfer or change,

$$\Delta F = \Delta H - T \Delta S \quad (4)$$

where ΔF = change in free energy

ΔH = change in enthalpy of system

T = absolute temperature

ΔS = change in entropy of system

All terms in Eq. (4) are customarily expressed in heat units. ΔH , as the change in total energy, includes external work against an atmosphere. $T \Delta S$ is the *theoretical minimum energy change* necessary to bring the system from the original to the final state. The difference between the two terms is then the energy available for driving the reaction under specified conditions of temperature and pressure.* Since ΔF and ΔH are taken as *energy decreases of the system*, a reaction has a high driving force when ΔH has a high negative value.

The *free energy of formation* of a compound from its elements is a definite quantity just as is heat of formation. The analogy also applies to

* Tabulations of free energies, enthalpies, and entropies are usually given at the "standard state" of 25°C and 1 atm. These values change with temperature and pressure, and the free energy of a reaction under other conditions may be widely different from its value at the standard state.

the *free energy of a reaction*, which may be calculated by subtracting the free energies of formation of the products from the sum of those of the reactants. Critical surveys and compilations of free energy and other thermodynamic properties of hydrocarbons and other compounds, including the principal constituents of gaseous fuels, have recently been made.^{1,2}

A compound is thermodynamically unstable with respect to decomposition into its elements unless its free energy of formation has a sizable minus value. Thermodynamic instability of hydrocarbons increases with temperature except for acetylene and possibly some of its derivatives. In other words, most hydrocarbons tend to decompose at elevated temperatures.

EFFECT OF TEMPERATURE ON EQUILIBRIUM

The free energy of formation of a compound and that of a reaction may be calculated at various temperatures from the values at the standard state. The other thermodynamic properties needed for this calculation are the specific heat-temperature relations for the substances involved. From thermodynamics,

$$d(\Delta H) = (\Delta C_p) dT$$

Specific heats are conveniently expressed as a function of temperature by the empirical relation,

$$C_p = a + bT + cT^2 + \dots$$

Combining the above for a given compound or reaction, the temperature-enthalpy relation becomes

$$\Delta H = \Delta H_0 + a'T + b'T^2 + c'T^3 + \dots \quad (5)$$

where ΔH_0 is the constant of integration. (By inspection it is an algebraic *extrapolation* of ΔH to absolute zero.)

From the definition of free energy, the relation

$$\int d\left(\frac{\Delta F}{T}\right) = - \int \frac{(\Delta H)}{T^2} dT \quad (6)$$

may be derived.

Combining Eqs. (5) and (6) and integrating give

$$\Delta F = \Delta H_0 - a'T \ln T + b'T^2 + \left(\frac{c'}{2}\right) T^3 + \dots + IT \quad (7)$$

Equation (7) is the conventional relation for ΔF of a reaction in terms of temperature. I is the constant of integration.

¹ THACKER, FOLKINS, and MILLER, *Ind. Eng. Chem.*, **33**, 584 (1941).

² Selected Values of Properties of Hydrocarbons, *API Research Project 44* (1942-1946), *Nat. Bur. Standards*.

Calculation of Equilibrium Constant. From the definition of free energy and Eq. (3)*

$$\Delta F^\circ = -RT \ln K \quad (8)$$

where values of both ΔF° and K must be taken at temperature T .

The relation for K in terms of temperature is obtained by eliminating ΔF between Eqs. (7) and (8) or by integrating the van't Hoff equation,

$$\frac{d \ln K}{dT} = \frac{\Delta H}{RT^2} \quad (9)$$

after eliminating ΔH between Eqs. (5) and (9). By either procedure the final equation is

$$\log K = -\frac{\Delta H_0}{2.3RT} + \left(\frac{a'}{R}\right) \log T + \left(\frac{b'}{R}\right) T + \left(\frac{c'}{2R}\right) T^2 + I'T \quad (10)$$

where I' is a constant of integration.

In the foregoing equations, the customary units of ΔF and ΔH are calories per gram mol, with T in degrees Kelvin. This requires that C_p and R be expressed in *calories per gram mol per centigrade degree*.

For a given substance or reaction, ΔH_0 , a' , b' , and c' have the same numerical values in Eqs. (5), (7), and (10).

Results of a critical survey³ of the equilibrium constants for reactions between constituents of combustion gases are plotted in Fig. 1.

Illustration 1

For the hydrogenation of ethylene,



- Determine the enthalpy and the free energy of the reaction at 25°C. ($\Delta S_{298} = 29$.)
- Evaluate the expression for ΔH vs. temperature.
- Evaluate the expression for ΔF° vs. temperature.
- Evaluate the expression for $\log K_p$ vs. temperature.
- For an original mol of ethane, calculate the equilibrium fraction dehydrogenated at 1000°K and 1 atm constant pressure.

Solution: a. From Chap. V, Table 1, the heats of combustion at 25°C of hydrogen, ethylene, and ethane are 68.3, 337.2, and 372.8 kg-cal/g mol, respectively, whence

$$\begin{aligned} -\Delta H_{298} &= 68.3 + 337.2 - 372.8 = 32,800 \text{ cal} \\ \Delta F^\circ_{298} &= \Delta H_{298} - (T \Delta S)_{298} \\ &= -32,700 + (298)(29) = -24,060 \text{ cal} \end{aligned}$$

* More complete details of the definitions, derivations, and restrictions applying to the equations given in this chapter may be found in textbooks on physical chemistry, on thermodynamics, and in the "Chemical Engineers' Handbook." ΔF° is the free energy change under *standard* or unit pressure, 1 atm for an ideal gas.

³ LEWIS and VON ELBE, *J. Am. Chem. Soc.*, **57**, 612 (1935).

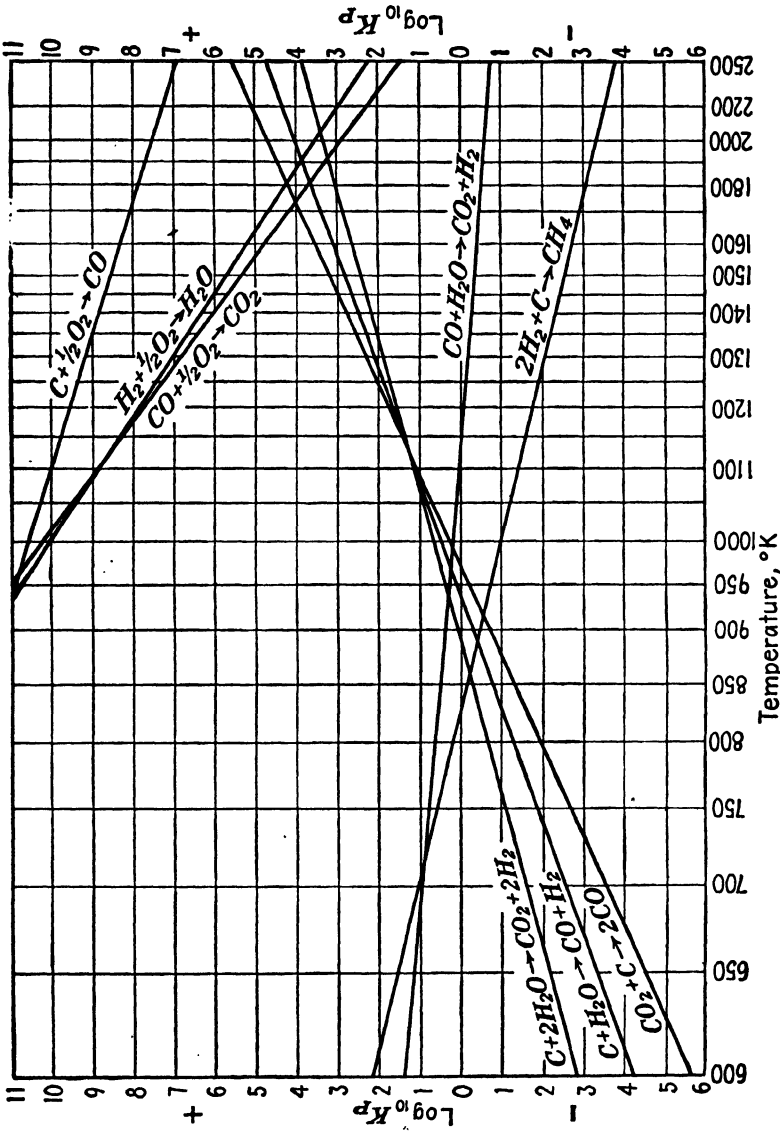

FIG. 1.—Equilibrium constants of combustion gas reactions.

Example: $\text{C} + 2\text{H}_2\text{O} \rightarrow \text{CO}_2 + \text{H}_2$; $K = \frac{(\text{CO}_2)(\text{H}_2)}{(\text{H}_2\text{O})^2}$. (Data from Lewis and von Elbe.)

b. The ΔH -temperature relation involves heat capacities of all reactants. For simplicity, ΔCp will be assumed linear with temperature,

$$\Delta Cp = a' + b'T$$

The two temperatures of interest to this problem are 25°C and 1000°K. For convenience in evaluating a' and b' , a temperature of 300°K will be used. From data in the literature:

MC_p	300°K	1000°K
Hydrogen.....	6.90	7.23
Ethylene.....	10.49	22.62
Ethane.....	13.16	29.82

from which,

$$(\Delta C_p)_{300} = 6.90 + 10.49 - 13.16 = -4.23$$

$$(\Delta C_p)_{1000} = 7.23 + 22.62 - 29.82 = -0.03$$

and

$$\Delta C_p = -6.03 + 0.006T$$

Equation (5) is

$$\Delta H = \Delta H_0 + a'T + b'T^2 + \dots$$

Substituting values at 298°K, $\Delta H_0 = -31,170$ cal and

$$\Delta H = -31,270 - 6.03T + 0.006T^2 \quad \text{Ans.}$$

c. Equation (7) for this case is

$$\Delta F^\circ = \Delta H_0 - a'T \ln T - b'T^2 + IT$$

Substituting values at 298°K, $I = -8.6$ and

$$\Delta F^\circ = -31,170 + 6.03T \ln T - (0.006)T^2 - 8.6T. \quad \text{Ans.}$$

d. Substituting values of the constants just obtained into Eq. (10),

$$\log K = \frac{6800}{T} - 3.04 \log T + 1.313 \times 10^{-3}T + 1.88. \quad \text{Ans.}$$

e. From the above equation,

$$K_{1000^\circ\text{K}} = 8.2$$

Letting x = fraction dehydrogenated at 1000°K and 1 atm constant pressure,

$$\frac{p_{\text{C}_2\text{H}_6}}{(p_{\text{C}_2\text{H}_4})(p_{\text{H}_2})} = \frac{1-x^2}{x^2} = 8.2$$

$x = 0.30 = 30$ per cent dehydrogenated at 1000°K. *Ans.*

NOTE: The best experimental value of K at 1000°K is about 5. Experimental and calculated values agree when calculations are carried out in a more refined manner.⁴

Illustration 2

The equilibrium constant for the reaction of hydrogen and oxygen to steam is 3 at about 4000°K.

When steam is heated to this temperature, what fraction is dissociated into H_2 and O_2 at 0.1, at 1.0, and at 10.0 atm total pressure? To simplify the problem, assume that no other type of dissociation occurs.

Solution: For the equation

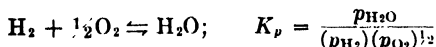

⁴ Supplementary Reference 2, pages 36-41.

Let x = fraction decomposed of 1 mol original steam. Then,

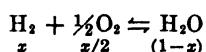

and total volume = $(x + x/2 + 1 - x) = (1 + x/2)$. Partial pressures of the constituents are

$$\begin{aligned} p_{\text{H}_2} &= \pi \left(\frac{\text{vol H}_2}{\text{total vol}} \right) = \frac{\pi x}{1 + x/2} \\ p_{\text{O}_2} &= \frac{1}{2} p_{\text{H}_2} \\ p_{\text{H}_2\text{O}} &= \frac{\pi(1 - x)}{1 + (x/2)} \end{aligned}$$

Substituting these expressions for partial pressures into the equilibrium equation and simplifying,

$$x = \frac{2}{3}[1 - (4.5\pi - \frac{1}{2})x^2]$$

which is readily solved by successive approximation to give

π , atm.....	0.1	1.0	10.0	
x = fraction decomposed.....	0.677	0.44	0.24	<i>Ans.</i>

Free energies of hydrocarbons and of their reactions have been the subject of much study in recent years because of the commercial importance of predicting equilibria such as hydrocarbon syntheses from carbon monoxide and hydrogen, catalytic cracking, alkylation, isomerization, hydrogenation, and dehydrogenation.

PART 2. CHEMICAL KINETICS

The concept of dynamic equilibrium has shown that the extent of completion of a reaction often depends upon the relative rates of forward and reverse changes. In almost all organic reactions, the "yield" is determined by the rate at which the desired reaction proceeds as compared to the rates at which undesired side reactions occur. For any process, the time required to obtain a definite amount of product is controlled by the *rate of the reaction*. The branch of chemistry that deals with factors influencing such rates of reaction is known as *chemical kinetics*.

The study of kinetics is one of the most difficult and complex branches of modern chemistry. Experimental measurements must always be made on a system while concentrations are changing. Also, a reaction for which one may write a single simple stoichiometric equation is very often the result of a complex series of steps. In rate studies, these individual steps must be completely distinguished in order to determine the true mechanism or path of the reaction. For example, the influence of moisture on the rusting of iron is well known; kinetically, the reactions of metallic iron with dry, gaseous oxygen and with oxygen dissolved in water are two radically different processes. In cases such as these it

may be difficult to determine what intermediate substances are actually involved.

Rate Constants and Units. The specific reaction velocity constant of a chemical reaction—designated by the symbol k —is defined as the time rate of reaction under conditions of unit concentration. The rate of reaction at any other concentration may be calculated by using k as a proportionality factor. (The specific reaction velocity is analogous to quantities such as specific gravity and specific heat.)

The symbols and units commonly employed are θ for time (seconds) and c (mols per liter) for concentration. It is assumed in all theoretical rate equations that the concentrations used are the *true active concentrations* of all the various reagents.* In practice, the problem of evaluation of active concentrations is often a major source of error in rate determinations.

Since the specific reaction velocity constant involves concentrations, the absolute rate of reaction in a finite system is continuously decreasing. To permit easy perception of *relative rates*, they are sometimes expressed in terms of the "half-life period"; *i.e.*, the time required for one-half of a given quantity of reactant to be converted. Typical values for velocity constants with their calculated half-life periods for thermal decomposition of some hydrocarbons are given in Table 1.⁵

TABLE 1.—RATES OF THERMAL DECOMPOSITION OF SOME HYDROCARBONS 550°C

	Specific react vel const ($k \times 10^5$) sec ⁻¹	Calculated half life ^a
Ethane.....	2.3	8 hr 29 min
Propane.....	45	26 min
<i>n</i> -Heptane.....	360	3 min
Ethylbenzene.....	28	41 min
Pentane-2.....	137	8 min
Cyclohexane.....	130	9 min

^a Assumes negligible rates of reverse reactions; not always valid.

CONCENTRATION EFFECTS; ORDER OF REACTION

Where the *law of mass action* is obeyed, there is a definite relation between the rate of a reaction and the concentration of its reagents. The form of this relation varies with different reactions and, on the basis of the number and type of concentration terms involved, reactions may be classified in terms of "order."

* Hereafter, *reagent* is used synonymously with *reactant*, in order to avoid frequent syllabic repetition between the latter and *reaction*.

⁵ PEASE and MORTON, *J. Am. Chem. Soc.*, **55**, 3190 (1933).

A reaction is designated as of the *n*th order if the rate can be expressed by an equation of the form:

$$\frac{-dc}{dt} = kc^n \quad (11)$$

Simple-order reactions with their concentration-rate expressions are:
First order:



Second order:



or

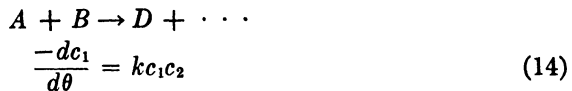

Third order:



or

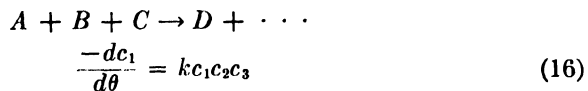

or

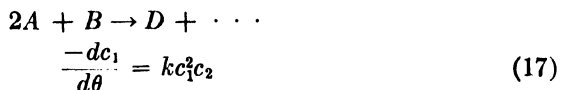

where *c* denotes concentration, *θ* time, and *k* the specific reaction velocity constant.

First-order Reaction. The simplest case is that of a reaction such as decomposition or isomerization involving only one reagent and whose rate is directly proportional to concentration, according to Eq. (12).

Integration of Eq. (12) gives

$$-\ln c = k\theta + \text{constant}$$

This requires that when values of $\ln c$ are plotted against corresponding time values, a straight line results. Other integrated forms of Eq. (12) follow:

Integration between limits gives

$$k(\theta_2 - \theta_1) = \ln \left(\frac{c_1}{c_2} \right)$$

where c_2 and c_1 are the concentrations at time θ_2 and θ_1 , respectively. If c_0 is the initial concentration, θ_0 is zero, and the equation reduces to

$$k = \frac{1}{\theta} \ln \left(\frac{c_0}{c} \right) = \frac{2.303}{\theta} \log \left(\frac{c_0}{c} \right)$$

If the half-life period is to be calculated, c is one-half c_0 and

$$\theta_{1/2} = \frac{2.303}{k} \log (2) = \frac{0.693}{k}$$

It should be noted that for a first-order reaction, the value of $\theta_{1/2}$ will be independent of c_0 ; thus the time required for 75 per cent of a sample to react is twice that required for 50 per cent of it to react.

In some cases reaction velocity may be followed by observing the rate of appearance of the product. Then,

$$\frac{dx}{d\theta} = k(a - x)$$

where a is the initial concentration of reagent and x the concentration of reagent stoichiometrically consistent with the amount of product present at time θ . For this case,

$$k = \frac{2.3}{\theta} \log \left(\frac{a}{a - x} \right)$$

It should be noted that the rates of first-order reactions are apparently independent of total pressure.

Second-order Reaction. Integration of Eq. (13) for a second-order reaction gives

$$\frac{1}{c} = k\theta + \text{constant}$$

Accordingly, a graph of $1/c$ versus corresponding times produces a straight line.

Integration between limits gives

$$k(\theta - \theta_0) = \frac{1}{c} - \frac{1}{c_0}$$

$$k = \frac{1}{\theta} \left(\frac{c_0 - c}{c_0 c} \right)$$

It is obvious that

$$\theta_{1/2} = \frac{1}{kc_0}$$

since at half-life time, $(c_0 - c) = c$. Thus, for a second-order reaction, the calculated half-life period *varies* inversely as the initial concentration.

If the rate of appearance of a product is to be measured, the rate equation is used in the form,

$$\frac{dx}{d\theta} = k(a - x)^2$$

or

$$k = \frac{1}{\theta} \frac{x}{a(a - x)}$$

If two different reagents are involved, Eq. (14) applies, where a and b are the initial concentrations of the two reagents. Integrating and solving for k ,

$$k = \frac{1}{\theta(a - b)} \ln \left[\frac{b(a - x)}{a(b - x)} \right]$$

Third-order Reaction. A similar analysis of Eq. (15) shows that

$$\frac{1}{2c^2} = k\theta + \text{constant}$$

A graph of values of $1/c^2$ versus corresponding time values then gives a straight line. Other integrated forms for the special type of third-order reaction having but a *single* reagent are

$$k = \frac{1}{\theta} \left(\frac{c_0^2 - c^2}{2c_0^2 c^2} \right)$$

$$\theta_{1/2} = \frac{3}{2kc_0^2}$$

$$k = \frac{1}{2\theta} \left[\frac{1}{(a - x)^2} - \frac{1}{a^2} \right]$$

For a third-order reaction having *three* reagents,

$$\frac{dx}{d\theta} = k(a - x)(b - x)(c - x)$$

which integrates to

$$k = \frac{1}{a'c'\theta} \ln \frac{a}{a - x} + \frac{1}{a'b'\theta} \ln \frac{b}{b - x} + \frac{1}{b'c'\theta} \ln \frac{c}{c - x}$$

where $a' = (a - b)$, $b' = (b - c)$, $c' = (c - a)$.

If the initial concentrations of two of three reagents are equal,

$$\frac{dx}{d\theta} = k(a - x)^2(c - x)$$

and

$$k = \left(\frac{1}{\theta}\right) \frac{1}{(c - a)^2} \left[\frac{(c - a)x}{a(a - x)} \ln \frac{c(a - x)}{a(c - x)} \right]$$

In practice, the "apparent" order of a reaction is commonly determined by measuring the concentration of reagents at various time intervals and then plotting functions such as $\log c$, $1/c$, $1/c^2$ against θ to determine which gives a straight-line relationship. The reaction velocity constant k may then be determined from the slope of the line.

Reaction order may also be calculated from half-life values at different concentrations, or by comparing values of k from the different equations. (In a given experiment, k is constant when the correct equation is used.)

Illustration 3

Table 2 gives the experimental results on the decomposition of nitromethane⁶ at 209.8°C, according to the equation,



The partial pressure of nitromethane (p) is used as the measure of its concentration.

TABLE 2.—RATE OF DECOMPOSITION OF NITROMETHANE

θ , min	p , mm	$\log p$	$1/p$	k_1 , calc	$k_2 \times 10^4$, calc
0	230.1	2.36192	0.00435		
7	184.2	2.26555	0.00543	0.0316	1.546
11	163.6	2.21379	0.00611	0.0298	1.708
16	139.7	2.14511	0.00716	0.0316	2.092
20	123.6	2.09189	0.00809	0.0306	2.332
23	112.3	2.05034	0.00891	0.0318	2.721
27	98.9	1.99539	0.01011	0.0316	3.015

On Fig. 2, $\log p$ and $1/p$ are plotted against time. The values of $\log p$ form a straight line as required for a first-order reaction.

The slope of the line is -0.01357 and

$$k = -(2.303)(\text{slope}) = 0.0313$$

⁶ STEADIE and SHAW, *Proc. Roy. Soc. (London)*, **A146**, 388 (1934).

In the fifth column of Table 2 are tabulated values of k calculated for a first-order reaction:

$$k = \frac{2.303}{\theta_2 - \theta_1} \log \frac{p_1}{p_2}$$

For example, between 11 and 16 min,

$$k = \frac{2.303}{16 - 11} \log \frac{163.6}{139.7} = 0.0313$$

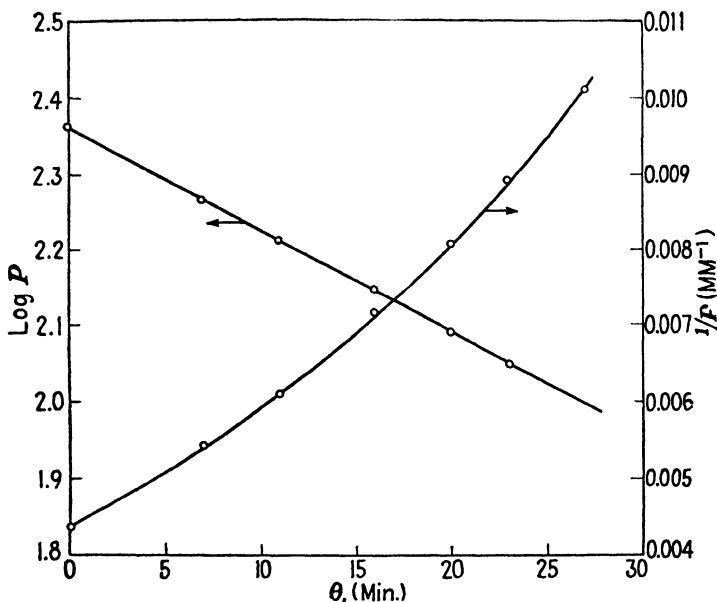

FIG. 2.—Rate of thermal decomposition of nitromethane at 209.8°C.

In the sixth column are tabulated values of k calculated for a second-order reaction:

$$k = \frac{1}{\theta_2 - \theta_1} \left(\frac{p_1 - p_2}{p_2 p_1} \right)$$

For example,

$$k = \frac{1}{16 - 11} \left(\frac{163.6 - 139.7}{163.6 \times 139.7} \right) = 2.092$$

The first-order values show only random variation, whereas the second-order values change consistently. The reaction must therefore be first-order.

Anomalies in Apparent Reaction Orders. More often than not, experimental rate data cannot be accurately represented by equations for first-, second-, or third-order reactions. This indicates fundamental inadequacy of the assumptions on which Eqs. (12) to (17) are based, in that the true reaction mechanism is not properly and completely accounted for.

Occasionally the rate of a reaction may be closely represented as of *fractional order*. For example, the decomposition of acetaldehyde at low temperature,⁷

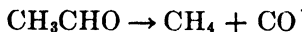

proceeds according to the rate equation,

$$\frac{d(\text{CH}_3\text{CHO})}{d\theta} = k(\text{CH}_3\text{CHO})^{1.5}$$

There is ample evidence, however, that most chemical changes are combinations of only first- or second-order steps. Apparent higher orders or fractional orders of reaction are actually the overall effect of the combination of much simpler steps. Consider the reactions

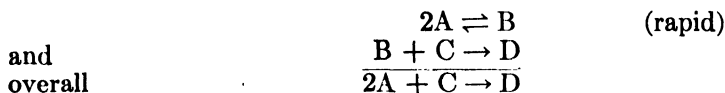

The rate of production of D would involve the expression

$$\frac{d(\text{D})}{d\theta} = k(\text{B})(\text{C})$$

but $(\text{B}) = K(\text{A})^2$, where K is the equilibrium constant. Therefore,

$$\begin{aligned} \frac{d(\text{D})}{d\theta} &= kK(\text{A}^2)(\text{C}) \\ &= k'(\text{A})^2(\text{C}) \end{aligned}$$

Experimentally, the overall effect of these steps is a third-order reaction.

Occasionally a *zero order* of reaction is observed, in which $dx/d\theta = k$, with the rate of reaction seemingly independent of concentration. Such an effect may result from a saturated surface in a catalytic reaction, or when an outside agency such as energy from light is necessary. The degree of catalyst surface adsorption in the former case and the rate of introduction of the light energy in the latter case, rather than the concentration of reagent, are then the controlling factors.

INTRODUCTORY MECHANISM

The simplest explanation of the effects of concentration of the various rate and equilibrium expressions is that *collision between molecules* is required for reaction. The number of molecules present in a given volume—the specific concentration—determines the probable frequency

⁷ LETORT, M., *J. chim. phys.*, **34**, 206, 265, 355, 428 (1937).

of molecular collisions. The experimental rate of reaction is directly related to the frequency of collision if this assumption is correct. The probability of more than three molecules colliding simultaneously is negligible, hence a reaction requiring more than three molecules of necessity involves a *sequence* of two or more steps. Consider the reactions whose stoichiometric equations are

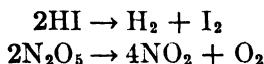

Experimentally, the first is second-order and may therefore be considered truly bimolecular and resulting from collision of two HI molecules. The second reaction, although involving two reagent molecules as written, is kinetically unimolecular. The explanation is found in *the series of reactions*,

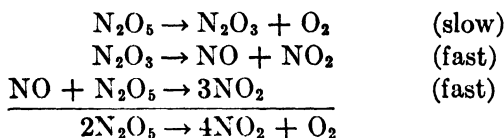

The overall reaction involves two molecules of nitrogen pentoxide, but the observed *rate* of decomposition is determined by the slow first step.

However, the order of reaction for a given set of conditions does not conclusively prove the mechanism. For example,

1. The hydrolysis of ethyl acetate in *dilute* water solution is first-order, yet the equation

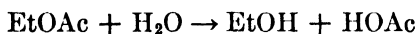

as written requires a bimolecular mechanism. Actually, the reaction is bimolecular, but experimental studies on dilute solutions indicate a first-order reaction because water is present in such large excess that its concentration undergoes no appreciable variation. Such a reaction is sometimes designated *pseudo-unimolecular*.

2. Experimentally, the reaction between iodide and iodate ions in solution is fifth-order, hence it must be concluded that the change actually involves several steps.

TEMPERATURE EFFECTS—ENERGY OF ACTIVATION

From a study of experimental data available at the time, Arrhenius discovered in 1889 that a general relation between temperature and rate of reaction is

$$\frac{d \ln k}{dT} = \frac{E}{RT^2} \quad (18)$$

where T is the absolute temperature, R the molar gas constant, and E a constant characteristic of the reaction. (E is expressed in energy units consistent with R and T .)*

Integration of Eq. (18) gives

$$k = ae^{-E/RT} \quad (19)$$

where a is a constant for a given reaction and is designated the *frequency factor*. The quantity E is called the *energy of activation*. It may be seen that the Arrhenius equation is similar to the van't Hoff equation which relates the equilibrium constant to temperature, and that E is analogous to the energy term (ΔH) of Eq. (9).

Values of a and of E for a given reaction may be determined by measuring the rate of a reaction at different temperatures. Integration of the Arrhenius equation between the limits of T_1 and T_2 and k_1 and k_2 gives

$$\ln \left(\frac{k_2}{k_1} \right) = \frac{E}{R} \left(\frac{1}{T_1} - \frac{1}{T_2} \right) \quad (20)$$

But when rate data at a number of temperatures are available, E is best evaluated graphically. Equation (20) may be written

$$\ln k = \frac{E}{R} \left(\frac{1}{T} \right) + \text{constant}$$

from which it is seen that a plot of $\log k$ against $1/T$ should give a straight line whose slope is $E/2.303R$.

A numerical value of k_2/k_1 is designated *temperature coefficient* of a reaction and is usually evaluated over a 10°C temperature interval. Another method of expressing the increase in rate with temperature is by the *number of degrees required to double the rate of reaction*, or $T_2 - T_1$ for which $(k_2/k_1) = 2$. Inspection of Eq. (20) shows that where E is independent of temperature, the temperature coefficient *decreases* and the temperature interval required to double the rate *increases* with *increasing temperature level*. Likewise, the smaller the value of E , the smaller will be the effect of temperature. In many cases, the temperature interval necessary to double the rate is about 10°C at ordinary temperatures, and as much as 25°C at extremely high temperatures.

Illustration 4

For uncatalyzed thermal dehydrogenation of ethylbenzene to styrene,

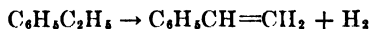

k is found to have values given in the second column in the accompanying table.⁸

* The Arrhenius equation is not exact or universal but a very good approximation over fairly wide ranges of temperature.

⁸ PEASE and MORTON, *op. cit.*

Temp °C	$k \times 10^4$	Temp coeff, k_2/k_1	E , cal per mol
540	1.6		
550	2.8	1.75	74,400
560	4.5	1.61	64,600
580	12.1	1.35	70,200

The temperature coefficient between 540 and 550°C, is

$$\frac{k_2}{k_1} = \frac{2.8 \times 10^{-5}}{1.6 \times 10^{-5}} = 1.75$$

The coefficients between other 10-degree intervals are tabulated in the third column

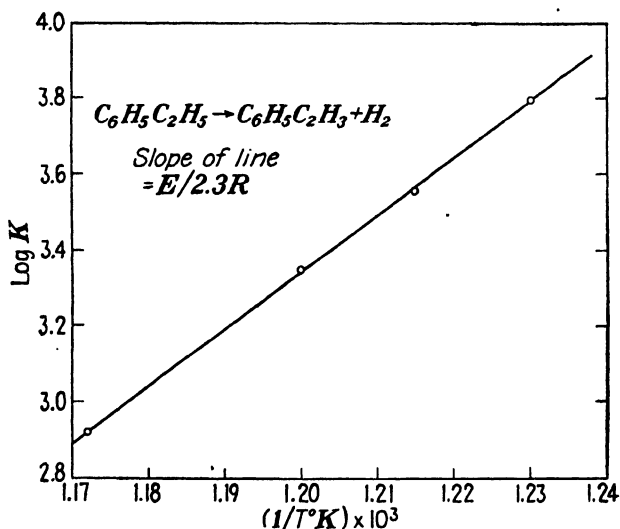

FIG. 3.—Thermal dehydrogenation of ethylbenzene at 1 atm.

The energy of activation is calculated from Eq. (20)

$$E = 2.3R \log \left(\frac{k_2}{k_1} \right) \left(\frac{T_2 T_1}{T_2 - T_1} \right)$$

For example,

$$\begin{aligned} E &= 2.303 \times 1.987 (\log 1.75) \left(\frac{823 \times 813}{823 - 813} \right) \\ &= 74,400 \text{ cal/mol} \end{aligned}$$

Since determinations at four temperatures are available, k is better determined graphically. The above data are plotted on Fig. 3, from which,

$$\text{Slope of line} = \frac{-E}{2.3R} = -15,150$$

whence

$$E = (15,150)(2.3)(1.99) = 69,300 \text{ cal/mol}$$

Energies of activation and frequency factors of a few typical hydrocarbon reactions are given in Table 3.⁹ The value of 79,385 cal required for thermal decomposition of methane is one of the highest encountered in organic reactions. Values for hydrocarbon reactions and combustion

TABLE 3.—BASIC CONSTANTS FOR UNCATALYZED HYDROCARBON REACTIONS

	Frequency factor, <i>a</i>	<i>E</i> , cal per mol
Thermal decomposition:		
Methane.....	1.0×10^{12}	79,385
Ethane.....	1.26×10^{14}	69,800
Propane.....	6.4×10^{13}	62,100
<i>n</i> -Butane.....	1.13×10^{17}	73,900
Polymerization (to dimers):		
Ethylene.....	7.1×10^{10}	37,700
Isobutane.....	2.0×10^{12}	43,000
Hydrogenation:		
Ethylene.....	3.77×10^5	43,150

processes are often between 25,000 and 60,000 cal. Activation energies of catalytic reactions may be much lower.

THERMAL DECOMPOSITION OF HYDROCARBONS

Hydrocarbons spontaneously decompose at elevated temperatures. Depending upon the temperature and the type of hydrocarbon, there may also occur molecular rearrangements, dehydrogenation, and polymerization. Thermal decomposition of high-molecular-weight paraffins is barely perceptible at 500°F, but the rates of all such reactions increase rapidly with temperature. The temperature range for commercial processes of thermal cracking and other uncatalyzed hydrocarbon reactions is about 850 to 1125°F. Thermal aromatization and certain dehydrogenation processes employ even higher temperatures (see Chap. II, Part 6).

Hydrocarbon decomposition reactions are approximately first-order. Because of the commercial importance of these reactions, many experiments have been made from which reaction velocity may be computed. Velocity constants of a number of these are summarized in Fig. 4.¹⁰ The plot was developed from data of which the rate of disappearance of the original stock could be observed or computed. The curves are stated to be dependable for depths of cracking (fractional decompositions)

⁹ From Supplementary Reference 3.

¹⁰ NELSON, W. L., "Petroleum Refinery Engineering," 2d ed., p. 306, McGraw-Hill Book Company, Inc., New York, 1941.

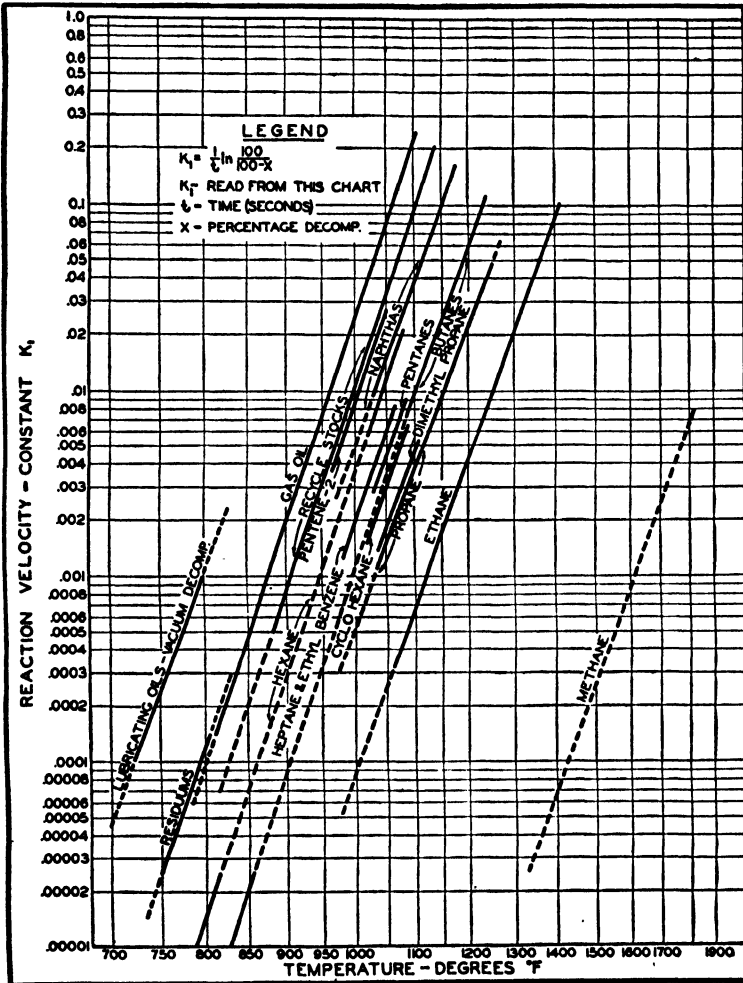

Fig. 4.—Constants for initial rates of thermal decomposition of hydrocarbons and petroleum fractions. (Courtesy of W. L. Nelson.)

up to about 25 per cent per pass, and in some cases are valid up to greater fractional decompositions.*

Using the notation on Fig. 4,

$$K_1 = \frac{1}{t} \ln \left(\frac{a}{a-x} \right)$$

* In deep-cracking operations, secondary reactions may produce compounds that are not distinguished from the original stock by the particular method of measuring decomposition. The rate constants are also invalidated by alteration of total moles of all compounds present or of the volume of the system during the reaction, as occurs progressively during the course of the cracking reaction.

or,

$$= \frac{1}{t} \ln \left(\frac{100}{100 - x} \right)$$

where K_1 = constant from Fig. 4

t = time at decomposition temperature, sec

a = fraction of crackable material in original stock ($a = 100$ for a "pure" stock such as a pure hydrocarbon or virgin gas oil)

x = fraction or percentage of stock decomposed or of a molar or volumetric equivalent of primary product formed:

1. For hydrocarbon gases (methane through heptane), x is mol or gas volume fraction of hydrocarbon decomposed
2. For naphthas through heavy residua, x is liquid volume fraction of 40°EP gasoline produced

Figure 4 may be used to estimate decomposition (with limitations as noted) but it is not suitable for calculation of energies of activation.

Illustration 5

Estimate the decomposition of butane during 5 sec at 1200°F in a thermal cracking unit.

Solution: From Fig. 4, K_1 for butane at 1200°F is 0.06. Solving the first-order equation,

$$0.06 = \frac{1}{5} \ln \left(\frac{100}{100 - x} \right) = \frac{2.3}{5} \log \left(\frac{100}{100 - x} \right)$$

$$x = 25.9 \text{ per cent decomposed}$$

THEORIES OF ABSOLUTE REACTION RATES

The ultimate goal of chemical kinetics is to predict reaction rates from fundamental properties of the molecular species involved. The essential problem is to be able to *derive* a satisfactory value of the specific reaction velocity constant from data that do not involve rate determinations. There are at present two lines of approach to the prediction of reaction rates. Both are based upon Eq. (19):

$$k = ae^{-E/RT}$$

Molecular energy is ultimately thermal in nature, and as the temperature of a system is raised the fraction of activated molecules it contains increases. For simple reactions, the exponential term in the preceding equation is a direct measure of the concentration of activated molecules, by the following reasoning: The translational velocity of a gaseous molecule is related to its energy. The molecules in any gas have a very regular numerical velocity distribution as represented by the Maxwell-Boltzmann curves (Fig. 5).

Let ϵ be the energy of activation for one molecule, or the minimum energy content it must possess to be capable of reacting. Let v be the velocity of a molecule having energy ϵ . The fraction of molecules having velocities in excess of v then have energies in excess of ϵ and are in the activated state. This fraction may be calculated from the relation:

$$\text{Fraction} = e^{-v/kT} = e^{-\epsilon/k'T}$$

or, for any quantity of gas such as 1 mol,

$$\text{Fraction} = e^{-E/RT}$$

The value of E is the energy to "activate" the molecules so that they may react.

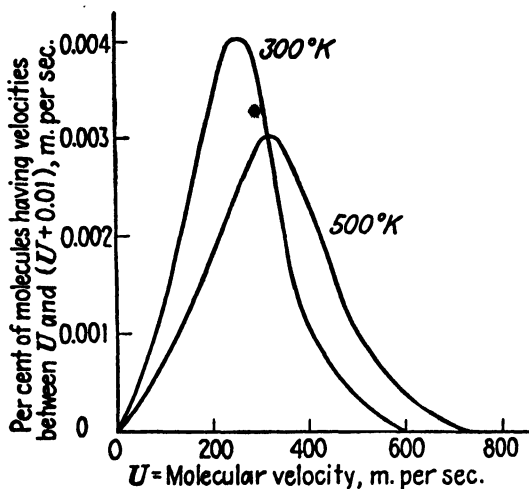

FIG. 5.

This simple hypothesis is not entirely adequate, as witnessed by the fact that the Arrhenius equation does not give the temperature coefficient of all reactions with absolute exactness. The frequency factor (a) may vary appreciably with temperature. The two current theories of absolute reaction rates differ in the method used to calculate this factor. The theories are designated, (1) collision, and (2) transition state (or activated complex).

Collision Theory. The collision theory is based upon the logical concept that reaction cannot occur between two or more molecules until those molecules come in contact with or close proximity to one another. A primary factor in determining the rate of a reaction is therefore the *frequency of collisions* between molecules. This is in addition to the second requirement that the molecules possess a certain minimum energy content. *The absolute rate of reaction should then be*

obtained by multiplying the number of collisions per unit time by the fraction of molecules which contain the required energy.

The influence of concentration on the rate of reaction is explained by its influence on the frequency of molecular collisions. In the case of gaseous materials, the number of collisions under specified conditions may be calculated on the basis of the kinetic theory using the laws of probability. Calculations show that the relation between *number of collisions* per unit volume and *number of molecules* per unit volume is identical with the relation between rate of reaction and concentration. For a simple reaction such as

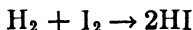

the frequency at which molecular collisions occur is numerically equal to the frequency factor a of Eq. (19).

The collision theory has the advantage that it provides a clear-cut mechanical model for the reaction process, but its calculations cannot in general be extended beyond simple, homogeneous, gas-phase reactions.

Many cases are known in which there is no agreement between calculated and observed values of the frequency factor. This is not surprising since the use of the term $e^{-E/RT}$ is based on the assumption that only the translational component of molecular energy influences reactivity of a molecule. For complex molecules, rotational and vibrational energy become important. For such molecules, factors such as orientation, internal energy, and distribution may well be expected to assume even more importance than the total number of collisions. As of the present, this seems to be a fundamental limitation to the collision theory.

This theory also fails to predict a *negative* temperature-rate coefficient. (For some reactions over limited temperature ranges, a *rise* in temperature causes a *decrease* in rate.)

Transition-state Concept. The second theory of reaction rates discussed by Daniels¹¹ is based upon the concept that the reaction of a molecule must be preceded by the formation of some sort of "intermediate complex." This complex then breaks down, either to form the original substances or new products. The complex (transition state) will exist only temporarily and may consist of a single "hot," activated molecule or of some grouping of molecules; but some such intermediate must be postulated for each reaction. Thus the reaction



involves two steps:



¹¹ DANIELS, F., *Ind. Eng. Chem.*, **35**, 504 (1943).



AB denotes the activated complex or transition state.

According to this theory, the observed rate of change will depend upon the rate of step (2) and thus upon the concentration of the activated complex. This in turn will depend upon the position of equilibrium in step (1).

Formally,

$$\frac{d(AB)}{d\theta} = k_{\ddagger}(AB)$$

where k_{\ddagger} denotes the specific rate of conversion of (AB) to C.

For the equilibrium in step (1)

$$K_{\ddagger} = \frac{(AB)}{(A)(B)}$$

Therefore,

$$\frac{d(AB)}{d\theta} = k_{\ddagger}K_{\ddagger}(A)(B)$$

The ordinary rate equation for this reaction would be

$$\frac{d(AB)}{d\theta} = k_{\text{obs}}(A)(B)$$

Then

$$k_{\text{obs}} = k_{\ddagger}K_{\ddagger}$$

Eyring and others have shown,¹² on the basis of modern concepts of quantum and statistical mechanics, that a reasonable value for k_{\ddagger} may usually be obtained from the relation

$$k_{\ddagger} = \frac{RT}{Nh}$$

where R is the Boltzmann gas constant, h is Planck's constant, and N is the Avogadro number.

The equation then becomes

$$k_{\text{obs}} = \frac{RT}{Nh} K_{\ddagger}$$

This relation is useful because K_{\ddagger} is an equilibrium constant, to which the familiar thermodynamic relations and calculations are applicable. Thus,

$$\Delta F_{\ddagger} = -RT \ln K_{\ddagger} = \Delta H_{\ddagger} - T \Delta S_{\ddagger}$$

¹² GLASSTONE, LAIDLER, and EYRING, "The Theory of Rate Processes," McGraw-Hill Book Company, Inc., New York, 1941.

where ΔF^\ddagger , ΔH^\ddagger , ΔS^\ddagger represent changes of free energy, enthalpy, and entropy, respectively, *involved in the formation of the activated complex.*

From the above,

$$k_{\text{obs}} = \frac{RT}{Nh} \cdot e^{-\Delta F^\ddagger/RT} = \frac{TR}{Nh} \cdot e^{\Delta S^\ddagger/R} \cdot e^{-\Delta H^\ddagger/RT}$$

Comparison with Eq. (19)

$$k_{\text{obs}} = ae^{-E/RT}$$

shows that the *energy of activation* (E) corresponds closely to the *enthalpy of activation* (ΔH^\ddagger). Actually, $E = \Delta H^\ddagger - RT$. The frequency factor a will be determined essentially by the entropy of activation (ΔS^\ddagger). It may also be noted that the RT/Nh term serves to explain the discrepancies already noted in the application of the Arrhenius equation to various reactions.

The influence of concentrations of the reagents upon the rate of reaction is explained by their influence upon the position of equilibrium and thus upon the concentration of the activated complex. The influence of temperature upon the rate is explained by its influence upon the value of the equilibrium constant K^\ddagger .

The transition-state concept has the advantage that the rate of reaction may be easily calculated whenever the necessary energy values are known. The major difficulty in its use at the present time is that the methods whereby these energies must be calculated are those of quantum and statistical mechanics. The calculations are quite laborious, and numerical values of the energies have not been calculated except for very simple reactions. These energy quantities may however be determined experimentally.

Summary and Comparison. A complete reaction process may be visualized as consisting of three steps:

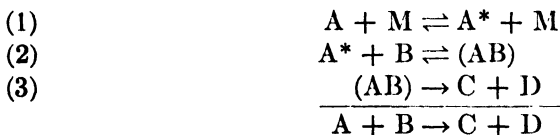

In step (1) a molecule of reagent A collides with some other molecule M and gains energy. In step (2) an activated complex is formed; and in step (3) the complex decomposes to form the products.

According to the collision theory, step (1) or (2) controls the overall rate. According to the transition-state theory, the third step determines the rate, and it depends upon the concentration of activated complexes. Actually there is no fundamental conflict between these theories. It is

probable that the mechanisms of both theories are involved in a reaction, the mechanism of one theory or of the other controlling the rate according to the special conditions that prevail.

At present, rates of reaction have been predicted successfully in but few cases. The frequency factor and the energy of activation must usually be determined from *observed* rates of reaction and the results summarized according to Eq. (19). In some cases, it has been necessary to introduce a correction factor into the transition-state equations to represent the probability of the activated complex crossing the energy barrier.

CATALYSIS

Kinetic studies show that a catalyst increases the rate of an *overall* reaction by providing new intermediate steps that require lower energies of activation. The final product is then formed more rapidly under the same conditions of temperature and concentration. The catalyst is a true reagent and only *seems* to take no part in the reaction because it is constantly regenerated. It has already been shown that a molecule must acquire a certain minimum of energy in order to react, and that the height of this energy barrier—as measured by the activation energy (E) or enthalpy (ΔH^\ddagger)—is a primary factor in the rate of reaction. The catalyst may serve (through formation of some intermediate compound) to make available a “pass” through this energy barrier, *i.e.*, a reaction mechanism involving a lower energy of activation. For example, the thermal decomposition of diethyl ether requires an energy of activation of 53,000 cal/mol. A trace of iodine catalyzes this reaction, decreasing the energy of activation to 34,300 cal/mol.

Distinction is sometimes attempted between an “intermediate compound” type of catalyst and a “contact” catalyst. The latter apparently functions by mere contact with the reagents.

A well-known example of “contact catalysis” is the decomposition of ethyl alcohol. In the presence of metallic copper, the principal reaction is *dehydrogenation*:



When alumina is used instead of copper, the alcohol is *dehydrated*,

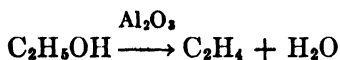

This phenomenon is explainable only on the basis of interaction between the alcohol and the catalyst. Careful study shows that the alcohol is

adsorbed on the catalyst surface. Thus one may write intermediate reactions such as,

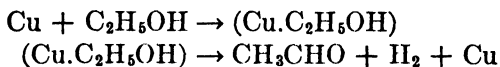

Some such adsorption is involved in the functioning of contact catalysts in general. In every case, an effective catalyst is an integral reagent in the true mechanism.

The preceding reactions illustrate what may be called "selectivity" of a catalyst for promoting only a certain reaction or type of reaction where more than one type is possible. This characteristic is of major practical importance, since catalysts can often be found that promote only a *desired* reaction. With the use of such a catalyst, there is much less time for undesired side reactions to occur and the yield of desired product is correspondingly greater. In addition to the time factor, a catalyst may increase further the yield of desired product by permitting the reaction to be carried out under milder or more favorable conditions of temperature and pressure so that undesired side reactions actually proceed at slower rates.

A catalyst usually lowers the energy of activation, but this is not the only means by which it may influence the rate. In recent studies on denaturation of proteins, certain reactions that show comparable rates have widely different energies of activation. Reaction velocity also involves a frequency factor, and this may conceivably be affected by a catalyst. In terms of the transition-state theory, alteration of the frequency factor involves a change in the *entropy of activation*. In certain cases of thermodynamic equilibria, entropy differences are of greater importance in determining the point of equilibrium than are the enthalpy differences. The same considerations should apply to the point of equilibrium of the transition state (whose relation to reaction rate is discussed in the preceding section).

COMPLEX REACTIONS

As previously discussed, interpretation of reaction mechanism is complicated by the fact that an overall change (as represented by a simple stoichiometric equation) frequently involves a series of consecutive "reactions" in the kinetic sense.

In some cases (as in nitrogen pentoxide decomposition) one step may be so much slower than any of the others that it determines the rate of the whole process. Other cases are much more difficult to represent by rate equations because several consecutive steps have rates of the same order of magnitude and each is influential upon the overall rate. Such complex reactions may be classified into three types:

1. Opposing Reactions :

For the reactions

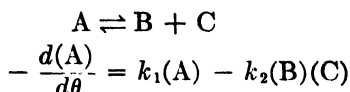

where k_1 and k_2 are *rate constants* for the forward and reverse reactions, respectively. Such a system finally attains equilibrium, where the *equilibrium constant* is

$$K = \frac{k_1}{k_2}$$

Therefore

$$-\frac{d(A)}{d\theta} = k_1(A) - \frac{K}{k_1}(B)(C)$$

Accurate determinations of both the equilibrium constant and the rate of approach to equilibrium at various concentrations permit k_1 and k_2 to be calculated.

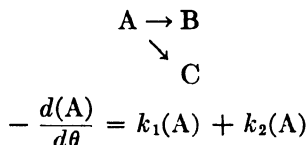
2. Side Reactions :

This situation is very common in organic reactions. The rate constants are determined best by measuring the rates of appearance of the products B and C independently. Many systems are much more complex, involving several different products.

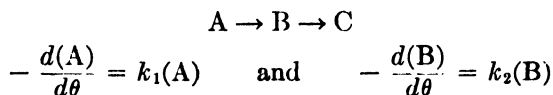
3. Consecutive Reactions :

Rate calculations here are complicated by the fact that the rate of the second step depends upon the continuously changing concentration of B.

Only the simplest possible cases—such as that of two successive first-order reactions—may be solved, unless independent methods are available for determining the concentration of each intermediate substance as well as that of the final product. If more than two steps are involved or if any step is of higher order, the relations become too complex for solution from overall rate determinations.

CHAIN REACTIONS

A *chain reaction* may be regarded as an important special case of consecutive reactions. In a chain reaction, one or more of the first products is itself a reagent ("chain carrier"). A chain carrier is consumed by one step but emerges from a later step, so that a given series of steps may be repeated indefinitely. The reaction between hydrogen and chlorine is a classical example:

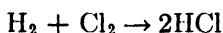

This is not a simple bimolecular reaction but is rather the result of the "chain" of reactions:



where steps (1) and (2) depend upon each other but continue in alternating sequence as long as conditions are favorable.

The chain is initiated by the formation of *atoms* of hydrogen or chlorine. Thus a hydrogen-chloride mixture that reacts very slowly in the dark may explode when exposed to light because the light may cause dissociation of the chlorine molecules and initiate numerous chains.

The steps shown above might continue until hydrogen or chlorine is exhausted, except for the occurrence of "chain-breaking" reactions that destroy the chain carriers, *e.g.*,

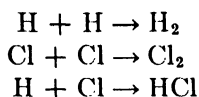

In general, the combination of atoms into molecules results in chain breaking.

It may be noted that the rate of production of hydrogen chloride depends upon a complex balance between the rates of chain-starting, chain-propagating, and chain-breaking steps.

This complex mechanism is also sensitive to experimental conditions. Recombination of atoms occurs readily on many surfaces; therefore the rate may be decreased very materially by increasing the relative amount of surface exposed to a reaction mixture. Any other substance or impurity present may influence the rate by reacting with and thus destroying chain carriers.*

In other cases, the surfaces of vessel walls or of other substances *increase* the rate by *producing* chain carriers.

* Certain substances suppress a reaction when present in very small or "trace" concentrations by destroying chain carriers. These are called "inhibitors."

Free Radicals. Propagation of a chain requires very active "carriers" or reagents containing sufficient energy to undergo rapid reaction without further activation. Free atoms are active chain carriers, but there are many chain reactions in which free atoms play only a minor or insignificant part.

Hexaphenylethane molecules are known to dissociate into two non-ionic groups in solutions. Lead tetraethyl when heated forms particles of sufficient reactivity to remove thin metallic mirrors previously deposited on a glass surface. Such particles must be "free radicals"—groups such as C_2H_5 —existing uncombined. There is ample spectroscopic and other evidence of the existence of the free radicals, CH_3 , CH , OH , CN , and many others. Free radicals are molecules in the physical sense but are inordinately "unsaturated" or reactive in the chemical sense.

Free radicals may act as chain carriers just as do free atoms. The photochemical decomposition of acetaldehyde, corresponding to the overall reaction

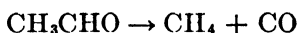

appears to have the chain mechanism

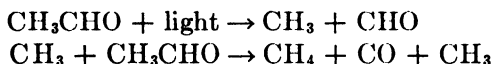

The *chain-breaking* steps apparently involve the reaction¹

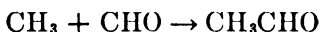

Chain Branching. Studies of oxidation reactions show that if the reaction of a chain carrier results in the production of not one but *two* new chain carriers, the resulting "branched chain" will show rapid acceleration and explosion. When branching occurs and *chain carriers* are not removed, the result is a rapid accumulation of carriers with consequent increased reaction and further production of carriers; this results almost instantaneously in a reaction of explosive rate.

Consider the hypothetical reaction of 1 cc of a stoichiometric (2:1) mixture of H_2 and O_2 at standard conditions. For the purpose of this illustration, assume that OH is the only chain carrier. If one new radical is formed for each radical reacting, the number of H_2 molecules reacting will effectively equal the number colliding with an OH radical. The number of collisions per second is approximated by the formula¹⁸

$$z = 2n_1n_2(\sigma_{1,2})^2 \left(\frac{2\pi rT}{\mu} \right)^{1/2}$$

¹⁸ KASSEL, I. S., "Kinetics of Homogeneous Gas Reactions," p. 31, Reinhold Publishing Corporation, New York, 1932.

where $\sigma_{1,2}$ = "collision diameter," approximately 3×10^{-8} cm

r = gas constant, per molecule

μ = "reduced mass" (function of molecular weights)

$$= \frac{m_1 m_2}{m_1 + m_2}$$

n_1 = 10H radical

n_2 = 1.73×10^{19} H₂ molecules

then,

$$z = 9.18 \times 10^9 \text{ collisions per second}$$

and according to Eq. (14),

$$\frac{dz}{d\theta} = kn_1 n_2$$

whence,

$$k = 5.31 \times 10^{-10}$$

If n_1 remains constant at 10H per cc, the reaction is first-order with respect to rate, and the half life for consumption of hydrogen is

$$\frac{0.693}{5.31 \times 10^{-10}} \text{ sec} = 41.4 \text{ years}$$

Now suppose instead that branching occurs in fraction f of all hydrogen collisions. Then, at any given moment,

$$n_1 = 1 + fz$$

$$n_2 = a - z$$

where a = initial concentration of H₂ and z = concentration that has reacted. The relation between time and collisions for constant fraction of branching is

$$\left[\frac{1}{1 + fa} \right] \ln \left[\frac{a(1 + fz)}{a - z} \right] = k\theta$$

Accordingly, if 1 per cent of the collisions result in branching ($f = 0.01$), the time for 99.9 per cent of the hydrogen to react is 5.57×10^{-7} sec.

Although these times are only rough approximations, they show the enormous influence of chain branching on rate of reaction. Branching of only 1 per cent of the chain steps accelerated a very slow reaction to explosive rate. Borderline conditions of pressure and temperature at which chain branching becomes appreciable are called "explosion limits."

A branched-chain reaction is not necessarily explosive. Reactions on surfaces or with other molecules in the gas phase may remove the extra chain carriers as rapidly as produced. The overall reaction may

then have any rate between very slow and explosive depending upon the balance between branching and breaking steps.

Evaluation of Chain Reactions. The kinetic equations become highly complex when applied to a series of consecutive steps such as occur in chain reactions. This leads to different and more elaborate techniques for studying chain reactions than are needed for simple rate studies. For example, a chain reaction may be carried out as a continuous process under carefully controlled conditions and flow rates, so that concentrations of all reagents at a given *point* attain a dynamic equilibrium or remain constant with respect to time.

With whatever information is available beforehand, a postulation of a possible or probable series of reactions is made, that is supposed to include all transitory and terminal products. The single and collective effects of different variables are studied, such as temperature, pressure, surfaces (clean and coated with salt, vessel-packing materials to provide additional surface area), and extraneous reagents. The effect of each of these variables upon the rate is then checked for theoretical agreement with the postulated reactions. Where discrepancies appear, further experimental data may be needed. Quantitative kinetic evaluation of a chain-reaction mechanism is a tremendous job beset with many difficulties.

THE HYDROGEN-OXYGEN REACTION

Chain reactions are of major practical importance if for no other reason than that combustion reactions are all of the chain type. The efficient operation of spark ignition and of diesel engines depends upon the *control* of chain reactions between the fuel hydrocarbons and oxygen of the air. Gas-phase combustion reactions are very rapid in a kinetic sense and are called "explosive" when the rate tends to become almost infinitely fast.

The hydrogen-oxygen reaction has been the subject of very extensive studies, since it is an almost ideal example of chain, combustion, and explosion reactions. It is the simplest overall combustion reaction (with the possible exception of formation of CO), and the only one of which both qualitative and quantitative knowledge is as yet nearing completeness. A recent article by Lewis and von Elbe¹⁴ treats this reaction comprehensively.

At certain temperatures, there are three distinct boundary values of *total pressure*, designated as *first, second, and third explosion limits*. Upon increasing the pressure, the reaction rate changes from slow to fast, fast to slow, or slow to fast, respectively, when first, second, or third limits are traversed. Although the exact pressures at which these phenomena

¹⁴ *J. Chem. Phys.*, **10**, 366 (1942).

occur are influenced by the nature and area of exposed surface, typical values encountered at 570°C are shown in Fig. 6. The explanation of the phenomena will now be outlined.

Reactions in the combustion of hydrogen involve chain carriers of which OH is very prominent. Exactly how the first OH radicals are formed is not of great importance, but it seems that hydrogen peroxide forms in traces on the walls of the containing vessel and may then decompose,

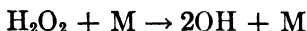

where M is any third body such as the wall or a gas molecule.

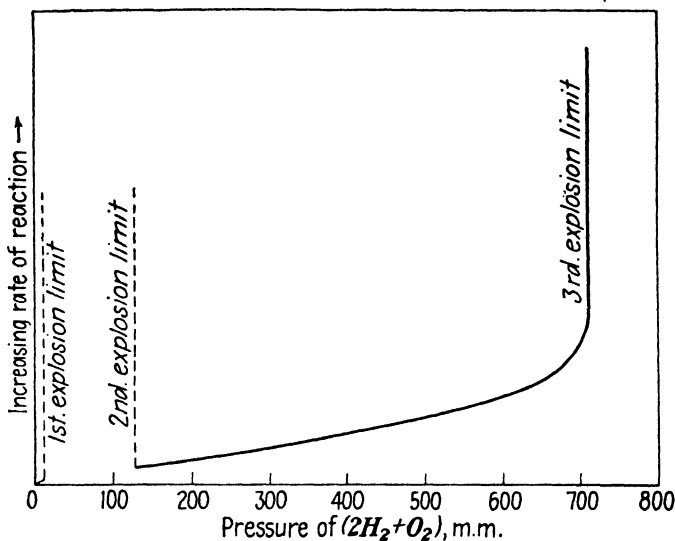
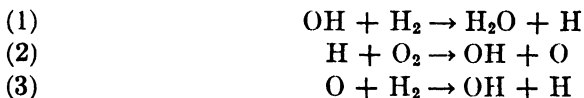

FIG. 6.—Explosion limits of stoichiometric hydrogen-oxygen mixture at 570°C.

The important chain steps in the conversion of hydrogen molecules into water molecules are



Step (1) is *chain propagating*, producing one molecule of final product (water), plus an atom of hydrogen to carry on the chain. Steps (2) and (3), however, are *branching reactions*, in which each radical destroyed produces two others. When steps (2) and (3) predominate, the rate of reaction will accelerate to explosive velocity.

First Explosion Limit. There are two distinct means by which chain carriers may be removed: by reactions at solid surfaces and by reactions in the gas phase. Below the first explosion limit, the rate of reaction

becomes very small because chain carriers rapidly find their way to the walls where they are destroyed. At comparatively low pressures where few molecules are present, H, O, and OH may collide with the walls and be absorbed *before* they collide with H₂ or O₂ molecules in the volume. Thus the reaction remains slow. Increased pressure increases the probability of collision with other molecules before the chain carriers reach the walls. As soon as a condition is reached at which the H, O, and OH are produced faster than they are eliminated at the walls, explosion occurs.

Support of this concept is obtained from the experimental fact that the first explosion limit varies consistently with the size and shape of the reaction vessel, the nature of its surface, presence of solid packing material, etc.

Second Explosion Limit. A second limit will exist if H, O, or OH radicals react with some gaseous molecule that effectively destroys them. At high pressures, gas-phase collisions are frequent and chain carriers may be removed with sufficient rapidity to keep the reaction slow. A decrease in pressure to the point where these reactions could not remove the carriers as fast as produced would then result in explosion.

In H₂-O₂ mixtures the homogeneous chain-breaking mechanism is

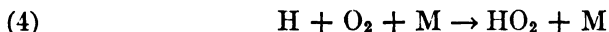

where M may represent any third particle (such as N₂, H₂O, etc.) present in the mixture and involved in a collision. HO₂ is not a stable "compound" in the ordinary chemical sense, but it is far less active than the H atom. It can exist long enough to reach the walls of the container and be adsorbed there, thus effectively removing H from the reacting mixture.

There are two possible *type* reactions upon collision of H and O₂:

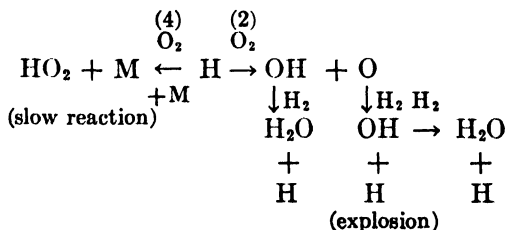

As indicated, an explosion occurs when step (2) predominates. An increase of pressure promotes the three-body step (4) relatively more than it promotes the two-body step (2), thereby suppressing branching.

At the second explosion limit, an *increase* of pressure actually prevents explosion by the effects just noted.

Third Explosion Limit. A reaction that is self-propagating must be exothermic. Thus the temperature of a reacting system tends to rise, whereupon an increasing fraction of the reagents becomes activated or forms radicals, and the rate is then self-accelerating. However, as soon as the temperature of the system becomes higher than that of the surroundings, heat is transferred out of the system. The maximum temperature attained by a reacting system depends upon a balance between rate of heat generation and rate of heat loss. Under favorable conditions, of which high pressure is a very important factor, a reaction may accelerate to explosive velocity.

The third explosion limit for the hydrogen-oxygen reaction shown on Fig. 6 apparently has a thermal basis. In contrast to the first and second limits which exhibit abrupt changes, temperature and rate at the third limit increase slowly at first but accelerate steadily to a final explosive velocity.

Supplementary References

1. GETMAN and DANIELS: "Outlines of Physical Chemistry," 7th ed., John Wiley & Sons, Inc., New York, 1943. On equilibrium, Chaps. 6, 7, 12; on kinetics, Chap. 14.
2. PEASE, R. N.: "Equilibrium and Kinetics of Gas Reactions," Princeton University Press, Princeton, N.J., 1942.
3. STEACIE, E. W. R.: The Kinetics of the Elementary Reactions of the Simple Hydrocarbons, *Chem. Rev.*, **22**, 311 (1938).

Exercises

1. The free energy of isomerization of butane



is +1,700 cal at 900°K and -160 cal at 400°K.

a. What percentage of isobutane in a mixture with *n*-butane is it theoretically possible to obtain by thermal isomerization of *n*-butane at 900°K?

b. What percentage of isobutane is possible by catalytic (AlCl₃-HCl) isomerization of *n*-butane at 400°K?

2. If methane is in equilibrium at 900°C and 1 atm with a producer gas that contains 10 per cent H₂,

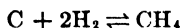

what per cent methane does the gas contain?

3. The secondary reaction from burning coke with insufficient air is

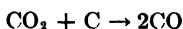

If a gas from dry air is at equilibrium at 900°C and 1 atm, what per cent of CO₂ will it contain?

4. Calculate the heat liberated on burning a mol of CO with theoretical air, taking into account the equilibrium between CO and CO₂ at atmospheric pressure and (a) 2000°C and (b) 2500°C.

NOTE: Fraction CO at equilibrium = $q = \left(\frac{p_{\text{CO}}}{p_{\text{CO}} + p_{\text{CO}_2}} \right)$

and heat liberated

$$= Q_T = (1 - q) [Q_{15^\circ} - (MCp_{\text{reacts}} - MCp_{\text{prods}}) (t - 15^\circ)]$$

Assume $Q_{15^\circ} = -\Delta H_{25^\circ}$ from Table 1, Chap. V.

5. For decomposition of *n*-heptane (assumed to give only *n*-heptene and hydrogen) with an initial pressure of 190 mm heptane, the time required for 25 per cent decomposition of the heptane is 130 sec at 540°C and 80 sec at 550°C. Calculate

a. k_{540} and k_{550} for the reaction.

b. E .

c. The time for 60 per cent of the heptane to be decomposed at 580°.

6. Reading K_1 from Fig. 4, calculate the per cent of decomposition (appearance of gasoline) in a thermal cracking process. The stocks and conditions are (1) gasoil at 900°F for 40 sec, (2) recycle stock at 1000°F for 10 sec.

7. Estimate the temperature at which a thermal cracking unit must be operated in order to have 50 per cent decomposition of butane during 4 sec.

8. For the thermal polymerization of ethylene (to butenes)

$$\log k = 10.85 - \frac{37,700}{2.3RT} \text{ (liter)/(mol)(sec)}$$

calculate the per cent of polymerization that would occur in 30 sec at 377°C and 50 atm pressure.

CHAPTER VII

THE COMBUSTION PROCESS

PART 1. MECHANISM OF COMBUSTION REACTIONS

Combustion is rapid, high-temperature oxidation. With the exception of combustion of elementary carbon, oxidation reactions occur in the gas phase. The discussion hereafter applies only to gas-phase reactions with the exception noted.

Combustion mechanism is that of rapid chain reactions, of which the hydrogen-oxygen reaction previously discussed is a relatively simple example. Chain reactions in the combustion of hydrocarbons are vastly more complicated. The type and predominance of the various chain steps depend to some extent upon the type of fuel but, since the essential chemical ingredients of all commercial fuels are carbon and hydrogen, the *process* of burning is controlled more by external factors such as concentrations, initial gas temperatures, and the manner of mixing of the combustion air, than by differences of composition and other characteristics of the fuel.

Flame. The usual combustion process is accompanied by the bright glow or flame characteristic of fast, high-temperature oxidation. The flame front or surface is an area of very rapid chemical reaction and is a boundary between burned and unburned gas that continually moves toward the unburned gas. The *thickness* of the flame front (or combustion wave) may range from very thin (tenths of a millimeter) to indefinite thickness, depending upon local conditions. Burning is relatively fast in commercial burner flames and, in passing through the flame front, combustion is either practically complete or consumes the locally available oxygen. The more rapid the combustion, the thinner the flame front and in the usual burner flame, *ignition* and *combustion* occur almost simultaneously and inseparably. Propagation of flame is generally a thermal process in that the flame must transfer heat to the unburned gas to cause it to ignite.

The shape of the flame is determined mainly by local conditions. Where a quiet inflammable mixture is ignited *at a point* as by a spark, the flame front moves uniformly in all directions away from the point of ignition, assuming the shape of an expanding sphere. In a commercial burner, the inflammable mixture issues from the end of a tube at con-

trolled velocity, and the flame front remains stationary in space. Flame traveling inside a tube is a special case discussed later.

Slow Combustion. Chain reactions in an ordinary flame occur so rapidly that no means are yet available directly to observe the kinetics or rates of the individual chain steps. Oxidation reactions proceed more slowly at subflame temperatures and, in the range 400 to 600°C, are slow enough to be measurable. Much qualitative and quantitative information on the fundamental reactions of combustion has been obtained in recent years by studies of the slow oxidation of various compounds mixed with air or oxygen in closed vessels at controlled temperatures and pressures.

Although chain mechanisms of slow combustion are not quantitatively identical with those of flames, they have many points of qualitative similarity. Information gained from slow combustion studies has already been instrumental in the development of improved fuels for internal-combustion engines. Chain reactions are of sufficient importance to be taken up in some detail.

CHAIN REACTIONS IN THE COMBUSTION OF HYDROCARBONS*

Because of their complexity, neither qualitative nor quantitative knowledge of chain reactions in the combustion of hydrocarbons is complete. The reactions discussed in the following sections are based on the evidence of data from a wide variety of careful experiments together with scrutiny of their theoretical soundness and probability. It is clear that successive, competing, overlapping, and opposing reactions occur simultaneously in a combustion process.

At the temperature of combustion, hydrocarbons rapidly dissociate into *free hydrocarbon radicals*. The hydrocarbon radicals are labile to oxygen attack; and highly reactive, unstable *oxygenated compounds or radicals* are formed which have only transitory lives. Nevertheless, it is now generally accepted that only through successions of these active radicals are the carbon and hydrogen of fuels converted into carbon dioxide and water. There is also convincing evidence that the atoms and radicals O, H, OH, and HO₂ involved in the oxidation of hydrogen are also active in the combustion of hydrocarbons. *Aldehydes*, although likewise of transitory existence, are essential links in the combustion process. The types of oxygenated radicals which form the aldehydes and are formed from them are still the subject of experimentation at the present writing.

Methane. The important primary and secondary chain steps in the slow combustion of methane are given in Table 1. Granting that the

* For comprehensive treatment of the subject consult Supplementary References 1 and 2 listed at the end of this chapter.

list is essentially complete and correct, *formaldehyde* is an intermediate of all chain mechanisms between methane and its final oxidation products and is formed only via the CH_3 radical.

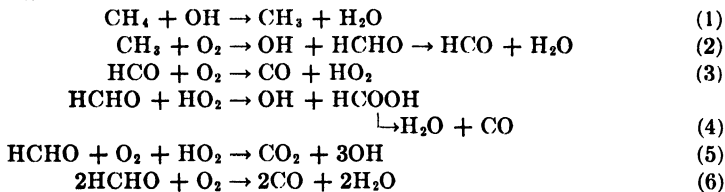
TABLE 1.—PRINCIPAL CHAIN REACTIONS IN THE COMBUSTION OF METHANE^a

^a Selected from publications of Lewis and von Elbe.

TABLE 2.—CHAIN REACTIONS IN THE COMBUSTION OF CARBON MONOXIDE^a

Involving hydrogen:

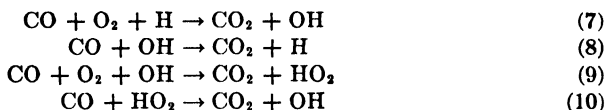

Not involving hydrogen:

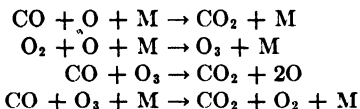

^a Selected from publications of Lewis and von Elbe.

Three of the steps in Table 1 produce carbon monoxide. Table 2 gives mechanisms by which CO may be converted into CO_2 . Whenever a burning mixture contains hydrogen in any form whatsoever, the chain carriers H, OH, and HO_2 appear. The presence of these accelerates the combustion of CO; hence in the usual case, its oxidation must be chiefly via Reactions (7) to (10).

At pressures above 1 atm, other reactions become important. With increasing pressures, methanol appears as an intermediate, in concentrations roughly proportional to total pressure.

Higher Hydrocarbons. Hydrocarbon radicals are formed by thermal decomposition and also by reaction with chain carriers. Thermal decomposition ruptures carbon chains but, at combustion temperature, either mechanism may result in the loss of hydrogen atoms. *Hydrocarbon radicals* combine with molecular oxygen to form peroxides. Peroxides are known to decompose spontaneously at elevated temperatures and they also react with aldehydes. Thus,

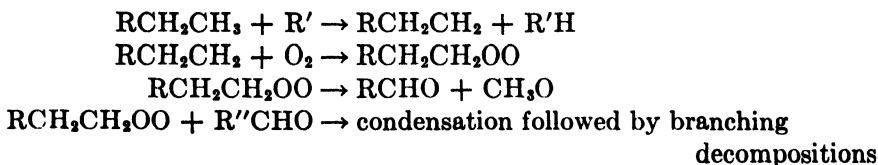

An aldehyde and a hydroxyl radical can react to form water plus a very active alkyl carbonyl radical:

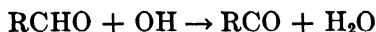

The carbonyl radical can react with oxygen to form a peracid radical:

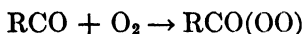

Peracids are known to be formed by reactions such as

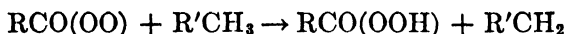

Peracids are very active and quickly decompose or react with other molecules or radicals. In high-temperature combustion, it is supposed that a prominent reaction is



Lewis and von Elbe have designated the above types of reactions "peroxide branching" and "aldehyde degradation."

To summarize, hydrocarbons are dissociated, oxygenated, and those above methane are successively degenerated to lower molecular-weight compounds. The end products are of course CO_2 and H_2O .

Acetaldehyde (and probably higher aldehydes) behave quite differently in the combustion process than does formaldehyde. Acetaldehyde is active in high-temperature chain reactions in the gas phase whereas high-temperature reactions involving formaldehyde are mainly at the walls, and in any event reaction products of formaldehyde are near the end products of combustion. Acetaldehyde appears in the combustion of higher hydrocarbons but not in the combustion of methane.

Spectrometric data on flames indicate the presence of CH , C-C , and C-cluster radicals, none of which are found at the lower temperatures of slow-combustion experiments.

TEMPERATURE AND OXIDATION RATE

For any combustible mixture under otherwise constant conditions, there exists a temperature below which chain carriers are not rapidly generated nor maintained in appreciable concentration. The rate of oxidation at lower temperatures is extremely slow and the minimum temperature at which oxidation rates are measurable depends upon many variables. Slow gas-phase oxidation of "undecane" at 200°C (392°F) has been reported.¹ Oxygenated compounds appear in unsaturated liquid hydrocarbon and petroleum samples after storage at atmospheric temperatures with access of air.

¹ BONE and TOWNEND, "Flame and Combustion in Gases," Longmans, Green and Company, New York, 1927.

Gas-phase chain carriers form at rates exponential with absolute temperature, chiefly by molecular activation (see Chap. VI) and dissociation. Since combustion chain reactions are of the same fundamental nature as other chemical reactions, increases in velocity constants with temperature are given by the Arrhenius-type equation,

$$k = k_0 \sqrt{\frac{T}{T_0}} e^{-(1-T/T_0)E/RT} \quad (11)$$

where k_0 is a *reference* velocity constant at temperature T_0 , E the activation energy, and R the gas constant.

When a combustible mixture is heated to some elevated temperature, the *concentration* of chain carriers at first increases. Other factors that destroy chains then come into play and, if conditions are such that the absolute rate of destruction of chain carriers becomes equal to the absolute rate of their generation, the rate of oxidation becomes steady. Algebraically,

$$n = \frac{n_0}{\beta - \alpha}$$

where n = concentration of chain carriers

n_0 = rate of chain initiation

α = coefficient of chain branching

β = coefficient of chain breaking

The following situations are evident from inspection of the above relation:

$\beta > \alpha$ Reaction rate measurable. (Finite and definite concentration of chain carriers.)

$\beta < \alpha$ Explosion zone. (Reaction rate continually accelerates, tending to become almost infinitely fast.)

The above relation is useful for determining the general mechanism of a combustion experiment but is very difficult to apply to an unsteady process since all the quantities in the right-hand term vary with temperature and other local conditions. Temperature is the most important variable in the combustion rate of a given experiment. Increasing the temperature may increase the coefficient of chain branching as well as that of chain initiation.

In the study of explosive reactions, it is frequently attempted to distinguish *thermal* from *branched-chain* mechanisms. By designation, a rapid increase in reaction rate leading to a *thermal* explosion depends upon temperature rise due to heat liberated by the reacting mixture. On the other hand, the acceleration of a reaction to an ideal *branched-chain* explosion can theoretically occur under isothermal conditions. Distinction between the two is by no means clear-cut.

Rates of chain initiation, of chain branching, and of chain breaking for a given system may have very different temperature coefficients. This observation can be used to explain seeming anomalies in slow oxidation and in certain ignition characteristics of aliphatic hydrocarbons that occur at temperatures between 300 and 400°C (*the ignition pressure peninsulas, temperature zones of nonignition, cool flames*). Low-temperature combustion experiments are complicated by an "ignition lag" or "induction period" during which the concentration of chain carriers is building up. (In the case of hydrocarbons, the concentration of aldehydes steadily increases during the induction period. The duration of the induction period for paraffins is greatly shortened by the addition of 1 per cent or less of an aldehyde to the original mixture.) The rate of oxidation increases exponentially during this period and terminates in either a moderate and steady or in an explosive reaction, depending upon local conditions.

Between 400 and 600°C, oxidation rates of various aliphatic hydrocarbons increase rather uniformly with temperature, but at 600°C (1112°F) rates for various individual hydrocarbons range from fairly rapid to quite fast. (Note that 600°C is in the higher temperature range of commercial "cracking" or thermal decomposition of petroleum fractions.)

Transitory combustion radicals are both qualitatively and quantitatively determinable at any temperature (including that of flames) by spectroscopic methods. Each kind of molecule and radical has characteristic or individual emission and absorption spectra, ranging from infrared to ultraviolet frequencies. Spectra of several of the combustion radicals have been charted within recent years and progress in the knowledge of combustion mechanism closely follows new developments in this field. The spectrometer has become an extremely potent scientific tool whose scope and usefulness are being extended yearly.

TOTAL PRESSURE AND OXIDATION RATE

The total pressure of a combustible mixture is a direct measure of specific concentration or molecular proximity. The mechanism of pressure effects on rate of oxidation or combustion should be regarded from this viewpoint.

Although a wall surface may initiate some chain carriers, it destroys others. The usual effect of a cold wall is to retard combustion. At low-pressure levels where the mean free path of the molecules is of the same order of magnitude as the vessel radius, chain carriers (particularly hydrogen atoms) find their way to the wall very quickly and are destroyed.

Over the approximate temperature range 400 to 600°C and starting at zero pressure, *two pressure zones of nonignition* bounded by first, second,

and third pressure "explosion limits" were noted for the hydrogen-oxygen system. In this and other systems, low-pressure noninflammability is due to rapid destruction of chain carriers by the wall. The intermediate pressure zone of noninflammability for the hydrogen-oxygen system is due to destruction of hydrogen atoms by the *homogeneous* reaction,

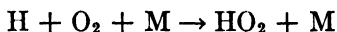

at a temperature and pressure in which HO_2 is inactive as compared to H. At higher pressures, thermal effects cause other reactions to become predominant, and HO_2 becomes an active chain *carrier* or even *brancher*, for example,

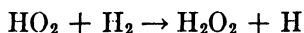

Thus at low pressures, factors of gas diffusion, size of chamber, and nature of its surface are often highly influential.

Similar phenomena appear in the combustion of other substances but are frequently less distinct or easy to observe. This must be expected where there is a greater variety of chain reactions. In the combustion of hydrocarbons, many of the radicals are both complex and highly unstable with respect to spontaneous decomposition. An additional effect of pressure here is to increase the frequency of collisions so that a greater fraction takes part in chain reactions.

TYPES OF GASEOUS COMBUSTION PROCESSES

It is convenient to classify gaseous combustion processes according to *mode of propagation of the combustion zone*, although border lines between the various modes are not sharp.

1. Homogeneous Combustion. A combustible gas mixed with air or oxygen and heated to a temperature of 400°C or higher often burns without the appearance of a definite flame front. The rate and course of the reaction depend upon controllable conditions, chiefly mixture composition, pressure, initial temperature, and factors of heat transfer to and from the surroundings.

This type of combustion is used in slow-combustion rate studies as already noted. Very rapid oxidation can, however, be brought about without the appearance of flame by careful control of conditions.

2. Isopiestic Flame Propagation. Flame results from ignition of a combustible gas or vapor where mixed with oxygen or air in such proportion that the reaction generates a high temperature, and so is self-propagating.

The isopiestic condition requires that the flame be unconfined so that no appreciable pressure is developed by the increasing volume of gases resulting from combustion. (In commercial burners, the *burned gases*

are free to expand. In central ignition of combustible gas in a soap bubble, the *unburned mixture* is free to expand. (See Rate of Flame Propagation, page 205.)

The isopiestic flame is characteristic of commercial burners. However, the rate and mechanism of combustion in the flame front are quite different when the combustible contains no oxygen (or less than that of the upper limit of inflammability) than when it is premixed with enough air so that the mixture is itself inflammable or explosive.

a. Inappreciable Premixed Air.—An ignited gas stream issuing into the atmosphere burns as rapidly but only as rapidly as it mixes with air to form a combustible mixture; for example, a candle flame or the blaze of burning gas issuing from a pipe. For a low-velocity jet of any appreciable size, the flame front fluctuates or wavers as thermal eddy currents mix the gas with air to combustible proportions.

Burners for certain applications are designed to cause gas and air to travel in almost parallel streams over a considerable length, so that air-gas mixing is slow but steady. The resulting flame is long and luminous—the “diffusion” flame.

b. Air Premixed with Gas—Inflammable Mixture.—This case includes the bunsen flame of commercial burners. An unconfined ignition-combustion wave or flame front propagates or travels through an inflammable mixture at a definite velocity. Completeness either of combustion or of consumption of premixed oxygen occurs during the brief interval in which the flame front passes a given point.

Rate of flame propagation is a function of mixture composition, temperature, and total pressure. When these variables are fixed, the rate of ignition or flame propagation becomes constant and measurable. Flame velocity depends more upon heat transfer from the flame front to the combustible layer immediately adjacent to it than upon the kinetics of combustion chain reactions. A fairly accurate estimation of flame speed may be made from knowledge of the type of fuel and the adiabatic combustion temperature of the mixture. (Quantitative effects of the principal variables in this important case are taken up in Part 2 of this chapter.)

3. Pressure-temperature Flame Propagation. Where combustion occurs in a confined or partly confined *space*, expansion of the burning gases develops appreciable pressure. The combustion process is affected to an extent depending upon the magnitude and manner of propagation of the combustion pressure. The magnitude of the generated pressure depends upon the fundamental burning speed of the mixture, the degree of confinement, and the total pressure.

a. Small Combustion Pressure.—A small local pressure unbalance equalizes itself or disappears very rapidly by bulk movement of fluid.

The velocity of a pressure wave may be as high as the velocity of sound, depending upon the steepness of the local pressure gradient. *Burning velocities* under isopiestic conditions are usually only a small fraction of the velocity of sound and are substantially unaffected by the development of moderate combustion pressures. *Volume increases during combustion cause small pressure unbalances, which in turn cause bulk movement of the burning gas. This may greatly accelerate the movement of the flame front with respect to a fixed point in space.*

The process of flame travel through an open tube filled with an inflammable mixture illustrates the above phenomenon. This has been the subject of many early combustion experiments. Suppose that the initial flame front is a plane of the cross section of the tube. Combustion raises the gas temperature and increases its volume so that the burned gas is pushed backward and the unburned gas moves regularly forward ahead of the flame front. Owing to friction and to the cooling effect of the tube wall, the flame travels most rapidly at the axis and lags near the wall, the flame front assuming the shape of a parabola of revolution. The surface area of the parabola is greater than that of the original plane, and more gas is burned per unit time. Thus there are two effects tending to accelerate flame travel in tubes, and the rate of flame travel in 1-in.-diameter glass tubes is roughly double its isopiestic velocity of propagation for many (nondetonating) mixtures. In large tubes, the occurrence of irregular vortices or convection currents further increases the surface area of the flame front, and the rate of flame travel is observed to increase with tube diameter.

b. Large Combustion Pressure.—Under conditions of rapid flame propagation, steeper combustion-pressure gradients occur. Where the effect of these approaches adiabatic compression, a compression-temperature increase occurs that accelerates the actual *burning velocity*. This effect is superimposed upon the bulk movement effect of (a). Thus the flame front may travel in space at velocities as high as those of sound. Small zones of high-velocity flame travel are responsible for part or all of the noise of burner flames.

Under conditions of both (a) and (b), combustion or oxygen consumption is essentially complete after the flame front has passed.

c. Detonation.—The chemical burning mechanisms discussed in items 2 and 3 are all identical. There is a small but finite preflame *induction period* (mentioned earlier) or *ignition lag* that is an important factor of the burning velocity. As long as the combustion mechanism remains the same, the speed of flame propagation does not exceed the velocity of sound in the mixture.

Mixtures that burn very rapidly (due to composition, preheat temperature, or both) under conditions of partial or total confinement or at

superatmospheric pressure, exhibit a radically different type of combustion known as *detonation*. Detonation is characterized by an extremely sharp pressure or "shock wave" that travels at supersonic velocities, frequently between 5,000 and 8,000 ft/sec. Energy carried by the wave is many times greater than that of an intense sound wave. It ignites the gas with no measurable delay; the combustion in turn releases the energy that supports the wave. Passage of the wave does not require complete combustion, and several waves in rapid succession may be supported by the same mixture. Shock-ignition waves must propagate at high velocities to be self-sustaining and may travel along and be reflected from solid surfaces.

Most combustible gases develop detonation waves in open tubes when mixed with oxygen and ignited. These and somewhat slower burning mixtures also can develop detonation waves when ignited in closed bombs.

COMBUSTION OF ELEMENTARY CARBON

Elementary carbon does not vaporize at ordinary flame temperatures, and its combustion occurs by heterogeneous reactions. Hotel and coworkers² studied the combustion of several forms of carbon under a variety of conditions and successfully developed theoretical rate equations. Following are some of their results and conclusions:

At temperatures below 1300°C the predominant reaction is *first order*, corresponding to



At temperatures above 1500°C, the predominant reaction is *zero order*, corresponding to



The energy of activation for the combustion of "brush carbon" (largely graphite) is about 44,000 cal. (It is probably lower for less graphitic carbon.)

At temperatures below 1000°C, reaction kinetics control oxidation velocity, but this "chemical" resistance decreases and becomes negligible above 1100°C where combustion rate is controlled by diffusion of oxygen to the carbon surface.

Photographic evidence and microsampling of the gas at various points show that both O₂ and CO concentrations decrease to low values near the surface. The rate of combustion varies linearly with the partial pressure of oxygen in the surrounding atmosphere, all else being equal. These observations indicate that the combustion of carbon is controlled by a mechanism whereby CO₂ is a primary product.

² *Ind. Eng. Chem.*, **26**, 749, 889 (1934); **28**, 1334 (1936).

PART 2. ENGINEERING PROPERTIES

SPONTANEOUS IGNITION TEMPERATURE

When a fuel is heated to some temperature under specified conditions, it spontaneously ignites and burns. The minimum temperature of self-ignition is designated *spontaneous ignition temperature* (SIT). As discussed in the preceding section, rates of oxidation tend to increase with temperature. Oxidation reactions are highly exothermic and, once started, oxidation can raise the temperature of the combustible mixture until it bursts into flame. The lowest temperature at which self-heating starts is obviously contingent upon a rate of heat generation in excess of the rate of heat loss to surroundings. Thus an experimental SIT for a given material is affected by any condition that has to do with rate of heat loss from the mixture.

Walls or surfaces of a confining vessel or tube may have a pronounced effect on oxidation rate at the lower temperature levels. The *condition* of the surface as well as the material of which it is made may also be influential. Bone and Townend¹ list 11 methods with which SIT values have been determined. Experimental values for a compound as determined by various methods differ by hundreds of degrees in some cases, hence SIT is not a true physical constant of a material. Nevertheless, a standardized test that gives consistent and reproducible values is useful to compare relative ignition temperatures of various substances. Determinations on liquids are most conveniently made by an oil-drop and crucible method. This method was originated by Moore,³ who used a heated platinum crucible through which air or oxygen is passed and into which is placed a drop of the fuel to be tested. The ASTM later standardized a similar procedure with a pyrex flask. (The ASTM test is designated *autogenous ignition temperature, D 286—30.*)

A later article⁴ lists the SIT values of Table 3. The apparatus used was similar to that of Moore, but a stainless-steel crucible having a volume of 43 cc was employed. "Temperature zones of nonignition" above the minimum or SIT values appeared with a number of hydrocarbons. The complete temperature-ignition boundary curves for two of these (*n*-heptane and cetane) are given in Fig. 1. Substitution of an atmosphere of 50 per cent nitrogen and 50 per cent oxygen in place of air in this apparatus did not appreciably affect the SIT values but completely eliminated the zones of nonignition.

The fuel gas constituents—hydrogen, carbon monoxide, methane, and ethane—all have ignition temperatures above 1000°F (538°C). SIT values of hydrocarbons show a downward trend with increasing molecular weight for members of an homologous series. Chemically

³ *J. Soc. Chem. Ind.*, **36**, 109 (1917).

active oxygenated compounds such as aldehydes and acids have very low SIT values. The SIT of a petroleum fraction can be lowered by slow atmospheric oxidation.

Refining operations (in the manufacture of fuels) remove oxygenated compounds and some of the processes also remove easily oxidized hydrocarbons, thereby raising and stabilizing the SIT.

Oxidation inhibitors (such as are added to gasoline and lubricating oils) tend to raise the SIT of the product. Of gasoline hydrocarbons, the antiknock properties (octane numbers) of the pure compounds fall in about the same order as their SIT values. Ignition temperatures of a number of the paraffins are raised to 850 to 1000°F (454 to 538°C) by the addition of 3 cc of tetraethyl lead per gallon of liquid hydrocarbon.⁴

TABLE 3.—SPONTANEOUS IGNITION TEMPERATURES OF VARIOUS HYDROCARBONS

Compound	Ignition temp		Zones of nonignition	
	°F	°C	°F	°C
Cetane.....	455	235	560-632 685-775	293.3-333.3 362.8-412.8
Decane.....	487	252.8	602-752	316.7-400
Heptane.....	498	258.9	613-745	322.8-396.1
Decahydronaphthalene.....	520	271.1	615-698	323.9-370
Propylcyclopentane.....	545	285	646-708	341.1-375.6
Methylcyclohexane.....	740	393.3		
Pentane.....	785	418.3		
2,3-Dimethylhexane.....	820	437.8		
2-Methyl-3-ethylpentane.....	862	461.1		
Methylcyclopentane.....	876	468.9		
Isododecane.....	932	500		
2,2,4-Trimethylpentane.....	985	529.4		
α -Methylnaphthalene.....	1050	565.5		
<i>o</i> -Xylene.....	1097	591.7		
Toluene.....	1165	629.4		
Benzene.....	1205	651.7		
<i>m</i> -Xylene.....	1272	688.9		
<i>p</i> -Xylene.....	1275	690.6		

Ignition Lag. As noted earlier, a fuel does not ignite the instant it reaches its SIT. The ignition lag persists above the SIT but decreases with increasing temperature. Figure 2 shows the effect of temperature upon ignition lags of *n*-heptane and of cetane under specified conditions in the steel apparatus. The high-temperature end of each curve of Fig. 2 is the lower boundary of a temperature zone of nonignition. These

⁴ SORTMAN, BEATTY, and HERON, *Ind. Eng. Chem.*, **33**, 358 (1941).

boundary temperatures are within the range in which "cool flames" and "explosion peninsulas" of aliphatic hydrocarbons occur.* A partial explanation of these three phenomena is that they appear under conditions in which there is a high rate of *initial oxygen attack* with a *negative*

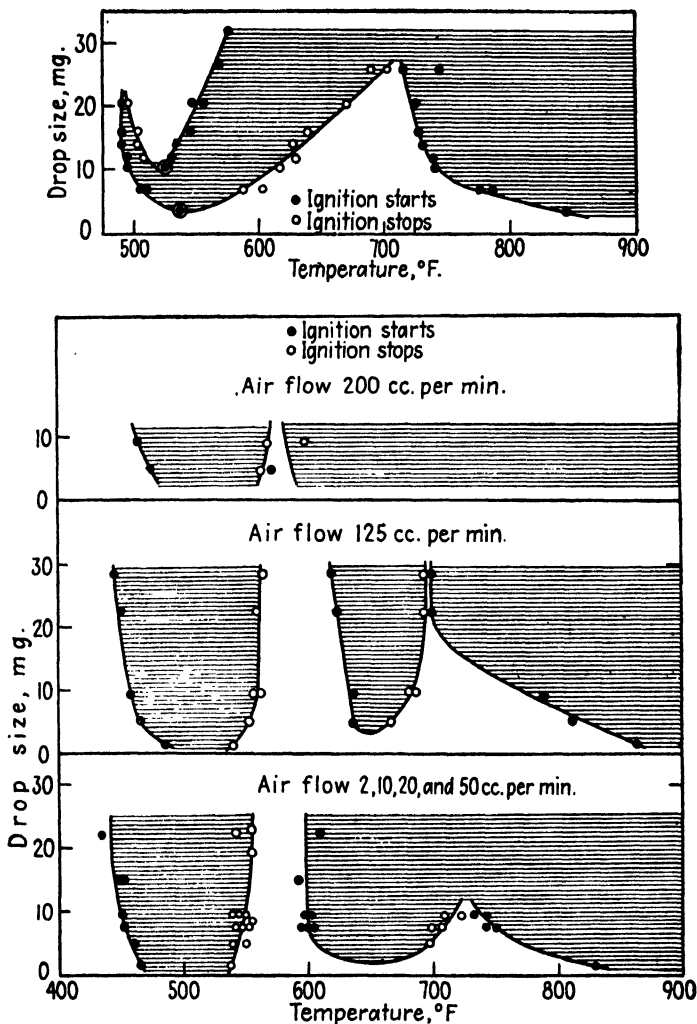

FIG. 1.—Temperature zones of nonignition. Above, *n*-heptane; below, cetane.

temperature coefficient of the rate of secondary oxidation. (It is understood that secondary or deep oxidation is more highly exothermic than is initial oxidation.) It has been suggested that the negative temperature coefficient is caused by suppression of chain branching due to more rapid

* See p. 158 of Supplementary Reference 1.

destruction of aldehydes over a limited temperature range.⁵ ("Cool flames" are the visible radiation emitted during formation of *activated* formaldehyde.)

Temperature and time lag frequently conform to the relation,

$$\log \theta_{\text{lag}} = \frac{a}{T} + b \quad (14)$$

"Ignition lag" limits the speed at which diesel engines can be operated and is therefore an important characteristic of fuels for use in high-speed types of diesels. The ASTM has developed a method of rating the "ignition quality" of diesel fuels (ASTM D 613). The method is based

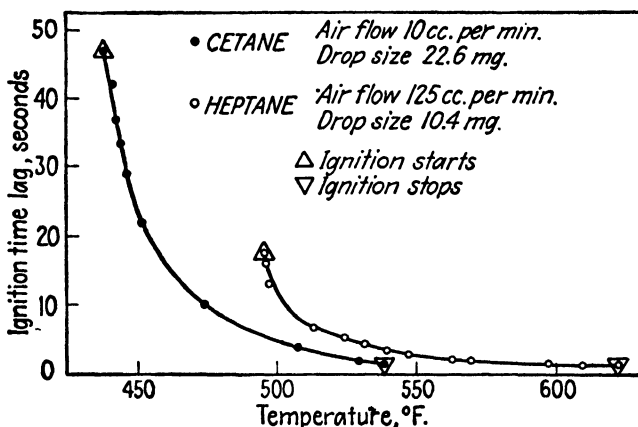

FIG. 2.—Ignition lag vs. temperature.

on matching the ignition lag or delay of a fuel sample against that of blends of cetane (hexadecane) with α -methyl-naphthalene. The test is conducted under a specified procedure with a test engine developed for the purpose. The numerical test result is designated "cetane number," and is the per cent cetane in a mixture with α -methyl-naphthalene whose ignition delay matches that of the fuel. (Cetane has a very short ignition delay whereas α -methyl-naphthalene has a very long one.)

Small percentages of certain compounds such as alkyl nitrates and acetone peroxide are effective in raising the cetane number of diesel fuels by shortening the ignition delay. Diesel "dopes" are sometimes added to the fuels for this purpose. The preignition mixture temperature actually developed in a diesel-engine cylinder may be approximated for a known compression pressure by assuming adiabatic compression:

$$T_2 = T_1 \left(\frac{p_2}{p_1} \right)^{R/MC_{pav}} \quad (15)$$

⁵ PEASE, R. N., "Equilibrium and Kinetics of Gas Reactions," Chap. VIII, Princeton University Press, Princeton, N.J., 1942.

where T_2 = compression temperature

T_1 = initial temperature of mixture

p_2 = maximum preignition compression pressure

p_1 = initial pressure in cylinder at start of compression

R = molar gas constant

MCp_{av} = average molar heat capacity of air-fuel mixture in units consistent with R

Pressures and temperatures must be in absolute scales.

LIMITS OF INFLAMMABILITY

A combustible gas-air mixture is said to be explosive if it will support combustion to the extent that flame is self-propagating through it. Burning is fastest or most violent at mixture compositions that contain somewhat *more* than the theoretical proportion of combustible. As the proportion is either decreased or increased from this composition, the rate of combustion or of flame propagation* always decreases. Both lean and rich *limiting compositions* exist beyond which flame will not propagate. The boundary compositions are designated lower and upper inflammability limits (L_1 and L_2), respectively.

The Mallard-Le Châtelier equation is an interesting relation between temperatures and other factors of the combustion process.⁶ Consider a filament in a gas-air mixture passing through a gas flame. The heat of the combustion raises the temperature of the inflammable mixture as it approaches the flame, from t_1 to its ignition temperature t_i , whereupon the mixture inflames and its temperature rises very rapidly. Secondary combustion occurs and the flame dies out with the burned gases at a much higher temperature (t_2) (Fig. 3). For a filament of unit cross-sectional area, the rate of heat transfer (between

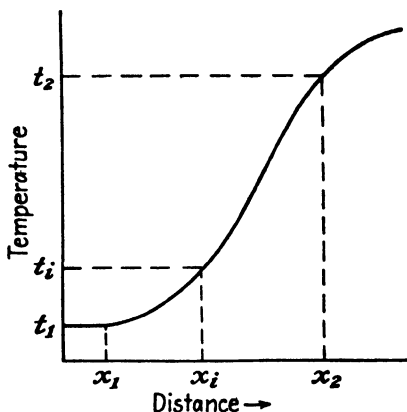

FIG. 3.—Temperature gradient through surface of inner cone of bunsen flame, from inside to outside.

* Throughout this text the designations *rate of flame propagation*, *flame velocity*, *flame speed*, and *burning velocity* (V_f), are all used in identical senses. All refer to the velocity of the flame front relative to that of the unburned combustible-air mixture, under conditions of constant pressure and in which the flame is not confined by walls of a vessel or tube. (Earlier authors have used the first three of these designations in other senses.)

⁶ LEWIS and VON ELBE, *Chem. Rev.*, **21**, 347 (1937) or Chap. XII of Supplementary Reference 2.

flame and oncoming inflammable mixture) required to heat the mixture to ignition temperature is

$$\left(\frac{dQ}{d\theta}\right)_i = (V_f)(\rho_u)(Cp_u)(t_i - t_1) \quad (16)$$

where $(dQ/d\theta)_i$ = rate of heat transfer from flame to inflammable mixture, up to point of ignition

V_f = flame velocity

ρ_u = density of inflammable mixture

Cp_u = average specific heat of inflammable mixture between t_1 and t_i

Assuming all heat to be transferred by conduction through the short distance x_i to x_2 ,

$$\left(\frac{dQ}{d\theta}\right)_i = k \left(\frac{dt}{dx}\right)_{x_i} \quad (17)$$

where k is the thermal conductivity of the inflammable mixture. As a simplifying approximation, the temperature gradient is assumed linear through the flame front or zone of rapid reaction between x_i and x_2 . Then,

$$\frac{dQ}{d\theta} = \left(\frac{k}{x_2 - x_i}\right) (t_2 - t_i) \quad (17a)$$

By eliminating $(dQ/d\theta)$ between Eqs. (16) and (17a) and noting that the thickness of the flame reaction zone (x_f) is $(x_2 - x_i)$, one obtains

$$V_f = \left(\frac{k}{k_f}\right) \left(\frac{1}{\rho_u Cp_u}\right) \left(\frac{t_2 - t_i}{t_i - t_1}\right) \quad (18)$$

Although very difficult to apply quantitatively, several qualitative deductions are evident from Eq. (18).*

1. A change in composition of a gas-air mixture affects the flame temperature t_2 greatly but has only minor effects upon the other variables. Both at lean and at rich compositions, t_2 approaches t_i , whereupon V_f approaches zero. This predicates the existence of lower and upper inflammability limits (IL). Equation (18) also indicates that the composition giving the maximum flame temperature is approximately the same as that giving the maximum flame velocity.

2. The term (k/x_f) is a combustion rate coefficient whose value changes almost directly with flame velocity and almost inversely with thickness

* Lewis and von Elbe have further developed Eq. (18) and tested the result quantitatively against the reaction between oxygen and ozone. Their calculated and experimental values were as close as might be expected in view of the complexity of the problem and the uncertainties of the necessary assumptions and approximations.⁷

of the flame reaction zone x_f . All else being equal, an increase in temperature level increases flame velocity both by increasing k and by decreasing x_f . An increase of pressure increases ρ_w , thereby tending to decrease V_f and to promote a *second explosion limit* (see preceding section). However, chain reactions actually control the burning velocity and the resultant of all mechanisms cannot be generally expressed by any such simple formula as Eq. (18).

As with SIT, limits of inflammability are influenced by experimental apparatus and technique as well as by temperature, pressure, and mixture composition. The mechanism of flame extinction at the lower limit is quite different from that at the upper limit. The lower limit compositions of many substances give substantially the same adiabatic combustion temperature, indicating that the lower limit is thermal in nature. On the other hand, the upper limit seems to be the result of an oxygen-fuel ratio too low to maintain the necessary rapid chain reactions.

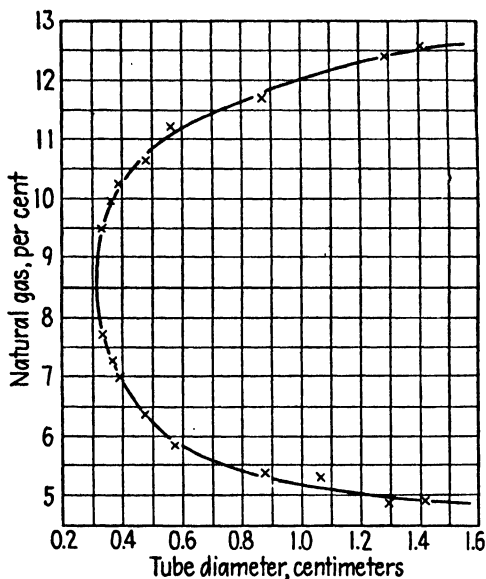

FIG. 4.—Effect of tube diameter on limits of inflammability in natural gas-air mixtures (downward propagation, 1 atm). (Courtesy of Lewis and von Elbe.)

Experimental values for inflammability limits may be obtained with any apparatus in which air and gas can be mixed in known proportion and ignited. However, the values depend to some extent upon the apparatus and technique employed. The two limits are closer together when the flame travels downward than are found in the same apparatus so arranged that the flame travels horizontally. Likewise, the limits are closer for horizontal than for upward flame travel. Limits determined by central ignition in a jar or spherical vessel are often between

the corresponding limits for upward and for downward propagation in a tube, but depend somewhat upon vessel size. The walls of a vessel or tube chill and tend to extinguish the flame. As a result, limits determined in small vessels are closer than those in large vessels or tubes. The effect of tube diameter is illustrated in Fig. 4 for natural gas mixtures.⁷ Approximate minimum tube sizes below which flame will not travel at atmospheric pressure and temperature are shown in the accompanying table.

	<i>Min Diam, Mm</i>
Hydrogen.....	0.9
Coal gas.....	2
Carbon monoxide.....	2.5
Natural gas.....	3
Methane.....	4

As tube diameter is increased, the wall effect fades out. Inflammability limits determined for upward propagation in 2-in.-diameter (5 cm) tubes are within a few tenths of a per cent of those determined in much larger apparatus. To obtain reproducible values at atmospheric pressure that closely approximate dangerous or explosive concentrations of gas in large enclosures such as tanks, ducts, and shafts, Coward and Jones standardized procedures for igniting a gas mixture at the bottom of a vertical tube 2 in. (5 cm) in diameter and 4 to 6 ft high.⁸ With their standard apparatus and procedure, minor differences of room temperature, barometric pressure, and humidity have slight or negligible effects upon experimental values. A list of values for the more common combustible gases and vapors from the compilation by Jones is given in Table 4.

Some approximations relating inflammability limits to other properties of *paraffin hydrocarbons* (including methane) useful to estimate inflammability limits of natural gases follow:

1. For paraffins in the vapor phase, their mixtures, and natural gases:

$$L_1 = \frac{8.0}{n + 0.5} \quad (19)$$

$$L_2 = \frac{63}{n + 3.5} \quad (20)$$

where n is the average number of carbon atoms from the general paraffin formula, C_nH_{2n+2} . (For natural gases containing diluents, n is based on the *total volume of fuel gas*.)

2. At the lower limit composition, the gross heat of combustion of the *total air-gas mixture* is 12 to 13 kg-cal/g mol.

⁷ LEWIS and VON ELBE, *J. Chem. Phys.*, **11**, 75 (1943).

⁸ COWARD and JONES, *U.S. Bur. Mines Bull.* 279.

3. At the lower limit composition, the calculated adiabatic combustion temperature is about 2550°F, based on the gross heating value. (This automatically compensates for the lowered limit of a preheated mixture.)

Items (2) and (3) apply with less accuracy to other combustible gases. There are several other regularities.⁹

TABLE 4.—INFLAMMABILITY LIMITS FOR UPWARD PROPAGATION IN 2-IN. TUBES

	Vol % in air at room temp and 1 atm	
	Lower limit	Upper limit
Hydrogen.....	4.1	74
Hydrogen sulfide ^a	4.3	45.5
Carbon monoxide.....	12.5	74
Methane.....	5.3	14
Acetylene.....	2.5	80
Ethylene.....	3.0	29
Ethane.....	3.2	12.5
Propylene ^a	2.0	11.1
Propane.....	2.4	9.5
Butadiene ^a	2.0	11.5
Butylene ^a	1.7	9.0
Isobutane.....	1.8	8.4
<i>n</i> -Butane.....	1.85	8.4
Isopentane ^a	1.3	
Pentane.....	1.4	7.8
Benzene.....	1.4	6.7
Cyclohexane.....	1.3	8.3
Hexane.....	1.2	6.9
Toluene.....	1.4	6.7
Methylcyclohexane.....	1.2	
<i>o</i> -Xylene ^a	1.0	6.0
Octane.....	0.95	
Gasoline.....	1.4	6.5

^a Values obtained in small or closed apparatus and not strictly comparable with others.

Multicomponent Fuel Gases. Le Châtelier's rule relates the composition of a multicomponent fuel to its component L's and to the L of the fuel in air. Assume that the limit compositions of pure combustible gases in air give a mixture of limit composition.

Choose a basis of 100 mols of fuel.

Let n_a, n_b, n_c, \dots be mols of combustible components A, B, C in the fuel

y'_a, y'_b, y'_c, \dots be mol fractions of pure A, B, C in their limit mixtures with air.

⁹ MASON and WHEELER, *J. Chem. Soc.*, **113**, 45 (1918).

Then,

$$\text{Mols limit mix of A in air} = \left(\frac{n}{y'}\right)_a$$

$$\text{Mols limit mix of B in air} = \left(\frac{n}{y'}\right)_b, \text{ etc.}$$

and

$$\text{Total mols (gas + air)} = \left(\frac{n}{y'}\right)_a + \left(\frac{n}{y'}\right)_b + \left(\frac{n}{y'}\right)_c \cdots$$

The composition of the limit mixture = y'_{mix}

$$= \frac{\text{mols gas}}{\text{total mols mix}} = L = \frac{100}{(n/y')_a + (n/y')_b + (n/y')_c \cdots} \quad (21)$$

Values of y' are given in Table 4, and must be all lower or all upper limits for calculation of L_1 or L_2 , respectively. If the values of y' are taken as *percentages*, L is obtained in *per cent* also. Equation (21) gives fairly reliable results for lower limits, but the calculated upper limits are less dependable.

Effect of Diluent Gases. It is frequently desired to calculate inflammability limits for fuels containing air or inerts, or in atmospheres containing diluents other than air, such as carbon dioxide or excess nitrogen. (Reference 8 treats such cases comprehensively.)

The following approximations apply to inflammable mixtures containing inerts in addition to the nitrogen from air:

1. At the lower limit, the per cent combustible in the mixture is the same as for air.
2. At the upper limit, the ratio of combustible to oxygen is the same as for air.

It follows that

- a. The lower limit for fuels *containing* air or inerts is given by Eq. (21).
- b. The upper limit for fuels *containing* air may be calculated from the upper limit computed for the combustible only, using Eq. (21).
- c. The upper limit for fuels *containing* inerts (no oxygen) is given by the relation,

$$L_2 = \frac{100}{(n/y')_a + (n/y')_b + (n/y')_c + \cdots + n_{\text{inert}}} \quad (22)$$

On the basis of 100 mols of fuel, when values of y' are taken in *per cents* n_{inert} must be divided by 100.

Effects of Temperature and Pressure on Limits. Effects of elevated temperatures and of subatmospheric pressures on the inflammability limits of methane⁹ are shown in Fig. 5. Elevated temperature widens the limits, while reduction of pressure causes the limits to approach each

other and finally join to form an inverted plateau.* Many fuel gases give curves of the same general shapes.† Superatmospheric pressures have diverse effects upon gases differing in chemical nature and molecular

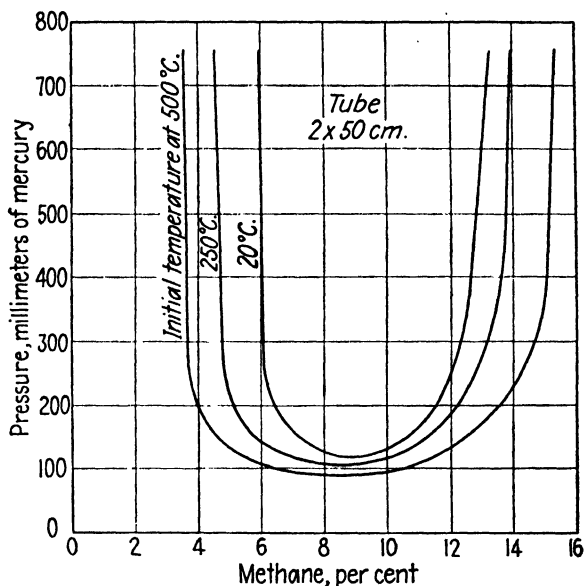

FIG. 5.—Limits of inflammability of methane in air for downward propagation (low pressure range).

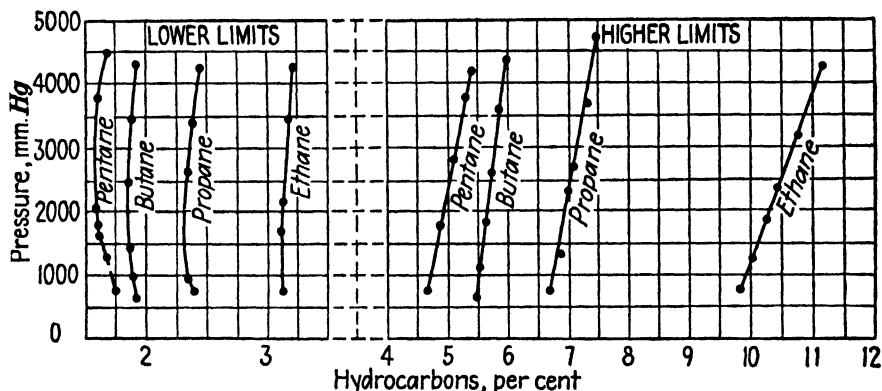

FIG. 6.—Limits of inflammability of some paraffin hydrocarbons for downward propagation (superatmospheric pressures).

structure. The range of inflammable concentrations of the principal fuel-gas constituents is usually widened by pressures up to several atmos-

* The plateau is the *first explosion limit*.

† This statement must be made with reservation. Inflammability limits of higher hydrocarbons at high temperatures have not been thoroughly investigated.

pheres, the upper limit being the most greatly affected.¹⁰ Limits for some paraffin hydrocarbons determined in a 2- by 40-cm tube at pressures between 1 and 6 atm¹¹ are given in Fig. 6. Limits for methane at pressures up to 400 atm¹² are given in Fig. 7. One set of determinations in a small cylinder shows limits pinching toward each other at about 25 atm. The same phenomenon was observed for hydrogen in a

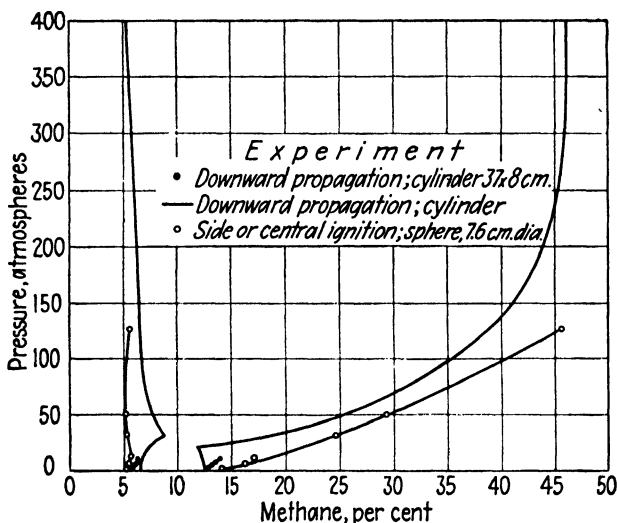

FIG. 7.—Limits of inflammability of methane in air at high pressures.

similar apparatus. Details of the experimental method have a great influence upon inflammability limits at superatmospheric pressures.

THE BUNSEN FLAME

With few exceptions, gas burners employ the bunsen principle of mixing part of the combustion air with the gas before ignition. This gives rapid burning with a short, easily controlled flame.

In the normal operation of small burners, the flame consists of a sharply defined bright-blue inner cone extending to or slightly overlapping the end of the burner tube, and having a surrounding mantle or envelope of lower luminosity. The outer envelope is less sharply defined than the inner cone and is blue at the base but may have a yellow tip. Ignition occurs at the inner surface of the inner cone. Delicate mechanical sampling and chemical analysis of interconal gases show considerable amounts of CO and H₂, and formaldehyde may also be detected. Spectrophotometric observations on the inner cone indicate the presence of

¹⁰ JONES and KENNEDY, *U.S. Bur. Mines Rept. Investigation* 3798 (1945).

¹¹ PAYMAN and WHEELER, *J. Chem. Soc.*, **123**, 426 (1923).

¹² BERL and WERNER, *Z. angew. Chem.*, **40**, 245 (1927).

hydrogen atoms, OH, CH, CC, CHO, and C_2 radicals and also aldehydes. The OH spectra persist into the outer mantle.

Qualitative characteristics of bunsen flames may be observed from the performance of a common laboratory burner. These burners have a jet or orifice at the base of the tube, through which the gas issues at fairly high velocity. The high-velocity gas stream entrains or inspirates "primary" air through the vent holes, in a proportion controlled by adjustment of a perforated ring or other variable restriction at the base of the tube. It may be assumed that the gas is thoroughly mixed with the inspired air as it emerges from the top of the burner tube.

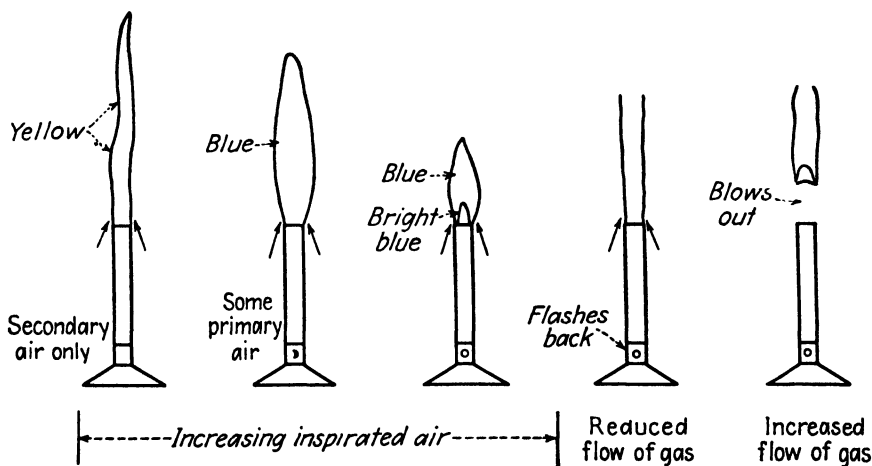

FIG. 8.—Qualitative effects of changes in rates and proportions of air and gas.

Consider a bunsen burner operated on any of the common types of fuel gases. Varying the flow rates of gas and of air affects the flame as shown in Fig. 8. When the air vent is entirely closed, no air is premixed with the gas and the flame is long, yellow (luminous), and sometimes sooty. The luminosity is due to incandescent carbon particles (approximately $4 \text{ by } 10^{-5}$ in. in diameter) resulting from decomposition of hydrocarbons in the gas. Partial opening of the air vent admits a *small proportion of primary air*; the flame turns blue and assumes a definite size. Combustion is obviously more rapid than with no premixed air, and incandescent carbon particles are not formed. *With the air vent opened wider*, a distinct blue cone appears inside the fainter blue envelope. Ignition and rapid combustion start at the surface of the cone, yet combustion is not complete until the surface of the larger envelope has been passed. The entire envelope is smaller than before, indicating faster combustion. A point or particle in the gas stream travels through the active zone of the inner cone in about 0.001 sec. It remains in the outer envelope two orders of magnitude longer (tenths of a second). In

normal burner operation, 40 to 90 per cent of the theoretical quantity of air may be inspired into the tube, or supplied as *primary air*.

Reducing the flow of gas with the air vent wide open causes flashback, with flame appearing at the orifice and a second pale flame observable at the end of the tube. The increased volume of gases in the tube chokes off or reduces air inspiration. Increasing the flow of gas above normal causes the flame to lift or leave the end of the burner tube; it is "blown away" and extinguishes.

Conclusions from Qualitative Burner Observations. 1. For rapid and complete combustion, part of the air must be premixed with the gas before ignition.

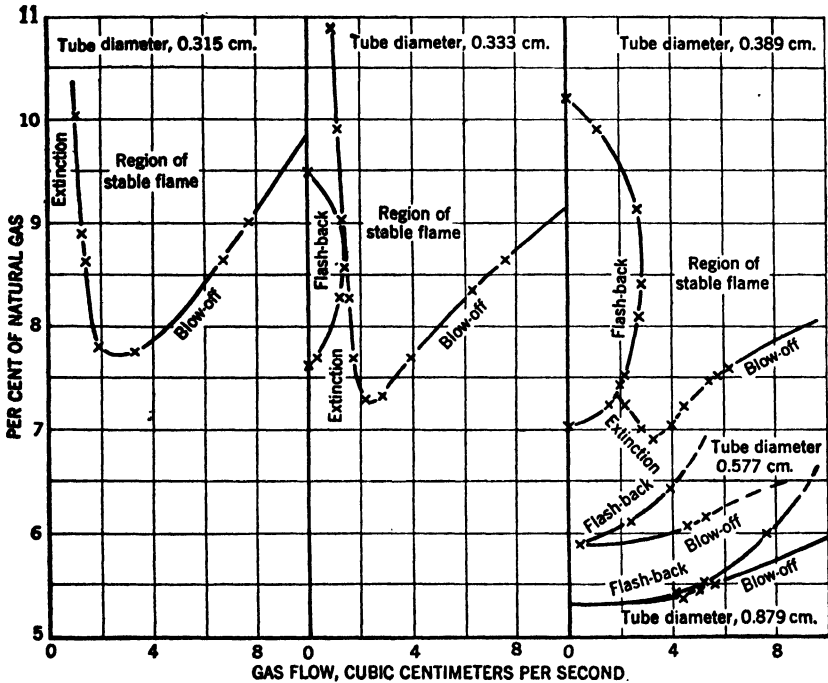

FIG. 9.—Regions of stable natural gas-air flames for tubes of various sizes. (Courtesy of Lewis and von Elbe.)

2. The *speed* of combustion is related inversely to the size of the flame and depends upon the fraction of premixed air.

3. The flame has a definite speed of propagation for a definite gas-air mixture composition. If the flow of mixture through the tube is too high, the flame is blown away from the end of the tube.

4. The wall of the burner tube slows down flame propagation, so that for normal conditions the flame burns at the end of the tube but does not penetrate it.

Quantitative stability characteristics of bunsen flames for small tubes and at low flow rates⁷ are shown in Fig. 9. The fuel is a natural gas of typical composition whose mixture with theoretical air contains approximately 8.5 per cent gas. Areas of "stable flame" as in normal burner operation exist between rather wide limits of gas and primary air rates but, over the greatest part of these areas, the mixtures contain less than stoichiometric combustion air. In other words, flames are stable over widest ranges of flow rates with less than 100 per cent primary air. Data on the larger tubes show extensive zones in which flashback occurs; these zones become smaller and finally disappear with decreases in tube size. Areas of flashback are bounded by areas of stable flame and of blowoff for tubes larger than 0.5 cm in diameter, but are bounded only by areas of stable flame and of flame extinction for the smaller tubes.⁸

The location and shape of stable flame boundaries also depend upon the nature of the fuel, according to its velocity of flame propagation. Natural gases consist chiefly of methane and burn more slowly than coal gas or manufactured (carbureted water) gas, whose relative burning velocities increase in the order given.

RATE OF FLAME PROPAGATION

The velocity of flame propagation or the speed at which flame travels through a gas-air mixture* is related to the capacity or input range over which gas burners function satisfactorily. Many determinations of the "speed of uniform movement" of flames have been made using apparatus in which the flame *traveled* through a long open tube. However, a flame travels through a tube much more rapidly than it propagates through the same inflammable mixture when unconfined. Although true burning velocities may be calculated from open-tube or closed-bomb experiments, values most nearly independent of the experimental apparatus are obtained by some method in which the flame neither develops appreciable pressure nor travels any considerable distance. The current method of determining "burning velocity" that is least affected by details of experimental apparatus is the central ignition of a gas-air mixture contained in a soap bubble.¹³

Another simple and convenient determination of flame propagation velocity is by the "stationary flame method," whose conditions are those of actual burner operation. The essential apparatus is a burner tube of known size into which gas and air are separately metered. The angle formed by the surface of the inner flame cone is carefully observed at mixture velocities sufficiently low so that laminar or streamline flow prevails in the tube, and the flame is steady. The speed of flame propaga-

* Note definitions at beginning of section, Limits of Inflammability.

¹³ See Art. I of Supplementary Reference 1.

tion is calculated from the angle (α) between a tangent to the surface of the inner flame cone and the vertical or tube axis. The linear velocity of the air-gas mixture in the tube varies over the cross section, increasing from zero at the tube wall to a maximum at the axis. At a point 0.7 of the radius from the axis, the linear velocity is the same as the average for the whole tube. *The flame propagates in a direction normal to the surface of the inner cone.* On the vector triangle constructed according to Fig. 10, the hypotenuse is the component of linear velocity of the gas mixture and the base is the component of flame speed or velocity of flame propagation:

Let q = gas-air flow, cu ft/sec

S = cross-sectional area of tube, sq ft

V_{av} = average gas-air velocity, ft/sec = q/S

Then

$$V_f = \text{flame speed} = V_{av} \sin \alpha \quad (23)$$

Flame velocities so obtained are nearly constant over most of the tube radius but are lower near the wall and rise to a peak value at the tube axis.⁷ The velocity gradient observed near the tube wall is caused by friction and the cooling effect of the wall, and by diffusion of secondary or outside air into the flame. The high velocity at and near the axis results from heat transferred by the surrounding flame together with a slight back pressure caused by expansion of the burning gases. Flame velocities determined by stationary flame and by soap-bubble methods are in fundamental agreement.

FIG. 10.—Calculation of flame or ignition velocity (stationary-flame method).

$$V_f = V_{av} \sin \alpha$$

Smith and Pickering¹⁴ determined flame velocities by the stationary-flame method for several of the principal fuel-gas compounds. One of their plots is given as Fig. 11. Several sizes of burner tubes were used. The flame velocities depend somewhat on tube diameter, the wall effect increasing as tube diameter decreases. Maximum flame velocities occurred with mixture compositions containing less than theoretical air, as would be predicted from Eq. (18).

Maximum flame velocities with their compositions for the principal fuel-gas compounds (from Fig. 11) determined in small burner tubes are given in Table 5. The compositions for ethane, butane, and pentane (not determined by Smith and Pickering) were estimated from Payman's data as reproduced by Coward and Greenwald.¹⁵

¹⁴ SMITH and PICKERING, *Nat. Bur. Standards Research Paper 900* (1936).

¹⁵ U.S. *Bur. Mines Tech. Paper 427* (1928).

Multicomponent Fuels. The flame speed-composition diagrams of Fig. 11 may be used to calculate speed-composition diagrams for a multicomponent gas of known composition.¹⁵

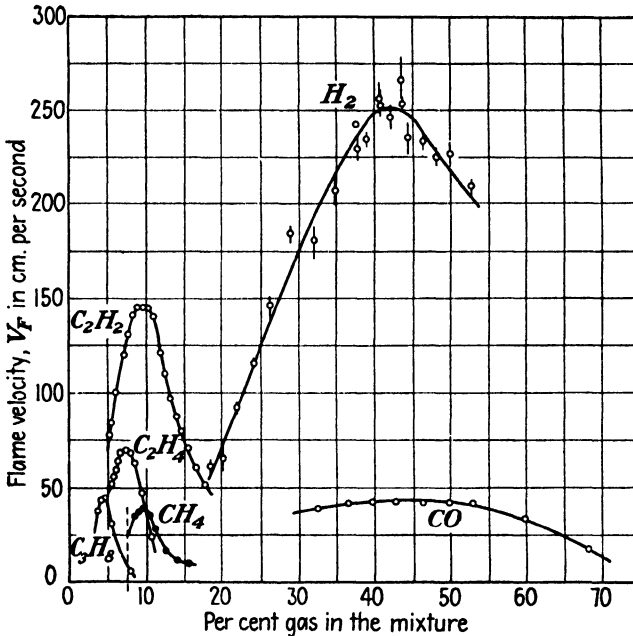

FIG. 11.—Burning velocities of some fuel gas constituents by stationary-flame method (burner tubes 2.75 to 9.6 mm diameter). H_2 , CO , and C_2H_2 at $30^\circ C$ mixture temperature; CH_4 , C_2H_4 , and C_3H_8 at $50^\circ C$ mixture temperature. (Courtesy of Smith and Pickering.)

When pure gases are separately mixed with air in such proportions that each has the same flame speed, a blend of the mixtures frequently

TABLE 5.—COMPOSITION AND RATE OF FLAME PROPAGATION FOR MAXIMUM-SPEED MIXTURES (Small burner tubes)

	% gas	% theoretical air	V_f cm per sec
Hydrogen.....	42	58	225
Carbon monoxide.....	45	50	43
Methane.....	9.8	95	37
Acetylene.....	9.5	80	145
Ethylene.....	7.2	90	70
Ethane.....	6.4	87	
Propane.....	4.7	85	45
Butane.....	3.65	85	
Pentane.....	2.9	88	35 ^a

^a Jost, W., "Explosions- und Verbrennungsvorgänge in Gasen," p. 71, Verlag Julius Springer, Berlin, 1939.

has approximately the same flame speed as the components. This observation is used to estimate the per cent of a multicomponent gas in air that will have a designated flame speed. The relation is of the same form as Eqs. (21) and (22):

$$Y = \frac{100}{(n/y')_a + (n/y')_b + (n/y')_c + \dots} \quad (24)$$

In Eq. (24), Y is the mol fraction (or percentage) of the fuel gas in air and y' the mol fraction (or percentage), respectively, of each component gas in air that has the same speed as each of the others. Since for each gas there is an upper and a lower composition having the same flame speed, there are likewise upper and lower compositions of the multicomponent gas giving the same speed. The observation on which Eq. (24) is based does not apply to flame speeds higher than the maximum of the slowest burning component. Thus, it may not be applied to mixtures containing methane for speeds above 37 cm/sec. It may, however, be used to approximate the maximum-speed composition, on the different assumption that the maximum-speed mixture is a blend of the maximum-speed mixtures of the components. This composition is obtained by using *maximum-speed* instead of *equi-speed* values of n and y' in Eq. (24). The flame speed of such a mixture can be estimated by a third assumption that it is a molar average of the maximum-speed mixtures of its components. Thus,

$$V_{\max} = \frac{(Vn/y')_a + (Vn/y')_b + (Vn/y')_c + \dots}{(n/y')_a + (n/y')_b + (n/y')_c + \dots} n_{\text{inert}} \quad (25)$$

In Eq. (25), V , n , and y' are the corresponding maximum flame velocity, mols, and maximum-speed composition, respectively, of each combustible component in the fuel. Equations (24) and (25), although serving as useful approximations for fuel gases, have no theoretical foundations and for some mixtures give results greatly in error.¹

Effects of Initial Temperature. Flame velocity data on the various compounds listed in Table 5 and Fig. 11 were determined at room temperature or at 30 or 50°C. Although variation of a few degrees has little effect on these values, temperature variations of greater magnitude do have appreciable influence.

One of the most important effects of preheat on a combustible mixture (or on its combustion air) is that the preheated mixture attains its flame temperature more quickly. Preheat thereby increases flame speed and, for many gases, the increase is approximately proportional to the square of the absolute temperature.¹⁶ Accordingly,

$$V_f = aT^2 \quad (26)$$

¹⁶ "Combustion," p. 94, *Am. Gas Assoc.*, 1938.

The constant a in Eq. (26) may be evaluated from flame speed at any known temperature. Flame speed at burner temperature is a factor of gas-burner design (see Chap. IX).

Illustrations

1. For a domestic "bottle gas" whose composition is equivalent to 40 mol per cent propane and 60 mol per cent n -butane, calculate the lower inflammability limit by the following correlations:

- a. The paraffin gas formula, Eq. (19).
- b. By taking 12.5 kg-cal/g mol as the gross heat of combustion of the mixture.
- c. By assuming an adiabatic combustion temperature of 2550°F for the mixture (initial temp = 60°F).
- d. By Le Châtelier's rule.

2. Estimate the flame speed for the same bottle gas when premixed with 70 per cent of the theoretical air, as in a burner tube.

Solutions (Refer to Chap. V for data): 1a. The average number of carbon atoms is

$$n = (0.4)(3) + (0.6)(4) = 3.6$$

According to Eq. (19), the lower limit is

$$L_1 = \frac{8.0}{3.6 + 0.5} = 1.95 \text{ per cent gas in air}$$

1b. The heat of combustion of 1 mol of the fuel is

$$(0.4)(530.6) + (0.6)(688.0) = 625 \text{ kg-cal}$$

and 1 mol of the lower limit mix to generate 12.5 kg-cal contains

$$\frac{(100)(12.5)}{625} = 2.0 \text{ per cent gas}$$

1c. One mol of the fuel contains 3.6 mols of carbon, 4.6 mols of hydrogen, and requires 5.9 mols of oxygen for theoretical combustion. The burned gas contains

	Mols	MCp_{av} 60 → 2550	(MCp) (mols)
CO ₂	3.6	12.5	45
H ₂ O.....	4.6	9.7	44.6
N ₂	22.2	7.7	171
Excess air.....	x	7.8	7.8x
			260.6 + 7.8x

For an adiabatic combustion temperature of 2550°F,

$$Q = (MCp) \left(\frac{2550 - 60}{1.8} \right) = (260.6 + 7.8x)(1383) = 625,000 \text{ cal}$$

Solving, $x = 24.4$ mols excess air.

$$\text{Lower limit} = \frac{100(\text{gas})}{\text{gas} + \text{air}} = \frac{(100)(1)}{1 + 5.9(100/20.9) + 24.4} = 1.87 \text{ per cent gas}$$

1d. Experimental values of L_1 from Table 4 are 2.4 per cent for propane and 1.85 per cent for *n*-butane. By Le Châtelier's rule,

$$L_1 = \frac{100}{40/2.4 + 60/1.85} = 2.04 \text{ per cent gas}$$

2. The flame velocity curve for butane is not available. However, from similarities in shape and position of flame speed curves for paraffins above methane, the butane curve can be satisfactorily superimposed upon the propane curve by adjustment of the gas composition scale. (This is equivalent to assuming the same flame speeds and per cents of excess air at inflammability limits and at the maximum speed composition.) Accordingly, the speed of the mixture will be the same as that of propane alone with 70 per cent of theoretical air.

A mol of propane requires 5 mols of oxygen for complete combustion, and a mixture having 70 per cent of theoretical air contains

$$\frac{100}{1 + (0.7)(5)(100/20.9)} = 5.63 \text{ per cent propane}$$

From Fig. 11, the flame velocity is approximately 30 cm/sec.

EFFECTS OF LOCAL CONDITIONS ON COMBUSTION

Temperature or Preheat. Under usual conditions, increases in temperature accelerate both the speed of ignition and the rate at which combustion is completed. High-temperature furnaces can operate at much higher rates of heat input than low-temperature furnaces of the same size. The effect of preheat is to raise the adiabatic combustion temperature. Preheat also raises actual furnace temperatures where other operating conditions are left undisturbed.

Hot Surfaces. A hot refractory surface receives heat from flame and transmits it to colder portions of a burning mixture, increasing the rates both of ignition and of combustion. Refractory-tile burner ports always improve burner performance, and the role of the hot refractory lining in promoting combustion is essential to the operation of high-temperature furnaces (Chaps. IX, XIV). The influence of the hot refractory is so pronounced that its effect has been designated *surface combustion*. Silica, fireclay, and probably other refractories definitely catalyze combustion chain reactions at low temperatures (about 400 to 700°C). However, heat transfer-temperature effects coupled with local turbulence caused by surface roughness or a bed of broken refractory are of major if not of controlling importance in "surface combustion" phenomena at high furnace temperatures.

High Pressures. It is difficult to isolate pressure effects from thermal effects. As noted earlier, a selected mixture may have one or two pres-

sure zones of noninflammability, but in general the effect of elevated pressure is to accelerate ignition. Pressure may also accelerate later stages of combustion, although rates of ignition and of complete combustion are fundamentally independent of each other.

Internal-combustion Engines. The entire course of combustion in the chamber of an internal-combustion engine is a phenomenon of major practical importance and has been intensively studied in recent years. Only a few generalities can be noted here. Piston engines are of two general types: spark-ignition and diesel. In both types, combustion gases at high pressures expand against a moving piston. The piston later compresses a fresh charge before it is ignited. The higher the compression or preignition pressure of the mixture, the more efficient is the conversion of heat into mechanical energy, all else being equal. Compression pressures up to about 8 atm are obtained in some spark-ignition engines, while diesel engines may utilize compression pressures of about 14 atm . The peak *combustion pressure* is roughly four times the *actual compression pressure*. In high-speed engines, combustion must be very rapid to develop full pressure soon after the piston starts moving downward. Rapid, efficient combustion depends upon properties of the fuel (such as volatility and octane number of gasolines, ignition delay of diesel fuels), and upon factors of engine design and operation (notably compression ratio and air-fuel ratio). The walls of the combustion chamber conduct heat away from the compressed mixture, and an engine will not run efficiently when the preignition mixture temperature is too low. This condition occurs when the engine is started cold.

In the common type of diesel engine, the piston compresses the air only. The fuel is sprayed into the cylinder under high pressure when the piston is near the top, and it spontaneously ignites. Obviously the temperature-time lag relation of a diesel fuel is of prime importance.

In spark-ignition engines, the fuel is sprayed into the air before it enters the combustion chamber. It is highly desirable that the fuel be completely vaporized (no mist) before ignition. Since the mixture is in contact with the walls of the combustion chamber, oxidation starts before ignition and carbonaceous or other deposits on the walls may catalyze and noticeably influence the early course of the combustion. "Knocking" is caused by high-velocity pressure waves traveling back and forth across the combustion chamber (at 3,000 to 6,000 cycles/sec) that are similar to detonation waves. Knocking is frequently called *detonation*. It occurs and becomes increasingly intense with increasing compression pressure. The antiknock property of a fuel was formerly expressed as its "highest usable compression ratio" (*HUCR*) as determined on a test engine similar to the later CFR engine (see Chap. II, Part 5). Engine knock is actually the resultant of a number of complex factors. As

already noted, antiknock properties of pure hydrocarbons and their mixtures increase with increasing spontaneous ignition temperature.

Combustion under pressure is also employed to generate power in the *gas turbine*, in the *jet-propulsion engine*, and in certain types of steam generators.

BURNING OF LIQUID AND SOLID FUELS

Fuel Oils. Without exception, oil burners either vaporize or atomize the fuel before ignition. Droplets of atomized oil are completely or largely vaporized by heat of the flame before and during combustion. The mechanism of combustion of oil vapor is substantially the same as for gaseous hydrocarbons of lower molecular weight, and well-designed oil burners operating on distillate fuels can produce nearly as short flames as burners handling hydrocarbon gases at the same input rates (Chap. X). Droplets of heavy oils may be partly *carbonized* in the flame, as evidenced by showers of sparks.

Autogenous ignition temperatures of fuel oils have little if any relation to their performance in oil burners.

Coal on Grates. Coal and coke are burned in beds through which air is passed. Mechanism and stages of combustion change from top to bottom of the bed. A lump of coal as fired in a furnace is subjected to heat, and the same general kind and sequence of transformations occur as in high-temperature carbonization. The coal gas burns mainly in the flame above the bed, while the coke remains in place until it is burned to ash.

Complete combustion of the coke is accomplished by air passing through the bed ("combustion air") whereas complete combustion of the gases depends upon air admitted above the bed ("overfire air"). Adequate quantities and proper proportions of combustion air and of overfire air are necessary for efficient operation of a furnace grate.

In the case of coke and low-volatile coals, firing rates at which combustion becomes incomplete are determined by properties of the burning coke, chiefly its lump size, ash content, and physical characteristics. In the main, these are characteristics of the particular fuel although affected somewhat by furnace conditions.

Complete combustion of high-volatile coals may depend upon the rate at which sufficient overfire air mixes with the coal gas. Thorough mixing of the overfire air and coal gas over a fixed fuel bed occurs much more slowly than in the flame of a gas or an oil burner. The time required for adequate mixing also increases with the size of the bed or grate. This consideration indicates the existence of an upper limit to the size of grate on which coal can be burned efficiently and economically. The mechanical difficulty of complete mixing is greatly reduced in the firing

of pulverized coal, and the largest coal-burning units (such as central station boilers) are always thus fired.

Pulverized Coal. Pulverized-coal particles burn while suspended in the furnace atmosphere. The firing system employs a current of air to transport the fuel particles through a pipe from the grinder to the burner, thus handling it as a fluid. The same general combustion stages occur for pulverized-coal particles as prevail in the combustion of coal on grates. However, the combustion of a small particle takes place much more rapidly. The stages are

1. Heating and ignition.
2. Distillation of volatile matter and its combustion.
3. Combustion of the residual coke.

Hottel and Stewart¹⁷ made a comprehensive study of the problem, and the material following is abstracted from their article.

Pulverized fuel from commercial grinding equipment includes a wide range of particle sizes, whose size distribution depends mainly upon the particular grinder. The size distribution is satisfactorily represented by the Rosin-Rammler equation. The larger sizes of particles require longer times for complete combustion and determine the combustion space required.

During the heating or preignition period, the moisture and some gases are driven off. Ignition temperatures increase with the rank of fuel from 200 to 300°C for lignites to 450 to 600°C for anthracites. Minimum heat absorption to the temperature of ignition corresponds roughly with ease of ignition and is least for bituminous and dried lignite fuels. Preignition *time* depends upon both fuel and furnace conditions but is of short duration.

The distillation-flaming combustion period is likewise of short duration, the time being of the order of 5 milliseconds. During this period the particles swell; durain particles increase to about double their original volume while vitrain particles swell even more, up to eight times their original volume. Swelling increases the particle surface and diminishes the time necessary for complete combustion.

The period for combustion of the coked particles is much longer than the other periods, and controls the firing rate at which appreciable unburned combustible is lost in flue and ashpit. The principal variables of this latter period are particle size, type of fuel, furnace temperature, and excess air. The first three are related to the *fraction of fixed carbon unburned* (FFCU) at any given moment (θ) following discharge from the burner mouth by the factor,

$$\text{FFCU} = \frac{2A(1+m)\theta}{x_w \rho \alpha^{1+m}} \quad (27)$$

¹⁷ *Ind. Eng. Chem.*, **32**, 719 (1940) and references.

where A = a factor dependent upon type of fuel and furnace temperature

m = a constant of combustion velocity, often zero

α = particle swelling ratio before and after coking (diameters)

ρ = density of coke

x_w = weighted mean particle size of coal

Per cent of excess air is a major factor in the time required for the last stage of combustion. There is also a probable factor of diffusional resistance offered by ash, especially the "inherent" or colloiddally dispersed ash that is present to some extent in all coals.

In commercial furnaces, combustion of pulverized coal is 50 per cent complete in about 0.05 sec after the particles leave the burner port. The time at which 5 per cent of the fixed carbon remains unburned may range from 0.1 to 0.3 sec. Further reduction of unburned fixed carbon proceeds very slowly.

Supplementary References

On mechanism:

1. FLOCK, E. F.: Art. I in "The Chemical Background for Engine Research," Interscience Publishers, Inc., New York, 1943.
2. LEWIS and VON ELBE: "Combustion Flames and Explosions of Gases," Cambridge University Press, London, 1938.

On engineering properties:

3. PERRY, J. H.: "Chemical Engineers' Handbook," 2d ed., pp. 2397-2405, McGraw-Hill Book Company, Inc., New York, 1941.

Exercises

1. Summarize, using generalized equations, the principal reactions in the combustion of paraffin hydrocarbons. Note the principal types of intermediate compounds. What are the principal chain carriers?

2. What is the general range of spontaneous ignition temperatures of gaseous fuels? of liquid hydrocarbons? Which has the higher SIT, a fuel oil or a pure hydrocarbon of the same molecular weight? Why?

3. a. What is the limit of inflammability? How is it usually determined?

b. Explain how to construct the flame speed-composition curve for a combustible gas when its analysis and the speed-composition relations for its components are known.

4. For a natural gas consisting essentially of 90 per cent methane and 10 per cent ethane, calculate inflammability limits by the following procedures:

a. The limits by the formulas for paraffin gases.

b. The lower limit by assuming the heat of combustion to be 12.5 kg-cal/g mol of limit mix.

5. Calculate the lower inflammability limit of the gas of Exercise 4 according to the assumed conditions, using gross heat of combustion:

a. The temperature of the completely burned mixture is 2550°F and the mixture is at 60°F initially.

b. The same combustion temperature as in (a) but with the mixture preheated to 800°F. (Neglect change in heat of combustion with temperature.)

6. What are the inflammability limits of a coke-oven gas consisting of 50 per cent H_2 , 25 per cent CH_4 , 10 per cent CO , 3.5 per cent C_2H_4 , and 11.5 per cent inerts, calculated by Eqs. (21) and (22)?
7. *a.* What is the per cent of gas and maximum flame speed of the coke-oven gas of Exercise 6 in air?
- b.* What is the flame speed of the mixture of (*a*) preheated to $600^\circ F$? (Assume that all values for pure components of Table 5 are at $86^\circ F$.)
8. What would be the minimum compression ratio (p_2/p_1) at which a diesel engine could possibly operate on a fuel of formula $C_{12}H_{22}$, having an ignition temperature of $700^\circ F$? For the purpose of this exercise, assume that the engine is to operate on an air-fuel ratio for theoretical combustion; that the fuel is completely vaporized and at a temperature of $150^\circ F$ when compression begins, that the specific heat of the oil vapor is 0.5, and that the compression is adiabatic.

CHAPTER VIII

MANUFACTURED GAS

Manufactured gases are made from solid and liquid fuels by processes involving chemical reaction and/or thermal decomposition.*

Producer gas (essentially CO, H₂, and N₂) is an industrial fuel made by passing air and steam continuously through the hot fuel bed of a gas producer. Producer fuels are coal, coke, and mixtures of the two, although refuse fuels are sometimes burned. The gas has a relatively low flame temperature as well as a low heating value (130 to 180 Btu/cu ft) owing to its high nitrogen content (50 to 56 per cent). To obtain high furnace temperatures and adequate heat efficiency, the furnace or process must be equipped with a heat-recovery system; commonly a regenerator or recuperator for high-temperature processes or a waste-heat boiler for lower-temperature processes. Gas producers were developed chiefly for firing open-hearth steel furnaces. Other applications include coke ovens, glass and ceramic furnaces. A few lime kilns are fired with producer gas and, in some localities, producer gas is blended with high-Btu gases in city supplies.

Water gas or *blue gas* (essentially CO and H₂) is made by passing steam through the hot fuel bed of a water-gas set. A water-gas set operates on short time cycles; the gas "make" portion of the cycle (using steam) is alternated with a "blast" run (using air) in order to maintain the high temperature of the fuel bed and other parts of the set. The water gas is collected only during the make portion of the cycle and by this means the unwanted nitrogen from air is separated from the gas. The solid fuels used in water-gas sets are coke, coals, and their mixtures. Blue gas has a heating value of about 300 Btu/cu ft but, since it contains only small percentages of inerts, it has a high adiabatic combustion temperature. It is suitable for welding, and increasing amounts are used for chemical synthesis. However, most of the water-gas production is either *carbureted* or blended with high-Btu gases for city supplies.

The fuel bed of a gas producer or of a water-gas generator is maintained at high temperature. Any coal that may be used as fuel undergoes carbonization. Hence the lower part of the bed consists of coke whether the fuel be coal, coke, or a mixture. Oxygen and steam introduced below the grate react with the incandescent coke to form CO and H₂.

* Coal gas and refinery gas are covered by the definition. See Chaps. I and II, respectively.

When passed through a hot bed of coke, the oxygen in air can be almost quantitatively converted to carbon monoxide under favorable conditions. Under similar conditions, steam is largely converted to carbon monoxide and hydrogen. The simplest *overall* reactions are



Although these equations may not represent the actual mechanisms of the reactions, they may be used for stoichiometric calculations.

The maximum temperature in a gas generator occurs near the bottom of the fuel bed, and the reaction of coke with oxygen from air at that point is ordinary combustion, the carbon burning directly to CO_2 .

Carbon Monoxide from Air. Sampling and analysis of the gas in a burning fuel bed at various distances above the grate gave the data¹ from which Fig. 1 was constructed. Near the bottom of the bed, decrease

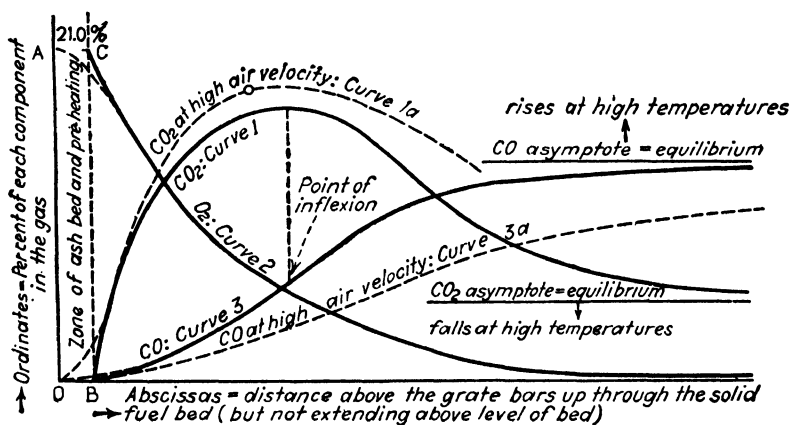

FIG. 1.—Consumption of oxygen vs. appearance of CO_2 and CO in furnace fuel beds. (Courtesy of W. H. McAdams.)

in oxygen is accompanied by equivalent increase in CO_2 . Appreciable carbon monoxide is formed only after a considerable percentage of CO_2 has appeared. Increase in air velocity raises the temperature, accelerates combustion to CO_2 , but decreases the percentage of CO at any given point. The conclusions are that CO_2 is a *primary* product of a reaction that is *first-order* with respect to oxygen concentration. Carbon monoxide is formed chiefly by reduction of CO_2 , the *net* reaction being,



The *equilibrium constant* of Eq. (3) increases rapidly with temperature, and the *rate* of the reaction is controlled by chemical resistance rather

¹ OvitZ and Augustine, *U.S. Bur. Mines Tech. Paper* 137.

than by diffusion of CO_2 at the temperatures prevailing in gas producers and water-gas generators. (See Combustion of Elementary Carbon, page 190.)

Water Gas from Steam. In a series of laboratory experiments,² steam was passed through a bed of granular carbon,* while the bed temperature, steam pressure, and steam rate were all controlled. Tem-

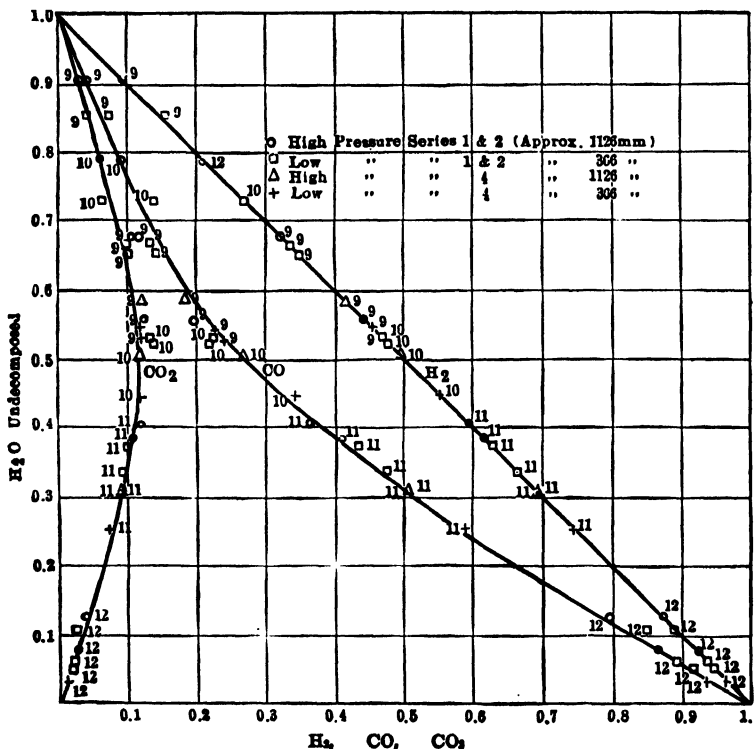

FIG. 2.—Composition of water gas vs. residual steam. (Courtesy of R. T. Haslam.)

$$\begin{aligned} \text{Ordinate: } & \frac{\text{(H}_2\text{O)}}{\text{(H}_2\text{O} + \text{H}_2)} \\ \text{Abscissa: } & \frac{\text{(component)}}{\text{(H}_2\text{O} + \text{H}_2)} \end{aligned}$$

peratures and times of contact were essentially equivalent to those prevailing in commercial equipment. Analyses of the gas and a plot of the data for temperatures from 900 to 1200°C gave the correlation shown in Fig. 2. Both coordinates are expressed as *fractions of total original steam*; that is, the denominators are $\text{H}_2\text{O} + \text{H}_2$. The ordinate is *fraction of water undecomposed* and the abscissa is *fraction of each gas to total entering*

² HASLAM, HITCHCOCK, and RUDOW, *Ind. Eng. Chem.*, **15**, 115 (1923).

* The experimental "bed" was a tube packed with carbon.

steam. These coordinates eliminate the variables of temperature, pressure, and time of contact *per se* and show only the extent to which the reactions have taken place.

The origin is the upper left-hand corner of the plot and, since all curves intersect this origin at definite slopes, H₂, CO, and CO₂ all must be *primary reaction products of steam and carbon*. Since all data at various pressures, gas velocities, and temperatures (between 900 and 1200°C) fell on the same curves, *all reactions must be of the same kinetic order and first-order with respect to water*.*

The overall rate of steam decomposition is most easily represented in terms of the reactions,

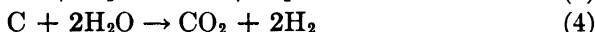

occurring simultaneously. If the formation of CO₂, CO, and H₂ are all kinetically first-order, reaction (4) cannot represent a true mechanism. However, the above postulation enables steam decomposition in commercial units—*i.e.*, gas producers—to be correlated with the gas analysis without further knowledge of *the true reaction mechanisms* (see Gas Producer Calculations later in this chapter).

GAS PRODUCERS

The body of a gas producer is a circular steel shell lined with firebrick. In some models, the active zone of the shell is unlined and cooled by a water jacket. The fuel bed is supported by an *ashpan* that is kept filled with water. The water supplied to the pan seals off the gas and serves to quench the ash. Air containing steam is supplied by the *blast pipe* through the center of the ashpan. The pipe terminates in a *blast hood* or *distributor*, of which there are several designs. For models in which the shell rotates, the top is stationary and a second water seal is provided between top and shell. On this type, the gas offtake, fuel feed mechanism, and a rake or poker are all mounted in the top.

The fuel is fed manually or mechanically through a trap closed at the bottom by a bell or other gas seal. For charging, the bell is lowered and the fuel drops onto the bed. Producers that do not have mechanical rakes or pokers may have a multibell charging arrangement so that the fuel spreads over the bed as it is charged. The rake or poker levels off high spots on the bed, filling in low places and closing blowholes in the fire. The *Wellman* producer shown in Fig. 3 employs mechanical feed and a mechanical, water-cooled poker. The poker oscillates and with

* For a given apparatus, time of contact is equivalent to contact surface area per unit gas. Both are directly proportional to pressure and inversely proportional to steam rate.

the rotation of the shell, it periodically traverses the surface of the entire bed. The poker breaks up caked masses and maintains an even fire. Ash is removed by the action of the adjustable plow. In this installation, the gas duct is equipped with a two-chamber dust catcher (Fig. 4).

The United Gas Improvement Company (UGI) *rim feed producer* has a stationary shell, a revolving ring in the top, and a revolving grate.

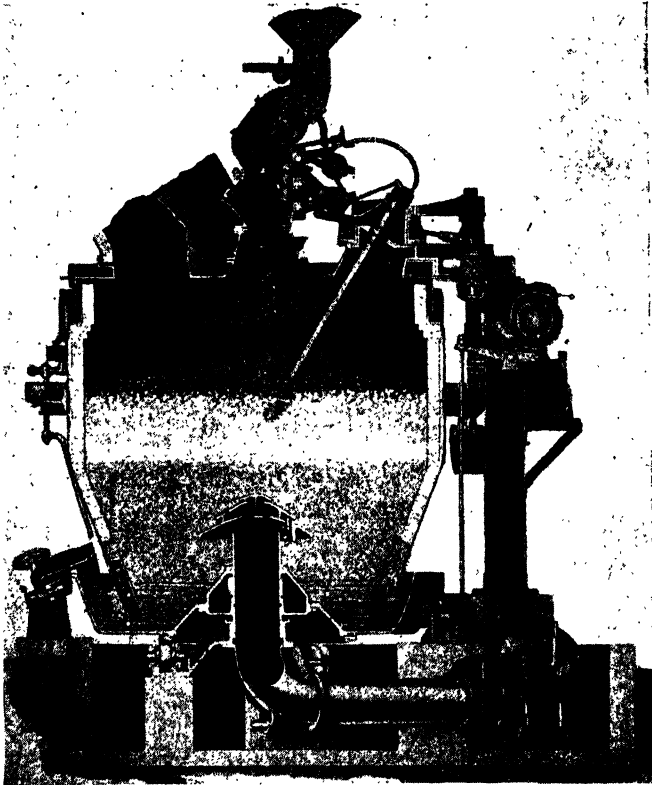

FIG. 3.—Sectional view of Wellman mechanical gas producer for bituminous coals. (Courtesy of Wellman Engineering Company.)

The fuel is introduced by a hopper mounted in this ring, which forms part of the top of the machine. The central gas offtake is stationary and starts as an enlarged or bell-shaped section that forms an annular space inside and at the top section of the shell. The fuel drops through the hopper into this annular space and the producer is kept filled with fuel to or above the bottom of the bell. This arrangement obviates the need of a rake or poker and has the desirable feature of maintaining only a very small gas space.

There are a number of other types of gas producers. Less elaborate machines have fewer or no mechanical features and require manual

charging, poking, and ash removal. Various sizes and designs are available for charging coke, coal, refuse, or low-grade fuels. *Pressure-type producers* are probably the most numerous. Air is supplied by a blower, and there is 5 to 20 in. H_2O pressure loss through the machine. The gas leaves under sufficient pressure to put it through whatever cleaning units are used and for its distribution if the units to be served are near

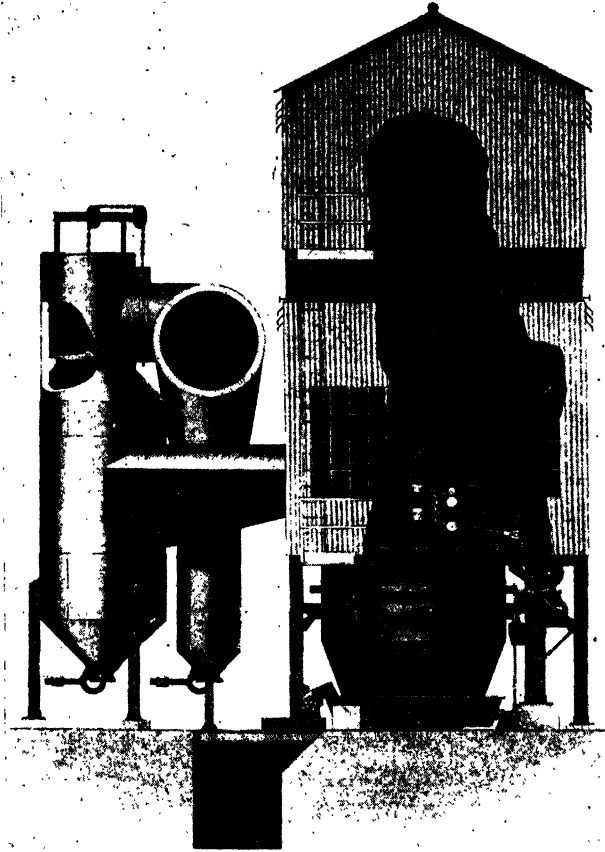

FIG. 4.—Elevation view of gas producer house. (Courtesy of Wellman Engineering Company.)

by. In *suction producers*, the gas is drawn through the machine by a slight vacuum on the gas duct created by the consuming unit. This arrangement is prevalent where the gas is consumed by large gas engines, as in steel plants. Many European motor trucks are fueled by a small gas producer carried on the truck. The truck producers burn charcoal, wood, and combustible refuse.

Sizes and Capacities. Commercial producers are usually 6 to 12 ft in diameter and 10 to 20 ft high, the bed of fuel and ash having a propor-

tionate height that is usually 4 to 10 ft. Rotating types turn steadily or intermittently at speeds averaging $\frac{1}{6}$ to 1 rph (with the exception of the *Wellman* machine illustrated that turns at 8 to 10 rph and is fired at higher rates than most other types). Machine capacities are usually 0.5 to 2 tons of fuel per hour, or up to 40 lb/sq ft of cross-sectional area per hour. Machine capacity depends upon characteristics of the fuel as much as upon the size of the producer. The steam rate is usually from 0.2 to about 1.0 lb/lb fuel, frequently 0.25 to 0.5 lb. The quantity of gas produced is usually between 55 and 80 cu ft/lb of fuel (60°F saturated 30 in. Hg). Heating value of the gas depends primarily upon type of fuel and secondarily upon producer operation (see Overall Efficiency, page 225).

Factors of Capacity and Operation. The surface of the fuel bed of most producers is maintained nearly flat and level by mechanical or manual means. The air is projected horizontally from the blast hood, but it tends to rise rather than to move horizontally through the bed. For proper distribution of gas through the bed, the ash layer is often kept somewhat higher at the sides than at the center, so that the fuel bed above the ash is somewhat thicker at the center. (In the type of producer that has a flat grate and no central blast pipe, the ash layer is nearly flat.) In some cases, good operation requires that the fuel level be maintained lower or higher at the center than at the sides, depending upon the shape of the ash layer and the difference in gas-flow resistance of the bed at the center from that at the sides.³

Satisfactory bed and zone thicknesses depend upon the fuel and upon the temperature of operation. The higher the temperature, the more rapid the reactions, and for this reason a high rate may not require a thicker bed. In fact, high rates are often maintained with relatively thin beds.

Both the maximum rate and the highest rate of satisfactory operation of a producer depend upon the nature and preparation of the fuel. The optimum size of fuel is $\frac{3}{8}$ to $1\frac{1}{4}$ in. screen size,³ but lumps up to 4 in. and fuels containing up to about 15 per cent of fines are frequently used. Too wide a gradation of sizes causes uneven burning. Large lumps may not be completely burned by the time they reach the ash zone. Fines tend to cause blowholes in the fuel bed, resulting in an uneven bed and low-quality gas.

Both percentage of ash and its fusing temperature are important. Ash cannot be satisfactorily removed at rates much greater than 10 lb/(hr) (square foot bed cross section) in many producers. The maximum temperature in the oxidation zone of a producer must be kept below the fusing point of the ash or clinkers will form. In extreme cases, coal that

³ DENIG, FRED, "Coke-fired Gas Producer Operation," AGA Convention, 1927.

is high in low-fusing ash may limit the capacity of a producer to 5 or 6 lb/(sq ft) (hr). Higher firing rates with a given fuel are obtainable by increasing the steam-fuel ratio. This reduces the temperature and inhibits clinker formation even more than expected from the temperature reduction. However, little if any steam in excess of 0.5 lb/lb fuel is usefully decomposed. Too great an excess of steam results in high gas outlet temperatures, a wet gas of low heating value and of high CO₂ content. The best gas and most satisfactory operation are obtained when a producer is not "pushed" to its maximum rate. The temperature should be maintained as high as permitted by freedom from clinkers.

Coke vs. Coal as Producer Fuel. The kind of fuel used in a producer depends principally upon cost and availability. Screened coke gives easiest producer operation. Since coke is noncaking, the lumps hold together until burned to ash and there is little or no tar. Byproduct coke-oven plants dispose of coke breeze and screenings in producer fuel wherever possible. Coke-fired producers use relatively large amounts of steam and operate with deep fuel beds. Their firing rates are easily controlled and their capacities are high.

The majority of the coke-fired producers in the United States are of the *Kerpely* type.³ Mechanical producers have water jackets instead of firebrick linings at the active zone. The cooled walls are not subject to clinker adherence, and the jackets generate about half a pound of low-pressure steam per pound of fuel charged. *Kerpely* producers do not have mechanical fuel rakes and depend upon distribution of the fuel and maintenance of the fire by careful charging and manual poking.

When bituminous coal is used as producer fuel, the gas contains considerable tar (as mist or fog) resulting from distillation of volatile matter. This tar imparts a gray to yellow color to the gas and, when present in quantity, it represents an appreciable part of the heating value of the gas. Tar causes no difficulty when the hot gas is fired directly into a nearby furnace. When a producer is operated with a high top temperature, decomposition of the tar into soot and gaseous hydrocarbons sets in.

As producers using coal are subject to trouble from caking and clinkering, their operation must be closely controlled and the fire carefully watched. Fuels of coal and coke mixed in various proportions give easier operation and are widely used. Anthracite coal is an excellent producer fuel, but its use is limited to applications where fines are available, or fuel cost is not a principal consideration.

Use of Steam. If nothing but air were used in a producer, the oxygen would be converted to carbon monoxide and the entire heat of formation of carbon monoxide would be set free. This would cause inordinately high temperatures. Since the decomposition of steam is endothermic, putting steam in with the air has the effect of converting part of the

oxidation heat into hydrogen and additional carbon monoxide. The use of steam gives a control over temperature, permitting a lower gas outlet temperature with but little sacrifice of thermal efficiency. When the fuel-bed temperature is maintained at the proper value, about 60 per cent of the steam is decomposed. (Test values of 90 per cent steam decomposed can be obtained.) The best heat efficiency is obtained with fairly high bed temperatures. For operation near the optimum temperature and steam rate (usually 0.25 to 0.45 lb/lb fuel), a slight change in steam rate has very little effect upon overall efficiency. However, excess steam is used in order to control clinker formation and to permit higher rates of gas production by holding the temperature down.

Water vapor must pass through the active zone of the bed in order to be decomposed. Little if any of the *moisture in the fuel* is decomposed since it is liberated and carried upward without ever coming in contact with the hot *reduction zone*. Some water is supplied by evaporation from an ashpan seal where present, but most of it is usually introduced by a steam jet in the blast pipe. The entering air is usually warm enough so that all the steam remains as vapor, but the air is close to or at its saturation temperature after introduction of steam. The proportion of steam is most conveniently controlled by maintaining a wet-bulb or saturation temperature of 128 to $132^{\circ}F$ or higher in the blast pipe. (These temperatures correspond to 106 and 118 mm partial pressures of water, respectively, and are equivalent to 65 to 75 per cent as many mols of steam as of oxygen in the air.)

An improved effect on inhibiting clinkers has been reported in one instance by placing the steam jet directly in the blast hood.

Cleaning the Gas. When producer gas is to be temporarily stored or used for purposes where clean gas is required, the dust, soot, and tar must be removed. This is accomplished by using a centrifugal dust catcher followed by a scrubber cooler (usually some sort of packed tower), a pinhole and annulus or impingement (P & A) type of tar eliminator (originally developed by Pelouze and Andouin), a Cottrell electrostatic precipitator, or some combination of these. The electrostatic precipitator is effective in removing very fine suspended particles.

The quantity of tar depends upon the fuel and the producer operation. In American practice, the amount of tar is usually less than 5 per cent of the weight of fuel.* It has a specific gravity of about 1.05 and tests about 10 per cent hydrogen. It contains about 8 per cent oxygen chiefly as tar acids, and a typical heating value of the moisture-free tar is $15,500$ gross Btu/lb. It is different in composition from and of poor quality as compared to coke-oven tar and is generally burned as plant fuel.

* In the *Mond* byproduct operation, 2.5 to 10 lb of steam per pound of fuel is used and up to 80 lb of ammonium sulfate and 20 gal of tar per ton of coal are recovered.

Overall Efficiency. The range of heating values of clean tar-free producer gas from various fuels is shown in the accompanying table.

<i>Fuel</i>	<i>Gross Btu per Cu Ft, 60° Sat, 30 In.</i>
Coke.....	125-135
Anthracite coal.....	130-150
Bituminous coal.....	140-180

The heat of combustion of carbon monoxide is 70 per cent of that of equivalent carbon, and the heat of combustion of cold producer gas (*cold efficiency*) is usually 70 to 80 per cent of that of the producer fuel. Adding the heat of combustion of the tar and the sensible heat in the gas as it leaves the producer may account for as high as 92 per cent of the heat of the fuel. This total is designated *hot efficiency*. The 8 to 12 per cent loss in normal practice is distributed among unburned combustible in ash (1 to 3 per cent), sensible heat in ash and dust, vaporization of water in seals (and jacket where present), and direct loss to the outside air.

The range of gas compositions is shown in the accompanying table.

	%
CO.....	20-30
H ₂	20-8
CH ₄	3-0.5
CO ₂	9-3
N ₂	50-56
O ₂	0.1-0.3

Gas high in both H₂ and CO₂ results from the use of excess steam.

Chemistry of Producer Operation. Reactions occurring in the bed of a producer are shown diagrammatically in Fig. 5. The fuel bed must be thick enough to provide adequate time for heating the fuel, decomposition of steam, and reduction of CO₂. The bed of ash must extend some distance above the blast hood to obtain even distribution of air. The "hot zone" is only a few inches thick, and here the coke burns to CO₂ just as in ordinary combustion. The gas temperature quickly attains its peak value necessary for subsequent steam decomposition and reduction of CO₂, which reactions are *endothermic*. Reduction reactions start near the top of the hot zone as soon as the oxygen from air has been consumed. In the "reduction zone," decomposition of steam into CO and H₂ occurs quite rapidly and is completed in the lower part of the zone. Reduction of CO₂ to CO proceeds more slowly but continues over a greater depth. At some point, the "coking distillation" zone is encountered where the volatile matter is driven out of the fuel. When coke is fired, the top part of the bed is only a preheating zone since there is little or no volatile matter.

Throughout the reduction zone and for a distance above it, the *water-gas reaction*



tends to bring the concentrations of the four components to equilibrium at the existing temperature. The position of equilibrium is high in CO at high temperatures and high in CO₂ at low temperatures. As the gas temperature falls in its travel up through the bed, the rates of all reactions decrease markedly. At the relatively low temperatures pre-

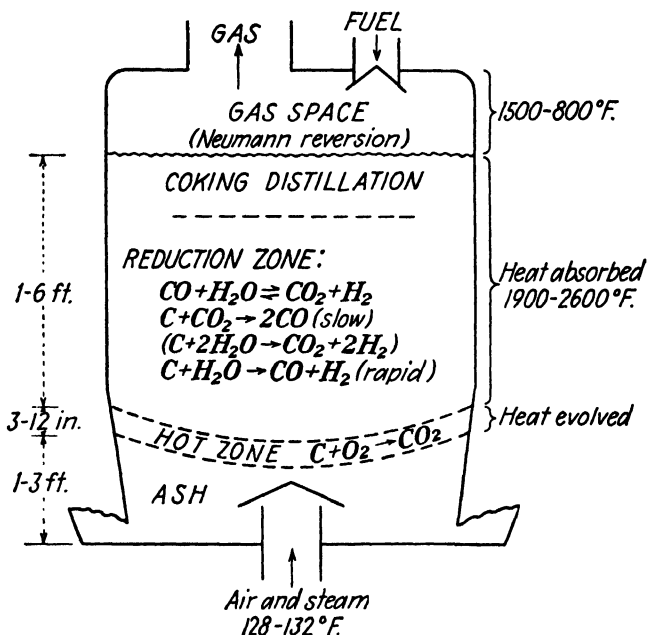

Fig. 5.—Gas reactions and temperature ranges in a gas producer.

vailing near the top of the bed, in the space above it, and in the gas duct system, the point of equilibrium of the water-gas reaction is to the CO₂ side. Reaction (3) also tends to reverse,



both effects tending to increase the CO₂ at the expense of the CO.

Progress of Reaction (5) to the right is undesirable if the gas is to be cooled and used for fuel, since water vapor condenses out whereas CO₂ does not. Reversal of Reaction (3) is undesirable, particularly if the gas is to be cleaned. Fortunately, carbon monoxide in producer gas does not decompose rapidly. Loss of heating value of the gas by such reactions is known as the *Neumann reversion*.

GAS PRODUCER CALCULATIONS

Stoichiometry. Gas-producer installations are seldom equipped to give complete operational data on flow rates, hence gas, fuel, and ash analyses are of particular value. Much valuable information on efficiency and characteristics of gas-producer operation may be obtained from analytical and temperature data. If one stream (air, gas, or fuel) can be metered or otherwise determined, all the others may be computed.

A nitrogen balance is indispensable for relating the amount of air to the amount of producer gas, as for any furnace (see Chap. IV). The total hydrogen in the gas comes from any net hydrogen in the fuel and from steam decomposition. Decomposition of steam must add exactly half as much oxygen as hydrogen to the gas, as CO, CO₂, and H₂.*

Estimation of Steam Injection. When a producer is operated at a moderate capacity and the steam rate is low, the per cent of the steam decomposed is high (up to about 90 per cent). As already noted, excess steam is frequently used to hold down the temperature at high firing rates and to avoid clinker troubles.

Steam meters (in common with other meters) may not be accurate unless frequently serviced, and not all producers are individually metered. Relations among the steam injected, the steam decomposed, and the gas analysis are therefore of great value.

It follows from Fig. 2 and the discussion concerning it that the concentrations of CO, CO₂, H₂, and H₂O in the gas as it passes through the bed of a producer are all interrelated and in a relatively simple manner. Haslam noted that for many cases of normal producer operation, gas composition with respect to these components is related by an "apparent" water-gas equilibrium constant, whose value is independent of temperature, firing, and steam rates but increases with thickness of the bed. His proposed relation is⁴

$$\frac{(\text{CO}_2)(\text{H}_2)}{(\text{CO})(\text{H}_2\text{O})} = 0.096L \quad (6)$$

where L is the fuel-bed thickness in feet. Equation (6) is very convenient for estimating *total water-vapor content* of the producer gas.

Walker, Lewis, McAdams, and Gilliland⁵ developed a successful method of predicting steam decomposition in terms of gas composition. Hydrogen from steam only—H₂'—is calculated and used in the equations

* This is not absolutely exact, since a small amount of methane is always formed.

⁴ HASLAM and RUSSELL, "Fuels and Their Combustion," p. 563, McGraw-Hill Book Company, Inc., New York, 1925.

⁵ "Principles of Chemical Engineering," 3d ed., pp. 237-250, McGraw-Hill Book Company, Inc., New York, 1937.

rather than *total* hydrogen for coal-fired producers. The relations were developed by using Reactions (2) to (4) to represent steam decomposition and reduction of CO_2 .

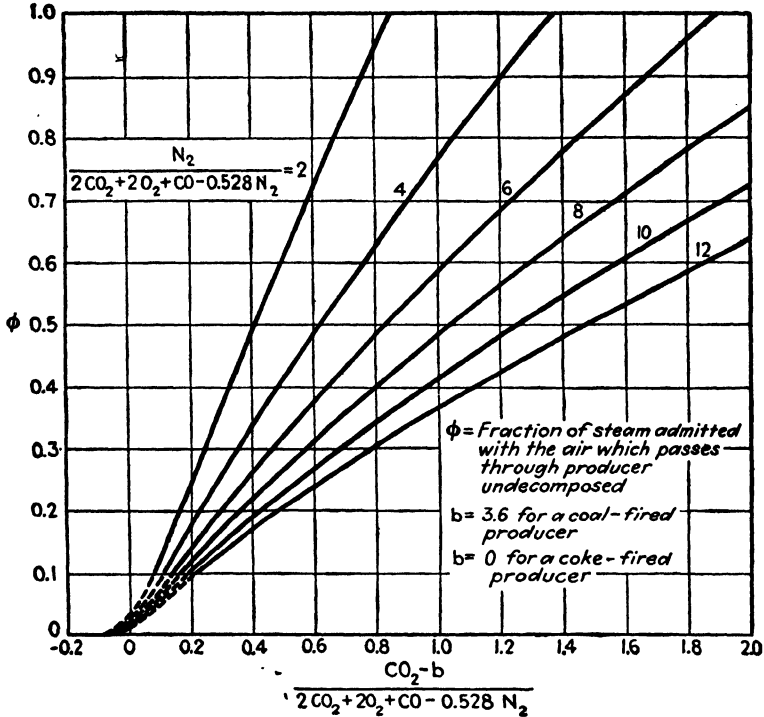

FIG. 6.—Chart for estimation of steam decomposition in gas producers. (Courtesy of W. H. McAdams.)

Let w = mols of water vapor present at some point in fuel bed, or in outlet gas

w_0 = mols of steam injected

ϕ = fraction of injected steam undecomposed = w/w_0

$b = 3.6$ for coal fuel, zero for coke fuel (a correction for higher CO_2 content of gas when coal is fired than when coke is fired)

The principal relations are; for water gas (inappreciable nitrogen),

$$1.01(\text{CO}_2) = (\phi - \phi^{1.319})w_0 \quad (7)$$

or for a volume of producer gas containing 100 mols of nitrogen,

$$1.01(\text{CO}_2) = w + (26.9 - w_0)\phi^{1.319} \quad (8)$$

Equations (7) and (8) relate CO_2 and H_2O , and apply to coke-fired units. When the fuel is coal, the actual CO_2 is about 3.6 points higher than the calculated value. The CO_2 values for firing with coal

become consistent with the equation by subtraction of $b = 3.6$ from the observed values. Thus, Eq. (8) can be converted into

$$\frac{101(\text{CO}_2 - b)}{N_2} = w + (26.9 - w_0)\phi^{1.319} \quad (9)$$

and

$$1.01 \left(\frac{\text{CO}_2 - b}{H'_2} \right) (1 - \phi) = \phi + 0.269(1 - \phi) \left(\frac{N_2}{H'_2} - 1 \right) \phi^{1.319} \quad (10)$$

where H'_2 is *hydrogen from decomposition of steam*. H'_2 is calculated from the concentrations of other gas constituents upon which it is stoichiometrically dependent, by the relation,

$$H'_2 = 2\text{CO}_2 + 2\text{O}_2 + \text{CO} - 0.528N_2 \quad (11)$$

All constituents are expressed as *mols per 100 mols of producer gas* in Eqs. (7), (9) to (11). Equation (11) neglects hydrogen consumption by formation of methane. As an average value, 2 mols of CH_4 are formed per 100 mols H_2 in the gas.⁶

Figure 6, a graph of Eq. (10), is useful for estimating the injection or fractional decomposition of steam in a gas producer. (Reference 5 also gives a *heat balance* on producer-gas formation in terms of gas composition and steam decomposition, and may be used to correlate *fuel-bed temperatures* with operating conditions.) Comparable but somewhat less certain results are obtainable by calculations that assume *equilibrium concentrations* of the gas constituents (from steam, oxygen, and carbon) in the gas leaving the producer.⁷

Illustration 1

Analyses* of fuel, refuse, and gas from a producer firing a bituminous coal are given in the accompanying table.

	Wt %—as fired		Dry gas, tar and soot free	Mol %
	Coal	Refuse		
C.....	76.0	15	CO.....	20.5
H ₂	5.4	...	H ₂	12.5
O ₂	5.8	...	CO ₂	7.5
N ₂	1.5	...	O ₂	0.2
S.....	1.5	...	CH ₄	3.0
Ash.....	9.8	85	C ₂ H ₄	0.5
			N ₂	55.8
Total.....	100.0	...		100.0

⁶ HARTZEL, F. W., private communication, October, 1944.

⁷ GOFF, J. A., *Ind. Eng. Chem.*, **18**, 585 (1926).

* Analyses from p. 227 of Reference 4.

Tar formation is estimated to be 3 per cent of the fuel. For 1 lb of coal as fired, calculate

- Cubic feet of producer gas.
- Cubic feet of air.
- Pounds of steam decomposed.
- Total steam admitted with air and its fraction decomposed, using Eq. (6). (Fuel bed is 9 ft thick.)
- Decomposition of steam, as fraction of that admitted with air, using Fig. 6.

Solution: Since the solution of the problem depends upon balances of the chemical elements, it is convenient to make tabular breakdowns of the analyses. The approximate tar composition is 82 per cent C, 8 per cent O₂, and 10 per cent H₂. The 3 lb of tar from 100 lb of coal contains 2.46 lb of C, 0.24 lb of O₂, and 0.3 lb of H₂.

The refuse contains (9.8) (0.15/0.85) = 1.73 lb C. For 100 lb of coal see the accompanying table.

	Total lb	Lb to gas ^a	Mols to gas ^a
C.....	76.0	71.81	5.98
H ₂	5.4	5.1	2.53
O ₂	5.8	5.56	0.174
N ₂	1.5	1.5	0.054
S.....	1.5	1.5	0.047
Ash.....	9.8		

^a Totals minus tar and refuse equivalents.

For 100 mols dry, tar-free gas,

	<i>Total Mols</i>
C, 20.5 + 7.5 + 3 + (0.5)(2).....	32.0
H ₂ , 12.5 + (3.0)(2) + (0.5)(2).....	19.5
O ₂ , 20.5/2 + 7.5 + 0.2.....	17.95
N ₂	55.8

The sulfur is converted largely to H₂S. Assuming this to be included with CO₂ by the analytical method, the carbon equivalent from coal to gas is

$$5.98 + 0.047 = 6.027 \text{ mols,}$$

and *mols dry gas per 100 lb of coal* = 6.027/32 = 0.188.

a. Gas production is

$$(359)(0.188) \left(\frac{520}{492} \right) \left(\frac{29.92}{30 - 0.52} \right) = 72.5 \text{ cu ft, } 60^\circ\text{F sat, } 30 \text{ in. Hg. Ans.}$$

b. The air used is calculated by a nitrogen balance. Nitrogen from coal is so small that it may be neglected.

$$(72.5)(0.558) \left(\frac{100}{79.1} \right) = 51.1 \text{ cu ft air, } 60^\circ\text{F sat, } 30 \text{ in. Hg. Ans.}$$

c. Steam decomposition produces additional total hydrogen and oxygen in the gas above the net hydrogen from coal and oxygen from air, respectively.

$$\text{Additional oxygen in 100 mols gas} = 17.95 - (55.8)(20.9/79.1) = 3.2 \text{ mols} \\ = 6.4 \text{ mols H}_2 \text{ from steam.}$$

Net hydrogen in gas = $2.53 - (0.174)(2) = 2.18$ mols/100 lb coal.

Additional hydrogen in gas (above net hydrogen from coal) per 100 mols gas = $19.5 - (2.18/0.188) = 7.92$ mols.

The two hydrogen values differ because of analytical discrepancies, and the average— 7.16 mols H_2 from steam—is probably safest to use. Steam decomposition is then,

$$\left(\frac{7.16}{100}\right) (0.188)(18) = 0.243 \text{ lb/lb coal. } \textit{Ans.}$$

d. Rearranging Eq. (6) and substituting values,

$$\begin{aligned} H_2O &= \frac{(CO_2)(H_2)}{(CO)(0.096L)} \\ &= \frac{(7.5)(12.5)}{(20.5)(0.096)(9)} = 5.3 \text{ mols/100 dry gas} \end{aligned}$$

Water in gas per pound of coal

$$\left(\frac{5.3}{100}\right) (0.188)(18) = 0.18 \text{ lb}$$

Water from oxygen in 1 lb of coal,

$$\left(\frac{0.174}{100}\right) (2)(18) = 0.063 \text{ lb}$$

From part (c), steam decomposed = 0.243 lb. Whence,

$$\text{Steam admitted with air} = 0.18 + 0.243 - 0.063 = 0.36 \text{ lb}$$

Fraction of injected steam decomposed = $100 \left(\frac{0.243}{0.36}\right) = 0.68 = 68$ per cent *Ans.*

e. Hydrogen from decomposition of steam, by Eq. (11), is

$$H_2' = (2)(7.5) + (2)(0.2) + 20.5 - (0.528)(55.8) = 6.5 \text{ mols}$$

The abscissa of Fig. 6 is

$$\frac{7.5 - 3.6}{6.5} = 0.6$$

The parameter is

$$\frac{55.8}{6.5} = 8.59$$

Whence,

$$\begin{aligned} \phi &= 0.3 \text{ and fraction decomposed} \\ &= 1.0 - 0.3 = 0.7 = 70 \text{ per cent } \textit{Ans.} \end{aligned}$$

CARBURETED WATER GAS

Straight water gas (*blue gas*) burns with a blue (nonluminous) flame. Before domestic electricity was generally available, flat-flame burners were in use for lighting, and illuminating properties were required of city gas supplies. This is mainly responsible for development of the carburetion process.

Carbureted water gas is actually water gas containing gaseous hydrocarbons produced by "carburetion" of a petroleum oil sprayed into the

water-gas set. These hydrocarbons consist principally of methane, gaseous olefins, and benzene, although minor amounts of higher aromatics, of ethane, and of higher paraffins are also present. The hydrocarbons above methane or more specifically the unsaturates, including aromatics, are still designated by the term *illuminants* (III).

Carburetion greatly increases the heating value of the gas, and carbureted water gas of any desired heating value can be made. In a few cases, gas with heating value above 1100 Btu/cu ft has been made. Such high-Btu gas is not economical to manufacture for general use. The heating value of carbureted water gas where used alone for city supplies is closely maintained at some value between 500 and 600 Btu/cu ft in most localities. The composition range of gas of this heating value is as shown in the accompanying table.

	%
H ₂	30-50
CO.....	20-30
CH ₄	9-15
Ill.....	7-12
CO ₂	3.5-6
O ₂	0.5-1.0
N ₂	4-15
Gravity.....	0.55-0.7 (air = 1.0)

Ethylene is the principal constituent of the illuminants and usually amounts to about 85 per cent of the total group.

Carbureted water gas of the usual type is interchangeable with coal gas for city supplies, and the two are frequently mixed.

The principal units of a carbureted water gas set are *generator*, *carburetor*, and *superheater* (Fig. 7). These are constructed as steel shells lined with firebrick. Generators and carburetors are usually 5 to 12 ft o.d., and the height is equal to or greater than the diameter. The superheater is considerably higher than the generator and carburetor. The generator contains the fire and is equipped with hearth or grate, means of charging and of ash removal. The oil is sprayed partly or entirely into the carburetor. Carburetor and superheater are maintained at high temperature to decompose the oil.

The superheater is filled with checkerwork maintained at 1100 to 1500°F. It provides the necessary time factor at this temperature to "fix" the oil vapor or continue its decomposition to low-molecular weight hydrocarbons that remain in the gas. The direction of gas flow through the carburetor is downward in most installations and is upward through the superheater. From the superheater, the gas passes through the *wash box (tar batter)*. The wash box serves as a water-seal check valve for the "make" gas. It also cools the gas to 170 to 185°F by evaporation

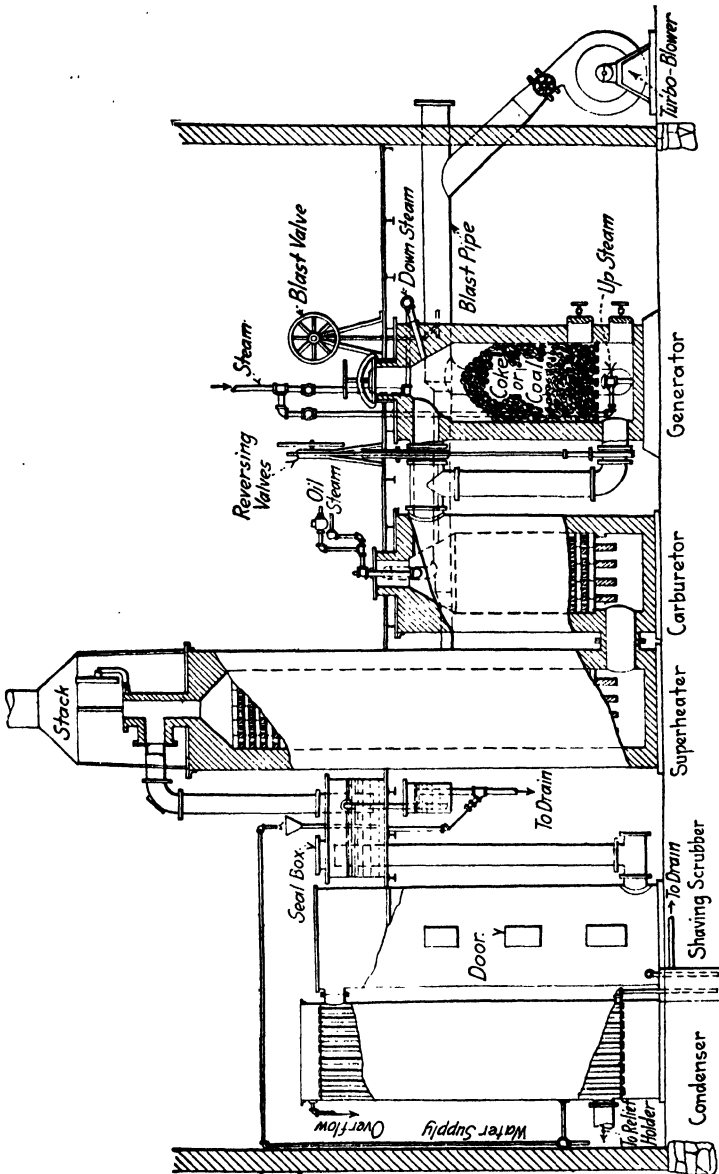

Fig. 7.—Diagram of principal units of a water gas set. (Courtesy of R. T. Haslam.)

of water and collects most of the tar and soot (lampblack) in the gas. From the wash box, the gas is further cooled and cleaned in a vertical shell-and-tube cooler and/or a grid-packed scrubbing tower, and goes to a *relief holder*. Final removal of tar and purification follow the relief holder, and the finished gas then goes to a *storage holder*.

The generator fuel is screened coke, coal, or mixtures of the two, in fairly uniform sizes between 2 and 6 in. Coke gives the easiest operation but due to relative cost and availability, more than twice as much coal as coke is used as generator fuel in the United States. A number of sets are operated on 100 per cent bituminous coal. Coal may give a somewhat higher heating-value gas before carburetion (about 335 *Btu/cu ft*) than can be obtained from coke, and so may require slightly less oil.

Operation of Carbureted Water-gas Sets. Since the formation of water gas and the decomposition of oil (as actually carried out) are endothermic, the operation of a water-gas set must include alternate heating ("blast," "blow") and gas-making ("run") periods in its cycle. Temperatures in the set rise during the blow and fall during the run; the checkerwork, firebrick linings, and generator fuel bed must serve as heat reservoirs. For this reason a thick fuel bed is maintained, frequently 6 to 8 ft in depth.

The steam cools the bed most rapidly at and near the point of its first contact (top or bottom, as the case may be). To maintain the deep bed in good operating condition and at effective gas-making temperature throughout, the cycle includes both an "uprun" and a "downrun" using steam. Except in rare cases, the blow is only from the bottom up in the generator and, to avoid danger of explosion, the downrun is followed by a short purging uprun to eliminate gas from the bottom of the generator before the blow. When the fuel is bituminous coal, considerable of the volatile matter distills during the blast. As the temperature rises, the heating value of the blast gas increases and, to recover this, the blast is often concluded by a brief "blowrun." The blowrun gas is similar to producer gas, and it is responsible for most of the nitrogen in the finished product. The entire cycle usually lasts 3 to 6 min (180 to 360 sec) and the operation is automatically controlled in up-to-date plants.

Time schedules for the above "standard cycle" are usually in the range shown in the accompanying table.

	<i>Sec</i>
Blow	90-120
Blowrun	5- 25
Uprun	75-105
Downrun	70-120
Purging uprun	3- 10

In this particular process, oil is sprayed only during the uprun. Oil is usually started a few seconds after the start of the uprun and is cut off

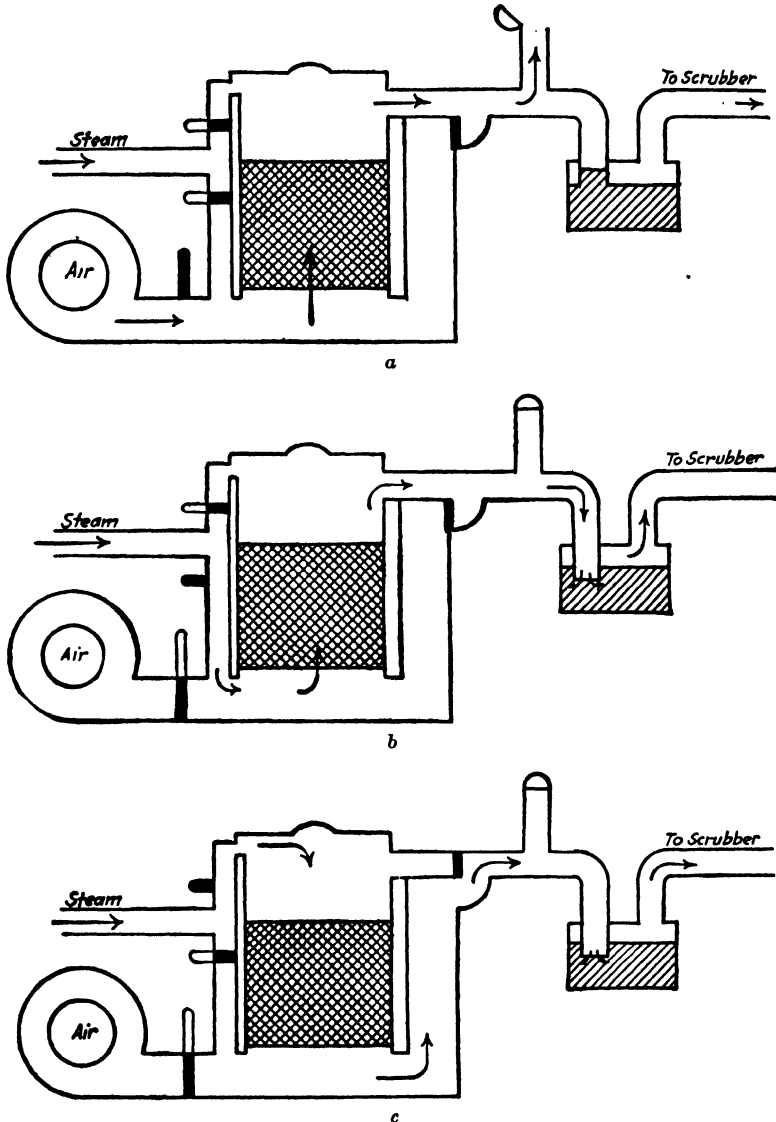

FIG. 8.—Gas flow through generator, showing position of valves. a, blast; b, uprun; c, downrun. (Courtesy of R. T. Haslam.)

20 to 30 sec before the end of the uprun. Downrun gas (containing no oil vapor) usually by-passes the carburetor and superheater, going directly to the wash box.

Controlling the flows of air blast, of steam, and of *make* oil into the set and of gases out of the set requires elaborate valve arrangements. Positions of the principal valves and the flows through the generator are indicated in Fig. 8.

In early operation of carbureted water-gas sets using coke and a good grade of gasoil, the blast gas was passed through generator, carburetor, and superheater in series, oil was sprayed only to the carburetor, and downrun steam was put in at the top of the generator.

Decomposition of the oil occurs largely on the hot surfaces of carburetor and superheater with deposition of carbon. Although much of the carbon deposited during the uprun with oil is subsequently burned off by the blast, a coating of carbon accumulates that must be cleaned off periodically. The more effectively to reduce carbon accumulation without producing excessive temperatures, common practice is to introduce some of the blast air into the carburetor, and occasionally a third supply of air is put into the superheater.

Modifications. With increasing use of coal and of lower grade carbureting oils, a number of modifications of equipment and operation were developed to eliminate smoke, to reduce carbon accumulation, to utilize particular fuels more efficiently, and to increase the life of the refractory checkerwork and linings. Some of the more significant modifications will be briefly described.

The UGI and others have developed modifications to use bunker or residual fuels successfully for carburetion instead of the more expensive gas oils. The UGI modifications include removal of checkerwork from carburetor (this checkerwork is usually replaced by a simple pier), spraying part or all of the oil directly on the generator fire (instead of all into the carburetor), and providing supplementary air piping and openings near the top of the generator fuel bed so as to admit part of the blast near the top of the generator fire (*marginal blast*).

Figure 9 shows a UGI set with generator (at right), carburetor, superheater, and wash box in sectional view. The generator has a fixed-type grate, although the larger sizes may have rotating mechanical grates very similar to those of gas producers, and water-cooled shells. The instrument panel, automatic cycle controller (at extreme right), and much of the main piping and valves with the pneumatic control lines may be seen in the diagram. The blast gas from the superheater may be wasted from the top valve into the stack or passed through the waste-heat boiler (behind wash box and set at a slight angle from the vertical in Fig. 9).

In the *Reverse Air-blast process*, the regular blow is followed by a reversed blow of about a minute with air put into the superheater and flowing through the carburetor and then generator. The gas emerging

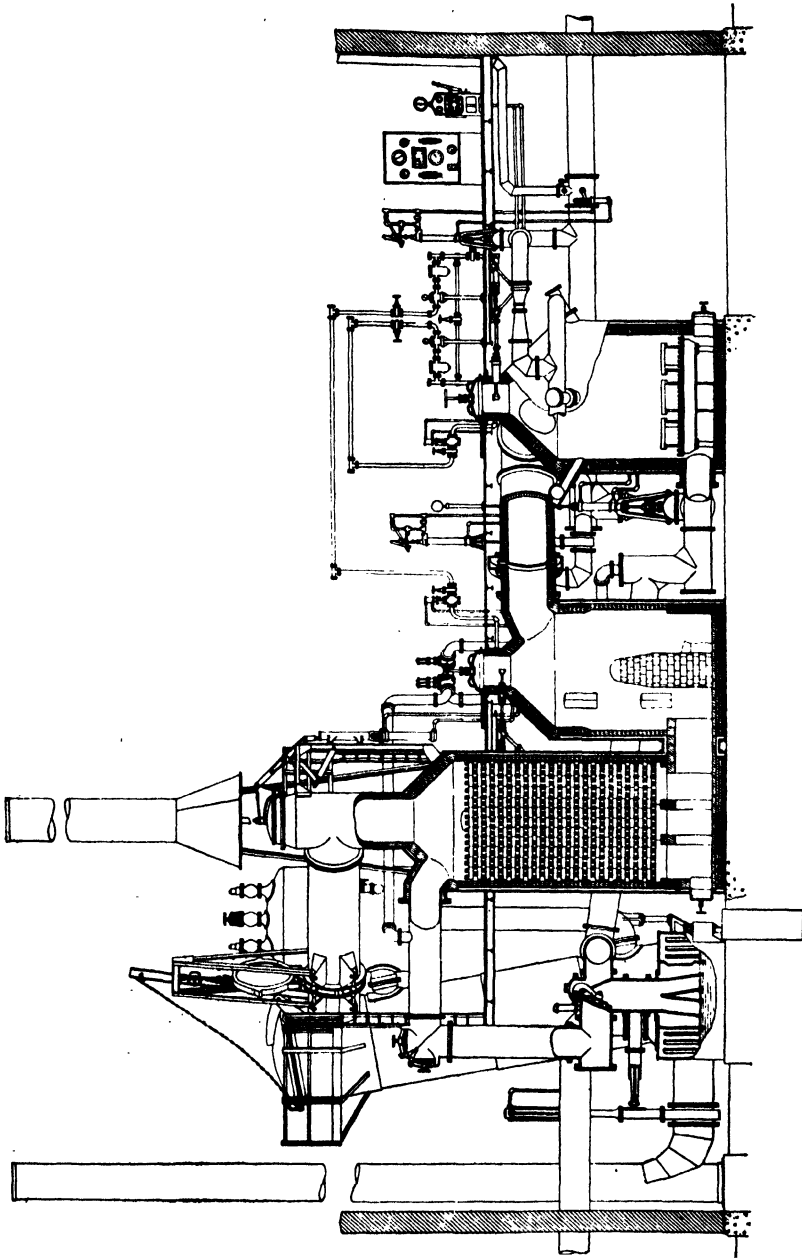

FIG. 9.—U.G.I. carbureted water-gas apparatus.

from the generator has a sufficiently high heating value to send through the wash box and include in the *make gas*. This process is effective in minimizing carbon accumulation and eliminating smoke when the fuel is bituminous coal.

In the *Backrun process*, the backrun steam is put into the superheater and flows in series through it, the carburetor, and the generator. This operation is reported to raise the capacity of the set somewhat and to increase the life of the checkerwork from about 1,000 to about 3,000 hr. The backrun steam consumes some of the oil carbon deposit from the checkers by forming water gas.*

Owing to the relatively high blast pressures used, the generator fire tends to be most active at the walls. This may be overcome by heaping the fuel higher at sides than in center, by the use of a cone-type grate or by a mechanical grate and high central blast pipe as in a producer. Large coal-fired generators are sometimes equipped with a central *pier* so that the fuel bed has the shape of a ring (*Pier process*).

The *Refractory Screen process* converts a carbureted water gas set to the use of oil as generator fuel (see Oil Gas, page 243).

SUMMARY OF OPERATING CONDITIONS

<i>Utilities per 1,000 Cu Ft Gas*</i>	<i>Usual Range</i>
Generator fuel.....	15-50 lb
Oil.....	3-5 gal
Air.....	1,000-2,000 cu ft
Steam.....	25-75 lb

* Hereafter, *M* designates 1,000 cu ft, 60°F sat., 30 in. Hg.

The requirement for generator fuel depends upon the particular process and operating conditions. The *Marginal blast* (UGI) *process* effectively uses part of the oil as generator fuel.

For any given process, the oil requirement depends upon the Btu of the gas made and upon the quality of the oil. Virgin paraffinic gasoils show *carbureting values* (heating value added to gas) of up to 115,000 Btu/gal. Cracked residual oils may give carbureting values as low as 80,000 Btu/gal, or lower if they contain much emulsified water. The carbureting efficiency of an oil is actually measured by the heating value of the gaseous hydrocarbons (and hydrogen) it adds to the gas. The difference between the carbureting value and the heating value of the original oil is accounted for by deposited carbon, tar, soot, and heat losses.

The air requirement depends upon operating conditions and type of fuel. Nearly all of the air is used for the blast. The least air is used

* In a modification of the process, make oil is sprayed onto the generator fire and sometimes to the carburetor also, during the backrun with steam. This procedure increases consumption of oil but decreases consumption of solid generator fuel.

when the fuel is bituminous coal and the most is required when the fuel is coke. The fraction of the steam decomposed is usually between 40 and 60 per cent of that admitted. Increased steam decomposition can be obtained where desired by the use of short cycles and operation of the set at low rates.

The hot blast gas is put through a waste-heat boiler and generates up to 40 lb of steam per M gas made. Additional heat may be recovered by putting the *make gas* through the boiler. However, the *make gas* contains suspended tar that deposits on the boiler tubes, necessitating frequent and inconvenient cleaning.

Of the heat energy in the gas, that supplied by the carbureting oil may be anywhere from about a third to three times that furnished by the generator fuel. Values of the items in the heat balance are given in the accompanying table.

TYPICAL HEAT BALANCE ON CARBURETED WATER-GAS SET

	%
Heat of combustion of cold gas.....	60-70
Heat of combustion of tar.....	5-15
Total in blast gas.....	5-15
Sensible heat in make gas (dry).....	3- 5
Sensible heat in undecomposed steam.....	2- 5
Total in ash and dust.....	1- 5
Total to carbon and balance.....	3-10

RATES AND TEMPERATURES^a

Capacity, max.....	5-6 M gas/(hr)(sq ft generator hearth area)
Blast rate.....	220-300 cu ft air/(min) (sq ft hearth)
Blast pressure.....	50-70 in. H_2O
Steam rate.....	3-8 lb/(min) (sq ft hearth)
Temperature generator bed, approx....	2800°F max
Temperature carburetor bottom.....	1300-1550°F
Temperature superheater top.....	1100-1400°F

The peak capacity of a set is 15 to 40 per cent lower when using bituminous coal than when using coke or anthracite. Carburetion appreciably increases the capacity of a water-gas set, as to both total volume of gas and thermal output, over that obtainable when making straight blue gas. But the higher the required Btu of the gas, the lower the peak rate of the set. It is not economical to operate a set at its peak rate, however.

The temperature of the generator bed is maintained as high as possible with avoidance of clinker troubles, since this permits high capacity and gives high percentage steam decomposition.

The blast rate must be such that generator fuel bed, carburetor, and superheater are all properly heated without local overheating. This is

^a See article by G. W. Steere, presented at AGA spring conference, June, 1944.

accomplished by using a high blast rate—just under that which will disrupt the fire and blow over excessive amounts of fuel particles and ash—and by using supplementary blast air in carburetor and sometimes superheater.

The carburetor and superheater temperatures together with the steam rate determine the degree of decomposition and “fixing” of the oil and its gaseous products. These temperatures must be somewhat higher at high gas rates than at low gas rates. When temperatures are too low, decomposition of the oil is inadequate and the tar from the wash box becomes oily. When temperatures are too high, floating lampblack appears in the wash box. Excessive temperatures of carburetor and superheater may also result in the formation of a troublesome amount of naphthalene.

WATER-GAS TAR

A carbureted water-gas set produces *0.2 to 0.9 gal of tar per M gas*. The amount of tar formed depends upon the Btu of the gas made and upon the type of oil. The tar may amount to as much as 30 per cent of the oil when bunker oils are carbureted. The amount of tar from gas-oil is less than from heavy oils, other factors being equal.

Tar condenses in and must be removed from the wash box, the condenser, the scrubbing system, the relief holder, and the interconnecting lines. It tends to emulsify with water, and the wet material is run into a tar-settling tank where tar and water slowly separate. Most of the separator water is recirculated to the wash box, but some of it must be discarded. The settled tar still contains some emulsified water and is ordinarily used for boiler fuel. If it does not contain too much water and suspended carbon, it may be returned to the set.

Water-gas tar has a gravity usually between 1.05 and 1.15. It somewhat resembles coke-oven tar, but it contains nitrogen bases, considerable free carbon, and is not of so good quality as coal tar. The tar may be distilled for recovery of by-products—notably benzene, toluene, and tar oils—where a sufficiently large and good quality supply is available to make the operation feasible.

COMPOSITION AND TREATMENT OF GAS

The gas leaving the wash box is at a temperature of about 180°F and is nearly saturated; a third or more of its volume is water vapor. The impurities that must be eliminated or controlled are suspended tar, dust, and soot; tar-forming compounds; naphthalene; hydrogen sulfide; organic sulfur (principally CS₂); hydrocyanic acid; oxides of nitrogen (traces, chiefly NO).

Roughly half of the tar, dust, and soot is caught by the wash box.

The condensing, scrubbing, and purification systems are similar to those used for coke-oven gas in many respects, although carbureted water gas does not contain ammonia. Since the *make* is intermittent, the gas is usually sent to a relief holder before treatment so that gas flow through the treating units is continuous and steady. The relief holder loses heat to the atmosphere, accomplishing some cooling and condensation of water and tar.

Condensing and Scrubbing. The gas is cooled by direct or indirect contact with water in a condenser, cooler, or washer. A vertical shell-and-tube condenser is commonly used. The gas is cooled to about 100°F and most of the water vapor and tarry compounds condense and are removed. The operation also brings down soot and dust in the condensates. The remaining tar is in the form of mist. Several types of eliminators are used for final removal of tar. Early scrubbers were packed with wood shavings or grids. Water circulated through the scrubber assists in removal of the tar and dissolves a portion of the gaseous impurities; H₂S, HCN, and oxides of nitrogen. The packed type of scrubber can be very efficient at low gas rates. The P & A type of tar extractor is a compact apparatus that will remove most of the tar. The Cottrell electrostatic precipitator is very efficient for both tar and dust removal and can be operated to clean the gas to any desired tar elimination.

Naphthalene Removal. At 60°F gas saturated with naphthalene contains about 10 grains /100 cu ft. When the temperature at any point in a gas-distribution system falls below the naphthalene saturation temperature, the solid hydrocarbon may deposit and cause a stoppage. Naphthalene content of the gas must be maintained at or below the above figure for city supplies in cool climates.

The amount of naphthalene formed in a carbureted water-gas set depends upon the peak temperatures of carburetor and superheater. Much of the naphthalene is eliminated with the tar (in which it is soluble), and many gas plants do not use separate naphthalene treatment. However, naphthalene scrubbers are sometimes required. These consist of packed towers through which a small amount of oil is circulated. The carbureting oil is often used for this purpose before being charged to the set. A naphthalene scrubber also effects partial removal of gum-forming constituents such as styrene and indene. When these compounds condense in "drips" (as in low portions of a cool gas line), they tend to polymerize to "liquid-phase" gum and cause stoppages in distribution lines.

Purification. Purification of the gas is the final stage of its treatment. The principal impurity to be removed is hydrogen sulfide, of which city gas supplies must be substantially free. The quantity of hydrogen sulfide formed depends upon the sulfur content of the carbureting oil and to a lesser extent upon that of the generator fuel.

Hydrogen sulfide content of the raw gas is as high as *300 grains/100 cu ft* in some cases but is usually much lower. For large supplies that have high H_2S concentrations, it is feasible to remove most or all of this impurity by a *liquid purification process* such as those noted in Chap. II, Part 2. The most common method of hydrogen sulfide removal has been the *dry-box process* employing boxes filled with hydrated iron oxide suspended on wood shavings, corn cobs, peat moss, or other material. In dry-box purification, the hydrogen sulfide reacts with the iron oxide. In successive reactions, the oxide is converted into Fe_2S_3 , and most of the sulfur is finally oxidized to elementary sulfur. It is necessary to revivify the boxes periodically and this is usually accomplished by careful circulation and partial recirculation of air.

Dry-box purification can reduce hydrogen sulfide in the gas to negligible concentration.

Organic sulfur compounds, chiefly CS_2 , usually occur only in small concentrations of the order of a few grains per 100 cu ft and are innocuous at these concentrations. Organic sulfur compounds are not removed by the usual purification processes and, where elimination is necessary, they are first converted to H_2S by a special high-temperature catalytic process.

Hydrocyanic acid in gas from coal occurs in concentrations usually less than 15 grains/100 cu ft. Gas from coke contains only one-tenth or less of this amount. It is largely or completely removed by any process used to eliminate H_2S .

Oxides of nitrogen are formed in trace concentrations in the fire of the water-gas generator. These must be completely eliminated. Fortunately, they are also removed by the processes for H_2S elimination. It is sometimes necessary to admit a little oxygen (usually as air) into the gas before purification. This apparently oxidizes NO to NO_2 , and gives better elimination by the H_2S scrubber or dry box.

Small amounts of nitric oxide remaining in the finished gas form "vapor-phase gum" with unsaturated hydrocarbons in the gas. This type of gum appears as an extremely fine mist that remains suspended in the gas for long periods but slowly deposits as a coating on pipe and other surfaces confining the gas. The merest traces of vapor-phase gum cause trouble with regulators and small orifices of gas appliances.

Dehydration and Oil Fogging. Gas as distributed is frequently near its dew point and as it cools in the distribution lines, water and tarry hydrocarbons slowly condense out. This material is removed by traps placed in the line for the purpose.

A gas supply may be dehydrated to a moisture content such that the dew point is below the minimum temperature to which it is exposed. Cooling with mechanical refrigeration and scrubbing with calcium chloride brine have been employed, but a current process uses diethylene glycol as a dehydrating agent. Dehydrated gas supplies tend to release dust

(such as particles of rust) in distribution systems, and the gas also dries out and shrinks nonmetallic packings, gaskets, and diaphragms in pipe joints, meters, pressure regulators, and other appliances. After dehydration, dust is kept under control and deterioration of nonmetallic parts is avoided by "oil fogging." A fine spray of gasoil is introduced into a chamber through which the gas is passed. Gas saturated with the oil holds about 1 gal/million cu ft. An excess is often used, particularly at the start of the operation in a system, and 2 to 5 gal/million cu ft may be carried away in the gas. Dehydration and oil fogging are standard practices for natural gas supplies.

OIL GAS

It is a universal custom to distinguish carbureted water gas from gas made entirely from oil. However, the current oil-gas supplies are similar in composition to carbureted water gas.

There are almost innumerable methods and modifications by which an oil may be decomposed to give a combustible gas.

Pintsch gas and *blau gas* were produced by thermal decomposition of oil in steel retorts. The decomposition was controlled so that the gas contained high percentages of illuminants. The gases were compressed and stored in steel pressure cylinders for use in illumination and so were the original "bottled gases."

The *Dayton process* decomposed oil by autocombustion with deficient air in a heated steel retort. The process required high-grade gasoil for successful operation. The gas contained *55 to over 60 per cent* N₂ and the maximum heating value that could be regularly obtained was about *560 Btu/cu ft*.

Current supplies of oil gas are made in the Middle West using converted carbureted water-gas sets, and on the Pacific Coast with oil-gas sets developed for the purpose.

Refractory Screen Process.—A number of carbureted water-gas sets have been converted to the manufacture of oil gas by the refractory screen modification.⁹ The grate is removed from the generator and it is replaced by checkerwork covered with a bed of small refractory blocks. Oil burners for heating are installed in both generator and carburetor, and oil sprays for carburetion are used in both. The oil burner in the generator is used only for the initial heating when the set is put into operation.

A typical cycle of about 6 min consists of

- Upblast (air up through generator, burner operated in carburetor)
- Downblast
- Downpurge (steam)
- Downrun (oil spray into generator and carburetor)
- Uprun (steam)

⁹ *AGA Proc.* 892 (1932) and articles in subsequent annual volumes.

During the oil run, carbon is deposited on the refractory screen and is removed by the subsequent steam uprun and by the blast. More carbon is deposited than is needed for reheating the generator, and the length of the steam run is so adjusted that the refractory screen is substantially cleaned by the blast on each cycle.

The cycle time is about the same as for carbureted water gas, and gas of 525 to 1100 Btu can be made. The tar amounts to 1 to 2 gal/M gas.

PACIFIC COAST OIL GAS

Large-scale manufacture of oil gas for city supplies was developed chiefly in the Pacific Coast states because of the relatively high cost of coal and coke. Pacific Coast oil-gas sets are of single- and two-shell types. Some gas of 1000 Btu is made, but the greatest part of the production is of about 550 Btu. The composition range of the latter material is shown in the accompanying table.

H ₂	45-55
CO.....	8-12
CH ₄	25-30
H ₂ S.....	3-5
CO ₂	1-5
O ₂	0.2-1.0
N ₂	3.5-8
Gravity.....	0.4-0.5 (air = 1.0)

The shells of oil-gas machines are checkered and are quite similar to the superheaters of carbureted water-gas sets. However, they are frequently much larger, ranging from 5 to 27 ft o.d. and from 12 to 48 ft high. The cycles are similar to those of carbureted water-gas sets but are often several times as long. Heating is accomplished partly by air blast that burns deposited checker carbon, and finally by burning oil in the set. During the heating portion of the cycle, the checkerwork attains a maximum temperature somewhere between 1600 and 1700°F. The high temperature produces enough naphthalene to require a naphthalene scrubber, and a large amount of lampblack that is recovered from the wash box.

A general comparison of Pacific Coast oil gas with carbureted water-gas manufacture can be briefly given. In the oil-gas sets, water gas is made chiefly by steam contact with carbon deposited on the checkers, and the oil gas contains less CO. A second fundamental difference is the higher checker temperatures in oil-gas sets. This results in a greater degree of oil decomposition. Oil gas is high in hydrogen and contains more methane and less illuminants than carbureted water gas of the

same heating value. Oil gas and coke-oven gas of the same heating value are of substantially the same composition.

There are two principal modifications of the single-shell apparatus. The earlier type is known as the *single-shot, heat up and make down*. The checkerwork is supported on an arch. The heating and air blasting are both from below. *Make oil* and steam are put in at the top, with the *make gas* removed from below the checkers. A large quantity of lampblack—up to 24 lb/M gas—is produced.

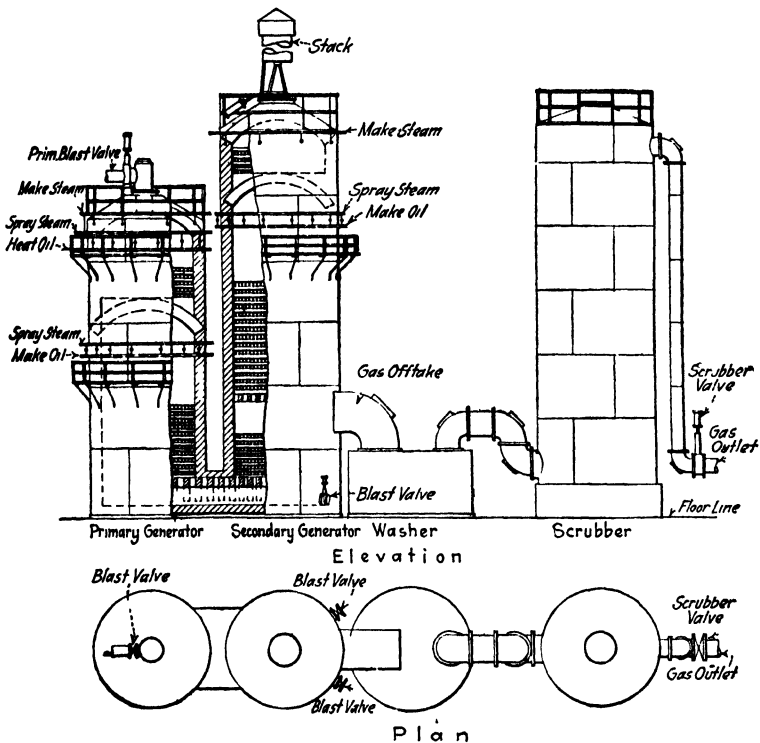

FIG. 10.—Diagram of Jones process oil gas set. (Courtesy of R. T. Haslam.)

The later single-shell apparatus is designated *heat-and-make down*. Heating, blasting, *oil* and *steam makes* are all from the top down. This type of operation results in a higher carbureting value of the oil, and with careful control produces much less lampblack than is formed in the "single-shot" apparatus.

The two-shell oil gas set (Jones type) has about double the capacity of a single-shell machine of the same shell diameter, or about the same specific capacity per shell. Each shell is a generator, but heating oil is burned only in the first shell. The checkerwork in the primary generator

is divided into two sections with a supporting arch between, in the apparatus shown in Fig. 10. Checkerwork of the lower section continues through the connecting duct into the lower part of the second generator. The gas offtake is located just above the bottom checker, and the checkerwork arrangement above the offtake is essentially the same as in the first generator.

Heating oil is burned at the top of the first generator, and heating gases pass downward through it, then upward through the second checker and out the stack. Blast gases follow the same course, although separate blast air may be admitted to the second generator. Oil and steam makes are downward in both generators. Most of the steam is admitted at the top of the generators. The make oil is admitted at the second checkerwork section from the top in each generator. Steam is used to atomize or spray the oil, and it tends to suppress carbon accumulation and formation of lampblack. A typical cycle of 20 min is given in the accompanying table.

<i>Min</i>	
Air blast.....	5 (air to second shell also during last 2 min)
Heating.....	5
Steam purge-make.....	1
Oil make.....	7 (steam in spray)
Steam make-purge.....	2

The oils are usually California heavy or topped crudes. When the oil is high in sulfur, the gas may contain considerable organic sulfur that must be removed by a special purification process (see Purification under Composition and Treatment of Gas). Naphthalene is scrubbed with part of the process oil. Lampblack is removed from the wash box, drained, briquetted (with tar as a binder), and sold or used as plant fuel.

Some production factors for oil-gas sets are shown in the accompanying table.

Capacity.....	400-650 cu ft gas/(hr)(sq ft inside cross section of each shell)
Total steam.....	20-40 lb/M gas
Total oil.....	7-13 gal/M gas (depends on Btu of gas. About 1 gal or less for heating)
Carbureting value of oil.....	60,000-85,000 Btu/gal
Tar.....	1.5-7 lb/M gas (approx 0.2-0.8 gal)
Lampblack.....	12-24 lb/M gas
Naphthalene.....	Up to 1 lb/M gas
Heat equivalent of cold gas...	45-55 per cent
Heat equivalent of lampblack.	18-29 per cent
Heat equivalent of carbon deposited on checkers.....	10-20 per cent

In spite of the high operating temperatures, the life of the checkers is from $1\frac{1}{2}$ to 3 years.

Oil Gas without Lampblack. As previously noted, high checker temperatures result in the formation of large quantities of lampblack. This cannot always be profitably disposed of. The *Refractory Screen* modification for carbureted water-gas sets can be operated without producing lampblack because of the lower carburetor and superheater temperatures. Operation at the lower checker temperatures without excessive carbon accumulation is made possible by the refractory screen device, so that most of the deposited carbon is burned as generator fuel.

The *Filter-Producer process*¹⁰ employs four shells, two of which are checkered and two are of special construction. Each of the latter is provided with a grate supporting a bed of refractory spheres. During an oil make, lampblack in the gas is caught or filtered out by the refractory bed. It is later burned off by the air blast, the blast gas being used to heat a checkered shell. Utilization of the lampblack for heating reduces the oil requirement.

The *Twin-Generator process*¹¹ virtually prevents formation of lampblack by decomposing the oil in an atmosphere of steam. The equipment is converted from a carbureted water-gas set. It is operated to make gas of 900 to 1000 Btu that is interchangeable with natural gas in city supplies.

CITY GAS SITUATION

During the past two decades, the tremendous expansion of petroleum and natural gas production has profoundly influenced city gas industries. Natural gas is produced and consumed for carbon black, power, and other industrial uses in quantity equivalent to several times that of all city supplies. In 1940, 80 per cent of the total natural gas was produced in Texas, California, Louisiana, Oklahoma, and West Virginia. Gas from these states is piped to most urban areas of the United States for use in city supplies. City gas in Southwestern states and California is almost exclusively straight natural gas.

Dry natural gases have heating values usually between 1000 and 1025 Btu/cu ft, almost double that of most carbureted water gas. The manufactured gas industry considered *reforming* natural gas to lower heating values, using water-gas sets. Reforming is practiced to some extent, but it is a wasteful process from the standpoint of thermal efficiency. The great majority of gas appliances designed for 500 to 600 Btu gas can be operated on 1000 Btu natural gas after installation of smaller gas orifices and adjustment of air shutters (see Chap. IX).

¹⁰ *Pacific Coast Gas Assoc. Proc.*, 66 (1937).

¹¹ *AGA Proc.*, 377 (1942).

Current reforming operations are chiefly on refinery gas. Present practice is merely to blend natural with manufactured gas to the desired heating value. The output of a carbureted water-gas plant may be greatly increased by making blue gas only and enriching with natural or other high-Btu gas.

Mixed gas is served in metropolitan areas. Various mixed gas supplies may contain blue gas, carbureted water gas, oil gas, producer gas, coke-oven gas, refinery gas, natural gas, propane, and butane. The heating value of mixed gas supplies consisting largely of manufactured gas is 600 to 875 Btu. Where the supply is principally natural gas, standby and supplementary supplies are high-Btu oil gas, propane, and butane. In general, these are used to meet peak and emergency loads.¹²

Propane and butane are used alone or mixed with air to supply small isolated communities. *Bottled gas* (liquefied petroleum, LP gas) is delivered by truck to individual rural consumers.

Supplementary References

1. MORGAN, J. J.: "American Gas Practice," Vol. I, J. J. Morgan, Maplewood, N.J., 1931.
2. "Gas Engineers' Handbook," Sec. V, Pacific Coast Gas Association, McGraw-Hill Book Company, Inc., New York, 1934.
3. "Rogers' Manual of Industrial Chemistry," 6th ed., Chaps. 15, 19, by W. H. Fulweiler, Van Nostrand Company, Inc., New York, 1942.
4. "Chemistry of Coal Utilization," Vol. II., Chap. 36, by B. J. C. van der Hoeven, Chap. 37 by J. J. Morgan, John Wiley & Sons, Inc., New York, 1945.
5. ALTIERI, V. J., "Gas Analysis and Testing of Gaseous Materials," American Gas Assoc., New York, 1945.

Exercises

NOTE: Refer to Chaps. V and VI for data.

1. A producer gas obtained from coke is in approximate equilibrium with the reaction

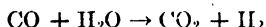

The gas contains 20 per cent CO, 8 per cent CO₂, 57 per cent N₂, and 12 per cent H₂ on the dry basis. Neglect methane formation.

- a. How many mols of water vapor are present per 100 mols of dry gas?
 - b. What per cent of the original H₂O is decomposed?
2. A producer gas tested 6.0 per cent CO₂, 24.0 per cent CO, 9.0 per cent H₂, 1.5 per cent CH₄, 56.5 per cent N₂, 3.0 per cent O₂. Neglect tar formation. The fuel from which it was made was hydrogen-free coke. Calculate
 - a. Pounds of steam decomposed per pound of C as coke.
 - b. Cubic feet of dry gas per pound of C as coke.
 - c. Pounds of steam admitted per pound of C as coke.
 3. If the reaction $\text{CO} + \text{H}_2\text{O} \rightarrow \text{CO}_2 + \text{H}_2$ controls the CO₂ present in the gas from a water-gas generator, at what temperature is a gas containing 25 per cent CO,

¹² SEGELER, C. G., *Am. Gas J.*, **155** (November and December, 1941).

40 per cent H_2 , and 5 per cent H_2O in equilibrium with (a) 4 per cent CO_2 ? (b) 6 per cent CO_2 ?

4. Siemens gas, which is essentially carbon monoxide and nitrogen, is manufactured by passing a mixture of air and flue gas through a bed of incandescent coke. The mixture is so proportioned that the heat effects of burning the O_2 to CO and reducing the CO_2 to CO balance, and the fuel bed remains at a constant temperature. In this case the temperature is to be $900^\circ C$.

Assuming adiabatic operation (no heat losses to the outside), a flue gas containing 21 per cent CO_2 , air and flue gas both preheated to $900^\circ C$, and quantitative reactions, calculate

- The heat given up by combustion of 1 mol of O_2 to CO at $900^\circ C$.
- The heat absorbed by reduction of a mol of CO_2 to CO at $900^\circ C$.
- The mols of flue gas per mol of air in the mixture.
- The mols of Siemens gas produced per mol of carbon, and its composition.

The atomic heat capacity of carbon between $60^\circ F$ and $900^\circ C$ may be taken as 4.5. (One mol of O_2 is a convenient basis.)

5. The essential reactions occurring in a gas producer burning coke may be represented:

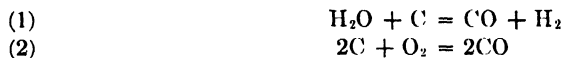

Such a producer is to be operated at a constant temperature of $1860^\circ F$ by admitting only enough steam to maintain the temperature, since Reaction (1) is endothermic, while Reaction (2) is exothermic. The oxygen is supplied in the form of air. The reactants are at the following initial temperatures: air, $60^\circ F$; steam, $240^\circ F$; coke, $1860^\circ F$.

Assuming adiabatic operation, quantitative reactions, and an average atomic heat capacity of carbon of 4.75, calculate

- The heat of Reaction (1) at $1860^\circ F$.
- The heat of Reaction (2) at $1860^\circ F$.
- Mols of air used per mol of steam. (Let x = mols O_2 /mol steam.)
- Pounds steam per pound of C as coke.
- Composition of producer gas.
- Cubic feet of producer gas at $60^\circ F$ and 1 atm/lb coke. (One mol steam is a convenient basis.)

6. Coke and steam are heated at 1 atm to (a) $1000^\circ F$, (b) $1500^\circ F$, and (c) $2000^\circ F$. Assuming that the steam does not dissociate to give O_2 , calculate the analysis of the resulting gas and the per cent of the steam decomposed. In the final analysis, neglect any constituent whose concentration amounts to less than 1 per cent.

CHAPTER IX

GAS BURNERS

INTRODUCTORY FLUID MECHANICS

Small fluid pressures in pipes may be measured by open manometers using any confining liquid whose specific gravity is higher than that of the fluid flowing. For gases under low pressures, water is a convenient confining liquid and the pressure that is measured as the difference in liquid height in the two arms is *head pressure in inches of water* (H''_w). In the relations to follow, head pressure (H) is expressed as *feet of gas*. This is calculated from the pressure in inches of water by the conversion;

$$H = \frac{12}{62.3} \rho_g H''_w = 0.1925 \rho_g H''_w$$

where ρ is the gas density as pounds per cubic foot at the flowing temperature and pressure.

Whenever the fluid in a pipe is flowing, the observed pressure depends upon the manner in which the manometer is connected to the pipe (Fig. 1). *Static pressure* is obtained when the manometer connection

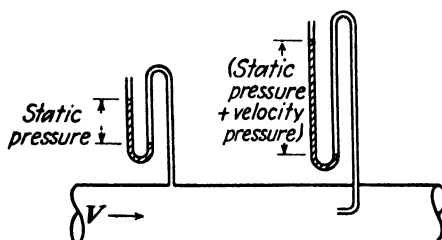

FIG. 1.—Measurement of static and velocity pressures.

is flush with the inside surface of the pipe or *normal to the direction of fluid flow*. *Static pressure plus velocity pressure* is obtained when the manometer tube connection is *pointed upstream to the direction of fluid flow* and is always greater than static pressure alone. The difference between the two manometer readings is the *velocity pressure*, which is directly related to the rate of fluid flow. The pitot tube is an instrument used to measure fluid velocity in pipes by the utilization of this principle. It consists of velocity and static openings mounted together and connected to a single manometer, so that the manometer reading is the differential

or velocity pressure directly. From physics,

$$\text{Kinetic energy} = \frac{1}{2} \left(\frac{W}{g} \right) V^2$$

where W is the weight of a body, V its linear velocity, and g the acceleration of gravity. This relation applies to fluids, since a fluid is actually a large number of submicroscopic particles. Choosing a basis of 1 lb of fluid, the kinetic energy is $V^2/2g$. Bringing it to rest by projecting it vertically upward against the force of gravity converts its kinetic energy into potential energy. If H is the height to which kinetic energy will project the fluid,

$$H = \frac{V^2}{2g} \quad (1)$$

or

$$V = \sqrt{2gH} \quad (1a)$$

The impact or upstream opening of Fig. 1 accomplishes just this, and H is identified as the *velocity pressure* or *head, expressed as feet of the fluid*. Also,

V = linear velocity, ft/sec

g = acceleration of gravity, 32.17 ft/(sec)(sec)

Impact pressure expressed as velocity head is related by Eq. (1) to the fluid velocity *at the point in the pipe where the tube opening is placed*. However, fluid velocity varies over the cross section of a pipe, approaching zero near the wall and attaining maximum velocity at the pipe axis. In other words, there is a definite *velocity gradient* from wall to axis. The pattern of this gradient is always the same at a given value of the *Reynolds number* ($DV\rho/\mu$)

where D = pipe diameter

V = average fluid velocity

ρ = fluid density

μ = fluid viscosity

all variables being expressed in self-consistent units. At Reynolds numbers up to 2,100, a streamline, laminar, or viscous type of flow prevails. For this type of flow

$$V_{av} = 0.5V_{max}$$

At higher Reynolds numbers, the flow is turbulent and the velocity gradient is quite different. At high values of the Reynolds number (above 15,000),

$$V_{av} = 0.8V_{max}, \text{ approx}$$

These relations enable calculation of the flow in a pipe from a pitot reading taken at the pipe axis, for flow at low and at high Reynolds numbers. For flow measurements at Reynolds numbers between 2,100 and 15,000 it is necessary to make a *pitot traverse* of the pipe.¹

Equation (1) also applies to partial interchanges between static and velocity pressures as occur in the venturi tube and sharp-edged orifice (Figs. 2 and 3). Hereafter, V refers to *average velocity* over the entire cross section.

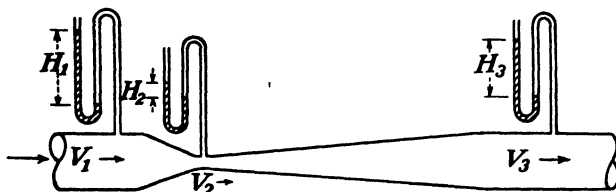

FIG. 2.—Venturi tube.

In the *venturi tube*, the velocity increases from V_1 in the line to V_2 in the contracted throat. For steady flow under conditions of substantially constant volume of fluid,

$$V_2 = V_1 \left(\frac{S_1}{S_2} \right)$$

where S_1 and S_2 are the cross-sectional areas of the tube at upstream and throat sections, respectively.

The static pressure at the throat (H_2) is less than that at the upstream section, and the velocity pressure is correspondingly greater. Equating the potential plus kinetic energy at the two sections,

$$H_1 + \frac{V_1^2}{2g} = H_2 + \frac{V_2^2}{2g}$$

or

$$H_1 - H_2 = \frac{V_2^2 - V_1^2}{2g} \quad (2)$$

The same relation holds in going from throat to downstream section (*section 2* to *section 3*), and the static pressure increases. However there is a permanent loss caused by fluid friction, and H_3 is always somewhat less than H_1 because of friction. A method of accounting for friction loss is to introduce a *discharge coefficient* (c) into the equation. Thus,

$$V_2^2 - V_1^2 = 2gc^2(H_1 - H_2) \quad (3)$$

For a well-constructed venturi tube operated under ordinary conditions, $c = 0.98$.

¹ See pp. 835-841 of Supplementary Reference 1.

The *sharp-edged orifice* shown in Fig. 3 is often constructed by inserting an accurately drilled plate between the halves of a pipe connection flange. Equation (3) applies, but since the fluid must find its own contraction and enlargement streamlines, there is a much greater friction

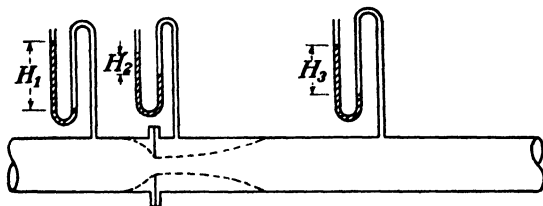

FIG. 3.—Sharp-edged orifice.

loss than occurs in the venturi tube. For a sharp-edge orifice handling gases at high Reynolds numbers, the value of c approaches 0.61. The pitot tube, venturi, and sharp-edged orifice are common types of industrial flowmeters.^{2,3}

Consider the inspirator diagram of Fig. 4. Gas issues from the small tube or orifice and flows into the inspirator tube, drawing air in with it.

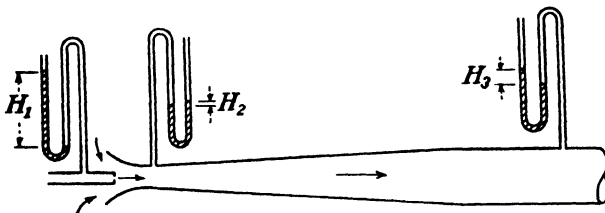

FIG. 4.—Inspirator tube.

Except for friction there would be a constant flow of mechanical fluid energy at all points.

Let W_g = weight of gas leaving orifice

W_a = weight of air entrained

H = static head, as feet of fluid in tube at indicated point

then,

$$W_g \left(\frac{V_1^2}{2g} \right) = (W_g + W_a) \left(\frac{V_2^2}{2g} + H_2 \right) = (W_g + W_a) \left(\frac{V_3^2}{2g} + H_3 \right) \quad (4)$$

Equation (4) is a mechanical energy balance which theoretically applies between various sections of an inspirating gas burner, provided that fluid friction is negligible. Actually, *friction controls the performance of atmos-*

² BADGER and McCABE, "Elements of Chemical Engineering," 2d ed., Chap. II, McGraw-Hill Book Company, Inc., New York, 1936.

³ WALKER, LEWIS, McADAMS, and GILLILAND, "Principles of Chemical Engineering," 3d ed., Chap. III, McGraw-Hill Book Company, Inc., New York, 1937.

pheric gas burners, since pressure differences between some sections may be as low as a few hundredths of an inch of water. Consequently, Eq. (4) is seldom used for the design of low-pressure burners.

GAS-BURNER CLASSIFICATION

There are many types of gas burners and, for a given application, several satisfactory designs can be worked out. The only general feature possessed by all types of burners is the provision for mixing the gas with part or all of the air (primary air) before ignition. Similarly, there is not always a sharp distinction between burner types. Most installations are "atmospheric burners" that use gas at low pressure and inspire the primary air from the atmosphere. These produce short flames. Furnaces having sizable fireboxes can accommodate fairly long flames, and burners designed for high heat density are used. The energy needed for inspiring air into high-capacity burners may be furnished by higher gas pressures or by a fan or blower.

Gas-line pressures as high as 40 psig at the burner are sometimes used, and many burners can be satisfactorily adapted to a wide range of capacities by installing the proper size of gas orifice. A further advantage of high-pressure gas is that smaller orifices may be used. Since smaller orifices provide higher gas velocities, higher burner-head pressures are developed that give greater working range or turndown. "Turndown" is defined as the maximum flow rate divided by the minimum flow rate over the range of satisfactory burner performance. Burner practice calls for a turndown ratio of about five to one. When greater variation in heat requirements occur, several small burners rather than a single large one should be installed so that some may be turned out completely.

A convenient burner classification is accorded by the *type of port*, or opening at which the gas mixture burns:

1. *Small-port burners* having port holes up to No. 28 drill size (0.1405 in. in diameter).

2. *Large-port burners* having port holes larger than No. 28 drill size, or requiring gas at a pressure above 8 oz of water gauge pressure.

3. *Radiant or tile-port burners* in which the burner ports consist of, or are mounted in, a special refractory shape (burner tile), which is heated to incandescence while in operation.

SMALL-PORT BURNERS

Small-port burners include most of the domestic and a number of atmospheric industrial types. The essential features of their construction are shown in Fig. 5. Gas issuing from the small orifice entrains "primary" air that is drawn in through the air shutter. The mixture flows through the mixing tube into the manifold and out through the

small port holes, where it burns in short blue flames. The gas rate or input is controlled by the valve. The proportion of primary air is adjusted by setting the air shutter.

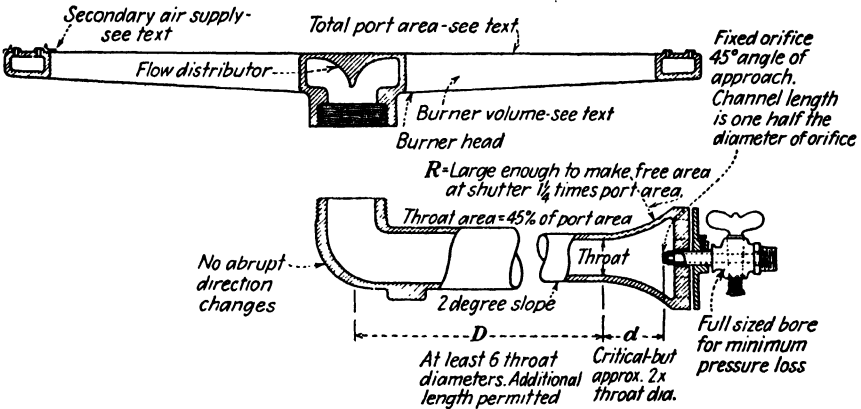

FIG. 5.—Essential details of a small-port burner. (Courtesy of American Gas Association.)

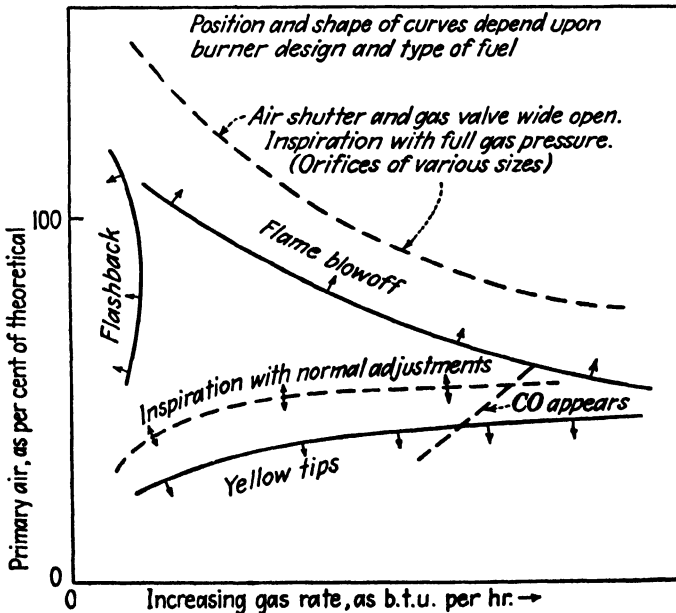

FIG. 6.—Typical performance curves of an atmospheric burner.

Typical operating characteristics of atmospheric burners are illustrated by Fig. 6. The abscissa is the gas rate or input. The ordinate is "per cent primary air" (per cent of theoretical air from complete combustion) entrained by the burner. As the air shutter is opened, more

primary air is inspirated, the flame first turns blue, then becomes shorter and "harder" (see Chap. VI). For any given rate of heat liberation (input), there exists a maximum and a minimum percentage of primary air between which the flame is nonluminous and stable. At higher percentages of primary air, flame blowoff occurs; at lower percentages the flames become yellow. As the input is increased, these limits approach each other and finally coincide. The point of coincidence is the maximum input at which the burner can be made to function. The maximum *practicable* input must be lower than this and is kept below the rate at which CO appears. At very low rates, flashback occurs if the burner ports are large. Extinction takes place if the ports are small and the fuel is of the slow-burning type (natural or liquefied hydrocarbon gas).

In general, burners are capable of inspirating more than the required proportion of primary air, with the exception of some installations using low-Btu manufactured gases at low gas-line pressures. In many cases, when the gas valve and air shutter are both wide open the primary air-input value lies above the blowoff curve. The upper dashed curve of Fig. 6 is typical of wide-open values obtained using orifices of various sizes in the same burner.

When a burner is installed, the orifice size and air shutter are adjusted so that primary-air inspiration is between blowoff and yellow tip values at all inputs. The "normal inspiration" curve is shown in Fig. 6. With the gas-line pressure fixed, the orifice capacity should limit the maximum input. It is also evident that the per cent of primary air is most critical at the maximum input, and the air shutter should be adjusted so that neither blowoff nor yellow tips occur when the gas valve is wide open.

Size and Number of Ports.⁴ Port design involves a compromise between cost of manufacture, size of flames, and point of flashback. The larger the ports, the fewer the number needed and the lower the manufacturing cost of the burner. However, large ports produce long flames and flashback occurs at appreciable input rates, limiting the *minimum* input at which the burner can be operated. Small ports are restricted to low *maximum* inputs by flame blowoff but are less critical of percentage of primary air and reduce or eliminate occurrence of flashback. Port holes are drilled, and their sizes are designated as standard twist drill sizes. Deep ports give somewhat better flame stability than do shallow ports. Port depths of from $\frac{1}{8}$ to $\frac{3}{8}$ in. are generally satisfactory.

Maximum values of port size and heat input per square inch of port area recommended by the AGA for domestic and light-duty atmospheric industrial burners are summarized in Table 1. Burners designed in

⁴ See *AGA Bull.* 10 (1940).

conformance with these figures can be depended upon to produce their rated inputs with stable, nonluminous flames and freedom from flash-back down to acceptable minimum rates. The maximum input is seen to be *inversely* related to primary air, as required by the shape of the *blowoff* curve of Fig. 6. However, the input value at which CO appears *increases* with primary air, and these two factors set the actual peak input of a burner.

TABLE 1.—DESIGN FACTORS FOR GENERAL APPLICATIONS OF SMALL-PORT ATMOSPHERIC GAS BURNERS (Conforms to AGA Bulletin 10)

	Type of gas		
	Manufactured	Natural	Propane-butane
Typical Btu/cu ft, 60°.....	540	1025	3000
Theoretical cu ft air/1000 Btu.....	8.6	9.4	9.2
Usual line pressure, in. H ₂ O.....	3.5	7.0	11.0
Maximum port sizes:			
Drill No.....	38	30	32
Diameter, in.....	0.1015	0.1285	0.1160
Ports per sq in.....	124	77	94
Max input, Btu/(hr) (sq in.) of port area: ^a			
40% primary air.....	52,000	31,000	Yellow flame
55% primary air.....	30,000	18,000	21,000
70% primary air.....	19,000	12,000	13,000
Optimum primary air:			
Range-top, %.....	55-60	55-60	55-60
Radiant space heaters.....	65-75	65-75	70-80
Ovens, boilers, etc. ^b	35-40	40-45	55-65
Max input limited by.....	Low air inspira- tion	Blowoff	Yellow flame or blowoff
Port spacing (all gases):			
Ports on straight lines.....		¼-⅜ in.	
Ports on radii of circles.....		⅝ ₂ -¼ in.	
(Between limits, spacings increase with port size and with radii of circles.)			

^a Max inputs using proper orifice with regulated gas-line pressure.

^b Applications with adequate headroom to avoid flame impingement. Secondary air opening, 1 sq in. per (5000 Btu)/(hr).

In applications where flame impingement need not be considered and high turndown is not required, inputs twice those of Table 1 may be obtained by the use of larger ports on about the same port spacing. The flames then partly impinge on each other, and this effect greatly increases the input at which blowoff occurs.

A *universal burner*, which will perform satisfactorily on manufactured gas, natural gas, and their mixtures (mixed gas), is designed with port

size suitable for manufactured gas and with total port area based upon the maximum input rate for natural gas.

Pressure Loss through Ports. The pressure drop through the burner ports is measured by the pressure inside the burner head when in operation. (It is seldom necessary to know head pressure for design of domestic burners since the peak head pressure is limited by the specifications in Table 1 and is related to the available gas pressure. Gas-line pressures generally used in city distribution systems are $3\frac{1}{2}$, 6, 7, and 11 in. H_2O for manufactured, mixed, natural, and liquefied hydrocarbon types of fuels, respectively. These are more than adequate for atmospheric burners.) In cases of special design and high-duty burners, burner-head pressures may become higher than the gas pressure can develop. The method of calculating burner-head pressure follows:

Assume that the burner port behaves as a sharp-edged orifice. Equation (3) then applies.

$$V_2^2 - V_1^2 = 2gc^2(H_1 - H_2)$$

Velocity inside the head is so much smaller than through the port that V_1 may be neglected in comparison to V_2 . Taking H_2 at barometric pressure as the datum, H_1 becomes the head pressure as *feet of air-gas mixture*:

$$H = \frac{V^2}{2gc^2} \quad (3a)$$

Head pressures are commonly expressed as inches of water. Letting ρ_m be the density of the gas mixture as pounds per cubic foot,

$$62.3 \left(\frac{H''}{12} \right) = H\rho_m$$

Values of c range from 0.6 to 0.8. Using the conservative value of 0.6 and substituting,

$$\text{Burner-head pressure as inches } H_2O = 0.0083(\rho_m)(V^2) \quad (5)$$

In Eq. (5) V is the linear velocity of gas mixture through the ports, in feet per second.

Burner Head and Manifold. The size and shape of the burner head are worked out to suit local conditions. Considerable latitude can be used in its design, hence only general guiding considerations can be given:

1. Provision must be made for access of sufficient secondary air to allow complete combustion at the ports. This is accomplished by suitable port arrangement; not more than two rows of ports should be included

in one tube or arm of a burner head without provision for secondary air admission between the rows. Raised ports (as in Fig. 5) are desirable. For burners consisting of a straight drilled tube, rows of ports should be separated by an *angle of at least 35°*.

No absolute rule can be made for port spacing. Many burners are constructed with the smaller ports spaced on $\frac{1}{4}$ -in. centers, and the larger sizes on $\frac{3}{8}$ -in. centers. In any case, the flame must travel from port to port when the burner is lighted.

Slots having widths two-thirds of the maximum port diameters may be used instead of port holes, but the slots should be made at least $\frac{1}{2}$ in. deep. Slots may be either straight or circular. A circular or annular-slot burner is shown in Fig. 7.

2. The cross section of the manifold should taper off toward the closed end so as to provide uniform pressure to all ports. Satisfactory gas distribution is obtained if the taper is such that the manifold cross section at any point has an area two or three times the area of the ports remaining to be fed.

Mixing Tube, Bell, and Shutter. The important considerations are noted on Fig. 5.

1. The mixing tube should be constructed in the shape of a venturi, with throat area 40 to 45 per cent of the port area. A length of six throat diameters from throat to burner head assures good mixing of gas and air. It is customary to manufacture the downstream section enlarging by a total angle of 4° , but a larger angle is satisfactory.

2. The gas orifice should be placed one to two throat diameters from the throat and should be accurately centered on the mixing-tube axis.

3. To maintain a negligibly small friction loss through the shutter, its total opening should be at least $1\frac{1}{4}$ times the port area and preferably two times the port area for burners using manufactured gas, so that the velocity of air through the shutter is always less than 5 ft/sec. Bell diameter is determined by this consideration. It is desirable that the interior surface of the whole tube be rather smooth, particularly the throat and bell sections. Burner castings should be inspected for metal beads or burrs left by imperfect molding cores.

When a burner is mounted in a firebox, an opening to admit secondary air must be provided. The AGA recommends 1 sq in. of secondary air opening per 5000 Btu/hr for domestic appliances.

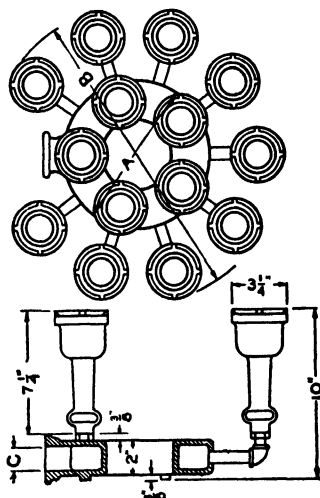
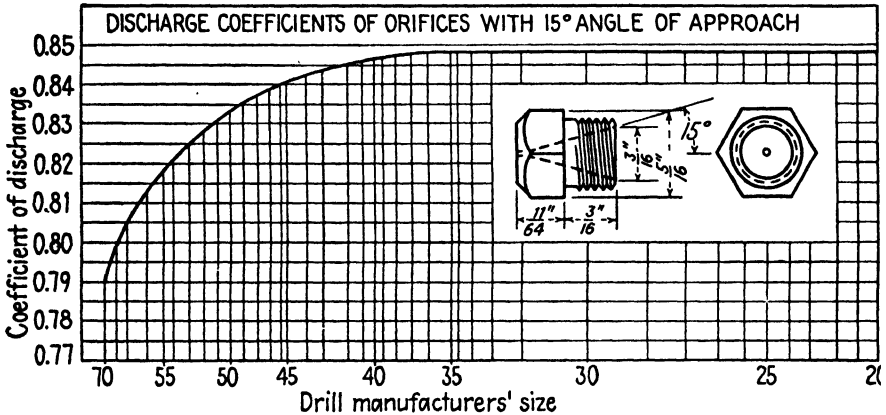

FIG. 7.—An annular-slot burner arrangement. (Courtesy of Webster Engineering Company.)

Gas Orifice. The size of orifice or spud is selected or adjusted so as to deliver gas at the rated capacity of the burner at full-line pressure with the valve wide open.



(Courtesy of American Gas Association.)

FIG. 8.

Equation (3) is used to calculate orifice size. The burner-head pressure (H_2) is so close to atmospheric and the velocity of approach (V_1) is so small that these quantities may be neglected in the calculation of gas flow. Solving for V_o , Eq. (3) becomes

$$V_o = c \sqrt{2gH_g} \tag{3b}$$

Now let q_o = cubic feet of gas per hour

S_o = orifice area, sq in.

ρ_g = gas density, lb/cu ft

Since V is in feet per second and H is in feet of gas,

$$V_o = \frac{(q_o)144}{3,600(S_o)} = 0.04 \frac{q_o}{S_o}$$

and

$$H_g = \left(\frac{62.3}{12}\right) \left(\frac{H''_w}{\rho_g}\right)$$

Equation (3b) becomes

$$\begin{aligned} q_o &= \left(\frac{3600}{144}\right) c S_o \sqrt{\frac{(64.3)(62.3)}{12} \left(\frac{H''_w}{\rho_g}\right)} \\ &= 457 c S_o \sqrt{\frac{H''_w}{\rho_g}} \end{aligned} \tag{6}$$

If the gas density is expressed as *gas gravity* G (density relative to dry air at 60°F and 1 atm) and a discharge coefficient of 0.78 is chosen, Eq. (6)

becomes

$$q_o = 1300S_o \sqrt{\frac{H_w''}{G}} \quad (6a)$$

which is sufficiently accurate for many purposes.

Considerations of orifice design are its discharge coefficient, injection efficiency, and ease of manufacture. The design that produces the highest discharge coefficient does not require so high a gas-line pressure as is otherwise necessary, but such an orifice is expensive to manufacture.

Efficient practical designs are shown in Figs. 8 and 9. The orifice hole is drilled and should have a depth not much greater than half its diameter. The approach section affects the discharge characteristics. An angle of approach of 15° between the wall and the axis as in Fig. 8 has a high discharge coefficient. A 60° angle of approach as shown in Fig. 9 gives a slightly lower coefficient but has the advantage that it can be counterbored to this angle with an ordinary twist drill. Orifices are designated by standard twist drill sizes (see Table 2).

DISCHARGE COEFFICIENT OF ORIFICES
WITH 60° ANGLE OF APPROACH

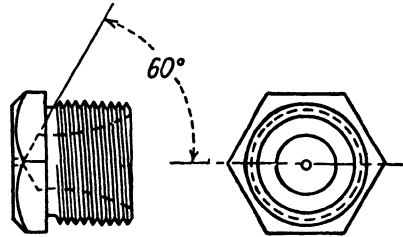

TWIST DRILL SIZE NO. 20 TO NO. 51
DISCHARGE COEFFICIENT=0.801

FIG. 9. (Courtesy of American Gas Association.)

Orifices are designated by standard

Adjustable orifices are widely used in domestic appliances. An adjustable orifice consists of a screwed needle mounted in a threaded hood. The hood is very similar to a fixed orifice or spud. The adjustment of gas opening is made by turning the needle, which forms a small annular orifice with the hood. An adjustable orifice is set when the burner is installed and with the adjustment feature, it can be used over wider ranges of gas heating values and line pressures than is possible with a single fixed orifice. The discharge coefficient (c) of an adjustable orifice is lower than that of a fixed orifice or spud and is usually between 0.6 and 0.7.

Gas-line Pressure and Air Inspiration. A necessary condition for the operation of all atmospheric burners is that the energy of the gas issuing from the orifice be sufficient to inspire as high a percentage of primary air as is needed. The energy available from the gas stream depends upon the gas-line pressure. As noted earlier, the gas-line pressures in general use are adequate to inspire sufficient air in well-designed domestic and low-duty industrial burners at input rates and port velocities not greatly exceeding the values given in Table 1. High-duty burners require higher gas pressures.

TABLE 2.—STANDARD TWIST DRILL SIZES

Designation	Diam. in.	Area, sq in.	Designation	Diam. in.	Area, sq in.	Designation	Diam. in.	Area, sq in.
$\frac{1}{8}$	0.5000	0.1963	3	0.213	0.03563	$\frac{3}{32}$	0.0938	0.00690
$\frac{1}{16}$	0.4844	0.1843	4	0.209	0.03431	42	0.0935	0.00687
$\frac{1}{32}$	0.4688	0.1726	5	0.2055	0.03317	43	0.0890	0.00622
$\frac{3}{64}$	0.4531	0.1613	6	0.204	0.03269	44	0.0869	0.00581
$\frac{1}{16}$	0.4375	0.1503	$\frac{1}{8}$	0.2031	0.03241	45	0.0820	0.00528
$\frac{3}{64}$	0.4219	0.1398	7	0.201	0.03173	46	0.0810	0.00515
Z	0.413	0.1340	8	0.199	0.03110	47	0.0785	0.00484
$\frac{1}{32}$	0.4063	0.1296	9	0.196	0.03017	$\frac{5}{16}$	0.0781	0.00479
Y	0.404	0.1282	10	0.1935	0.02940	48	0.0760	0.00454
X	0.397	0.1238	11	0.191	0.02865	49	0.0730	0.00419
$\frac{3}{64}$	0.3906	0.1198	12	0.189	0.02806	50	0.0700	0.00385
W	0.386	0.1170	$\frac{3}{16}$	0.1875	0.02761	51	0.0670	0.00353
V	0.377	0.1116	13	0.185	0.02688	52	0.0635	0.00317
$\frac{1}{8}$	0.375	0.1104	14	0.182	0.02602	$\frac{1}{4}$	0.0625	0.00307
U	0.368	0.1064	15	0.1800	0.02545	53	0.0595	0.00278
$\frac{3}{64}$	0.3594	0.1014	16	0.1770	0.02461	54	0.0550	0.00238
T	0.358	0.1006	17	0.1730	0.02351	55	0.0520	0.00212
S	0.348	0.09511	$\frac{1}{8}$	0.1719	0.02320	$\frac{3}{16}$	0.0473	0.00173
$\frac{1}{32}$	0.3438	0.09281	18	0.1695	0.02256	56	0.0465	0.001698
R	0.339	0.09026	19	0.1660	0.02164	57	0.0430	0.001452
Q	0.332	0.08657	20	0.1610	0.02036	58	0.0420	0.001385
$\frac{1}{16}$	0.3281	0.08456	21	0.1590	0.01986	59	0.0410	0.001320
P	0.323	0.08194	22	0.1570	0.01936	60	0.0400	0.001257
O	0.316	0.07843	$\frac{3}{32}$	0.1563	0.01917	61	0.039	0.001195
$\frac{1}{16}$	0.3125	0.07670	23	0.1540	0.01863	62	0.038	0.001134
N	0.302	0.07163	24	0.1520	0.01815	63	0.037	0.001075
$\frac{1}{32}$	0.2969	0.06922	25	0.1495	0.01755	64	0.036	0.001018
M	0.295	0.06835	26	0.1470	0.01697	65	0.035	0.000962
L	0.29	0.06605	27	0.1440	0.01629	66	0.033	0.000855
$\frac{1}{16}$	0.2813	0.06213	$\frac{1}{8}$	0.1406	0.01553	67	0.032	0.000804
K	0.281	0.06202	28	0.1405	0.01549	$\frac{1}{32}$	0.0313	0.000765
J	0.277	0.06026	29	0.1360	0.01453	68	0.031	0.000755
I	0.272	0.05811	30	0.1285	0.01296	69	0.0292	0.000670
H	0.266	0.05557	$\frac{1}{8}$	0.1250	0.01227	70	0.028	0.000616
$\frac{1}{32}$	0.2656	0.05542	31	0.1200	0.01131	71	0.026	0.000531
G	0.261	0.05350	32	0.1160	0.01057	72	0.025	0.000491
F	0.257	0.05187	33	0.1130	0.01003	73	0.024	0.000452
$E\frac{1}{2}$	0.2500	0.04909	34	0.1110	0.00968	74	0.0225	0.000398
D	0.246	0.04753	35	0.1100	0.00950	75	0.021	0.000346
C	0.242	0.04600	$\frac{3}{16}$	0.1094	0.00940	76	0.020	0.000314
B	0.238	0.04449	36	0.1065	0.00891	77	0.018	0.000254
$\frac{1}{16}$	0.2344	0.04314	37	0.1040	0.00849	78	0.016	0.000201
A	0.234	0.04301	38	0.1015	0.00809	$\frac{1}{8}$	0.0156	0.000191
1	0.228	0.04083	39	0.0995	0.00778	79	0.0145	0.000165
2	0.221	0.03836	40	0.0980	0.00754	80	0.0135	0.000143
$\frac{1}{32}$	0.2188	0.03758	41	0.0960	0.00724			

NOTE—Designations are in fractions of an inch, in standard twist drill letters, or in standard twist drill numbers, the letter being the same as steel wire gauge numbers. (Courtesy of AGA.)

Several different methods have been proposed for predetermining the maximum amount of primary air that a burner will inspire, in terms of gas-line pressure and burner design factors. So many variables are involved in the problem and the theory of the injector (or burner inspirator) is so imperfectly understood that no simple and accurate method of calculation has been developed. However, certain guiding factors permit a conservative value of primary air or of minimum gas-line pressure to be predicted. A conservative value, although inaccurate, is safe for design purposes.

Equation (4) does not apply to actual burners because fluid friction is high as compared to fluid energy. The method given in the following paragraphs was developed by the Bureau of Standards.⁵ Granted that the "normal inspiration" curve of Fig. 6 is typical, it is seen that the percentage of primary air inspired is fairly constant with respect to input at the high-input end. When the percentage of primary air is constant over a range of rates, the ratio of *fluid momentum* at any two cross sections of a burner must also be constant. Algebraically,

$$\frac{W_1 V_1}{W_2 V_2} = \text{a constant}$$

Applying this relation between ports and orifice of a burner,*

$$\frac{W_p V_p}{W_o V_o} = k \quad (7)$$

W_o and V_o can be expressed in terms of orifice size and gas pressure. W_p and V_p at a given gas rate can be expressed in terms of port area and percentage of primary air. Equation (7) relates these quantities to k , the *burner momentum constant*.

By the use of Eqs. (3a) (3b), (6a), and (7) with a conservative value of k , the inspiring capacity of a burner (as percentage of primary air) can be calculated for a definite gas-line pressure. Conversely, an adequate minimum gas-line pressure can be calculated that will inspire any chosen or required percentage of primary air. In general, burners should be designed to inspire at least 70 per cent of primary air whether they are to be so operated or not. Yellow flames appear at percentages of primary air less than about 40 per cent on manufactured and natural gases, and at less than about 55 per cent on liquefied hydrocarbon gases.

The *burner momentum constant* is influenced by all the variables of burner design and operation. Present knowledge of the relation between

⁵ *Nat. Bur. Standards Circ.*, 394 (1931).

* Equation (7) is actually a convenient but empirical method of accounting for fluid friction losses in a burner.

k and its various factors is summarized by the relation,

$$k = F_b F_s \sqrt{\frac{A_p G}{V_o}} \quad (8)$$

where F_b is a factor of burner design, F_s a factor for relative shutter position or opening, A_p the total port area, G the gas gravity, and V_o the linear velocity of the gas as it issues from the orifice.

F_b can only be evaluated from experimental data. It is an inverse function of friction loss in the entire burner tube and so is affected by the roughness of the passages. For burners otherwise identical, F_b is supposedly the same for burners of different sizes but having the same geometrical proportions when compared at proportional mixture velocities.

F_s depends upon the air shutter setting. In burners having total shutter areas two or more times the port areas, F_s is equal to unity or is not a variable and is not affected by partial closing of the shutter until the resistance to air flow through the actual opening becomes appreciable. k is slightly affected when the actual shutter opening is about 150 per cent of the port area. At smaller openings only, k decreases approximately as the square root of the actual opening. Eq. (8) is not valid for very low shutter openings or for closed shutters. As may be seen from Eq. (7) for closed shutters or no primary air, $W_p = W_o$ and

$$k = \frac{V_p}{V_o} = \frac{S_o}{A_p}$$

At very low gas velocities, k actually approaches zero. With increasing gas pressure or input through a fixed orifice, k increases slowly to a maximum and again slopes off. The maximum "open shutter" primary air is usually higher than necessary, and its peak value may also occur at an input higher than allowable in domestic burners.

Values of k for well-designed burners when normal conditions of installation and operation prevail are usually between 0.3 and 1.0. For these conditions, it is safe to assume $k = 0.3$ to calculate maximum primary air or minimum gas-line pressure. Equation (8) is useful for predicting the effects of altering the port area, the gravity of the gas, the orifice size, and the gas pressure. The factor ($F_b F_s$) must be evaluated beforehand from burner performance data under known conditions.

The maximum heat inputs per square inch of port area in terms of percentage of primary air given in Table 1 correspond to definite maximum velocities of the primary mixture through the burner ports, for the

typical fuel gases. These maximum-input port velocities are given with satisfactory accuracy by the empirical relations:

Maximum port velocity for manufactured gas:

$$V_p = 16.8 - 15.7(\text{per cent primary air}/100) \quad (9)$$

Maximum port velocity for natural and liquefied hydrocarbon gases:

$$V_p = 7.25 - 5.2(\text{per cent primary air}/100) \quad (10)$$

Velocities given by Eqs. (9) and (10) are calculated as for a temperature of 60°F and 1 atm, with V_p in feet per second.

Burner tests should be made with the burner actually installed and lighted. Sufficient time should be allowed for the burner to attain its maximum operating temperature before test data are taken. (Inspiration and flame characteristics are somewhat different for hot than for cold burners, and pressure and flow characteristics are likewise different for burners in actual operation than for unlighted burners.)

The foregoing relations were developed primarily for use in connection with domestic and other low-duty burners. However, the same principles apply to the design of high-duty burners using gas at pressures up to 3 psig or thereabouts. In the design of such burners, allowance must be made for the higher rates employed and for the variations in gas volumes occurring with changes in pressure.

Illustration

An atmospheric burner with a capacity of 20,000 Btu/hr is to be designed for a water heater. It is to be operable on either 1025 Btu natural gas or 550 Btu manufactured gas with proper orifices. The gravity of both gases is approximately 0.6.

Determine

- Size and number of ports.
- Minimum gas-line pressures.
- Orifice drill sizes for 7 in. H₂O natural-gas line pressure and 3½ in. H₂O manufactured-gas line pressure.
- Throat size, minimum length, and maximum diameter of the mixing tube.

Solution: This is to be a universal burner, but high turndown is not required for a water heater. The maximum port size for manufactured gas and port area based on the maximum input for natural gas will give satisfactory performance.

a. Referring to Table 1, the port size is No. 38 drill, requiring 124 ports per square inch of port area.

The port area will be based upon maximum input for natural gas with 45 per cent primary air. Since 9.4 cu ft of theoretical air are required to generate 1000 Btu, the volume of the primary mixture is

$$\frac{20,000}{1025} + (0.45) \left(\frac{20,000}{1000} \right) (9.4) = 104 \text{ cu ft/hr}$$

By Eq. (10) the maximum port velocity for this mixture is

$$7.25 - 5.2(0.45) = 4.9 \text{ ft/sec}$$

The port area is $\frac{(104)(144)}{(3600)(4.9)} = 0.85$ sq in. and the required number of ports is $(124)(0.85) = 106$. *Ans.*

b. Minimum line pressure for the natural gas. From Eq. (18) of Chap. V,

$$\text{Theoretical cu ft air/cu ft gas} = \frac{\text{Btu/cu ft}}{96} - 1 = 9.7$$

The weight ratio of burner mixture to fuel is

$$\frac{W_p}{W_o} = \frac{0.6 + (9.7)(0.45)}{0.6} = 8.3$$

Using the safe value 0.3 for the burner momentum constant and rearranging Eq. (7), the orifice velocity required to inspire 45 per cent primary air is

$$V_o = \left(\frac{V_p}{k}\right) \left(\frac{W_p}{W_o}\right) = \left(\frac{4.9}{0.3}\right) (8.3) = 135 \text{ ft/sec}$$

Rearranging Eq. (3b) with a discharge coefficient of 0.8, the minimum head of gas is

$$H_o = \frac{V^2}{2gc^2} = \frac{(135)^2}{(64.3)(0.64)} = 442 \text{ ft}$$

The gas density at 60°F and 1 atm is

$$\rho_g = \frac{(0.6)(29)}{356} \left(\frac{492}{520}\right) = 0.0462 \text{ lb/cu ft}$$

The minimum line pressure for the natural gas is then

$$\frac{12}{62.3} H_o \rho_g = \left(\frac{12}{62.3}\right) (442)(0.0462) = 3.93 \text{ in. } H_2O. \text{ } \textit{Ans.}$$

Operation on manufactured gas will be satisfactory using 40 per cent primary air. By similar calculations, the mixture volume is 105 cu ft/hr, the required orifice velocity is 68.5 ft/sec and the minimum line pressure is 1.0 in. H_2O . *Ans.*

c. Since the actual gas line pressures are higher than the minima, the orifice velocities will be higher and the sizes smaller. Applying Eq. (6a) to the natural gas under 7 in. pressure,

$$S_o = \left(\frac{20,000}{1,025}\right) \left(\frac{1}{1300 \sqrt{7/0.6}}\right) = 0.0044 \text{ sq in}$$

The next larger drill size is No. 48; 0.00454 sq in. and this should be used. Similarly, the calculated orifice size for manufactured gas is 0.0116 sq in. and the next larger drill is $\frac{1}{8}$; 0.01227 sq in. *Ans.*

d. The throat area of the mixing tube should have about 45 per cent of the port area, whence its diameter is

$$\sqrt{(4)(0.45)(0.85)/\pi} = 0.7 \text{ in.}$$

The minimum mixing length of six throat diameters is 4.2 in., and the maximum tube diameter for a cross section three times the port area is

$$\sqrt{(4)(3)(0.85)/\pi} = 1.8 \text{ in.}$$

LARGE-PORT BURNERS

Large industrial furnaces and heaters, particularly those which operate at extremely high temperatures, require a more compact heat source than is used for small applications in which an atmospheric burner is placed close to the heat-absorbing surface.

High-density heat generation requires higher gas pressures, compressed air, or both. High-pressure gas is obviously capable of inspi-

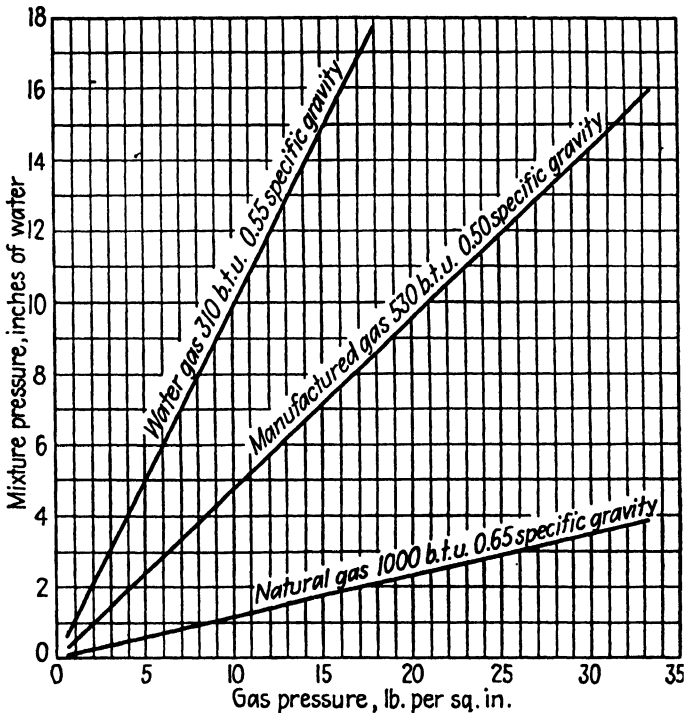

FIG. 10.—Mixture pressures obtainable with various types of fuel gases in high-pressure inspirators. (Courtesy of American Gas Association.)

rating a high percentage of primary air, frequently all that is needed. Available gas line pressure is often adequate but, if not, it is usually most convenient and economical to compress the gas rather than to blow in the air, since there are many designs of high-duty commercial burners to choose from (Fig. 10).

The range of gas pressures which includes the requirements of most burners is 1 to 25 *psig*. Port velocities are often much higher than in the smaller atmospheric types since higher head pressures are developed. However, the primary air must be more closely controlled. A single-stage inspirator of the same general design as the small-port burners

is common (Fig. 11). For thorough mixing of gas and air in a short length and a more constant air-gas ratio, the two-stage inspirator of Fig. 12 is used on high-pressure gas lines. To avoid flame blowoff from large ports, the by-pass arrangement of Fig. 13 provides a low-velocity

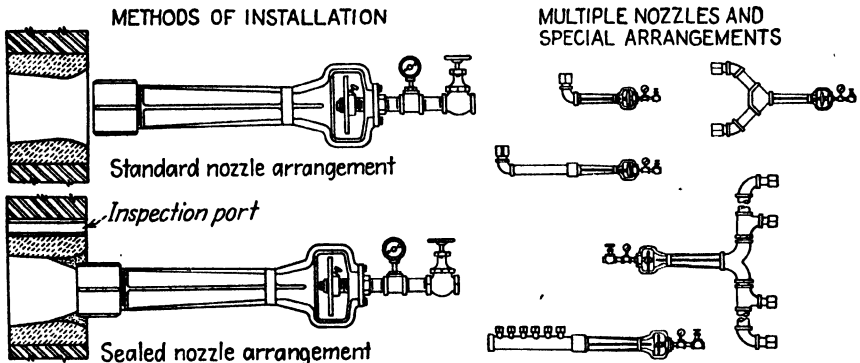

FIG. 11.—Mountings and arrangements of large-port burners. (Courtesy of Webster Engineering Company.)

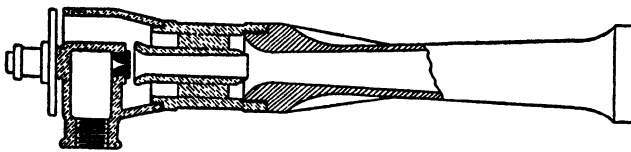

FIG. 12.—Two-stage inspirator. (Courtesy of American Gas Association.)

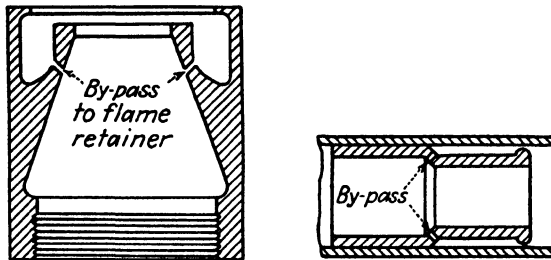

FIG. 13.—Burner nozzles with flame-retaining modifications. (Courtesy of American Gas Association.)

gas layer surrounding the main stream. Figures 14 and 15 illustrate typical installations. A pilot burner is helpful in lighting the main burners and is also a safety precaution in case anything should disturb the flame of the main burner. Port- or nozzle-mixing burners require air under pressure, as from a blower. However, since combustion starts at the point of mixing, flashback cannot occur (Fig. 16).

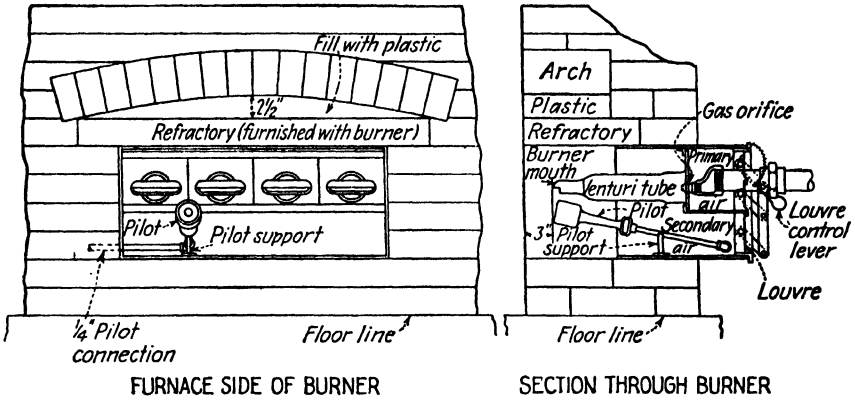

FIG. 14.—A large-port burner installation. (Courtesy of Webster Engineering Company.)

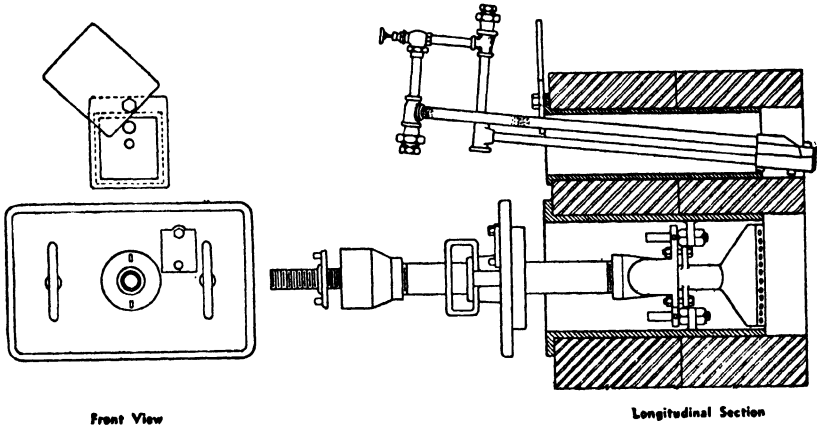

FIG. 15.—An industrial small-port burner installation. (Courtesy of Webster Engineering Company.)

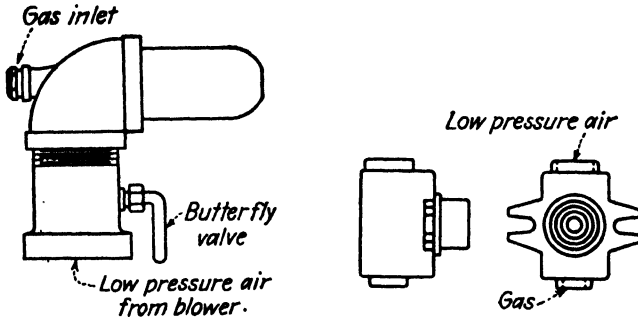

FIG. 16.—Nozzle-mixing burners. (Courtesy of American Gas Association.)

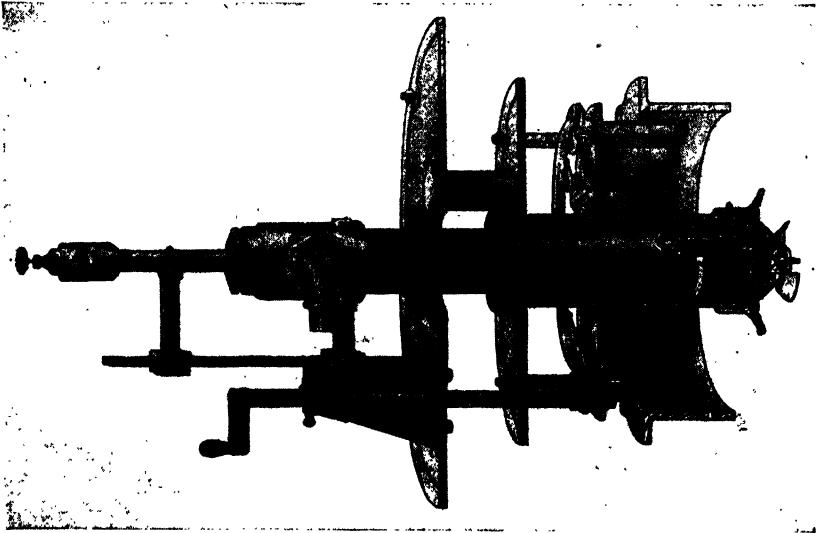

FIG. 17.—Sectional view of a gun-type combination burner (gas and oil). (Courtesy of Webster Engineering Company.)

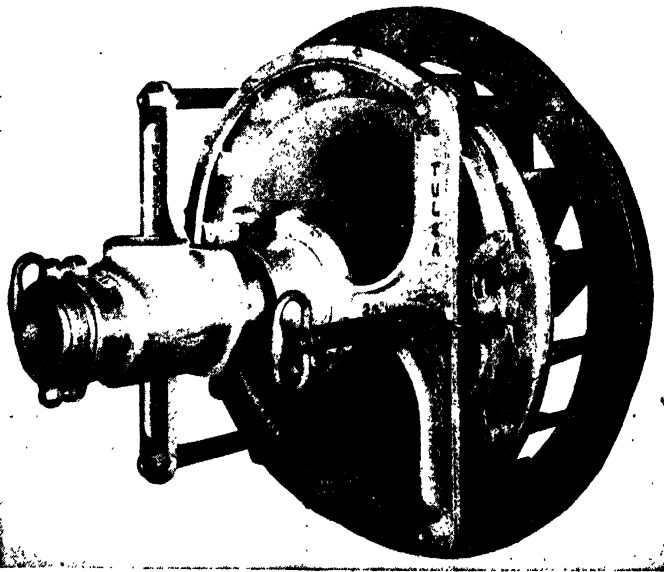

FIG. 18.—Gun-type burner showing air louver and adjustment features. (Courtesy of Webster Engineering Company.)

The gun-type burner is very common in the petroleum industry. It is usually mounted in a circular wall opening or thimble. Since the

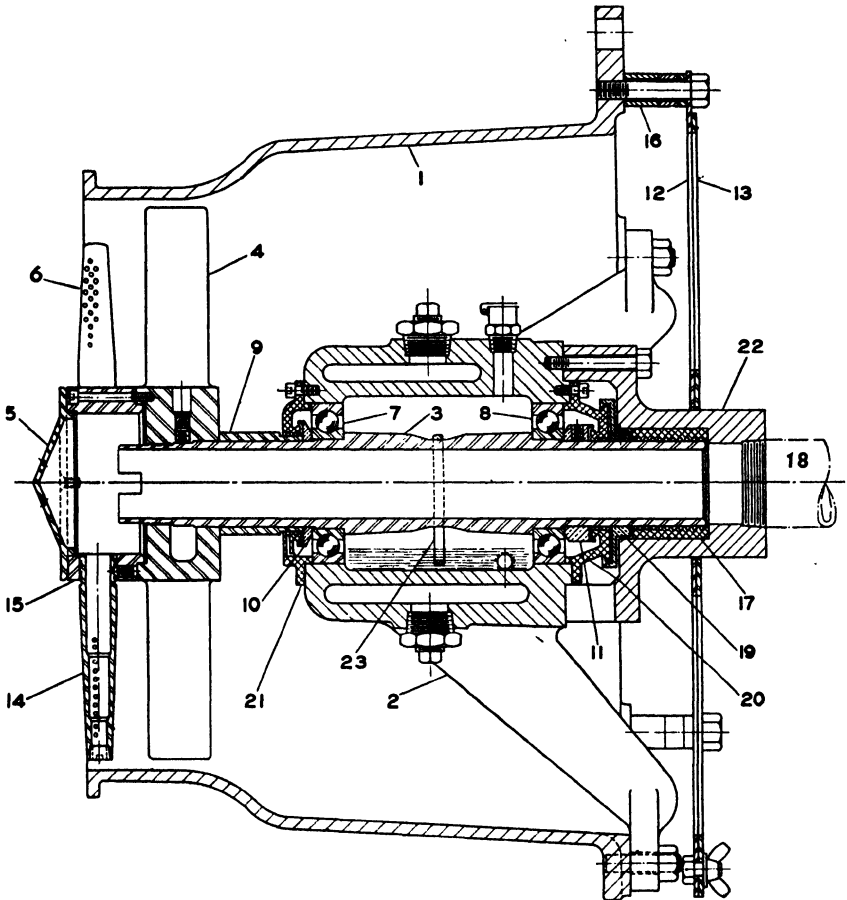

FIG. 19.—FANMIX Burner. (Courtesy of Coppus Engineering Company.)

- | | |
|-----------------------|-----------------------|
| 1. Casing | 13. Shutter slide |
| 2. Bracket | 14. Driver arm |
| 3. Shaft | 15. Driver hub |
| 4. Fan | 16. Spacer |
| 5. Nose plate | 17. Labyrinth bushing |
| 6. Gas orifices | 18. Gas line |
| 7. Front ball bearing | 19. Deflector |
| 8. Rear ball bearing | 20. Rear enclosure |
| 9. Shaft sleeve | 21. Front enclosure |
| 10. Front oil finger | 22. Inlet housing |
| 11. Rear oil finger | 23. Oil ring |
| 12. Shutter frame | |

firebox of a petroleum tubestill heater is comparatively large, a long flame can be tolerated and only 25 to 30 per cent of primary air is needed. The secondary air supply is regulated by an adjustable shutter and by the

position of the gun tip. The gun can be moved back and forth, and the distance of the tip from the plane of the inner wall controls to some extent the inspiration of secondary air. Some guns have more than one gas nozzle in order to handle gases of high and low heating values. Most burners of this general design are combination gas and oil burners. Those shown in Figs. 17 and 18 are typical; the steam-atomizing oil gun is constructed of a $\frac{3}{8}$ -in.-diameter oil pipe inside a 1-in.-diameter steam pipe, both connecting with the oil nozzle. This small oil gun slips into the gas gun which is constructed of $2\frac{1}{2}$ - and $3\frac{1}{2}$ -in.-diameter pipe, gas nozzle, and diffuser. The guns are mounted in a 5-in.-diameter guide tube. Each gun can be readily adjusted and removed.

The FANMIX rotating burner shown in Fig. 19 is a recent development. Gas issuing from jets drilled at an angle in the rotating spider causes it to spin and the fan connected to it to draw in air at a constant ratio that can be adjusted by regulation of the air shutter. Thorough mixing of gas and air is obtained, and very little excess air is needed.

Single gas-burner units are available which generate 50 million Btu/hr and more. Most burners are adaptable to rather wide ranges of capacity, gas pressure, and gas heating value merely by changing orifice sizes and shutter openings.

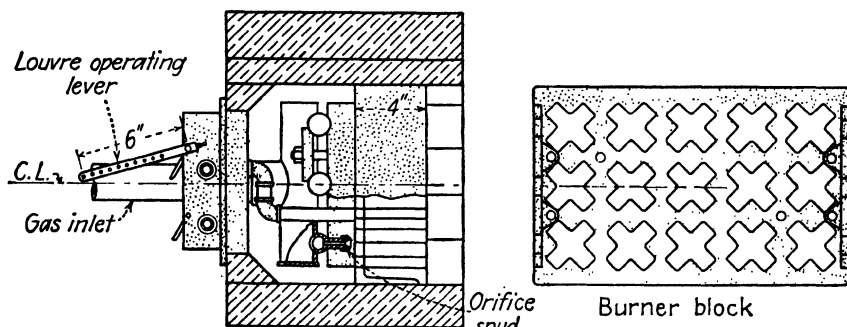

FIG. 20.—Tile-port burner for rectangular opening. (Courtesy of Webster Engineering Company.)

TILE-PORT BURNERS

The effect of hot surfaces in promoting combustion is utilized in radiant-type burners. The presence of a tile or radiant port results in a shorter flame and general improvement of burner performance. It frequently allows an increase in furnace capacity also (Figs. 20 to 22).

Figure 23 is a conversion burner for firing boilers with gas that were designed for burning coal or oil.

The kiln burner shown in Fig. 24 illustrates a special type that furnishes a high but uniform temperature over a considerable space

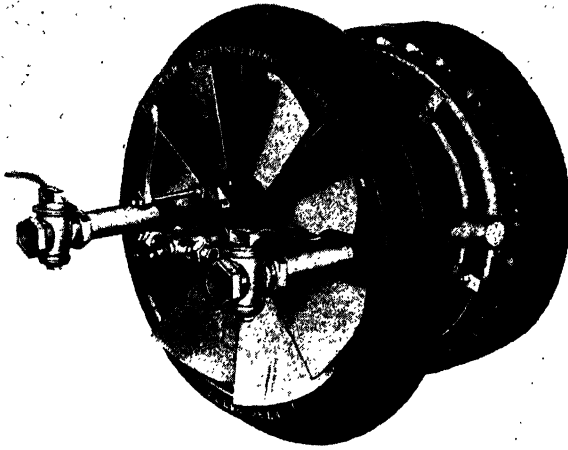

FIG. 21.—Tile-port burner for circular opening. (Courtesy of Webster Engineering Company.)

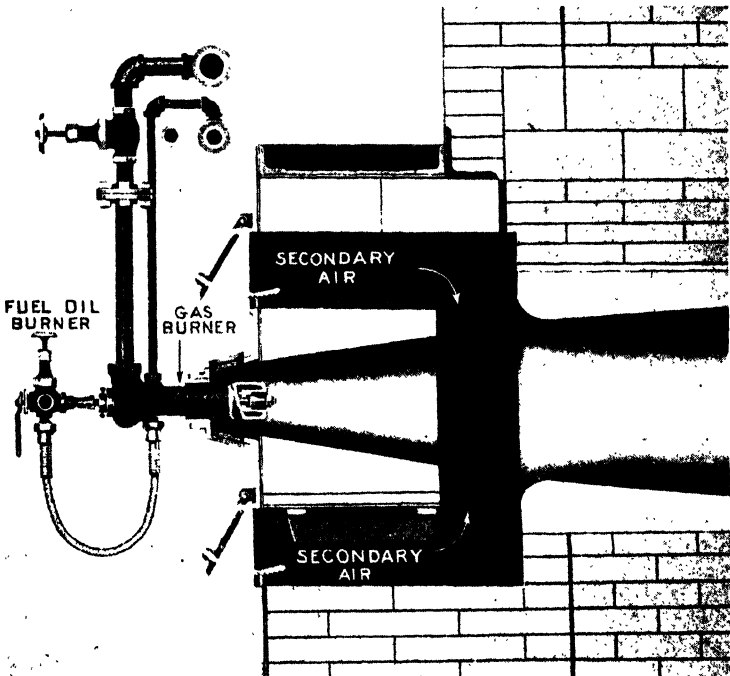

FIG. 22.—Combination burner in tile mounting. (Courtesy of National Airoil Burner Company.)

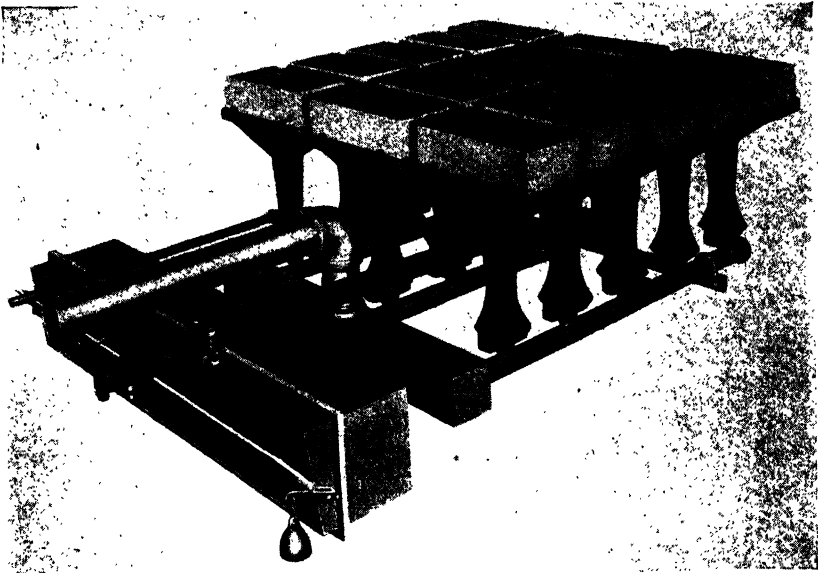

FIG. 23.—Conversion burner for small boilers. (Courtesy of Webster Engineering Company.)

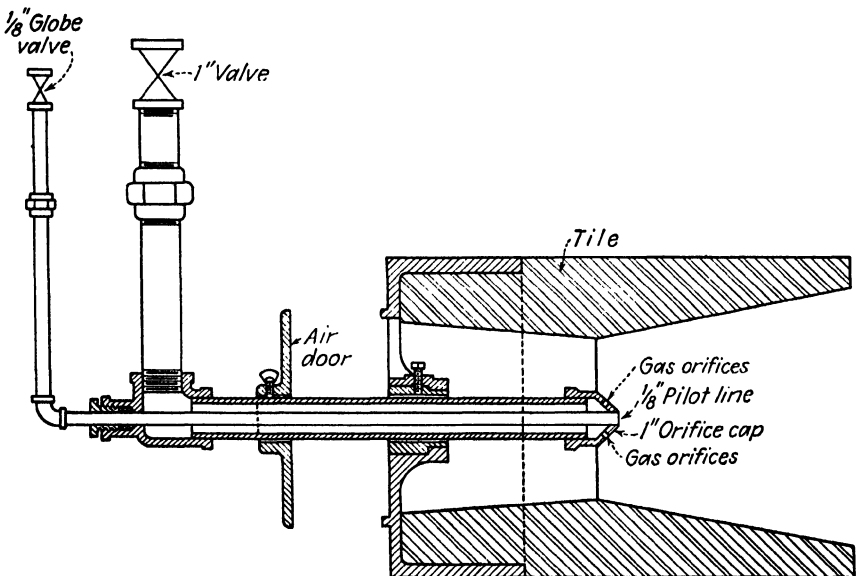

FIG. 24.—Kiln burner.

without local overheating. Primary air mixes with gas in the tile, which thereby serves as both mixing tube and port. The tile heats to incandescence, and the burner cannot be operated at full capacity until it has become so heated.

As seen from the illustrations, large-port burners are frequently mounted with the port terminating in a refractory ring or block made for the purpose. The tile must not fuse or soften appreciably at 3000°F.

High-temperature furnaces are sometimes fired with gas *premixed with all of the air*. The interior wall or lining of such furnaces is a refractory that heats to incandescence, and flame may not even be visible at

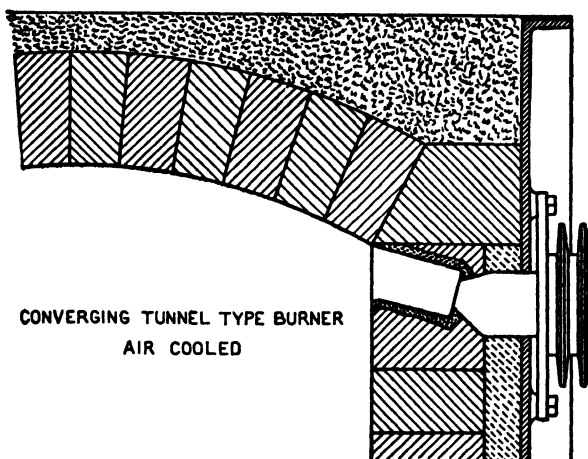

FIG. 25.—(Courtesy of Surface Combustion Company.)

the burner port. Velocity of the gas in the line must be high enough to prevent flashback (Fig. 25).

GAS-BURNER APPLICATIONS

Fuel gas is suitable for most heating and furnacing applications, but cost and unavailability prevent it from becoming the universal fuel. Most gas-burner installations are for domestic heating and cooking, small boilers occupying second place. Gas is fired in larger industrial furnaces when some special requirement or condition exists, such as an unusually high or uniform furnace temperature, a controlled furnace atmosphere, or a favorable price situation (as occurs in natural-gas-producing areas) (see Chaps. XIII, XIV, XVI).

The convenience of gas burners has resulted in numberless small applications where clean, easily controllable heat is needed. Many such burners are individual in shape and construction. For example, liquids contained in a pot or kettle may be efficiently heated with a *submerged-tube burner* consisting of a straight or looped tube immersed in the liquid

except at the ends. The head end contains the burner proper. The hot combustion gases pass inside the tube, transfer their heat through the tube wall, and issue from the open end of the tube.

Submerged Combustion. The evaporation of water solutions is difficult where salt or any other scale tends to deposit on the heat-transfer surface. Scaling trouble may be avoided for inorganic solutions (that are uninjured by contact with flame) by the use of a submerged-combustion burner.⁶ The burner is fired with gas premixed with all of the air for combustion.* Its design is such that it functions under water, releasing the combustion gases directly into the solution. In this case the combustion gases themselves provide the heat-transfer surface as they bubble up through the liquid and escape. The evaporating liquid remains at a temperature of about 90°C (194°F) and the gases leave at substantially the same temperature, saturated with water vapor.

Automatic Controls. The quick, easy regulation characteristic of gas burners makes them readily adaptable to automatic control. There are a number of types of control equipment actuated by changes of temperature, pressure, or rate of flow. Temperature and pressure controllers are very common. These are so reliable and inexpensive that their use is the rule rather than the exception in domestic heating plants as well as in industrial installations.⁷

Supplementary References

1. PERRY, J. H.: "Chemical Engineers' Handbook," 2d ed., pp. 2418-2430, McGraw-Hill Book Company, Inc., New York, 1941.
2. "Gas Engineers' Handbook," Sec. VIII, 5, Pacific Coast Gas Association, McGraw-Hill Book Company, Inc., New York, 1934.
3. TRINKS, W.: "Industrial Furnaces," 2d ed., Vol. II, Chap. 2, John Wiley & Sons, Inc., New York 1942.

Exercises

1. A 2.0-in. i.d. line carries a natural gas at 90°F (gravity = 0.6). An open-arm manometer connected to a static opening shows 10 in. H₂O and another open manometer connected to an impact tube at the center of the pipe shows 10.5 in. H₂O. Barometer is normal.
 - a. What is the linear velocity of the gas at the center of the pipe, as ft/sec?
 - b. If $V_{av} = 0.8V_{max}$, what is the rate of flow of gas as cu ft/min calculated as at 60°F and 14.4 psia?
 - c. What is the flow rate in lb/hr?
2. For the same gas, if the same manometer readings were obtained across a sharp-edged orifice 1.0 in. diam in the 2 in. line, what would be the flow rate as cu ft/min? The discharge coefficient (c) = 0.65.

⁶ KOBE, HAUGE, and CARLSON, *Ind. Eng. Chem.*, **28**, 589 (1936).

* Another type of submerged-combustion burner is oil-fired.

⁷ RHODES, T. J., "Industrial Instruments for Measurement and Control," McGraw-Hill Book Company, Inc., New York, 1941. ECKMAN, D. P., "Industrial Process Control," John Wiley & Sons, Inc., New York, 1945.

3. A venturi meter used to measure refinery gas (gravity = 1.0) in a standard 2-in. pipe has a throat 0.8 in. diam, and shows a differential pressure of 5.0 in. H_2O . The line pressure is 25 psig and the temperature is 120°F. What is the gas flow rate as lb/hr? ($c = 0.98$.)

4. It is desired to fire a small boiler with natural gas that is now being fired with manufactured gas. It has three burners, each having 96 ports $\frac{5}{32}$ in. diam. The maximum heat generation is 200,000 Btu/hr. The heating value of the natural gas is 1050 Btu/cu ft at 60°F, 30 in., and its gravity is 0.65.

- a. Can the present burner furnish the required input on the natural gas?
- b. What will be the minimum gas-line pressure for operation on natural gas?
- c. If a line pressure of 4 oz (6.93 in. H_2O) will be available, specify the proper size of orifices to install.

5. In a radiant type of large-port burner, a refractory tile shape performs the duty of both mixing tube and port. A spud or orifice is mounted behind each hole in the tile, the holes being $1\frac{3}{4}$ in. diam. A mixture velocity of 30 ft/sec is permissible through the tile openings (60°F.)

For operation on 1050 Btu gas (gravity = 0.65) with 80.0 per cent of the theoretical air inspired through the tile, calculate

- a. Number of openings for a unit that must generate 2.5 million Btu/hr.
- b. Minimum spud size for a gas-line pressure of 4 oz. $C = 0.7$.

CHAPTER X

OIL BURNERS

Most oil burners function by *atomizing* the oil, thus converting it into a fine spray approaching a mist in particle size, so that the droplets quickly vaporize as they burn and the combustion process is completed in a fraction of a second. There are, however, some burners that completely *vaporize* the oil before ignition.

Oil burners are conveniently classified according to the method of dispersing the oil: (1) vaporizing, (2) mechanical atomizing, (3) oil-pressure atomizing, (4) low-pressure air-atomizing, (5) high-pressure steam- or air-atomizing.

The choice of one of these classes for a particular installation depends upon quite a number of factors. The most important factors are grade of fuel to be used, size and shape of firebox, range of heat loads, desirability of automatic control, and installation and operating costs.

Vaporizing Burners. *Blowtorches* and *portable gasoline stoves* use straight-run naphtha as fuel. The fuel line is heated while the torch or stove is in use, and vaporization occurs in the line leading to a needle valve. The valve serves as an adjustable orifice. Enough pressure is maintained on the fuel tank so that the vapor issues from the orifice at high velocity and entrains primary air just as does a gas burner. The mixing tube and burner head are similar to those of inspiring gas burners with provision for keeping the burner heated.

The *sleeve-type burner* (used for domestic stoves and water heaters) vaporizes the fuel from an asbestos wick, burning the vapor in an annular space between two vertical concentric sheet iron cylinders or screens. The cylinders are perforated, allowing air to enter the annular space. Progressive burning with a blue flame occurs throughout the annular space.

An inexpensive type of domestic oil burner feeds oil into a metal pot where it vaporizes and burns. The pot is heated by contact with and radiation from the flame. Gravity feed controlled by a valve is commonly used. Vaporizing burners require light fuels which vaporize at temperatures below that at which appreciable thermal decomposition or cracking occurs. Nevertheless, carbon accumulates slowly even with fuels as light as kerosine, necessitating periodical cleaning of the wick or pot. Vaporizing burners are usually limited to straight-run fuels, whose end-point temperature is not higher than 660°F.

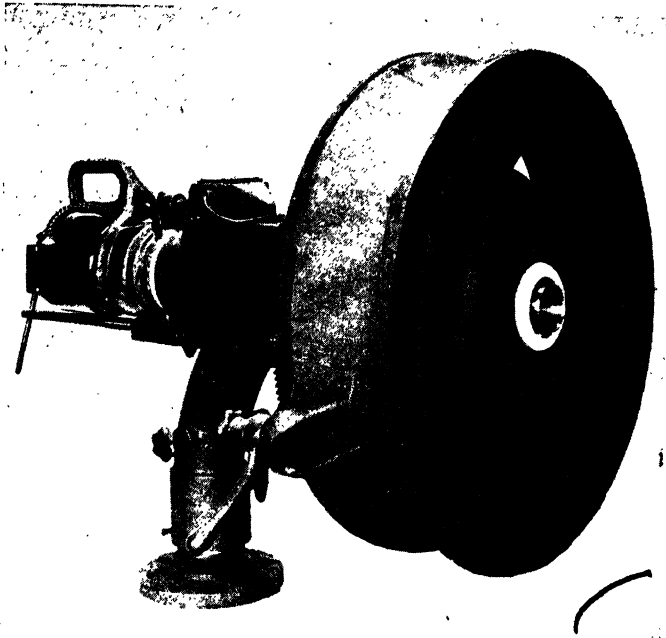

FIG. 1.—Horizontal rotary-cup burner. (Courtesy of W. N. Best Engineering Company.)

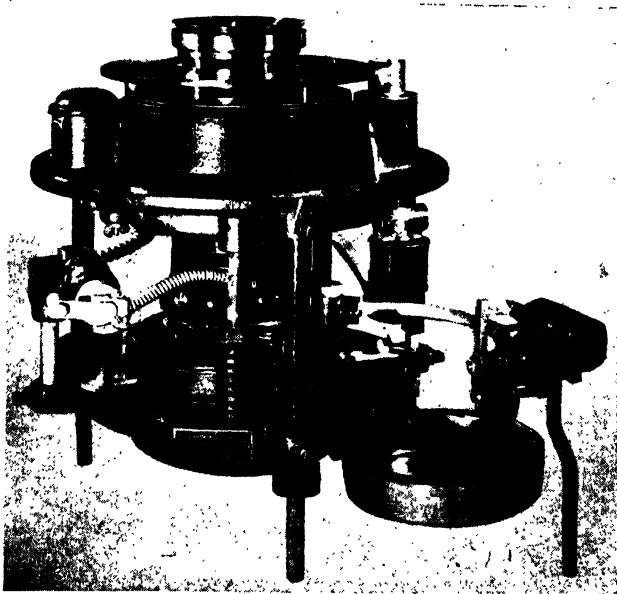

FIG. 2.—Vertical rotary-cup burner (domestic and light industrial use). (Courtesy of Automatic Burner Corporation.)

Mechanical Atomizing Burners. The most important class of mechanical atomizing burner is the rotary-cup type (Figs. 1 to 3). The cup is mounted axially on a hollow shaft and is spun by an electric motor or compressed-air turbine. The two most common rotational speeds are about 3,500 and 10,000 rpm. The oil is fed into the cup through the hollow shaft. The hole in the shaft is sometimes tapered with the bore larger toward the cup so that centrifugal force moves the oil along in-

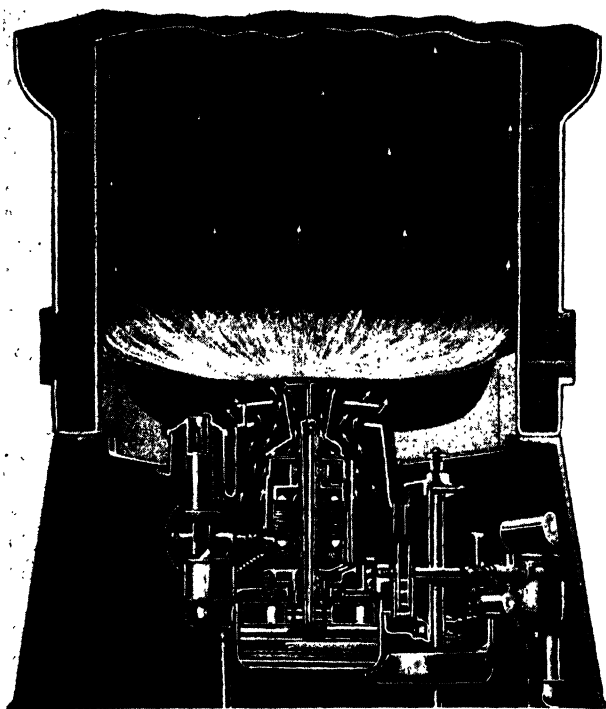

FIG. 3.—Vertical rotary-cup burner mounted in boiler. (Courtesy of Automatic Burner Corporation.)

side the shaft and into the bottom or back of the cup. Centrifugal force spreads the oil into a thin film on the inside wall of the cup. When the oil reaches the rim it is thrown out, dispersing into a fine spray. On the high-capacity horizontal types, distribution of the spray is completed by a blast of primary air issuing from the annular space between the rim of the cup and the stationary air nozzle that surrounds it. The shape of the flame is controlled by the angle of the inner walls of the cup and by the position of the air nozzle. Setting the nozzle back slightly changes the flame from long fan-like, to short bushy proportions.

Rotary-cup burners are available to handle any grade of fuel oil, in capacities up to 500 gph. The larger installations are mounted with the

cup horizontal, while some domestic and smaller industrial burners are mounted vertically. In the latter case, furnace draft is usually depended upon to supply all the necessary air. Rotary-cup burners have a very wide throttling range and require little attention.

There are several other designs of domestic mechanical atomizing burners which utilize centrifugal force to accomplish atomization. One popular burner in the small-capacity class atomizes the oil by sending both oil and primary air through a rotary pump. The vanes on the pump rotor effectively whip the oil into a fog.

Oil-pressure Atomizing Burners. Fluid under pressure when released through a small orifice tends to break into a spray. This principle is utilized by a larger number of burners.

Figure 4 shows the essential features of a burner spray nozzle. The oil must acquire a swirling motion *inside the nozzle* before it is released from the orifice in order to develop a satisfactory spray. This is ensured by diagonal grooves cut in a disk, through which the oil must pass. The nozzle of Fig. 4 is made only in small capacities with ratings between 1 and 10 gph. It requires distillate-grade fuel. However, high-capacity nozzles are also available with ratings up to 500 gph which will handle the heavier fuels.



FIG. 4.—Spray nozzle for light oils. (Courtesy of Monarch Manufacturing Works.)

Performance data are reported on nozzles of the type illustrated with oils having viscosities up to 100 Saybolt seconds at 100°F.¹ The minimum oil pressure for a fully developed spray is 75 psi. The spray takes the shape of a cone, whose angle is determined by both inside and outside angles of the orifice hole and to a lesser extent by oil viscosity. The shape of the back wall of the "swirl chamber," formed by the face of the grooved disk, is also important. A flat or protruding disk face produces a hollow cone of spray with little oil at the center, whereas a recessed disk gives a more evenly distributed or "solid" spray cone and better combustion. Nozzles are usually designed to produce a 60 to 80° angle on the spray configuration. About half of the oil pressure is lost in the swirl chamber, where it is largely converted into rotational, swirling energy.

The flow rate through a nozzle increases as the *square root* of the pressure. Doubling the pressure increases the rate only by about 40 per cent; hence this type of burner has only a narrow throttling range. Most of the installations are used for on-and-off operation and are provided with automatic controls. Ignition is accomplished by an electric spark,

¹ GLENDENNING, BLACK, VENTRES, and SULLIVAN, *Trans. ASME*, **61**, 373 (1939).

a gas pilot, or spark ignition with a temporary gas flame. In the latter, the gas burns several seconds and then is shut off automatically.

Low-pressure Air-atomizing Burners. Air under low pressure ($\frac{1}{2}$ to 2 lb) is used as the atomizing medium for the burner shown in Fig. 5. Oil pressure need be sufficient only to deliver the fuel through the ports in the inner tube. The air is introduced into the inner chamber through slots tangential to a small circle, which impart a rotary motion to it. This air picks up the oil, partly atomizing it. Atomization is completed when the stream from the inner chamber engages a second air stream from the annular space, which is not whirling. Another design provides

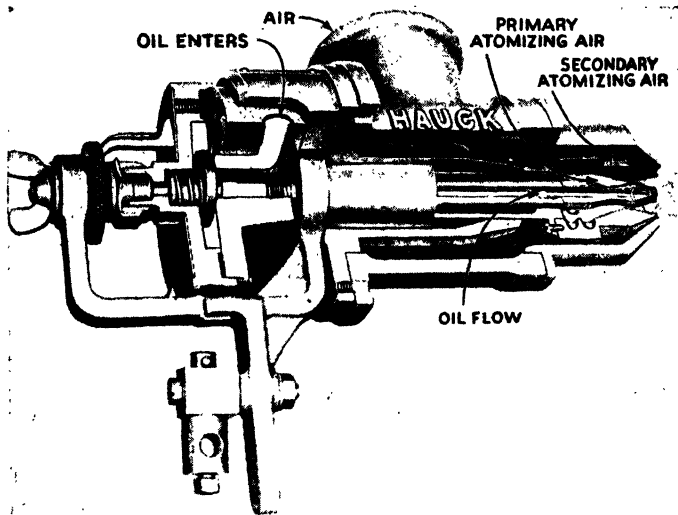

FIG. 5.—Low-pressure air-atomizing burner. (Courtesy of Hauck Manufacturing Company.)

three concentric air blasts. Any specification grade of fuel can be handled, and the burner operates satisfactorily over a throttling range of more than five to one, hence is readily adapted to automatic control. These burners are available in rated capacities of from one to over 500 gph, with automatic proportional throttling control (Fig. 19).

There is also a "low-air-pressure" type of burner in which oil pressure does the preliminary atomizing and low-pressure air accomplishes the final atomizing. The oil must be delivered at 20 to 30 lb pressure for the light grades or at 50 to 60 lb for heavy grades. Its operation is similar to the outside-mixing types of high-pressure burners described in a paragraph following.

High-pressure Steam-atomizing Burners. Steam-atomizing burners are widely used since they are inexpensive to install wherever steam is available and will handle any grade of fuel oil. Oil refineries use burners

of this general class to dispose of dirty or slop oils and even acid sludges. The oil guns in combination oil and gas burners are nearly always of the steam-atomizing type. There is a multitude of steam-atomizing designs.

A subclassification is afforded by considering the point of mixing of oil and steam. *Outside-mixing* burners contact the two fluids only at the point of their release into the furnace atmosphere, whereas *inside-*

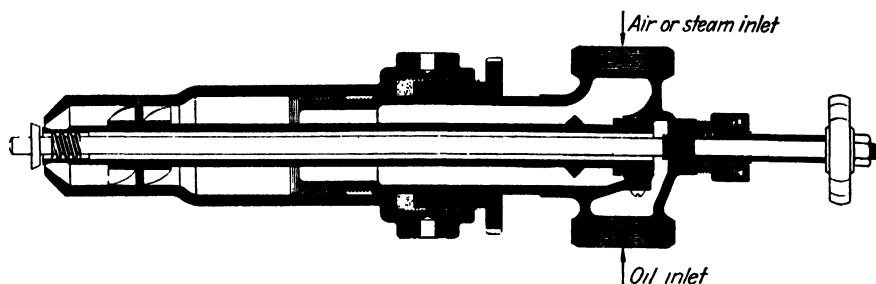

FIG. 6.—High-pressure air- or steam-atomizing burner. The adjustable orifice provides a wide throttling range. (Courtesy of Schutte and Koerting Company.)

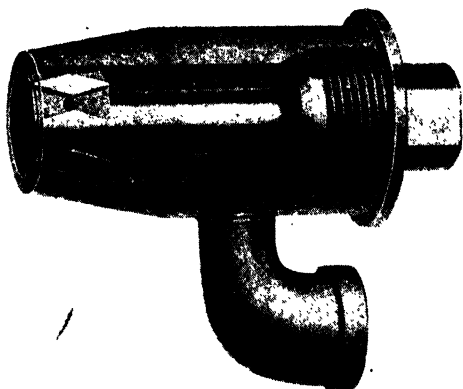

FIG. 7.—High-pressure air- or steam-atomizing burner. (Courtesy of Hauck Manufacturing Company.)

mixing burners contact the oil and steam inside the burner and obtain secondary dispersion when the mixture passes through an outside port or nozzle. Figure 6 shows a highly developed outside-mixing type. Both the atomizing fluid and oil are caused to swirl before making contact. Figures 7, 8, and 8a are inside-mixing types. On the latter two, the sizes of steam nozzles and outside ports may be changed to provide a wide range of capacities and flame shapes. Inasmuch as a fixed nozzle permits little control over the shape of the flame, fan-shaped flat flames are obtained by special design of nozzles, such as long narrow slots or multiple ports with axes in a plane.

The outside-mixing type is less susceptible to clogging from sediment or solids in the fuel, whereas in general the inside-mixing type is more economical of steam consumption. On the latter type, interchangeable tips permit a variety of flame shapes to be obtained. Several manifold mounting arrangements for furnace installations are shown in Fig. 9. *Oil guns* in combination with oil and gas burners may be of either inside- or outside-mixing design.

Steam-atomizing burners are best suited to large installations where a fireman is on duty to regulate the burners and clean them when neces-

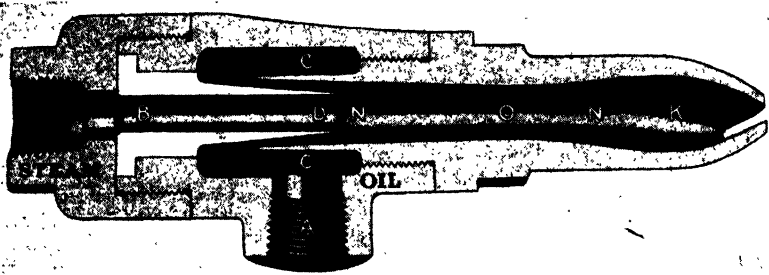

FIG. 8.—Steam-atomizing burner for heavy oils. (Courtesy of National Airoil Burner Company.)

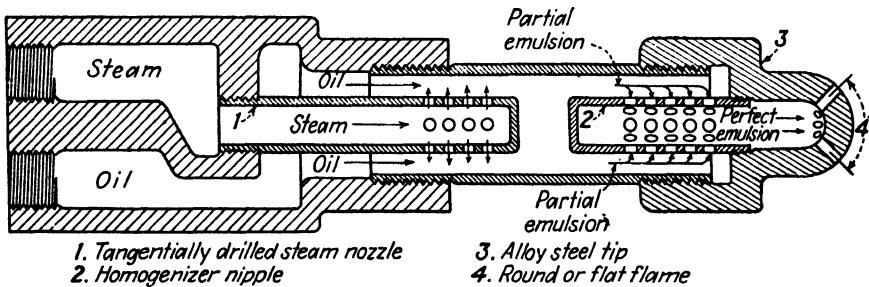

FIG. 8a.—Steam-atomizing sludge burner. (Courtesy of John Zink Company.)

sary. Unit ratings are mostly between 10 and 500 gph, with throttling ranges usually double to half of the rated capacity.

Steam pressures required are from 10 to 100 psig, and the oil pressure must exceed that of the steam supply somewhat. The inexpensive and older types required about 4 lb of steam per gallon of oil, whereas the more highly developed types use little more than one-third of this figure.

High-pressure air can be substituted for steam in nearly all steam-atomizing burners, giving more rapid combustion and a shorter, more intense flame. Thermal efficiency of the furnace becomes somewhat higher when atomizing air is substituted for steam. The use of high-

pressure air is not common because of the high operating cost from the power required to compress the air. A number of intermediate-pressure air-atomizing burners are available in designs similar to both low- and high-pressure types.

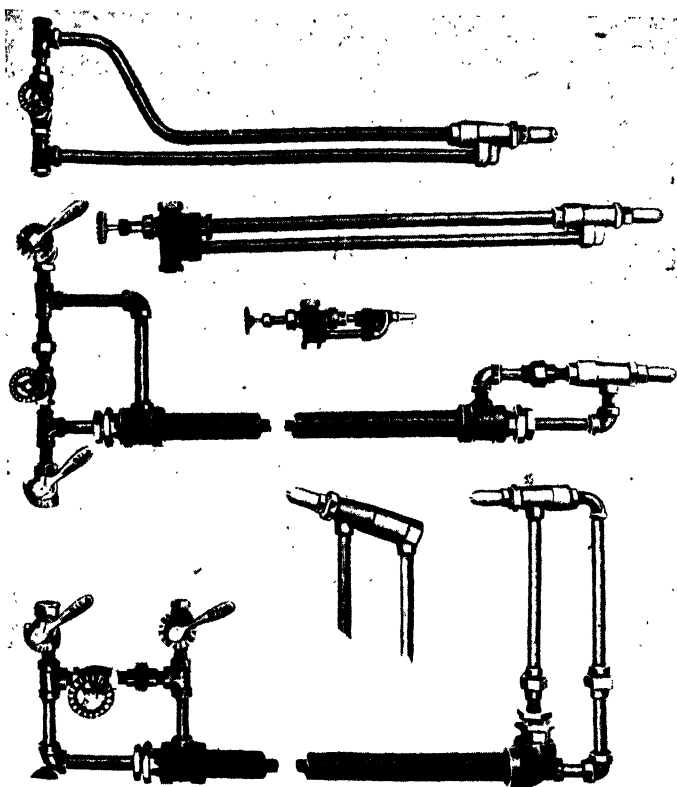

FIG. 9.—Some burner arrangements. (Courtesy of National Airoil Burner Company.)

Comparative Maintenance and Operating Costs. With the exception of mechanical burners, direct operating costs fall in the same order as the power required to produce the fluid energy for atomizing and dispersing the oil. The figures in Table 1 are approximate only.

TABLE 1.—DIRECT OPERATING COST OF BURNING 100 GAL OF FUEL OIL. TYPICAL VALUES

	<i>Cents</i>
Oil-pressure atomizing.....	5
Low-pressure air-atomizing.....	7.5
Intermediate-pressure air-atomizing.....	10-25
Steam-atomizing.....	20-30
High-pressure air-atomizing.....	60

The fraction of the theoretical combustion air introduced as atomizing air decreases as air pressure increases. Typical values are shown in the accompanying table.²

Gauge pressure, psi.....	$\frac{1}{2}$	1	2	5	10	25	60	100
% of theoretical air needed for atomization.	52	42	33	25	18	15	11	7

The increased cost of high-pressure air over steam atomization is partly offset by lower heat losses to the stack. In general, the more highly developed types of burners are the more economical of air or steam and thereby have lower operating costs.

Mountings. Burner mountings should include an adjustable shutter or louver to regulate the amount of combustion air. Frequently a manufacturer provides such a mounting for his burners. For round or cone-shaped flames the shutter may be designed to impart a swirling motion to the air, so that it mixes thoroughly with the spray and gives rapid and complete combustion. A refractory combustion ring will improve the performance of any burner to which it can be adapted. Several types of mountings are to be seen in the illustrations of Chaps. IX and X.

BURNER AUXILIARIES

Oil Pumps. Fuel oil must be supplied to burners at low but steady rates. Positive-displacement-type pumps are the most satisfactory for this service. The smaller capacity pumps are usually of the gear type shown diagrammatically in Fig. 10. Larger capacity pumps are often

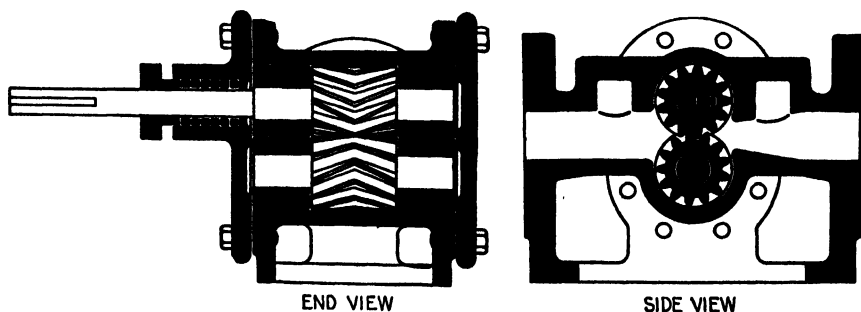

Fig. 10.—Spur-gear-type pump. (Courtesy of Schutte and Koerting Company.)

of a type similar to that shown in Fig. 11. Centrifugal force and the oil pressure acting on the bottom of the movable vanes hold them against the interior surface of the housing, trapping a portion of oil in the space between the rotor and the housing and discharging it into the outlet port.

² "Hauck Industrial Combustion Data," 1st ed., p. 6, Hauck Manufacturing Company.

Reciprocating-piston steam pumps continue to be used in some installations and as standbys in case of electrical power failure. Operating and maintenance costs of reciprocating pumps are generally higher than for rotary pumps.

Fuel pumps are customarily equipped with an automatic pressure-operated by-pass or relief valve, so that a constant discharge pressure is maintained. Flow through the burner is regulated by a special valve on

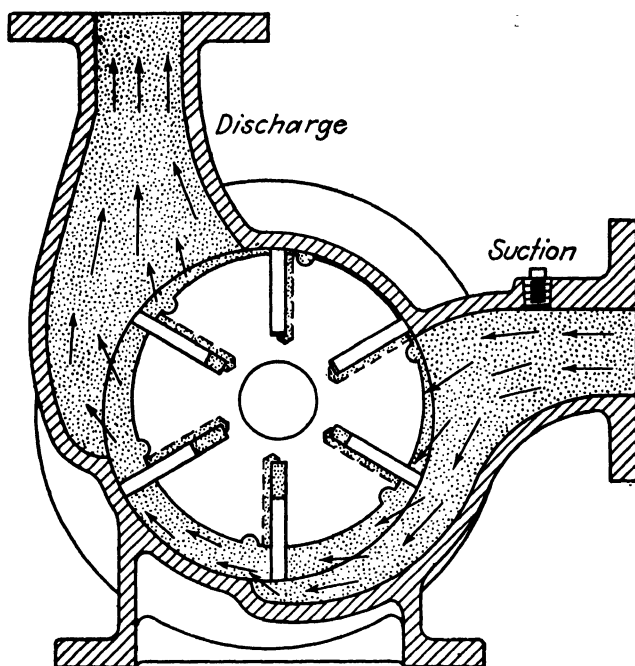

FIG. 11.—Sliding-vane-type rotary pump. (Courtesy of National Transit Pump and Machine Company.)

all but the pressure-atomizing types, which are installed for on-and-off service and burn at a fixed rate.

Oil Preheaters. For proper atomization, oil must not be too viscous at the point where atomization occurs. The maximum allowable oil viscosity depends upon the individual burner and is between 100 and 300 Saybolt Universal seconds. This figure may be used as a guide to determine the temperature of preheating necessary for heavy oils, since their viscosity decreases rapidly upon warming. A temperature of 250°F is the highest required of any *specification grade* of fuel. Both electrical and steam preheaters are in use, the latter being the more economical, particularly for large units. Steam-atomizing burners can do considerable heating by direct contact at the point of atomization. This is not advisable, since it leads to poor combustion caused by condensation of

the steam. Steam containing slugs of water can extinguish the flame momentarily and cause an explosion, hence all steam-atomizing burners should be provided with a steam trap located as close to the burner as possible. Small pockets of water in the oil are even more dangerous.

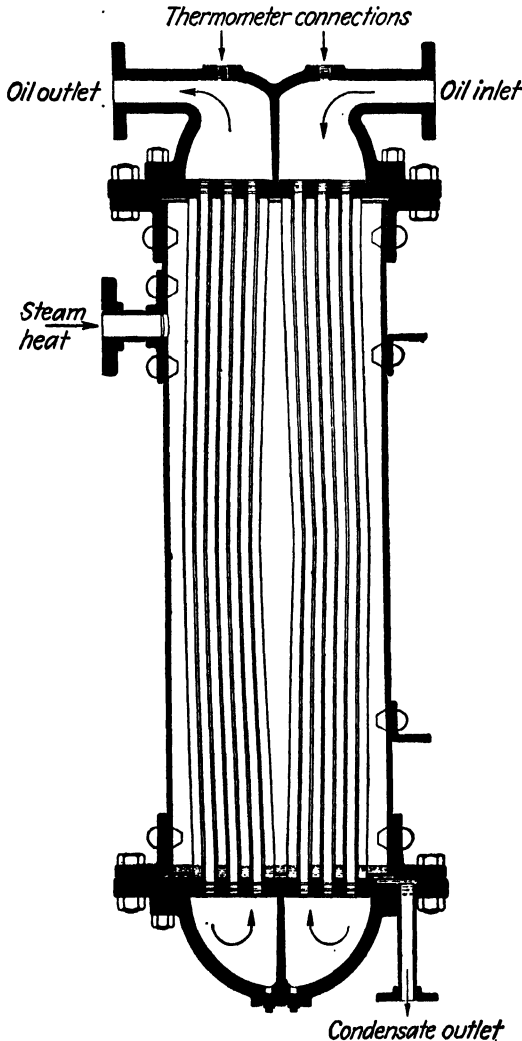

FIG. 12.—Shell-and-tube-type fuel-oil heater. (Courtesy of Schutte and Koerting Company.)

Steam-operated oil preheaters are of shell-and-coil or shell-and-tube construction (Fig. 12). The proper arrangement is to heat the oil as it goes to the burner rather than to warm an entire tank of fuel, since a tank loses heat to the atmosphere, and also separation and settling of water and sediment occur when heated oil is allowed to stand.

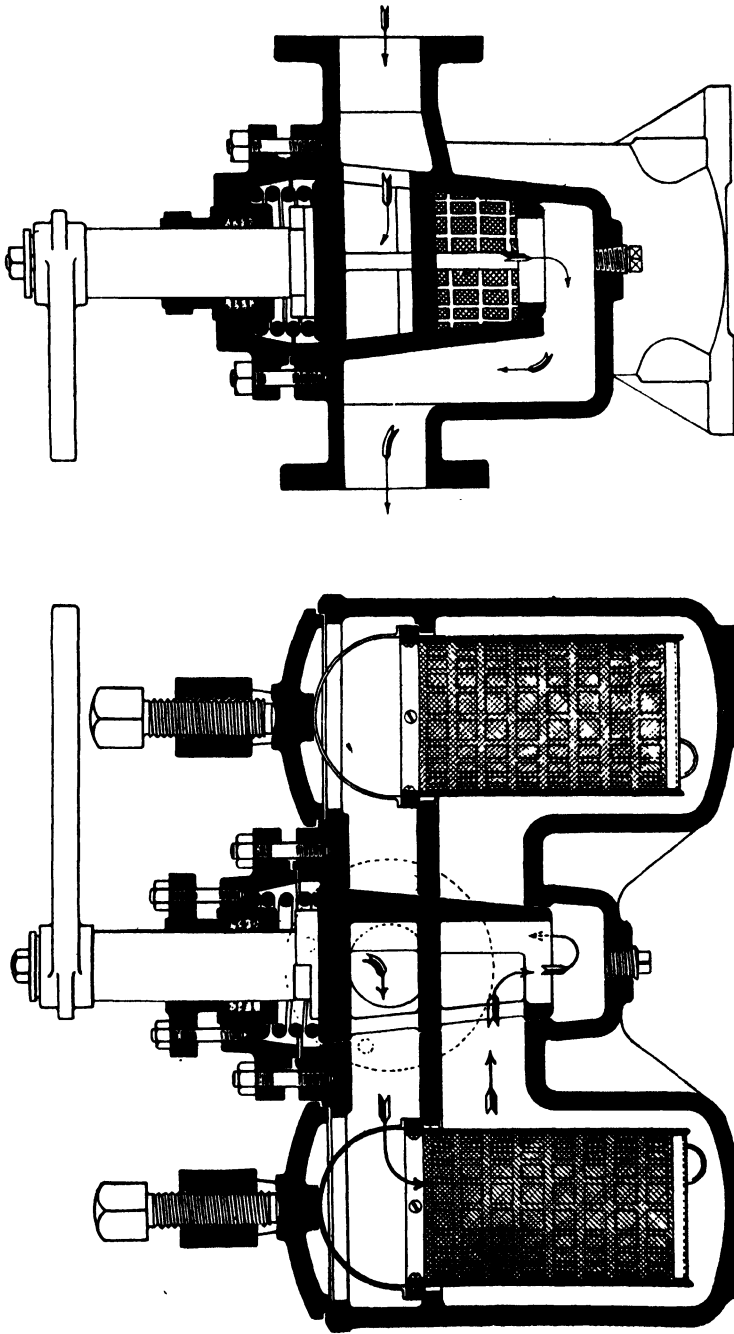

FIG. 13.—Fuel-oil strainer. (Courtesy of Schutte and Koerting Company.)

Small plants often use the lighter grades of fuel oil, and no preheaters are needed. Distillate oils do not readily deposit carbon on the nozzle nor do they contain sediment, and therefore less attention is required than for firing heavy fuels.

Strainers. Strainers are a necessity for burner nozzles having small orifices. A strainer unit consists of a chamber in which a perforated cylinder or wire gauze is mounted, through which the oil must pass (Fig. 13). The screen must be readily accessible for cleaning. There are a number of other types using special straining or filtering media.

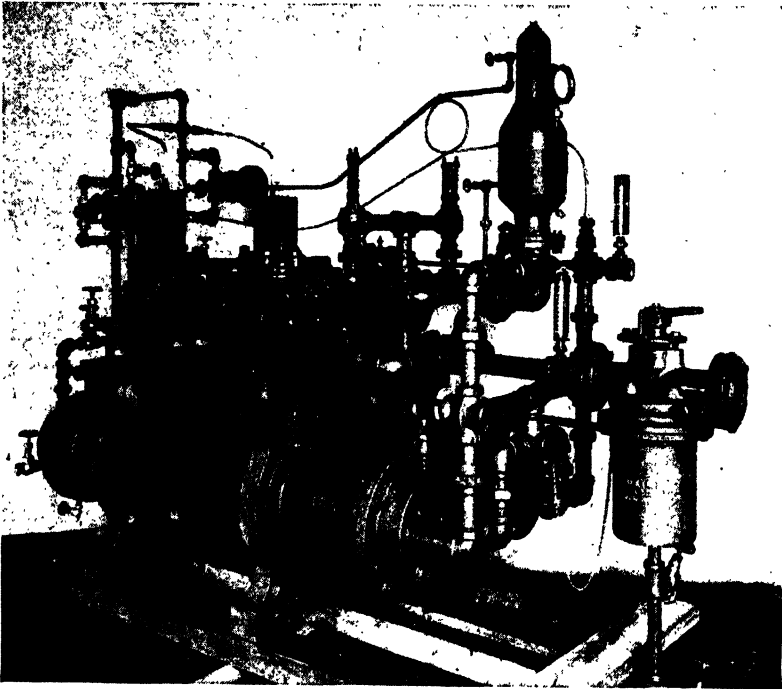

FIG. 14.—Heavy-fuel-oil pumping and conditioning set. (Courtesy of W. N. Best Engineering Company.)

The "self-cleaning" type consists of a number of thin interlapping plates, alternately fixed and mounted on a movable shaft. Oil travels through the spaces between the fixed plates. When clogged, a twist of the movable plates clears out the sediment. The nozzle of Fig. 4 contains a small, built-in strainer. Nearly all burner manufacturers also supply strainers.

Oil Pumping and Conditioning. For smooth, trouble-free operation, oil burners should be supplied with properly preheated, strained oil at constant line pressure. Devices to provide this conditioning have been discussed. The various accessories may be installed separately, but assemblies are available that are very convenient. Figure 14 shows such

an assembly that has twin units. Oil enters the strainer at the extreme right and is drawn into the oil cylinders of the duplex plunger pumps. The pump discharge pressure is held constant by the control valve in the steam line to the steam end of the pumps. This control is actuated by pressure obtained from the surge chamber on the oil line following the pump. The oil then passes through the shell-and-tube steam heaters below the pumps and is discharged into the burner line. Oil pressure-relief valves are visible above and to the right of the pumps. The oil temperature is automatically controlled by a thermostatically operated valve in the steam line to the heater shells. The thermostat bulb connection is seen emerging from the oil discharge line. By-pass valves, drain valves, thermometers, pressure gauges, and pump lubricators complete the assembly.

Air Pumps and Fans. Air for combustion and for atomization may be provided by fans, rotary blowers, or compressors. The sectional view

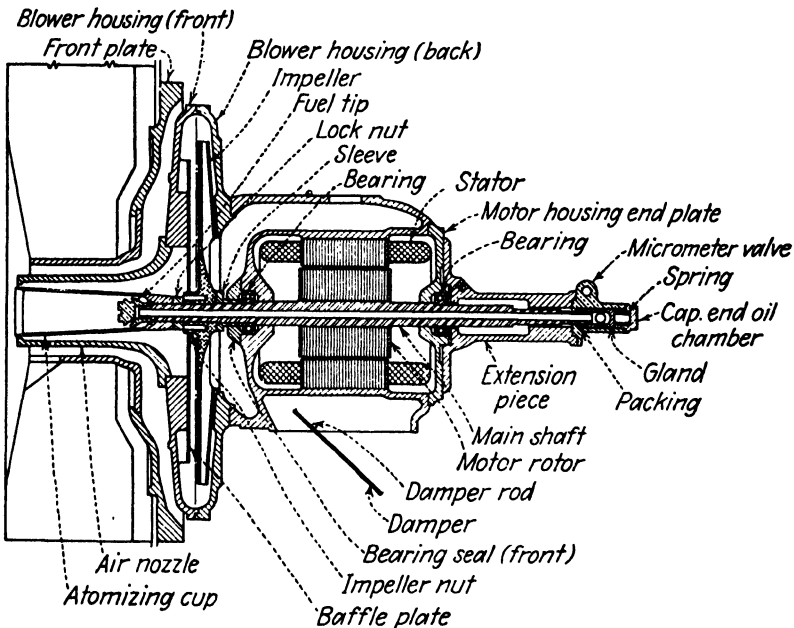

FIG. 15.—Sectional view of horizontal rotary-cup burner, showing blower. (Courtesy of National Airoil Burner Company.)

of a rotary-cup burner (Fig. 15) shows a blower as an integral part of the assembly. Single-stage fans and turbine-type blowers have rated delivery pressures from 1 in. H_2O up to 12 psig (Fig. 16), and three-stage units are available to deliver at 35 psig. High-speed high-pressure rotary compressors are being developed. Economics of construction restrict the

maximum speed and rotor diameters, which in turn limit the amount of compression or pressure increment generated in each stage. However, since stage compression depends upon gas density, each succeeding stage develops a higher pressure increment than the preceding one.

A positive-displacement type of blower is illustrated by the Roots-Connorsville machine, shown diagrammatically in Fig. 17. There is a close fit, but no actual contact between the impeller and case, hence no wear is possible at these points. These develop 5 lb pressure at very low speeds and with very little leakage and can be used when a variable supply is needed or where noise is objectionable.



FIG. 16.—Turbine-type air or gas compressor. (Courtesy of Roots-Connorsville Corporation.)

Although many burners will induce all the air needed for combustion, conservative practice is to provide additional secondary air ports *below* the burner mounting, to be available when needed. A good working rule is to allow 1 sq in. of such opening for each 50,000 Btu generated per hour.

Forced Draft. Some furnace and heater designs are capable of absorbing heat faster than burners operating under natural draft can furnish and maintain satisfactory combustion in the available firebox space. Where space is at a premium, it becomes worth while to use forced draft if the furnace can absorb the greater heat release without damage.

Forced-draft installations commonly use preheated air, since a fan must always be provided. Only a few tenths of an inch of water pressure is needed for increasing the heat release in a natural-draft furnace by about 75 per cent, since the greatest part of the air pressure drop through such a furnace is in the air shutter around the burner. Necessary burner changes are inclusion of a "wind box" or air duct enclosing the burner

mounting, and a flame shield around the burner nozzle to prevent the flame from being blown away from it. These are in evidence in Fig. 18, which is an oil-pressure-atomizing burner installed in a Scotch marine boiler. The refractory port is essential for good combustion in this case, since without it the heat-absorbing surface that almost completely surrounds the flame chills it so fast that combustion is not completed.

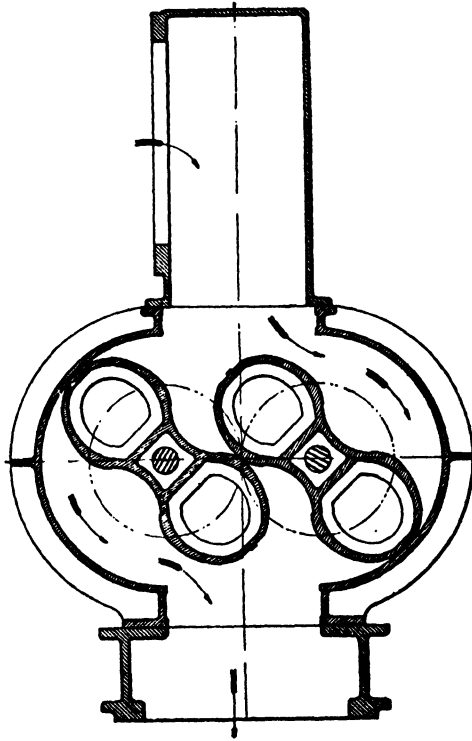

FIG. 17.—Roots-Connorsville gas pump and meter.

Burner Controls. There are several means of partly or completely controlling an oil burner. Vaporizing burners can be throttled by an automatically controlled valve. Mechanical and oil-pressure atomizing burners are not well adapted to throttling and so are generally used in on-and-off service. Automatic controls start and shut off these burners as required to maintain a control temperature or boiler pressure.

Air- and steam-atomizing burners must have the atomizing fluid proportioned to the oil rate for satisfactory operation. Since these burners are used chiefly in large installations, the proportioning is customarily a manual operation done by the fireman. A proportioning device is now on the market for a low-pressure air-atomizing burner, which may be set to deliver a constant percentage of the theoretical air over a range

of oil rates. This proportioner allows the oil and air to be simultaneously throttled with a single control lever and thus is adapted to automatic control. The assembly is shown in Fig. 19. Automatic controls for steam-atomizing burners are being developed.

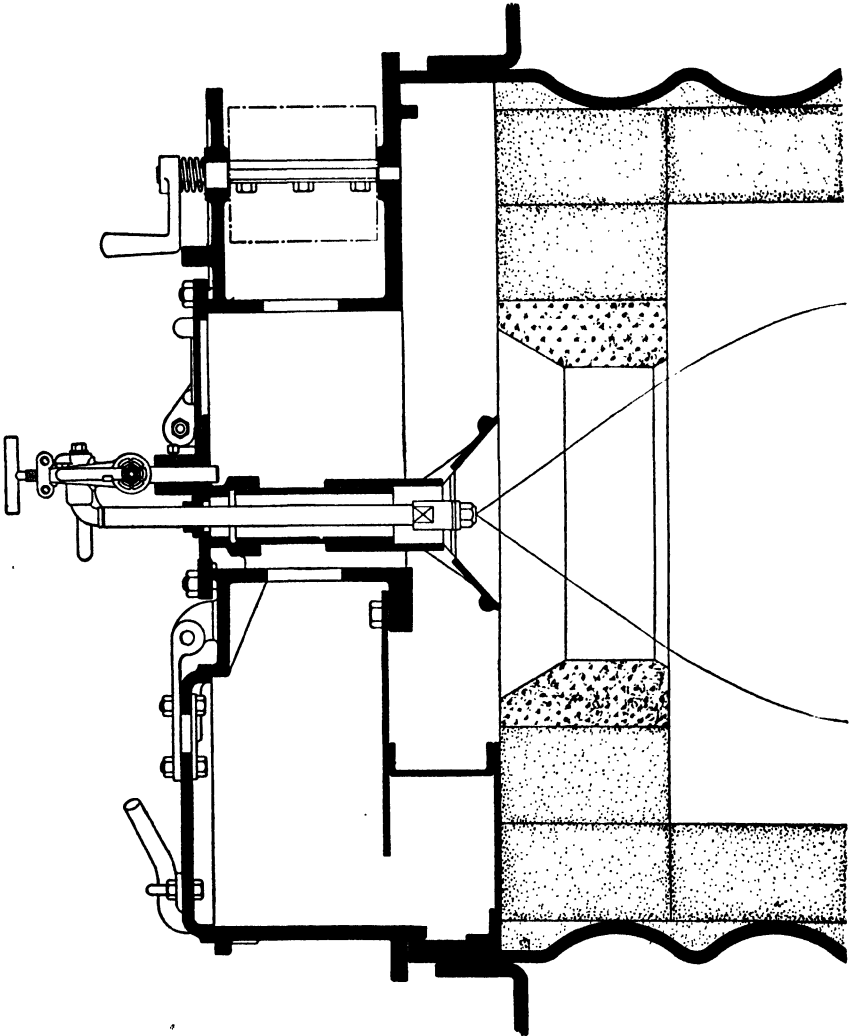

FIG. 18.—Oil burner installation in Scotch marine boiler showing tile thimble and liner, and wind box for forced draft. (Courtesy of Schutte and Koerting Company.)

Safety Devices. If an oil (or gas) flame becomes extinguished and the burner continues to flow, the combustion chamber rapidly fills with a combustible mixture. Ignition may occur upon contact of the mixture with hot furnace walls, by a lingering spark, or by relighting of the burner,

whereupon an explosion ensues. To avoid explosions, oil burners may be equipped with gas pilot flames. There are also safety devices which shut off the burner or the fuel supply if the flame becomes extinguished by any means. Some of these automatically relight the burner after a

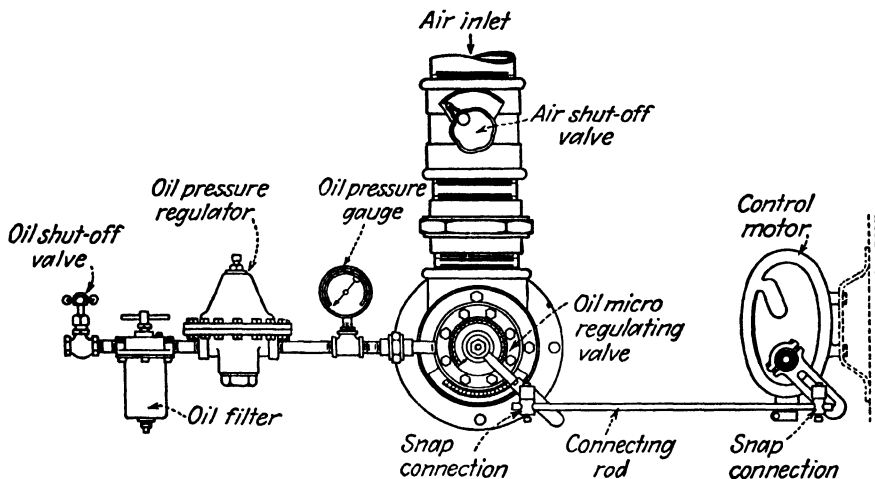

FIG. 19.—Arrangement of automatic control system for a single proportioning burner. Burner backplate and oil-valve assembly can be rotated to bring the operating lever to any one of four quadrants, giving flexibility for location of control motor. (Courtesy of Hauck Manufacturing Company.)

sufficient time interval for the combustible gas or vapor to have been purged from the combustion chamber.³

Supplementary Reference

STEINER, K.: "Oil Burners," McGraw-Hill Book Company, Inc., New York, 1937.

Exercises

1. a. What types of burners are most suitable for automatically controlled hot-water heating systems? for boilers? Which types may be adapted to process furnaces in which a level temperature must be maintained with automatic control?
- b. What grades of oil are to be recommended for the above applications? Give reasons.
2. If it became necessary to fire a heavier grade of fuel or to improve the performance of an existing burner installation, how could it be accomplished
 - a. For an oil-pressure atomizing burner?
 - b. For a steam-atomizing burner?
3. It is desired to increase the heat generation (duty) of an oil-fired furnace by 30 per cent. The furnace is of adequate size, and the existing burner installation and accessories are to be used insofar as possible. What modifications might be required to accomplish this for each of the five burner classes listed?

³ COHEN, T. A., *Ind. Eng. Chem. News Ed.*, **21**, 302 (1943).

4. A steam-atomizing burner uses 1.5 lb of steam per gallon of oil. The oil tests 24°API, 9 wt per cent hydrogen, negligible sulfur, and 18,500 gross Btu/lb. The combustion air is practically dry and the flue-gas temperature is 600°F. Calculate the sensible heat loss due to the atomizing steam in the flue, as per cent of the net heat of combustion. Take the steam at the burner as at 212°F and saturated.

5. *a.* In changing over to air atomization, the flue-gas temperature of Exercise 4 can be maintained at 600°F and the excess air reduced from 50 to 40 per cent. If all of the net heat of combustion except that lost in the flue can be utilized, calculate the furnace efficiency in each case. The air enters at 60°F.

b. For the same furnace, the fuel oil costs 3 cents per gallon and the steam costs 40 cents per 1,000 lb. What are the savings, as fuel plus steam costs per 100 gal of oil fired (to be used for comparison with the cost of air atomization)?

CHAPTER XI

STOKERS AND PULVERIZED-COAL BURNERS

The functions of a stoker are (1) to feed coal to a furnace combustion zone at a steady but easily controllable rate, (2) to admit an evenly distributed supply of air, (3) to retain the burning fuel until combustion is complete, and (4) to separate the ash without permitting much air leakage. The efficiency of a stoker is measured by the completeness with which it separates ash from unburnt combustible and how well it maintains only a low percentage of excess air while giving complete and smokeless combustion. Obviously, some fuels such as coals high in volatile matter are more difficult to burn efficiently than others; coals having low-fusing or clinkering ash tend to give lower efficiencies. Finally, stoker and furnace design are interrelated. The peak firing rate for satisfactory combustion with a given stoker depends upon the characteristics of the fuel, available draft, excess air used and volume of the combustion space. The maximum rate for stationary practice is usually between 30 and 60 lb. of fuel per square feet of grate surface per hour, including hand-fired furnaces and all types of stokers.

Much progress in smoke abatement in large cities and industrial areas has already been made. Part of the improvement has resulted from antismoke legislation, but a great deal has been accomplished by voluntary effort. Proper design and efficient operation of a furnace automatically eliminates the smoke.

Small domestic stokers are increasing in popularity as they are improved to burn the less expensive grades of fuel. In addition to the convenience over hand firing, a stoker can be expected to provide considerably better heat efficiency, particularly in the smaller units. However, stoker fuel must contain no large pieces, and must also be screened in some instances.

The combustion process in the fuel bed is essentially the same as in a gas producer fired without steam (see Chap. VIII), except that the bed is much thinner; usually 4 to 12 in. from grate bars to the top of the fire. Long flames result from volatile matter distilling and burning, and completeness of its combustion is the chief factor that determines the combustion space required for bituminous coals.

In designing a furnace and specifying a stoker, the fuel to be used, available draft, and volume of combustion space must all be considered.

In general, high firing rates require thicker fuel beds than are needed for firing at low rates. However, high rates develop higher temperatures, faster burning, and correspondingly less time for a lump of fuel to burn completely to ash. Overloading a furnace may result in overheating and burning out the grate bars. An accumulation of ash beneath and in contact with the bars is quite apt to result in overheating. On the other hand, a thin layer of ash on top of the grate keeps the bars cool. A thin layer of ash can be maintained on some types of grates but not upon others.

Satisfactory combustion always requires excess air. The minimum excess depends upon the volume of the combustion space, the firing rate, and the fuel characteristics. Small furnaces are not apt to be very carefully controlled and frequently use 60 to 80 per cent excess air, whereas large boiler plants maintain an excess as low as 20 to 30 per cent. Too little excess air causes smoke or results in carbon monoxide and an injurious reducing atmosphere in the furnace (see Chap. XIII).

Most stokers use a forced-draft fan to supply air. Although a fan may not be required in the case of thin fuel beds, it gives so much better control over the air supply that one is often specified even when the unit can be operated without it. A control mechanism is used to operate a damper in the air duct to or from the fan, proportioning the air supply to the rate at which the fuel is stoked. The fan should be able to deliver somewhat more air than is required at the maximum firing rate, and at the static pressure required under those conditions. Several air throttling arrangements and special fan impellers have been developed for stoker use.

HAND-FIRED GRATES

Combustion in hand-fired furnaces is not a strictly continuous process since the fuel is added in small batches. A burning period occurs between stokings, during which no fuel is supplied. Following a stoking, the green coal heats up, distills volatile matter, and the slower combustion of the coke sets in. Primary air (also designated "underfire air" and "combustion air") is admitted below the grate and burns the coke. Secondary or "overfire" air is admitted above the fuel bed and burns the volatile matter. These two supplies are needed in about equal amounts for a typical bituminous coal. To maintain a constant release of heat between firings, a high percentage of overfire air is needed to burn the volatile matter immediately after a charge is thrown in. Near the end of the burning period, little overfire air is needed but an increased amount of underfire air is required.

It is difficult and impracticable to regulate these two separate air supplies continuously and independently, but fluctuation of their require-

ments is minimized by firing small amounts of fuel at frequent intervals. This practice permits considerably less excess air to be used than is required to avoid smoke when large, infrequent firings are practiced. The optimum hand-firing interval is about 5 min and the interval should be shorter for bituminous coal than for anthracite or coke. The heat efficiency of a hand-fired furnace is usually rather low but varies considerably with the care exercised in firing and in adjustment of dampers. Careful control is good economy, and an automatic draft-regulating damper in the stack is inexpensive and can be advantageously used even on the smallest of furnaces.

Hand firing is most prevalent in domestic furnaces and other small units, especially those not in continuous service. Hand firing is a necessity for some waste and refuse fuels, and for incinerators.

STOKERS

Mechanical stoking provides *continuous* addition of fuel and steady combustion. It permits the air supplies to be adjusted so that complete

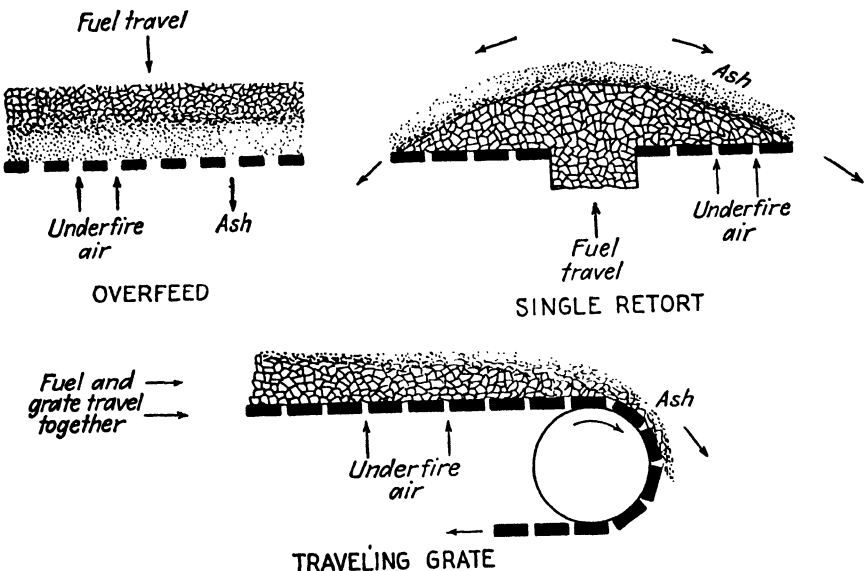

FIG. 1.—Types of stoker grates. "Underfire air" is same as "combustion air" or "primary air."

combustion is obtained with a minimum of excess air. The underfire air always passes upward through the fuel bed, whereas the directions of fuel movement and of propagation of the combustion zone depend upon the type of stoker. With a principal exception of the spreader stoker, furnace units are built with stoker and grate integral or together. Stokers

may be classified according to directions of travel of the fuel and propagation of the combustion zone (Fig. 1). On an *overfeed* stoker, the fuel is fed in on top of the bed and the combustion zone propagates upward. On an *underfeed* or *retort stoker*, the fuel is fed at the bottom or side of the bed and the combustion zone propagates downward. On a *traveling-grate stoker*, the grate carries the bed horizontally on the flat upper surface of a continuous web or "chain grate." The principal modifications of these types are discussed in the following sections.

Overfeed Stokers. The *Roney stoker* is typical of the early inclined-grate overfeed stokers. In this unit, coal is fed at the upper edges of

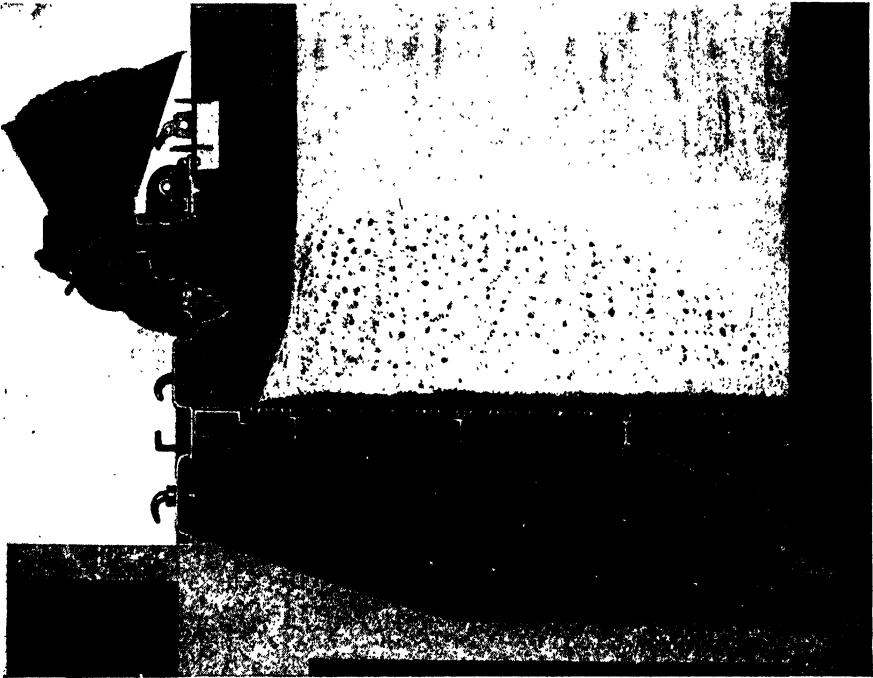

FIG. 2.—Detroit RotoStoker installation. (Courtesy of Detroit Stoker Company.)

mechanical reciprocating grates, built in the form of a wide V. The grates slowly move the burning fuel downward to the center where the ash is removed. This type has been widely used in power plants but is now considered obsolete. Inclined-grate stokers are now chiefly used for burning waste or refuse fuels, such as sawdust and bagasse.

Overfeed stokers of the *spreader type* such as the *Detroit RotoStoker* shown, are rapidly gaining in importance. The spreader mechanism of Fig. 2 has blades mounted on a rotating cylinder which throw the fuel evenly over the grate. Since the fuel particles must travel through the

flame, they are heated toward ignition and the fines are burning before they reach the bed. This shortens the burning period on the grate, permitting high firing rates with thin beds and quick regulation of the furnace load. The grate shown in Fig. 2 is stationary with the ash dropping through of its own accord. Dumping grates and traveling grates are used in larger units and in installations burning fuels that have a tendency to cake.

Other spreader-type stokers differ in their feed and spreader mechanisms, and at least one type employs a blast of air under the spreader to assist in the distribution of fuel over the grate. The fires are accessible and easy to clean where necessary. Spreader stokers are particularly well adapted to low-grade and refuse fuels, and can successfully burn almost any fuel that the mechanism can feed. They cannot handle large lumps, and it is necessary to crush and screen or otherwise eliminate large pieces from the feed.

Underfeed or Retort Stokers. The underfeed stoker dates from 1888 when a Mr. Jones patented an underfeed design, realizing that complete

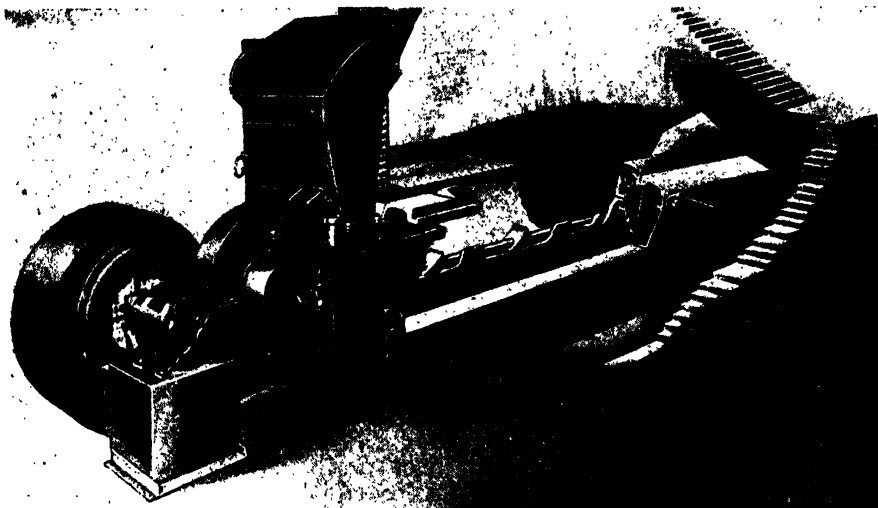

FIG. 3.—Single-retort stoker installation. (Courtesy of Riley Stoker Corporation.)

combustion would be easier to obtain if combustible gases from the volatile matter were passed through incandescent coke rather than through green coal. The underfeed stokers of today retain this principle. There are several types of underfeed or retort stokers which differ as to the number of retorts, method of distributing and moving the bed, and removal of ash.

1. *Worm- or screw-feed stokers* are made for domestic and small indus-

trial units, and burn only good grades of sized coal. The fuel is forced upward through the center of the grate, and moves out to the sides as it burns. The ash accumulates at the sides and is removed periodically.

2. *Side-cleaning stokers* are built in units of one or two retorts. Single-retort units of this type are shown in Figs. 3 and 4. The coal is fed from the hopper to the grate by a motor-driven, reciprocating, lug-equipped plunger rod. The fuel travels upward and then over to the side as it burns, the ash finally reaching the dump grates. On the unit shown in

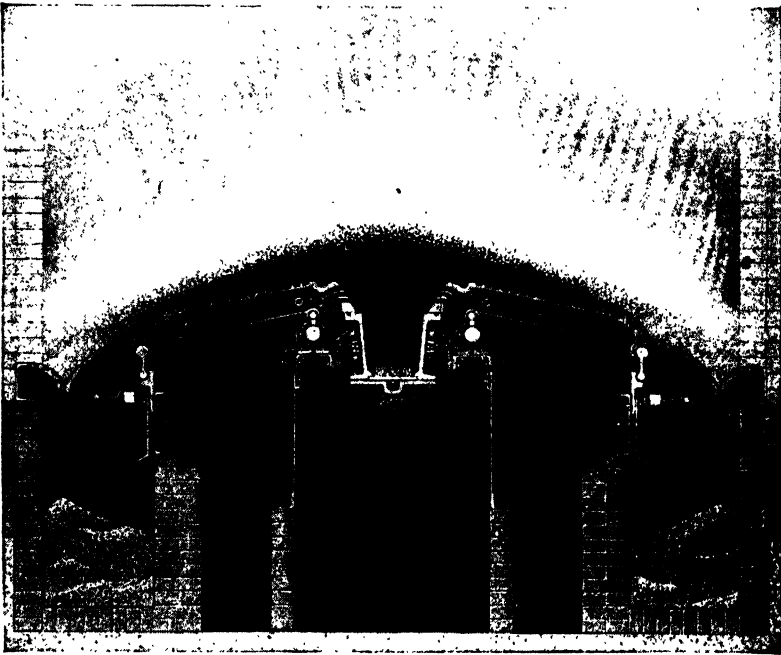

Fig. 4.—Sectional view of a single-retort stoker installation. (Courtesy of Detroit Stoker Company.)

Fig. 3, the hinged dump plates are dropped periodically to remove dead ash. On the larger unit shown in cross-section as Fig. 4, travel of the burning fuel is aided by movable power-driven grates. The ash is removed continuously by the power-driven rocker plates at the sides. The fuel rate may be automatically proportioned with the air from the fan, once the proper ratio has been set for a particular coal.

These stokers are best adapted to coking coals. The plunger thrust tends to break up agglomerates on each stroke, allowing uniform distribution of air and clean separation of ash. A pressure of three or four inches of water is required on the air supply. A comparatively high firing rate per square foot of grate surface can be obtained, and they can

also be overloaded considerably before incomplete combustion becomes serious. Side-cleaning stokers are most prevalent in intermediate sizes.

3. *Multiple-retort stokers* such as those shown in Figs. 5 to 7 are large-capacity units. They are made up of three sections; the retorts seen at the rear through which the coal is fed, an overfeed or extension grate section, and either a set of dead plates or curved rocker plates for ash

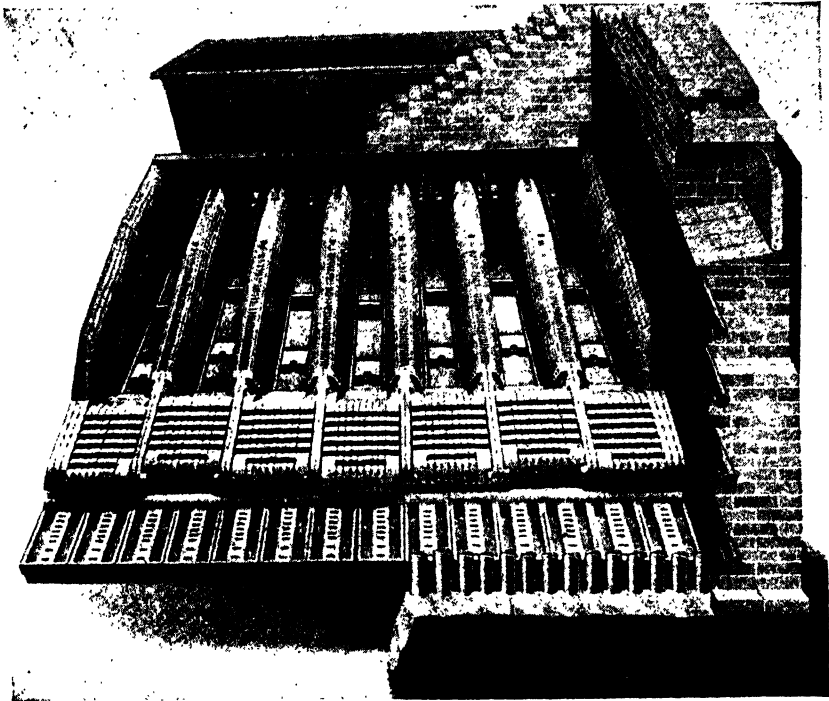

FIG. 5.- Multiple-retort stoker, showing details of installation. (Courtesy of Detroit Stoker Company.)

removal. The unit shown in Fig. 5 has retort *bottoms* and extension grate sections that are mounted on individual tracks and linked to power-driven cams. The cams impart a reciprocating motion to individual retort bottoms and extension grate sections, moving the burning fuel slowly along the retorts and across the extension grates. The ash comes to rest upon the hinged dead plates that are dumped periodically.

The grate shown in Figs. 6 and 7 has retorts built in halves, each half being mounted together with its own section of extension grate and rocker plate, as can be observed in Fig. 6. Adjacent sections reciprocate in opposite directions to cause the stoking action, so that when one section is moving forward, the other is moving backward. Coal enters the hopper by gravity and is fed into the retorts by means of plungers.



FIG. 6.—A large multiple-retort stoker. (Courtesy of Riley Stoker Corporation.)

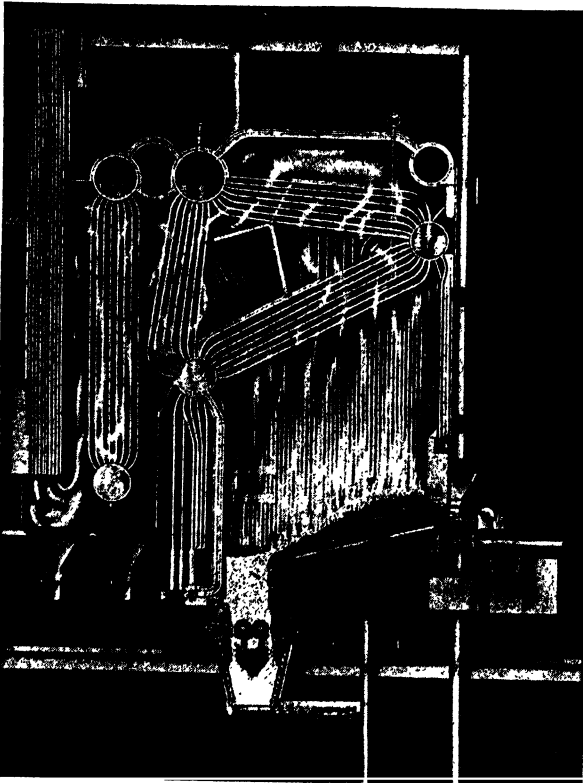

FIG. 7.—Multiple-retort stoker installed in boiler, showing air duct, air preheater (at extreme left), and clinker grinder. (Courtesy of Riley Stoker Corporation.)

The reciprocating movement of the retort sides (carrying the air supplying the grates) distributes coal over the grate surface, and at the same time keeps the fuel bed porous. The fuel bed is progressively conveyed towards the bridgewall by the reciprocating retort sides. By the time the fuel reaches the overfeed section of the stoker, the volatile matter is consumed and only coke and ash remain. Combustion is then completed on the overfeed or extension grates. Ash is moved onto the rocker

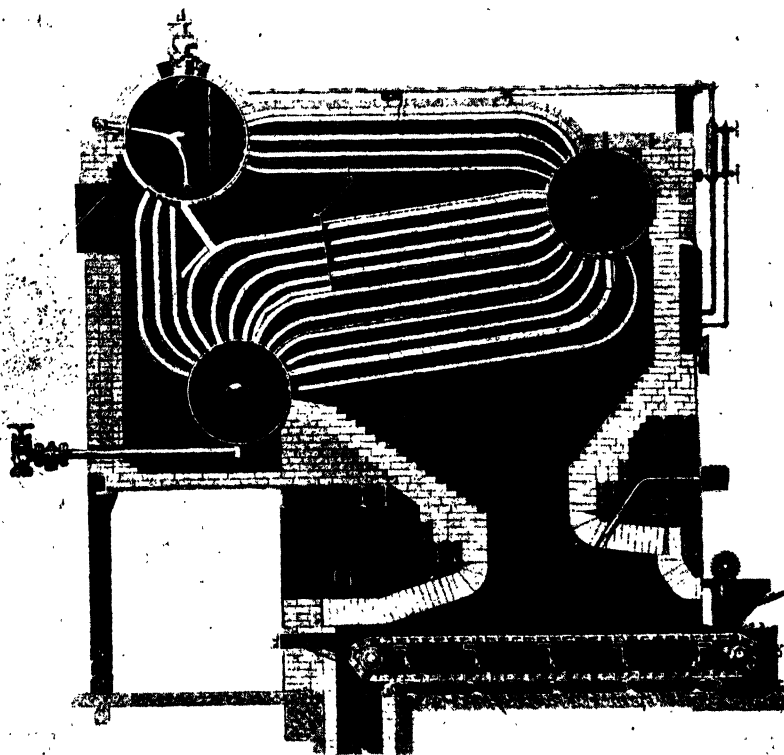

FIG. 8.—Traveling grate stoker installed in Stirling boiler, showing combustion arch.
(Courtesy of Babcock and Wilcox Company.)

plates which by a combination of horizontal and vertical rocking motions continuously agitate, crush, and eject the ash to the ashpit. This reduces the formation of clinker at the rear of the stoker.

The coal hopper, clinker grinder, and forced-draft duct are visible in the sectional view of the installation (Fig. 7). Note the hinged air deflector by which air is proportioned between retort and overfeed sections. Static pressure required by this type of unit is about 5 in. H_2O .

Traveling-grate Stokers. The traveling- or "chain-grate" stoker such as shown in Figs. 8 and 9 has found wide usage in medium- to large-

size installations because of its ability to burn practically any grade of lump fuel. A typical grate of this type uses swing-mounted bars about 8 in. long and 1 in. wide. The linear speed of the grate is one half to one complete revolution per hour, or about $2\frac{1}{2}$ times its length in feet per hour, when using forced draft. Each grate is individually designed for the particular fuel to be burned and capacity to be obtained. Grates are built in sizes up to about 20 ft wide by 25 ft long. One manufacturer makes grates having less than 20 to more than 600 sq ft of effective area.

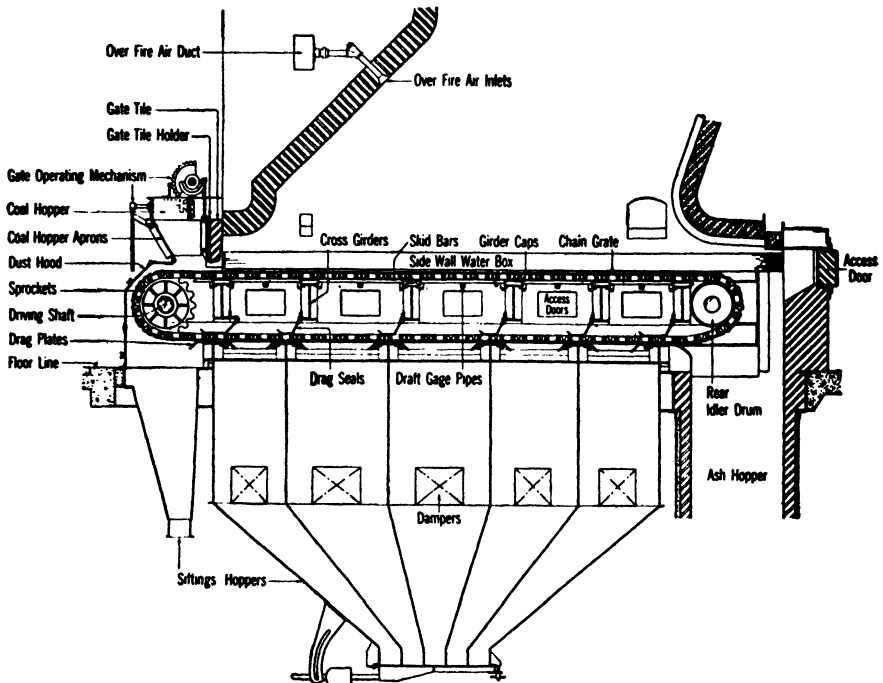

FIG. 9.—Heavy-duty type of traveling grate stoker, showing combustion air distributor and overfire air inlet. (Courtesy of Babcock and Wilcox Company.)

Refractory arches are often mounted two feet or more above the grate to reflect heat and quickly ignite the coal, thereby permitting a greatly increased combustion rate. Arches are a necessity for anthracite coal and other fuels hard to ignite. The back or "ignition arch" for slow-burning fuels such as anthracite should be much longer than the front or "reverse arch." This construction locates the "throat" or minimum area near the front of the grate. The size of this throat or minimum area depends upon the furnace design and the fuel to be burned. In some cases it is as little as 30 per cent of the grate surface. Operating with bed thicknesses of $2\frac{1}{2}$ to 12 in., a combustion rate of 200,000 to 400,000 Btu/(sq ft of grate surface)(hr) is obtained with less than 5 per

cent loss of combustible in the ash. The thicker of these beds require forced draft.

A recommended design for any specific installation and fuel is always furnished by the manufacturer. Grate widths are standardized, and the grate length for a given width determines both maximum and minimum capacity, since there are practical limits to both fuel bed thickness and grate speed. Traveling grates are not suited for thin beds of highly coking coals, and a thin bed always results in high excess air unless the fuel is screened to a uniform size. Operating at low capacity with a considerable length of dead ash on the back of the grate has the same undesirable effect. Too high a grate speed tends to increase both excess air and ashpit loss of combustible. Too thick a bed produces both of these effects because of a tendency of the air to channel, and this is further aggravated by clinker formation. Note the partitions forming air ducts across and inside the upper and lower chain of the grate. The primary air is proportioned through these ducts to give even and complete combustion with a minimum of excess air and ashpit loss. Major changes in firing rate are accomplished by altering the thickness of the bed. Minor changes are made by varying grate speed. The total air supplied for combustion must be adjusted accordingly.

PULVERIZED-COAL BURNERS

The high heat efficiency and quick regulation obtainable with liquid and gaseous fuels are also realized by pulverized-coal installations. The major disadvantage of this efficient method of burning a cheaper fuel is the expensive pulverizing and handling equipment required, and its rather high operating cost for mechanical power. Pulverized-coal units are economically feasible only for plants consuming a ton or more fuel per hour. About half of the ash is swept through the furnace into the stack, and near urban areas dust catchers or precipitators are necessary to avoid the nuisance of fly ash, the smaller particles of which settle over a radius of several miles.

Any type of bituminous and, in special cases, coke or anthracite coal may be handled, but power requirement is high for grinding hard coals, and power requirement increases rapidly with moisture content of any coal. It is worth while to dry the fuel as far as possible before pulverizing. Two general classes of pulverizer and burner arrangements are in use:

1. The "central system," consisting of a large grinder supplying a number of burners, and having a pulverized-coal bunker which can store several hours' supply.
2. The unit pulverizer and burner, in which the grinder supplies only one burner and has no storage bin.

Both arrangements utilize air-classification to separate fuel particles ground to sufficient fineness from larger particles which are returned to or stay in the mill for further size reduction. Likewise, both transport the pulverized material from grinder to bin and burner through a conveyor pipe by a blast of air.

The first or "central system" is used only in the largest of central station boiler plants. There are disadvantages to storing pulverized coal for as short a time as a few hours: the ground fuel flows freely immediately after pulverizing, but slow surface oxidation starts immediately and in a short time noticeable caking occurs. Spontaneous ignition almost always occurs when a bin or sizeable accumulation of powdered coal is left undisturbed for several days. Since the second or unit system, which is often called "direct-firing," is the more common, it is the only one discussed.

Combustion Characteristics of Pulverized Fuel. The burning stages for pulverized coal are the same as for larger lumps. Since the total fuel surface is so much greater, combustion of a particle is substantially complete in less than half a second. Ignition occurs in a few hundredths of a second, and ignition temperatures range from 200 to 300°C (212 to 572°F) for lignite to 450 to 600°C (842 to 1112°F) for anthracite. The rate of flame propagation depends upon a number of factors, and is greatest for high-volatile low-ash fuels. The highest value occurs when using about 50 per cent of the air required for combustion, and may reach 45 ft per sec. Ignition velocity varies inversely with particle diameter, and time required for combustion varies as the square of particle diameter (see Chap. VII). Coal pulverizers produce a range or aggregate of particle sizes. The ASTM sieve test (D 197—30) determines and expresses the *degree of pulverization* as proportions of the various screened sizes.

In general, the larger the combustion space, the larger the particle size that can be tolerated. Many installations obtain satisfactory operations with a fuel 65 per cent of which passes through the 200-mesh sieve. The figures given in Table 1 are more conservative and are perfectly safe.

Pulverizing Equipment. A pulverizing system includes a coal feeder, grinder, fan, and air classifier. The units are frequently of integral construction. The feeder moves the fuel into the grinder (or disintegrator) at a definite, adjustable rate. The mechanism used in prevalent types of feeders is a variable-stroke plunger, a revolving screw, or a rotating table. The feeders in Figs. 10 to 12 are all of the rotating-table type. The coal is fed to the table from an overhead bin, its continued movement being insured by lugs or ridges on the vertical shaft or the table itself. A stationary adjustable blade separates an outer layer of coal from the table, dropping it into the pulverizer.

There are several types of pulverizers: *ball mill* (Fig. 10), *bowl mill*, *ball-race mill* (Fig. 11), and the *attrition mill* (Fig. 12). The unit shown in Fig. 12 pulverizes by the mechanism of attrition alone and the fan and classifier are self-contained. The other types pulverize by actual grinding and have separate fans and classifiers. The velocity of the

TABLE 1.—FINENESS OF PULVERIZATION REQUIRED WITH DIFFERENT COALS
(Per cent through 200-mesh screen)

	Fuel classification					
	Petro- leum, coke, and an- thracite, FC 97.9- 86%	Bituminous				
		Low volatile, FC 85.9- 78%	Medium volatile, FC 77.9- 69%	High volatile, FC below 69%		
				Btu above 12,999	Btu 12,999- 11,000	Btu below 11,000
Stationary boiler furnaces:						
Max input below 15,- 000,000 Btu.....	85	80	75	75	70	65
Max input above 15,- 000,000 Btu.....	80-85	75	70	70	65	60
Marine boiler furnaces....	..	85	80	80	75	
Metallurgical furnaces....	..	85	80	80	80	
Cement kilns.....	..	80	80	80	80	

The classification of coals given above conforms to ASTM D 388-38. (*The Babcock and Wilcox Co.*)

FC = % FC in dry fuel on Mm-free basis

$$= \frac{\text{as-fired FC}}{1 - [\text{moisture} + (1.1)(\text{ash})]}$$

Btu = Btu/lb of moist coal on Mm-free basis

$$= \frac{\text{as-fired Btu/lb}}{1 - (1.1)(\text{ash})}$$

air put through a mill determines the largest size of particles that are carried into the classifier. The classifier determines the fineness of the coal going to the burners, and returns the oversize to the mill.

Although the great majority of pulverized coal installations are in stationary power plants, Fig. 11 shows an adaptation to the firing of cement kilns. Units of this type are built in capacities of from $\frac{1}{2}$ to 45 tons/hr. Raw coal is fed to the inside of the upper grinding ring and passes outward between the grinding elements. The pressure between balls and rings is applied and adjusted by external springs. The coal feed may be 1 in. or smaller in size.

The mill shown in Fig. 12 is made in capacities of 1 to 6 tons/hr. The coal is fed to the first stage, consisting of a series of swing hammers

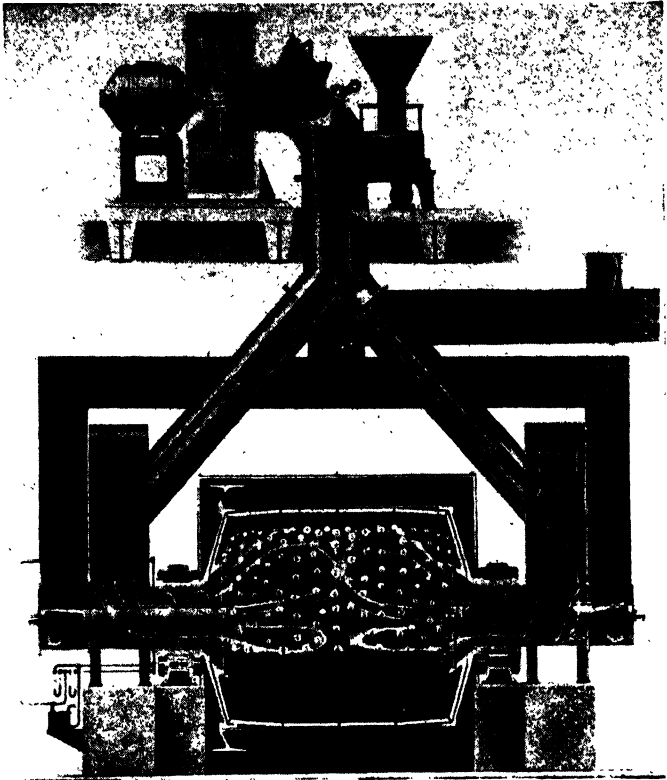

FIG. 10.—Ball mill pulverizer (twin classifiers at opposite ends of mill). (Courtesy of Foster-Wheeler Corporation.)

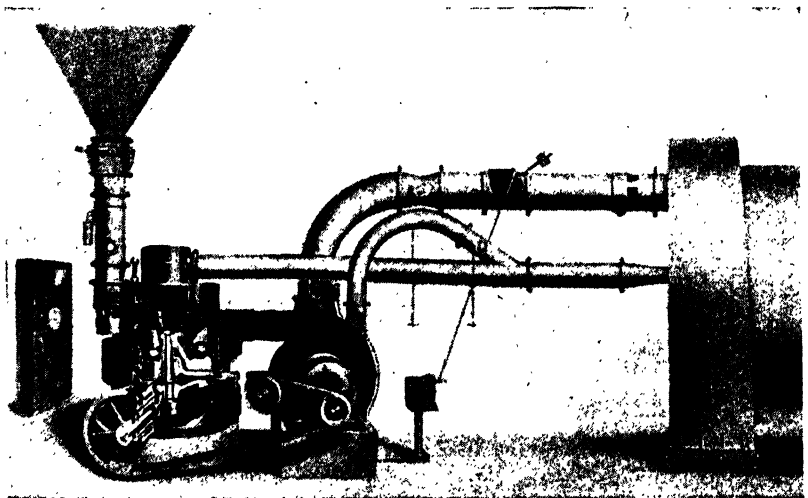

FIG. 11.—Pulverizer installed on cement kiln. (Courtesy of Babcock & Wilcox Company.)

that break it down to granular size. It then passes around the outside of the rotor to the final stage. Here, moving pegs on a rotating disk travel between stationary pegs mounted on the housing. Attrition reduces the granular material to the desired fineness. From this compartment the pulverized coal is drawn through the center of the pulverizer through a series of rotating rejector arms on the same shaft. These arms separate the coarse particles, throwing them back into the maze of pegs for further disintegration. The pulverized material then enters the fan

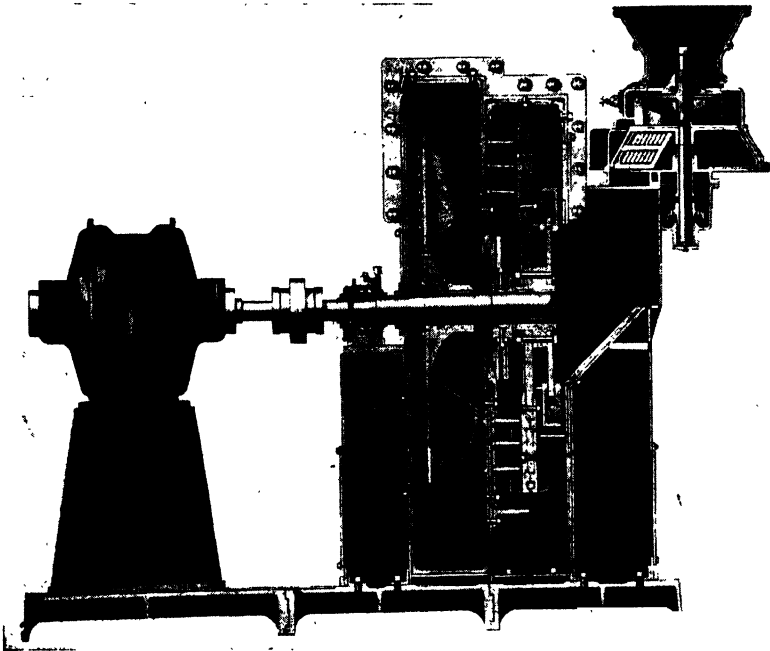

FIG. 12.—Attrition-type pulverizer. (Courtesy of Riley Stoker Corporation.)

chamber from which it is discharged directly to the burner. For operation at maximum capacity, only about 10 per cent of the air required for combustion need be supplied by the pulverizer. The remaining air is proportioned as primary or secondary air as desired.

The air used in pulverizers dries out the fuel, and the air temperature may drop as much as several hundred degrees in passing through the machine owing to the heat of vaporization of moisture. The temperature drop would be even greater were it not for the fact that the power used in grinding is converted into heat. The heat from mechanical power is about half of the heat of vaporization for coal of average moisture content. Thermostatic control may be applied to the inlet air supply to the pulverizer. The air should be sufficiently preheated so that nearly all of

the free moisture is eliminated from the fuel. This requires that the pulverizer outlet temperature be considerably above 100°F. If the fuel is not dry as it leaves, the capacity of the mill is reduced and the grinding power increased. The allowable air preheat temperature depends chiefly upon the amount of moisture in the fuel. On the other hand, when outlet temperatures rise above 300°F, coal particles begin sticking together and a fire may start in the grinder. The energy required is usually from

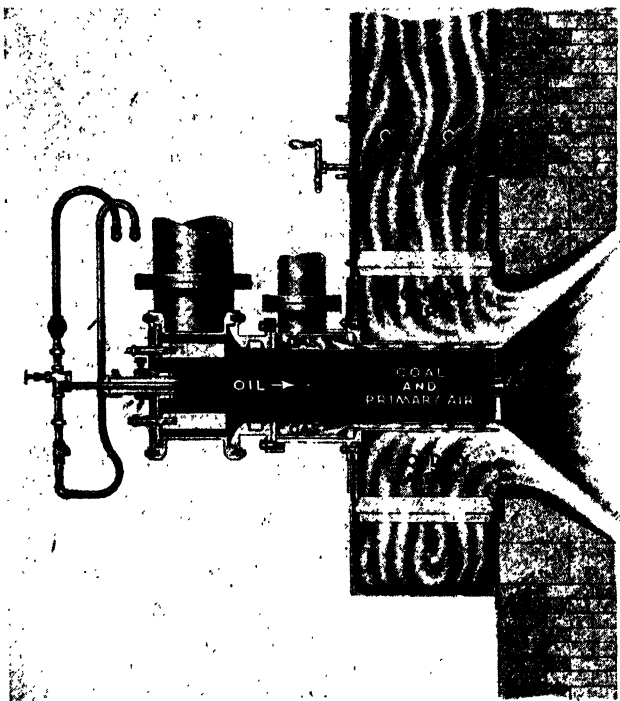

FIG. 13.—Combination burner (mounted) for pulverized coal and oil. (Courtesy of Riley Stoker Corporation.)

10 to 30 kwhr/ton, depending upon the “grindability” of the fuel (see Chap. I).

Pulverized-fuel Burners. Burners for pulverized coal are comparatively simple. Frequently (as in Fig. 13), the coal is simply jetted into the furnace by the air which has passed through the pulverizer, with enough more introduced to bring the total primary air up to about 50 per cent of the theoretical. Since most installations are in boilers, the secondary air is usually supplied as forced-draft, preheated and introduced through a “wind-box” opening around the burner. In Fig. 13, a wind box is seen in the mounting of a combination pulverized coal, oil, and gas burner. This mounting provides a swirling motion to both

primary and secondary air supplies by passing them through slanted, stationary blades arranged similarly to those of a fan impeller.

Air Preheaters. Somewhat more than half of the sensible heat in outgoing flue gas may be recovered by heat exchange with the incoming air. Air preheaters of the *recuperative* or *heat exchanger* type are the most common, although one *regenerative* type is widely used. Plain carbon steel is the general material of construction, but alloy steel equipment is available for longer life, higher temperature service, or unusually corrosive conditions.

The principal designs of recuperative heaters are tube, flat plate, and corrugated-plate types, the direction of flow between gas and air streams being either countercurrent or semicountercurrent. Figure 14 shows a tube-type unit. In the flat plate variety, air and gas pass through adjacent ducts formed by the plates which are mounted side by side and closed at the edges. In the corrugated-plate type, a corrugated plate is mounted between two flat plates forming separated, triangular ducts for the air and gases.

Installation of an air preheater on an existing furnace changes the operating conditions, resulting in higher furnace temperatures, less excess air, and an increase of furnace capacity. The ability of burners and furnaces to withstand the new conditions should be investigated before making a change. An increase in furnace temperature amounting to about three-fourths of the number of degrees of air preheat is to be expected. (For further discussion, see the section *Recuperation and Regeneration*, Chap. XVI.)

Fly-ash Separators. Of the fine pulverized fuel ash carried through the combustion chamber, 90 to 99 per cent of the material down to 20 microns in size can be removed by a "cyclone type" of separator. These depend upon centrifugal force to throw the ash out of the gas stream, against the wall of the separator where it slides down and into a dust

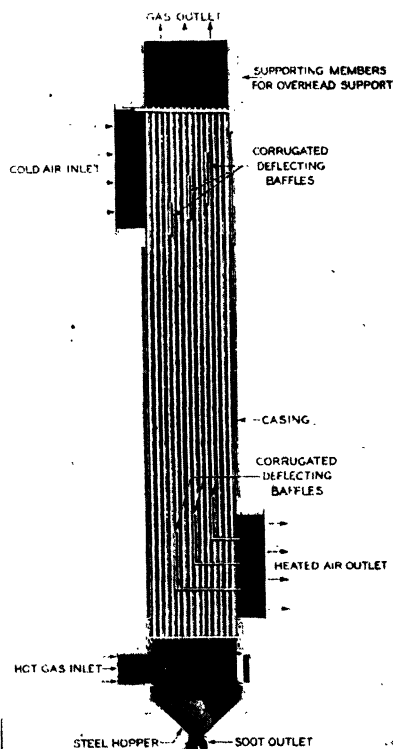

FIG. 14.—Air preheater. (Courtesy of Babcock and Wilcox Company.)

receiver. Since the centrifugal force available by imparting a swirling motion to the gas is limited, the speed of travel of the ash particles *through the gas* toward the wall is not great. Separators should therefore be constructed so that the dust will not have to travel far before reaching

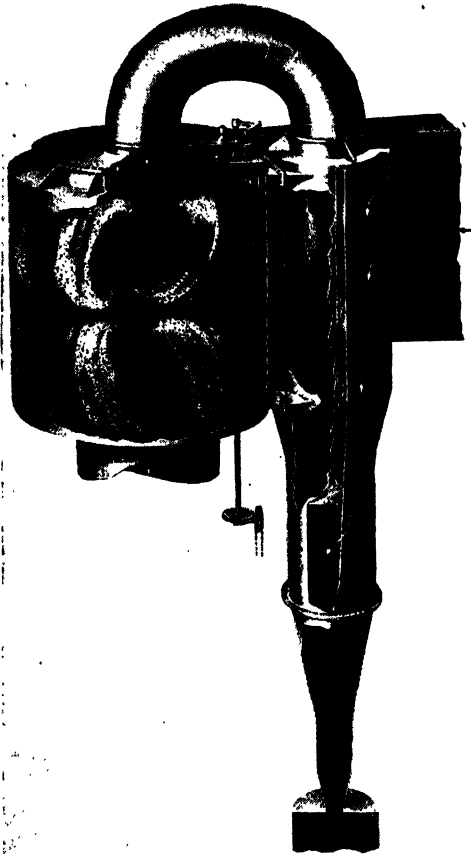

FIG. 15.—Compound cyclone type of fly-ash separator. (Courtesy of Buell Engineering Company.)

the wall. This is accomplished by making the cylinders of small diameter, and using several in parallel rather than a single large cone.

Figure 15 shows an ingenious compound separator, employing another well known principle of settling to remove the ash from large quantities of gas. The gas from the furnace enters the large cylinder tangentially from the rectangular duct at the right. This imparts a swirling motion to it which throws the dust out toward the periphery, leaving the gas near the center practically dust free even though all the dust has not yet collected at the wall. The clean gas goes through the vanes into the

central duct and out to the stack. The gas near the wall contains all the separable dust and flows through the narrow slot opening into the small-diameter secondary separator of conventional design. The cleaned gas from the secondary settler is led back into the larger outlet duct by the overhead U bend.

When it is necessary to remove the last traces of suspended solids (including smoke) from a gas stream, it may be accomplished by a high-voltage electrical precipitator (Cottrell patent).

An elevation drawing showing the various accessories as installed in a power plant is given at the end of the book.

Supplementary References

1. HASLAM and RUSSELL: "Fuels and Their Combustion," Chaps. XII–XV, McGraw-Hill Book Company, Inc., New York, 1926.
2. "Chemistry of Coal Utilization," Vol. II, Chap. 33, by M. A. Mayers; Chap. 34, by A. A. Orning, John Wiley & Sons, Inc., New York, 1945.
3. Symposium on Dust Collection, American Institute of Chemical Engineers, Chicago, Ill., Dec. 16, 1945.

Exercises

1. The firing rate of a coal-burning furnace is not so flexible in general, either in overall range or in quickness of response, as are units firing other types of fuels.
 - a. For what common applications is coal firing best suited? Explain.
 - b. Of the various methods for firing coal, which is the most suitable for a heat load that fluctuates widely and rapidly? Why is this method not used for all such applications?
2.
 - a. Discuss the characteristics of various coals which determine their suitability for use in overfeed and in underfeed or retort-type stokers.
 - b. Traveling-grate stoker installations can be designed to burn almost any fuel. Since this is so, why do traveling grates not predominate over all other types of stokers?
3. Discuss briefly the factors to be considered in deciding if it is advisable to install an air preheater in an existing boiler plant.
4. A certain pulverizer installation handles 18,000 lb/hr of a coal which enters the unit at 80°F containing 8 per cent moisture. 0.5 lb of air per pound of coal is blown through the unit to classify and carry out the pulverized fuel. The air is preheated to 600°F and is substantially dry. The pulverizer motor consumes 240 kw and is 90 per cent efficient. The specific heat of the dry coal is approximately 0.3.

Assuming that the pulverized fuel contains 1 per cent moisture, that the pulverized fuel and air attain the same temperature, and that the pulverizer loses no heat to the outside atmosphere, calculate

 - a. The heat required to dry out the coal (as at 80°F).
 - b. The outlet temperature of the air-coal stream.
 - c. The heat supplied by electrical power, as per cent of the total heat consumed in drying the coal and warming the coal and water vapor to the outlet temperature. (1 kwhr = 3412 Btu.)

CHAPTER XII

INTRODUCTORY HEAT TRANSMISSION

Heat transmission has to do with the calculation of rates of heat flow and related problems for many and varied conditions. There are three distinct mechanisms by which heat is transferred:

1. Conduction. When molecules are in close proximity, they tend to distribute and equalize their kinetic energy. The energy level or heat content of matter is a function of its temperature and, wherever a temperature gradient or difference exists, heat tends to flow to obliterate the gradient or difference. The mechanism is called *conduction* when the molecules remain in the same place or substantially so, as in solid materials.

2. Convection. Heat may be transferred by *bulk motion* of a hot fluid to cooler surroundings. For example, steam that is generated in a boiler may be passed through a pipe to a radiator where it gives up its heat.

The density of a fluid decreases when its temperature is raised, as required by its thermal coefficient of expansion. The expression, *heat rises*, is an abbreviated statement that hotter portions of a fluid—having lower density—set up convection currents or cause *natural convection*.

If a pump or other source of pressure differential is employed to cause the motion, it is designated *forced convection*.

3. Radiation. All surfaces transmit heat in the form of *waves* or *rays*. Heat rays are of the same nature as light but have lower frequencies that are in the infrared range. A given surface emits, absorbs, reflects, and transmits a different fraction of heat rays than of visible light. Solid substances that are transparent to light rays are only partly so to radiant heat. At high temperatures, polyatomic gases become effective emitters and absorbers of radiant energy.

Radiation from a given surface increases with the fourth power of its absolute temperature. At 200°F, heat *radiated* from a surface may be significant in comparison to that transmitted by conduction and convection. At higher temperatures, radiation increases in importance and becomes the predominant mechanism of heat transfer in and through gases.

MECHANISM OF HEAT TRANSFER BY CONDUCTION

Heat transfer through dense solids or homogeneous solids generally is considered to occur by conduction only. For unidirectional conduction

in homogeneous solids (and fluids where no convection currents are present), the absolute rate of heat transmission is proportional to the area normal to the direction of heat flow and to the temperature gradient parallel to heat flow. The algebraic statement of these conditions is *Fourier's law*:

$$\frac{dQ}{d\theta} = -kA \left(\frac{dt}{dL} \right) \quad (1)$$

where Q = quantity of heat, Btu

θ = time, hr

$\frac{dQ}{d\theta}$ = rate of heat transfer, Btu/hr

k = thermal conductivity; the proportionality constant

A = area of heat transfer; a plane *normal* to direction of heat flow, sq ft

t = temperature, °F

L = thickness, or distance that heat travels, ft

$-\left(\frac{dt}{dL} \right)$ = temperature gradient, °F/ft

Equation (1) defines thermal conductivity k . (Thermal conductivities of engineering materials are given in Appendix Tables 14-16.) When the units of the other quantities are as just given, the units of k must be

$$\text{Btu}/(\text{hr})(\text{sq ft})(\text{°F}/\text{ft}) = (\text{Btu})(\text{ft})/(\text{hr})(\text{sq ft})(\text{°F}) = \text{Btu}/(\text{hr})(\text{ft})(\text{°F})$$

Numerical values of thermal conductivities given in handbooks and elsewhere are frequently expressed in other sets of units such as centimeters, grams, seconds, and centigrade degrees. Any value may be converted into the above or any other set of units desired by multiplying by the proper conversion factor for each individual dimension. For example, the conversion factor to obtain thermal conductivity in *ft-lb-hr-F°* units from a value given in *cgs °C* units is the product of the individual factors:

$$\begin{aligned} k_{\text{Btu}/(\text{ft})(\text{hr})(\text{°F})} &= k_{\text{cal}/(\text{sec})(\text{cm})(\text{°C})} \\ &\times \left[\left(\frac{1 \text{ Btu}}{252 \text{ gm cal}} \right) \left(\frac{3,600 \text{ sec}}{1 \text{ hr}} \right) \left(\frac{30.5 \text{ cm}}{1 \text{ ft}} \right) \left(\frac{1\text{°C}}{1.8\text{°F}} \right) \right] \\ &= 242 k_{\text{cal}/(\text{sec})(\text{cm})(\text{°C})} \end{aligned}$$

For conditions in which the *temperatures* at several points along the direction of heat flow remain constant, the *temperature gradient* is fixed, and the *rate of heat flow is constant*. Equation (1) then becomes

$$q = \frac{Q}{\theta} = -kA \left(\frac{dt}{dL} \right) \quad (2)$$

which applies to *steady-state* heat flow.

If the cross-sectional area of the path of heat flow is also constant, as for heat traveling along a wire or through a flat wall, integration of Eq. (2) gives

$$q = \frac{Q}{\theta} = \frac{kA(t_2 - t_1)}{L} = \frac{kA\Delta}{L} \tag{3}$$

- where q = rate of heat flow, Btu/hr
- t_2 = higher temperature, °F
- t_1 = lower temperature, °F
- Δ = temperature difference, °F
- L = distance between points of t_1 and t_2 , ft

Equation (3) is commonly known as *Fourier's law of heat conduction*. Heat flow can be compared to the flow of direct-current electricity, since both are proportional to a potential difference or driving force, and

inversely proportional to a resistance. Ohm's law for the conduction of electricity

$$I = \frac{E}{R'}$$

where I = direct current, amp (coulombs/sec)

E = potential difference, volts

R' = electrical resistance, ohms

is seen to be similar to the law of conduction of heat when thermal conductance (kA/L) is replaced by its reciprocal, thermal resistance (R),

$$q = \frac{\Delta}{R} \tag{3a}$$

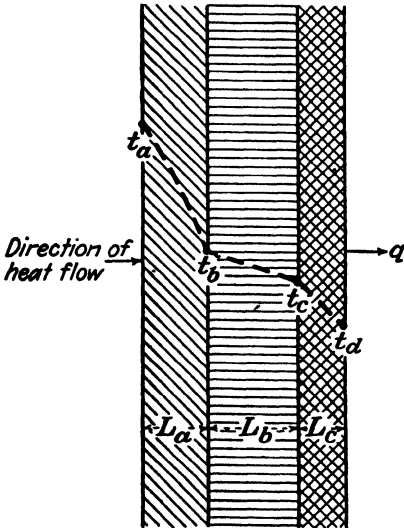

FIG. 1.—Temperature drops through resistances in series (conduction).

In both cases, resistances connected in series are additive, and conductances connected in parallel are additive.

Heat Transfer through Resistances in Series. For steady flow, all the heat must travel through each of a series of resistances, making the *heat current* the same through each (Fig. 1). Temperatures automatically adjust themselves to provide this condition. Let $q = q_1 = q_2 = q_3$ be the heat flow through a series of resistances. Rearranging Eq. (3) gives

$$q \frac{L_1}{k_1 A_1} = \Delta_1, \quad q \frac{L_2}{k_2 A_2} = \Delta_2, \quad q \frac{L_3}{k_3 A_3} = \Delta_3 \dots$$

Also, $\Delta_1 = (t_a - t_b)$, $\Delta_2 = (t_b - t_c)$, $\Delta_3 = (t_c - t_d)$. These combine into

$$q = \frac{\Delta_1 + \Delta_2 + \Delta_3}{\frac{L_1}{k_1 A_1} + \frac{L_2}{k_2 A_2} + \frac{L_3}{k_3 A_3}} = \frac{t_a - t_d}{R_1 + R_2 + R_3} = \frac{\Delta}{\Sigma R} \quad (3b)$$

Equation (3b) defines R and ΣR . For constant cross section of path of heat conduction such as through flat walls or slabs, $A = A_1 = A_2 = A_3$, and the area term may be factored.

Heat-transfer Area of Thick-walled Cylinders. There are many industrially important cases of heat transfer through resistances in series where the areas are not equal or even approximately so. The most common case is that of a heavily insulated pipe. If A_{av} is defined by the relation,

$$q = \frac{k A_{av} \Delta}{L}$$

it may be shown that

$$A_{av} = \frac{A_2 - A_1}{2.3 \log_{10} (A_2/A_1)} \quad (4)$$

where A_2 and A_1 are the outer and inner surface areas of the cylinder of the pipe insulation for the case just mentioned. Equation (4) gives the *logarithmic mean* (l m) area for heat conduction. The log mean area is always smaller than the arithmetic average area $(A_2 + A_1)/2$, but where the ratio (A_2/A_1) is between 0.5 and 2.0, the two means differ by less than 4 per cent. The simpler arithmetic average may then be used, since the precision of other data in a problem seldom justifies greater accuracy in calculations.

Mean Temperature Difference in Heat Exchangers. In a tubular exchanger, heater, or cooler, the *temperature difference* changes continuously from one end of the apparatus to the other. The arithmetic average temperature difference is not the correct average value unless the temperature differences at the two ends are nearly equal.

Assuming constant specific heats and a constant overall heat-transfer coefficient, it can be shown that for certain important cases the proper temperature difference for use in the heat-transfer equation is the *logarithmic mean temperature difference*:

$$\Delta_{lm} = \frac{\Delta_1 - \Delta_2}{2.3 \log (\Delta_1/\Delta_2)} \quad (5)$$

where Δ_1 and Δ_2 are the temperature differences at the ends of the apparatus. The logarithmic mean temperature difference applies to the following cases:

1. Concurrent and counterflow heat exchangers having a single pass for each fluid, as in concentric double-pipe apparatus.

2. Heaters and coolers in which one fluid is at a constant temperature, such as a condensing vapor or a boiling liquid.

A correction must be made to Eq. (5) when applied to multipass heat exchangers.¹

SURFACE FILM COEFFICIENTS

Convection Mechanism. There are two general mechanisms by which a fluid may travel through a pipe or duct: (1) viscous, laminar, or streamline, and (2) turbulent motion.

1. In *viscous flow*, all particles of the fluid travel parallel to the axis of the pipe. A portion of the fluid at a given distance from the wall remains in the same relative position as it flows along the straight pipe.

2. In *turbulent flow*, elements in the main portion of the stream move back and forth over the cross section of the pipe in a random motion, in addition to their net flow along the axis of the pipe.

High values of diameter (D), velocity (V), and density (ρ) with low values of viscosity (μ) create turbulence. The group combining these variables is known as the *Reynolds number* ($DV\rho/\mu$) and is a quantitative measure of the existence and degree of turbulence (see Chap. IX).

Even in highly turbulent flow there is a thin fluid layer or film adjacent to the pipe wall, which remains in viscous flow. Micro velocity measurements starting at the pipe wall give the type of curve shown in Fig. 2.

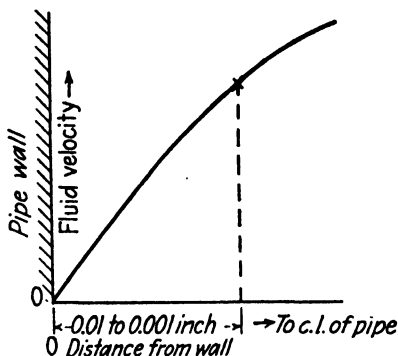

FIG. 2.—Fluid film at pipe wall.

The velocity is zero at the wall and increases almost linearly for a short distance out from it. This portion of the curve (theoretically parabolic) is experimental evidence of the existence of the film, and correlations based upon the *film theory* are triumphs of modern chemical engineering. The Reynolds number is quantitatively

related to film thickness and appears in all correlations of heat-transfer *film coefficients*.

Heat must flow through the film by the mechanism of conduction, before being swept away by eddies in the rapidly moving main body of the stream.

Heat-transfer film coefficients are calculated from experimental heat-transfer data. They are actually ratios of the thermal conductivity to the *effective film thickness*:

¹ See p. 971 of Supplementary Reference 1.

$$h = \frac{k}{L_{\text{eff}}}$$

It is seldom necessary to know each variable separately. The *film coefficient* is actually a *specific conductance* and is combined into the summation equation as such. In other words, if the ratio (k/L) is known, k and L need not be individually known. If h_i and h_o are the film coefficients for the inside and outside surfaces of a pipe wall, respectively, Eq. (3a) applied from inside fluid to outside fluid becomes

$$q = \frac{\Delta}{\left(\frac{1}{hA}\right)_i + \left(\frac{L}{kA_{\text{av}}}\right)_w + \left(\frac{1}{hA}\right)_o} \quad (3c)$$

In the case of metallic heating or cooling tubes surrounded by and filled with fluids, the fluid films ordinarily offer much greater resistances to heat transfer than does the tube wall. It is then said that the films

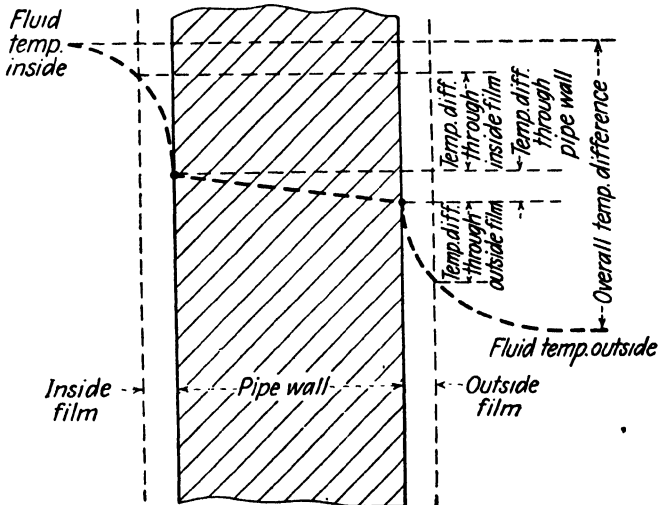

FIG. 3.—Temperature drops through fluid films and pipe wall.

offer the *controlling resistance* to heat transfer (Fig. 3). The common ranges of fluid film coefficients are given in Table 1. Gas films have particularly high resistances. The conduction mechanism must be depended upon to transfer heat across a film, and the thermal conductivity of air is very low. In fact, second to high vacuum, the best heat-insulating materials are those containing a large number of very small air-filled pore spaces.

Thin films of foreign material such as dirt, scale, or products of corrosion frequently introduce appreciable resistances to heat transfer.

TABLE 1.—FLUID FILM COEFFICIENTS

	Usual range of values, h , Btu per hr per sq ft per °F			
	Gases	Water	Nonviscous liquids	Viscous liquids
Inside pipes.....	10-50	200-2000	50-500	10-100
Outside pipes:				
Natural convection.....	1-3	20-200	2-50
Forced convection.....	5-20	100-1000	50-200	10-100
Boiling liquid:				
Inside pipes.....	500-5000		
Outside pipes.....	300-9000	200-2000	
Condensing vapor.....	1000-10,000	200-400	50-100

They present comparatively rough surfaces and maintain thicker films than would otherwise exist. Typical values of "fouling coefficients" to be included in the summation of resistances to heat transfer are given in Table 2.

TABLE 2.—FOULING COEFFICIENTS

	Usual Range of Values, h , Btu per Hr per Sq Ft per °F
Steam.....	1500-3000
Clean water.....	500-2000
Dirty water.....	150- 500
Petroleum vapors and condensates.....	200-2000
Petroleum residuals and crudes.....	100- 200

The effects of fouling are not great when overall heat-transfer coefficients are small, but they become important as the overall coefficients increase. The *condition* of the heat-transfer surface whether polished or rough, perfectly clean or slightly fouled, has a marked effect upon high values of the *overall coefficients*, and particularly so for boiling liquids and condensing vapors. However, correlations of film coefficients in terms of flow rate, dimensions of apparatus, and the properties of the fluid for the cases of greatest engineering importance enable the *prediction* of film coefficients for clean apparatus² with a probable error of less than 25 per cent.

Heat loss coefficients for horizontal bare pipes in quiet air are correlated on Fig. 4. These are for *total* heat loss which includes radiation. Figure 4 may also be used to estimate heat loss from lagged pipes. For the latter purpose, the temperature and the diameter of the *outside surface of the insulation* should be used instead of pipe temperature and nominal pipe diameter.

² See pp. 111-132 of Supplementary Reference 4.

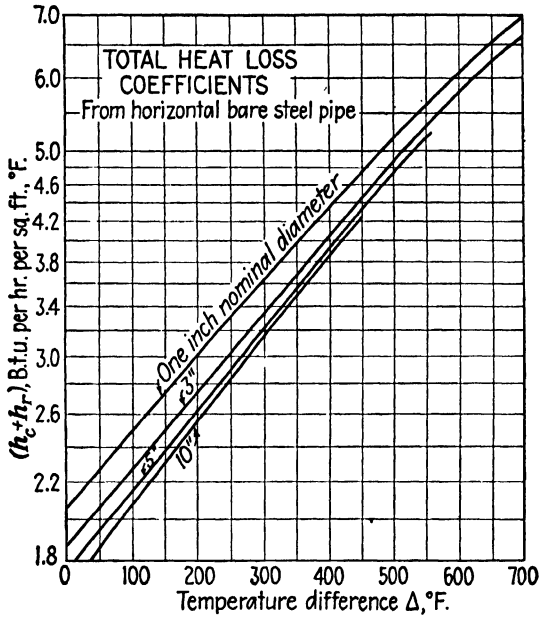

FIG. 4.

Illustration 1

The flat vertical walls of a furnace are constructed of 4 in. of a high-temperature brick ($k = 0.75$) inside of and sealed to 8 in. of insulating brick ($k = 0.06$). The temperature of the inside surface is 2200°F . The outside surface film coefficient ($h_c + h_r$) is 2.0, and the air temperature is 90°F .

- a. What is the heat loss through the furnace wall, as Btu per square foot per hour?
- b. What are the temperatures at the inside and outside surfaces of the insulating brick?

Solution: a. Since the walls are flat, all heat-transfer areas are the same. For 1 sq ft, the heat loss is

$$q = \frac{\Delta}{\frac{L_1}{k_1} + \frac{L_2}{k_2} + \frac{1}{h}} = \frac{2200 - 90}{\frac{4}{0.75} + \frac{8}{0.06} + \frac{1}{2.0}} = 175 \text{ Btu/hr}$$

b. With the layers of brick well bonded together, the inside of the insulating brick and the outside of the high-temperature brick will have the same temperature. The temperature drop through the high-temperature brick is

$$t_a - t_b = \frac{qL}{k} = \frac{(175)(\frac{4}{0.75})}{0.75} = 78^\circ$$

and the inner temperature is $2200 - 78 = 2122^\circ\text{F}$. The temperature of the outer furnace wall surface is

$$t = 90 + \frac{q}{h_c + h_r} = 90 + \frac{175}{2.0} = 178^\circ\text{F}$$

Illustration 2

A standard 1½-in. pipe is carrying saturated steam at 180 psig through a room at 70°F. It is insulated with 2 in. of magnesia lagging ($k = 0.045$). Thermal conductivity of the pipe wall is 30. Per 100 linear ft, calculate

- The heat loss, expressed as Btu per hour.
- The film coefficient ($h_c + h_r$) from the surface of the lagging to the room.
- The temperature drop through the pipe wall.

Solution: The controlling resistance to heat loss from a well-insulated pipe is the insulation itself. In calculating heat loss, the temperature drop through the pipe wall may be neglected. For 2 in. of good insulation on pipes of 1 in. in diameter or greater, the surface temperature will be about 25°F above that of the room, or $70 + 25 = 95^\circ\text{F}$ in this case.

The temperature of saturated steam at 180 psig is 373°F. From Table 12 in the Appendix, standard 1½-in. pipe is 1.9 in. o.d. and 1.61 in. i.d.

The outside area of the pipe is

$$(100) \left(\frac{1.9}{12} \right) = 49.7 \text{ sq ft}$$

The area of the outside insulation surface is

$$(49.7) \left(\frac{1.9 + 4}{1.9} \right) = 154.5 \text{ sq ft}$$

Since the ratio of diameters through the insulation is greater than 2, the log mean area must be used

$$A_{lm} = \frac{154.5 - 49.7}{2.3 \log \left(\frac{154.5}{49.7} \right)} = 92.6 \text{ sq ft}$$

- The heat loss from the pipe is

$$Q = \frac{kA_{lm}\Delta}{L} = \frac{(0.045)(92.6)(373 - 95)}{\frac{1}{2}} = 6950 \text{ Btu/hr}$$

- The film coefficient from the lagging surface is

$$(h_c + h_r) = \frac{Q}{(A_s)(\Delta_s)} = \frac{6950}{(154.5)(25)} = 1.8 \text{ Btu/(hr)(sq ft)(}^\circ\text{F)}$$

This checks Fig. 4 closely.

- The temperature drop through the pipe wall (pw) is

$$\Delta_{pw} = \frac{QL}{kA_{pw}} = \frac{(6950) \left(\frac{1.9 - 1.61}{2 \times 12} \right)}{(30) \times (49.7) \left(\frac{1.9 + 1.61}{2 \times 1.9} \right)} = 0.061^\circ\text{F}$$

OVERALL HEAT-TRANSFER COEFFICIENTS

For convenience in solving heat-transfer problems, thermal resistances in series through solids, scale, and fluid films may be combined into a single *total resistance*, (ΣR).

The overall heat-transfer coefficient is then defined as U in the equation

$$q = U A \Delta = \frac{\Delta}{\Sigma R}$$

For example, a heater tube may have fluid film resistances and scale on both sides, and a resistance through the wall itself.

$$\frac{1}{U} = A(\Sigma R) = A(R_{\text{outside film}} + R_{\text{outside scale}} + R_{\text{tube wall}} + R_{\text{inside scale}} + R_{\text{inside film}})$$

$$= A \left[\left(\frac{1}{h_o A_o} \right) + \left(\frac{1}{h_s A_o} \right) + \left(\frac{L}{k A_w} \right) + \left(\frac{1}{h_s A_i} \right) + \left(\frac{1}{h_i A_i} \right) \right] \quad (6)$$

TABLE 3.—OVERALL HEAT-TRANSFER COEFFICIENTS^a
Usual range of values. U , Btu per hr per sq ft per °F

Type of heat exchanger	State of controlling resistance		Typical fluid	Typical apparatus
	Free convection, U	Forced convection, U		
Liquid to liquid.....	{ 25-60 5-10	150-300	Water	Liquid-to-liquid heat exchangers
Liquid to gas (atm press).....		20-50	Oil	
Liquid to boiling liquid.....	{ 20-60 5-20	50-150	Water	Hot-water radiators Brine coolers
Gas (atm press):		25-60	Oil	
To liquid.....	1-3	2-10	Air coolers, economizers
To gas.....	0.6-2	2-6	Steam superheaters
To boiling liquid.....	1-3	2-10	Steam boilers
Condensing vapor to liquid.....	{ 50-200 10-30 40-80	150-800	Steam-water	Liquid heaters and condensers
		20-60	Steam-oil	
		60-150	Organic vapor-water	
		15-300	Steam-gas mixture	
Condensing vapor to gas (atm press).....	1-4	2-10	Steam pipes in air, air heaters
Condensing vapor to boiling liquid.....	{ 40-100 300-1200 50-150	Scale-forming evaporators
		Steam-water	
		Steam-oil	

^a Compiled chiefly from p. 1000 of "Chemical Engineers' Handbook," 2d ed., McGraw-Hill Book Company, Inc., New York, 1941.

Subscripts f , s , w , o , and i refer to film, scale, wall, outside, and inside properties, respectively.

Where the inside and outside areas are not the same, as for the case just mentioned, the value of U will depend upon which area is chosen. For the *outside* of a tube of diameter D , Eq. (6) can be written

$$\frac{1}{U_o} = A_o(\Sigma R) = \left(\frac{1}{h_f}\right)_o + \left(\frac{1}{h_s}\right)_o + \left(\frac{D_o}{D_w}\right)\left(\frac{L}{k}\right)_w + \left(\frac{D_o}{D_i}\right)\left(\frac{1}{h_i}\right)_i + \left(\frac{D_o}{D_i}\right)\left(\frac{1}{h_f}\right)_i \quad (6a)$$

The ranges of overall heat-transfer coefficients for the more common cases are given in Table 3.

HEAT TRANSFER BY RADIATION

Since thermal radiation is akin to visible light, most solids, liquids, and gases that are transparent to light will transmit some fraction of heat rays that may strike them. Opaque materials are opaque to radiant heat or nearly so, and highly reflective surfaces reflect heat rays efficiently. There are some exceptions to these observations, but in general the transparency of a substance is lower for heat than for light rays.

Radiant heat transfer is usually significant wherever a high-temperature surface capable of radiating can "see" another surface at a lower temperature. In cases of engineering importance, radiant energy passes through an atmosphere of air and, in a furnace, it originates in the luminous flame and nonluminous combustion gases, H_2O , CO_2 , CO , SO_2 . However, radiant heat-transfer equations were originally developed by studies of heat emitted from and received by *solid surfaces* and treatment of radiation from nonluminous gases, luminous flames, and clouds of luminous particles was developed later.

Surface Emissivity. A given surface *emits* radiant heat at a definite rate at a fixed temperature. Some surfaces emit at higher rates than others, but at any given temperature there exists a *definite maximum rate* per unit area for a theoretically perfect radiator. Such a surface is called a *blackbody* (bb). Actual surfaces emit less than the blackbody surface, and the term *emissivity* (ϵ) is the *ratio of heat emitted by an actual surface to that of a blackbody of the same area and at the same temperature*.

$$\epsilon = \frac{q_{act}}{q_{bb}}$$

Emissivities of polished metal surfaces are very low but are greatly increased by the presence of slight films of oxide or of tarnish. Emissivities of engineering materials and equipment surfaces under conditions

of use are between 0.7 and 0.9 in most cases.* Although heat rays can be reflected and focused, they leave an emitting source almost completely scattered or diffuse, as does light (hemispherical radiation).

Surface Absorptivity. Of the radiation striking or incident to a surface, part is reflected (refl) and the remainder is absorbed (abs). A perfect absorbing surface must therefore be totally unreflective and is also designated *blackbody*. Absorptivity (α) is the *fraction of incident radiant energy which a surface absorbs*:

$$\alpha = \frac{q_{\text{abs}}}{q_{\text{bb}}} = \frac{q_{\text{abs}}}{q_{\text{abs}} + q_{\text{refl}}}$$

For most materials, absorptivities increase slowly with the temperature. It may be shown from Kirchoff's law that absorptivity and emissivity of a given surface are numerically equal (both source and receiver) at the same temperature. For practical heat-transfer surfaces, both coefficients are comparatively high. Since they change only slowly with temperature, they are often numerically close so that one may be substituted for the other with but slight error. Algebraically,

$$\alpha = \epsilon \quad (\text{approx})$$

Radiation Equations.³ The Stefan-Boltzmann law states that the intensity of radiant heat emitted from the surface of a body increases proportionately to the fourth power of its absolute temperature. This may be simply given in a usable form:

$$\frac{q_r}{A} = 0.173\epsilon \left(\frac{T}{100} \right)^4 \quad (7)$$

where q_r = total heat loss by radiation Btu/hr

A = area of radiating surface, sq ft

0.173 = Stefan-Boltzmann radiation constant $\times 10^8$, Btu/(hr) (sq ft) $(^\circ\text{R}/100)^4$

ϵ = emissivity, used as a constant

T = surface temperature, $^\circ\text{R} = (460 + ^\circ\text{F})$

Equation (7) assumes that all points of the surface are at the same temperature and that its emissivity is uniform. It is exact only for surfaces having no concavities, *i.e.*, no portion of the surface "sees"

* Throughout the book, *emissivity* is used in the sense of *specific emittance*, since this usage is entrenched in the engineering literature. Accordingly, a numerical value for a material depends upon the nature, condition, and roughness of its surface as well as upon temperature.

³ Equations (8)-(12) and Fig. 5 were developed and presented by Hottel. Pp. 1002-1029 of Supplementary Reference 1; also pp. 25-80 of Supplementary Reference 3.

any other portion. It gives *total* radiation. When the surroundings are at any temperature above absolute zero, a body *receives* some radiation from surroundings and its net rate of heat loss is less than given by Eq. (7). However, if the surface temperature of the body is as much as several hundred degrees higher than that of the surroundings, Eq. (7) gives a close approximation of actual heat loss by radiation.

In the case of greatest interest, there are two surfaces at different temperatures interchanging radiant heat. For a hypothetical configuration in which each surface "sees" nothing but the other (as approximated by large concentric shapes with small spaces between surfaces), the radiant heat *transfer* is

$$\frac{q_{\text{net}}}{A_1} = 0.173 \left[\epsilon_1 \left(\frac{T_1}{100} \right)^4 - \alpha_{1,2} \left(\frac{T_2}{100} \right)^4 \right] \quad (8)$$

as *Btu per square foot of one surface per hour*.

Although the notation can be reversed, the surface at the higher temperature is usually designated by subscript 1. $\alpha_{1,2}$ denotes the absorptivity of surface 2 at T_2 for the quality of radiation originating at T_1 . Since both surfaces emit and receive radiation, albeit at different temperature levels, Eq. (8) is exact only when

$$\epsilon_1 = \epsilon_2 = \alpha_{1,2} = \alpha_{2,1}$$

Fortunately, numerical values of these four coefficients are sufficiently close for cases of practical interest to permit their combination into a generalized factor.

In a second hypothetical case, the surfaces are totally black but are not completely interenclosing. An equation which can be applied is

$$\frac{q_{\text{net}}}{A} = 0.173 \left[\left(\frac{T_1}{100} \right)^4 - \left(\frac{T_2}{100} \right)^4 \right] F \quad (9)$$

where F is a *geometrical factor* to account for shape and orientation of the surfaces. Numerical values of F for several of the more important configurations have been worked out and are presented as graphs in the references noted. For the purposes of this chapter, Fig. 5 for radiation between parallel planes will suffice.

In a third hypothetical case, the surfaces are again totally black, and the source and sink surfaces are interenclosed by nonconducting but reradiating surfaces or walls. This condition is fulfilled by an empty muffle furnace, the muffle of which is heated through the floor only, and heat is removed only through the roof. This is *approximated* by a furnace having a flat fuel bed with a cold heat-absorbing surface above and parallel to it. For such a configuration, \bar{F} is substituted for F in Eq. (9).

Values of \bar{F} for parallel planes are also given in Fig. 5, and may be calculated from F by the relation

$$\bar{F}_{1,2} = \frac{A_2 - A_1(F_{1,2})^2}{A_1 + A_2 - 2A_1F_{1,2}} \tag{10}$$

Values of \bar{F} for single and double rows of tubes near a refractory surface are given in Fig. 20 of Chap. XV.

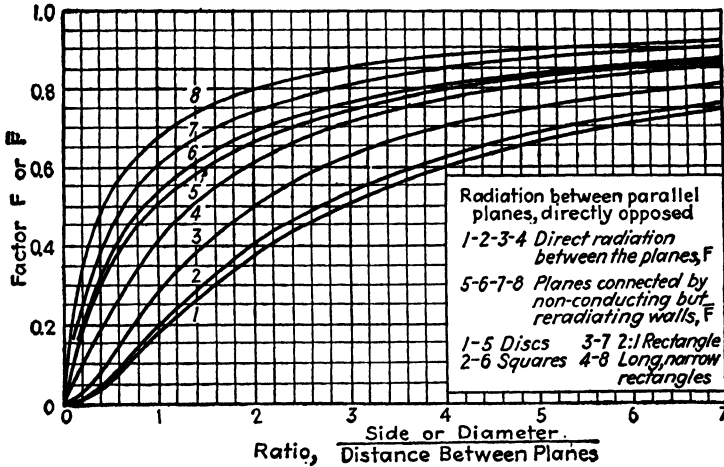

FIG. 5.—(Courtesy of H. C. Hottel.)

For the same hypothetical conditions assumed in developing Eq. (10), radiant heat-transfer equations between the source, reradiating walls, and sink have been solved for the *wall surface temperature*, giving

$$T_w = \sqrt[4]{\frac{(A_1 - A_1F_{1,2})T_1^4 + (A_2 - A_1F_{1,2})T_2^4}{(A_1 - A_1F_{1,2}) + (A_2 - A_1F_{1,2})}} \tag{11}$$

In actual combustion chambers, the surfaces are never totally black. To allow for emissivities and absorptivities below unity, F or \bar{F} of Eq. (9) is replaced by \mathfrak{F} .

By assuming uniform temperatures of source and sink surfaces, Hottel developed the relation

$$\frac{1}{\mathfrak{F}_{1,2}} = \frac{1}{\bar{F}_{1,2}} + \left(\frac{1}{\epsilon_1} - 1\right) + \frac{A_1}{A_2} \left(\frac{1}{\epsilon_2} - 1\right) \tag{12}$$

Radiation between hot and cold surfaces (sources and sinks) in a furnace may be calculated by successively evaluating F , \bar{F} , and \mathfrak{F} then using \mathfrak{F} so obtained in Eq. (9). For illustrations, see the references cited.

Gas Radiation. In working out the factors for the preceding equations, the assumption was made that air or other gas between the radiating surfaces is *transparent* to radiant energy. However, polyatomic gases and CO absorb and emit appreciable quantities of radiation. For usual

combustion conditions in a furnace of medium size, as much heat is radiated directly from the gases to the surroundings as would be emitted by a hypothetical surface of equivalent size and temperature, that had an emissivity factor somewhere between 0.05 and 0.3. Gas radiation is often a major item in furnace heat transfer, and the preceding equations alone are inexact for furnace calculations since gas radiation is not included in them.

Gas-radiation charts in usable form have been developed by introducing the concept of the "mean length of radiant beam"; in other words, an effective thickness of gas layer with respect to radiant heat emission by the gas itself. Charts for nonluminous gas radiation, for correction of *radiation interference* due to CO_2 and H_2O being present together in flue gases, and for luminosity of flames are given in the same references. Radiation from pulverized coal flames has been treated in a series of articles by Hottel.⁴

The Combustion Chamber. The present state of knowledge does not readily permit an absolutely exact calculation of the heat transferred within a specific furnace by all mechanisms. If a continuous furnace operating under steady conditions is selected, such a calculation involves the following heat balances:

1. The *heat given up by the gases within the furnace* = q_g , expressed in terms of the heat of burning the fuel and sensible heat in all gases entering and leaving the furnace.

2. The same quantity (q_g) is equal to the heat lost from flame and gases by radiation and convection to the stock or tube surfaces and to the refractory walls.

3. The *heat absorbed by the stock or tube surfaces* (q_p) is equal to the radiant heat received from flame and gases, secondary radiation from the furnace walls, and from gas convection.

4. By a *heat balance on the refractory walls*, their heat received from the flame, gas radiation, and convection equals their secondary radiation to the cold surfaces plus the heat loss transmitted through the walls to the outside.

The refractory walls may acquire a temperature either higher or lower than the adjacent gas layer, depending upon the type of furnace and local conditions. These four respective heat balances expressed symbolically are

$$(1) \quad q_g = q_f + q_1 - q_2$$

$$(2) \quad q_g = (q_{cs} + q_w)_{\text{flame}} + (q_{cs} + q_w)_{\text{gas}} + (q_{cs} + q_w)_{\text{conv}}$$

$$(3) \quad q_p = (q_{cs})_{\text{flame}} + (q_{cs})_{\text{gas}} + (q_{cs})_w + (q_{cs})_{\text{conv}}$$

$$(4) \quad (q_w)_{\text{flame}} + (q_w)_{\text{gas}} + (q_w)_{\text{conv}} = (q_{cs})_w + q_{\text{loss}}$$

⁴ *Ind. Eng. Chem.*, **32**, 719 (1940) and earlier.

- where q_1 = sensible heat content of fuel and air entering furnace
 q_2 = sensible heat content of flue gases leaving furnace
 q_f = heat of burning of fuel
 q_g = total heat given up by (removed from) gases in the furnace
 q_p = total heat absorbed by cold stock or tube surfaces (cs)
 q_{cs} = heat received by stock or by tube surfaces (cold surface) from the individual source designated
 q_w = heat received by refractory wall from individual source designated
 q_{loss} = heat loss by conduction to refractory wall to outside

Subscripts outside parentheses:

conv = heat transferred by convection; all other items are by radiant transfer

w = refractory wall

Before these heat balances can be solved readily, certain simplifying approximations must be made. The choice of simplifications depends upon the particular problem. For further study, the supplementary references may be consulted.

Supplementary References

1. PERRY, J. H.: "Chemical Engineers' Handbook," 2d ed., Chap. 7, McGraw-Hill Book Company, Inc., New York, 1941.
2. BADGER and McCABE: "Elements of Chemical Engineering," 2d ed., Chap. IV, McGraw-Hill Book Company, Inc., New York, 1936.
3. McADAMS, W. H.: "Heat Transmission," 2d ed., McGraw-Hill Book Company, Inc., New York, 1942.
4. WALKER, LEWIS, McADAMS, and GILLILAND: "Principles of Chemical Engineering," 3d ed., Chap. IV, McGraw-Hill Book Company, Inc., New York, 1937.
5. SCHACK, A.: "Industrial Heat Transfer," John Wiley & Sons, Inc., New York, 1933.

Exercises

1. A certain furnace has a flat wall made up of 6 in. of firebrick, 10 in. of kieselguhr brick, and 8 in. of building brick. If the inside and outside temperatures of the wall are 1000 and 100°C, respectively, calculate the temperatures of the inner and outer surfaces of the kieselguhr brick, as °C. (k for firebrick = 0.75, for kieselguhr brick = 0.08, for building brick = 0.5.)

2. The following data were obtained in a test on a flat, vertical furnace wall, the lining of which consisted of 4.5 in. of firebrick of unknown heat conductivity and the outer wall of 9 in. of clay brick, also of unknown conductivity.

Temperature of inner wall.....	1400°F
Temperature of outer wall.....	310°F

The furnace was then lagged with 2 in. of mineral wool ($k = 0.035$), thermocouples inserted at various points, and the following data taken:

<i>Temperature</i>	<i>°F</i>
Inner wall.....	1400
Outer surface of firebrick.....	1295
Outer surface of clay brick.....	1020
Outer surface of mineral wool.....	170
Room.....	70

Calculate

- a. The thermal conductivities of each kind of brick.
- b. The percentage of the heat loss that is saved by the mineral wool.
- c. The film coefficient ($h_c + h_r$) from the surface of the wall to the room, for each case.

3. A steam-jacketed kettle is made of wrought iron 0.5 in. thick. The steam temperature is 230°F, and the steam film resistance may be neglected. The liquid being heated shows a film coefficient of 150. A lead lining $\frac{1}{8}$ in. thick is to be installed in the kettle.

Calculate

- a. The overall heat-transfer coefficient before installation of the lining.
- b. The overall heat-transfer coefficient if the lining is hammered into place, leaving average 0.005 in. air space between it and iron. (Neglect radiation; $k_{\text{air}} = 0.017$.)
- c. The overall heat-transfer coefficient if the lining is fused to the iron.

4. A heater tube with steam on the outside and an organic liquid inside is made of aluminum ($k = 120$) and is 0.607 in. i.d. with a wall thickness of 0.134 in. Taking a steam film coefficient of 3,000, a steam-side scale coefficient of 1,000, a liquid film coefficient of 280, and a liquid-side scale coefficient of 1,800, calculate

- a. The overall heat-transfer coefficient, based on the inside area of the tube.
- b. The overall heat-transfer coefficient, based on the outside area of the tube.
- c. The overall heat-transfer coefficient, based on the average area of the tube.

5. A shell-and-tube heater is used to preheat 200 gph of a heavy fuel oil from 50 to 180°F. The heater contains a bundle of tubes 0.902 in. i.d. and 6 ft long. An equal portion of the oil flows through each tube. The oil enters at one end and leaves at the other end, making but a single pass through the heater. The heating medium is saturated steam (outside the tubes) at such a pressure that it condenses at 250°F.

- a. What is the proper value of Δ , the correct average temperature difference from steam to oil?
- b. If the steam condensate is removed at condensing temperature, the average specific heat of the oil is 0.6 and its density 7.5 lb/gal, how many pounds per hour of steam must be supplied?
- c. How many tubes are needed if the overall heat-transfer coefficient based on the *inside* tube area is 30?

6. A ladle of molten iron at 2600°F is 12 in. in diameter at the surface of the metal. The emissivity of the molten surface is 0.3. Neglecting heat loss through the fireclay body of the ladle, calculate the *rate* of cooling as degrees per minute due to radiation from the metal surface. The ladle holds 600 lb and the heat capacity of iron at this temperature is 0.28.

7. A standard 1-in. water pipe line is laid on the surface of the ground. At night, the air, pipe, and ground temperatures are all 32°F. The pipe radiates heat from half of its surface to the sky, which is at absolute zero. How long will it take the pipe to freeze solid? The emissivity of the pipe surface is 0.62.

CHAPTER XIII

FURNACE REFRACTORIES

Refractories are ceramic structural materials used in high-temperature processes for the following general purposes:

1. Confining or handling hot gases, liquids, and solid materials.
 - a. Thermal insulators (furnace walls, linings, etc.).
 - b. Heat conductors (muffles, retorts, recuperators, etc.).
2. Storing heat in cyclical operations (regenerators).

Item (1a) is of much the greatest importance. All refractories must retain both their shapes and certain strength at high operating temperatures. The serviceability of any given type is, however, less dependent upon its fusing temperature than upon other properties, chiefly, *high-temperature strength*, and *resistance to abrasion, to spalling, and to chemical fluxing or slagging*.

Furnace refractories are made in a variety of sizes and shapes for straight walls and arches, and for stack, kiln, and other cylindrical linings. The standard 9-in. straight brick is 9 by $4\frac{1}{2}$ by $2\frac{1}{2}$ in. Granular refractory materials as well as refractory cements and mortars are also used in large quantities.

The ASTM¹ has standardized a number of tests on the physicothermal behavior of refractories and certain of their raw constituents, which tests are valuable as guides to specifications for and comparison of different products. A comprehensive treatise on refractories is available in the book by Norton (see Supplementary Reference 1).

PYROMETRIC CONES

Since the refractory is an integral part of a furnace, the temperature at which it softens or loses its strength is of much greater practical importance than the temperature at which it actually fuses. Fireclay materials exhibit a wide and often unpredictable spread between these two temperatures. Softening temperatures of fireclay materials and silica cements are determined by making up small "cones" of the material to be tested and by comparing their behavior with that of cones of standard composition having the same size and shape. The *pyrometric cone equivalent* (PCE) is the designated number of the standard cone that softens and bends simultaneously with the test cone when the two are heated according to a specified procedure (Fig. 1). The standard

¹ "Manual of ASTM Standards on Refractory Materials," current edition.

test with pyrometric cones eliminates several variables in the testing of refractories that the actual temperature (as determined by a pyrometer) does not properly account for: rate of heating, composition of furnace atmosphere, and radiation effects.

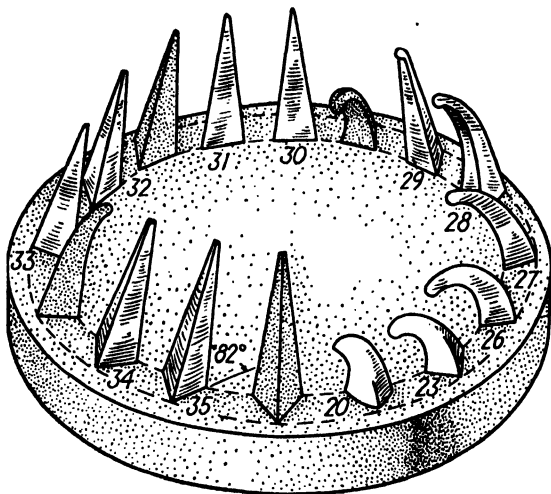

FIG. 1.—Method of mounting pyrometric cones and their appearance after testing. (Courtesy of ASTM.)

The ASTM cone *end point* or PCE temperatures are given in Table 1 (C 24).* The term PCE will be frequently used in this chapter.

TABLE 1^a

Cone No.	End point		Cone No.	End point	
	°C	°F		°C	°F
15	1435	2615	30	1650	3002
16	1465	2669	31	1680	3056
17	1475	2687	32	1700	3092
18	1490	2714	32½	1722	3131 (approx)
19	1520	2768	33	1745	3173
20	1530	2786	34	1760	3200
23	1580	2876	35	1785	3245
26	1595	2903	36	1810	3290
27	1605	2921	37	1820	3308
28	1615	2939	38	1835	3335
29	1640	2984			

^a The cone end points given in Table 1 are dependable only for conditions equivalent to the ASTM test procedure. For example, slower rates of heating give lower cone end points by as much as 100°C in some cases.

* Bold-face numbers prefixed by C are ASTM designations.

PETROLOGY OF FIRED REFRACTORIES

The manufacture of refractories involves grinding, proportioning, and mixing of selected mineral constituents, forming the mix into the desired shapes and firing in a kiln in accordance with a carefully controlled time-temperature schedule. Raw mineral constituents used in a batch range from substantially pure compounds to highly complex mixtures and include a wide range of particle sizes. The larger particles or grains should consist of the more highly refractory constituents so that the grains may retain their shape on firing, forming a skeleton of the same shape as the entire article which then retains its original shape also. During the last part of the firing, vitrification (partial fusion) occurs, accompanied by high temperature chemical reactions between mineral constituents. With certain exceptions, the fired product is heterogeneous and very complex in microstructure. Residues of the original large grains remain, but they are often altered by the effects of the firing and by contact with the fine material or groundmass. The groundmass partly or completely fuses to an amorphous glass which serves to cement the larger grains together. The larger grains themselves are composed principally of crystals, which may also form within the glass between grains.

Thus it is seen that the physical properties of the finished product depend upon those of the raw materials, as well as upon fineness of grind and *particle size distribution* of the constituents, and upon the firing schedule (time-temperature factors). It is also evident that chemical analysis of the product can give only a very incomplete picture of its physical properties. Small amounts of low-fusing constituents concentrated at grain boundaries exert an influence on high-temperature strength out of all proportion to the total quantity present. Many good ceramic clays are unsuitable for refractories because they contain relatively small but sufficient amounts of iron and alkaline earth compounds to impair refractoriness of the products. The tolerance of iron, sodium, potassium, and calcium compounds depends upon their chemical states, dispersion within the clay particles, and upon other constituents present.

GENERAL CLASSES OF REFRACTORIES

Fireclay refractories are in greater tonnage production than are all other classes together. For more severe service conditions than fireclay refractories will withstand, high-alumina refractories are made from materials containing higher percentages of alumina than fireclay, or blends of high-alumina material with fireclay. Both types are aluminum silicates in chemical composition, and a few special varieties approach a definite aluminum-silicate compound or mineral.

Since a chemical engineer has particular interests in chemical process and metallurgical furnaces, the discussion of other refractories in the following pages is more extensive in comparison to that of fireclay materials than corresponds to their respective usage. The other refractories in tonnage production are silica, magnesite, dolomite, forsterite, chrome, mullite, alumina, and silicon carbide products. Small quantities of rare superrefractories such as spinels, beryllium, thorium, and zirconium compounds are available for special purposes.

An important physical difference between a fireclay refractory and most of the other classes is that the former loses much of its high-temperature strength several hundred degrees below its PCE temperature, whereas the latter retain their strength at temperatures much closer to the PCE.

SILICA REFRACTORIES

Most refractories contain certain amounts of silica in the free state, chemically combined, or both. Hence a knowledge of the behavior of pure silica is of value in interpreting the behavior of many products.

Quartz is silica. The word *quartz* has been loosely used to connote various forms of silica with much confusion ensuing.

TABLE 2

Modification	Specific vol, cc per kg at $T^{\circ}\text{C}$	Stability and persistence
Low-quartz.....	377/0°	Stable from RT to 573°C
High-quartz.....	395/600°	Stable between 573 and 870°. Exists above 870°
Low-tridymite.....	442/0°	Unstable. Exists from RT to 117°
Lower high-tridymite....	445-450	Unstable. Exists between 117 and 163°
Upper high-tridymite....	445-450	Stable between 870° and 1470°. Exists between 163° and its melting point of 1670°
Low-cristobalite.....	431/0°	Unstable. Exists between RT and 275°
High-cristobalite.....	450/300° (approx)	Stable between 1470° and its melting point of 1710°. Exists above 200°
Vitreous silica.....	454	Unstable below its melting point of 1710°. Exists at all temperatures, but devitrifies above 1,000°

Silica is complex in its polymorphic behavior. It exists in a number of modifications, several of which are extremely persistent at temperatures at which they are thermodynamically unstable. It also exhibits points of *rapid* inversion from one thermodynamically unstable form to another.

Some of the significant properties of the eight better known modifications are given in Table 2.²

The high-low inversions occur rapidly and almost inevitably. On the other hand quartz, tridymite, and cristobalite have distinctly different crystal structures, and conversion of one structure to another occurs only slowly; the rate being influenced by temperature, state of subdivision, and the impurities present.

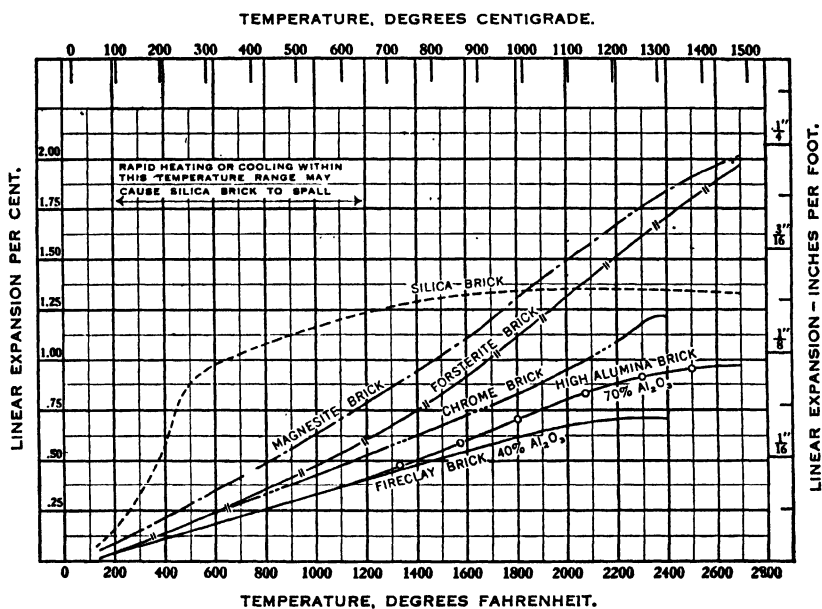

FIG. 2.—Reversible thermal expansion of commercial types of refractories. (Courtesy of Harbison-Walker Company.)

The raw material used for the manufacture of silica brick is a selected quartz mineral, commonly known as *quartzite* or *ganister*. It is ground and sized, mixed with about 2 per cent lime (CaO), pressed or molded, and fired to a final temperature which may be as high as 1500°C. During the firing, the quartz slowly changes to cristobalite and tridymite with an increase in volume of 12 to 14 per cent. The lime combines to form calcium silicate which fuses to a glass and cements the silica particles together. The final brick consist mainly of tridymite and cristobalite, with only a small percentage of unchanged quartz remaining. The lime glass amounts to 5 to 10 per cent. On cooling, the *high* modifications revert to the *low* forms, with a corresponding contraction. Properly

² Compiled from data given in "The Properties of Silica," by R. B. Sosman, ACS Monograph 37 (1927), Reinhold Publishing Corporation, New York.

fired silica brick after cooling are about 10 per cent greater in volume than the unfired material.

Specimens of silica brick removed from an open-hearth furnace roof after long service at fairly constant temperature show three distinct zones in their cross sections, approaching the phase equilibrium predicted from Table 2. The zone near the exposed face consists of cristobalite and vitreous silica with impurities from dust and vapor absorption. Back of this (where the temperature has remained between 1470 and 870°C for a considerable time) is found a layer consisting principally of tridymite. On the cold side (which has not exceeded 870°C for any lengthy period) some of the brick is essentially unchanged and contains some of the original particles of free quartz.

Silica has a comparatively high thermal coefficient of expansion below 600°C (Fig. 2). This makes the refractory very sensitive to rapid changes in temperature below 600°C and heating and cooling must be done very slowly in this range. Silica refractories have excellent high-temperature strength and resistance to abrasion.

ALUMINA-SILICA REFRACTORIES

Alumina and silica are miscible when molten, and if cooled rapidly a glass is always formed. Between 1549°C (2820°F) and the melting point of the mixture, the compound *mullite* ($3\text{Al}_2\text{O}_3 \cdot 2\text{SiO}_2$) is stable and will crystallize. The pure compound contains 71.8 weight per cent of Al_2O_3 and melts at 1830°C. It is the only alumina-silica compound stable above 1549°C. The alumina-silica phase equilibrium diagram given in Fig. 3 shows the stable phases for any composition and tempera-

TABLE 3.—ASTM CLASSIFICATION OF FIRECLAY REFRACTORIES
Designation C 27-41

Test.....	PCE	Load test at 2640°F	Shrinkage	Spalling loss
Designation.....	C 24	C 16	C 113	C 122
	Min	Max deformation	Max	Max
Low-heat duty.....	19			
Intermediate heat duty.....	29	or 3%		
High-heat duty.....	31-32	or 1.5%		
Superduty.....	33	1%	4%
Alumina-diaspore:				
Class 50: 50 ± 2.5% Al_2O_3	34			
Class 60: 60 ± 2.5% Al_2O_3	35			
Class 70: 70 ± 2.5% Al_2O_3	36			

ture. A eutectic containing 5.5 per cent Al_2O_3 exists which melts at $1549^\circ C$. With the exceptions of mullite and sillimanite ($Al_2O_3 \cdot SiO_2$), alumina-silica mixtures soften at several hundred degrees below their melting points. Figure 4 gives the approximate softening temperatures

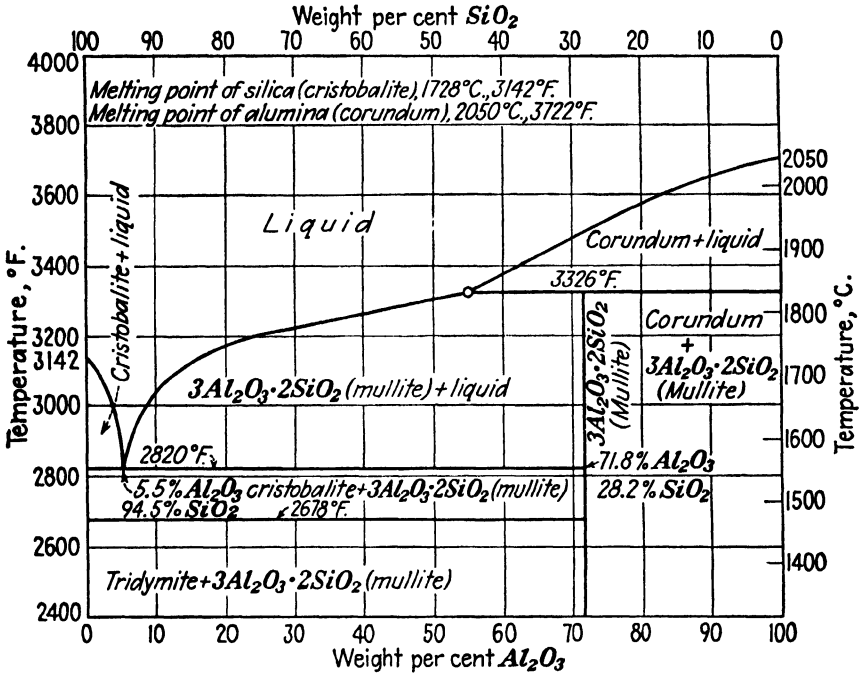

FIG. 3.—Phase diagram for the system alumina-silica. (Courtesy of Harbison-Walker Company.)

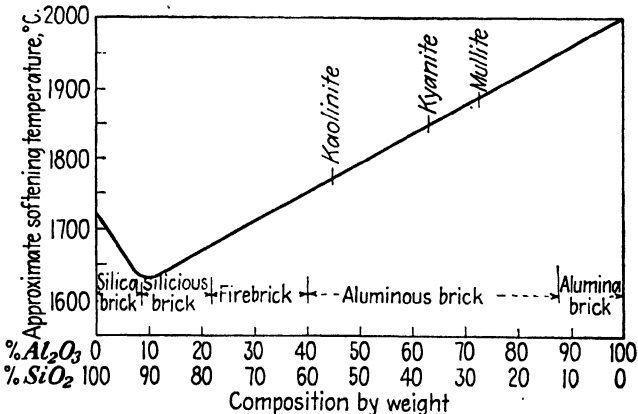

FIG. 4.—Refractoriness diagram for alumina-silica system products. (After Mellor and Green.)

of alumina-silica refractories³ versus composition and is seen to have the same general shape as the melting point (upper) curve of Fig. 3. Increasing the alumina content increases the refractoriness, and brick are marketed that contain up to 90 per cent alumina. The ASTM classification for fireclay brick is given in Table 3. PCE's of high-alumina refractories are given in Table 4.⁴ The 80 and 90 per cent alumina products have PCE's above cone 38. There is much greater difference in the actual service characteristics of these classes than is indicated by the PCE.

TABLE 4

% Al ₂ O ₃	50	60	62	70
PCE	34-35	36-37	37	38

Pure alumina (corundum) makes a superior refractory and would be more widely used if it could be produced less expensively.

FIRECLAY REFRACTORIES⁴

The essential ingredients of fireclay are hydrated aluminum silicates, notably *kaolinite*, Al₂O₃·2SiO₂·2H₂O. The general formula corresponds to 39.5 per cent alumina, 46.5 per cent silica, and 14.0 per cent water. At high temperatures the water is driven off and the resulting material consists of 45.9 per cent alumina and 54.1 per cent silica. Even the purest clays contain a small amount of other compounds, such as those of iron, calcium, magnesium, titanium, sodium, and potassium.

The clays of greatest importance in the refractories industry may be divided into two general groups: flint and plastic fireclays, known also as hard and soft clays, respectively. Intermediate between these in physical properties are the semihard or semiflint, and the semiplastic clays.

Flint clays are hard and dense and usually break with a conchoidal fracture. Their plasticities and *drying shrinkages* are very low; their *firing shrinkages* are fairly high and somewhat variable. The best clays of this type are extremely refractory, having a PCE of cone 33 to 35. Deposits of flint clay occur in rather limited areas in central Pennsylvania, Maryland, eastern Kentucky, southern Ohio, and eastern Missouri.

Semiplastic and plastic refractory clays vary considerably in refractoriness, plasticity, and bonding strength. Drying and firing shrinkages are usually fairly high. The PCE values of clays of this type range

³ MELLOR and GREEN, *J. Soc. Chem. Ind.*, **572**, 627 (1938).

⁴ Reprinted with special permission, from "Modern Refractory Practice," 2d ed., Harbison-Walker Refractories Co., Pittsburgh, Pa.

from cone 30 to cone 33 for the most refractory varieties; from cone 26 to cone 30 for many clays of high plasticity and excellent bonding power. Most of the deposits occur in the carboniferous system of rocks, frequently in association with the flint clays.

Fireclay Brick. The materials used in making fireclay brick are selected raw and calcined fireclays. The relative proportions of flint, bond, and calcined clay used in the batch depend upon the character and quality of the brick to be made. The most refractory brick are made largely of flint clay; some others contain little or no flint clay. Some brick contain no calcined material; others as much as 50 per cent or more. The amount of semiplastic or plastic clay used ranges from zero to 100 per cent. The several grades of fireclay brick are divided into classes known as superduty, high-heat duty, intermediate-heat duty, and low-heat duty (see Table 3).

Fireclay brick are made both by hand and by machine. Machine-made brick are manufactured by either the "extrusion" or the "power press" process. "Handmade" brick of the standard series of sizes are usually manufactured by grinding the clay batch with water in a wet pan, followed by hand molding, partial drying on a hot floor, and repressing in a press operated by hand. In making machine-made brick of the extruded type, the clays are ground in a dry pan; blended and tempered with water in a mixer; extruded as a column through the die of a plunger, auger, or other machine; and cut by means of wires into brick which are then repressed to give them sharp corners and edges and smooth surfaces and to imprint the brand name. In the manufacture of power-pressed brick the clays are ground in a dry pan, screened to the desired size, blended, and thoroughly mixed with a small but definitely measured amount of water. The moistened batch is then fed to a mechanically operated press in which the brick are formed under high pressure. The brick thus formed are dried either on hot floors or in tunnel or controlled-humidity driers, and fired in periodic downdraft kilns or in continuous car-type tunnel kilns. The temperature of firing depends upon the maturing temperature of the mix and the service for which the brick are intended.

Within recent years great improvements have been made in the manufacture of fireclay refractories. The "power press" process has permitted improvement in the resistance of the finished brick to spalling, to slag attack, and in better high-temperature strength. In one modification of this process, stronger and denser brick are produced by the removal of entrapped air from the mix by pressing the brick under vacuum. Another important development is the product known as "superduty" fireclay brick. The outstanding properties of this brick

are high-temperature constancy of volume, ability to support load, and remarkable resistance to thermal spalling.

HIGH-ALUMINA REFRACTORIES

Products that belong to the alumina-silica group of refractories and which contain more than 47.5 per cent alumina are known as *high-alumina* refractories. They are supplied in the 50, 60, 70, and 80 per cent alumina classes.

High-alumina raw materials include bauxite, diaspore clay, kyanite, andalusite, sillimanite, and crystalline alumina or corundum. However, most high-alumina refractories are made from diaspore clay, either used alone or blended with flint or plastic clay according to the properties and alumina content desired in the finished product. The process of manufacture is similar to that used for making fireclay refractories. On account of the high firing shrinkage of diaspore clay, a large proportion of the material entering into the batch is precalcined.

The mineral constitution of the finished product is largely dependent upon the temperature and duration of firing, which effects conversions to the minerals mullite, corundum, cristobalite, and possibly tridymite. Such properties as resistance to slag attack, strength, and constancy of volume at high temperatures depend in large measure upon the mineral changes that occur during firing.

High-alumina brick have become widely used only within the past two decades. The rapid increase in their use has resulted from the enhancement of their properties resulting from improved methods of manufacture, and from the growing demand for brick of higher refractoriness than obtainable in fireclay or silica products. In many industries, high-alumina brick are now regarded as standard for certain applications.⁴

Fused-cast Varieties. Complete fusion of a selected or blended high-alumina stock forms a dense product which also retains its strength to higher temperatures than a product of the same material fired in the conventional manner. Refractories consisting of high-alumina, mullite-corundum, and pure alumina are available which have been fused and cast into shapes. Fused-cast refractories of other types have been made on experimental and semicommercial scales.

MULLITE REFRACTORIES

Mullite ($3\text{Al}_2\text{O}_3 \cdot 2\text{SiO}_2$) is a definite mineral compound, stable up to its melting point of 1830°C (3326°F). The pure compound contains 71.8 per cent Al_2O_3 , and mullite crystals form in high-alumina refractory materials when subjected to vitrifying temperatures. The degree to which the compound forms is related to the improvement of properties

of high-alumina over fireclay products. Mullite refractories have excellent high-temperature strength, resistance to spalling, and good resistance to many fluxes. These properties make them well suited for linings of glass tanks, certain metal-melting and other high-temperature furnaces.

Although natural mullite occurs in a few small deposits, mullite refractories are synthetic. The manufacture consists of fusing alumina and silica materials in correct proportion, or calcining a sillimanite mineral ($\text{Al}_2\text{O}_3 \cdot \text{SiO}_2$), which converts into mullite and silicate glass. The fusion process is carried out in an electric furnace. The melt is allowed slowly to cool and solidify. It is then ground and sized, mixed with a bonding material, pressed, dried, and fired.

MAGNESITE REFRACTORIES

Pure magnesite rock, the raw material from which magnesite refractories are made, contains 47.6 per cent magnesia (MgO) and 52.4 per cent carbon dioxide (CO_2). The first step in the manufacture of magnesite refractories is the "dead burning" of the crude material. This process consists of calcining the rock at a temperature sufficiently high to drive off the carbon dioxide and to form a dense, sintered product that is chemically inert at ordinary temperatures to atmospheric moisture and carbon dioxide.

Dead-burned magnesite is marketed in the form of nodules or grains varying in size from pieces of about $\frac{5}{8}$ in. in diameter to very fine but gritty particles. It is used for the construction of monolithic furnace hearths, for the manufacture of brick, and for the preparation of "furnace magnesite" used in laying magnesite brick.

Magnesite brick of three types are regularly supplied:

1. Brick Bonded by Firing. In the manufacture of these brick, dead-burned magnesite is ground and blended to the desired aggregate of grain sizes. The ground material is tempered with water in a wet pan, molded at high pressure in a power press, thoroughly dried in a tunnel drier, and fired at an exceedingly high temperature.

2. Brick Bonded Chemically. These brick consist of ground, dead-burned magnesite usually mixed with a small percentage of ground chrome ore. The process of manufacture is the same as that of the fired brick, except for the addition of a chemical binder and omission of the firing. In service at high temperatures, chemically bonded brick undergo changes, as a result of which their characteristics approach those of brick fired in the usual manner.

3. "Metalkase Magnesite Brick." These consist of fired or unfired magnesite brick encased in soft steel containers. Their cross section is round, square, or rectangular. The round brick are made by packing a mix of dead-burned magnesite and bonding material into steel tubes

of standard lengths. Square or rectangular casings are used for both fired and unfired brick, and the steel usually covers three or four faces of the brick. In service at high temperatures, the steel casings soften and weld together at the heated end, forming a structure which is practically monolithic and highly resistant to spalling. The cooler portions of the steel casings serve to reinforce the brick and add to the strength of the structure.⁴

Subclassification and Applications. Although magnesite brick have the highest fusion temperature (above 2150°C) of any of the common refractories, their greatest usefulness lies in their basic nature which provides resistance to slagging or fluxing by metals and oxides at high temperatures.

For this reason they are most valuable to metallurgical operations, specifically in furnace walls below the slag line. There are two general grades according to iron content.⁵ The common or "high-iron" varieties contain 5 to 7 per cent Fe_2O_3 which exists principally in the form of magnesioferrite ($\text{MgO}\cdot\text{Fe}_2\text{O}_3$). This mineral fuses at 1750°C hence a considerable proportion can be tolerated before the fusing point is significantly affected. The "low-iron" grade which contains 2 to 3 per cent Fe_2O_3 must be made from selected mineral and is consequently more expensive. Its fusing point and its resistance to chemical attack are considerably better than the same properties of the high-iron variety.

Magnesite brick are difficult to manufacture and therefore expensive. Their resistance to spalling is lower than that of good silica brick, and this characteristic with their high cost tend to limit their applications to services in which other refractories are not satisfactory.

DOLOMITE REFRACTORIES

The mineral *dolomite* (calcium magnesium carbonate) may be calcined or dead-burned to form a refractory material. Although dolomite refractory brick have not proved commercially successful, the refractory in grain form is the principal material used to *maintain* the working surfaces and bottoms of open-hearth steel furnaces. Its properties and behavior are discussed by Schallis.⁶

FORSTERITE REFRACTORIES

The mineral *forsterite* ($2\text{MgO}\cdot\text{SiO}_2$) fuses at 1910°C and is an excellent refractory. It is the only magnesium silicate stable at furnace temperatures. The pure mineral is too rare in occurrence to be available for refractories; however certain olivines consist largely of forsterite although containing small amounts of accessory minerals that impair refractoriness.

⁴ McDOWELL, J. S., *Blast Furnace Steel Plant*, June, 1939.

⁶ U.S. Bur. Mines Inf. Circ. 7227 (1942).

Forsterite refractory is manufactured by adding magnesia to a selected olivine or serpentine and firing. The accessory minerals are largely converted into synthetic forsterite.

Although a relatively new product, forsterite refractory is established in a number of industries. It has excellent high-temperature strength and resistance to slagging, particularly by alkaline materials, dusts, and fumes. It is successful in the hot zone of rotary kilns, in copper-smelting furnaces, and in the ports and regenerators of glass-tank furnaces.

CHROME REFRACTORIES

The raw material used for the manufacture of chrome refractories is chrome ore (chrome spinel) whose essential constituent is *chromite* ($\text{FeO} \cdot \text{Cr}_2\text{O}_3$). Chrome ores used for this purpose are chemically complex and varied; the usual range of composition is shown in the accompanying table.

	%
Cr_2O_3	30-50
FeO.....	12-20
MgO.....	13-18
Al_2O_3	13-30
SiO_2	4-8

The ore occurs as a solid solution of these constituents, and its composition affects the properties of the refractory. Methods of manufacture are similar to those used for making magnesite refractories. Of the two classes, chrome brick are somewhat less expensive. As chrome refractories have good resistance to basic slags and to iron oxide at temperatures below 2800°F (1538°C), they are used in metallurgical furnaces where conditions are not so severe as to require magnesite.

SILICON CARBIDE REFRACTORIES

Silicon carbide (SiC) is a synthetic compound formed by chemical reaction between sand and coke. The reaction is carried out in an electrical resistance furnace at about 4000°F (2200°C). The resulting crystals are ground, mixed with bonding material, formed, and fired. Finished silicon carbide refractories containing 40 to 85 per cent or more of the carbide are supplied for various applications.⁷

Silicon carbide does not fuse or soften appreciably below its dissociation temperature (above 4000°F). It is extremely resistant to thermal spalling and is inert to slags and to most reducing atmospheres. It has superior high-temperature strength, but in pure or unprotected form it is susceptible to furnace oxidation. Because of these properties, the serviceability of silicon carbide refractories is in general determined

⁷ "Super Refractories," 1940 ed., The Carborundum Co., Niagara Falls, N.Y.

by the bonding material and manufacture rather than by the properties of the pure carbide. The single most important property of the refractory is its high thermal conductivity, which is about ten times that of fireclay products.

The combination of properties possessed by silicon carbide refractories has permitted very diversified applications: metallurgical heating and melting furnaces, retorts, kiln furniture, shields, and thermocouple tubes, and many applications where strongly reducing atmospheres are encountered. Likewise, it has enabled the construction of larger and more efficient equipment for high-temperature processes, some of which are not otherwise commercially practicable.

EFFECTS OF SERVICE CONDITIONS

Both the raw materials used and the methods of manufacture influence the quality and serviceability characteristics obtainable in a refractory. As a guide to dependable service, the ASTM has developed specifications for fireclay refractories to be used in certain applications: various parts of metallurgical furnaces, annealing ovens, boilers, and incinerators. Surveys of conditions affecting refractory service in open-hearth, malleable-iron, copper, lead, coke-oven, lime-burning, and portland cement kilns and glass-making industrial furnaces are also given.¹ The principles underlying fluxing and slagging tendencies are discussed in the section following.

Fluxing and Slagging. Fusing points of refractories are higher than furnace temperatures in most cases. Representative fusion temperatures are given in Table 5.

TABLE 5

	<i>Fusing Temp, °C, of Commercial Refractories</i>
Fused alumina.....	1750-2000
Bauxite.....	1565-2000
Mullite.....	1650-1820
Fireclay.....	1500-1750
Silica.....	1685-1800
Silicon carbide.....	1800-2240
Magnesite.....	2150-2165
Chrome.....	1850-2050
Spinel (MgO.Al ₂ O ₃).....	2135

Fusing points of the pure constituents are even higher. Accessory minerals found in refractories will fuse and cool to solid solutions and they exhibit eutectics of definite compositions.

In many applications, refractories are exposed to metal oxide dusts. Compounds of sodium, potassium, and iron are found in fuel ash and in many inorganic materials. Silica and refractories containing SiO₂

TABLE 6.—REACTION TEMPERATURES BETWEEN DIFFERENT REFRACTORIES, °C

Type of refractory brick	Silica		Fireclay		High-alumina, 70% Al ₂ O ₃		Chrome		Magnesite		Forsterite	
	A	B	A	B	A	B	A	B	A	B	A	B
Silica.....	1500	^a	1600	^a	No reaction		1500	1600	1700	1700
Fireclay.....	1500	^a	No reaction		1600	^a	1400	1500	1500	1600
High-alumina (70% Al ₂ O ₃).	1600	^a	No reaction		1600	1600	1500	^a	1700	1700
Chrome.....	No reaction		1600	^a	1600	1600		No reaction		No reaction	
Magnesite.....	1500	1600	1400	1500	1500	^a	No reaction		No reaction	
Forsterite.....	1700	1700	1500	1600	1700	1700	No reaction		No reaction			

^a Not damaging.

A = reaction first observed, B = reaction first became damaging. 1400°C = 2552°F; 1500°C = 2732°F; 1600°C = 2912°F; 1700°C = 3092°F.

will form silicates at elevated temperatures with oxides of most metals, producing lower melting glasses or slags, which may progressively destroy the refractory (Fig. 5). As a rule, metallurgical furnaces impose severe service upon refractories with respect to fluxing and slagging. Partial



Fig. 5. Slagging of the burner hood of a rotary lime kiln. (Courtesy of L. J. Trostel.)

equilibrium diagrams for silica with CaO, FeO, and Na₂O are shown in Figs. 6 and 7. Iron, magnesium, and calcium silicates all melt near 1550°C, and their eutectics melt at even lower temperatures. Sodium and potassium each form two silicates melting near 1000°C, and with silica each shows a eutectic melting under 800°C. Magnesia, alumina, and silica form a ternary eutectic fusing at 1345°C. Other lower melting

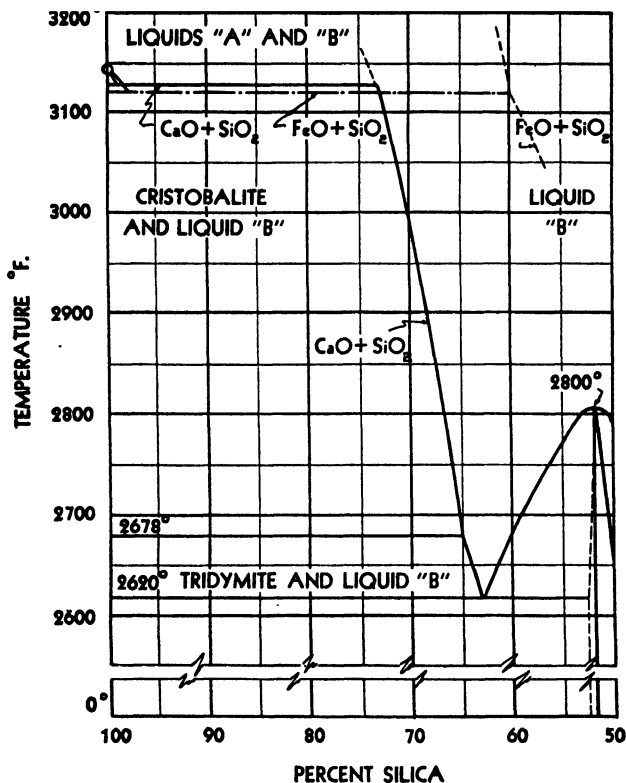

Fig. 6.—Partial equilibrium diagram of the binary systems lime-silica and ferrous oxide-silica (CaO-SiO₂ and FeO-SiO₂). (Courtesy of Harbison-Walker Company.)

complex eutectics undoubtedly exist.⁸ Fusing points of many metallurgical slags are between 1170 and 1250°C.

When refractories of different types are placed in contact and heated, slagging reactions may occur at a temperature lower than that at which the individual types are serviceable. Table 6 gives temperatures at which contact reactions first become noticeable and temperatures at which they become damaging.⁴ A single course of chrome brick is often placed between sections built of magnesite and silica and/or fireclay to prevent these reactions.

⁸ HALL and INSLEY, *J. Am. Ceram. Soc.*, **16**, 455 (1933).

Refractory mortars of different types of composition than the brick with which they are laid can also cause fluxing of damaging proportions (Fig. 8). Destructive combinations are aluminous mortar with silica

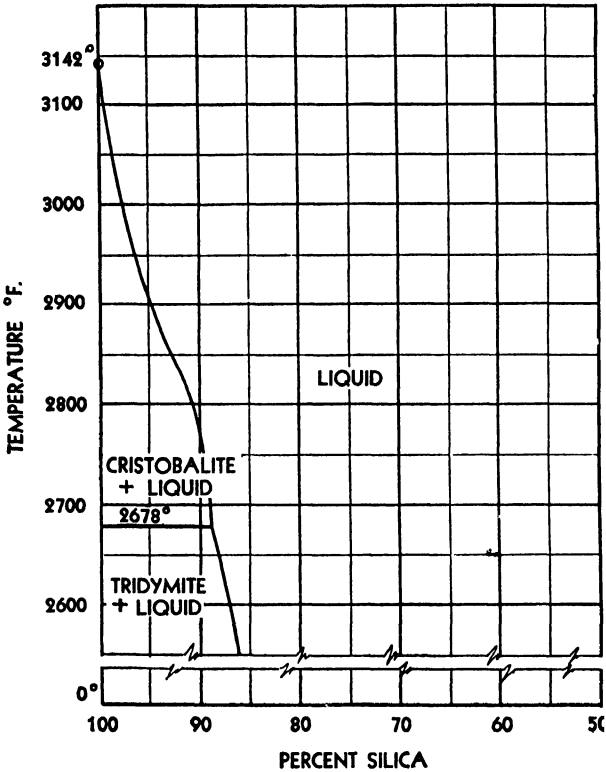

FIG. 7. Partial equilibrium diagram of the binary system sodium oxide-silica (Na₂O-SiO₂). (Courtesy of Harbison-Walker Company.)

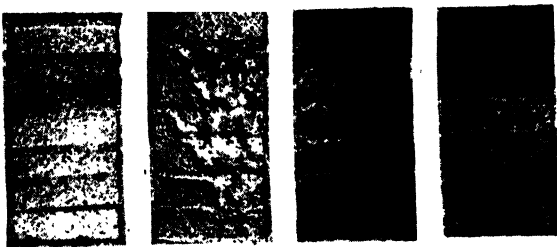

FIG. 8.—Fluxing action of improper type of mortar. (Courtesy of L. J. Trostel.)

brick, fireclay mortar with magnesite brick, and magnesia mortar with fireclay or silica brick. A safe working rule is to use mortar of the same general composition as the brick.

In brief, slagging reactions may occur at the lowest eutectic temperature for the combination of all constituents that come in contact with each other.

Furnace Atmospheres. As the excess air used in a furnace is decreased, carbon monoxide begins to appear and the furnace atmosphere changes from "oxidizing" to "reducing." In general, a furnace atmosphere is designated "reducing" when its oxygen content is less than 0.5 per cent. Maximum allowable service temperatures of refractories are frequently lower in reducing than in oxidizing atmospheres; fireclay brick are the most sensitive, and silica brick are also affected. PCE values of fireclay brick may be lowered one or two cones by a reducing atmosphere. Under certain conditions, decomposition of carbon monoxide or of hydrocarbon gas causes deposition of carbon in the pores of fireclay refractories, which often disintegrates the brick.⁹ This decomposition is catalyzed by the presence of free iron oxide. As an experiment, a fireclay brick was completely disintegrated during a 72-hr exposure to a manufactured gas at 900°C.

Reducing atmospheres also promote *chemical* decomposition. Oxides and salts tend to be reduced to lower fusing, more volatile compounds or even to elementary metals. Metallic magnesium, zinc, sodium, and potassium vaporize at 1100°C or lower. Chlorine and hydrochloric acid can be liberated in reducing atmospheres, and these gases attack most refractories. Metallic chlorides are comparatively very volatile; ferric chloride boils at 315°C, and readily reverts to the oxide in the presence of oxygen. Iron can be either removed from or deposited on refractories by varying local conditions. Either action is destructive, and both may even occur in different parts of the same furnace. Iron oxide attack is very common and is so recognized.

POROSITY

Refractories contain a certain percentage of their total volume as void space, both open and closed pores. Density, strength, and thermal conductivity of any single class of material are all dependent upon porosity and orientation of the pores. Resistance to slagging and spalling are also related to these factors.

In the final stage of firing a fireclay refractory, incipient fusion (vitrification) occurs, and bubbles of air and other gas slowly escape with an attendant shrinkage of the brick. The time at vitrifying temperature thereby determines porosity, but hard firing cannot be carried to the point of developing zero porosity in molded shapes. The porosity of commercial fired refractories is usually between 15 and 30 per cent of

⁹ Loux, J. H., *Ind. Eng. Chem.*, **33**, 42 (1941).

total voids. Extra-heavy and lightweight classes have porosities respectively lower and higher than these limits.

Fireclay brick in service sometimes attain temperatures at which slow secondary vitrification and shrinkage occur, resulting in sagging or complete failure of a structure. For this reason and the fact that they also exhibit slow, plastic flow at even lower temperatures, fireclay brick are not well suited for sprung arches of large furnaces or applications where high compression stress develops owing to thermal expansion. Chrome refractories fail under similar conditions at temperatures above 1500°C.

High-strength brick must be comparatively low in porosity. Gases such as CO₂ and SO₂ which are liberated in firing can be preeliminated by calcining the raw material before final grinding and forming into brick. Defective burned pieces (grog) are often reground and mixed into a new batch. This also reduces shrinkage in firing. Material to be used for dense brick must be carefully ground and screened so that it forms a dense aggregate. Vacuum applied to the mixer, pug mill, or extrusion press will remove most of the air that would otherwise result in a weaker, less dense product. In one process, high pressures (10,000 psi) are used tightly to consolidate unfired types of magnesite and chrome brick, and porosities as low as 8.5 per cent voids have been attained. Fused-cast refractories are nonporous.

TABLE 7

Type of brick	True sp gr ^a	Porosity, %
Fireclay:		
Superduty.....	2.65-2.75	12-16
High-heat duty, handmade.....	2.60-2.70	20-30
High-heat duty, machine-made.....	2.60-2.70	15-24
Intermediate-heat duty.....	2.55-2.65	17-21
High-alumina:		
50% Al ₂ O ₃	2.75-2.85	20-25
60% Al ₂ O ₃	2.90-3.05	22-30
70% Al ₂ O ₃	3.15-3.25	26-31
80% Al ₂ O ₃	3.35-3.45	26-31
Silica.....	2.30-2.40	22-30
Magnesite.....	3.40-3.60	20-28
Chrome.....	3.80-4.10	20-28
Forsterite.....	3.30-3.40	24-27

^a ASTM C 135. Not to be confused with "apparent specific gravity" given in ASTM C 20.

Lb/cu ft = (62.3)(true sp gr) (1 - % porosity/100)

17 standard brick = 1 cu ft.

On the other hand, refractories with low thermal conductivities are needed for heat insulation. *This property is mainly a function of porosity.*

Such materials are designated *insulating block* and *insulating firebrick*. They are made by several methods: (1) by carefully firing a naturally porous material such as kieselguhr (diatomaceous earth), (2) by whipping a wet batch into frothy consistency before firing, (3) by incorporating a substance that will produce gas bubbles when heated, and (4) by admixing a combustible material, such as cork or sawdust. Insulating refractories are so porous that they are easily cut. Large pieces may be fired and subsequently cut to size.

Lightweight refractories are necessarily much weaker mechanically than are the more dense varieties, hence they are unsuited to structural applications requiring high strength. Furthermore, they will not withstand as high service temperatures and are less resistant to slagging than the more dense products. The density of insulating block is less than 35 lb/cu ft. The density of insulating firebrick is between 35 and 70 lb/cu ft, whereas the regular classes weigh about 120 to 150 lb/cu ft. Lightweight refractories may have densities anywhere between those of the insulating and the regular classes. True specific gravities and porosities of full-weight refractories are given in Table 7.⁴

SPALLING⁴

Spalling is defined as "the breaking or cracking of refractory brick in service, to such an extent that pieces are separated or fall away,



Fig. 9.—Results of spall test on two kinds of brick. (Courtesy of L. J. Trostel.)

leaving new surfaces of the brick exposed" (see Fig. 9). Whenever the temperature changes, brickwork is exposed to spalling influences. How-

ever, the rate of spalling can be minimized by proper design of brick shapes and by proper construction and operation of furnaces.

Spalling of refractory brick is of three general types:

1. Thermal Spalling. This type of spalling is caused wholly or mainly by rapid and unequal expansion or contraction of the brick, owing to rapid changes in temperature.

In the case of high-heat-duty fireclay brick, relatively porous products of light burn are initially more resistant to thermal spalling than are denser, hard-burned brick. The former retain this property in service if subjected only to low or moderate temperatures. However, in high-temperature service, the hot ends of light-burned brick change in texture and actually become hard-burned, taking on the same spalling characteristics as hard-burned brick. In such cases a line of weakness forms between the harder and the lighter burned portions of the brick. This is a condition favorable to structural spalling as mentioned later.

Superduty fireclay brick, although dense and hard-burned, have the greatest resistance to thermal spalling of all the fireclay and other common types.

Silica brick are sensitive to rapid temperature changes below a dull red heat, on account of the abrupt volume change accompanying the crystalline inversions of the mineral cristobalite. However, at temperatures above 600°C (1112°F), silica brick have a remarkable resistance to the spalling influence of rapid temperature changes.

Neither magnesite nor chrome brick have as high resistance to thermal shock as do fireclay and high-alumina brick.

2. Mechanical Spalling. Shattering of brickwork may result from such influences as abuse during removal of clinker or slag, "pinching" (due to thermal expansion), or from other causes. "Pinch spalling" is frequently observed in sprung arches and results from the transfer of the arch stresses to a relatively small bearing surface at the hot end of the brick, owing to the greater thermal expansion of the hot end as compared with the cooler portions. Insulation decreases the temperature gradient through the brick and thereby tends to reduce pinch spalling.

3. Structural Spalling. Changes in the texture or in the mineral constitution of the hot end of a brick through the action of heat or absorption of slags or fluxes may result in the formation of zones of different structures and even different minerals between the outer and the inner ends. The physical properties of such zones differ not only from those of the original brick but also from those of each other. The inner ends of the brick may tend to crack or fall off for various reasons, such as shrinkage of the ends with the development of shrinkage cracks, differences in thermal expansion coefficients between adjacent zones, or increased sensitiveness to thermal shock (due to vitrification or slag

TABLE 8.—SUMMARY OF PROPERTIES

Refractory	PCE	High temp strength	Spalling resistance	Iron oxide slugging resistance*	Remarks
Silica.....	31-32	Excellent	Sensitive below 600°C	Fair	Widely used for sprung arches because of high-temperature strength General purpose material. Inexpensive
Fireclay.....	19-34	Fair	Fair Depends on manufacture	Poor	
High-alumina... Mullite.....	Above 38 38	Properties improve with increasing Al ₂ O ₃ Excellent	Good	Good	} Used for more severe conditions than fireclay will withstand Expensive. Used in metallurgical furnaces. High heat capacity
Magnesite.....	38 and above	Good	Sensitive. Depends somewhat upon manufacture	Superior	
Forsterite.....	Over 32	Excellent	Good	Excellent	} Indicated where both high-temperature strength and resistance to slugging are needed Less expensive and somewhat less slag-resistant than magnesite. Same general type of applications
Chrome.....	38 and above	Good	Fair to good, depending on composition and manufacture	Excellent below 2800°F. Poor above that temp	
Silicon carbide..	37 to above 38	Excellent	Superior	Fair to poor	Expensive. Used in contact with flames and for indirect heat transfer. Abrasion-resistant

* Resistance to slugging does not always control uses and applications. See last column under Remarks and context of chapter.

absorption). Slag may penetrate to a considerable distance into a brick, forming a vitreous section which is brittle when cool and which therefore tends to spall off when either cooled or heated rapidly. A section of this type is also sensitive to mechanical stress.

HEAT TRANSFER AND TEMPERATURE

In most applications, refractories are used either to insulate or to transmit heat, hence their thermal properties are of prime importance.

Thermal Conductivity. Since there are few if any completely homogeneous and nonporous refractories, many variables of manufacture as well as of composition determine the thermal conductivity of the finished product. In general, refractories consist of one or more types of crystalline minerals bonded by or imbedded in glass and containing many voids. The crystals and the pores vary in size, number, shape, and orientation. The glass varies in its proportion and even in its composition from point to point. Because of these variables, an accurate thermal conductivity for any given product must be experimentally determined. A few generalities should be noted:

1. The thermal conductivity of a crystal is higher than that of a glass of the same composition.
2. The thermal conductivity of crystals usually decreases slightly with increasing temperature level, whereas that of glasses increases with temperature.
3. The thermal conductivity of a fired product is roughly proportional to its bulk density.

In line with the above, thermal conductivities of refractories containing high proportions of glass (such as fireclay and silica products) increase with temperature. Highly crystalline products often show slight decreases with temperature, and samples can be found whose thermal conductivities are nearly independent of temperature over a considerable range (see Appendix, Table 15).

Thermal conductivity is usually independent of the *rate* of heat transfer, although the conductivity of a major brand of silicon carbide products has been observed to increase with heat flow.¹⁰

Heat Loss from Wall Surfaces. Refractory walls are frequently constructed of two or more layers of brick through which heat flows in series, escaping from the outer surface by convection and radiation. Besides thickness, the thermal conductivities of the component layers of brick, surface temperatures, and surface coefficients of convection and radiation are all interrelated with heat loss.

The outside surface coefficient ($h_c + h_r$) may be evaluated as follows:

Convection Coefficient (h_c):

The ASTM formulas¹ for convection heat loss may be reduced to *convection coefficients*:

For natural convection (quiet air),

$$h_c = \frac{q_c}{\Delta} = \frac{0.53C(\Delta)^{0.27}}{(T_{av.}^{\circ}\text{R})^{0.18}} \quad (1)$$

For surfaces exposed to steady drafts or winds,

$$h_{fc} = \frac{q_{fc}}{\Delta} = \frac{1 + 0.225V}{\Delta} \quad (2)$$

where q = convection heat loss, Btu/(hr)(sq ft)

h = surface convection coefficient, Btu/(hr)(sq ft)(°F)

Δ = temp difference, wall surface to air, °F

C = shape constant (1.39 for a vertical wall or 1.79 for a furnace arch)

$T_{av.}$ = arithmetic average temperature of wall surface and air

V = velocity of air, ft/sec (direction not specified)

¹⁰ Personal communication from C. F. Geiger, The Carborundum Co., February 1944.

Radiation Coefficient:

The radiant heat-transfer coefficient is calculated by combining the relation

$$q_r = h_r \Delta$$

with Eq. (9) of Chap. XII, giving

$$h_r = \frac{0.173\epsilon[(T_w/100)^4 - (T_a/100)^4]}{\Delta} \quad (3)$$

where h_r = surface radiation coefficient, Btu/(hr)(sq ft)(°R)

T_w = wall surface temperature, °R

T_a = air temperature, °R

$\Delta = T_w - T_a$

ϵ = surface emissivity factor. (Typical values are given in Appendix, Table 17. For dark-colored brick, ϵ is about 0.95 and increases slightly with temperature. For light-colored brick, it is 0.9 to 0.95 at 200°F and decreases to 0.5 at temperatures of about 1500°F.)¹¹

Equation (1) or (2) with Eq. (3) gives the total surface coefficient, ($h_c + h_r$). This is used in the heat-transfer summation equation (see Illustration 1 of Chap. XII).

Surface temperature must first be guessed at to compute ($h_c + h_r$). With the approximate coefficient so obtained, heat loss and surface temperature may be calculated. If the calculated surface temperature differs appreciably from that originally assumed, a new value of ($h_c + h_r$) should be computed from the calculated surface temperature, and the heat loss calculation repeated.

Service Temperatures. The exposed inner refractory surfaces of a furnace remain several hundred degrees below the temperature of the hot gas, under usual conditions. A small but definite amount of heat is transmitted through the refractory wall, and a gas film partly insulates the refractory from the hottest furnace atmosphere. Furthermore, the practice in boiler- and oil-heater design is to place a row of heat-absorbing tubes close to or even embedded in the refractory at the hottest zone of the furnace (the so-called "water walls" in boilers).

Interior refractory surfaces sometimes reach temperatures at which slow plastic flow or even slight surface fusion occurs, yet they may still continue to render satisfactory service. The explanation for this becomes apparent from the *temperature gradient* through the brick: a large portion of the wall thickness is at a temperature sufficiently low so that enough structural strength is retained. In small- or medium-sized furnaces, satisfactory service will be obtained at a mean refractory temperature

¹¹ HEILMAN, R. H., *Mech. Eng.*, **58**, 291 (1936).

at which the material will pass the "ASTM Test for Refractory Materials under Load at High Temperatures," (conducted at a pressure of 25 psi), *provided also* that the surface temperature does not approach the PCE. Both temperatures can be estimated by heat-loss calculations.

Before insulation is applied to a furnace wall, the temperatures that will exist under the new conditions should be estimated; the refractory may not be serviceable under the higher temperature that will then exist. Many an operator has watched a furnace lining fusing down on the inside surface, yet when the wall had thinned to some fraction of its original thickness, the action practically stopped and the lining had a reasonably long life.

Supplementary References

1. NORTON, F. H.: "Refractories," 2d ed., McGraw-Hill Book Company, Inc., New York, 1942.
2. SILVERMAN, MOREY, and ROSSINI: Data on Chemicals for Ceramic Use, *Nat. Research Council Bull.* 107 (1944), National Academy of Sciences, Washington, D.C.

Exercises

1. *a.* What changes occur during firing in the manufacture of silica brick? How do these changes affect the size of the brick?
b. What changes occur during heating and cooling of fired silica brick as used in service? What precaution must a furnace operator observe?
2. Silica brick have been extensively used in sprung arches of open-hearth furnaces and in other applications where they have poor resistance to slagging. Explain why this practice is justifiable.
3. Rotary cement kilns are frequently lined with several varieties of brick, including different grades of fireclay and high-alumina refractories. What factors should be considered in determining how a kiln should be lined?
4. *a.* Under what conditions will a dense refractory spall where a lightweight product of the same type gives long service life?
b. Under what conditions will a lightweight refractory spall after a short period of use, where a dense product of the same type gives good service life?
5. What types of refractories are serviceable in contact with (*a*) acid gases, (*b*) strongly reducing atmospheres, (*c*) metal oxides and slags, (*d*) rapid changes in temperature, (*e*) abrasive conditions?
6. Should the outside of a furnace always be insulated to obtain optimum fuel economy? Explain.

CHAPTER XIV

FIREBOX AND CHIMNEY CONSIDERATIONS

Considerations in the design of a furnace or heater firebox include operating temperature, rate and manner of heat liberation and of heat absorption. Size, proportions, and construction must be such that complete combustion of the fuel occurs with the heat distributed and absorbed evenly and efficiently.

In some types of furnaces, the stock receives heat directly from flame and combustion gases. In others, there is a wall or container between stock and combustion atmosphere, with no direct contact between the gases and the material heated. For convenience of description, the former are designated *direct furnaces*, and the latter *indirect heaters*.^{*} Most kiln and many metal-heating operations are conducted in direct furnaces. Indirect heaters include tube heaters, muffles, some ovens, pot and crucible furnaces. Muffle furnaces have a thin refractory enclosure (the muffle itself) that contains the stock and is heated from the outside. Ovens are of similar construction to muffles but in general operate at lower temperatures, and the "muffle" is metallic.

HEAT RELEASE AND RELATED FACTORS

For purposes of comparison, the specific thermal input to a furnace is expressed by the term *heat release*, or *Btu generated per cubic foot of furnace volume per hour*. A numerical value for it is always easily obtainable and so is of great convenience. However, there is *no fundamental relation for heat release between different types of furnaces*; in fact values differ more than a thousand fold. Nevertheless, fairly definite limits exist for an individual type when used for a given purpose. In this sense, *heat release* is useful in deciding upon the fuel and method of firing, the burner capacity, and size of firebox—if heat release limits are known or can be estimated for the type of furnace and process in question.

Furnace temperature is the only factor bearing any general relation to *heat release*. High rates of heat transfer require high *temperature differences* between heat source and heat-absorbing surface. Great temperature differences are obtainable only by high-temperature sources.

^{*} This differentiation is made according to *mode of heat absorption* and does not include *indirect-fired* and *semi-muffle* furnaces, in which the heat-absorbing surface is shielded from or out of sight of the flame but has direct contact with the combustion gases. A better designation for the latter types is *convection furnaces*.

Highest heat-release values, over 500,000 Btu/(cu ft) (hr), are obtained in high-temperature operations where the material being heated is not injured by high surface temperature or by interior temperature gradients, as, for example, billet reheating and forging furnaces. Lowest heat-release values (200 and less) are used in drying and bake ovens. Other things being equal, small furnaces tolerate higher heat release than large ones, owing to greater surface-to-volume ratio.

In coal-fired furnaces and small units fired with oil, the maximum firing rate may depend upon combustion volume; harder firing resulting in incomplete combustion or local overheating. More often, the rate of firing is determined by allowable surface temperatures and temperature gradients in the material heated. Flames should not impinge upon either furnace wall or heat-absorbing surfaces. Avoidance of flame impingement sometimes fixes the minimum length of combustion chamber. Length of the flame depends chiefly upon type of fuel and design of the burner.

Present-day design almost always provides a much larger combustion chamber than the minimum required. Advantages gained by this practice are more uniform temperatures throughout the furnace, ease of heat density control at various points, and avoidance of local overheating. As an aid to control combustion, a portion of refractory-lined combustion space adjacent to the burner with no heat-absorbing surface present is desirable (see Tile-port Burners in Chap. IX). This may be in the form of a refractory burner mounting, an extended combustion ring, or a "dutch oven" whose back opens into the furnace. The flame is shortened because combustion is speeded. Less total space is required for complete combustion, and a more uniform furnace temperature is obtained.

Gas Firing. Gas flames are ordinarily shorter than those of either oil or coal at equivalent heat liberation. Combustion is substantially complete at the tip of the flame envelope. It follows that heat release in gas-fired furnaces is seldom limited by available combustion space. However, it is possible to chill the flame to extinction before combustion has been completed. Extremely high values of heat release are more readily obtainable with gas than with other fuels.

As discussed in Chap. IX, fuel gas is *premixed* with part or all of the air for combustion, and its flame is of low luminosity. Increasing the luminosity of a flame by reducing the percentage of primary air increases its rate of radiant heat emission somewhat. However, water vapor and carbon dioxide emit considerable nonluminous radiation, that from water vapor being the greater of the two.

Shape and size of a gas flame depend to a great extent upon burner design and the percentage of primary air used. Most gas burners permit some control over both shape and size of the flame. Special burners

that produce long, luminous flames (diffusion flames) are sometimes used for special applications.

Complete combustion is obtainable with less excess air when firing with gas than with oil or coal. Nevertheless, stack losses are greatest with gas fuel at equal flue temperatures and percentages of excess air, since gas has the highest hydrogen content and water vapor carries out more sensible heat than does carbon dioxide.

Oil Firing. In many applications, oil is almost as convenient a fuel as is gas. The cost of oil fuel is between the costs of coal and of gas in most localities.

Typical values of heat release in oil-fired furnaces for various temperature levels are given in Table 1.¹

The size of an oil flame depends upon the heat liberation and class of fuel, the type of burner, the degree of atomization, the atomizing fluid if any, and the turbulence of the air-fuel mixture. No general correlation is available to predict flame size. As with gas, combustion is substantially complete at the extremity of the flame when good atomization and dispersion exist, and in such cases no special provision is needed for secondary combustion space. Refractory burner mountings are of great value in preventing too rapid heat loss from the flame with accompanying incomplete combustion.

TABLE 1

<i>Furnace Temp., °F</i>	<i>Heat Release, as Btu per Cu Ft per Hr</i>
600-1500	1,000-15,000
1500-1800	15,000-22,000
1800-2000	22,000-35,000
2000-3000	35,000-150,000

Stoker Firing. Under normal conditions, about half of the heat of a coal fire is generated within the fuel bed and half above it. Hot gases leaving the bed contain carbon monoxide and volatile matter, the proportion depending upon the type of stoker and the amount of volatile matter in the coal. Low-volatile coals liberate more carbon monoxide than high-volatile fuel at the same rate of heat generation, and in medium- to large-sized furnaces, incomplete combustion may result in carbon monoxide in the flue gases rather than in appearance of smoke. Any more than a trace of smoke indicates inefficient operation or faulty design.

The U.S. Bureau of Mines has conducted investigations on the problem of combustion space requirements for the burning of coal. However, as Haslam has pointed out,² more thorough mixing of gases was had in

¹ "Industrial Combustion Data," 1st ed., p. 12, Hauck Manufacturing Co.

² HASLAM and RUSSELL, "Fuels and Their Combustion," p. 345, McGraw-Hill Book Company, Inc., New York, 1925.

the U.S. Bureau of Mines experiments than prevails in commercial practice, and furthermore the gases were not cooled during their passage through the furnace. As a consequence, completeness of combustion for any particular firebox volume under these experimental conditions is higher than exists in actual furnace operation. The tendencies and trends found in the experiments are valuable.

Excess air is a major variable in the combustion space required, for the firing of all solid fuels, most particularly high-volatile coal. Table 2 is a summary from U.S. Bureau of Mines data for the burning of a bituminous coal.

TABLE 2
*Cu Ft Combustion Space per Sq Ft Grate Area,
Required for Complete Combustion*

<i>% Excess Air</i>	
10	11.0
25	7.8
50	5.0
75	3.8

Rate of firing also affects volume of combustion space, since a definite time is required for completing combustion in the gases above the grate. In general, 10 cu ft of combustion space per square foot of grate area is satisfactory and can be reduced if complete combustion at high firing rates is not a necessity. Underfeed stokers require the least combustion space, and overfeed types require the most. In large boilers, other considerations than completeness of combustion determine the minimum volume. Traveling-grate and overfeed stokers require ignition arches to maintain high combustion rates when burning low-volatile coals and high-moisture fuels such as anthracite and lignite, respectively.

Water-cooled walls permit higher rates of heat release than do plain refractory walls. Water-cooled side walls along the grate line of underfeed and traveling-grate stokers practically eliminate erosion and slag adherence at this area, which may otherwise require costly maintenance.

Pulverized-coal Firing. Pulverized coal requires a greater *minimum* combustion volume than other types of fuel and methods of firing, and cannot be used in small fireboxes. The length of a pulverized-coal flame depends upon the type of burner, the turbulence of the air-fuel mixture, the fuel composition, its fineness and size uniformity, the amount of excess air, and the air preheat temperature. The fusing point of the coal ash is a major factor in determining furnace type and volume. Low-fusing ash particles melt in the flame and will adhere to surfaces while at or near fusion temperature. When this condition exists, layers of partly slagged ash build up and then drop off of their own weight, carrying off bits of the furnace lining. Water-cooled walls effectively prevent damage by this type of erosive action hence are often specified

in boilers fired with pulverized coal. The same kind of ash deposition occurs on the surface of boiler tubes, where it reduces the heat-transfer coefficient and increases the resistance to gas flow.

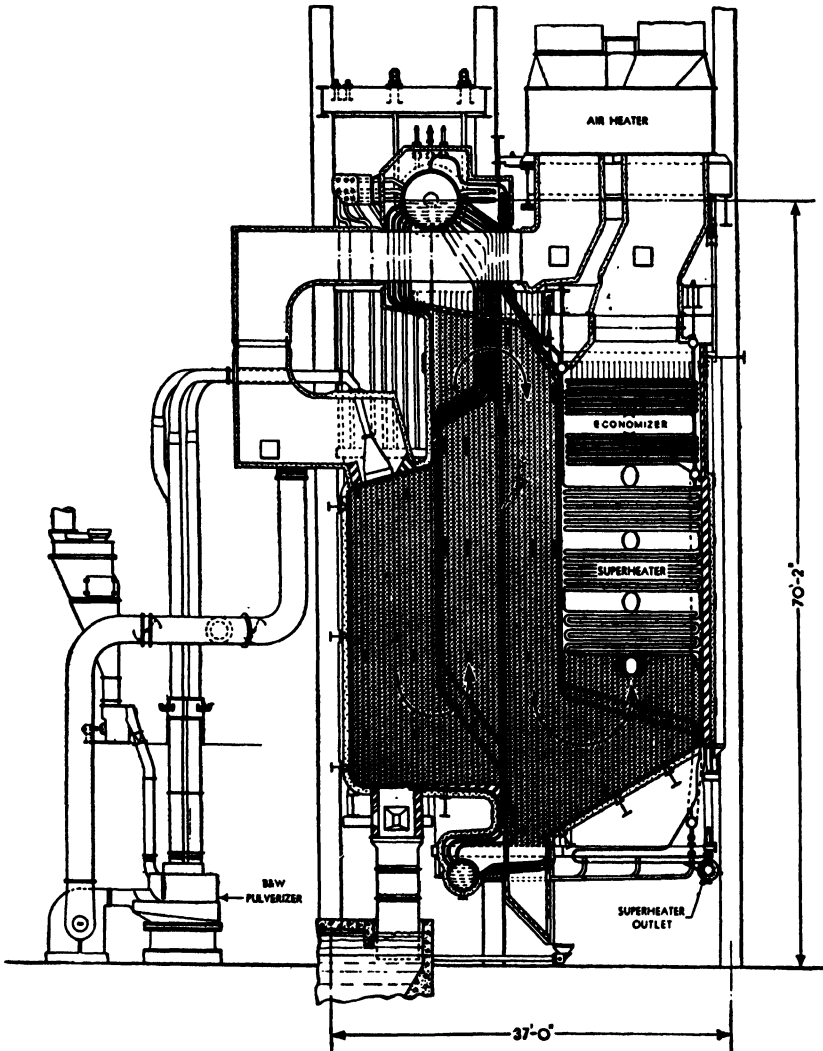

FIG. 1.—Multistage furnace in a central-station boiler. (Courtesy of Babcock and Wilcox Company.)

Adequate space must be provided for complete combustion of the larger particles in the fuel and also for fused ash particles to freeze before coming in contact with the furnace walls. Trouble with ash is minimized if the burners are mounted to project the flame downward rather than horizontally. Ash-fusion characteristics determine the type of furnace

best adapted to the particular coal. Low to medium ash-fusion coals are usually burned in wet-bottom or in slag-tap furnaces; medium to high ash-fusion coals in dry-ash furnaces that are generally of the hopper-bottom type.

One method of solving the ash disposal problem is to design the furnace in two or more *stages*. This design is used in water-cooled slag-tap furnaces. Both stages are water-cooled. The first stage or primary furnace is comparatively small and, in it, a high heat release [about 100,000 Btu/(cu ft)(hr)] is obtained. This permits ash to be removed in the molten state over a wide range of firing rates. In the secondary stage or chamber the gas temperature is sufficiently reduced so that the remaining ash particles are no longer adherent. This is readily accomplished since the gases in the secondary furnace are shielded from the intense radiant heat of the primary furnace. About half of the ash removal occurs as slag from the primary furnace and the balance as dry dust or water quench from the secondary furnace. This type of furnace is illustrated in Fig. 1. For the same coal and equivalent firing rates, dry-ash furnaces must be larger and of lower overall heat release than slag-tap designs. The general range of heat release in pulverized coal installations is 15,000 to 35,000 Btu/(cu ft)(hr). This system of firing is not economical for small units, as was discussed in Chap. XI.

FIREBOX CONSTRUCTION

General Details. Refractories are not primarily structural materials, and in firebox construction are best used merely to confine heat; hence large settings are so designed that the refractory has only its own weight to support insofar as possible. However, hearths of metallurgical furnaces must bear the weight of the charge, and compression stress of considerable magnitude is also unavoidable in sprung-arch construction.

Approximate height-thickness design data for vertical walls are given in Table 3.³

TABLE 3

<i>Thickness of Vertical Wall, In.</i>	<i>Approx Max Height, Ft</i>	
4½	3	} For unsupported lengths not ex- ceeding 1½ times the height
9	8	
13½	12	
18 or more	Over 12	

Tube furnaces and certain other types have a steel framework or skeleton to support heavy parts such as boiler drums and tubes. The framework may also serve to align the brick walls and to support the roof. In this construction, the brick are often laid dry. A wash of

³ "Modern Refractory Practice," 1937 ed., pp. 163, 167, Harbison-Walker Co.

refractory cement or "Gunite" may be applied later to seal small cracks between the brick, to protect the brick, or to shield the tubes in a "water wall." A number of high-temperature cements and plastic refractories or mortars are available (see Chap. XIII).

Settings of furnaces having no structural steelwork are laid similarly to conventional masonry walls with thin joints of refractory mortar serving both as a bond and seal. Obviously an all-masonry structure must be thicker and heavier than one having steel corners and other supports. The innermost course of brick forming the furnace lining is in many cases subjected to a temperature at which it has very little strength; its function is principally high-temperature insulation. It must be tied to the outer load-bearing courses at frequent intervals by endwise or "header" brick.

Thermal Expansion. Thermal expansion is allowed for when laying brick by leaving gaps between them (if no mortar is to be used), by providing expansion joints every few feet, or by inserting proper thicknesses of cardboard between ends. The last procedure keeps the ends clear of mortar and burns out on the first firing, permitting expansion without damage. Expansion allowances are given in Table 4.³ Vertical as well as horizontal expansion occurs, and adequate clearance must be left between brick and steelwork for expansion in both directions.

Refractory liners inside steel shells need less expansion allowance than given in Table 4 since the shell also heats up and expands. In rotary kilns, the shell becomes hot, and no provision for expansion of the liner is needed.

TABLE 4

<i>Material</i>	<i>Expansion Allowance</i>	
	<i>In. per Ft</i>	
Fireclay and 50% alumina.....	$\frac{1}{16}$	$\frac{3}{32}$
60-80% alumina.....	$\frac{3}{32}$	$\frac{1}{8}$
Chrome.....	$\frac{5}{32}$	
Silica:		
Handmade.....	$\frac{1}{8}$	$\frac{3}{16}$
Power-pressed.....	$\frac{3}{16}$	
Forsterite.....	$\frac{1}{4}$	
Magnesite.....	$\frac{1}{4}$	

Sprung Arches. Self-supporting or "sprung" arches are used on metallurgical furnaces and stationary horizontal kilns. The arch is designed with $1\frac{1}{2}$ to 3 in. of *rise* (vertical distance) for each foot of span. The most common practice is to lay out the arch with an included angle of 60° , which gives 1.61 in. of rise per foot of span. Wide spans require greater rise per foot and also greater thickness than do short spans. For adequate strength, the arch must have a thickness of 5 or 6 per cent of the span, but for erosive conditions and better heat economy, additional

thickness is often provided by making the total as much as 10 per cent of the span. For spans greater than about 15 ft, sprung arches become so heavy that they are not feasible, and suspended construction is used.

If the rows or courses of brick in the arch interlap as in common masonry walls, the arch is called *bonded*; if not, it is designated as a *ring arch*. *Ribbed-ring* arches have a course of extra-thick brick between several thinner courses. By this construction, fluxing and erosion loss is provided somewhat less expensively than by arches of uniform thickness. The rib is formed on the outside of the arch, leaving the inside smooth. Extra thickness is sometimes built into the arch near the edge of the span or where fluxing conditions are most severe.

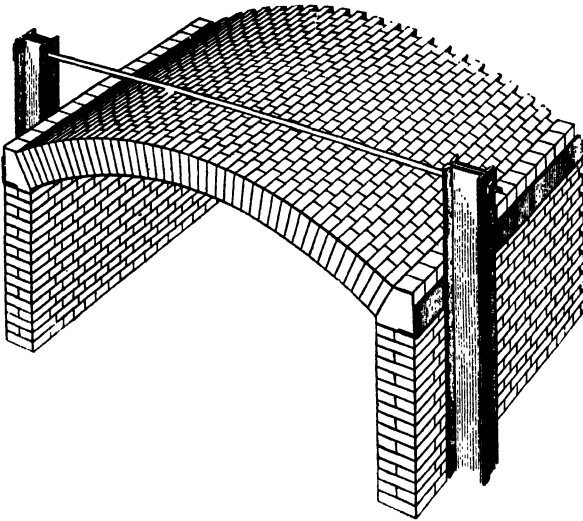

FIG. 2.—A bonded arch. (Courtesy of Harbison-Walker Company.)

The edges of the arch rest upon special refractory shapes called *skew-backs*, and the horizontal thrust is counteracted through *buckstay beams*, held together by *tie rods* (Fig. 2).

An approximate formula for the horizontal thrust or buckstay load P caused by one course of brick of weight W is

$$P = \frac{2WR}{S} \quad (1)$$

where R is the radius of the included angle of the arch (measured from the inside surface) and S is the span of the arch. In service, most of the expansion occurs in the heated underside, giving a greater thrust pressure than calculated and tending to cause pinch spalling at the inside of the arch. When designing buckstays and tie rods, the force calculated by Eq. (1) is multiplied by a safety factor of 2 to 3 (depending upon the

temperature of operation) to allow for this unequal expansion. The results of arch expansion may be overcome by allowing the crown of the arch to rise when heated, by loosening the tie rods during heating, or by placing compression springs between the tie-rod nuts and buckstays.

Until lately, silica brick were almost universally used in sprung arches, irrespective of their suitability in regard to fluxing conditions. This was simply because of unsatisfactory high-temperature strength of other

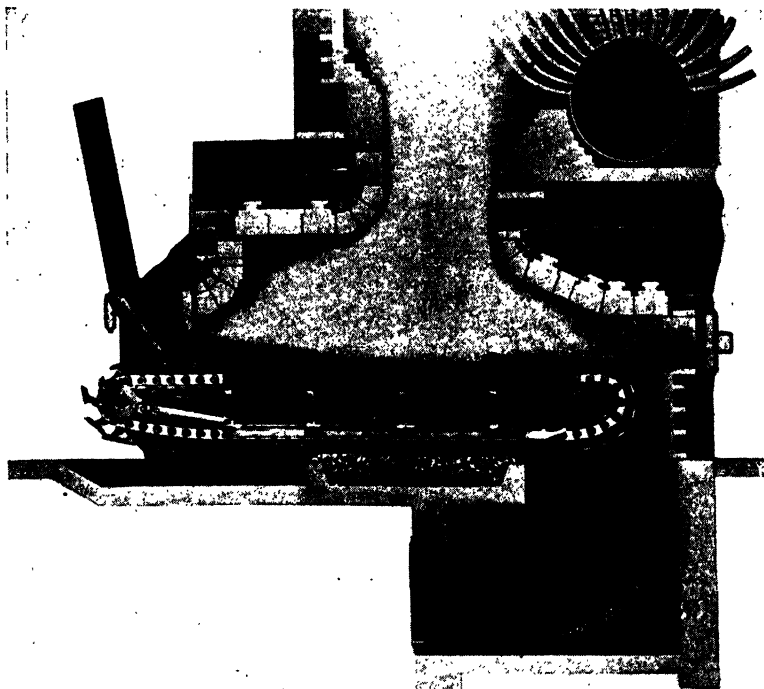

FIG. 3.—Suspended arch over a traveling-grate stoker. (Courtesy of Riley Stoker Corporation.)

refractories. In the presence of iron oxide, alkaline dusts, or fumes, the silica brick surface fluxed, then dripped or ran off. The arch became thinner and thinner in service until it had to be replaced. Today, basic refractories are largely occupying their rightful place in metallurgical furnaces, in both sprung and suspended arches.

Suspended Walls and Roofs. With improvements in methods of manufacture, refractories are now available that have greater tensile strength than earlier products, especially the lightweight, insulating, and basic types. This has made possible simpler, cheaper, and more dependable methods of *suspending* both wall and roof brick by steel girders, rods, and hangers.

Insulating refractories are always porous and of low density. Their use in boilers and oil heaters enables the whole setting to be made very light in weight; in fact, only a small fraction as heavy as settings of full-weight material. *Storage of heat* between atmospheric and operation temperature is decreased proportionately.

A large number of suspension shapes are made, such as punched, tongue, groove, and interlocking brick. Precast furnace slabs and sec-

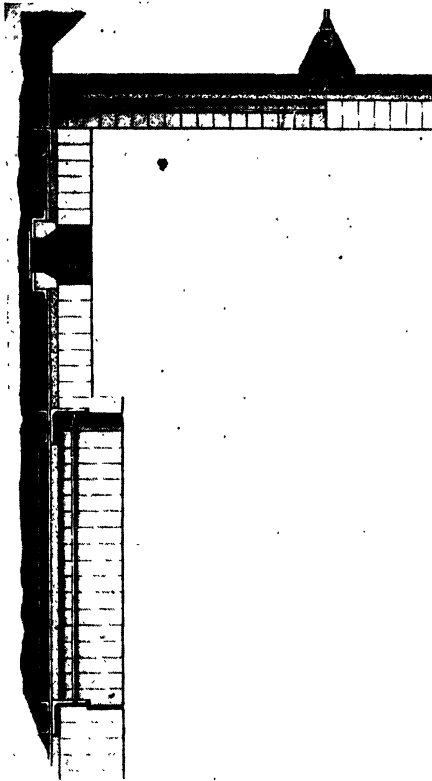

FIG. 4.—Lightweight suspended wall and roof construction. (Courtesy of The Lummus Company.)

tions are available. Constructional details of the suspended arch over a traveling-grate stoker are in evidence in Fig. 3. A simple and inexpensive method of suspension used in an oil heating furnace is shown in Fig. 4. In the latter, punched brick are held in place by steel tie rods. Only a single course of insulating brick backed by a 2- to 4-in. slab of mineral wool or equivalent insulation is needed. The exterior of insulated furnace walls is finished with either sheet steel or transite for outdoor installations.

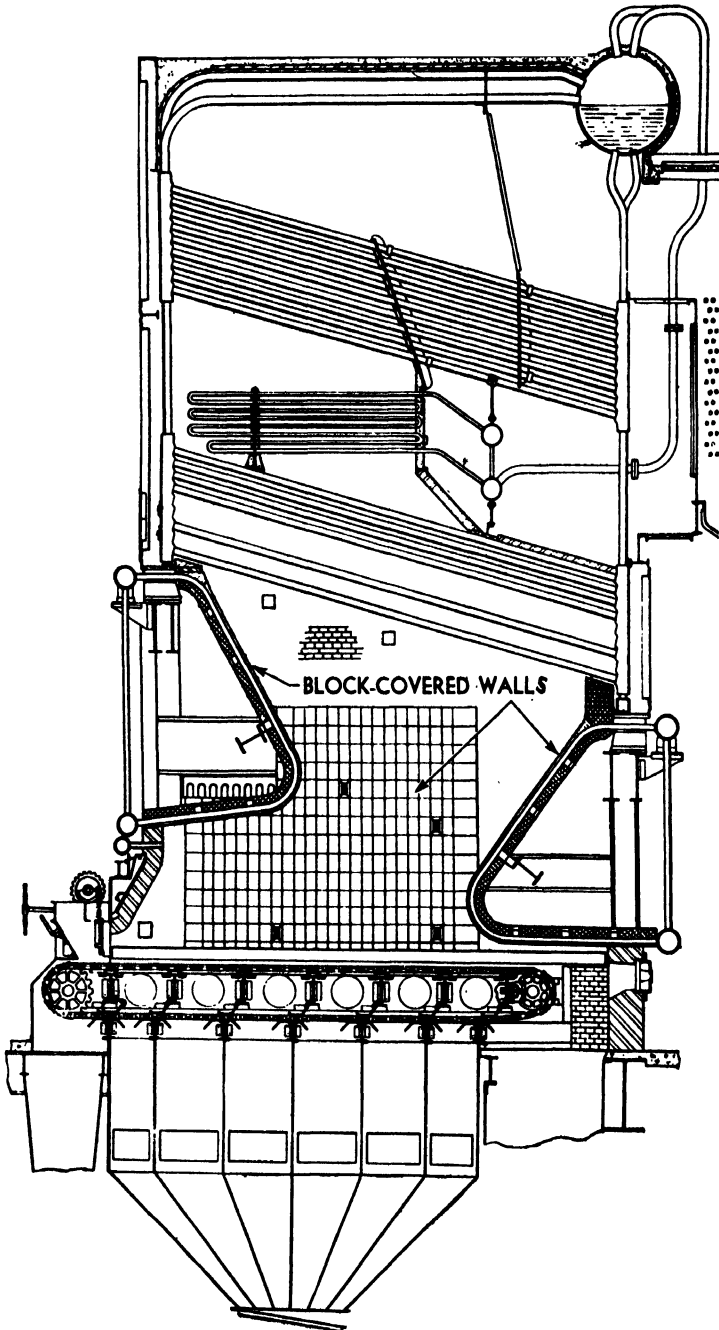

FIG. 5.—Combustion-zone protection of tubes in a boiler. (Courtesy of Babcock and Wilcox Company.)

Suspended arches are somewhat more expensive to install than sprung arches, but width of span in the suspended construction is not limited in any way by the strength of the refractory. Suspended arches may be built in any size and shape, and of any refractory.

Water-cooled Furnaces. Water-cooled boiler furnaces are of unique, integral construction of wall and tubes. The tubes are bent to form the framework of the furnace and are supported by hangers connected to structural steel members. In turn, the tubes support the refractory which provides the cover and seal, completing the inside surface of the wall. Arches, roofs, and vertical walls are all formed by bending the tubes into the proper shapes. The inner surface of the wall is completed by one of the following methods:⁴

1. For extremely high-temperature locations such as at the burner level in central station boilers, the tubes are studded and covered with plastic refractory.

2. Where gas temperatures are more moderate, the tubes may be covered with smooth-faced cast-iron or refractory blocks.

Metal blocks are used to finish hopper bottoms, water-cooled arches, and side walls around stokers, since they are resistant to erosion and will not accumulate ash (Fig. 5). Refractory blocks are more suitable for oil- and gas-fired furnaces, since ash erosion is not a problem and the furnace atmosphere is apt to be oxidizing. Refractory surfaces resist oxidizing atmospheres and aid combustion, whereas iron blocks do not.

3. For the upper sections of combustion chambers and water-cooled baffles, walls having the tubes partly exposed are formed by partly studded tubes, the studs holding a filling of plastic refractory placed between the tubes of a row. Most of the recent installations of central-station boiler plants use the stud-tube construction.

FURNACE PRESSURES AND DRAFT

Since combustion is dependent upon supply of air and removal of burned gases, both items must be provided for by maintenance of proper furnace pressures and draft at various points. Pressure in the combustion chamber may be 0.01 or 0.02 in. H₂O above atmospheric to somewhat less than 1 in. H₂O below the outside pressure. Wider limits are to be avoided.

Brick settings contain unavoidable leaks. Pressures appreciably above atmospheric drive the hot gases into these leaks, and the setting becomes overheated. When the pressure is below atmospheric, cold air leaks *in* and, although a small amount does no harm, relatively high furnace vacuums cause a loss of thermal efficiency that is easily avoided

⁴ "Water-cooled Furnaces," Bulletin G-16, (1939), Babcock & Wilcox Co.

by raising the pressure. It is desirable to keep furnace vacuum down to 0.2 or 0.3 in. whenever possible. In addition to leakage, other effects that higher vacuums may cause are unsteady flames, a fluctuating furnace turbulence or vibration, and furnace roar. Gas and oil flames are more sensitive to this unsteady combustion than are grate fires.

Chimneys and fans or blowers provide the pressure differences needed to move the gas. Pressure *losses* or *resistances* limit the rate of gas flow. These losses occur in the grate, fuel bed, overfire or secondary air openings, the firebox itself, and furnace accessories. At the highest obtainable firing rates, the total resistances exactly balance the maximum available draft. Lower rates are maintained by adjusting flue or stack dampers and by throttling air supplied by fans. *Natural draft* is furnished by the stack, *induced draft* by a fan between furnace and stack, and *forced draft* by a fan in the air supply line.

Natural-draft grates and stokers must not offer pressure losses higher than about 1 in. H₂O at peak firing rates, since it becomes economical to use mechanical draft rather than to build higher chimneys when total resistance is more than 1.5 in. H₂O. *Forced draft* sufficient to overcome grate and fuel-bed resistances and to relieve the slight furnace vacuum increases the possible firing rate by 75 to 100 per cent. Overfire air is admitted to natural-draft furnaces through shuttered openings provided for the purpose. In forced-draft installations, the overfire air must be blown in. When a number of small, high-velocity jets or nozzles are used, the delivery pressure is sometimes as high as 8 in. H₂O. This arrangement causes rapid, turbulent mixing with the combustible gases, accelerating secondary combustion.

Oil and gas burners actually *generate* a certain amount of draft, particularly when high-pressure gas, steam, or air dispersion is used. On the other hand, burner energy is offset by air-register types of mountings which may offer as much as 0.2 or 0.3 in. resistance.

The *combustion chamber resistance* may be anywhere from about 0.01 to several inches of water depending upon furnace size, baffling arrangements, and firing rate. Unobstructed fireboxes offer negligible resistance. For medium-sized boilers, Kent gives the data of Table 5.⁵

TABLE 5

	Boiler draft loss, as in H ₂ O (typical values)		
	100	150	200
Firing rate, % of rating.....	0.25	0.4	0.65
Water tube.....	1.0	2.25	
Fire tube, 18 ft × 2 in. diam.....			

⁵ KENT, R. T., "Mechanical Engineers' Handbook," Vol. II, Sec. 6, John Wiley & Sons, Inc., New York. (By permission.)

Air preheaters, economizers, and waste-heat boilers are designed to offer as little resistance to gas flow as is consistent with good heat recovery. Pressures through these accessories are often 1 to 3 in. H_2O . Resistances through tubestill heaters are lower than for water-tube boilers of comparable size, since gas velocities are lower, tube banks are shallower, and baffles are not used.

CONTROL OF GAS-FLOW PATTERN

An even distribution of heat in a furnace is required for high efficiency and avoidance of local overheating. In the combustion chamber, most of the heat is transmitted by direct radiation from the flame and combustion gases. The rest is by reradiation from the refractory walls and by convection to the heat-absorbing surfaces.

It is important that gas flow be controlled as to velocity and distribution. The gas layer nearest to the cold surfaces transmits heat faster by both radiation and convection than the gas in the middle of the chamber, leaving a hot gas "core" at the center. If no provision for control of gas flow exists, the hot portion may sweep through and out of the furnace without being near the cold surfaces long enough to transmit its heat efficiently. This causes high stack temperatures and may result in local "hot spots."

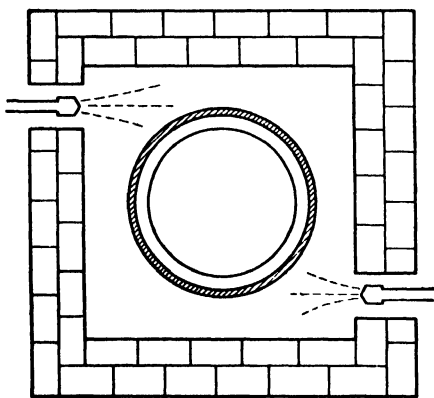

FIG. 6.—Offset mounted burners (in a pot furnace).

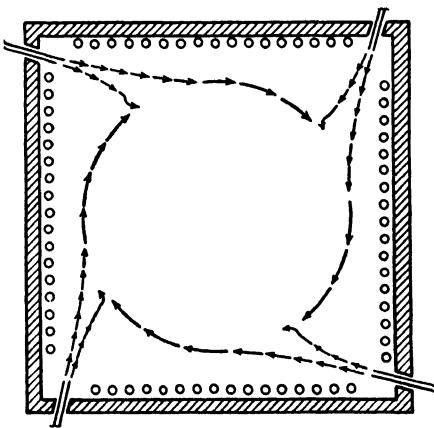

FIG. 7.—Corner-tangential method of firing (used in some central-station boilers).

Burner Arrangement. The jetting action of the burner itself is simply large-volume low-velocity gas inspiration. The slanting vane or louver type of burner mounting imparts a spinning or swirling motion to overfire or secondary air, which persists well into the firebox (see Figs. 17, 18 and 21 in Chap. IX; Fig. 13 in Chap. XI). Gas flow and pattern imparted by the burner and its mounting are sometimes adequate. When two or more burners are used, they should in general be

mounted all on one side of the furnace or, if on opposite sides, be offset from each other as in Fig. 6. Furnaces having directly opposing burners are in use, but it is not a satisfactory arrangement for operation at high values of heat release. The *corner tangential method of firing* consists of four burners mounted as shown in Fig. 7. This scheme is used with good results in some central-station boiler plants firing pulverized coal.

Baffles. Gas flowing through banks of tubes tends to develop velocity *gradients*, the highest velocity finding the path of least resistance. There are several different baffle combinations used in water-tube boilers to cause the gases to flow *across* the tubes two or more times in order to effect good mixing and efficient heat transfer. All baffling arrangements increase draft loss, but some obstruct the flow less than others while maintaining almost as good heat transfer. Two different baffle systems

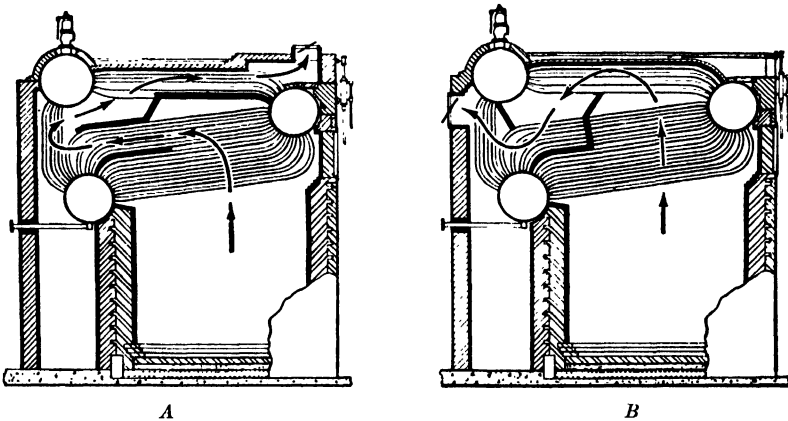

FIG. 8.—Two different arrangements of baffles in a Stirling boiler. (Courtesy of Babcock and Wilcox Company.)

applied to a Stirling boiler are shown in Fig. 8. Although 8A may give a somewhat lower stack temperature than 8B, it forces the gas to travel a longer path and also to make a sharp return bend, hence gives a higher draft loss. Baffles placed in a nearly horizontal position tend to accumulate dust and soot. (Other arrangements may be seen in Figs. 7 and 8 of Chap. XI, and Figs. 6 and 7 of Chap. XV.) Distribution of gases across the *width* of the tube bank may be controlled by creating a local resistance between adjacent tubes in a row. T-shaped tile made for this purpose are placed between tubes of one or more rows to form narrow strip baffles. In Figs. 7 and 8 of Chap. XI, these distribution baffles are shown on several rows of tubes.

Lack of or improper baffling may cause overheating in some places and cold or inactive zones at others. Both effects are undesirable and in boiler tubes, water-side scaling and tube rupture follow overheating, while settling of sediment and corrosion occur in unheated portions.

Petroleum tubestill heaters do not use baffles across the tubes. Temperatures and heat release in oil heaters are lower than in boilers, and tube banks in the former are so designed that gas velocity gradients through them are negligible.

Gas Recirculation. Faster travel of gases within a furnace may be brought about by a circulating fan within the combustion chamber, or by an outside fan in a duct connecting breeching and firebox. This results in more rapid heat transfer at a given temperature level and a *more uniform temperature* throughout the furnace. It is thus a means of maintaining smaller temperature differentials in the furnace and is useful where furnace temperature must be kept down to a definite maximum so as to avoid any local overheating of a temperature-sensitive material.

Gas recirculation is essentially a contacting operation to which the principle of countercurrent flow is not applicable, hence the gas in circulation cannot be cooled to a low temperature. Since an inordinate heat loss occurs if it is sent to the stack hot, a high overall heat efficiency is obtainable only if the flue gas removed from a circulating system is passed through an air preheater or waste-heat boiler before entering the stack.

CHIMNEYS

Theoretical Draft. The chimney produces *natural draft* and also serves to disperse flue gases into the atmosphere. The *theoretical draft* of a chimney is the calculated buoyancy of a column of flue gas of chimney height in atmospheric air, or the difference in weight (expressed as pressure) of identical sized columns of flue gas and atmospheric air. The draft equation is

$$\text{Theoretical draft as in H}_2\text{O} = 7.6 \left(\frac{b_{\text{mm}}}{760} \right) \left(\frac{T_s - T_a}{T_s T_a} \right) (H) \quad (2)$$

where b = barometric pressure, mm Hg

T_a = atmospheric air temperature, °R

T_s = average stack-gas temperature °R

H = height of stack, ft

The ideal-gas law and the same molecular weights for air and flue gas are assumed. (The latter assumption may introduce an error of about 5 per cent.)

Stack temperature decreases with distance from the breeching by *0.2 to 1.0°F per foot*, depending upon the insulating properties of the construction, the flue velocity, the extent of air infiltration, and inside and outside temperatures. In Eq. (2), T_s may be calculated from the temperature of gases entering the stack, by subtracting the estimated temperature loss from that point to a point half of the remaining chimney

height above it. In other words, the average stack temperature may be taken as the temperature midway between the gas inlet and the top.

It is not economical to construct chimneys higher than 225 to 250 ft (corresponding to about 1.5 in. of theoretical draft) for the purpose of producing draft. Higher chimneys are sometimes desirable to disperse nuisance or noxious dusts or fumes.

Available Draft. Chimney cross-sectional areas are designed on the basis of handling 1,000 to 3,500 lb of combustion products per square foot per hour. Natural-draft flue temperatures are frequently between 500 and 800°F. Corresponding minimum and maximum flue velocities considering both quantities and temperatures are approximately 7 and 30 ft/sec, which may be taken as working limits for natural draft operation. However, stack velocities as high as 40 ft/sec have been used. Available draft is less than theoretical draft by kinetic or velocity head and friction losses. Algebraically,

Actual draft = theoretical draft - velocity head - friction losses

Velocity head and friction losses vary with the square of linear gas velocity (see Chap. IX). For typical flue gases, the equations are

$$\text{Velocity head as in. H}_2\text{O} = \frac{0.12(V^2)}{T} \quad (3)$$

$$\text{Friction loss as in. H}_2\text{O} = \frac{0.002(H)(V^2)}{(m)(T)} \quad (4)$$

$$= \frac{0.008(H)(V^2)}{(D)(T)} \quad (4a)$$

where V = av linear velocity of flue gas, ft/sec

T = av temperature, °R

H = height of stack or length of duct, ft

m = hydraulic radius, ft ($m = D/4$ for circular cross sections)

D = diameter of circular stack or duct, ft

Equations (3) to (4a) apply to both stacks and connecting flues or breechings. Velocity-head loss should be evaluated only once, at the point of maximum velocity whether it be stack or breeching. Friction losses are calculated as the sum of the component losses through breechings, interconnecting flues, and the stack. Each 90° turn in a flue introduces a friction loss equivalent to about 10 diameters of the straight pipe.

Kinetic and friction losses are negligible at the lower limit of velocity mentioned but become of controlling importance at the upper limit.

Rule-of-thumb friction allowances are 0.05 in. H₂O for each 90° turn, 0.1 in. for 100 ft of flue, and available draft at the stack 80 per cent of the theoretical. Tables of economic chimney proportions versus draft and

capacity may be found in handbooks, but all such figures are approximations only.

Types of Construction. Types of construction in order of decreasing cost (and also general sightliness) are brick or tile; reinforced concrete, self-supporting steel, and guyed steel. Since brick and concrete stacks last longer than those of steel, economic differences figured over the probable life of the stack are considerably different than first costs alone would seem to indicate.

Wind load is a major factor in chimney design, since stresses caused by high winds are greater than those due to structural weight. Calculated stress caused by wind velocity of 100 or 125 mph is used as basis of design. For nicety's sake, the chimney may have a slight inside taper to give uniform velocity as the gas cools. However there is little real advantage to this, and stacks are built with approximately constant inside diameter. Circular cross sections are the most economical, but other shapes are occasionally used. Brick chimneys are designed to withstand compression stress of wind load plus weight on the leeward side, and a maximum net tension stress of only about 25 psi is allowable at any point on the windward side (in brick constructions). Radial tile are available both as solid forms and Custodis or special hollow varieties. Wiederholt is a special chimney tile consisting of a skeleton frame with complete inner and outer surfaces. These tile are set in place and filled with reinforcing steel and concrete, so that the tile form the entire facings, but the reinforced concrete provides the strength. Chimneys built entirely of reinforced concrete need weigh only about a third as much as those of all-brick construction. The Wiederholt type is slightly heavier than straight reinforced concrete, but more sightly. Lightning-rod protection should be provided with brick and concrete stacks.

Self-supporting steel stacks are flared out near the bottom and anchored at the base. Hence wall thickness must be sufficient to avoid buckling on the leeward side due to wind pressure. Guyed steel stacks are the cheapest to construct in diameters less than 7 ft and heights under 150 ft. This type is the lightest of all in weight, since wall thickness need be sufficient only to carry the chimney weight plus the vertical component of guy wire stress.

Exterior and interior corrosion both become severe in steel stacks at extremely high temperatures, whereas only interior corrosion is rapid at or below dew-point temperatures. Large steel chimneys are often lined with brick over a portion of or their entire height for the purpose of reducing both temperature loss and interior corrosion.

Supplementary Reference

TRINKS, W.: "Industrial Furnaces," Vol. I, 3d ed., Chaps. 2, 5, 6, John Wiley & Sons, Inc., New York, 1934.

Exercises

1.
 - a. What are the advantages of suspended walls and roofs in furnace construction?
 - b. Metallurgical furnaces and others that operate at high temperatures and hold heavy charges may in some cases use suspended roofs but not suspended walls. Why?
2.
 - a. What are the general conditions favoring the use of natural draft only? of forced draft? of induced draft?
 - b. What is the optimum pressure in a firebox? How may it be obtained and maintained at the proper value?
 - c. In the design of a firebox, what are the important factors to be considered in deciding upon the number and the location of the gas or oil burners?
3.
 - a. If a furnace has been designed for pulverized-coal firing, can it be readily converted to gas or to oil firing? Is the reverse usually true?
 - b. Is the conversion of a furnace to the firing of some other fuel likely to affect its efficiency? Explain.
 - c. Should a furnace be designed for gas or for oil if conversion to the other fuel may sometime be desired?

4. A furnace to be fired with either gas or oil is to generate 10 million Btu/hr and operate at an approximate temperature of 2000°F. It is agreed that natural draft is to be used and that the maximum actual draft need not be greater than 0.6 in. H₂O.

The furnace will be direct-connected to a steel stack, and the temperature at the base of the stack will be at least 600°F. Assuming 50 per cent excess air and a furnace efficiency of 80 per cent, specify reasonable values for

- a. Firebox volume in cubic feet.
- b. Diameter of the stack.
- c. Height of the stack above the breeching connection.

CHAPTER XV

TUBE HEATERS

BOILER FURNACES

Of all heat generated by industrial furnaces, more is used for producing steam than for all other purposes, and boiler designs are very numerous. Ordinarily, *low-pressure boilers* produce steam for heating, whereas *high-pressure* boilers produce steam to be used for power generation. Several arbitrary definitions of boiler capacity and performance are in use and, although these are obsolescent and have little fundamental significance, they are useful for purposes of design and comparison. The common definitions are

1 lb equivalent evaporation from and at 212°F = 970.3 Btu

= heat of vaporization at 212°F

1 boiler horsepower (BHP) = 34.5 lb of equivalent evaporation per hour

= 33,480 Btu/hr

“Convection types” of boilers are sometimes rated on the basis of *10 sq ft of heating surface per boiler horsepower*.

Water-tube boilers are very conservatively rated. They are often operated at loads far above their boiler horsepower rating. Fire-tube boilers are more closely limited to their rated capacities, since with harder firing the draft loss increases rapidly and circulation of water also becomes inadequate.

The maximum heat release in the furnaces of refractory-set stationary boilers is between *20,000 and 40,000 Btu/(cu ft)(hr)* depending chiefly upon the method of firing. Water-cooled furnaces can withstand considerably higher release rates than others, as noted in Chap. XIV. Small furnaces can be operated at higher release rates than large ones of similar design, owing to greater surface-to-volume ratio.

The overall efficiency of a boiler plant depends upon a large number of factors: size, design, type and grade of fuel used, method of firing, load factor and its fluctuation, and attention given to operation. The smaller industrial units obtain efficiencies of 70 per cent or less. Large units under usual conditions obtain 80 to 85 per cent efficiency, while test values of over 90 per cent have been recorded. Sensible heat contained in flue gases is responsible for most of the lost heat, while the smaller items of carbon monoxide in the gas, ashpit losses, and radiation from settings account for the balance.

Necessity for Feedwater Treatment. Solids present in all natural water supplies are concentrated by boiler evaporation. These are removed by "blowing-down" or bleeding off at the bottom of the boiler, so that precipitated solids are removed along with solids in solution. Nevertheless, the internal concentration of solids is many times that of the feedwater. Scale-forming and corrosive tendencies are greatly aggravated both by concentration effects and by elevated temperatures.

A boiler can be ruined in a short time by using an untreated or improperly treated feedwater. The higher the pressure and temperature of operation, the more exacting must be the water treatment.¹ This is of utmost importance and is a field in itself, hence is not taken up here.

Boiler Classification. The principal classification of boilers refers to the heat-transfer surface: (1) cast-iron (sectional), (2) plain double-shell, (3) fire-tube (combustion gases inside tubes), (4) water-tube.

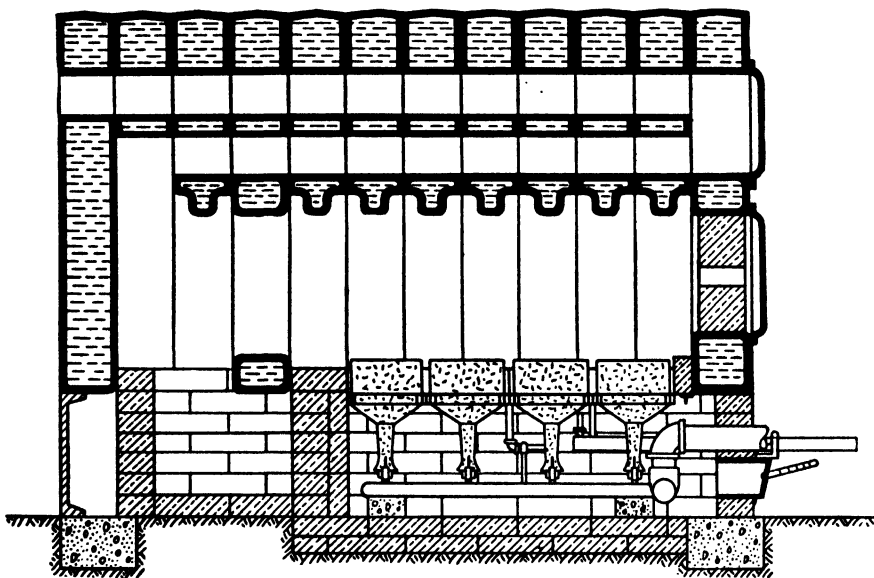

FIG. 1.—Cast-iron sectional boiler. (Courtesy of Webster Engineering Company.)

Cast-iron Boilers. For steam heating of houses and small apartment buildings, cast-iron boilers are the type most commonly used. These are often constructed in the form of narrow unit sections, and the heating capacity is determined by the number of sections connected together to make up the boiler (Fig. 1). Cast-iron boilers cannot be used for generating steam at more than 15 psig and are not economical in large capacities.

¹ PARTRIDGE and PURDY, *Ind. Eng. Chem.*, **31**, 387 (1939). FELLOWS, C. H., *Mech. Eng.*, October, 1944, p. 639.

Plain Double-shell Boilers. These are found in small sizes exclusively, up to 10 or 20 bhp, and for working pressures seldom above 100 lb, although fairly common for small-capacity industrial installations (Fig. 2). Their thermal efficiency falls off rapidly with hard firing, and they are not economical to construct in large sizes or for higher pressures. To fire a small boiler with oil, a refractory burner mounting or hearth must be provided (Fig. 3 in Chap. X):

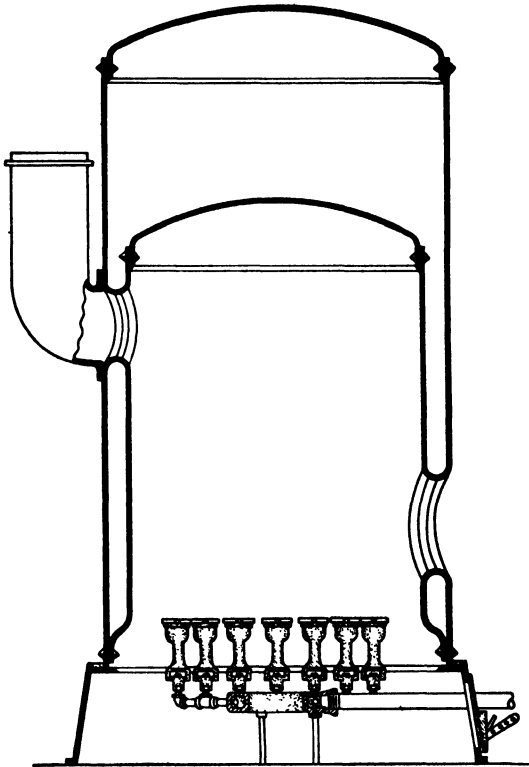

FIG. 2.—Plain double-shell boiler (small capacities only). (Courtesy of Webster Engineering Company.)

Fire-tube Boilers. Where space is at a premium or portability is required, a fire-tube type of boiler is indicated. The combustion gases pass inside the tubes, giving high rates of heat transfer. This type of boiler should have nonscaling feedwater, since the scale forms on the outside of the tubes, and a hard scale once formed is inaccessible for removal by mechanical means. (The tubes are placed close together and are enclosed by the shell.)

● Fire-tube boilers are constructed in small- and medium-sized units. Horizontal types predominate, but small vertical or upright units are

fairly common. Draft losses are higher than for other classes of equal capacity. Forced draft is often needed where firing with coal, but they may be successfully fired with natural draft by using high-pressure gas or steam-atomizing oil burners.

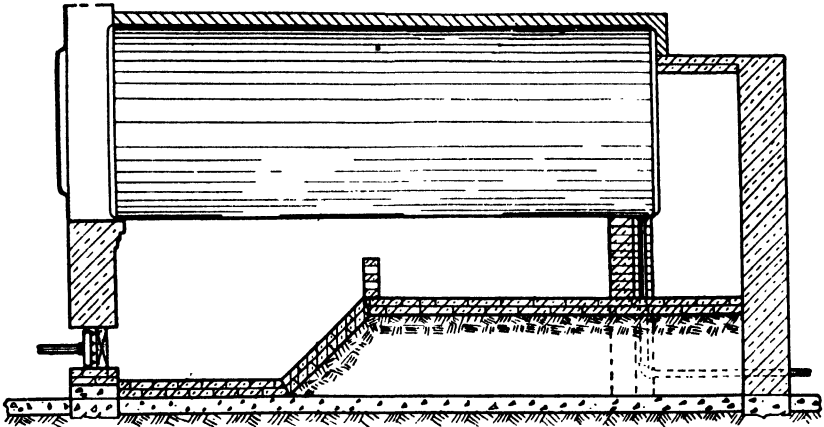

FIG. 3.—Horizontal return-flow fire-tube boiler (stack at front). (Courtesy of Webster Engineering Company.)

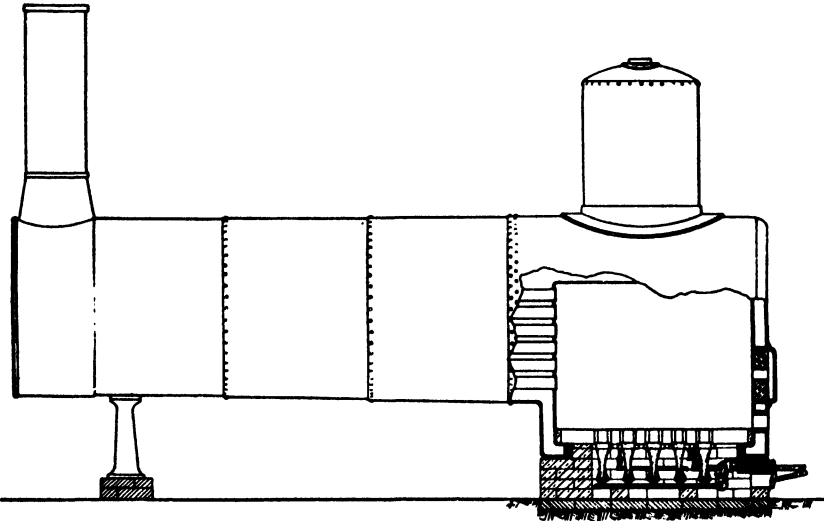

FIG. 4.—Oilfield or locomotive-type boiler. (Courtesy of Webster Engineering Company.)

Some fire-tube boilers have part of the outer shell exposed to the flame. The horizontal return tubular type shown in Fig. 3 is mounted on a firebrick setting. The underside of the shell forms the roof of the combustion chamber and absorbs considerable heat. The gases pass into the tubes at the back end and flow forward and out into the stack

through the front breeching. The heat-transfer duty of this type is relatively low, amounting to only 4 or 5 lb of equivalent evaporation per square foot of tube surface area per hour. Maximum steam pressure is about 150 psig.

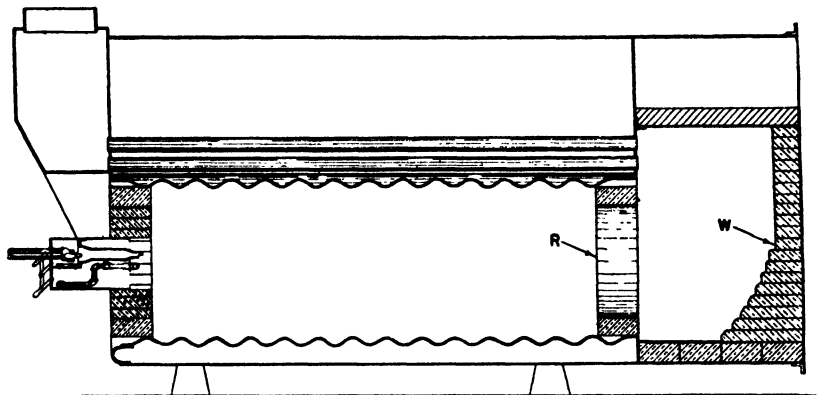

FIG. 5.—Scotch marine boiler. (Courtesy of Webster Engineering Company.)

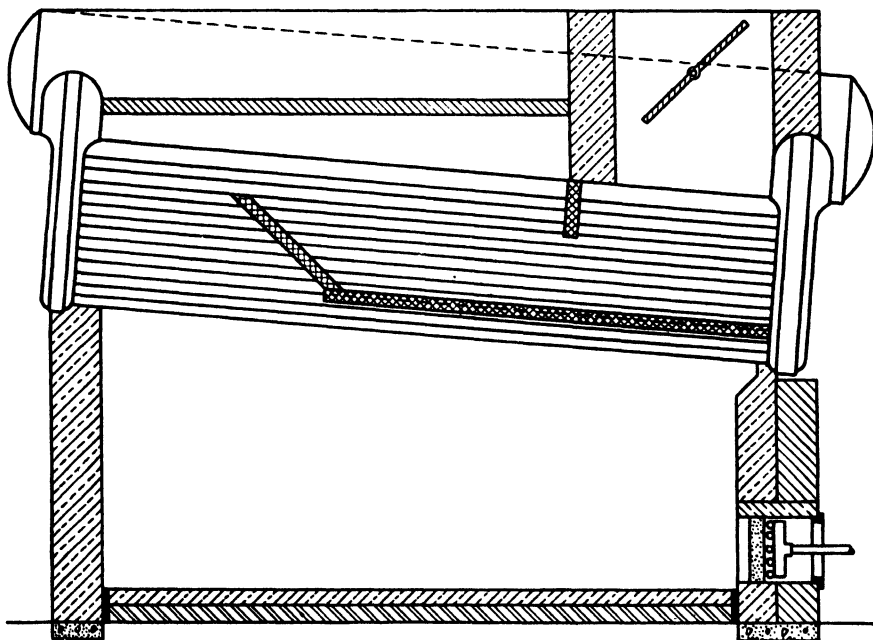

FIG. 6.—Straight-tube inclined-drum type of water-tube boiler with box headers. (Courtesy of Webster Engineering Company.)

The *oilfield* or *locomotive-type* boiler (Fig. 4) does not require a masonry setting; the firebox is part of the boiler itself so that water-cooled surfaces almost completely surround the flame. Since the unit is portable,

it has undoubtedly been subjected to a wider range of operating conditions and purposes than has any other type.

The *Scotch marine* boiler shown in Fig. 5 is extremely economical of space, permitting a heat release of $50,000 \text{ Btu}/(\text{cu ft})(\text{hr})$. Its evaporative duty is seldom above 18 or $20 \text{ lb}/(\text{sq ft})(\text{hr})$, however. Since the corrugated shell cools the flame very rapidly, care must be exercised in the selection and mounting of the burner to avoid incomplete combustion. To offset the effects of the large cold surface upon combustion, a refractory burner mounting and other refractory surfaces such as the *combustion ring R* and *back wall W* are provided.

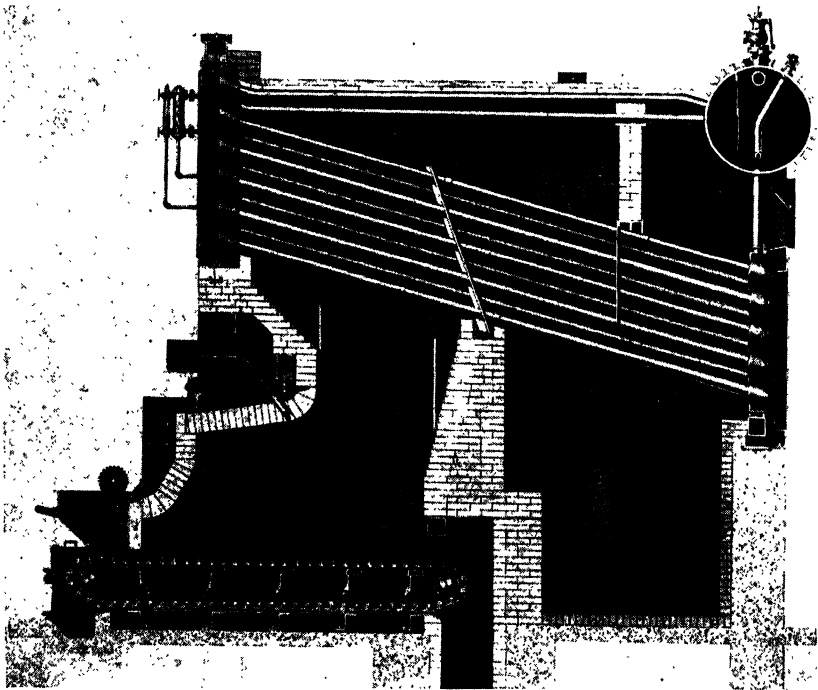

FIG. 7.—Straight-tube, cross-drum type, with cast headers. (Courtesy of Babcock and Wilcox Company.)

Water-tube Boilers. Medium to large size and high-pressure boilers are most economical in water-tube types. Common tube diameters are 3 to 4 in., and *heat-transfer duty* at full capacity may be as high as $15,000 \text{ Btu}/\text{sq ft}$ of tube surface per hour. These may be subdivided into straight-tube and bent-tube types of construction.

In *straight-tube* boilers, as the name implies, the tube bank or “convection surface” is composed of straight tubes mounted between headers. Low-pressure boilers may use box headers which are large, flat, stayed

boxes. Higher steam pressures require individual headers for each column of tubes. These are usually made sinuous to give a staggered arrangement of tubes in the bank. The box-header construction is illustrated in Fig. 6, and sinuous headers are shown in Fig. 7. Straight-tube boilers are known either as *longitudinal-drum* or as *cross-drum*, depending upon whether the drum axis is parallel or perpendicular to the axis of the tubes.

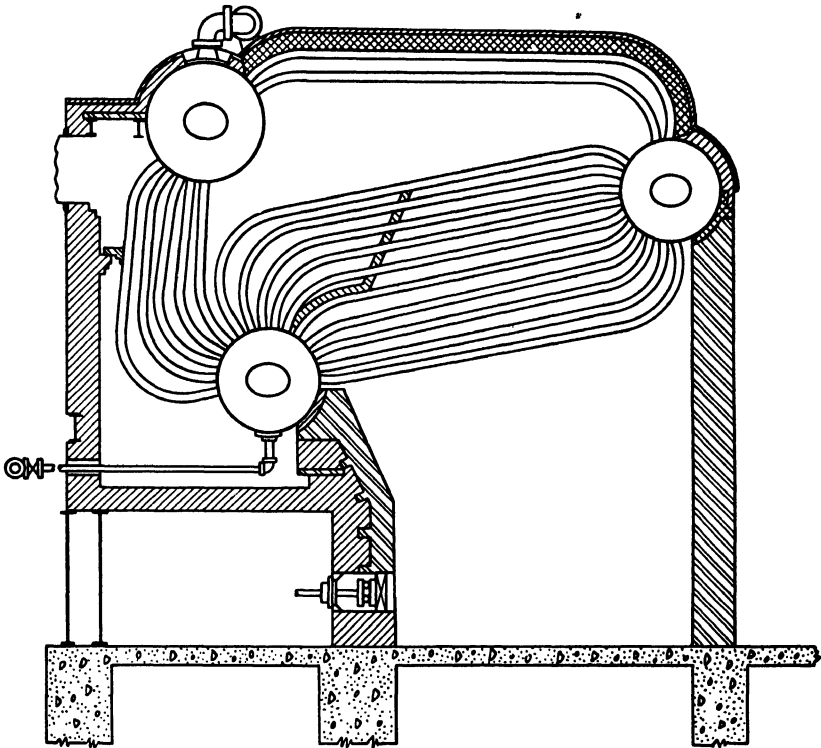

FIG. 8.—Bent-tube type of boiler. (Courtesy of Webster Engineering Company.)

An advantage possessed by the longitudinal-drum type is high water and steam storage capacity, which is desirable when there is a rapid and wide fluctuation in steam demand. However, this type of boiler is limited in width of tube bank per drum, a wide boiler requiring a number of drums. Cross-drum boilers are unlimited in width per drum, and single-drum units can be designed to have any desired capacity.

Bent-tube boiler construction permits great flexibility of design. Tubes are arranged to obtain uniform heat absorption, permitting high firing rates. Effective baffling arrangements offer less obstruction to the gases than is possible to obtain with straight-tube types, resulting in lower draft losses. These boilers are commonly constructed with two,

three, or four drums. Figure 8 shows a three-drum unit. The highest drum serves both as a water reservoir and as a steam-and-water separator. The lowest drum accumulates sludge that is periodically removed by

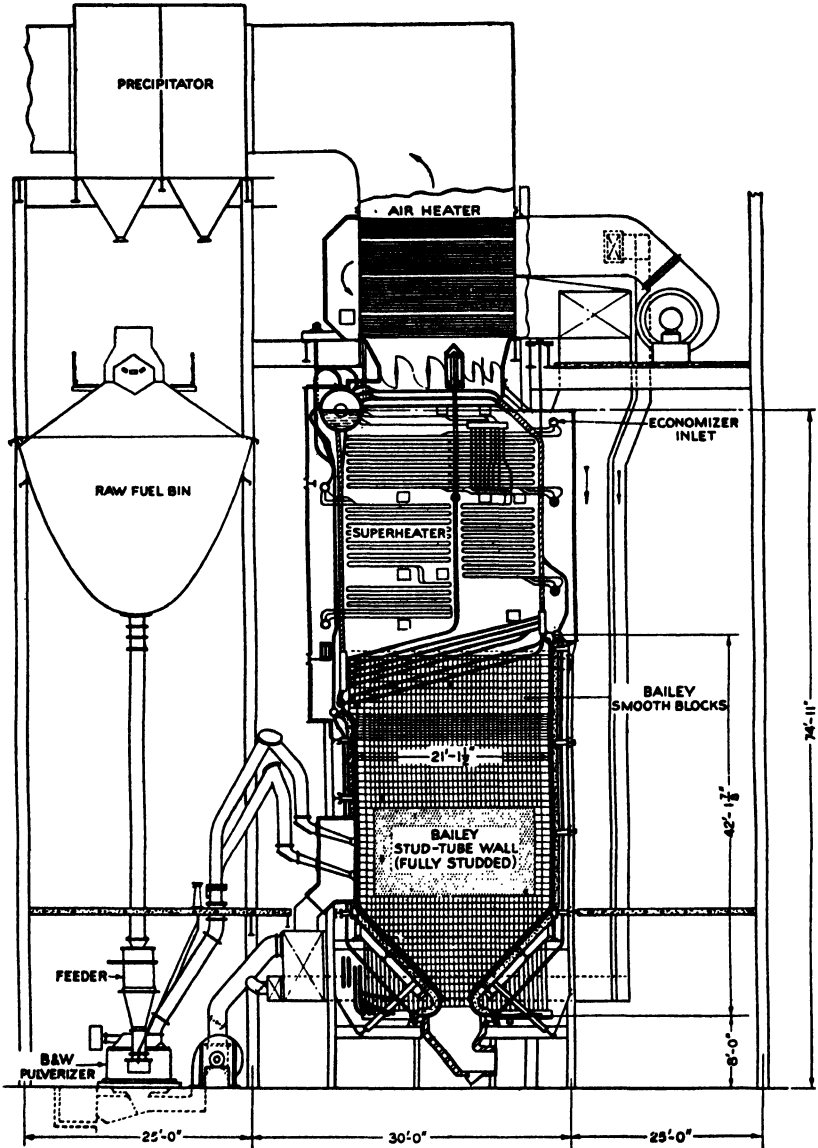

FIG. 9.—Central-station boiler plant. (Courtesy of Babcock and Wilcox Company.)

“blowing down” through the small pipe connected to the bottom of this drum. The central drum serves principally as a tube header. Water circulation between drums in Fig. 8 is in a counterclockwise direction.

Faster circulation of water can be obtained by placing several down-take tubes outside the setting. Since these outside tubes are not heated, no boiling occurs in them and a rapid flow of water from upper to lower drums takes place, ensuring continuous flow in the *opposite direction* through the *heated* tubes. The same effect with slower circulation exists when all tubes are inside the setting but heated at different intensities.

In a bank of tubes, the first row directly exposed to the flame absorbs two to three times as much heat as a row inside the bank.

Central-station Boilers. The largest type of boiler is customarily referred to as the *central station*, as it is used principally in large power plants. These are always of the water-tube type but are built in a wide variety of designs. Units are in service that generate more than a million pounds of steam per hour, and the pressures are as high as 2,500 *psig*.

A central-station boiler designed to make 375,000 lb of steam per hour at 1,375 *psig* pressure and superheated to 900°F is shown in Fig. 9. The furnace is of water-cooled construction and equipped with a hopper bottom for dry-ash removal. Furnace tubes are covered with cast-iron blocks except for the studded, refractory-covered areas in the burner zone. The small amount of bare or convection-tube surface in the boiler is mainly in the form of straight tubes. Superheat is controlled by altering the position of the dampers beneath the air heater, which varies the amount of gas flowing through the side containing the superheater. Final cooling of the gas is accomplished by the air heater.

Large central-station units employ both induced-draft and forced-draft fans, since the range of total draft loss is from 6 to over 20 in. H₂O.

SUPERHEATERS

Superheated steam shows great economy over saturated steam in power generation. The use of superheated steam causes much less condensation to occur within the cylinders or turbines of prime movers, especially when operated condensing, or with the exhaust completely condensed under vacuum. The resulting high thermal efficiency or conversion of heat into work is directly attributable to superheating.

Superheaters within the boiler setting (integral superheaters) consist of a number of parallel tube circuits terminating in manifolds or headers. They are of two general types: radiant and convection.

Radiant superheaters are built into furnace walls, and most of the heat is transferred to these walls by radiation. With this type of superheater, the steam outlet temperature decreases as the load increases. Care must be exercised to avoid overheating the tubes during starting-up periods.

Convection superheaters consist of banks of bare tubes. They receive heat from combustion gases that sweep their surfaces in a direction that

may be either longitudinal or transverse to the tube axes. Steam outlet temperature increases with load for this type, and the farther the superheater is located from the combustion zone the greater this effect becomes. Convection superheaters may be subclassified into *interdeck* and *overdeck* varieties, according to location with respect to boiler convection tubes. The boiler shown in Fig. 5 of Chap. XIV contains an interdeck superheater. As a rough approximation, convection superheater surface equivalent to 1 per cent of the steam-generating surface gives 5°F of superheat in the overdeck location, and 10°F in the interdeck position.

Control of Superheat. It is desirable to maintain constant steam temperature for the best operation of prime movers over a range of load. This can be accomplished in several ways. By proper combination of radiant and convection surface, temperature can be made nearly independent of load. Dampers controlling the quantity of gas coming in contact with the tube surface are often employed to regulate superheat. A third method of control is to *desuperheat* the steam, either by injection of water spray or by causing part or all of the steam to pass through tubes submerged in the boiler water. A separately fired superheater unit permits constant steam temperature to be maintained under all conditions of load. In such a unit, a control thermostat in the outlet steam line may be used to regulate the rate of firing.

STEAM GENERATORS AND FORCED-CIRCULATION BOILERS

A number of steam-generating units are of more or less specialized design and are therefore not included in the preceding classifications. They are of small to medium capacity and are available in both fire- and water-tube types. Their principal features are portability and compactness, or relatively small size and light weight per boiler horsepower. They are most frequently oil-fired and, since they contain only small amounts of water, they can be lighted and brought up to operating pressure very quickly.

Forced-circulation boilers are usually designed for high steam pressures in order to furnish economical power generation in small- to medium-sized plants. The principle of forced circulation is applied to both "once-through" and "partial-recirculation" types.

The **Benson boiler** is the most common "once-through flow" type. The feedwater is pumped into one end of the tube circuit and makes a continuous passage to the superheater outlet where it is discharged. Since no provision for separation of moisture is needed, no boiler drum is used. An inherent difficulty encountered in this type of flow is the depositing of solids inside the tube at the zone where final evaporation occurs. Flushing at regular intervals is required to remove the deposit that would otherwise soon result in overheating of the tube in that zone.

The **Steamotive boiler** is of the partial-recirculation type and was developed in the United States. Approximately 10 per cent more water is sent through the tubes than is converted to steam. The steam (of about 90 per cent quality) discharges from the evaporating-tube circuits into a separator, from which dry steam is taken out to a superheater section. The separated water passes through a feedwater heater and into the suction side of the feed pump. Concentrations of solids are maintained within allowable limits by blowdown from the separator drum. The unit is automatically controlled and is adapted to locomotive and to marine use.

The **Velox boiler** recirculates about 10 per cent of the water but is fundamentally different from other units in that a pressure of about 35 psig is maintained in the combustion chamber. Combustion at this elevated pressure permits low excess air and high rates of combustion. High-velocity flow of the gases past the heat-absorbing surfaces give extremely high rates of heat transfer. The disadvantages of the unit are its complexities. It requires an exhaust-gas turbine, an efficient air compressor, and an auxiliary starting turbine or motor.

WASTE-HEAT BOILERS

A number of industrial operations produce heat as a by-product or use heat at a high temperature level. Where large amounts of gas at a

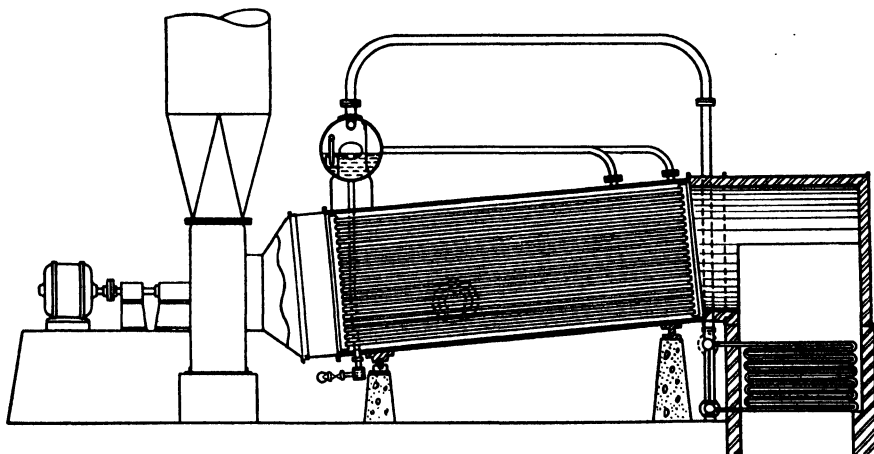

FIG. 10.—Fire-tube type of waste-heat boiler. (Courtesy of Babcock and Wilcox Company.)

temperature of about 1000°F or higher are to be disposed of, the heat may be profitably recovered as steam generated in a *waste-heat boiler*. These boilers can be used in continuous and in short-cycle processes. For intermittent and longer cycle operations, the heat is best recovered by using the gas to preheat the combustion air, the furnace charge, or both.

The more common applications of waste-heat boilers include large diesel power plants, gas-producer and water-gas sets, certain metallurgical furnaces and smelters, dry-process cement kilns, and sulfuric acid plants. As an example of the last-named, a contact acid plant making 200 tons of acid per day cools the burner gases from 2200 to about 600°F with a waste-heat boiler that generates 16,000 lb of steam at 175 psig.

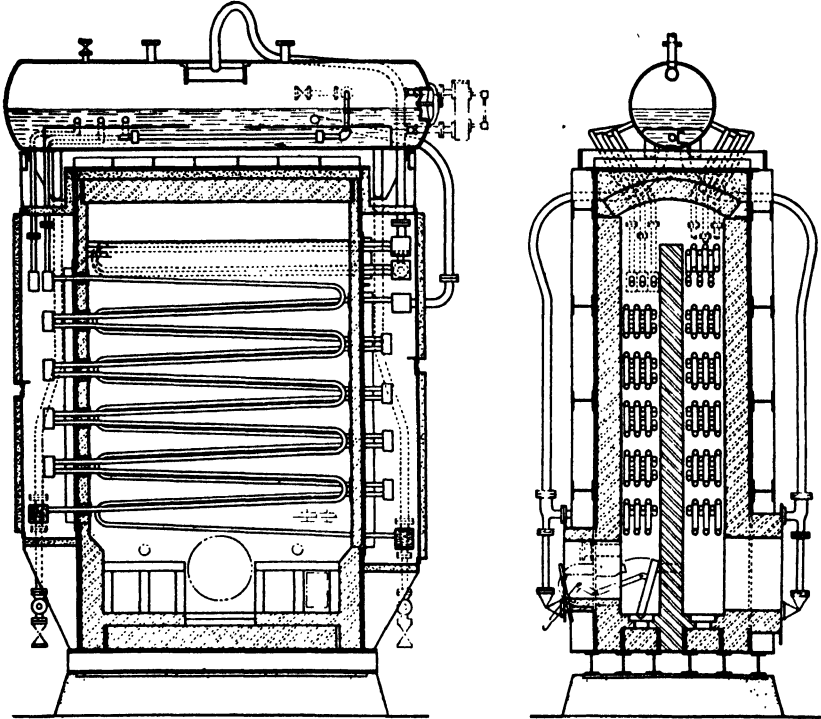

FIG. 11.—Water-tube type of waste-heat boiler. (Courtesy of Babcock and Wilcox Company.)

Both fire-tube and water-tube types are used in waste-heat recovery (Figs. 10 and 11). The former is the more compact but has a greater draft loss. Both types increase overall draft loss to some extent and may not be economical in small capacities if they require the installation of a forced-draft fan. For handling very dusty gases such as from a smelter or cement kiln, the water-tube type with the tubes mounted vertically gives least trouble from accumulation of dust.

HIGH-TEMPERATURE-FLUID SYSTEMS

Numerous processes require heat at a closely controlled temperature and with very little film overheating. Direct heating with flue gases is often unsatisfactory for such applications, and the use of some other

high-temperature fluid is indicated. Fluid heating applications include evaporation, distillation, and drying of chemical products; solvent stripping; varnish making; plastics molding; baking; catalytic chemical reactions, and certain catalyst regenerations.

High-temperature-fluid heating is accomplished by circulating the fluid between a tube furnace and the heat-transfer surface in the vessel to be heated. Fluids used for this purpose include flue and other inert gases, condensing vapors, and certain liquids.

Gas Systems. Since gases have relatively low heat capacity per unit volume, large volumes must be handled per Btu transferred. Since they must cool as the heat is transferred, the material heated must tolerate some film overheating. The simplest arrangement is merely partial recirculation of flue gases through a furnace or kiln, which provides a more uniform temperature and avoids extremes of local overheating.

Flue gas is used to dry volatile inflammable solvents from impregnated materials, and for reconcentrating used sulfuric acid. There are few other common applications.

Vapor Systems. Vapor heating systems are by far the most prevalent, since condensing vapor releases its heat of condensation at a definite temperature. Furthermore, the temperature is readily controllable by altering the condensing pressure on the system.

Substances used for vapor heating are saturated steam, mercury, Dowtherm A, and certain other organic compounds. Some of the significant thermal properties of the first three are given in Table 1.

TABLE 1

	NBP °F	Latent heat at NBP, Btu per lb	Usual temp range, °F	Corresponding press, psia
Saturated steam.....	212	970	50-580	0.18-1320
Dowtherm A.....	500	123	450-700	8-90
Mercury.....	675	122	600 to over 1000	6.6 to over 180

Saturated steam is of course generally used for temperatures up to about 400°F at which the pressure is 247 psia. Dowtherm A is a eutectic mixture consisting of 73.5 per cent diphenyl oxide and 26.5 per cent diphenyl, melting at 53.6°F. It was developed specifically for use as a high-temperature or boiler fluid, since it permits higher temperatures and at much lower pressures than can be obtained with steam.² A Dowtherm heating system is shown in Fig. 12. The boiler contains two horizontal drums, one set directly above the other. Circulation through

² DEAN, D. K., *Ind. Eng. Chem.*, **31**, 797 (1939).

the furnace tubes is in a clockwise direction. Separate temperature regulation for several users supplied from a single boiler source is accomplished by individual throttle valves that control the condensing pressures. For a gravity-return system, each user must be installed at a sufficient height above the boiler so that condensing pressure plus hydrostatic pressure of the liquid leg (H) above the level in the boiler drum is equal to the boiler pressure. When this is not convenient, the condensate may be pumped back to the boiler. All-liquid phase Dowtherm systems may be used where a constant heat supply temperature is not required.

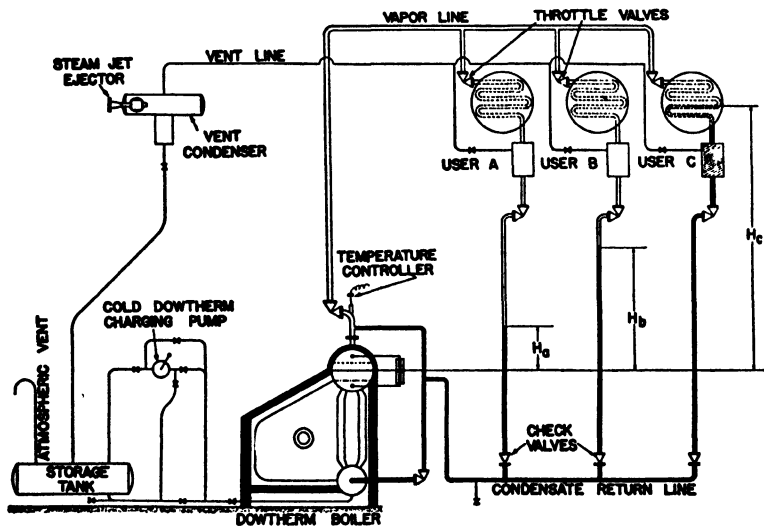

FIG. 12.—Arrangement of Dowtherm vapor generator applied to three different users and designed for throttling so as to operate at different pressures and temperatures. (Courtesy of Dow Chemical Company.)

The use of mercury as a high-temperature fluid is confined to power generation and to a few processes requiring heat at exact temperatures above 700°F as in certain petroleum conversion processes (Sun Oil Co.). Mercury is expensive, highly poisonous, and requires special grades of steel to handle it safely. However, it permits of a higher cycle or thermal efficiency in power generation than does steam.

Liquid Systems. The more common heat-transfer liquids are water, aqueous solutions, oils, and molten lead. High-boiling oils are fairly stable to about 550°F and may be used at even higher temperatures by periodical replacement.

HTS is a new high-temperature liquid, that is a low-fusing salt mixture having the composition, 40 per cent sodium nitrite, 7 per cent sodium nitrate, and 53 per cent potassium nitrate.³ This ternary mixture is

³ KIRST, NAGLE, and CASTNER, *Trans. AICHE*, **36**, 371 (1940).

more stable than the binary mixture of equal parts of sodium nitrite and potassium nitrate that melts at 282°F. HTS melts at 288°F. and has a specific heat of 0.37. It is useful for temperatures approaching 1000°F and is in service as a heating fluid for regenerating Houdry cracking process catalyst and for revivifying oil decolorizing clays in some instances. Other applications will undoubtedly be made of it as time goes on.

PETROLEUM HEATING AND CRACKING FURNACES

Evolution of the Tubestill Heater. The distillation of petroleum was originally carried out by heating it in a cylindrical steel drum mounted over a firebox. This apparatus was known as a *shell still*. It was originally a batch operation and beset by many troubles. The crude often contained water in the form of an emulsion which was apt to break suddenly, and cause the still to boil over. As the distillation proceeded and the temperature rose, coke formed and was deposited on the hot surface, causing the shell to overheat and necessitating a shutdown to clean out the solid residue. Many devices were tried for the purpose of reducing coking troubles and for facilitating coke removal. These included scrapers, double shells, and other innovations, none of which was very satisfactory.

Later, shellstill operation was made continuous by connecting a number of stills in series and removing a successively heavier distillate from each still in the battery until the bottoms from the last still was a heavy residual oil. The operation was further improved by mounting a short fractionating column on each unit. The battery was necessarily expensive and bulky and degraded the heavier portions of the crude, since the oil was exposed to high temperatures for 24 hr or longer during its passage through the battery.

Cracking operations were conducted in single shell stills under pressure. Here, carbonization was very pronounced, permitting runs of only 18 to 24 hr. The first significant improvement in cracking-still design was the use of a unit identical in form with the straight-tube type of water-tube boiler. In this apparatus, better oil circulation enabled longer runs and, since the coke was deposited mainly in the tubes, cleaning out was accomplished without waiting for the unit to cool. Shell stills had to be cooled sufficiently to permit cleanout men to work inside them. Batch cracking operations have been discontinued since about 1925, but some shell stills in straight-run distillation service remain in use. No new shellstill installations have been made for a number of years.

The original tube still seems to have been disclosed in a patent to J. A. Dubbs in 1915, as an apparatus for *dehydrating* crude petroleum

emulsions under heat and pressure. The apparatus simultaneously produced cracked gasoline and was soon adapted to cracking service. Not until about 1925 was it generally appreciated that the tube still was superior in all respects to the shell still for straight-run distillation as well as for cracking. All of the tube still's advantages could not be realized however until efficient fractionating and stripping columns were available to the petroleum refiner.

Tubestill Heater Types. The elements of a tubestill heater consist of a combustion chamber or *radiant section* and a *convection section* (Fig. 13). For heating the oil, the tubes in the radiant section are

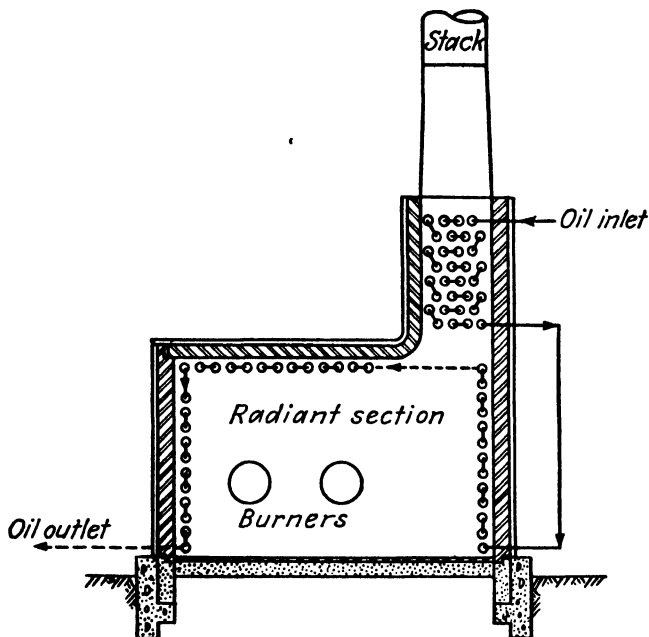

FIG. 13.—Typical overhead convection-section furnace. (Courtesy of W. E. Lobo.)

placed in single rows close to the refractory walls and roof; 60 to 80 per cent of the total absorbed heat is picked up in this section. The oil enters through the convection bank of tubes, contacting the partly cooled gases from the radiant section.

Most heaters have these two sections in one form or another. A somewhat larger furnace such as the one shown in Fig. 14 has tubes along the side and bridge walls, and a staggered double row of roof tubes. It was designed for cracking service. Furnaces to be used for cracking have more tubes than straight-run distillation heaters of equivalent throughput. Oil to be cracked must be heated 200 to 400°F higher than for straight-run distillation; the oil is often *soaked* or held at cracking temperature within the furnace for a period of time, and the cracking reac-

tion itself usually absorbs heat. In this heater, the *soaking* or *cracking tubes* consist of the upper row of roof tubes, and also a bank *between* two separate preheating banks in the convection section, as may be seen by tracing the flow diagram.

Figure 13 shows a cracking furnace with the convection section above the combustion chamber. This furnace is fired from the floor with gas burners and has auxiliary burners in the walls. A temperature-heat input diagram for it is shown in Fig. 16, the oil having been preheated to 675°F by heat exchange with hot tower bottoms. Although designed for an outside reaction chamber or soaking drum, this heater could be

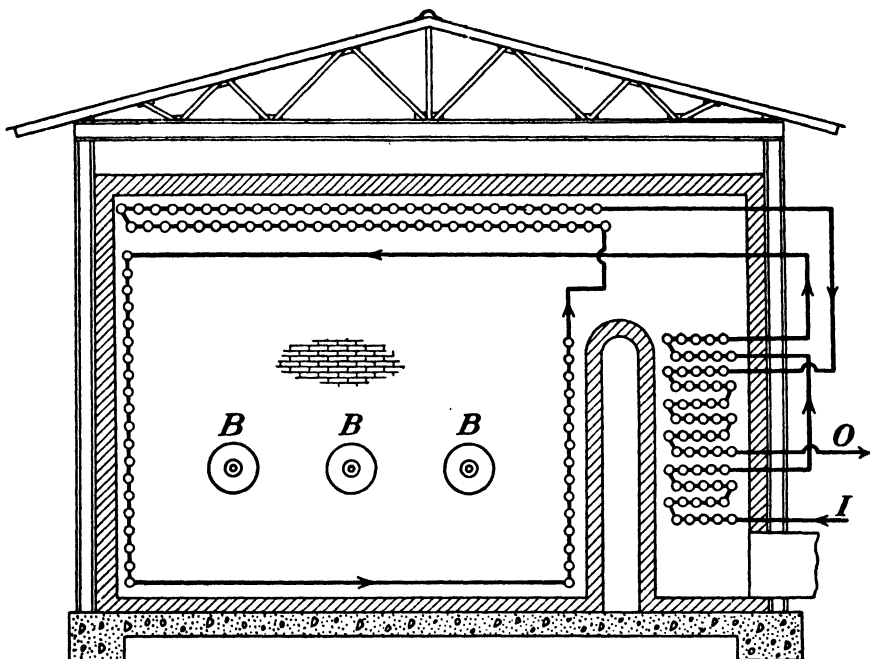

FIG. 14.—Cracking furnace with soaking banks. (Courtesy of Universal Oil Products Company.)

used without one by harder firing. The upper row of roof tubes and wall tubes would then serve as cracking tubes, and the oil outlet temperature would be higher.

Cylindrical heaters (Deflorenz type) have a single circle of tubes mounted vertically near the inside wall of the radiant section. An inherent characteristic of this construction is that all tubes are equidistant from the flame. Figure 17 shows an "upshot" cylindrical heater fired from the bottom, and with the convection section at the top. Immediately above it is an air preheater. "Downshot" heaters of cylindrical construction are fired at the top with the gases being removed at the bottom.

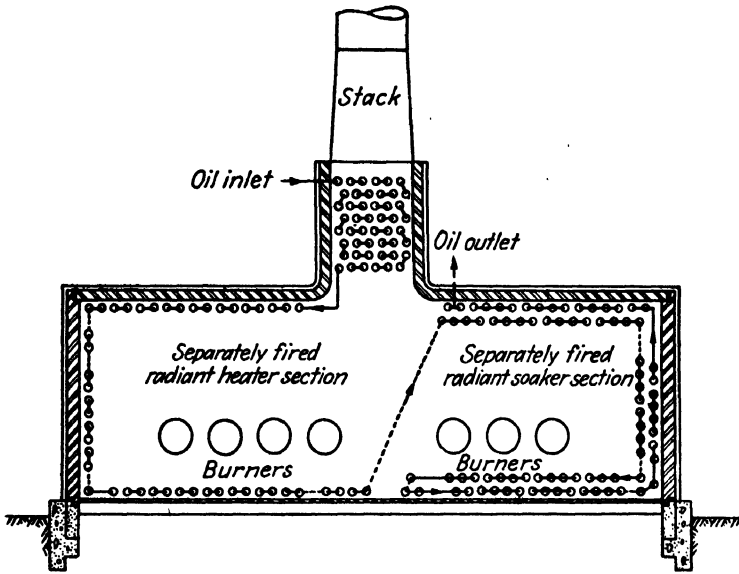

FIG. 18.—Typical double radiant-section furnace with central overhead convection bank. (Courtesy of W. E. Lobo.)

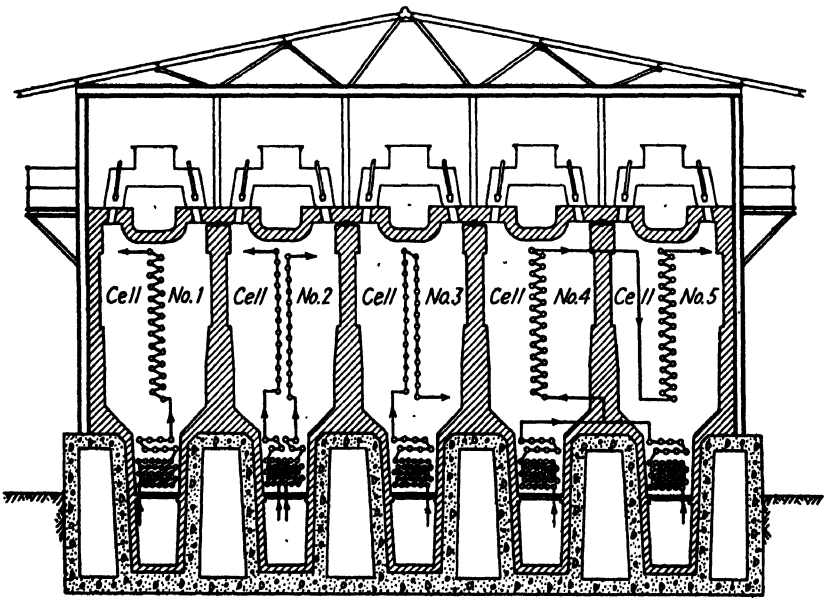

FIG. 19.—Five-cell "Equiflux" heater. (Courtesy of Universal Oil Products Company.)

center of each radiant section, and burners are placed on both sides of these tube banks. This arrangement gives very uniform radiation heating around the circumference of each tube and permits higher rates of heat input than would otherwise be feasible. The multicell construction also permits great flexibility in oil-flow arrangements.

Numerous other heater designs have been tried on a commercial scale, including theoretically correct downdraft types. Very few special designs have found widespread usage, since all are more expensive to construct than the standardized units shown. Advantages gained in special design are usually offset by increased costs of construction and maintenance.

Oil-heater Design and Operation. Most oil heaters have capacities between 2,000 and 30,000 bbl of oil per day. The tubes are commonly 4 or 5 in. in diameter. In the larger units there are two or more tube streams in parallel, and the total length of tubing is several miles.

The furnace outlet or transfer-line temperature of the oil is between 600 and 740°F for straight-run operations, depending upon the boiling range of the crude, the fraction of it to be vaporized, and the amount of stripping steam used. Transfer-line temperatures in cracking operations are between 950 and 1150°F depending upon the process, type of stock, and depth of cracking desired.

Pressure drop through the furnace tubes is usually 100 to 300 lb in straight-run operations, and up to 700 or 800 lb in a large cracking furnace. Total pressure in the tubes is very low (about 50 lb) for vapor-phase cracking, but as high as 2,000 lb or more for reforming and thermal polymerization processes.

The following factors are useful for the design of tube systems for cracking furnaces:⁴

1. Linear velocities calculated for cold volume of oil should be 6 to 8 ft/sec.

2. A conservative basis of heat-transfer duty for the tubes in the radiant section is 13,000 Btu/(sq ft)(hr) for distillate oils, and 10,000 Btu/(sq ft)(hr) for black oils, both based on outside tube area.

3. The heat-transfer duty for the tubes in the soaking section may be 35 to 40 per cent of the value for the radiant section.

These figures are safe and conservative, for negligible coke formation within the tubes. In heaters used for straight-run distillation of crude oil, coking is not a problem. Maximum heat content of the oil at a given temperature is obtained when vaporization occurs within the tubes. To permit maximum vaporization, pressures and pressure drops through the tubes of a straight-run furnace are kept low. Straight-run

⁴ RICKERMAN, LOBO, and BAKER, *Trans. ASME*, **60**, 521 (1938). *Oil Gas J.*, May 5, 1938.

furnaces are designed on the basis of cold oil velocities of only 2 to 3 ft/sec, and the use of parallel-tube systems is common. In the radiant sections, rates of heat input are about the same as for cracking furnaces.⁵

An oil refinery may force a heater up to twice the rates noted here, although this practice is apt to result in markedly higher maintenance costs.

Placing the tubes in the radiant section all in single rows automatically provides a combustion chamber of adequate volume. Excess air may be maintained between 25 and 40 per cent, and the overall thermal efficiency of a well-designed and properly operated oil heater is about 80 per cent.

HEAT-TRANSFER COEFFICIENTS

Although theoretical correlation of heat-transfer coefficients for tubes in a furnace is highly complex, empirical correlations are available that are of sufficient accuracy to be generally useful.

Convection Section. For heat transferred to a *bank of staggered tubes* by furnace gases, (the convection section of an oil heater or a boiler economizer), the gas *convection coefficient* is given by the equation of Monrad:⁶

$$h_c = \frac{1.6(G^{2/3})(T^{0.3})}{D^{1/2}} \quad (1)$$

where h_c = convection heat-transfer coefficient, Btu/(hr)(sq ft) (°F)

G = mass velocity of gas at minimum free cross-sectional area, lb/(sq ft)(sec)

T = gas temperature, °R

D = tube diameter, in.

However, heat is simultaneously transferred *by radiation from the furnace walls and from the gas* even in the convection section, making the total coefficient considerably higher than that due to convection alone. The total outside surface coefficients ($h_c + h_r$) range from 3.5 to 7.5 Btu/(hr)(sq ft)(°F) in many cases. Reference 6 includes a correlation for these overall coefficients, developed from test data on a number of furnaces by using radiation calculations in connection with Eq. (1).

Radiant Section. For the radiant sections of oil heaters and for sections of bare tubes forming the water wall of a boiler, several sets of relatively simple, empirical equations have been presented which usually give satisfactory results. An early set that is applicable to the radiant sections of both boilers and petroleum tubestill heaters is⁷

⁵ Personal communication from W. E. Lobo, January, 1941.

⁶ *Ind. Eng. Chem.*, **24**, 505 (1932).

⁷ WILSON, LOBO, and HOTTEL, *Ind. Eng. Chem.*, **24**, 486 (1932).

For Single Rows of Tubes:

$$\frac{1}{\mu} = 1 + \frac{G \sqrt{Q/A_c}}{3,200} \quad (2)$$

For Rows of Tubes Two or More Deep:

$$\frac{1}{\mu} = 1 + \frac{G \sqrt{Q/\bar{F} A_{cp}}}{4,200} \quad (3)$$

where μ = fraction of heat available (net) above 60°F absorbed by cold surfaces (tubes)

G = air-fuel ratio (lb/lb) when no gas is recirculated. When gas recirculation is used,

$$= \frac{(\text{lb gases through furnace}) - 1}{\text{lb fuel fired}}$$

Q = firing rate, net Btu/hr

A_c = total tube surface, sq ft

A_{cp} = cold plane area (plane or projected area of tube bank), sq ft

\bar{F} = radiant projection factor, a function of size, spacing, and number of rows of tubes (Fig. 20)

= 1.0 for deep banks of staggered tubes.

Although Eqs. (2) and (3) are apparently safe for conditions of conventional design and operation, they break down at low rates of heat input and may result in errors of unknown magnitude when applied to special designs. A more accurate and general correlation is available that is necessarily more complex.⁸

Illustration. Heat Balance on Pipestill Furnace

A test was made on a 10,000-bbl tube heater used for the straight-run distillation of crude oil. The unit was fired with natural gas and had six burners, three on the north side and three on the south side.

The oil flow through the tubes is indicated on Fig. 21. The crude after heat exchange with the tower bottoms enters the preheater bank near the base of the stack, flows upward through the bank and into the wall tubes. From the wall tubes the oil passes through the roof tubes, the afterheater bank, and then out through the transfer

⁸ LOBO and EVANS, *Trans. AIChE*, **35**, 743 (1939).

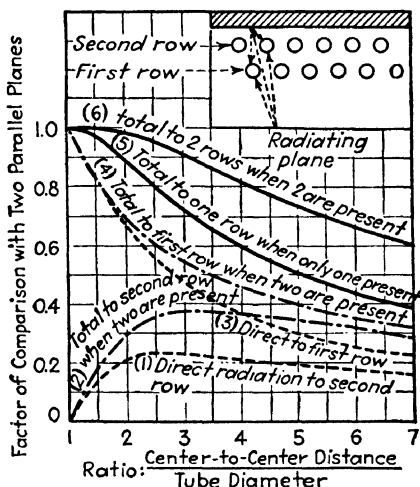

Fig. 20.--Radiant projection factor for rows of tubes). (Courtesy of H. C. Hottel.)

line to the fractionating tower. A steam superheater bank is placed between preheater and afterheater banks to superheat the plant steam used in the fractionating tower.

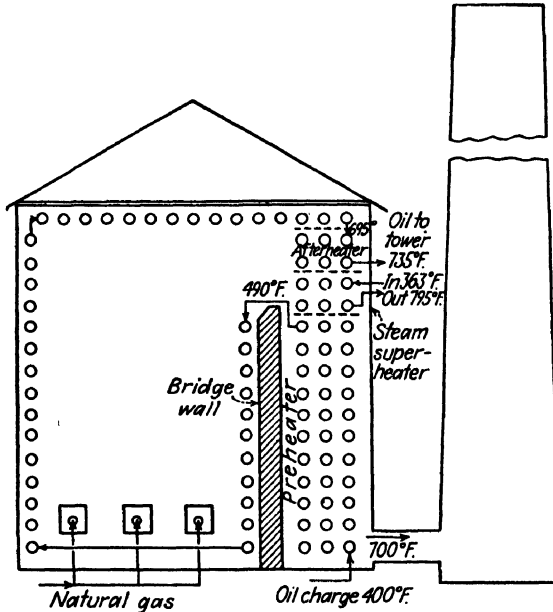

FIG. 21.—Flow and temperature diagram.

Constructional data furnished by the company's engineering department are as follows:

Radiant Section:

	<i>Cu Ft</i>
Volume of firebox to bridge wall.....	11,228
Volume above bridge wall.....	1,152
Total radiant section.....	12,380

Minimum free area for gas flow through convection bank = 61.4 sq ft.

Tube Data:

	No. in series	No. in parallel	Total
Bridge wall.....	8	2	16
Front wall.....	11	2	22
Roof.....	11	2	22
Afterheater.....	4	6	24
Preheater.....	48	2	96
Steam superheater.....	6	2	12

All tubes are 5.0 in. o.d. by 30 ft. Effective heating surface = 37.6 sq ft outside area per tube. (Ends of tubes in header compartments not heated.)

Operating Data:

Oil charge rate = 435 bbl/hr at 86°F

Steam rate = 3,666 lb/hr

Fuel gas rate = 53,400 cu ft/hr at 60°F and 1 atm

STREAM TEMPERATURES AND PRESSURES (AVERAGE)

	Press, psig	Temp, °F
Preheater inlet.....	225	400
Preheater outlet.....	185	490
Bridge wall outlet.....	170	
Roof tube outlet.....	110	695
Afterheater outlet.....	20	735
Superheater inlet.....	146	
Superheater outlet.....	56.4	795

GAS TEMPERATURES (Av), °F

Combustion air.....	95.5
At bridge wall.....	1485
At base of stack.....	700

ORSAT ANALYSIS (Av), %

CO₂ = 7.2, O₂ = 8.0, CO = 0.0

FUEL GAS ANALYSIS (COMPANY LABORATORY)

	%
Methane.....	98
Ethane.....	0.65
Propane.....	0.5
Butane.....	0.6

Gross heating value = 1035 Btu/cu ft, 60°F

Net heating value (calc) = 935 Btu/cu ft, 60°F

Charge: Rodessa Crude Oil 45.5°API

The company laboratory furnished the ASTM distillation and distillate-gravity data. From these, the UOP *K* value for the crude was 12.25. The slope of the ASTM distillation curve was 7.3, the slope of the equilibrium flash curve was estimated at 5.3 with the intersection of flash and ASTM curves at 400°F and 33 per cent off.⁹

The pressure-temperature relation was estimated by drawing a line through 400°F and 1 atm on the hydrocarbon vapor-pressure chart. Flash vaporization curves for higher pressures were constructed by reading off temperatures at selected pressures from the synthetic vapor-pressure curve, locating these temperatures at 33 per cent off and drawing parallel straight lines through them; all with the slope 5.3°F per cent. These data and results are presented as the curves on Fig. 22.

⁹ See pp. 1399-1401 of Supplementary Reference 1.

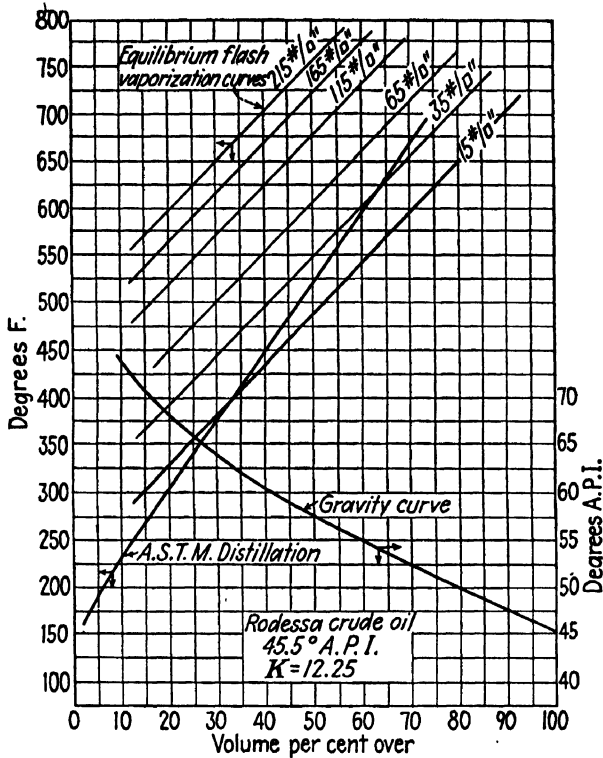

FIG. 22.

Calculation of Heat Balance

Datum temp = 60°F for air, fuel, and flue gases.

Fuel Gas (basis, 1 hr. Neglect sensible heat):

Net heat of combustion = (53,400)(935) = 49.9 million Btu

$$\text{Rate} = \left(\frac{53,400}{357}\right) \left(\frac{492}{520}\right) = 141.6 \text{ lb mols}$$

$$\text{Mols carbon} = \left(\frac{141.6}{100}\right) [98 + 2(0.65) + 3(0.5) + 4(0.6)] = 146$$

$$\text{Mols hydrogen (H}_2\text{)} = \left(\frac{141.6}{100}\right) [2(98) + 3(0.65) + 4(0.5) + 5(0.6)] = 287$$

Flue Gas (basis, 1 hr):

$$\text{Rate (carbon balance)} = (146) \left(\frac{100}{7.2}\right) = 2030 \text{ mols dry flue gas}$$

$$\text{Excess oxygen} = (2030) \left(\frac{8.0}{100}\right) = 162 \text{ mols}$$

$$\text{Nitrogen} = \frac{(2030)(100 - 7.2 - 8.0)}{100} = 1720 \text{ mols}$$

$$\text{Excess air} = \frac{(100)(8.0)}{(100 - 8.0 - 7.2)(20.9/79.1) - 8.0} = 55.5\%$$

Sensible heat in flue gas at 700°F,

	Mols	(<i>MCp</i>) _{av}	Btu per degree
CO ₂	146	10.3	1,503
O ₂	162	7.3	1,182
N ₂	1,720	7.1	12,220
H ₂ O.....	287	8.3	2,380
Total.....	17,285

$$\text{Heat loss in flue gases} = (17,285)(700 - 60) = 11.1 \text{ million Btu}$$

Air (basis, 1 hr):

$$MCp = 7.0 \text{ Btu/lb mol. Temp} = 95.5^\circ\text{F}$$

$$\text{Heat entering} = \left(\frac{1720}{0.791}\right) (7.0)(95.5 - 60) = 540,000 \text{ Btu}$$

Steam Superheater (basis, 1 hr):

$$\text{Outlet: } 71.1 \text{ psia } 795^\circ\text{F, } q = 1427.5 \text{ Btu/lb}$$

$$\text{Inlet: } 160.7 \text{ psia sat, } q = 1195$$

$$\qquad\qquad\qquad 232.5$$

$$\text{Heat added} = (3666)(232.5) = 852,000 \text{ Btu}$$

Heat Absorbed by Oil:

The gravity of 45.5° API corresponds to 6.656 lb/gal at 60°, and the multiplier for reducing the volume from the flow temperature of 86°F, is 0.9871.

The weight rate of the oil stream is

$$(435)(42)(6.656)(0.9871) = 120,300 \text{ lb/hr}$$

Referring to Fig. 22, it is apparent that the charge is entirely liquid as it enters the preheater and that vaporization is negligible in the preheater bank but must be accounted for thereafter. The procedure will be to calculate the total heat absorbed by the oil from 32°F to its condition at given points in the furnace.

The recommended method for calculating the heat content of oil which is partly vaporized is first to determine the fraction vaporized, the properties of this vapor (including its average boiling point), and the properties of the residue liquid. The heat content is then the sum of the following five items:¹⁰

- a. The sensible heat of the charge liquid from 32°F to the average boiling point of the vapor at 1 atm.
- b. The heat of vaporization of the vaporized portion (at its average boiling point at 1 atm).
- c. A correction due to elevated pressure (which is here applied to the heat of vaporization).
- d. The sensible heat of the vapor from its average boiling point to the outlet temperature.
- e. The sensible heat of the liquid residue from the same average boiling point to the outlet temperature.

¹⁰ See pp. 1346-1353 of Supplementary Reference 1.

The experimental temperatures and pressures enable the heat content of the oil stream to be calculated at the furnace inlet, the preheater outlet, the roof tube outlet, and the afterheater outlet. By means of Fig. 22 with the correlations developed earlier and others for specific heat and pressure correction for vapors,¹⁰ Table A was prepared.

TABLE A

	Tube banks		
	Preheater	Wall and roof	Afterheater
Outlet temp, °F.....	490	695	735
Outlet press, psia.....	199.7	124.7	34.7
Vapor:			
Vol % at outlet (Fig. 22).....	0	52	84
°API (Fig. 22).....		57	49
Wt % at outlet.....		48.9	82.4
Av bp °F (1 atm).....		320	415
<i>L</i> , at av bp (Btu/lb).....		117	106
Press corr (Btu/lb).....		17	3
<i>C_p</i> , av bp to outlet temp.....		0.625	0.655
Crude oil:	0.57 (to 400°)		
<i>C_p</i> , 32° to av bp.....	0.595 (to 490°)	0.545	0.57
Liquid residue:			
Wt % at outlet.....	100	51.1	17.6
°API (weight bal).....	45.5	34.8	30.7
<i>C_p</i> , av bp to outlet temp.....		0.735	0.76

From the data in Table A, heat quantities are calculated:

At preheater inlet (400°):	<i>Btu per Lb Crude</i>
(0.57)(400 - 32).....	210
At preheater outlet (490°):	
(0.595)(490 - 32).....	273
At av bp of vapor from wall and roof banks (320°):	
Total liquid, (0.545)(320 - 32).....	157
Vaporization, (0.489)(117 - 17).....	49
Sensible heat from 320 to 695°:	
Vapor, (0.489)(0.625)(695 - 320).....	115
Residue, (0.511)(0.735)(695 - 320).....	137
At av bp of vapor from afterheater (415°):	
Total liquid, (0.57)(415 - 32).....	218
Vaporization, (0.824)(106 - 3).....	84.5
Sensible heat from 415 to 735°:	
Vapor (0.824)(0.655)(735 - 415).....	173
Residue (0.176)(0.76)(735 - 415).....	43

The heat *inputs* to the various sections are

	Btu per lb	%
Preheater, 273 - 210.....	63	20.4
Wall and roof tubes: 157 + 49 + 115 + 137 - 273.....	185	60.0
Afterheater: 218 + 84.5 + 173 + 43 - 273 - 185.....	60.5	19.6
Total.....	308.5	100.0

Total heat to oil = (120,300)(308.5) = 37.1 million Btu/hr.

SUMMARY

	Heat in		Heat out	
	10 ⁶ Btu per hr	%	10 ⁶ Btu per hr	%
Combustion air.....	0.54	1.1		
Fuel gas (net hv).....	49.9	98.9		
Net to steam.....			0.85	1.7
Net to oil.....			37.1	73.5
Flue gas.....			11.1	22.0
Unaccounted for.....			1.39	2.8
Total.....	50.44	100.0	50.44	100.0

Furnace efficiency = 73.5 + 1.7 = 75.2 per cent

Supplementary References

1. PERRY, J. H.: "Chemical Engineers' Handbook," pp. 2434-2445, 2d ed., McGraw-Hill Book Company, Inc., New York, 1941.
2. KENT, R. T., "Mechanical Engineers' Handbook," Vol. II, Sec. 6, John Wiley & Sons, Inc., New York.
3. NELSON, W. L.: "Petroleum Refinery Engineering," 2d ed., Chap. XXII, McGraw-Hill Book Company, Inc., New York, 1941.

Exercises

1. The following data were obtained from a test of a stoker-fired boiler burning lignite screenings. The boiler is of the bent water-tube type, rated at 420 hp, and having no preheater, superheater, or economizer.

Constructional:

Grate: 9 ft × 9 ft 7 in.

Firebox volume: 1,220 cu ft

Total heating surface: 4,200 sq ft

Fuel:

Ultimate analysis: C = 71.3; H = 5.15; N = 1.3; O = 14.6; S = 0.45; A = 7.2 per cent

Moisture (as fired) = 24.08 per cent

Gross Btu (as fired) = 9463
 Combustible in dry refuse = 1.6 per cent
 Firing rate = 3,825 lb/hr

Flue Gas, Air, and Steam:

Orsat: CO₂ = 14.2, O₂ = 4.9, CO = 0.0
 Flue temperature = 486°F
 Combustion air temperature = 80°F (substantially dry)
 Feedwater temperature = 116°F
 Feedwater rate = 25,170 lb/hr
 Steam press = 233 psig (substantially dry and saturated)

Make a heat balance based on the gross heat of combustion of the lignite, giving the following results: per cent of excess air, per cent of total heat absorbed by boiler, net sensible heat loss in dry flue gas, heat loss due to water vapor from hydrogen plus moisture in fuel (take latent heat as 1050 Btu/lb H₂O), loss due to unburned combustible, and balance radiation and unaccounted for.

2. For the data and results of Exercise 1, calculate

- a. Fuel rate, as pounds per hour per square foot of grate area.
- b. Heat release, as Btu per hour per cubic foot of firebox volume.
- c. Equivalent evaporation, from and at 212°F per hour.
- d. Equivalent evaporation, per square foot of water heating surface per hour.
- e. Per cent of boiler rating developed.
- f. Pounds of equivalent evaporation per pound of fuel fired.
- g. Pounds of actual evaporation per pound of fuel fired.

3. The radiant section or combustion chamber of a small cracking furnace contains 12 wall tubes and 10 roof tubes, all placed in single rows near the refractory walls. The tubes are 18 ft long, and 4½ in. o.d. The furnace is charging 110 bbl/hr of fresh and recycle cracking stock, which enters the radiant section from the convection bank at a temperature of 580°F and discharges at cracking temperature into the soaking chamber. Fuel oil is being fired at the rate of 165 gal/hr. Forty per cent excess air is used. The air is not preheated and no flue gas is recirculated. Combustion is complete. Using the data below, calculate

- a. The per cent of the heat in the fuel absorbed by the charging stock.
- b. The outlet temperature, by means of Eq. (2).
- c. This furnace has given trouble with overheating of the tubes and short tube life. Could this be anticipated from the operating data? Explain.

Charging stock: gravity = 30°API. $C_p = 0.84$ (av)

Fuel oil: gravity = 14°API

Hydrogen content = 11.2 per cent

4. Referring to the pipestill furnace illustration, calculate

- a. The heat release in the radiant section.
- b. The heat-transfer duties in the radiant section, afterheater, and preheater banks, as Btu per square foot of effective surface per hour.
- c. The convection coefficient (h_c) for the preheater bank using Eq. (1). (Estimate the temperature at the top of the bank by assuming a proportional gas temperature change with heat removal, for all banks in the convection section.)
- d. The radiation coefficient (h_r) for the preheater, from the relation

$$q = (h_c + h_r)A(\Delta t)_{av}$$

with h_c from part (c).

CHAPTER XVI

PROCESS FURNACES AND KILNS

The basic features of most processing furnaces have been used for 50 to 100 years. Any truly original design was at first troublesome and not very successful in operation. Efforts to improve upon the worst faults of a furnace when later units were built have slowly but steadily evolved economical equipment of proved and dependable performance.

In this chapter, a primary classification of process furnaces is made by their shape and form rather than according to their individual applications. This treatment better illustrates the essential features. On the whole, there is no clear distinction between furnaces and kilns. Ceramic and a few inorganic industries use the term *kiln*, whereas *furnace* is preferred by metallurgical and other industries.

Temperature and Heat Input. Second only to application, operating temperature has the greatest influence upon design. A partial list of furnace temperatures for various operations is given in Table 1.

TABLE 1.—APPROXIMATE FURNACE TEMPERATURES

<i>Process</i>	<i>Max Stock Temp, °F</i>
Drying oven.....	300
Japanning oven.....	450
Soft metal annealing.....	700-900
Steel annealing and carburizing.....	1550-1800
Vitreous enameling.....	1600-1800
Lime kiln.....	2100
Lead smelter.....	2200
Glass furnace.....	2400
Cement kiln.....	2600-2800
Copper smelter.....	2800
Open-hearth steel furnace.....	2900
Blast furnace (iron).....	2100-3300

Allowable heat releases in various types of furnaces fall in the same general order as their operating temperatures. Capacity, heat input, and temperature are collectively limited by the sensitivity of the stock or charge to damage from surface overheating and interior temperature gradients. Trinks¹ gives approximate figures for temperature differences between the stock or charge and the furnace gases. These differentials increase with temperature level and with rate of heating.

¹ See Vol. I, p. 2, of the Supplementary Reference.

Heat Economy. High heat efficiency is not readily obtainable from the heating and cooling *cycles* of batch furnaces. Neither is it practicable to attempt efficient heat recovery from low-temperature gases. Process furnaces as a rule show only 5 to 40 per cent heat efficiency, 1 to 10 million Btu being required to process a ton of material in reheating, heat-treating, ceramic burning, and enameling operations.

MUFFLES

The following *special requirements* are met by the use of muffle furnaces: (1) the material must be heated in a controlled atmosphere, (2) the stock would be contaminated or injured by contact with combustion gases, or (3) a gaseous product is formed.

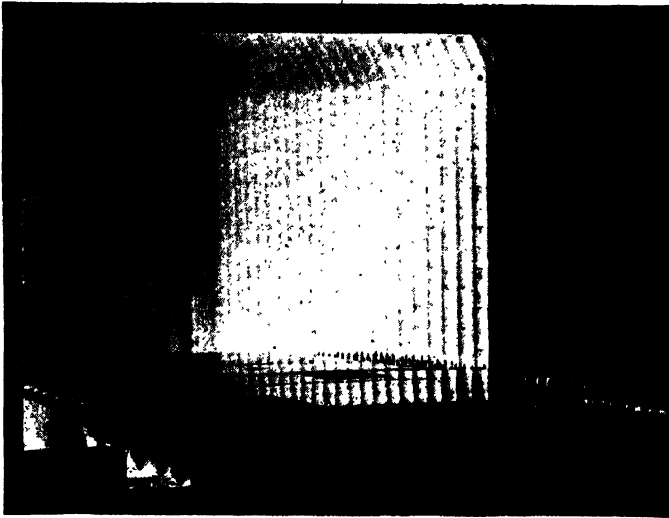

FIG. 1.—Large muffle furnace, burning flat enameled sheets. (Courtesy of The Carborundum Company.)

The muffle itself is frequently constructed of silicon carbide since this refractory has a much higher thermal conductivity than any other and withstands the highest temperatures encountered. Gas firing is probably the most common, but many of the smaller units are electrically heated.

Figure 1 shows a large muffle "burning" enameled steel sheetware at a temperature of 1650°F, and operating on the comparatively short time schedule of about 5 min per batch. It is also used for enameling a variety of sheet-steel products such as buckets, tubs, and stove parts. The walls and roof are of hollow silicon carbide muffle tile, heated with gas burned within the vertical ducts or flues formed by the tile.

To utilize fully the space in a muffle and minimize the time of loading and unloading, the stock may be stacked upon the open shelves of a *kiln car*, which is then wheeled into the chamber. With two cars available, one is cooled, unloaded, and reloaded while the other is inside the furnace.

Special Types. The indirect-heating feature of the muffle has been applied to other types of furnaces. The vertical "retort" usually consists of steel or silicon carbide tubes or ducts containing the stock and heated from the outside. This arrangement permits close temperature control and a semicontinuous operation; the stock is fed in at the top and the product is withdrawn from the bottom in small batches at regular intervals. Vertical retorts are used to make and revivify bone char, to reduce zinc ore, and to produce carbon dioxide gas by burning limestone. Byproduct coke ovens and coal-gas retorts fall within this general class, and there may be other applications. A muffled multiple-hearth type of furnace constructed of silicon carbide is also available.

CONTINUOUS TUNNEL TYPES

A continuous furnace is fired steadily while the stock moves through it. The *heating and cooling periods* required by batch furnaces are replaced by *preheating and cooling zones*. The steady firing enables increased throughput, much lower handling costs, and vastly better heat economy, giving much lower costs of production.

A *tunnel kiln* is constructed in the shape of a long duct through which the stock moves at a uniform speed. Large units embody several zones such as *preheating, heating, or soaking*, and sometimes *cooling*. Burners mounted along the sides control heat inputs to and temperatures in these zones. Movement of air and gases is regulated by fan arrangements. Partial countercurrent flow between stock and combustion gases is often employed to good advantage.

Reheating Furnaces. For hot working of metals such as rolling, stamping, and forging operations, the metal billets or blooms must be preheated to some definite temperature, between 1500 and 1800°F in the case of steel. Figure 2 shows a furnace designed for this purpose. The stock rests upon a track or skid consisting of parallel water-cooled steel tubes. A cold billet is periodically pushed into the preheating end, which moves the entire line of stock and forces a hot billet out of the opposite end. The usual capacity range of steel reheating furnaces is 35 to 100 lb of steel per square foot of hearth or floor area per hour. Certain forging furnaces may operate at considerably higher rates when handling soft steel.

Ceramic Kilns. The manufacture of ceramic products requires one to four furnacing operations. Only a single operation is needed for

coarse products such as plain brick and tile, but fine pottery and china-ware require separate operations for drying, firing, decorating, and glazing. The main firing operation (*bisque firing* in the latter case) takes 72 hr or longer, during which a maximum stock temperature of about 2250°F is attained. This was formerly done in cylindrical periodic (batch) kilns that were loaded, fired, cooled, then unloaded. The loading and unloading required a day each; heating, firing, and cooling in the kiln required about six days, giving a total schedule of about eight days. The continuous kiln shown in Fig. 3 and a shorter glost (glazing) kiln replaced eight periodic kilns, giving very much lower costs for heat, handling, and kiln maintenance.²

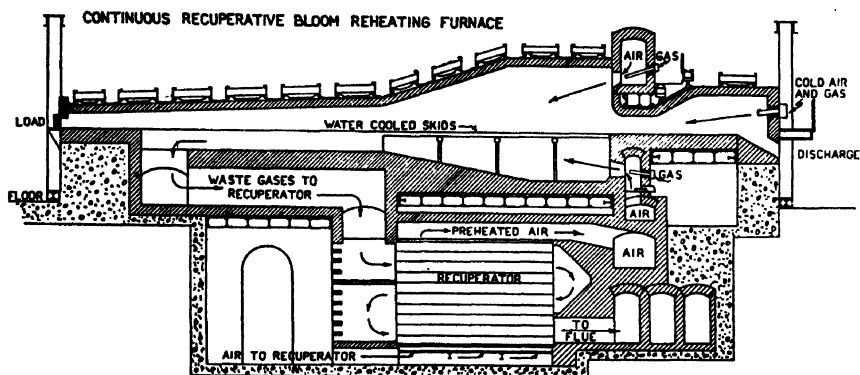

FIG. 2. (Courtesy of American Gas Association.)

Referring to the kiln of Fig. 3, oven-dried ware is carefully packed and loaded onto cars, one of which enters every 160 min. The kiln contains 27 cars. These move successively through preheating, firing, and cooling sections. The car trucks are kept cool (below 500°F) by a circulation of air in the passage below the sand seal. Air for cooling the stock is blown into the combustion space immediately outside the muffle and travels countercurrent to the cars. In this installation, the air may or may not be mixed with the combustion gases from the firing section. When the air has reached the heating section, it is quite hot and serves to preheat the stock.

Smaller ceramic kilns for specialty products are sometimes built in *ring* or *circular* form, having a continuously moving flat ring platform upon which the ware is placed. The kiln hood covers only part of the circular platform, so that green ware may be placed upon and burned ware removed from the platform at the uncovered section. For continuous uninterrupted movement of the ring platform, the ends of the kiln hood must be left open. This is not a very satisfactory arrange-

² OLIVE, T. R., *Chem. & Met. Eng.*, **44**, 412 (1937).

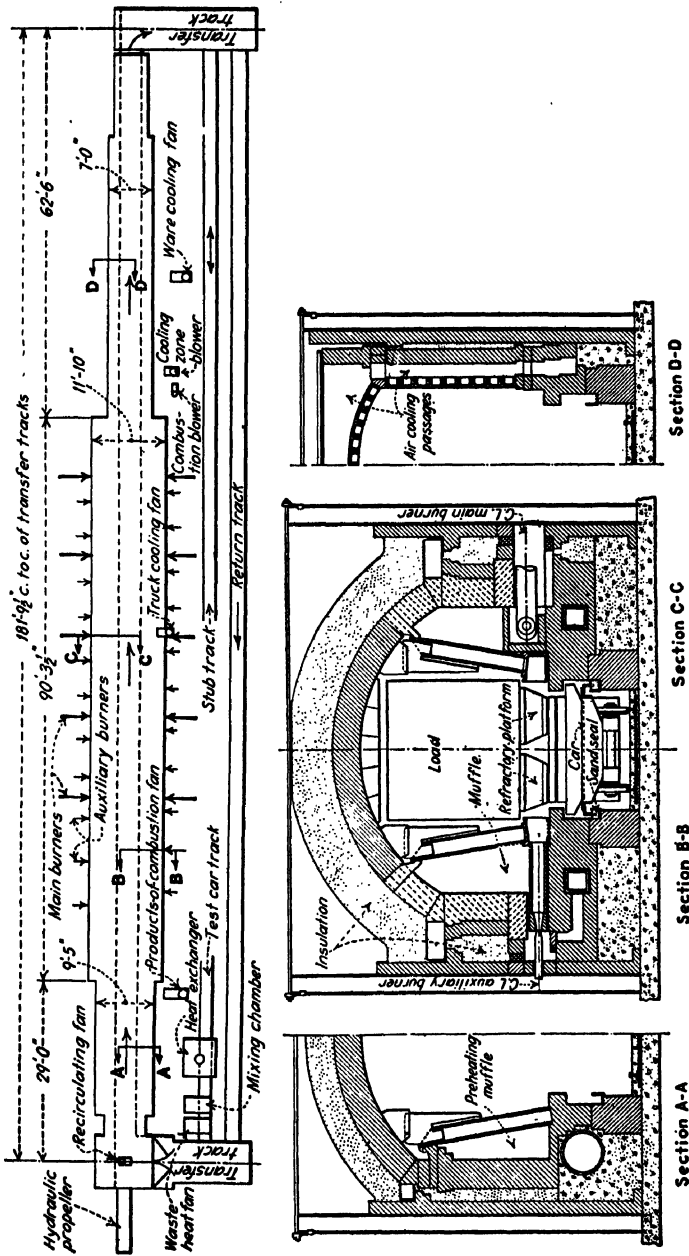

FIG. 3.—Above, plan of bisque kiln. Below, typical kiln sections: preheating section (A-A); firing section through auxiliary burner (B-B); firing section through main burner (C-C); cooling section (D-D). (Courtesy of *Chemical & Metallurgical Engineering*.)

ment, since positive control of gas flow and kiln temperature is then unobtainable.

BATCH MELTING FURNACES

Pot and Crucible Types. Small batches of metals are conveniently melted in a pot or crucible furnace. Iron or steel pots are often satisfactory for nonferrous metals melting below 1200°F. Higher melting metals require refractory crucibles of fireclay, Alundum (alumina), or

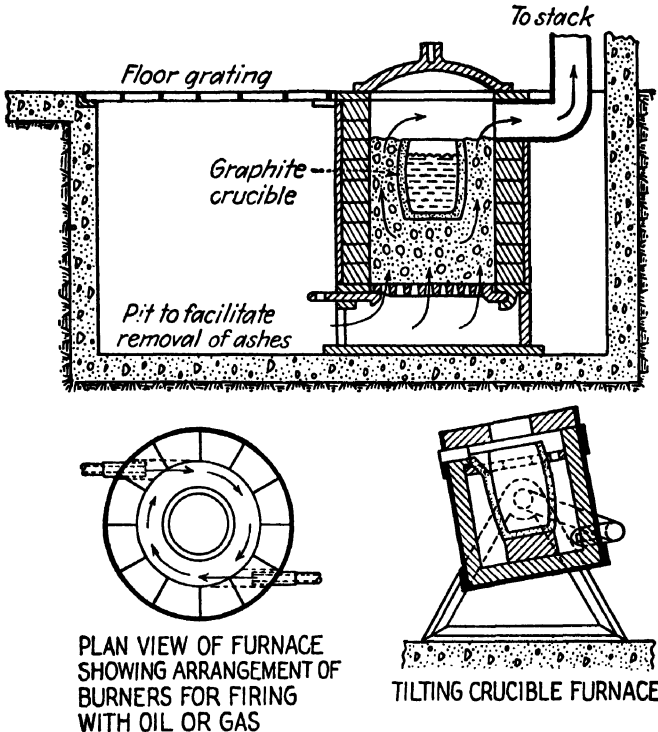

FIG. 4.—Some crucible furnaces. (Courtesy of W. L. Begeman.)

clay-graphite. Graphite crucibles are made in a wide range of sizes, the largest holding more than 1,000 lb of metal. Refractory crucibles are easily damaged or broken and, where they can be used, the more durable iron pots may of course be made much larger. Two to three batches may be melted during an 8-hr shift. The furnaces are of relatively simple construction (Fig. 4).

Tilting and Rotating Types. There are several advantages to mounting a furnace so that it can be tilted or rotated. Movement of the furnace agitates and mixes the charge. A simpler refractory construction is also possible since the melt can be poured from a spout rather than

having to be tapped from the bottom. Tilting furnaces are built in both direct and indirect (crucible) types, but rotating furnaces are direct-heated in most cases. A significant feature of a rotating furnace is that

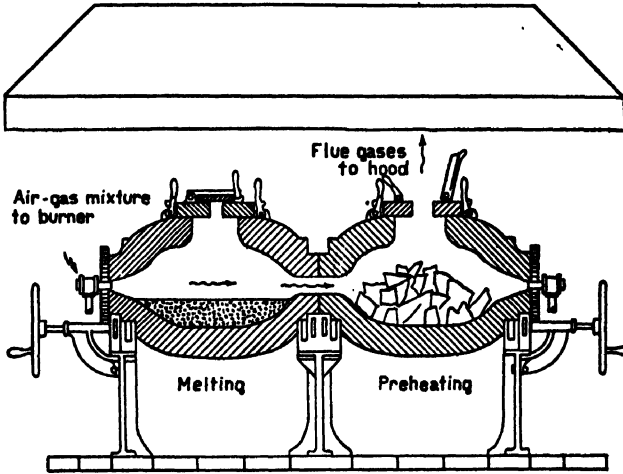

FIG. 5.—Double-chamber tilting metal-melting furnace. (Courtesy of American Gas Association.)

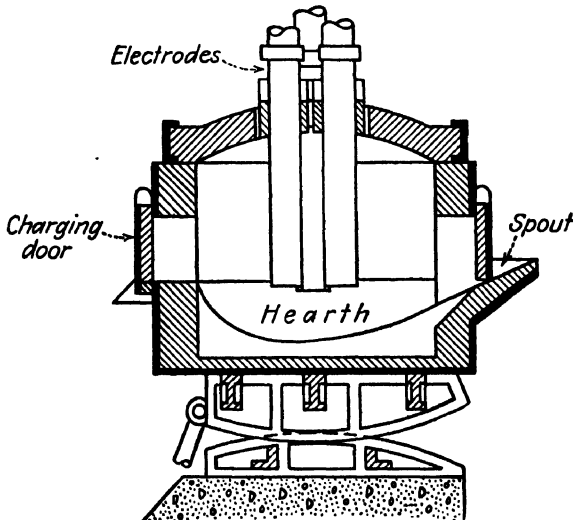

FIG. 6.—Direct-arc type of electric furnace. (Courtesy of W. L. Begeman.)

the heat absorbed by the refractory in the upper exposed position is transferred to the charge as it dips below the stock level. Figure 5 shows a twin or double-chamber rotating furnace. Considerable saving of fuel is effected by using the hot gases from one unit to preheat cold stock in the other. A charge of metal is melted in about an hour.

An electric-arc furnace such as shown in Fig. 6 will produce the highest temperature needed for any purpose and also permits an inert atmosphere to be maintained. However, gas or oil heat is more economical when atmospheres of flue gas are satisfactory.

VERTICAL AND SHAFT TYPES

Vertical or *shaft* furnaces are used to handle large quantities of a product that need not be very pure or highly refined, since there is direct contact between the fire and the material processed. Accurate temperature control is not obtainable. Shaft furnaces have been superseded by specialized types for a number of applications, but the former are more economical where they can be used. Shaft furnaces are relatively low in initial cost and permit high heat inputs.

Cement kilns were originally of the periodic type. These were later displaced by continuous shaft kilns, but in modern quantity production practice, cement is burned in the horizontal rotary kilns described later. Lime is burned in shaft kilns, but new installations are usually of the horizontal rotary type.

Blast Furnace. A blast furnace is a continuous, vertical smelter, that may roast, reduce, and melt all in the one unit. Its major application is in smelting iron ore to produce pig iron. A unit for this service is shown in Fig. 7. A conventional size blast furnace is about 20 ft in diameter and 90 ft high and charges 1,200 tons of iron ore, 600 tons of coke, and 250 tons of limestone to produce 600 tons of pig iron per day. The coke is both fuel and reducing agent and must pass specifications for purity, lump size, and strength. It supports the entire charge, maintaining it as a loose or unconsolidated aggregate so that the gases readily pass through the mass until ore reduction is complete and the "sponge iron" of the initial reduction is finally melted in the *bosh* or lower section. Preheated air at about 1250°F from the *stoves* (regenerators) is distributed through the circular *bustle pipe* and blown in through the *tuyères* under about 15 lb pressure. The gas attains a maximum temperature of approximately 3100°F a short distance in front of the *tuyères* and is cooled by countercurrent heating of the charge until its final temperature is about 500°F at the entrance to the *downcomer pipe* connection at the top. Blast furnace gas contains about 25 per cent CO. Roughly a third of it is burned in the *stoves*, of which there are four, three heating while the fourth is cooling by preheating the air supply. The rest of the gas is scrubbed of dust and used as open-hearth and boiler fuel in the plant, or as gas-engine fuel to compress the blast-furnace air and to generate electric power.

Blast-furnace refractory lining must resist mechanical abrasion by the charge, fluxing at the temperatures encountered, and the effects of a

strongly reducing atmosphere. Dense-burned fireclay is used, with superduty grade in the bosh and hearth sections. Appreciable heat loss by conduction through the wall occurs, but this is necessary in order that the lining remain sufficiently cool to have long life. The *inwall* or middle section is cooled by water sprayed on the outside of the steel shell. Cooler plates are built into the bosh section to avoid dangerously high brick temperatures there.

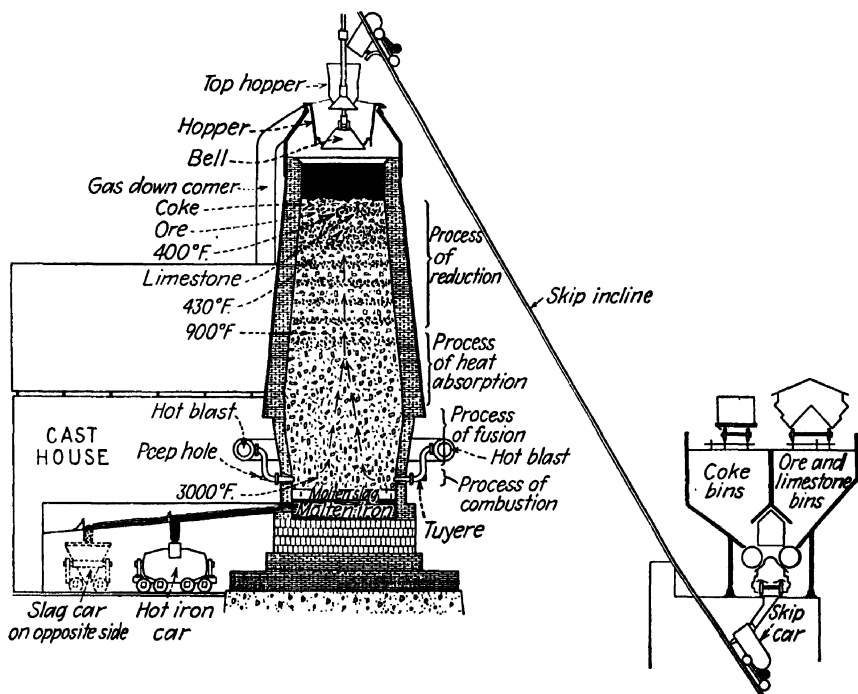
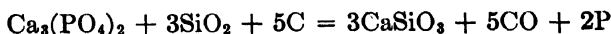

FIG. 7.—Diagrammatic sectional view of a blast furnace. (Courtesy of Bethlehem Steel Company.)

A blast furnace of similar construction is used to manufacture phosphorus and phosphoric acid by the reaction between phosphate rock, coke, and sand. The reactions may be summarized by the equation:



The blast-furnace gas in this case contains the phosphorus as vapor. The gas is burned in the same type of regenerative stoves, the resulting P_2O_5 being later hydrated in gas suspension to phosphoric acid. A portion of the hot gas may be cooled *before burning* to produce elementary phosphorus in any desired quantity.³

³ *Chem. & Met. Eng.*, **46**, 269 (1939).

Small blast furnaces of square cross section have been used to smelt copper and lead ores, but these have been largely supplanted by the multiple-hearth roasters described later.

Cupola. Metal for pouring gray iron castings is usually melted in a *cupola*. The essential features of its construction are shown in Fig. 8.

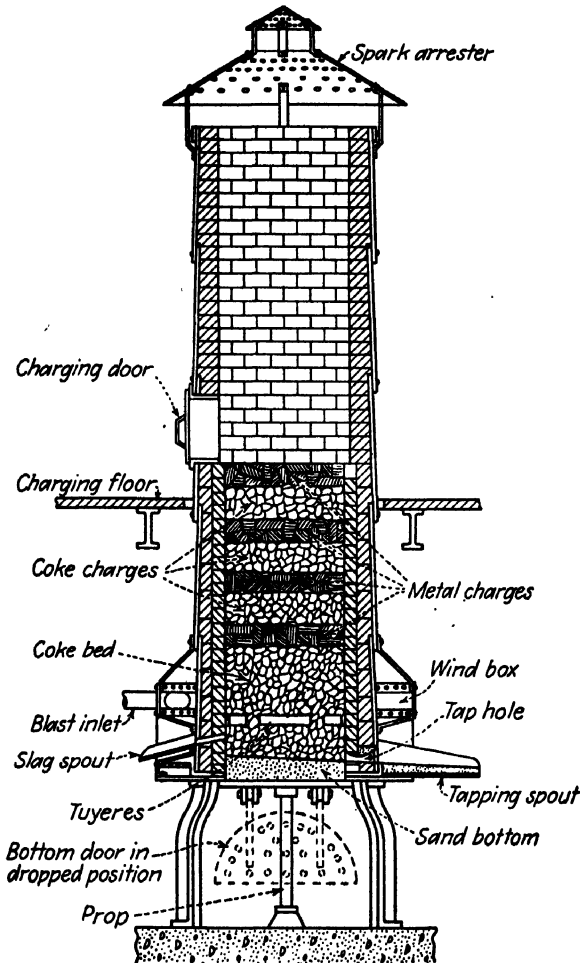

FIG. 8.—Cupola furnace, used for melting cast iron. (Courtesy of W. L. Begeman.)

The body consists of a vertical steel shell lined with firebrick and is equipped with hinged bottom plates, slag and metal tapping spouts, wind box, or "belt," and charging door. The *bottom* or hearth is formed by a layer of molding sand 6 to 9 in. thick. The section immediately above the bottom and below the tuyères which collects the molten metal and slag is called the *crucible* and is about 20 in. deep. The *effective*

height is the distance from the top of the *tuyères* to the sill of the *charging door* and varies from about 12 ft for a 36 in. i.d. unit up to 18 ft for larger units. The cross-sectional area determines the melting capacity. The smallest units are about 16 in. in diameter and will melt about $\frac{1}{2}$ ton/hr, whereas the largest units about 9 ft in diameter can handle 30 tons/hr.

A heat is started by building a coke fire about 3 ft deep, upon which are charged alternate layers of metal and mixed coke and flux. The usual charge consists of 6 in. layers of coke, 8 lb of metal per pound of coke, and $\frac{1}{5}$ lb of limestone and other flux per pound of coke.

Air is supplied to the wind belt at a pressure of 8 to 16 oz. The rectangular *tuyères* are 4 to 6 in. in size and have a combined area one-fourth to one-sixth that of the cupola cross section. Melting is very rapid while the blower is in operation, only about 5 min being required between charges. A heat may be continued for from 1 to 10 hr and is ended by tapping out all of the molten metal and slag, then dumping the fire by pulling out the bottom door support, and quenching the burning coke with a stream of water. Inspection and repair of the crucible section lining are made after each heat.

OPEN-HEARTH FURNACES

The *open-hearth type* of furnace has a comparatively shallow, basin-shaped refractory hearth to contain the molten charge.* Open-hearth furnaces are always direct-heated with the flame above the hearth. However, some furnaces are of the "split-flame" variety which are heated from both below and above the hearth.

As the roof has an important duty of reflecting and radiating heat from the flame and gases to the charge, it is constructed comparatively flat, with only a slight "rise." Units in which the whole roof is sloped down to form a restricted section or throat near the back of the hearth are designated as *reverberatory*. Open-hearth furnaces are widely used in both ferrous and nonferrous metallurgy and for glassmaking. Only the more common applications are discussed here.

Malleable Iron. One of the simpler open-hearth types is the "air" or "wind" furnace for making malleable iron (Fig. 9). It has a firebrick understructure, the hearth being covered with silica sand. The roof is built in narrow sections or "bungs," consisting of concave steel frames wide enough to accommodate about three courses of firebrick. The last brick to go into each course constitutes a wedge or key so that the assembly is actually a complete and portable section of a sprung arch. The bungs are set in place and lifted from the furnace by an

* The term *open-hearth* has heretofore been used to denote a type of steel-making furnace. As used in this chapter, the term refers only to the shape of the hearth and the manner of heating.

overhead crane. An opening is made for charging metal and flux by removing several bungs. After charging, the bungs are replaced and the fire started. At the proper times, the slag is skimmed from the melt, the iron analysis adjusted by throwing in coke, ferromanganese, and ferrosilicon through the skimming door and, when ready, the metal is tapped out through a spout.

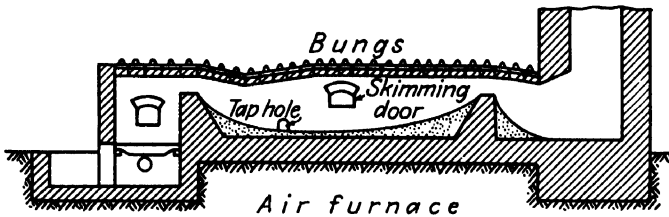

FIG. 9.—Diagrammatic sketch of air furnace. (Courtesy of W. L. Begeman.)

About 3 lb of metal are melted per pound of coal fired, and a typical furnace capacity is 20 tons of metal per heat. A heat requires about 5 hr. Any type of fuel can be used, but pulverized coal is probably the most common.

Steel. The open-hearth steel furnace is quite flexible in its operation. Its purpose is to make a medium to high grade of steel, and it may be charged with (1) molten iron from a blast furnace or bessemer converter or (2) cold steel scrap, iron ore, coke, and fluxes. It is thus adaptable to smelting, melting, and refining (Fig. 10.)

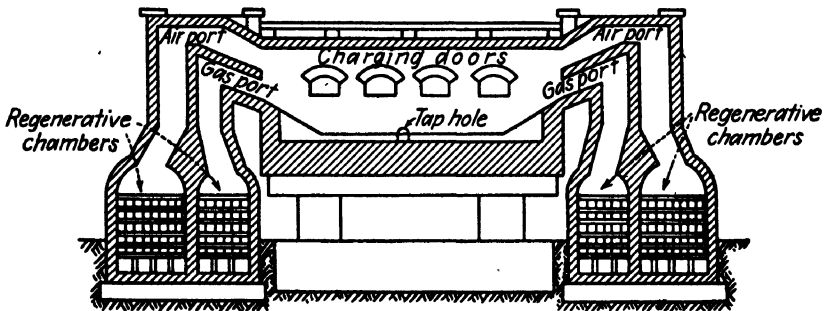

FIG. 10.—Diagram of open-hearth furnace. (Courtesy of W. L. Begeman.)

The fuel is oil, tar, natural gas, or producer gas. When firing with producer gas, both air and gas are preheated by a *regenerator system*. Duplicate checkerwork regenerator units are provided, one at each end. The chamber at each end has two compartments, one for preheating the air and a smaller one for preheating the fuel gas. The regenerator at one end is being heated by the flue gases while that at the other end is sepa-

rately preheating the streams of fuel and air. The flow is reversed at intervals of from 10 to 20 min.

The hearth is prepared by first lining it with grain magnesite or dolomite refractory, then covering with ground slag. The latter fuses and provides an impervious surface to hold the molten steel. Hearth dimensions are customarily about 15 by 40 ft with the front of the furnace along the wide side and the regenerators connected to air and gas ports (which also serve as flues) at the ends. The ports consist of straight, flat ducts with the gas port underneath. This construction gives a long "diffusion flame." Combustion occurs slowly and evenly across and near the surface of the melt, *radiating* most of the heat directly from the gases to the molten surface below.

Hearth depth is about 20 in., and this dimension determines furnace holding capacity—usually between 50 and 300 tons of steel. A heat starting with the cold charge of (2) requires 8 hr or longer, but less than half of this time is required to refine a pour of molten iron as of (1).

Although the slag floats on top of and thermally insulates the melt from the furnace gases, it is indispensable as a refining agent. The impurities and dissolved oxygen (as FeO) tend to approach equilibrium concentrations in each phase, with most of the oxide dissolving in the slag. A very pure iron is manufactured by a double open-hearth process in which the metal is finally soaked in contact with a second and fresh slag of a different composition.

Refining of molten blast-furnace or bessemer iron in an open hearth is known as the *Duplex process*, while *Triplex processes* consist of these operations followed by a third refining step in either an electric furnace or another open-hearth process.⁴

Glass. Glass was formerly made batchwise in fireclay pots, a number of which were set in a furnace. Although this type of manufacture is still in use for optical and special glasses, large tonnages of the more common grades are made in continuous "tank" furnaces.

A typical tank furnace of 40 tons daily capacity has a hearth or melting chamber 16 by 20 ft in size. The depth depends upon the time to be allowed for thoroughness of mixing and for gas bubbles and scum to completely rise to the surface. The furnace is equipped with either recuperators or regenerators, the latter being similar to those of a steel furnace. A glassmaking furnace uses producer gas or natural gas if the latter is available. The charge is fed in small batches through traps or "dog houses" near one end. It melts and slowly flows toward the other end, the surface scum being held back by refractory "floaters."

⁴ For treatment of iron and steel furnaces in greater detail see Rosenholtz and Oesterle, "Elements of Ferrous Metallurgy," 2d ed., John Wiley & Sons, Inc., New York.

The clear melt is finally withdrawn to processing machinery. Some furnaces have separate "melting" and "working" compartments connected by a narrow duct.⁵

ROTARY KILNS

The rotary kiln is used for calcining large quantities of inorganic substances. The feed requires little or no size preparation and often includes a range of particle sizes from dust up to fairly large lumps. The principal applications of rotary kilns are

Burning lime and dolomite.

Making portland cement clinker.

Revivification of fuller's earth (in oil refining).

Sintering ore "fines" from blast-furnace flues.

Sintering flotation concentrates, such as manganese ore.

Calcining inorganic pigments: titania and lithopone.

Calcining alumina.

Calcining petroleum coke to a pure carbon.



FIG. 11.—Rotary cement kiln viewed from burner end. (Courtesy of Vulcan Iron Works.)

The kiln is a cylindrical steel shell lined with firebrick or other refractory and mounted with its axis at a slight slope from the horizontal (Fig. 11). The feed is introduced continuously into the breech or upper end. Rotation of the kiln causes the material to slide and roll along the

⁵ TRINKS, W., *Ind. Eng. Chem.*, **25**, 865 (1933).

inner wall, slowly advancing toward the lower or discharge end where it is removed. The kiln is direct-fired at the lower end by a long-flame burner mounted in the hood. The breech is connected to a flue to remove the gases. Thus the movements of stock and gases are countercurrent.

There are in general three zones in a rotary kiln:

1. A *drying zone* at the breech, where moisture is driven off. Loose, transverse chains are often provided in this section to aid in heat transfer and to keep the material from packing and clogging the kiln as it dries out.

2. The *heating zone*, which includes most of the kiln length.

3. The *burning zone*, where the maximum temperature is attained, is near the discharge end.

The product usually attains a red or white heat and must be cooled before storing or further processing. Some kilns contain an integral *recuperator section* at the discharge end that preheats the combustion air while cooling the product. Another arrangement is to discharge the hot product into a rotary cooler mounted below the kiln. In the latter case the product is cooled partly by combustion air drawn through the cooler (into the kiln) and partly by heat loss through the cooler shell. The cooler is usually lined with firebrick for a certain distance at the hot end.

Time of Passage. The capacity or throughput of a kiln depends upon the amount of material that the kiln contains at any moment and the time a given particle remains in the kiln. Studies on a number of materials in laboratory-scale kilns have been made and the useful relation developed to correlate time of detention or passage, with kiln construction and operating conditions:⁶

$$t = \frac{1.77(l)}{p d n} \sqrt{\theta} \times (\text{factor}) \quad (1)$$

where t = av time of material in kiln, min

l = length of kiln, ft

p = slope or pitch of kiln, degrees from horizontal

d = diameter of kiln (inside), ft

n = rpm

θ = angle of repose of material in dry condition, degrees

The *factor* is unity for a simple unobstructed kiln. However, a "fire ring" of sintered material may slowly build up near the hottest point in a kiln, which forms a partial obstruction. This ring retains a larger amount of material in back of it and increases the time of passage. Means of evaluating this "ring factor" are given.

⁶SULLIVAN, MAIER, and RALSTON, *U.S. Bur. Mines. Tech. Paper 384* (1927). BAYARD, R. A., *Chem. & Met. Eng.*, **52**, 100 (March, 1945).

The angle of repose (θ) is measured from the highest point on the wall reached by the material while the kiln rotates at slow speed. Angles of repose for materials having nonspherical particles range from 32.8 up to 55.6°. The value for lead shot was 24.4°. Particle size has little effect on angle of repose for materials smaller than 10 mesh but the angles increase with larger particle sizes.

The manner of movement of the material differs at low and at high rotational speeds. At low speeds it reaches the angle of repose, then suddenly slumps to a lower position where it remains at rest until the next slump occurs. At higher speeds there is continuous falling of material, and the angle of repose is not reached. Time of passage is substantially independent of feed rate.

The authors of Eq. (1) report satisfactory results in applying it to several commercial kilns.

Commercial Kilns. The ratio of kiln length to the square of the shell diameter is usually between 2 and 4. The pitch or slope of the shell as mounted is most often $\frac{1}{2}$ in./ft of length (2.39°). Rotational speeds are commonly 25 to 30 ft/min, measured at the shell periphery. Good heat economy requires a long kiln but, since structural considerations limit the ratio of length to diameter, small high-temperature rotary kilns cannot be made long enough to obtain high thermal efficiencies.

TABLE 2.—CAPACITIES OF ROTARY KILNS

$$\text{Tons product per day} = \frac{kLD^2}{100}$$

(Values of k)

Service	Production rates		
	Min	Av	Max
Lime.....	0.8	1.0	1.25
Dolomite.....	0.75	1.0	1.15
Alumina.....	1.0	1.1
Wet-process cement.....	1.2	1.4	1.9
Dry-process cement.....	1.6	1.9

1 bbl cement = 376 lb

Kiln sizes: 6 × 60 ft to 10 × 300 ft (shells)

Rotary coolers: 4 × 40 ft to 9 × 140 ft

The throughput of rotary kilns is proportional to the volume according to the relation⁷

$$\text{Tons product per day} = \frac{kLD^2}{100} \quad (2)$$

⁷ GIBBS, R., *Chem. & Met. Eng.*, **50**, 117 (August, 1943).

where k = a constant whose value depends upon the material processed and the air preheat temperature

L = kiln length, ft

D = kiln shell diam, ft

Values of k from data on 12 kilns are given in Table 2.

Low-temperature Equipment. *Rotary driers* are used in many applications. The working portion is a rotating steel shell similar to that of a rotary kiln, but a drier is usually much smaller. Since driers operate at much lower temperatures, no refractory lining is necessary. Both driers and rotary coolers are set at somewhat greater slopes and rotate faster than the kilns. It is customary to equip driers and coolers with axial ledges or "flights" on the interior wall. These "flights" pick up the material, then steadily spill it off as a "curtain" or thin sheet of falling particles while the drier rotates. This action gives thorough contact with the air or gas, which is desirable for rapid drying. Correlations of time of passage and of heat transfer in flighted equipment have been published.⁸

MULTIPLE-HEARTH FURNACES

The multiple-hearth furnace handles granular to fine sizes of material, giving a long, countercurrent path between gases and stock in a compact unit. Its construction permits of improved temperature control and operating flexibility as compared to a rotary kiln. Multiple-hearth furnaces are available in a wide range of capacities. Standard industrial sizes are from 6 to over 20 ft in diameter and contain 4 to 16 hearths with total hearth areas of from 70 to over 3,000 sq ft. A furnace 16 ft in diameter handles an average of about 50 tons per day, depending upon the material. Applications of the furnace include roasting of many sulphide ores; drying and calcining of such materials as lime, magnesite, sludges; the revivification of oil decolorizing earths; and incineration. In sulphuric acid plants, multiple-hearth furnaces may be used to burn spent oxide, pyrites, or other sulphur-bearing mineral as a source of SO_2 .

The description of multiple-hearth furnace construction and operation may be followed by referring to Fig. 12 of a zinc roaster.⁹ The furnace consists of a vertical steel shell in which the refractory hearths and lining are mounted. The hearths are of sprung construction with a slight rise to permit thermal expansion. Drop-holes for the ore are alternately at the center and periphery of adjacent hearths.

Movement of the ore across the hearth and into the drop-hole is accomplished by *rabble teeth* set at an angle in the *rabble arms* attached to the central rotating shaft. There are usually either two or four

⁸ PRUTTON, MILLER, SCHUETTE, and SMITH, *Trans. AICHE*, **38**, 123, 841 (1942).

⁹ Bulletin 206, Nichols Engineering and Research Co.

rabble arms for each hearth. The time a particle of ore remains on a hearth is controlled by the number of rabbles, angularity of the rabble teeth (which is adjustable), and shaft speed which may be varied from a fraction of one to several revolutions per minute.

The central shaft and rabble arms are of concentric double-duct construction and are kept cool by air blown into the central duct of the shaft

at the bottom. The air then flows into the rabble arms, back into the annular space, and out at one end of the shaft. The air often acquires a temperature of 400 or 500°F and may be utilized as preheated combustion air.

Burners may be mounted at any hearth, so that the furnace can be zoned into preheating, roasting or burning, and cooling sections as desired. The ore is fed by a machine. The unit shown has a *dry hearth* on top which eliminates moisture while warming the ore slightly. The feed opening of the top hearth is usually equipped with a seal to prevent escape of gases or the inflow of air.

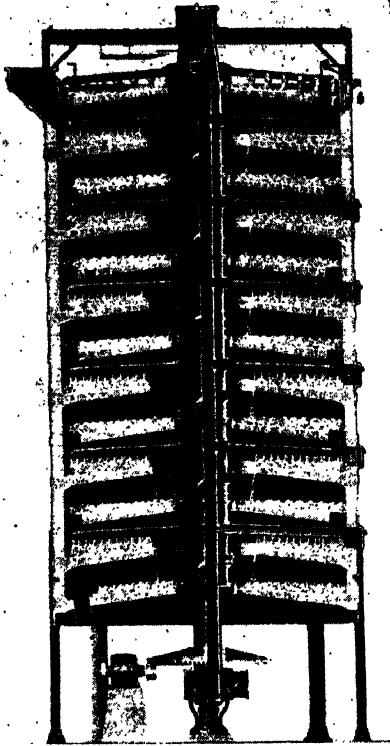

FIG. 12.—Multiple-hearth furnace or roaster. (Courtesy of Nichols Engineering Company.)

out satisfactorily, but the ash is strictly a waste material. Dust often causes trouble both within heating apparatus and as a nuisance when sent out the stack. A type of equipment designed to handle fine combustible material such as iron sulfide is illustrated in Fig. 13.

The operation is as follows: The raw material is fed into an air-swept ball-mill type of pulverizer by a variable-rate feeder mechanism. A current of air from the fan picks up the fines and carries them into the combustion chamber where they burn. The tangential gas takeoff duct from the combustion chamber promotes a swirling motion of the gas, and the larger particles of cinder or calcine settle out in this chamber.

FLASH ROASTER

Finely divided solids are difficult to handle and give generally unsatisfactory operation in most of the furnaces described in this chapter. The burning of pulverized coal and disposal of its ash have been worked

The hot gases are next cooled in the waste-heat boiler, where a further settling of dust occurs. The cooled gas is scrubbed free of dust and sent to the SO_2 recovery system. Part of the gases from the waste-heat boiler may be recirculated into the combustion chamber to prevent excessive temperatures and to steady the operation.

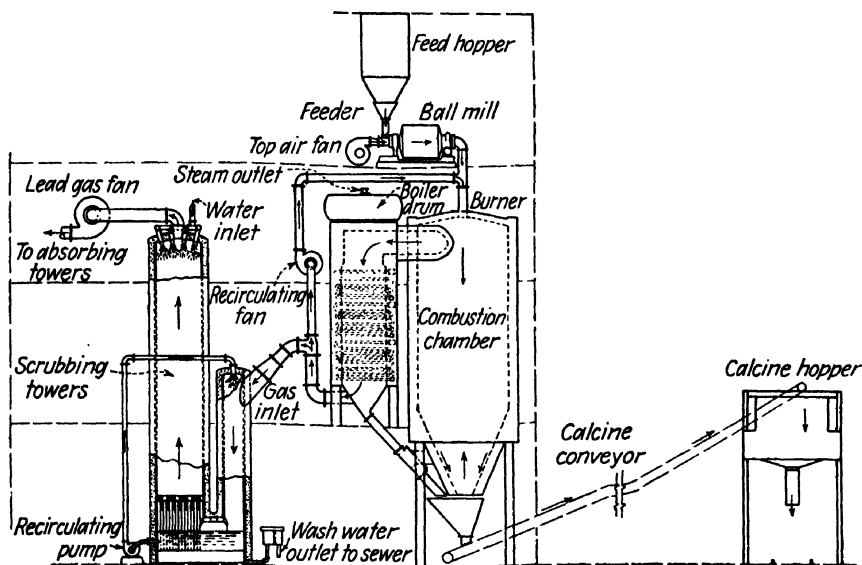

FIG. 13.—Nichols-Freeman flash roasting system for making SO_2 gas.

At the time of writing, the flash roaster is in commercial use, roasting iron pyrites for sulfur dioxide generation. Its adaptability to other fine materials such as flotation concentrates is apparent. Preparation of various raw materials for flash roasting may require operations of dewatering, drying, crushing, grinding, and air classification.

THERMOFOR KILN

The Thermoform kiln is an indirect heater which permits closer temperature control than is obtainable in either rotary or multiple-hearth furnaces.¹⁰ Its elements consist of metal tubes, each of which has a slanting spiral fin welded to it so as to provide a large heat-transfer surface. A number of these extended-surface tubes are mounted vertically and side by side with fins interlapping, all enclosed within a case or shell. The material to be processed is distributed evenly into the top of the shell. It then slides down, dropping from one fin to another until it finally reaches the bottom where it is removed. To control the temperature, a fused salt is circulated between the Thermoform tubes and

¹⁰ SIMPSON, NICHOLLS, and PAYNE, *Trans. AIChE*, **36**, 841 (1940).

a small tube-type furnace. This permits either heating or cooling. Heat of burning or of chemical reaction in the stock can be carried away by extinguishing the fire in the furnace and directing a blast of cold air through it.

This kiln was developed to revivify Houdry process catalyst and oil decolorizing earths. These contain considerable carbonaceous material which must be burned out, but the earths are injured if their temperature rises too high.

RECUPERATION AND REGENERATION

Sensible heat loss in flue gases is the greatest single source of low heat efficiency. The most generally applicable method of recovering heat from flue gas is to use it for preheating combustion air. Somewhat more than half of the sensible flue-gas heat from many sizable furnaces may be economically recovered by a *recuperator* or a *regenerator*. An approximate rule for oil and gas fuels is that 30°F of air preheat reduces fuel consumption by 1 per cent.

Preheating both air and producer-gas fuel is a necessity in a number of high-temperature metallurgical applications since the required furnace temperature may not be obtainable with the gases entering cold.

Recuperators. A recuperator is a heat exchanger type of air preheater. For medium temperatures as from boilers and oil heaters with fairly clean flue gases, the recuperator may be constructed of metal. Plain carbon steel is serviceable for preheating air up to about 800°F while alloy steels withstand air temperatures up to about 1200°F. The flue-gas temperature may be considerably higher than that of the air: 1600 to 2200°F, depending upon the recuperator composition and construction. (General details of metallic recuperator construction have been taken up on page 313 under Air Preheaters.)

Recuperators for high-temperature and special applications are constructed of ceramic material, usually fireclay or silicon carbide. Special recuperator tile have been widely used. These provide separate ducts for air and gas streams, the heat being transmitted through thin walls of the tile. They have not been wholly satisfactory, since thermal expansion and cracking permit leakage and finally render the unit unserviceable in some cases. Limits of pressures on this type are about 1½ in. H₂O above atmospheric to about 5 in. H₂O below it.

A later design shown in Fig. 14 is more durable and will withstand any ordinary draft pressure with but slight leakage. The tubes are 54 in. long, constructed of silicon carbide 4 in. i.d. with a ⅞ in. wall, and are sealed into fireclay headers. Fireclay *corebusters* of X shape are placed within the tubes and give better heat transfer on the inside. Air is passed inside the tubes and the heat-transfer coefficient is lowest on this

side. The flue gas flows outside and across the tubes. An installation may consist of one or more "passes," the number of passes being the number of tubes *in series* across which a particle in the gas stream must flow. The installation shown in Fig. 15 has four passes. The economic number of passes to be installed depends upon the cost of the unit, the

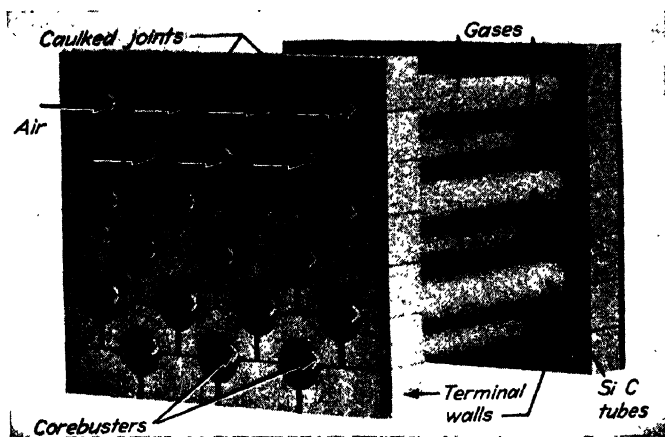

FIG. 14.—Silicon carbide tube recuperator. (Courtesy of Fitch Recuperator Company.)

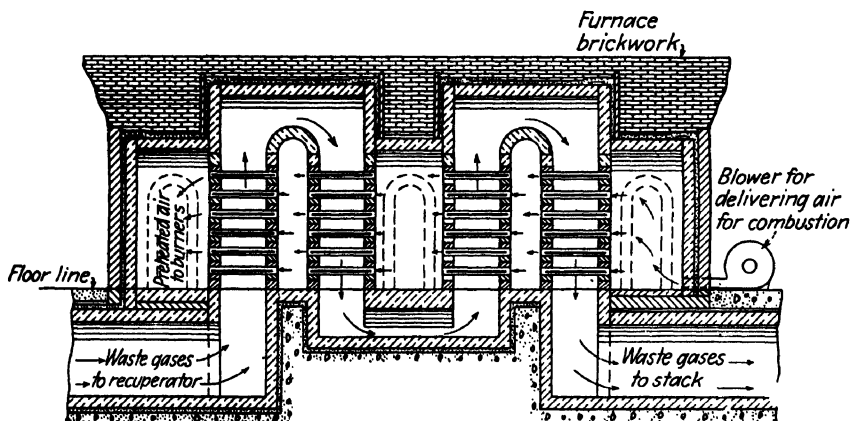

FIG. 15.—Four-pass recuperator installation. (Courtesy of Fitch Recuperator Company.)

draft loss (if mechanical draft is needed), and the value of the heat recovered.

Overall heat-transfer coefficients for all types of recuperators are usually between 2 and 5 $Btu/(hr)(sq\ ft)(^{\circ}F)$, metallic units in general giving higher values than those of ceramic construction. Air velocities are usually 6 or 8 ft/sec calculated as at $60^{\circ}F$. Flue-gas velocities may be somewhat higher. Pressure losses are ordinarily between 0.2 and 2.0 in. H_2O on the air side and somewhat lower on the gas side.

Thermal expansion due to heating and cooling tends to open up leaks in any recuperator, allowing the air to pass directly into the flue-gas stream. Recuperators are not generally satisfactory for dust-laden gases, since dust settles in and clogs the passages.

Regenerators. The regenerator is a device for recovery of the heat in high-temperature combustion gases from large furnaces by storing it temporarily in a unit constructed of firebrick or regenerator tile stacked in open formation. The operation is by alternate heating and cooling cycles. It is first heated by the flow of hot combustion gases through it, then the gas flow is changed or reversed so that the combustion air and producer gas are preheated.

The most important applications of regenerators are for open-hearth and blast furnaces. A blast furnace uses four regenerator units called "stoves." Open-hearth furnaces have twin units, the unit at each end being subdivided into air and fuel gas sections (Fig. 10). In the open-hearth type of installation, the flow is from one end of the furnace to the other. By a valve arrangement the flow is reversed at intervals. The combustion air and producer-gas fuel are preheated as separate streams. The duration of each heating or cooling period (time between reversals) may be as short as 6 or 7 min on small units to as long as 30 min on the large ones. Any deposited soot or tar is burned out when the flow is reversed.

Several styles of brick stacking are in use, no universally superior method having been found. Standard size firebrick are very common in checkers, but other sizes and shapes as well as special *regenerator tile* are also used. The brick and flues between should be about the same width. Minimum practical width is about $1\frac{1}{4}$ in., and this spacing shows some advantage over $2\frac{1}{2}$ in. widths in heating efficiency per cubic foot of checkerwork volume, when the narrow construction can be used without clogging by dust.

If possible, the regenerator should have vertical flow so that the flue gas travels downward on cooling and the air and fuel (being warmed) move upward. This minimizes undesirable channeling of the gases. Horizontal units are less effective since hot flue gases tend to remain in and heat the upper part, whereas the flow of cold air is fastest down near the floor. In conventional sizes and with normal temperature changes from top to bottom, 0.2 or 0.3 in. H_2O draft is *created*, which is more than the frictional resistance to gas flow.

Regenerator design calls for flue-gas velocity through the cross section of minimum free area of between 2 and 3 ft/sec, calculated as at 60°F. Regenerator volume determines the fraction of available heat that can be recovered. Standard firebrick weigh about 115 lb/cu ft and a total weight of from 35 to 70 lb of checker brick are provided per

pound of coal (or its fuel equivalent) *burned between flow reversals* for each regenerator unit. With twin units these figures are doubled.

Customary checkerwork construction gives about $4\frac{1}{2}$ sq ft of heat-transfer surface and contains 30 lb of brick per cubic foot of total volume. Other bases used for designing regenerators for steel furnaces burning producer gas are¹¹

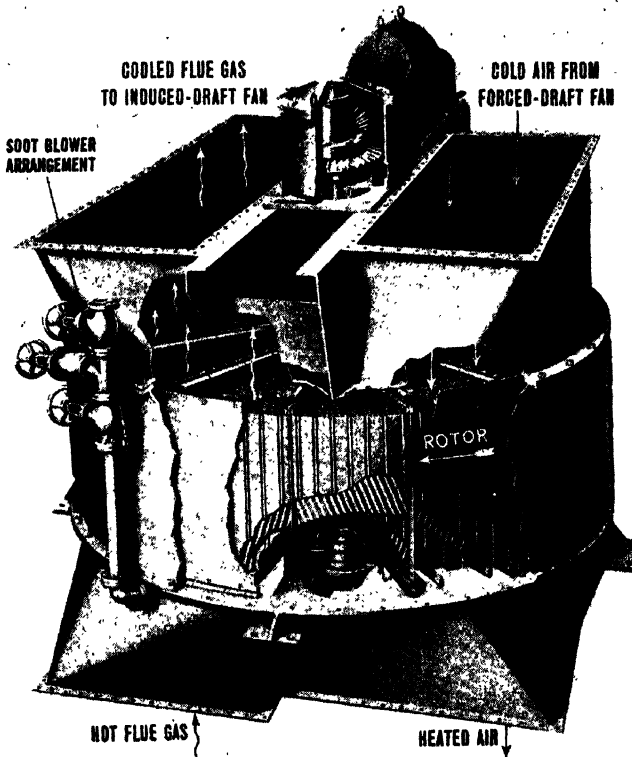

FIG. 16.—Regenerative-type air preheater. (Courtesy of Air Preheater Corporation.)

30 to 100 cu ft of checkerwork per ton of steel in furnace.

1 ton brick per ton of steel in furnace, for air checker.

1 cu ft of air per second per ton of steel in furnace.

1 lb of brick per cubic foot of air per second per °F preheat.

Air checker 10 to 100 per cent larger than producer gas checker (to give approximately equal preheat).

Complete regenerator calculations are cumbersome since many variables are involved.¹²

¹¹ HEPBURN, W. M., "Gas Engineers' Handbook," pp. 961-964, McGraw-Hill Book Company, Inc., New York, 1934.

¹² See Vol. I, pp. 207-228, of the Supplementary Reference.

Regenerative Preheater. Instead of the recuperative type of preheater, a special continuous type of metallic regenerator is sometimes used in boiler and oil heater service (Fig. 16). This consists of a rotating element of radial, corrugated plate construction, mounted in a case which provides separate air and flue-gas passages through the rotor. At any moment, half of the rotor is being heated by flue gas while the other half (comprising the air duct) is giving up its heat.

Illustration. Performance of a Wet-process Portland Cement Kiln

The following illustration is a complete heat and material balance made upon a wet-process rotary cement kiln and cooler, fired with natural gas. The data were obtained from a 6-hr test while the kiln was in normal operation. The unit is somewhat smaller than the average for cement kilns and was designed to produce 800 bbl of cement clinker per day.

The raw materials are oyster shell, clay, and water. In the wet process, the solids are ground and proportioned into a slurry or "raw mix" which is the kiln feed. During its passage through the kiln, the feed dries, the clay dehydrates, the calcium carbonate burns to CaO; finally sintering occurs and silicates form. The sintered material is the cement clinker. In this plant the clinker falls directly from the burner end of the kiln into the rotary cooler while at a white heat.

Equipment and Fuel

Kiln: Size = 8 by 220 ft. Slope = $\frac{3}{8}$ in/ft. Lining from burner end: $7\frac{1}{2}$ ft "hot-zone" blocks, 60 ft high-alumina brick, 90 ft "hot-zone" brick, 60 ft "cold-zone" brick. Chains for 60 ft at feed end.

Cooler: Size = 6 by 120 ft. Lined with firebrick for 60 ft from hot end. Channel lifters for 60 ft at cold end.

Primary Air System: Low-pressure type of burner. Primary air drawn through cooler and then 8-ft-diameter cyclone-type dust separator, by fan.

Fan Motor: 60 hp; 1,200 rpm; mechanical efficiency = 88 per cent.

Fan: American Blower Company, type S.E.; 1170 rpm; delivers 20,000 cu ft/min at 10.4 in. H₂O and 500°F; $PV = 15,500$; blower hp = 55.6; mechanical efficiency = 58 per cent.

Fuel Gas: Reported heating value: 1026.5 Btu/cu ft at 15.2 psi and 60°F. Reported analysis: methane, 99.74 per cent; ethane, 0.26 per cent.

TEST DATA

Figures are 6-hr totals or averages.

Slurry fed = 2,618 cu ft.

Fuel gas = 405,140 cu ft at 15.2 psia and 60°F.

<i>Temperatures</i>	°F
Air into cooler.....	96
Air out of cooler.....	1004
Air at fan inlet.....	477
Air at fan outlet.....	440
Flue gas.....	749
Fuel gas.....	75
Slurry.....	119
Clinker out of kiln.....	2160
Clinker out of cooler.....	234
Inside kiln*wall at burning zone.....	2470

Analyses

Material	SiO ₂ , %	Fe ₂ O ₃ , %	Al ₂ O ₃ , %	CaCO ₃ , %	MgCO ₃ , %	Ignition loss, %	CaSO ₄ , %
Clay.....	49.88	4.16	15.94	20.85	2.88	14.13	
Shell.....	1.44	0.54		96.03	0.84	43.21	
Raw mix.....	14.10	1.43	3.91	76.43	2.32	35.94	
				CaO	MgO		
Clinker.....	22.00	2.56	5.76	67.80	1.42	0.40	0.15
Cement.....	22.28	2.10	6.06	65.62	1.38	1.00	1.90

Slurry		Free lime	
Material.....	Av % H ₂ O	Material.....	% free lime
Clay.....	52.0	Clinker.....	0.50
Raw mix.....	43.0	Cement.....	0.80

Heats of Formation

$$\begin{aligned} \text{CaO} + \text{CO}_2 &= \text{CaCO}_3 + 42.0 \text{ kg-cal/g mol} \\ &\frac{(42,000)(1.8)}{56} = 1350 \text{ Btu/lb lime} \\ \text{CO}_2 &= \text{C} + \text{O}_2 - 94.39 \text{ kg-cal/g mol} \\ \text{Mg} + \text{C} + \text{O}_3 &= \text{MgCO}_3 + 266.6 \text{ kg-cal/g mol} \\ \text{MgO} &= \text{Mg} + \text{O} - 143.9 \text{ kg-cal/g mol} \\ \text{MgO} + \text{CO}_2 &= \text{MgCO}_3 + 28.31 \text{ kg-cal/g mol} \\ &\frac{(28,310)(1.8)}{40.32} = 1264 \text{ Btu/lb MgO} \end{aligned}$$

Silicates in clinker (approximately) = 200 Btu/lb clinker
 Other data given with calculations as needed.

CALCULATIONS

Slurry

Time: 6 hr (21,600 sec)
 Basis, 1 cu ft of water:

	Lb	%	Cu ft
Water.....	62.4	43.6	1.000
Solid mix.....	80.7	56.4	0.480
Total.....	143.1	100.0	1.480

Density of mix = 96.7 lb/cu ft
 Specific gravity = 1.550

Per cubic foot of mix:

$$\begin{array}{r} 42.15 \text{ lb water} \\ 54.55 \text{ lb solid mix} \\ \hline 96.70 \text{ lb, total} \end{array}$$

Weight of clinker produced by 1 cu ft of slurry:

$$\begin{array}{l} 615 \text{ lb solid feed} = 376 \text{ lb clinker} \\ 1 \text{ lb solid feed} = 37\frac{5}{6}\%_{15} = 0.6115 \text{ lb clinker} \\ (54.55)(0.6115) = 33.34 \text{ lb clinker/cu ft feed} \end{array}$$

From tank gaugings: 2,618 cu ft wet mix

$$\frac{(33.34)(2618)}{376} = 232.2 \text{ bbl clinker/6 hr}$$

or

$$\frac{232.2}{6} = 38.7 \text{ bbl/hr}$$

$$\text{Solids feed rate} = \frac{(54.55)(2,618)}{21,600} = 6.613 \text{ lb/sec}$$

$$\text{Clinker rate} = \frac{(33.34)(2,618)}{21,600} = 4.045 \text{ lb/sec}$$

Dust up stack = 19 lb/bbl clinker (plant estimate)

$$\frac{(4.045)(19)}{376} = 0.2045 \text{ lb/sec}$$

Air Rate through Cooler (See Fig. 17)

Cooler diam = 6 ft i.d.

$$\text{Area} = (3.14)(9) = 28.274 \text{ sq ft}$$

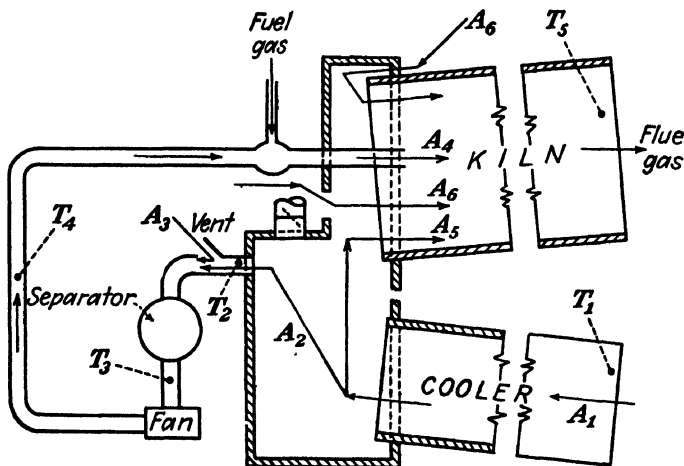

FIG. 17.—Air-flow diagram.

Air Streams	Temperatures
A ₁ . Air through cooler	T ₁ . Cooler inlet air
A ₂ . Preheated primary air	T ₂ . Cooler outlet air
A ₃ . Blend air from vent	T ₃ . Primary air at separator outlet
A ₄ . Total primary air	T ₄ . Primary air to kiln
A ₅ . Secondary air (directly from cooler)	T ₅ . Flue gas
A ₆ . Secondary air (leakage)	

Cross-sectional area divided into 2 equal concentric areas (anemometer traverse):

(1) Central area (14.137 sq ft):

$$\text{Av velocity} = \frac{169 + 134}{2} = 151.5 \text{ ft/min}$$

$$\text{Volume air} = (14.137)(151.5) = 2,142 \text{ cu ft/min}$$

(2) Annular area (14.137 sq ft):

$$\text{Av velocity} = \frac{139 + 87}{2} = 113 \text{ ft/min}$$

$$\text{Volume air} = (14.137)(113) = 1,598 \text{ cu ft/min}$$

$$\text{Air rate through cooler} = (2,142) + (1,598) = 3,740 \text{ cu ft/min at } 96^\circ\text{F}$$

$$= \frac{(3,740)(520)}{556} = 3,500 \text{ cu ft/min at } 60^\circ$$

$$\frac{3,500}{60} = 58.333 \text{ cu ft/sec at } 60^\circ\text{F}$$

Flue Gas and Total Air

Basis, 1 sec:

$$\text{Fuel gas burned} = \frac{405,140}{21,600} = 18.76 \text{ cu ft at } 15.2 \text{ psia } 60^\circ\text{F}$$

$$\text{Higher heating value} = 1026.5 \text{ Btu/cu ft at } 15.2 \text{ psia } 60^\circ\text{F}$$

Composition: 99.74% CH₄; 0.26% C₂H₆

	CO ₂	H ₂ O
CH ₄ + 2O ₂ = CO ₂ + 2H ₂ O	18.711 cu ft	37.422 cu ft
C ₂ H ₆ + 3½O ₂ = 2CO ₂ + 3H ₂ O	0.097	0.146

Totals in cubic feet at 15.2 psia and 60°F:

Oxygen.....	37.593
CO ₂	18.808
H ₂ O.....	37.568

Totals in cubic feet at 14.7 lb and 60°F:

Oxygen.....	38.86 (air, 185.0 cu ft)
CO ₂	19.45
H ₂ O.....	1.843 lb

Av flue-gas analysis:

	%
CO ₂	18.40
O ₂	2.23
CO.....	0.00
Inerts (by difference).....	79.37
Total.....	100.00

$$\text{Quantity of air necessary with no excess} = \frac{(38.86)(100)}{21} = 185.0 \text{ cu ft/sec}$$

$$\text{Nitrogen} = 185.0 - 38.9 = 146.1 \text{ cu ft}$$

Let x = cubic feet of excess air,

$$\text{Ratio of oxygen to nitrogen in flue gas} = \frac{2.23}{79.37} = 0.0281$$

$$\frac{0.21x}{146.1 + 0.79x} = 0.0281$$

$$x = 21.85 \text{ cu ft excess air}$$

$$\text{Total air into kiln} = 185.0 + 21.85 = 206.85 \text{ cu ft/sec}$$

Total Air (Check)

$$\text{Dry feed rate} = \frac{(54.55)(2618)}{21,600} = 6.613 \text{ lb/sec}$$

By analysis, 34.82 per cent of feed is CO_2 .

$$\text{CO}_2 \text{ from feed} = (6.613)(0.3482) = 2.302 \text{ lb}$$

or

$$\frac{(2.302)(379.5)}{44} = 19.85 \text{ cu ft/sec}$$

$$\text{CO}_2 \text{ from fuel} = \frac{19.45 \text{ cu ft}}{\text{Total CO}_2 = 39.30 \text{ cu ft/sec}}$$

$$\text{Dry flue-gas rate} = \frac{(39.30)(100)}{18.40} = 213.5 \text{ cu ft/sec}$$

$$\text{Total air into kiln} = \frac{(213.5)(0.7937)}{0.79} = 214.5 \text{ cu ft/sec}$$

compared to 206.9 cu ft/sec calculated from fuel-gas data.

$$\text{Av total air entering} = \frac{(214.5 + 206.90)}{2} = 210.7 \text{ cu ft/sec}$$

$$\text{Excess air} = \left(\frac{25.7}{185} \right) (100) = 13.9 \text{ per cent}$$

Cooler Heat Exchange

Basis, 1 sec:

$$\text{Air through cooler} = 58.333 \text{ cu ft/sec}$$

$$\text{Av temperature} = \frac{1004 + 96}{2} = 550^\circ\text{F}$$

$$\text{Av specific heat} = 0.248$$

$$\text{Density of air at } 60^\circ = \frac{29}{379.5} = 0.0764 \text{ lb/cu ft}$$

$$\text{Heat gained by air in cooler} = (58.333)(0.0764)(0.248)(1004 - 96) = 1002 \text{ Btu/sec}$$

Heat lost by clinker:

$$\text{Rate, } 4.045 \text{ lb/sec}$$

$$\text{Av temperature} = \frac{2160 + 234}{2} = 1197^\circ\text{F}$$

$$\text{Average specific heat} = 0.262$$

$$(4.045)(0.262)(2160 - 234) = 2040 \text{ Btu/sec}$$

$$\text{Heat lost by radiation} = (2040) - (1002) = 1038 \text{ Btu/sec.}$$

$$\frac{(1038)(100)}{2040} = 50.8 \text{ per cent}$$

Quantity of Air through Fan

Basis, 1 lb of air:

From Walker, Lewis, McAdams, and Gilliland, p. 46, a mechanical energy balance, neglecting friction, gives

$$W' = \int_1^2 v dp = \frac{u_2^2 - u_1^2}{2g}$$

where W' = mechanical work imparted to the fluid from an external source, ft-lb/lb v = specific volume, cu ft/lb p = absolute static press, lb/sq ft u = velocity of fluid at a chosen point, ft/sec g = acceleration due to gravity, 32.17 ft/(sec)(sec)

$$pv = nRT$$

$$v = \frac{1}{29} \frac{RT}{p}$$

$$\begin{aligned} W &= \frac{u_2^2 - u_1^2}{2g} + \frac{RT}{29} \int_1^2 \frac{dp}{p} \\ &= \frac{u_2^2 - u_1^2}{2g} + \frac{(2.303)(RT)}{29} \log \frac{p_2}{p_1} \\ &= \frac{u_2^2 - u_1^2}{64.3} + \left(\frac{2.303}{29} \right) (1,543)(918.5) \log \frac{417}{405.8} \\ &= \frac{u_2^2 - u_1^2}{64.3} + 1347 \end{aligned}$$

Volume of air at 10 in. H₂O gauge (407 in. H₂O = 1 atm)

$$\frac{(359)(918.5)(407)}{(29)(492)(417)} = 22.53 \text{ cu ft/lb}$$

$$\text{Area of outlet to fan} = 5.25 \text{ sq ft} = A_2 \quad (\text{Fig. 17})$$

$$\text{Area of inlet to fan} = (1.72)(3.14) = 5.41 \text{ sq ft} = A_1$$

$$\text{Volume of 1 lb of air at } (-1.2 \text{ in.}) \text{ water gauge} = \frac{(22.53)(417)}{405.8} = 23.15 \text{ cu ft/lb}$$

Let Q = air rate as cu ft/sec

$$Q_2 = u_2 A_2 = 5.25 u_2$$

$$Q_1 = 5.41 u_1$$

$$\frac{Q_1}{Q_2} = \frac{23.15}{22.53} = \frac{5.41 u_1}{5.25 u_2}$$

$$\frac{u_1}{u_2} = \frac{(23.15)(5.25)}{(22.53)(5.41)} = 0.9971$$

$$u_1 = 0.9971 u_2; \quad u_1^2 = 0.9943 u_2^2$$

$$Q_2 = 5.25 u_2; \quad \frac{Q_2}{22.53} = \frac{5.25}{22.53} u_2 = \text{lb air/sec}$$

Work delivered to each pound of air:*

$$\frac{(10,330)(22.53)}{5.25 u_2} = \frac{44,350}{u_2}$$

* See p. 436 for calculation of 10,330 ft lb/sec used here.

$$W' = \frac{44,350}{u_2} = \frac{u_2^2 - 0.9943 u_2^2}{64.3} + 1,347$$

$$44,350 = (8.87)(10^{-5}) u_2^2 + 1,347 u_2$$

Assume u_2 is 30 ft/sec,

$$(8.87)(10^{-5})(0.27)(10^6) + 40,410 \neq 44,350$$

$$2.4 + 40,410 \neq 44,350$$

This indicates that the term, $\frac{u_2^2 - 0.9943 u_2^2}{64.3}$, is negligible since it adds only 2.4 in 40,000; that is, the change in kinetic energy is negligible. Then,

$$\frac{44,350}{u_2} = 1,347$$

$$u_2 = 32.9 \text{ ft/sec}$$

Basis, 1 sec:

Volume = (5.25)(32.9) = 173 cu ft/sec at 458.5° and 417 in. H₂O

Air rate through fan at 1 atm and 60°F = $\frac{(173)(520)(417)}{(918.5)(407)} = 100.3 \text{ cu ft/sec}$

The following is a check on the calculations made above:

$$\text{Hp} = \frac{5.2Qh}{33,000E}$$

Power consumption = 27.45 kw

Efficiency of motor = 88 per cent; efficiency of fan = 58 per cent

$$\text{Hp to fan} = \frac{(27.45)(0.88)}{0.746} = 32.4$$

$$32.4 = \frac{(5.2)(11.2)(Q)}{(33,000)(0.58)}$$

$$Q = 10,640 \text{ cu ft/min at } 458.5^\circ\text{F}$$

$$= 177.3 \text{ cu ft/sec at } 458.5^\circ\text{F}$$

At 60°F,

$$= \frac{(177.3)(520)}{918.5} = 100.3 \text{ cu ft/sec}$$

From above efficiencies and power input:

$$\text{Hp to air} = (32.4)(0.58) = 18.8$$

or

$$(550)(18.8) = 10,330 \text{ ft lb/sec}$$

Radiation from Air Lines around Fan

Emissivity of aluminum paint surface = 0.35 (estimated)

Emissivity of oil-paint surface = 0.94

1 sq ft of oil-paint surface = 2.7 sq ft aluminum surface

Area between thermometer and thermocouple on opposite sides of fan:

Area of duct from thermometer (T_2) to fan inlet = 71.2 sq ft (Al paint)

Area of fan housing = 94.7 sq ft (Al paint)

Area of discharge line to thermocouple (T_4)

= 87.9 sq ft oil-painted (red) or the equivalent of 237.3 sq ft (Al paint)
to be used for rough check only.

Total area = 71.2 + 94.7 + 237.3 = 403.2 sq ft (Al-paint)*

Area of duct to separator = 62.35 sq ft (Al paint)

Area (surface) of separator = 275.56 sq ft (Al paint)

Area of duct from separator to T_3 = 53 sq ft (Al paint)

Total area = 62.53 + 275.6 + 53 = 391 sq ft*

Radiation around fan, between thermometer T_3 and thermocouple T_4 :

Average temperature of air = 458°F

Assume surface temperatures to be 400°F, and atm temp = 100°F

$h_c = 0.3(\Delta)^{0.25}$ (p. 133, Walker, Lewis, McAdams, and Gilliland)

$h_c = 0.3(300)^{0.25} = 1.25$ Btu/(hr)(sq ft)(°F)

$h_r = \frac{(0.173)(0.35)[(860/100)^4 - (560/100)^4]}{300}$

= (2.02)(10⁻⁴)(5480 - 980)

= 0.91 Btu/(hr)(sq ft)(°F)

$(q_c + q_r) = \frac{(1.25 + 0.91)(403.2)(400 - 100)}{3,600} = 72.5$ Btu/sec

$(t_1 - t_2) = \frac{(72.5)(379.5)}{(100.3)(29)(0.247)} = 38^\circ\text{F}$, compared to 37°F as read from thermo-

couple T_4 and thermometer T_3 .

Temperature drop in ducts and separator from the vent (T_2) up to point where thermometer (T_3) was located in the intake line to the fan:

Area around separator = 391 sq ft

Area around fan = 403 sq ft

Temp drop around separator = $\frac{(37)(391)}{403} = 36^\circ\text{F}$

True temperature of the primary air immediately after vent = 477 + 36 = 513°F

Weight of primary air = $\frac{(100.3)(29)}{379.5} = 7.67$ lb/sec

Let x be the amount of air drawn from cooler as primary air. Then (7.67 - x) is the amount drawn through vent from outside.

Temperature of air from cooler = 1004°F

Av specific heat of air at 760°F = 0.253

Av specific heat of air at 300°F = 0.247

Assume inlet air at 100°F,

$(7.67 - x)(0.247)(510 - 100) = x(0.253)(1004 - 513)$

$x = 3.43$ lb/sec primary air from cooler

$7.67 - x = 4.24$ lb/sec primary air from vent

Air through cooler = 58.333 cu ft/sec at 60°F

* Areas estimated from dimensions obtained from company blueprints.

or

$$\frac{58.333}{379.5} (29) = 4.46 \text{ lb/sec}$$

Air from cooler to kiln directly = $4.46 - 3.43 = 1.03$ lb/sec at 1004°F
 Total air entering kiln = 210.7 cu ft/sec at 60°F

or

$$\frac{(210.7)(29)}{379.5} = 16.1 \text{ lb/sec}$$

Secondary air from outside = $16.1 - (7.67 + 1.03) = 7.40$ lb/sec

KILN HEAT BALANCE

Basis, 1 sec, base temp, 60°F :

Heat Entering Kiln

Heat of formation of silicates = 200 Btu/lb clinker

Clinker rate = 4.045 lb/sec

Heat given off by silicate formation = $(200)(4.045) = 810$ Btu/sec

Fuel gas rate = $\frac{405,140}{21,600} = 18.76$ cu ft/sec at 15.2 lb and 60°F

Heating value of fuel = 1026.5 Btu/cu ft

Water from combustion of fuel gas = 1.843 lb/sec

Specific gravity of gas = 0.555

Weight rate of gas = $\frac{(18.76)(15.2)(29)(.555)}{(379.5)(14.7)} = 0.822$ lb/sec

Temperature of gas entering kiln = 75°F

Sensible heat in fuel gas above 60°F = $(0.822)(0.556)(75 - 60) = 6.85$ Btu/sec

Heat of combustion of fuel gas (net value)

$$= (18.76)(1026.5) - (1.843)(1040) = 17,313 \text{ Btu/sec}$$

Feed rate at 119°F :

Solids.....	6.613 lb/sec
Water.....	5.11 lb/sec
Total.....	11.723 lb/sec

Specific heat of solids at 90°F = 0.20

Specific heat of water = 1.00

Sensible heat in feed = $(6.613)(0.20)(119 - 60) + (5.11)(1)(119 - 60)$
 $= 380$ Btu/sec

Primary air rate: From cooler 3.43 lb/sec at 1004°F

Blend air from vent 4.24 lb/sec at 100°F

Specific heat of air from cooler = 0.250

Specific heat of blend air from vent = 0.245

Sensible heat in air from cooler = $(3.43)(0.25)(1004 - 60) = 800$ Btu/sec

Sensible heat in blend air from vent = $(4.24)(0.245)(100 - 60) = 40$ Btu/sec

Secondary air rate: Leakage 7.40 lb/sec at 300°F

Direct from cooler 1.03 lb/sec at 1004°F

Specific heat of leakage air = 0.246

Specific heat of air direct from cooler = 0.250

$$\begin{aligned}\text{Sensible heat in leakage air} &= (7.40)(0.246)(300 - 60) = 437 \text{ Btu/sec} \\ \text{Sensible heat in air direct from cooler} &= (1.03)(0.25)(1004 - 60) = 243 \text{ Btu/sec}\end{aligned}$$

$$\text{Total heat entering kiln} = 20,030 \text{ Btu/sec}$$

Heat Leaving Kiln

$$\text{Water from combustion} = 1.843 \text{ lb/sec}$$

$$\text{Water from slurry} = \frac{(2,618)(42.15)}{21,600} = 5.105 \text{ lb/sec}$$

$$\text{Total water in flue gas} = 5.105 + 1.843 = 6.948 \text{ lb/sec}$$

$$\text{Temperature of flue gas} = 749^\circ\text{F}$$

$$\text{Specific heat of water vapor at } 405^\circ\text{F} = 0.47$$

$$\text{Heat out in water vapor} = (6.948)(0.47)(749 - 60) + (1060)(5.105) = 7665 \text{ Btu/sec}$$

$$\text{Weight of dry flue gas (213.5 cu ft/sec at } 60^\circ\text{F)}:$$

$$\text{CO}_2: \frac{(213.5)(0.184)(44)}{379.5} = 4.56 \text{ lb/sec}$$

$$\text{O}_2: \frac{(213.5)(0.0223)(32)}{379.5} = 0.40 \text{ lb/sec}$$

$$\text{N}_2: \frac{(213.5)(0.7937)(28)}{379.5} = 12.50 \text{ lb/sec}$$

$$\text{Rate of flue gas} = 17.46 \text{ lb/sec}$$

$$\text{Average specific heat of dry flue gas at } 405^\circ\text{F}:$$

$$\text{N}_2: (0.7937)(0.248) = 0.1966$$

$$\text{O}_2: (0.0233)(0.220) = 0.0049$$

$$\text{CO}_2: (0.184)(0.217) = 0.0400$$

$$\text{Total specific heat} = 0.2415$$

$$\text{Heat out in flue gas} = (17.46)(0.2415)(749 - 60) = 2910 \text{ Btu/sec}$$

$$\text{Clinker rate} = 4.045 \text{ lb/sec}$$

$$\begin{aligned}\text{Heat out in clinker (specific heat at } 1110^\circ\text{F} = 0.225) &= (4.045)(0.255)(2160 - 60) \\ &= 2170 \text{ Btu/sec}\end{aligned}$$

$$\text{Rate of dust up stack} = 0.2045 \text{ lb/sec}$$

$$\text{Specific heat of dust} = 0.218$$

$$\text{Heat out in dust up stack} = (0.2045)(0.218)(749 - 60) = 30 \text{ Btu/sec}$$

$$\text{Solids feed rate} = 6.613 \text{ lb/sec}$$

By analysis of feed mix:

$$\% \text{ CaO} \dots \dots \dots 42.82$$

$$\% \text{ MgO} \dots \dots \dots 1.11$$

$$\text{Heat of decomposition of CaCO}_3 = -1350 \text{ Btu/lb CaO}$$

$$\text{Heat of decomposition of MgCO}_3 = -1264 \text{ Btu/lb MgO}$$

$$\begin{aligned}\text{Heat taken up by decomposition} &= (6.613)(0.4282)(1350) + (6.613)(0.0111)(1264) \\ &= 3910 \text{ Btu/sec}\end{aligned}$$

$$\text{Radiation from kiln (by difference)} = 3345 \text{ Btu/sec}$$

$$\text{Total heat leaving kiln} = 20,030 \text{ Btu/sec}$$

Summary of Results

 KILN MATERIAL BALANCE
 (Basis, 1 bbl of clinker = 376 lb)

	Lb per bbl of clinker	
	Items	Stream totals
<i>Materials In</i>		
Slurry feed:		
1. Solids.....	615.0	
2. Water.....	475.0	1,090.0
Fuel gas.....		76.4
Primary air:		
1. Preheated (from cooler).....	319.0	
2. Cold air into vent.....	394.0	713.0
Secondary air:		
1. Directly from cooler.....	95.7	
2. Leakage around hood.....	687.5	783.2
Total materials in.....		2,662.6
<i>Materials Out</i>		
Clinker.....		376.0
Stack materials:		
1. Dry flue gas.....	1,622.0	
2. Water vapor.....	646.0	
3. Dust.....	19.0	2,287.0
Total materials out.....		2,663.0
Total clinker output.....		928.0 bbl/day

KILN HEAT BALANCE
(Basis, 1 bbl of clinker. Base temperature: 60°F)

	Btu per bbl		% of total
<i>Heat Entering Kiln</i>			
Slurry feed:			
1. Solids.....	7,250		
2. Water.....	<u>28,000</u>	35,250	1.81
Fuel gas:			
1. Sensible heat.....	640		
2. Heat of combustion (net).....	<u>1,690,000</u>	1,690,640	87.06
Primary air:			
1. Preheated from cooler.....	74,350		
2. Blend air from vent.....	<u>3,720</u>	78,070	4.01
Secondary air:			
1. Directly from cooler.....	22,570		
2. Leakage around hood.....	40,620 ^a	63,190	3.25
Heat of clinker formation ^b		75,250	3.87
Total.....		<u>1,942,400</u>	100.00
<i>Heat Leaving Kiln</i>			
Sensible heat in clinker.....		205,000	10.6
Stack materials:			
		%	
1. Dry flue gas.....	270,000	27.43	
2. Water vapor:			
a. From fuel.....	55,500	5.63	
b. From slurry.....	656,500	66.66	
3. Dust.....	<u>2,800</u>	<u>0.28</u>	
	985,100	100.00	985,100
			50.6
Heat to decompose:			
		%	
1. CaCO ₃	354,700	97.63	
2. MgCO ₃	<u>8,600</u>	<u>2.37</u>	
	363,300	100.00	363,300
			18.7
Radiation (by difference).....			389,000
			20.1
Total.....			<u>1,942,400</u>
			100.00

^a Assumed temperature, 300°F.

^b Using Meade's value of 200 Btu/lb.

KILN AIR BALANCE

(Basis, 1 bbl of clinker. Base temperature, 60°F. Base pressure, 14.7 psi)

			Cu ft per bbl	% of total
<i>Sources</i>				
Primary air:				
1. Preheated (from cooler).....	4,170	44.7	9,330	47.65
2. Cold air into vent.....	5,160	55.3		
	9,330	100.0		
Secondary air:				
1. Directly from cooler.....	1,250	12.2	10,250	52.35
2. Leakage around hood.....	9,000	87.8		
	10,250	100.0		
Total.....			19,580	100.0
<i>Utilization of Air</i>				
Theoretical air for combustion.....			17,190	87.80
Excess air.....			2,390	12.20
Total.....			19,580	100.00
Per cent excess air.....				13.90

Supplementary Reference

TRINKS, W.: "Industrial Furnaces," Vols. I and II, 3d ed. (1934) and 2nd ed. (1942), respectively, John Wiley & Sons, Inc., New York.

Exercises

1. Discuss the essential differences of construction and operation between continuous and batch furnaces.
2. Under what circumstances are continuous furnaces more economical than batch furnaces? When is the reverse true?
3. What are the features of the following types of furnaces: (a) shaft, (b) open-hearth, (c) rotary kiln?
4. Give the general constructional data for rotary kilns.
5. Discuss briefly the relative advantages of the rotary kiln, the multiple-hearth furnace, and the Thermoform kiln, for an oil-refinery installation to revivify fuller's earth.
6. What are the essential differences between recuperators and regenerators? What factors should be considered in determining which is better for an installation that might use either?

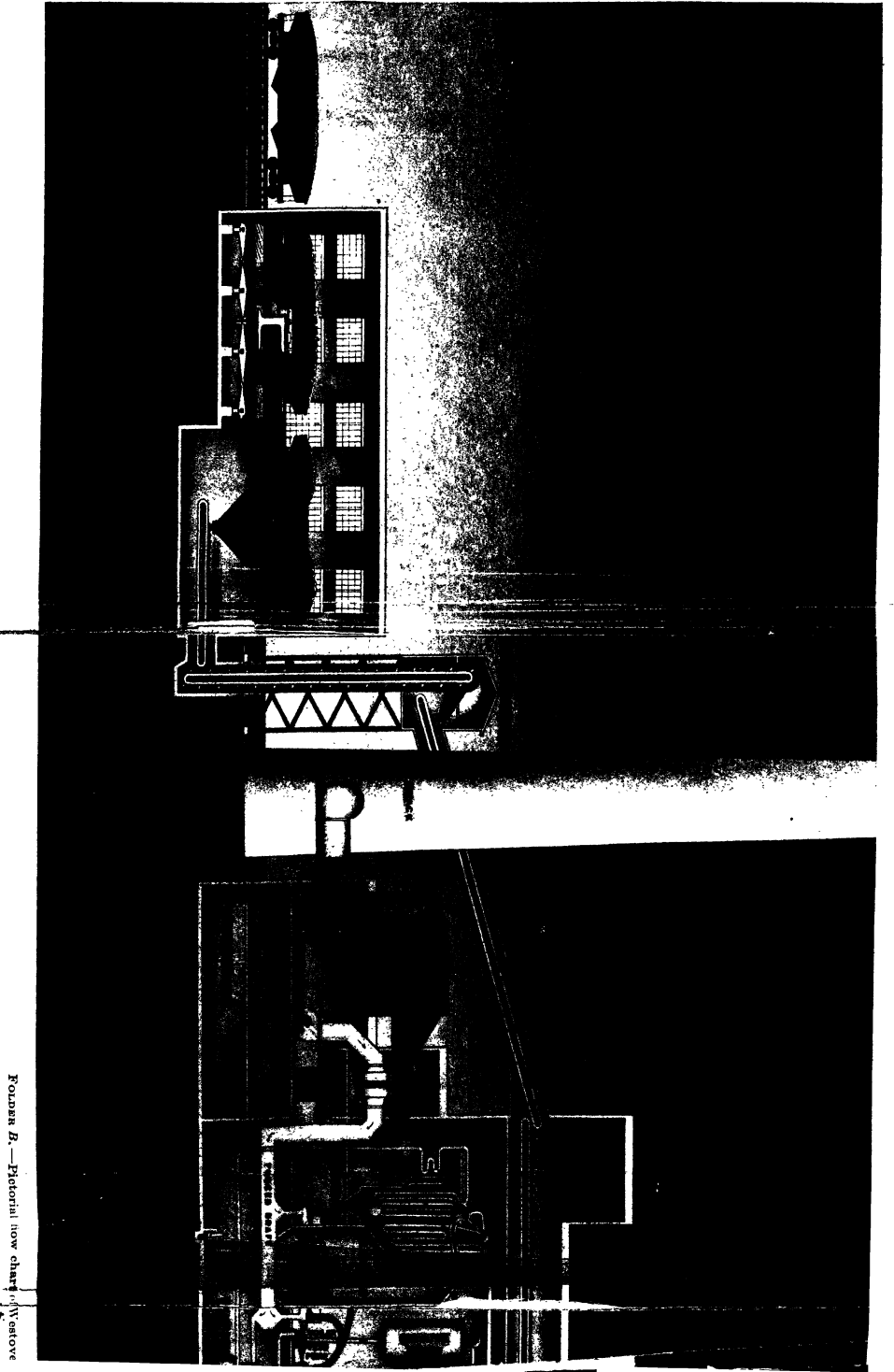

RODAN B.—Pictorial: how sharp is Westover

APPENDIX OF DATA

CONTENTS

	TABLE No.	PAGE
General Conversion Factors		
Units of Volume and Weight.	1	445
Units of Energy.	2	446
Temperature Conversion Table.	3	447
Vapor Pressure Tables		
Water, 30 to 219°F, mm Hg	4	449
Steam.	5	450
Approximate Head-pressure Equivalents for Mercury, Water, and Kerosine.	6	451
Properties of Fuels		
Pure Constituents of Gaseous Fuels.	7	451
Analyses and Heating Values of Typical Fuels	8	452
Conversion Factors for Petroleum Oils		
Pounds per Gallon and Specific Gravities Corresponding to Degrees API	9	453
Temperature Coefficients of Expansion.	10	457
Viscosity Units and Conversion Factors	11	458
Standard Wrought Iron and Steel Pipe Data.	12	460
Standard Condenser Tube Data	13	461
Physico-thermal Properties		
Thermal Conductivities of Metals and Alloys.	14	462
Thermal Conductivities of Some Building and Insulating Materials . . .	15	463
Thermal Conductivities of Some Liquids and Gases	16	464
Table of Emissivities	17	465
Color Scale for Temperatures.	18	468
Approximate Heat Content of Metals, Alloys, Refractories.	19	469
Transmitted Heat Losses through Walls	20	470

TABLE 1.—CONVERSION TABLE FOR UNITS OF VOLUME AND WEIGHT*

To convert from	Multiply by											
	To cu in.	To cu ft	To cu yd	To pt	To qt	To gal	To grain	To oz, av	To lb, av	To cc or g	To l or kg	To cu m
Cu in.....	1.00000	0.0,5787	0.0,2143	0.034632	0.017316	0.004329	252.891	0.578037	0.036127	16.3871	0.016387	0.0,1639
Cu ft.....	1728.00	1.00000	0.037037	59.8442	29.9221	7.48052	436996	998.848	62.4280	28316.9	28.3169	0.028317
Cu yd.....	46656.0	27.0000	1.00000	1615.79	807.896	201.974	117990	20968.9	1685.56	764556	764.556	0.764556
Pt.....	28.8750	0.016710	0.0,6189	1.00000	0.50000	0.125000	7302.23	16.6908	1.04318	473.177	0.473177	0.0,4732
Qt.....	57.7500	0.033420	0.001238	2.00000	1.00000	0.250000	1460.45	33.3816	2.08635	946.354	0.946354	0.0,9464
U. S. gal.....	231.000	0.133681	0.004951	8.00000	4.00000	1.00000	5841.79	133.527	8.34541	3785.42	3.78542	0.003785
Grain.....	0.003954	0.0,2288	0.0,8475	0.0,1369	0.0,6850	0.0,1712	1.00000	0.002286	0.0,1428	0.064799	0.0,6480	0.0,6480
Oz, av.....	1.72999	0.001001	0.0,3708	0.05913	0.029957	0.007489	437.500	1.00000	0.062500	28.3495	0.028350	0.0,2835
Lb, av.....	27.6799	0.016018	0.0,5933	0.958611	0.479306	0.119826	7000.00	16.0000	1.00000	453.593	0.453593	0.0,4536
Cc or gram.....	0.061024	0.0,3531	0.0,1308	0.002113	0.001057	0.0,2642	15.4323	0.035274	0.002205	1.00000	0.001000	0.000001
L or kg.....	61.0237	0.035315	0.001308	2.11337	1.05669	0.264172	15432.3	35.2739	2.20462	1000.00	1.000000	0.001000
Cu m.....	61023.7	35.3146	1.30795	2113.37	1056.69	264.172	15432.3	35273.9	2204.62	1000000	1000.00	1.00000

NOTE: The small subnumeral following a zero indicates that the zero is to be taken that number of times; thus, 0.0,1428 is equivalent to 0.0001428.

Values used in constructing table:

1 in. = 2.540001 cm

1 cu in. = 16.387083 cc = 16.387083 g H₂O at 4°C

4°C = 39°F

1 lb av = 453.5926 g

1 gal = 8.34541 lb

1 lb av = 27.679886 cu in. H₂O at 4°C.

1 lb av = 7,000 grains

1 gal = 58,417.87 grains

231 cu in. = 1 gal = 3,785.4162 g

In converting from volume to weight, the specific gravity must also be used in the multiplier.

* Compiled by E. I. du Pont de Nemours & Co.

TABLE 2.—CONVERSION TABLE FOR UNITS OF ENERGY*

To convert from	Multiply by										
	Btu	Pcu	Cal	Ft-lb	Ft-tons	Kg-m	Hp-hr	Kw-hr	Joules	Lb C	Lb H ₂ O
Btu.....	1.00000	0.555556	0.251996	778.0000	0.389001	107.563	0.0,3929	0.0,2931	1055.20	0.0,6876	0.001031
Pcu.....	1.80000	1.00000	45.3593	1400.40	0.700202	193.613	0.0,7072	0.0,5276	1899.36	0.0,1238	0.001855
Cal.....	3.96832	2.20462	1.00000	3091.36	1.54368	426.844	0.001559	0.001663	4187.37	0.0,2729	0.004089
Ft-lb.....	0.001285	0.0,7141	0.0,3239	1.000000	0.000500	0.138255	0.0,5050	0.0,3767	1.35625	0.0,8840	0.0,1325
Ft-tons.....	2.57069	1.428160	0.647804	2000.00	1.00000	276.511	0.001010	0.0,7535	2712.59	0.0,1768	0.002649
Kg-m.....	0.009297	0.005165	0.002343	7.23301	0.003617	1.00000	0.0,3653	0.0,2725	9.81009	0.0,6394	0.0,9580
Hp-hr.....	2544.990	0.141388	641.327	1980000	990.004	273747	1.00000	0.746000	2685473	0.175044	2.62261
Kw-hr.....	3411.57	1895.32	859.702	2654200	1327.10	366959	1.34041	1.00000	3599889	0.234648	3.51562
Joules.....	0.0,9477	0.0,5265	0.0,2388	0.737311	0.0,3687	0.101937	0.0,3724	0.0,2778	1.00000	0.0,6518	0.0,9766
Lb C.....	14544.0	8080.00	3665.03	113150,	5657.63	1564396	5.71434	4.26285	153470,	1.00000	14.9876
Lb H ₂ O.....	970.400	539.111	244.537	754971	377.487	1043790	0.381270	0.284424	1023966	0.066744	1.00000

* "Pcu" refers to the "pound-centigrade unit." The ton used is 2,000 lb. "Lb C" refers to pounds of carbon oxidized, 100% efficiency equivalent to the corresponding number of heat units. "Lb. H₂O" refers to pounds of water evaporated at 100°C = 212°F at 100% efficiency.

* Compiled by E. I. du Pont de Nemours & Co.

TABLE 3.—TEMPERATURE CONVERSION TABLE*

0 to 100				100 to 1000				1000 to 2000									
C	F	C	F	C	F	C	F	C	F	C	F						
-17.8	0	32.0	10.0	50	122.0	37.8	100	212	260	500	932	538	1000	1832	816	1500	2732
-17.2	1	33.8	10.6	51	123.8	38	101	214	266	510	950	543	1010	1850	821	1510	2750
-16.7	2	35.6	11.1	52	125.6	39	102	216	271	520	968	549	1020	1868	827	1520	2768
-16.1	3	37.4	11.7	53	127.4	39	103	217	277	530	986	554	1030	1886	832	1530	2786
-15.6	4	39.2	12.2	54	129.2	40	104	219	282	540	1004	560	1040	1904	838	1540	2804
-15.0	5	41.0	12.8	55	131.0	41	105	221	288	550	1022	566	1050	1922	843	1550	2822
-14.4	6	42.8	13.3	56	132.8	41	106	223	293	560	1040	571	1060	1940	849	1560	2840
-13.9	7	44.6	13.9	57	134.6	42	107	225	299	570	1058	577	1070	1958	854	1570	2858
-13.3	8	46.4	14.4	58	136.4	42	108	226	304	580	1076	582	1080	1976	860	1580	2876
-12.8	9	48.2	15.0	59	138.2	43	109	228	310	590	1094	588	1090	1994	866	1590	2894
-12.2	10	50.0	15.6	60	140.0	43	110	230	316	600	1112	593	1100	2012	871	1600	2912
-11.7	11	51.8	16.1	61	141.8	49	120	248	321	610	1130	599	1110	2030	877	1610	2930
-11.1	12	53.6	16.7	62	143.6	54	130	266	327	620	1148	604	1120	2048	882	1620	2948
-10.6	13	55.4	17.2	63	145.4	60	140	284	332	630	1166	610	1130	2066	888	1630	2966
-10.0	14	57.2	17.8	64	147.2	66	150	302	338	640	1184	616	1140	2084	893	1640	2984
-9.44	15	59.0	18.3	65	149.0	71	160	320	343	650	1202	621	1150	2102	899	1650	3002
-8.89	16	60.8	18.9	66	150.8	77	170	338	349	660	1220	627	1160	2120	904	1660	3020
-8.33	17	62.6	19.4	67	152.6	82	180	356	354	670	1238	632	1170	2138	910	1670	3038
-7.78	18	64.4	20.0	68	154.4	88	190	374	360	680	1256	638	1180	2156	916	1680	3056
-7.22	19	66.2	20.6	69	156.2	93	200	392	366	690	1274	643	1190	2174	921	1690	3074
-6.67	20	68.0	21.1	70	158.0	99	210	410	371	700	1292	649	1200	2192	927	1700	3092
-6.11	21	69.8	21.7	71	159.8	100	212	413.6	377	710	1310	654	1210	2210	932	1710	3110
-5.56	22	71.6	22.2	72	161.6	104	220	428	382	720	1328	660	1220	2228	938	1720	3128
-5.00	23	73.4	22.8	73	163.4	110	230	446	388	730	1346	666	1230	2246	943	1730	3146
-4.44	24	75.2	23.3	74	165.2	116	240	464	393	740	1364	671	1240	2264	949	1740	3164
-3.89	25	77.0	23.9	75	167.0	121	250	482	399	750	1382	677	1250	2282	954	1750	3182
-3.33	26	78.8	24.4	76	168.8	127	260	500	404	760	1400	682	1260	2300	960	1760	3200
-2.78	27	80.6	25.0	77	170.6	132	270	518	410	770	1418	688	1270	2318	966	1770	3218
-2.22	28	82.4	25.6	78	172.4	138	280	536	416	780	1436	693	1280	2336	971	1780	3236
-1.67	29	84.2	26.1	79	174.2	143	290	554	421	790	1454	699	1290	2354	977	1790	3254
-1.11	30	86.0	26.7	80	176.0	149	300	572	427	800	1472	704	1300	2372	982	1800	3272
-0.56	31	87.8	27.2	81	177.8	154	310	590	432	810	1490	710	1310	2390	988	1810	3290
0	32	89.6	27.8	82	179.6	160	320	608	438	820	1508	716	1320	2408	993	1820	3308
0.56	33	91.4	28.3	83	181.4	166	330	626	443	830	1526	721	1330	2426	999	1830	3326
1.11	34	93.2	28.9	84	183.2	171	340	644	449	840	1544	727	1340	2444	1004	1840	3344
1.67	35	95.0	29.4	85	185.0	177	350	662	454	850	1562	732	1350	2462	1010	1850	3362
2.22	36	96.8	30.0	86	186.8	182	360	680	460	860	1580	738	1360	2480	1016	1860	3380
2.78	37	98.6	30.6	87	188.6	188	370	698	466	870	1598	743	1370	2498	1021	1870	3398
3.33	38	100.4	31.1	88	190.4	193	380	716	471	880	1616	749	1380	2516	1027	1880	3416
3.89	39	102.2	31.7	89	192.2	199	390	734	477	890	1634	754	1390	2534	1032	1890	3434
4.44	40	104.0	32.2	90	194.0	204	400	752	482	900	1652	760	1400	2552	1038	1900	3452
5.00	41	105.8	32.8	91	195.8	210	410	770	488	910	1670	766	1410	2570	1043	1910	3470
5.56	42	107.6	33.3	92	197.6	216	420	788	493	920	1688	771	1420	2588	1049	1920	3488
6.11	43	109.4	33.9	93	199.4	221	430	806	499	930	1706	777	1430	2606	1054	1930	3506
6.67	44	111.2	34.4	94	201.2	227	440	824	504	940	1724	782	1440	2624	1060	1940	3524
7.22	45	113.0	35.0	95	203.0	232	450	842	510	950	1742	788	1450	2642	1066	1950	3542
7.78	46	114.8	35.6	96	204.8	238	460	860	516	960	1760	793	1460	2660	1071	1960	3560
8.33	47	116.6	36.1	97	206.6	243	470	878	521	970	1778	799	1470	2678	1077	1970	3578
8.89	48	118.4	36.7	98	208.4	249	480	896	527	980	1796	804	1480	2696	1082	1980	3596
9.44	49	120.2	37.2	99	210.2	254	490	914	532	990	1814	810	1490	2714	1088	1990	3614
10.0	50	122.0	37.8	100	212.0	260	500	932	538	1000	1832	816	1500	2732	1093	2000	3632

TABLE 3.—TEMPERATURE CONVERSION TABLE.^a—(Continued)

2000 to 2250			2250 to 2500			2500 to 2750			2750 to 3000		
C		F	C		F	C		F	C		F
1093	2000	3632	1232	2250	4082	1371	2500	4532	1510	2750	4982
1099	2010	3650	1238	2260	4100	1377	2510	4550	1516	2760	5000
1104	2020	3668	1243	2270	4118	1382	2520	4568	1521	2770	5018
1110	2030	3686	1249	2280	4136	1388	2530	4586	1527	2780	5036
1116	2040	3704	1254	2290	4154	1393	2540	4604	1532	2790	5054
1121	2050	3722	1260	2300	4172	1399	2550	4622	1538	2800	5072
1127	2060	3740	1266	2310	4190	1404	2560	4640	1543	2810	5090
1132	2070	3758	1271	2320	4208	1410	2570	4658	1549	2820	5108
1138	2080	3776	1277	2330	4226	1416	2580	4676	1554	2830	5126
1143	2090	3794	1282	2340	4244	1421	2590	4694	1560	2840	5144
1149	2100	3812	1288	2350	4262	1427	2600	4712	1566	2850	5162
1154	2110	3830	1293	2360	4280	1432	2610	4730	1571	2860	5180
1160	2120	3848	1299	2370	4298	1438	2620	4748	1577	2870	5198
1166	2130	3866	1304	2380	4316	1443	2630	4766	1582	2880	5216
1171	2140	3884	1310	2390	4334	1449	2640	4784	1588	2890	5234
1177	2150	3902	1316	2400	4352	1454	2650	4802	1593	2900	5252
1182	2160	3920	1321	2410	4370	1460	2660	4820	1599	2910	5270
1188	2170	3938	1327	2420	4388	1466	2670	4838	1604	2920	5288
1193	2180	3956	1332	2430	4406	1471	2680	4856	1610	2930	5306
1199	2190	3974	1338	2440	4424	1477	2690	4874	1616	2940	5324
1204	2200	3992	1343	2450	4442	1482	2700	4892	1621	2950	5342
1210	2210	4010	1349	2460	4460	1488	2710	4910	1627	2960	5360
1216	2220	4028	1354	2470	4478	1493	2720	4928	1632	2970	5378
1221	2230	4046	1360	2480	4496	1499	2730	4946	1638	2980	5396
1227	2240	4064	1366	2490	4514	1504	2740	4964	1643	2990	5414
1232	2250	4082	1371	2500	4532	1510	2750	4982	1649	3000	5432

The numbers in boldface type refer to the temperature either in degrees centigrade or in degrees Fahrenheit which it is desired to convert into the other scale.

Example:

To convert 770°C to its Fahrenheit equivalent:

Find boldface number 770 and read the equivalent, 1418°F, in the column at the right.

To convert 770°F to its centigrade equivalent:

Find boldface number 770 and read the equivalent, 410°C, in the column at the left.

^a By Albert Sauveur, Courtesy McGraw-Hill Book Company.

INTERPOLATION FACTORS

C	F	C	F
0.56	1	1.8	3.33
1.11	2	3.6	3.89
1.67	3	5.4	4.44
2.22	4	7.2	5.00
2.78	5	9.0	5.56

6	10.8
7	12.6
8	14.4
9	16.2
10	18.0

TABLE 4.—VAPOR PRESSURE OF WATER, 30 TO 219°F

t°F	mm Hg									
	0	1	2	3	4	5	6	7	8	9
30	4.2	4.4	4.6	4.8	5.0	5.2	5.4	5.6	5.8	6.1
40	6.3	6.5	6.8	7.1	7.3	7.6	7.9	8.2	8.5	8.9
50	9.2	9.6	9.9	10.3	10.7	11.1	11.5	11.9	12.3	12.8
60	13.2	13.7	14.2	14.7	15.3	15.8	16.4	16.9	17.5	18.2
70	18.8	19.5	20.1	20.8	21.5	22.3	23.0	23.7	24.5	25.3
80	26.2	27.1	28.0	28.9	29.9	30.8	31.8	32.9	33.9	35.1
90	36.1	37.3	38.4	39.6	40.9	42.2	43.5	44.8	46.2	47.6
100	49.1	50.6	52.1	53.7	55.3	56.9	58.6	60.3	62.2	64.0
110	65.9	67.8	69.8	71.8	73.9	76.0	78.2	80.4	82.7	85.0
120	87.5	90.0	92.5	95.1	97.7	100	103	106	109	112
130	115	118	121	124	128	131	135	138	142	145
140	149	153	157	161	165	170	174	178	183	188
150	192	197	202	207	212	218	223	228	234	239
160	245	251	257	263	269	276	282	289	296	303
170	310	317	324	332	339	347	355	363	371	380
180	388	397	406	415	424	433	443	453	463	473
190	483	494	504	515	526	537	548	560	572	584
200	596	608	621	634	647	660	674	688	702	716
210	730	745	760	775	791	806	822	838	855	872

TABLE 5.—STEAM TABLES*

Temp., °F <i>t</i>	Abs press, psi <i>p</i>	Specific vol			Enthalpy			Entropy		
		Sat liquid <i>v_f</i>	Evap <i>v_{fg}</i>	Sat vapor <i>v_g</i>	Sat liquid <i>h_f</i>	Evap <i>h_{fg}</i>	Sat vapor <i>h_g</i>	Sat liquid <i>s_f</i>	Evap <i>s_{fg}</i>	Sat vapor <i>s_g</i>
32	0.08854	0.01602	3306	3306	0.00	1075.8	1075.8	0.0000	2.1877	2.1877
35	0.09993	0.01602	2947	2947	3.02	1074.1	1077.1	0.0061	2.1709	2.1770
40	0.12170	0.01602	2444	2444	8.05	1071.3	1079.3	0.0162	2.1435	2.1597
45	0.14752	0.01602	2036.4	2036.4	13.06	1068.4	1081.5	0.0262	2.1167	2.1429
50	0.17811	0.01603	1703.2	1703.2	18.07	1065.6	1083.7	0.0361	2.0903	2.1264
60	0.2563	0.01604	1206.6	1206.7	28.06	1059.9	1088.0	0.0555	2.0303	2.0948
70	0.3631	0.01606	867.8	867.9	38.04	1054.3	1092.3	0.0745	1.9902	2.0647
80	0.5069	0.01608	633.1	633.1	48.02	1048.6	1096.6	0.0932	1.9428	2.0360
90	0.6982	0.01610	468.0	468.0	57.99	1042.9	1100.9	0.1115	1.8972	2.0087
100	0.9492	0.01613	350.3	350.4	67.97	1037.2	1105.2	0.1295	1.8531	1.9826
110	1.2748	0.01617	265.3	265.4	77.94	1031.6	1109.5	0.1471	1.8106	1.9577
120	1.6924	0.01620	203.25	203.27	87.92	1025.8	1113.7	0.1645	1.7694	1.9339
130	2.2225	0.01625	157.32	157.34	97.90	1020.0	1117.9	0.1816	1.7296	1.9112
140	2.8886	0.01629	122.99	123.01	107.89	1014.1	1122.0	0.1984	1.6910	1.8904
150	3.718	0.01634	97.06	97.07	117.89	1008.2	1126.1	0.2149	1.6537	1.8685
160	4.741	0.01639	77.27	77.29	127.89	1002.3	1130.2	0.2311	1.6174	1.8485
170	5.992	0.01645	62.04	62.06	137.90	996.3	1134.2	0.2472	1.5822	1.8293
180	7.510	0.01651	50.21	50.23	147.92	990.2	1138.1	0.2630	1.5480	1.8109
190	9.339	0.01657	40.94	40.96	157.95	984.1	1142.0	0.2785	1.5147	1.7932
200	11.526	0.01663	33.62	33.64	167.99	977.9	1145.9	0.2938	1.4824	1.7762
210	14.123	0.01670	27.80	27.82	178.05	971.1	1149.7	0.3090	1.4508	1.7598
212	14.696	0.01672	26.78	26.80	180.07	970.3	1150.4	0.3120	1.4446	1.7566
220	17.186	0.01677	23.13	23.15	188.13	965.2	1153.4	0.3239	1.4201	1.7440
230	20.780	0.01684	19.365	19.382	198.23	958.8	1157.0	0.3387	1.3901	1.7288
240	24.969	0.01692	16.306	16.323	208.34	952.2	1160.5	0.3531	1.3609	1.7140
250	29.825	0.01700	13.804	13.821	218.48	945.5	1164.0	0.3675	1.3323	1.6998
260	35.429	0.01709	11.746	11.763	228.64	938.7	1167.3	0.3817	1.3043	1.6860
270	41.858	0.01717	10.044	10.061	238.84	931.8	1170.6	0.3958	1.2769	1.6727
280	49.203	0.01726	8.628	8.645	249.06	924.7	1173.8	0.4096	1.2501	1.6597
290	57.556	0.01735	7.444	7.461	259.31	917.5	1176.8	0.4234	1.2238	1.6472
300	67.013	0.01745	6.440	6.466	269.59	910.1	1179.7	0.4369	1.1980	1.6350
310	77.68	0.01755	5.609	5.626	279.92	902.6	1182.5	0.4504	1.1727	1.6231
320	89.66	0.01765	4.896	4.914	290.28	894.9	1185.2	0.4637	1.1478	1.6115
330	103.06	0.01776	4.289	4.307	300.68	887.0	1187.7	0.4769	1.1233	1.6002
340	118.01	0.01787	3.770	3.788	311.13	879.0	1190.1	0.4900	1.0992	1.5891
350	134.63	0.01799	3.324	3.342	321.63	870.7	1192.3	0.5029	1.0754	1.5783
360	153.04	0.01811	2.939	2.957	332.18	862.2	1194.4	0.5158	1.0519	1.5677
370	173.37	0.01823	2.606	2.625	342.79	853.5	1196.3	0.5286	1.0287	1.5573
380	195.77	0.01836	2.317	2.335	353.45	844.6	1198.1	0.5413	1.0059	1.5471
390	220.37	0.01850	2.0651	2.0836	364.17	835.4	1199.6	0.5539	0.9832	1.5371
400	247.31	0.01864	1.8447	1.8633	374.97	826.0	1201.0	0.5664	0.9608	1.5272
410	276.75	0.01878	1.6512	1.6700	385.83	816.3	1202.1	0.5788	0.9386	1.5174
420	308.83	0.01894	1.4811	1.5000	396.77	806.3	1203.1	0.5912	0.9166	1.5078
430	343.72	0.01910	1.3308	1.3499	407.79	796.0	1203.8	0.6035	0.8974	1.4982
440	381.59	0.01926	1.1979	1.2171	418.90	785.4	1204.3	0.6158	0.8730	1.4887
450	422.6	0.0194	1.0799	1.0993	430.1	774.5	1204.6	0.6280	0.8513	1.4793
460	466.9	0.0196	0.9748	0.9944	441.4	763.2	1204.6	0.6402	0.8298	1.4700
470	514.7	0.0198	0.8811	0.9009	452.8	751.5	1204.3	0.6523	0.8083	1.4606
480	566.1	0.0200	0.7972	0.8172	464.4	739.4	1203.7	0.6645	0.7868	1.4513
490	621.4	0.0202	0.7221	0.7423	476.0	726.8	1202.8	0.6766	0.7653	1.4419
500	680.8	0.0204	0.6545	0.6749	487.8	713.9	1201.7	0.6887	0.7438	1.4325
520	812.4	0.0209	0.5385	0.5594	511.9	686.4	1198.2	0.7130	0.7006	1.4136
540	962.5	0.0215	0.4434	0.4649	536.6	656.6	1193.2	0.7374	0.6568	1.3942
560	1133.1	0.0221	0.3647	0.3868	562.2	624.2	1186.4	0.7621	0.6121	1.3742
580	1325.7	0.0228	0.2989	0.3217	588.9	588.4	1177.3	0.7872	0.5659	1.3532
600	1542.9	0.0236	0.2432	0.2668	617.0	548.4	1165.5	0.8131	0.5176	1.3307
620	1786.6	0.0247	0.1955	0.2201	646.7	503.6	1150.3	0.8398	0.4664	1.3062
640	2059.7	0.0260	0.1538	0.1798	678.6	452.0	1130.5	0.8679	0.4110	1.2789
660	2365.4	0.0278	0.1165	0.1442	714.2	390.2	1104.4	0.8987	0.3485	1.2472
680	2708.1	0.0305	0.0810	0.1115	757.3	309.9	1067.2	0.9351	0.2719	1.2071
700	3093.7	0.0369	0.0392	0.0761	823.3	172.1	995.4	0.9905	1.1484	1.1389
705.4	3206.2	0.0503	0	0.0503	902.7	0	902.7	1.0580	0	1.0580

* Abridged from "Thermodynamic Properties of Steam" by Joseph H. Keenan and Frederick G. Keyes. Copyright, 1937, by Joseph H. Keenan and Frederick G. Keyes. Published by John Wiley & Sons, Inc., New York.

TABLE 6.—APPROXIMATE HEAD-PRESSURE EQUIVALENTS FOR MERCURY, WATER, AND KEROSENE

Psi	Oz per sq in	In. Hg	Cm Hg	Ft H ₂ O	In. H ₂ O	Cm H ₂ O	In. kerosine	Cm kerosine
0.1	1.60	0.204	0.516	0.231	2.771	7.048	3.405	8.65
0.2	3.20	0.407	1.032	0.462	5.542	14.096	6.810	17.30
0.3	4.80	0.610	1.548	0.693	8.313	21.144	10.215	25.95
0.4	6.40	0.814	2.064	0.924	11.084	28.192	13.620	34.60
0.5	8.00	1.017	2.580	1.155	13.855	35.240	17.025	43.25
0.6	9.60	1.220	3.096	1.386	16.626	42.288	20.430	51.90
0.7	11.20	1.424	3.612	1.617	19.397	49.336	23.835	60.55
0.8	12.80	1.627	4.128	1.848	22.168	56.384	27.240	69.20
0.9	14.40	1.830	4.644	2.079	24.939	63.432	30.645	77.85

TABLE 7.—PROPERTIES OF PURE CONSTITUENTS OF GASEOUS FUELS

	Mol. wt	Liquid phase					Vapor phase (dry, 30 in. Hg, 60°F)		
		NBP, °F	d_{60}^{60}	°API	Lb per gal 60°F	VP at 100°F, psia	Gross Btu per lb	Gas grav-ity ^a	Gross Btu per cu ft ^a
Hydrogen.....	2.016	-423	62,100	0.069	325
Carbon monoxide	28.0	-313	4,360	0.967	322
Methane.....	16.04	-259	23,915	0.554	1015
Acetylene.....	26.04	-119	21,570	0.907	1490
Ethylene.....	28.05	-155	21,640	0.985	1615
Ethane.....	30.07	-128	0.374	248	3.11	22,340	1.05	1790
Propylene.....	42.07	-53	0.525	138	4.37	228	21,050	1.46	2380
Propane.....	44.09	-43.8	0.508	147	4.23	189	21,680	1.55	2570
Isobutane.....	58.12	10.9	0.563	120	4.68	74	21,280	2.08	3365
Butene-1.....	56.1	21.0	0.613	99	5.11	66	20,840	2.0	3190
<i>n</i> -Butane.....	58.12	31.1	0.5843	111	4.86	52	21,330	2.14	3395
Isopentane.....	72.15	82.3	0.625	95	5.20	20.3	21,060	2.65	4280
<i>n</i> -Pentane.....	72.15	97.0	0.631	92.7	5.25	15.5	21,120	2.65	4300
Av Isohexanes...	86.17	143	0.66	83	5.49	6.0	20,800	3.3	5270
<i>n</i> -Hexane.....	86.17	155.7	0.6640	81.6	5.53	5.0	20,970	3.3	5270
Benzene.....	78.05	176.2	0.8845	28.5	7.36	3.3	18,270	2.82	3940

^a Values include gas-law deviations; deviations for hydrocarbons heavier than *n*-butane are calculated. Principal source of thermal data, National Bureau Standards, publications.

TABLE 8.—ANALYSES AND HEATING VALUES OF TYPICAL FUELS

Kind of gas	Volume %									Gross Btu per cu ft 60°	
	CO ₂	CO	H ₂	O ₂	N ₂	CH ₄	C ₂ H ₆	Illumi- nants	C ₆ H ₆		Grav
Blast furnace.....	11.5	27.5	5.0	60.0	1.0	92
Producer:											
Coke.....	3.5	30.0	10.0	0.5	54.5	135
Anthracite coal..	6.6	25.1	18.7	49.0	0.3	0.3	0.83	150
Bituminous coal..	2.5	27.0	12.0	0.3	55.3	2.5	0.4	0.87	170
Blue gas, coke.....	5.4	37.0	47.3	0.7	8.3	1.3	0.50	287
Carbureted water gas.....	4.6	29.0	33.2	0.4	10.1	14.1	8.6	0.62	545
Oil gas.....	4.4	10.2	50.7	0.5	4.3	26.0	3.9	1.3	0.45	551
Oil gas, high Btu..	24.3	58.3	17.4	0.51	943
Coal, high-temp carb.....	2.2	6.3	46.5	0.8	8.1	32.1	4.0	0.46	584
Coal, low-temp carb.....	4.0	6.1	37.2	1.0	7.8	39.6	4.3	700
Natural.....	0.8	3.2	96.0	0.57	970
Natural.....	1.3	1.2	75.5	22.0	0.73	1153
Refinery, low-temp cracking.....	1.2	6.1	0.2	0.6	4.4	72.5	15.0	1650

Kind of fuel (wt %)	As-received				Coal and coke on dry basis						Gross Btu per lb
	Moist	VM	FC	Ash	C	H	O	N	S	°API	
Penn. gasoil.....	84.3	14.1	1.6	36.8	21,240
Mid-Cont gasoil...	85.4	13.1	1.1	0.2	24.5	19,230
Mid-Cont resid....	83.2	10.2	3.7	2.8	16.7	18,430
California gasoil..	85.1	11.3	1.2	0.6	1.1	17.8	18,480
California resid....	84.0	11.3	3.0	2.1	0.9	14.9	18,370
Bituminous coal....	4.3	36.5	52.0	7.2	77.2	5.1	8.1	1.5	0.6	13,670
Anthracite coal....	2.8	1.2	88.2	7.8	84.4	1.9	4.4	0.6	0.9	13,300
High-temp coke....	3.1	2.0	86.4	8.5	0.6	13,080

TABLE 9.—POUNDS PER GALLON AND SPECIFIC GRAVITIES CORRESPONDING TO DEGREES API

°API	Tenths of degrees									
	0	1	2	3	4	5	6	7	8	9
10	8.328	8.322	8.317	8.311	8.305	8.299	8.293	8.287	8.282	8.276
	1.0000	0.9993	0.9986	0.9979	0.9972	0.9965	0.9958	0.9951	0.9944	0.9937
11	8.270	8.264	8.258	8.252	8.246	8.241	8.235	8.229	8.223	8.218
	0.9930	0.9923	0.9916	0.9909	0.9902	0.9895	0.9888	0.9881	0.9874	0.9868
12	8.212	8.206	8.201	8.195	8.189	8.183	8.178	8.172	8.166	8.161
	0.9861	0.9854	0.9847	0.9840	0.9833	0.9826	0.9820	0.9813	0.9806	0.9799
13	8.155	8.150	8.144	8.138	8.132	8.127	8.122	8.116	8.110	8.105
	0.9792	0.9786	0.9779	0.9772	0.9765	0.9759	0.9752	0.9745	0.9738	0.9732
14	8.099	8.093	8.088	8.082	8.076	8.071	8.066	8.061	8.055	8.049
	0.9725	0.9718	0.9712	0.9705	0.9698	0.9692	0.9685	0.9679	0.9672	0.9665
15	8.044	8.038	8.033	8.027	8.021	8.016	8.011	8.006	8.000	7.995
	0.9659	0.9652	0.9646	0.9639	0.9632	0.9626	0.9619	0.9613	0.9606	0.9600
16	7.989	7.984	7.978	9.973	7.967	7.962	7.956	7.951	7.946	7.940
	0.9593	0.9587	0.9580	0.9574	0.9567	0.9561	0.9554	0.9548	0.9541	0.9535
17	7.935	7.930	7.925	7.919	7.914	7.909	7.903	7.898	7.893	7.887
	0.9529	0.9522	0.9516	0.9509	0.9503	0.9497	0.9490	0.9484	0.9478	0.9471
18	7.882	7.877	7.871	7.866	7.861	7.856	7.851	7.846	7.841	7.835
	0.9465	0.9459	0.9452	0.9446	0.9440	0.9433	0.9427	0.9421	0.9415	0.9408
19	7.830	7.825	7.820	7.814	7.809	7.804	7.799	7.793	7.788	7.783
	0.9402	0.9396	0.9390	0.9383	0.9377	0.9371	0.9365	0.9358	0.9352	0.9346
20	7.778	7.773	7.768	7.762	7.757	7.752	7.747	7.742	7.737	7.732
	0.9340	0.9334	0.9328	0.9321	0.9315	0.9309	0.9303	0.9297	0.9291	0.9285
21	7.727	7.722	7.717	7.711	7.706	7.701	7.696	7.691	7.686	7.681
	0.9279	0.9273	0.9267	0.9260	0.9254	0.9248	0.9242	0.9236	0.9230	0.9224
22	7.676	7.671	7.666	7.661	7.656	7.651	7.646	7.641	7.636	7.632
	0.9218	0.9212	0.9206	0.9200	0.9194	0.9188	0.9182	0.9176	0.9170	0.9165
23	7.627	7.622	7.617	7.612	7.607	7.602	7.597	7.592	7.587	7.583
	0.9159	0.9153	0.9147	0.9141	0.9135	0.9129	0.9123	0.9117	0.9111	0.9106
24	7.578	7.573	7.568	7.563	7.558	7.554	7.549	7.544	7.539	7.534
	0.9100	0.9094	0.9088	0.9082	0.9076	0.9071	0.9065	0.9059	0.9053	0.9047
25	7.529	7.524	7.519	7.514	7.509	7.505	7.500	7.495	7.491	7.486
	0.9042	0.9036	0.9030	0.9024	0.9018	0.9013	0.9007	0.9001	0.8996	0.8990
26	7.481	7.476	7.472	7.467	7.462	7.458	7.453	7.448	7.443	7.438
	0.8984	0.8978	0.8973	0.8967	0.8961	0.8956	0.8950	0.8944	0.8939	0.8933
27	7.434	7.429	7.424	7.420	7.415	7.410	7.406	7.401	7.397	7.392
	0.8927	0.8922	0.8916	0.8911	0.8905	0.8899	0.8894	0.8888	0.8883	0.8877
28	7.387	7.383	7.378	7.373	7.368	7.364	7.360	7.355	7.351	7.346
	0.8871	0.8866	0.8860	0.8855	0.8849	0.8844	0.8838	0.8833	0.8827	0.8822
29	7.341	7.337	7.332	7.328	7.323	7.318	7.314	7.309	7.305	7.300
	0.8816	0.8811	0.8805	0.8800	0.8794	0.8789	0.8783	0.8778	0.8772	0.8767
30	7.296	7.291	7.287	7.282	7.278	7.273	7.268	7.264	7.259	7.255
	0.8762	0.8756	0.8751	0.8745	0.8740	0.8735	0.8729	0.8724	0.8718	0.8713

TABLE 9.—POUNDS PER GALLON AND SPECIFIC GRAVITIES CORRESPONDING TO DEGREES API.—(Continued)

°API	Tenths of degrees									
	0	1	2	3	4	5	6	7	8	9
31	7.251	7.246	7.242	7.238	7.233	7.228	7.224	7.219	7.215	7.211
	0.8708	0.8702	0.8697	0.8692	0.8686	0.8681	0.8676	0.8670	0.8665	0.8660
32	7.206	7.202	7.198	7.193	7.188	7.184	7.180	7.176	7.171	7.167
	0.8654	0.8649	0.8644	0.8639	0.8633	0.8628	0.8623	0.8618	0.8612	0.8607
33	7.163	7.158	7.153	7.149	7.145	7.141	7.137	7.132	7.128	7.123
	0.8602	0.8597	0.8591	0.8586	0.8581	0.8576	0.8571	0.8565	0.8560	0.8555
34	7.119	7.115	7.111	7.106	7.102	7.098	7.093	7.089	7.085	7.081
	0.8550	0.8545	0.8540	0.8534	0.8529	0.8524	0.8519	0.8514	0.8509	0.8504
35	7.076	7.072	7.068	7.063	7.059	7.055	7.051	0.047	7.042	7.038
	0.8498	0.8493	0.8488	0.8483	0.8478	0.8473	0.8468	0.8463	0.8458	0.8453
36	7.034	7.030	7.026	7.022	7.018	7.013	7.009	7.005	7.001	6.997
	0.8448	0.8443	0.8438	0.8433	0.8428	0.8423	0.8418	0.8413	0.8408	0.8403
37	6.993	6.989	6.985	6.980	6.976	6.972	6.968	6.964	9.960	6.955
	0.8398	0.8393	0.8388	0.8383	0.8378	0.8373	0.8368	0.8363	0.8358	0.8353
38	6.951	6.947	6.943	6.939	6.935	6.930	6.926	6.922	6.918	6.914
	0.8348	0.8343	0.8338	0.8333	0.8328	0.8324	0.8319	0.8314	0.8309	0.8304
39	6.910	6.906	6.902	6.898	6.894	6.890	6.886	6.882	6.878	6.874
	0.8299	0.8294	0.8289	0.8285	0.8280	0.8275	0.8270	0.8265	0.8260	0.8256
40	6.870	6.866	6.862	6.858	6.854	6.850	6.846	6.842	6.838	6.834
	0.8251	0.8246	0.8241	0.8236	0.8232	0.8227	0.8222	0.8217	0.8212	0.8208
41	6.830	6.826	6.822	6.818	6.814	6.810	6.806	6.802	6.798	6.794
	0.8203	0.8198	0.8193	0.8189	0.8184	0.8179	0.8174	0.8170	0.8165	0.8160
42	6.790	6.786	6.782	6.779	6.775	6.771	6.767	6.763	6.759	6.756
	0.8155	0.8151	0.8146	0.8142	0.8137	0.8132	0.8128	0.8123	0.8118	0.8114
43	6.752	6.748	6.744	6.740	6.736	6.732	6.728	6.724	6.720	6.716
	0.8109	0.8104	0.8100	0.8095	0.8090	0.8086	0.8081	0.8076	0.8072	0.8067
44	6.713	6.709	6.705	6.701	6.697	6.694	6.690	6.686	6.682	6.679
	0.8063	0.8058	0.8054	0.8049	0.8044	0.8040	0.8035	0.8031	0.8026	0.8022
45	6.675	6.671	6.667	6.663	6.660	6.656	6.652	6.648	6.645	6.641
	0.8017	0.8012	0.8008	0.8003	0.7999	0.7994	0.7990	0.7985	0.7981	0.7976
46	6.637	6.633	6.630	6.626	6.622	6.618	6.615	6.611	6.607	6.604
	0.7972	0.7967	0.7963	0.7958	0.7954	0.7949	0.7945	0.7941	0.7936	0.7932
47	6.600	6.596	6.592	6.589	6.585	6.582	6.578	6.574	6.571	6.567
	0.7927	0.7923	0.7918	0.7914	0.7909	0.7905	0.7901	0.7896	0.7892	0.7887
48	6.563	6.560	6.556	6.552	6.548	6.545	6.541	6.537	6.534	6.530
	0.7883	0.7879	0.7874	0.7870	0.7865	0.7861	0.7857	0.7852	0.7848	0.7844
49	6.526	6.523	6.520	6.516	6.512	6.509	6.505	6.501	6.498	6.494
	0.7839	0.7835	0.7831	0.7826	0.7822	0.7818	0.7813	0.7809	0.7805	0.7800
50	6.490	6.487	6.484	6.480	6.476	6.473	6.469	6.466	6.462	6.459
	0.7796	0.7792	0.7788	0.7783	0.7779	0.7775	0.7770	0.7766	0.7762	0.7758

TABLE 9.—POUNDS PER GALLON AND SPECIFIC GRAVITIES CORRESPONDING TO DEGREES API.—(Continued)

°API	Tenths of degrees									
	0	1	2	3	4	5	6	7	8	9
51	6.455	6.451	6.448	6.445	6.441	6.437	6.434	6.430	6.427	6.423
	0.7753	0.7749	0.7745	0.7741	0.7736	0.7732	0.7728	0.7724	0.7720	0.7715
52	6.420	6.416	6.413	6.410	6.406	6.402	6.399	6.396	6.392	6.389
	0.7711	0.7707	0.7703	0.7699	0.7694	0.7690	0.7686	0.7682	0.7678	0.7674
53	6.385	6.381	6.378	6.375	6.371	6.368	6.365	6.361	6.357	6.354
	0.7669	0.7665	0.7661	0.7657	0.7653	0.7649	0.7645	0.7640	0.7636	0.7632
54	6.350	6.347	6.344	6.340	6.337	6.334	6.330	6.326	6.323	6.320
	0.7628	0.7624	0.7620	0.7616	0.7612	0.7608	0.7603	0.7599	0.7595	0.7591
55	6.316	6.313	6.310	6.306	6.303	6.300	6.296	6.293	6.290	6.287
	0.7587	0.7583	0.7579	0.7575	0.7571	0.7567	0.7563	0.7559	0.7555	0.7551
56	6.283	6.280	6.276	6.273	6.270	6.266	6.263	6.259	6.256	6.253
	0.7547	0.7543	0.7539	0.7535	0.7531	0.7527	0.7523	0.7519	0.7515	0.7511
57	6.249	6.246	6.243	6.240	6.236	6.233	6.229	6.226	6.223	6.219
	0.7507	0.7503	0.7499	0.7495	0.7491	0.7487	0.7483	0.7479	0.7475	0.7471
58	6.216	6.213	6.209	6.206	6.203	6.199	6.196	6.193	6.190	6.187
	0.7467	0.7463	0.7459	0.7455	0.7451	0.7447	0.7443	0.7440	0.7436	0.7432
59	6.184	6.180	6.177	6.174	6.170	6.167	6.164	6.161	6.158	6.154
	0.7428	0.7424	0.7420	0.7416	0.7412	0.7408	0.7405	0.7401	0.7397	0.7393
60	6.151	6.148	6.141	6.141	6.138	6.135	6.132	6.129	6.125	6.122
	0.7389	0.7385	0.7381	0.7377	0.7374	0.7370	0.7366	0.7362	0.7358	0.7354
61	6.119	6.116	6.113	6.109	6.106	6.103	6.100	6.097	6.094	6.090
	0.7351	0.7347	0.7343	0.7339	0.7335	0.7332	0.7328	0.7324	0.7320	0.7316
62	6.087	6.084	6.081	6.078	6.075	6.072	6.068	6.065	6.062	6.059
	0.7313	0.7309	0.7305	0.7301	0.7298	0.7294	0.7290	0.7286	0.7283	0.7279
63	6.056	6.053	6.050	6.047	6.044	6.040	6.037	6.034	6.031	6.028
	0.7275	0.7271	0.7268	0.7264	0.7260	0.7256	0.7253	0.7249	0.7245	0.7242
64	6.025	6.022	6.019	6.016	6.013	6.010	6.007	6.004	6.000	5.997
	0.7238	0.7234	0.7230	0.7227	0.7223	0.7219	0.7216	0.7212	0.7208	0.7205
65	5.994	5.991	5.988	5.985	5.982	5.979	5.976	5.973	5.970	5.967
	0.7201	0.7197	0.7194	0.7190	0.7186	0.7183	0.7179	0.7175	0.7172	0.7168
66	5.964	5.961	5.958	5.955	5.952	5.949	5.946	5.943	5.940	5.937
	0.7165	0.7161	0.7157	0.7154	0.7150	0.7146	0.7143	0.7139	0.7136	0.7132
67	5.934	5.931	5.928	5.925	5.922	5.919	5.916	5.913	5.910	5.907
	0.7128	0.7125	0.7121	0.7118	0.7114	0.7111	0.7107	0.7103	0.7100	0.7096
68	5.904	5.901	5.898	5.895	5.892	5.889	5.886	5.883	5.880	5.877
	0.7093	0.7089	0.7086	0.7082	0.7079	0.7075	0.7071	0.7068	0.7064	0.7061
69	5.874	5.871	5.868	5.866	5.863	5.860	5.857	5.854	5.851	5.848
	0.7057	0.7054	0.7050	0.7047	0.7043	0.7040	0.7036	0.7033	0.7029	0.7026
70	5.845	5.842	5.839	5.836	5.833	5.831	5.828	5.825	5.823	5.820
	0.7022	0.7019	0.7015	0.7012	0.7008	0.7005	0.7001	0.6998	0.6995	0.6991

TABLE 9.—POUNDS PER GALLON AND SPECIFIC GRAVITIES CORRESPONDING TO DEGREES API.—(Continued)

°API	Tenths of degrees									
	0	1	2	3	4	5	6	7	8	9
71	5.817	5.814	5.811	5.808	5.805	5.802	5.799	5.796	5.793	5.791
	0.6988	0.6984	0.6981	0.6977	0.6974	0.6970	0.6967	0.6964	0.6960	0.6957
72	5.788	5.785	5.782	5.779	5.776	5.773	5.771	5.768	5.765	5.762
	0.6953	0.6950	0.6946	0.6943	0.6940	0.6936	0.6933	0.6929	0.6926	0.6923
73	5.759	5.757	5.754	5.751	5.748	5.745	5.743	5.740	5.737	5.734
	0.6919	0.6916	0.6913	0.6909	0.6906	0.6902	0.6899	0.6896	0.6892	0.6889
74	5.731	5.728	5.726	5.723	5.720	5.718	5.715	5.712	5.709	5.706
	0.6886	0.6882	0.6879	0.6876	0.6872	0.6869	0.6866	0.6862	0.6859	0.6856
75	5.703	5.701	5.698	5.695	5.693	5.690	5.687	5.685	5.682	5.679
	0.6852	0.6849	0.6846	0.6842	0.6839	0.6836	0.6832	0.6829	0.6826	0.6823
76	5.676	5.673	5.671	5.668	5.665	5.662	5.660	5.657	5.654	5.652
	0.6819	0.6816	0.6813	0.6809	0.6806	0.6803	0.6800	0.6796	0.6793	0.6790
77	5.649	5.646	5.643	5.641	5.638	5.635	5.632	5.630	5.627	5.624
	0.6787	0.6783	0.6780	0.6777	0.6774	0.6770	0.6767	0.6764	0.6761	0.6757
78	5.622	5.619	5.617	5.614	5.611	5.608	5.606	5.603	5.600	5.598
	0.6754	0.6751	0.6748	0.6745	0.6741	0.6738	0.6735	0.6732	0.6728	0.6725
79	5.595	5.592	5.590	5.587	5.584	5.582	5.579	5.577	5.574	5.571
	0.6722	0.6719	0.6716	0.6713	0.6709	0.6706	0.6703	0.6700	0.6697	0.6693
80	5.568	5.566	5.563	5.561	5.558	5.556	5.553	5.550	5.548	5.545
	0.6690	0.6687	0.6684	0.6681	0.6678	0.6675	0.6671	0.6668	0.6665	0.6662
81	5.542	5.540	5.537	5.534	5.532	5.529	5.526	5.524	5.522	5.519
	0.6659	0.6656	0.6653	0.6649	0.6646	0.6643	0.6640	0.6637	0.6634	0.6631
82	5.516	5.514	5.511	5.508	5.506	5.503	5.501	9.498	5.496	5.493
	0.6628	0.6625	0.6621	0.6618	0.6615	0.6612	0.6609	0.6606	0.6603	0.6600
83	5.491	5.489	5.486	5.483	5.480	5.477	5.475	5.472	5.470	5.467
	0.6597	0.6594	0.6591	0.6588	0.6584	0.6581	0.6578	0.6575	0.6572	0.6569
84	5.465	5.462	5.460	5.458	5.455	5.453	5.450	5.448	5.445	5.443
	0.6566	0.6563	0.6560	0.6557	0.6554	0.6551	0.6548	0.6545	0.6542	0.6539
85	5.440	5.437	5.435	5.432	5.430	5.427	5.425	5.422	5.420	5.417
	0.6536	0.6533	0.6530	0.6527	0.6524	0.6521	0.6518	0.6515	0.6512	0.6509
86	5.415	5.412	5.410	5.407	5.405	5.402	5.400	5.397	5.395	5.392
	0.6506	0.6503	0.6500	0.6497	0.6494	0.6491	0.6488	0.6485	0.6482	0.6479
87	5.390	5.387	5.385	5.382	5.380	5.377	5.375	5.372	5.370	5.367
	0.6476	0.6473	0.6470	0.6467	0.6464	0.6461	0.6458	0.6455	0.6452	0.6449
88	5.365	5.363	5.361	5.358	5.356	5.353	5.351	5.348	5.346	5.343
	0.6446	0.6444	0.6441	0.6438	0.6435	0.6432	0.6429	0.6426	0.6423	0.6420
89	5.341	5.338	5.336	5.334	5.331	5.329	5.326	5.324	5.321	5.319
	0.6417	0.6414	0.6411	0.6409	0.6406	0.6403	0.6400	0.6397	0.6394	0.6391
90	5.316	5.314	5.312	5.310	5.307	5.305	5.302	5.300	5.297	5.295
	0.6388	0.6385	0.6382	0.6380	0.6377	0.6374	0.6371	0.6368	0.6365	0.6362

TABLE 9.—POUNDS PER GALLON AND SPECIFIC GRAVITIES CORRESPONDING TO DEGREES API.—(Continued)

°API	Tenths of degrees									
	0	1	2	3	4	5	6	7	8	9
91	5.293	5.291	5.288	5.286	5.283	5.281	5.278	5.276	5.274	5.271
	0.6360	0.6357	0.6354	0.6351	0.6348	0.6345	0.6342	0.6340	0.6337	0.6334
92	5.269	5.266	5.264	5.262	5.260	5.257	5.254	5.252	5.250	5.248
	0.6331	0.6328	0.6325	0.6323	0.6320	0.6317	0.6314	0.6311	0.6309	0.6306
93	5.246	5.243	5.240	5.238	5.236	5.234	5.232	5.229	5.227	5.225
	0.6303	0.6300	0.6297	0.6294	0.6292	0.6289	0.6286	0.6283	0.6281	0.6278
94	5.222	5.220	5.217	5.215	5.213	5.210	5.208	5.206	5.204	5.201
	0.6275	0.6272	0.6269	0.6267	0.6264	0.6261	0.6258	0.6256	0.6253	0.6250
95	5.199	5.196	5.194	5.192	5.190	5.187	5.185	5.183	5.180	5.179
	0.6247	0.6244	0.6242	0.6239	0.6236	0.6233	0.6231	0.6228	0.6225	0.6223
96	5.176	5.174	5.172	5.170	5.167	5.164	5.162	5.160	5.158	5.156
	0.6220	0.6217	0.6214	0.6212	0.6209	0.6206	0.6203	0.6201	0.6198	0.6195
97	5.154	5.151	5.149	5.146	5.144	5.142	5.140	5.138	5.136	5.133
	0.6193	0.6190	0.6187	0.6184	0.6182	0.6179	0.6176	0.6174	0.6171	0.6168
98	5.131	5.129	5.126	5.124	5.122	5.120	5.118	5.116	5.113	5.111
	0.6166	0.6163	0.6160	0.6158	0.6155	0.6152	0.6150	0.6147	0.6144	0.6141
99	5.109	5.107	5.105	5.012	5.100	5.098	5.096	5.093	5.091	5.089
	0.6139	0.6136	0.6134	0.6131	0.6128	0.6126	0.6123	0.6120	0.6118	0.6115
100	5.086									
	0.6112									

TABLE 10.—TEMPERATURE COEFFICIENTS OF EXPANSION OF PETROLEUM OILS*

Group No.	Coefficient of expansion per °F at 60°F	Gravity, °API	Gravity range of group (°API at 60°F)
0	0.00035	6	Up to 14.9
1	0.00040	22	15.0- 34.9
2	0.00050	44	35.0- 50.9
3	0.00060	58	51.0- 63.9
4	0.00070	72	64.0- 78.9
5	0.00080	86	79.0- 88.9
6	0.00085	91	89.0- 93.9
7	0.00090	97	94.0-100.0

* ASTM abridgment.

B.—VALUES FOR CONVERTING KINEMATIC VISCOSITY TO SAYBOLT FUROL VISCOSITY
AT 122° F

Kinematic viscosity, centistokes	Saybolt Furol viscosity, sec	Kinematic viscosity, centistokes	Saybolt Furol viscosity, sec	Kinematic viscosity, centistokes	Saybolt Furol viscosity, sec
48	25.2	100	48.5	200	94.7
50	26.0	105	50.8	210	99.3
52	26.9	110	53.1	220	104.0
54	27.8	115	55.3	230	108.7
56	28.7	120	57.6	240	113.3
58	29.6	125	59.9	250	118.0
60	30.5	130	62.2	260	122.7
62	31.4	135	64.5	270	127.4
64	32.3	140	66.9	280	132.0
66	33.2	145	69.2	290	136.7
68	34.1	150	71.5	300	141.3
70	35.0	155	73.8	310	146.0
72	35.9	160	76.1	320	150.7
74	36.8	165	78.4	330	155.4
76	37.7	170	80.7	340	160.1
78	38.6	175	83.1	350	164.8
80	39.5	180	85.4	360	169.5
82	40.4	185	87.7	370	174.1
84	41.3	190	90.0	380	178.8
86	42.2	195	92.4	390	183.5
88	43.1			400	188.2
90	44.0				
92	44.9				
94	45.8				
96	46.7				
98	47.6				

Over } Saybolt sec = centi-
400.. } stokes × 0.470

¹ Courtesy ASTM.

TABLE 12.—STANDARD WROUGHT-IRON AND STEEL PIPE DATA

Diam, in.			Weight per ft, lb	Diam, in.			Weight per ft, lb
Nominal	External	Internal		Nominal	External	Internal	
Black or galvanized standard weight pipe							
$\frac{1}{8}$	0.405	0.0269	0.244	6	6.625	6.065	18.974
$\frac{1}{4}$	0.540	0.364	0.424	7	7.625	7.023	23.544
$\frac{3}{8}$	0.675	0.493	0.567	8	8.625	8.071	24.696
$\frac{1}{2}$	0.840	0.622	0.850	9	9.625	8.941	33.907
$\frac{3}{4}$	1.050	0.824	1.130	10	10.750	10.192	31.201
1	1.315	1.049	1.678	10	10.750	10.020	40.483
$1\frac{1}{4}$	1.660	1.380	2.272	11	11.750	11.000	45.557
$1\frac{1}{2}$	1.900	1.610	2.717	12	12.750	12.090	43.773
2	2.375	2.067	3.652	12	12.750	12.000	49.562
$2\frac{1}{2}$	2.875	2.469	5.793	13	14.000	13.250	54.568
3	3.500	3.068	7.575	14	15.000	14.250	58.573
$3\frac{1}{2}$	4.000	3.548	9.109	15	16.000	15.250	62.579
4	4.500	4.026	10.790				
$4\frac{1}{2}$	5.000	4.506	12.538				
5	5.563	5.047	14.617				
Standard extra-strong pipe							
$\frac{1}{8}$	0.405	0.215	0.314	3	3.500	2.900	10.252
$\frac{1}{4}$	0.540	0.302	0.535	$3\frac{1}{2}$	4.000	3.364	12.505
$\frac{3}{8}$	0.675	0.423	0.738	4	4.500	3.826	14.983
$\frac{1}{2}$	0.840	0.546	1.087	$4\frac{1}{2}$	5.000	4.290	17.611
$\frac{3}{4}$	1.050	0.742	1.473	5	5.563	4.813	20.778
1	1.315	0.957	2.171	6	6.625	5.761	28.573
$1\frac{1}{4}$	1.660	1.278	2.996	7	7.625	6.625	38.048
$1\frac{1}{2}$	1.900	1.500	3.631	8	8.625	7.625	43.388
2	2.375	1.939	5.022	9	9.625	8.625	48.728
$2\frac{1}{2}$	2.875	2.323	7.661	10	10.750	9.750	54.735
				11	11.750	10.750	60.075
				12	12.750	11.750	65.415
Standard double extra-strong pipe							
$\frac{3}{4}$	1.050	0.434	2.440	3	3.500	2.300	18.583
1	1.315	0.599	3.659	$3\frac{1}{2}$	4.000	2.728	22.850
$1\frac{1}{4}$	1.660	0.896	5.214	4	4.500	3.152	27.541
$1\frac{1}{2}$	1.900	1.100	6.408	$4\frac{1}{2}$	5.000	3.580	32.530
2	2.375	1.503	9.029	5	5.563	4.063	38.552
$2\frac{1}{2}$	2.875	1.771	13.695	6	6.625	4.897	53.160
				7	7.625	5.875	62.079
				8	8.625	6.875	72.424

TABLE 13.—STANDARD CONDENSER-TUBE DATA*

OD, in.	Size number, BWG	Weight lb per ft ^b	Wall thick- ness, in.	ID, in.	Surface, sq ft per ft of length		Inside cross- sectional area, sq in.	Velocity, (ft per sec) for one U.S. gal per min	Capacity at 1 ft per sec velocity	
					Outside	Inside			U.S. gal per min	Lb water per hr
½	12	0.498	0.109	0.282	0.1309	1.0748	0.0624	5.142	0.1945	97.25
	14	0.403	0.083	0.334	0.1309	0.0874	0.0876	3.662	0.2730	136.5
	16	0.329	0.065	0.370	0.1309	0.0969	0.1076	2.981	0.3352	167.5
	18	0.258	0.049	0.402	0.1309	0.1052	0.1269	2.530	0.3952	197.6
	20	0.190	0.035	0.430	0.1309	0.1125	0.1452	2.209	0.4528	226.4
⅝	12	0.656	0.109	0.407	0.1636	0.1066	0.1301	2.468	0.4053	202.7
	14	0.526	0.083	0.459	0.1636	0.1202	0.1655	1.939	0.5157	258.9
	16	0.424	0.065	0.495	0.1636	0.1296	0.1927	1.667	0.5999	300.0
	18	0.329	0.049	0.527	0.1636	0.1380	0.2181	1.472	0.6793	339.7
	20	0.241	0.035	0.555	0.1636	0.1453	0.2420	1.326	0.7542	377.1
¾	10	0.962	0.134	0.482	0.1963	0.1262	0.1825	1.758	0.5688	284.4
	12	0.812	0.109	0.532	0.1963	0.1393	0.2223	1.442	0.6935	346.8
	14	0.644	0.083	0.584	0.1963	0.1528	0.2678	1.198	0.8347	417.4
	16	0.518	0.065	0.620	0.1963	0.1613	0.3019	1.063	0.9407	470.4
	18	0.400	0.049	0.652	0.1963	0.1706	0.3339	0.9611	1.041	520.5
⅞	10	1.16	0.134	0.607	0.2291	0.1589	0.2893	1.108	0.9025	451.3
	12	0.992	0.109	0.657	0.2291	0.1720	0.3390	0.9465	1.057	528.5
	14	0.769	0.083	0.709	0.2291	0.1856	0.3949	0.8126	1.230	615.0
	16	0.613	0.065	0.745	0.2291	0.1951	0.4360	0.7360	1.358	679.0
	18	0.472	0.049	0.777	0.2291	0.2034	0.4740	0.6770	1.477	738.5
1	10	1.35	0.134	0.732	0.2618	0.1916	0.4208	0.7626	1.311	655.5
	12	1.14	0.109	0.782	0.2618	0.2048	0.4803	0.6681	1.497	748.5
	14	0.887	0.083	0.834	0.2618	0.2183	0.5463	0.5874	1.702	851.0
	16	0.708	0.065	0.870	0.2618	0.2277	0.5945	0.5398	1.852	926.0
	18	0.535	0.049	0.902	0.2618	0.2361	0.6390	0.5022	1.991	995.5
1¼	10	1.74	0.134	0.982	0.3271	0.2572	0.7575	0.4236	2.362	1181
	12	1.45	0.109	1.032	0.3271	0.2701	0.8369	0.3834	2.608	1304
	14	1.13	0.083	1.084	0.3271	0.2839	0.9229	0.3477	2.877	1439
	16	0.898	0.065	1.120	0.3271	0.2932	0.9852	0.3257	3.070	1535
	18	0.675	0.049	1.152	0.3271	0.3015	1.043	0.3075	3.253	1627
1½	10	2.12	0.134	1.232	0.3925	0.3227	1.193	0.2688	3.720	1860
	12	1.76	0.109	1.282	0.3925	0.3355	1.292	0.2482	4.030	2015
	14	1.36	0.083	1.334	0.3925	0.3491	1.398	0.2292	4.362	2181
	16	1.09	0.065	1.370	0.3925	0.3588	1.473	0.2180	4.587	2294
	2	10	2.94	0.134	1.732	0.5233	0.4534	2.355	0.1362	7.342
12		2.40	0.109	1.782	0.5233	0.4665	2.494	0.1287	7.770	3885
14		1.85	0.083	1.834	0.5233	0.4803	2.643	0.1213	8.244	4122
16		1.47	0.065	1.870	0.5233	0.4896	2.747	0.1168	8.562	4281

* Prepared by T. B. Drew. Reproduced by permission from Walker, Lewis, McAdams, and Gilliland, "Principles of Chemical Engineering," p. 693, McGraw-Hill Book Company, Inc., New York, 1937.

^b In brass, sp gr = 8.56.

TABLE 14.—THERMAL CONDUCTIVITIES OF METALS AND ALLOYS*
 [Values of k in Btu/(hr)(sq ft)(°F per ft)]

$t^{\circ}\text{F}$	32	64	212	392	572	752	932	1112	Melting point, °C
$t^{\circ}\text{C}$	0	17.8	100	200	300	400	500	600	
Aluminum.....	117	119	124	133	144	155	659
Brass (70-30).....	56	60	63	66	67	940
Cast iron.....	29	28	1200
Cast iron, high silica.....	30	1260
Copper, pure.....	224	218	215	212	210	207	204	1080
Iron:									
Pure.....		39.0	36.6						
Wrought.....		34.9	34.6						
Lead.....	20	20	19	18	327
Nickel.....	36	34	33	32	1450
Nickel alloys:									
Constantan (60 Cu, 40 Ni).....		13.1	15.5						
Nickel silver.....		16.9	21.5						
Manganin (84 Cu, 4 Ni, 12 Mn).....		12.8	15.2						
Silver.....	242	238	960
Steel, mild.....		26	26	25	23	22	21	
Tantalum (at 18°C).....	32	2900
Tin.....	36	34	33	231
Wrought iron, Swedish.....		32	30	28	26	23	
Zinc.....	65	64	62	59	54	419

* Reproduced by permission from "Chemical Engineers' Handbook," McGraw-Hill Book Company, Inc., New York, 1941.

TABLE 15.—THERMAL CONDUCTIVITIES OF SOME BUILDING AND INSULATING MATERIALS*

[Values of k in Btu/(hr)(sq ft)(°F per ft)]

Material	Apparent density ρ , lb per cu ft at room temp	t , °C	k
Aerogel, silica, opacified.....	8.5	120	0.013
		290	0.026
Asbestos-cement boards.....	120	20	0.43
Asbestos sheets.....	55.5	51	0.096
Asbestos slate.....	112	0	0.087
Asbestos.....	112	60	0.114
	29.3	-200	0.043
	29.3	0	0.090
	36	0	0.087
	36	100	0.111
	36	200	0.120
	36	400	0.129
	43.5	-200	0.090
Aluminum foil (7 air spaces per 2.5 in.).....	0.2	38	0.025
		177	0.038
Ashes, wood.....		0-100	0.041
Asphalt.....	132	20	0.43
Bricks:			
Alumina (92-99 % Al ₂ O ₃ by wt) fused.....		427	1.8
Alumina (64-65 % Al ₂ O ₃ by wt).....		1315	2.7
Fireclay.....	115	800	0.62
Building brickwork.....	115	1100	0.63
		20	0.4
		200	0.67
Chrome brick (32 % Cr ₂ O ₃ by wt).....	200	200	0.85
Diatomaceous earth, natural, across strata.....	27.7	650	1.0
		1315	0.051
		204	0.077
Diatomaceous, natural, parallel to strata.....	27.7	871	0.077
		204	0.081
		871	0.106
Diatomaceous earth, molded and fired.....	38	204	0.14
		871	0.18
Diatomaceous earth and clay, molded and fired.....	42.3	204	0.14
		871	0.19
Diatomaceous earth, high burn, large pores.....	37	200	0.13
		1000	0.34
Fireclay (Missouri).....		200	0.58
		600	0.85
		1000	0.95
		1400	1.02
Kaolin insulating brick.....	27	500	0.15
		1150	0.26
Kaolin insulating firebrick.....	19	200	0.050
		700	0.113
Magnesite (86.8 % MgO, 6.3 % Fe ₂ O ₃ , 3 % CaO, 2.6 % SiO ₂ by wt).....	158	204	2.2
		650	1.6
		1200	1.1
Silicon carbide brick, recrystallized.....	129	600	10.7
		800	9.2
		1200	8.0
		1200	7.0
		1400	6.3

* MARKS, "Mechanical Engineers' Handbook," McGraw-Hill Book Company, Inc., New York, 1941. "International Critical Tables," McGraw-Hill Book Company, Inc., New York, 1929, and other sources.

TABLE 16.—THERMAL CONDUCTIVITIES OF SOME LIQUIDS AND GASES^a
 [Values of k in Btu/(hr)(sq ft)(°F per ft)]

	$t^{\circ}\text{F}$	k
Benzene.....	86	0.092
	140	0.087
Petroleum oils (av values).....	60	0.085
	212	0.078
Water.....	32	0.330
	86	0.356
	140	0.381
	176	0.398
Air.....	32	0.0140
	212	0.0183
	392	0.0226
Carbon dioxide.....	572	0.0265
	32	0.0085
	212	0.0133
	392	0.0181
Nitrogen.....	572	0.0228
	32	0.0140
	122	0.0160
Oxygen.....	212	0.0180
	32	0.0142
	122	0.0164
Water vapor.....	212	0.0185
	115	0.0120
	212	0.0137
	392	0.0187
	572	0.0248
	752	0.0315
	932	0.0441

^a Abstracted by permission from "Chemical Engineers' Handbook," McGraw-Hill Book Company, Inc., New York, 1941.

TABLE 17.—TABLE OF EMISSIVITIES^a
(Normal, total)

Surface	t°F	Emissivity
A. Metals and their oxides		
Aluminum:		
Highly polished plate, 98.3% pure.....	440-1070	0.039-0.057
Polished plate.....	73	0.040
Rough plate.....	78	0.055
Oxidized at 1110°F.....	390-1110	0.11-0.19
Al-surfaced roofing.....	100	0.216
Calorized surfaces, heated at 1110°F:		
Copper.....	390-1110	0.18-0.19
Steel.....	390-1110	0.52-0.57
Brass:		
Highly polished:		
73.2% Cu, 26.7% Zn.....	476-674	0.028-0.031
62.4% Cu, 36.8% Zn, 0.4% Pb, 0.3% Al.....	494-710	0.033-0.037
82.9% Cu, 17.0% Zn.....	530	0.030
Hard-rolled, polished:		
Direction of polishing visible.....	70	0.038
Somewhat attacked.....	73	0.043
Traces of stearin from polish left on.....	75	0.053
Polished.....	100-600	0.096-0.096
Rolled plate:		
Natural surface.....	72	0.06
Coarse emery rubbed.....	72	0.20
Dull plate.....	120-660	0.22
Oxidized by heating at 1110°F.....	390-1110	0.61-0.59
Copper:		
Carefully polished electrolytic.....	176	0.018
Comm'l, emiered, polished (pittéd).....	66	0.030
Comm'l, scraped shiny.....	72	0.072
Polished.....	242	0.023
Heated plate with thick oxide layer.....	77	0.78
Plate heated at 1110°F.....	390-1110	0.57-0.57
Cuprous oxide.....	1470-2010	0.66-0.54
Molten copper.....	1970-2330	0.16-0.13
Iron and steel:		
Metallic surfaces:		
Electrolytic iron, high polish.....	350-440	0.052-0.064
Polished iron.....	800-1880	0.144-0.377
Iron freshly emiered.....	68	0.242
Cast iron, polished.....	392	0.21
Wrought iron, high polish.....	100-480	0.28
Cast iron, newly turned.....	72	0.435
Polished steel casting.....	1420-1900	0.52-0.56
Ground sheet steel.....	1720-2010	0.55-0.61
Smooth sheet iron.....	1650-1900	0.55-0.60
Cast iron, turned on lathe.....	1620-1810	0.60-0.70

TABLE 17.—TABLE OF EMISSIVITIES.^a—(Continued)

Surface	t°F	Emissivity
Oxidized surfaces:		
Iron plate:		
Pickled, rusted red.....	68	0.612
Completely rusted.....	67	0.685
Rolled sheet steel.....	70	0.657
Oxidized iron.....	212	0.736
Cast iron, oxidized at 1100°F.....	390-1110	0.64-0.78
Steel, oxidized at 1100°F.....	390-1110	0.79-0.79
Smooth oxidized electrolytic iron.....	260-980	0.78-0.82
Iron oxide.....	930-2190	0.85-0.89
Rough ingot iron.....	1700-2040	0.87-0.95
Sheet steel:		
Strong rough oxide layer.....	75	0.80
Dense shiny oxide layer.....	75	0.82
Cast plate:		
Smooth.....	73	0.80
Rough.....	73	0.82
Cast iron, rough, strongly oxidized.....	100-480	0.95
Wrought iron, dull oxidized.....	70-680	0.94
Steel plate, rough.....	100-700	0.94-0.97
High temp alloy steels (see Nickel alloys)		
Molten metal:		
Cast iron.....	2370-2550	0.29-0.29
Mild steel.....	2910-3270	0.28-0.28
Lead:		
Pure (99.96%), unoxidized.....	260-440	0.057-0.075
Gray oxidized.....	75	0.281
Oxidized at 390°F.....	390	0.63
Monel metal, oxidized at 1110°F.....	390-1110	0.41-0.46
Nickel:		
Electroplated on polished iron, then polished.....	74	0.045
Technically pure (98.9% Ni, + Mn), polished.....	440-710	0.07-0.087
Electroplated on pickled iron, not polished.....	68	0.11
Wire.....	368-1844	0.096-0.186
Plate, oxidized by heating at 1110°F.....	390-1110	0.37-0.48
Nickel oxide.....	1200-2290	0.59-0.86
Nickel alloys:		
Chromenickel.....	125-1894	0.64-0.76
Nickelin (18-32 Ni; 55-68 Cu; 20 Zn) gray oxidized..	70	0.262
KA-2S alloy steel (8% Ni, 18% Cr) light silvery, rough, brown:		
After heating.....	420-914	0.44-0.36
After 42 hr heating at 980°F.....	420-980	0.62-0.73
NCT-3 alloy (20 Ni, 25 Cr), brown, spotted, oxi- dized from service.....	420-980	0.90-0.97
NCT-6 alloy (60 Ni, 12 Cr), smooth, black, firm adhesive oxide coat from service.....	520-1045	0.89-0.82

TABLE 17.—TABLE OF EMISSIVITIES.^a—(Continued)

Surface	t°F	Emissivity
Zinc:		
Comm'l, 99.1% pure, polished.....	440-620	0.045-0.053
Oxidized by heating at 750°F.....	750	0.11
Galvanized sheet iron, fairly bright.....	82	0.228
Galvanized sheet iron, gray oxidized.....	75	0.276
B. Refractories, building materials, paints, and miscellaneous		
Asbestos:		
Board.....	74	0.96
Paper.....	100-700	0.93-0.945
Brick:		
Red, rough, no gross irregularities.....	70	0.93
Silica, unglazed, rough.....	1832	0.80
Silica, glazed, rough.....	2012	0.85
Grog brick, glazed.....	2012	0.75
See Refractory Materials below.		
Carbon:		
T-carbon (Gebr. Siem.) 0.9% ash.....	260-1160	0.81-0.79
Carbon filament.....	1900-2560	0.526
Candle soot.....	206-520	0.952
Lampblack-water glass coating.....	209-362	0.959-0.947
Thin layer on iron plate.....	69	0.927
Thick coat.....	68	0.967
Lampblack, 0.003 in. or thicker.....	100-700	0.945
Enamel, white fused, on iron.....	66	0.897
Glass, smooth.....	72	0.937
Gypsum, 0.02 in. thick on smooth or blackened plate...	70	0.903
Marble, light gray, polished.....	72	0.931
Oak, planed.....	70	0.895
Paints, lacquers, varnishes:		
Snowwhite enamel varnish on rough iron plate.....	73	0.906
Black shiny lacquer, sprayed on iron.....	76	0.875
Black shiny shellac on tinned iron sheet.....	70	0.821
Black matte shellac.....	170-295	0.91
Black lacquer.....	100-200	0.80-0.95
Flat black lacquer.....	100-200	0.96-0.98
White lacquer.....	100-200	0.80-0.95
Oil paints, sixteen different, all colors.....	212	0.92-0.96
Aluminum paints and lacquers, on rough or smooth surface:		
10% Al, 22% lacquer body.....	212	0.52
26% Al, 27% lacquer body.....	212	0.3
Other Al paints, varying age and Al%.....	212	0.27-0.67
Al lacquer, varnish binder, on rough plate.....	70	0.39
Al paint, after heating to 620°F.....	300-600	0.35

TABLE 17.—TABLE OF EMISSIVITIES.^a—(Continued)

Surface	t°F	Emissivity
Plaster, rough lime.....	50-190	0.91
Porcelain, glazed.....	72	0.924
Quartz, rough, fused.....	70	0.932
Refractory materials, 40 different.....	1110-1830	
Poor radiators.....		0.65 } -0.75 0.70 }
Good radiators.....		0.80 } -0.85 0.85 } -0.90
Roofing paper.....	69	0.91
Rubber:		
Hard, glossy plate.....	74	0.945
Soft, gray, rough (reclaimed).....	76	0.859
Serpentine, polished.....	74	0.900
Water.....	32-212	0.95-0.963

^a Reproduced by permission from "Chemical Engineers' Handbook," McGraw-Hill Book Company, Inc., New York, 1941.

NOTE: When two temperatures and two emissivities are given, they correspond, first to first and second to second, and linear interpolation is permissible.

TABLE 18.—COLOR SCALE FOR TEMPERATURES

(The following color scale permits a rough approximation of high temperatures)

Color	°C	°F
Lowest visible red.....	475	885
Lowest visible red to dark red.....	475- 650	885-1200
Dark red to cherry red.....	650- 750	1200-1380
Cherry red to bright cherry red.....	750- 815	1380-1500
Bright cherry red to orange.....	815- 900	1500-1650
Orange to yellow.....	900-1090	1650-2000
Yellow to light yellow.....	1090-1315	2000-2400
Light yellow to white.....	1315-1540	2400-2800
White to dazzling white.....	1540 or higher	2800 or higher

TABLE 19.—APPROXIMATE HEAT CONTENT OF METALS, ALLOYS, REFRACTORIES
(Expressed in Btu per lb at various temperatures, above 32°F)

Substance	Btu per lb at t°F													
	200	400	600	800	1000	1200	1400	1600	1800	2000	2200	2400	2600	2800
Elementary metals:														
Aluminum.....	34	84	133	184	234	283 ^a	502							
Antimony.....	8	20	36	44	52 ^a	132	144	156	167					
Cadmium.....	8	20	34 ^a	67	83	98	114	130	145					
Chromium.....	24	58	90	125	157	190	225	257						
Cobalt.....	16	38	60	84	112	140	168	200	236	288	316	332	360 ^a	516
Copper.....	15	35	55	77	97	118	138	160	180 ^a	293	315	335		
Gold.....	4	11	19	25	32	38	45	51	58 ^a	94	101			
Iron.....	20	50	80	110	140	169	196	235	285	314	343	372	408 ^a	540
Lead.....	5	11	18 ^a	33	42	48	55	62						
Manganese.....	20	50	80	110	140	168	200	233	257	297	362 ^a	450		
Molybdenum.....	10	22	37	51	65	80	95	110	127	144	162	180	201	
Nickel.....	17	42	67	97	125	151	178	205	232	258	285	313	340 ^a	500
Platinum.....	6	12	18	24	32	40	48	56	64	70	76	84	92	
Silver.....	11	25	40	49	58	71	84	98 ^a	157	171	184			
Tin.....	10	23 ^a	61	75										
Tungsten.....	5	12	19	27	34	41	48	55	62	70	77	84	91	
Zinc.....	14	35	55 ^a	124	152	178								
Alloys:														
Al bronze (90 Cu, 10 Al).....							170	194	218 ^a	342	370			
Brass (85 Cu, 15 Zn).....	15	35	55	75	96	118	138	160	180 ^a	287				
Die casting:														
Al base.....	33	80	126	173	221 ^a	430	480							
Lead base.....	5	11	17 ^a	34										
Tin base.....	10	23 ^a	67											
Zinc base.....	14	35	55 ^a	124	153									
Babbitt:														
Lead base.....	5	12 ^a	47											
Tin base.....	10	23 ^a	72	84										
Linotype and stereotype.....	5	12 ^a	45											
Steel.....	15	40	68	95	123	160	192	230						
Refractories:														
Fireclay brick, clay bond.....	32	70	108	148	185	224	264	302	340	378				
Silicon carbide.....	25	62	98	133	168	204	238	274	308	344	380			
Magnesite.....	36	90	144	198	250	304	356							
Silica brick.....	30	83	132	183	233	284	334	384						
Diatomaceous earth brick.....	32	80	123	167	210	252	296	338	382					
Red brick.....	40	73	112	152	192	232	270	310	348	388				

^a Between this temperature and that shown in the next column at the right the heat content increases rapidly owing to latent heat of fusion in metal at melting point. (Hauck Manufacturing Co.)

TABLE 20.—TRANSMITTED HEAT LOSSES
(Loss in Btu per sq ft per hr. Approximate values)
A. Through Walls of Low-temperature Equipment

Kind and thickness of wall	Temperature—inside equipment wall—°F												
	125	175	225	275	325	375	425	475	575	675	775	875	975
Air cell insulation:													
1 in.	20	42	67	93									
2 in.	11	24	38	52									
3 in.	8	17	26	37									
4 in.	6	13	20	28									
85% magnesia block:													
1 in.	19	38	58	79	100	121	144	167	216				
2 in.	11	21	32	43	55	67	80	92	119				
3 in.	7	15	22	30	38	47	54	64	83				
4 in.	5	11	17	23	29	36	42	49	62				
Mineral wool blankets:													
1½ in.		29	44	60	77	95	...	133	176	221	270	321	388
2 in.		21	32	44	56	70	...	98	130	165	202	243	290
3 in.		14	21	29	37	46	...	65	86	109	134	162	194
4½ in.		9	14	19	24	30	...	42	57	73	90	110	132
5½ in.		7	11	15	20	25	...	35	46	59	74	90	107
6½ in.		6	9	13	17	21	...	29	39	50	62	76	92

B. Through Furnace Walls—Firebrick, Red Brick, Diatomaceous Brick, and Block

Kind and thickness of wall	Temperature—inside furnace wall—°F											
	400	600	800	1000	1200	1400	1600	1800	2000	2200	2400	
2½" FB uninsulated.	732	1090	1524	2040	2630	3310	4060	4940			
4½" FB uninsulated.	480	720	980	1262	1569	1903	2261	2641	3043	3478	
9" FB uninsulated.	282	411	554	706	869	1042	1229	1425	1635	1852	
13½" FB uninsulated.	392	497	611	732	860	995	1139	1288		
4½" FB & 4" RB.	530	585	850	1040	1225	1400	1600			
9" FB & 4" RB.	390	495	600	725	850	980	1125	1275		
9" FB & 8" RB.	220	290	370	460	550	645	745	845	955	
13½" FB & 8" RB.	220	290	370	460	550	645	745	845	955	
13½" FB & 8" RB.	75	125	180	240	305	375	445	510	605	690	78	
4½" FB & 2½" SX.	189	236	287	341	399	461				
4½" FB & 4½" SX.	115	145	176	208	243	278				
9" FB & 2½" SX.	165	207	252	299	349	403	460			
9" FB & 4½" SX.	107	133	161	192	224	257				
4½" FB & 2½" Sil-O-Cel.	194	244	297	354	416					
4½" FB & 4½" Sil-O-Cel.	168	211	255	301						
4½" FB & 9" Sil-O-Cel.	94	116	140	166						
9" FB & 2½" Sil-O-Cel.	168	213	260	310	363	419				
9" FB & 4½" Sil-O-Cel.	151	188	228	271	315					
9" FB & 9" Sil-O-Cel.	87	109	131	155						
13½" FB & 4½" Sil-O-Cel.	137	171	207	245	284	324				

FB = firebrick.
RB = red brick.

SX = superex blocks.
Sil-O-Cel = Sil-O-Cel natural brick.

TABLE 20.—TRANSMITTED HEAT LOSSES.—(Continued)
C. Through Furnace Walls—Firebrick and Insulating Brick

Kind and thickness of wall	Temperature—inside furnace wall—°F									
	1000	1200	1400	1600	1800	2000	2200	2400	2600	2800
4½" N16.....	184	238	293	352						
4½" FB & 4½" N16.....	160	205	240	310	362					
9" N16.....	95	123	152	183						
9" FB & 4½" N16.....	140	190	220	271	314					
13½" FB & 4½" N16.....	120	150	200	240	283	325	374			
4½" N20.....	200	245	300	374	445	525				
4½" FB & 4½" N20.....	210	260	305	360	418	488	577			
9" FB & 4½" N20.....	180	220	270	310	358	428	479	545		
9" N20.....	100	130	170	219	260	306				
13½" FB & 4½" N20.....	135	170	205	255	300	350	419	473	540	
4½" A25.....	280	351	460	565	670	782	820	1070		
9" A25.....	180	225	270	320	360	407	474	550		
4½" FB & 4½" A25.....	280	340	400	470	540	620	701	804	915	1020
9" FB & 4½" A25.....	240	300	340	400	450	510	580	659	744	826
9" FB & 4½" A25 & 4½" N16.....	115	145	180	200	240	280	310	342		
13½" FB & 4½" A25.....	200	250	295	340	390	440	500	577	630	710
13½" FB & 4½" A25 & 4½" N16.....	100	125	155	185	210	240	275	313	355	
4½" EF23.....	410	500	600	700	815	937	1080			
4½" EF23 & 4½" N16.....	130	150	200	250	286	330	377			
4½" FB & 4½" EF23.....	300	370	460	545	630	720	824	930	1039	
4½" EF26.....	360	480	600	710	830	950	1075	1230	1400	
4½" EF26 & 4½" N20.....	160	200	240	280	330	375	434	495	562	
4½" FB & 4½" EF26.....	275	345	430	500	590	700	806	914	1039	1180

FB = firebrick; N20 = 2000°F; EF23 = 2300°F; N16 = 1600°F; A25 = 2500°F; EF26 = 2600°F; indicating insulating firebrick with corresponding safe maximum temperature resistance. (Hauch Manufacturing Co.)

LIST OF VISUAL AIDS

The following list of visual aids can be used to supplement some of the material in this book. These films and filmstrips can be secured from the producers or distributors listed with each title. (The addresses of these producers and distributors are given at the end of the bibliography.) In many cases these materials can also be secured from your local film library or local film distributor.

The running time (min), whether it is silent (si) or sound (sd), motion picture (MP), or filmstrip (FS) are listed with each title. All those not listed as color (C) are black and white. All motion pictures are 16mm; filmstrips are 35mm.

Each film has been listed only once, under the first chapter to which it is most appropriate. In many cases a film can be used advantageously in more than one chapter.

Motion pictures produced by the U.S. Office of Education have coordinated silent filmstrips and instructors' manuals. Other films and filmstrips also have accompanying instructors' manuals.

CHAPTER I—COAL AND COKE]

Wildwood: One Hundred Per Cent Mechanized Mine (BM 45min si MP). Shows the operation of a mechanized mine and the use of modern machinery in the coal industry.

Making Coal Gas and Coke (Bray 11min si MP). Story of coke and coal gas; operation of a gas plant.

Anthracite Coal (EBF 15min si MP). Six units: The Miner Goes to Work; Timber Supports in the Mine; Blasting Coal; Removing Coal from the Mine; The Breaker; Cleaning and Grading Coal; Anthracite Region.

Bituminous Coal (EBF 15min si MP). Methods used in mining of soft coal and making of coke.

Black Sunlight (B&H 15min si MP). The coal formation a million years ago, visualized by means of animation; anthracite mining.

Buried Heat (Annis 11min sd MP). Hard coal mining; actual mining operations.

Digging Deep (Annis 11min sd MP). Anthracite coal mining.

Modern Coal Mining (Goodyear 20min sd MP). How labor-saving machinery has replaced older methods.

Peat and Coal (DeVry 11min sd MP). Geology; how coal was formed; preparing peat for fuel; operation of coal mine and preparation for market.

The Power Behind the Nation (B&H 35min sd MP). Importance of coal industry to economic life; origin of coal; mining processes; refining; grading; uses.

Sampling and Testing of Solid Fuels (Pa. St. Col. 25min sd MP). Sampling of coal at tippie, by diamond drilling and from seam; laboratory treatment.

The Story of Coal (B&H 11min sd MP). Formation; location in United States; mining processes; refining; grading; uses.

The Story of Coal (B&H 15min si MP). Formation; coal areas; how it is mined, graded; animation and actual photography.

CHAPTER II—PETROLEUM AND NATURAL GAS

Evolution of the Oil Industry (BM 30min si MP). Development of petroleum industry from early times to drilling of modern oil wells, pipe lines, and refineries.

Petroleum Geology (B&H 30min sd MP). Work of oil-geologist; traces topography of North America.

Oil for Tomorrow (10CC 30min sd C MP). Story of America's oil resources.

10,000 Feet Deep (Shell 20min sd MP). Modern methods of exploration and drilling for oil.

Marvel of Sun Oil Chemistry (Sun Oil 13min sd MP). Refining of Nu-Blue motor oil; the catalytic process.

Petroleum and its Uses (BM 42min sd MP). Drilling methods; laying pipe line; commercial, family, and industrial uses of petroleum products.

Masters of Molecules (YMCA 30min sd MP). Refining of petroleum.

Refining of Petroleum (Bray 8min si MP). What takes place in the refining of crude oil; shows cracking process.

Refining Crude Oil (EBF 15min si MP). Shows process of cracking crude oil and products derived from it.

The Story of Lubricating Oil (BM 30min si MP). Manufacture and use of lubricants; general view of typical refinery; theory of process used.

Oil (Calumet 10min sd MP). Shows oil types and oil qualities in lubrication; methods of testing gumming, carbon residue, viscosity, and corrosion.

The Story of Gasoline (BM 30min si MP). Story of the gasoline industry from the production of crude oil to the finished product; illustrates uses of naphtha, kerosine, gasoil, lubricating oils, fixed gas, and coke.

What is Good Gasoline (Florez sd FS). Deals with fuel requirement of modern internal-combustion engine; also story of the manufacturing of gasoline.

CHAPTER IV—COMBUSTION STOICHIOMETRY

Fire and Heat (DeVry 11min si MP). Physical properties and utilization.

Chemistry of Combustion (DeVry 11min sd MP). Series of chemical experiments showing processes of combustion and oxidation.

Fire Making (A&B 15min si MP). Traces methods of fire making and shows how matches are made.

Flue Gas Analysis—Orsat Apparatus (USOE 19min sd MP). Shows how to set up the Orsat gas analyzer; draw in an air-free sample of flue gas; absorb and measure amounts of carbon dioxide, oxygen, and carbon monoxide in the sample; and how to calculate the amount of nitrogen.

CHAPTER V—TEMPERATURE, ENTHALPY, AND HEAT OF COMBUSTION

Energy (JH FS). Shows the concept of work and the use of potential-kinetic formula—conservation of energy.

Energy and its Transformations (EBF 10min sd MP). Shows potential, kinetic, and radiant energy as manifested in mechanical, electrical, chemical, and thermal forms.

Thermodynamics (EBF 11min sd MP). Deals with selected heat phenomena: combustion; molecular action; mechanics of steam, gas, and diesel engines.

CHAPTER VI—EQUILIBRIUM AND KINETICS

Catalysis (EBF 10min sd MP). Explains several phenomena associated with catalysis; uses antiknock gasoline as practical application.

Velocity of Chemical Reactions (EBF 11min sd MP). Demonstrates effect of the nature and concentration of reacting substances and of the temperature on the rate of chemical reactions.

CHAPTER VII—THE COMBUSTION PROCESS

The Power Within—A Story of the Internal-combustion Engine (BM 20min sd MP). Explains in detail location and operation of each part of gasoline motor.

Fuels and Heat (EBF 11min sd MP). Role of carbon in fuels; process of combustion; operations of steam and internal-combustion engines.

CHAPTER XI—STOKERS AND PULVERIZED-COAL BURNERS

Stokers and Stoker Coal (Kansas 40min sd MP). Various types of domestic stoker furnaces and their installation in the home; coal used for burning in this type of furnace.

Distributing Heat Energy (EBF 11min sd MP). Heat sources; burning of furnace fuels; development of home heating; heat transfer.

Hot Air Heating (A&B 11min si MP). Divided into four parts: The Fireplace, The Stove; The Furnace; Summary Review of Heating Devices; Advances in Heating Devices.

CHAPTER XII—INTRODUCTORY HEAT TRANSMISSION

Heat and its Control (AM 20min sd MP). Value of controlled heat; its control by insulation.

Asbestos (BM 30min si MP). Shows the blasting of asbestos-bearing rock; making of many useful articles from asbestos.

The Story of Asbestos (BM 20min si MP). Shows sources of asbestos; pictures manufacture of various types of insulation and other asbestos products.

CHAPTER XIII—FURNACE REFRACTORIES

Fire-clay Refractories (BM 40min si MP). Depicts the manufacture of refractories by three common methods; dry press; stiff-mud process; hand-molded products; use of fireclay in iron blast furnaces.

Jewels of Industry (Kansas 20min si MP). The manufacture of carborundum and aloxite and their uses in industry.

Manufactured Abrasives (BM 24min sd MP). Shows experiments which led to discovery of Carborundum; manufacturing processes; uses of the products.

CHAPTER XVI—PROCESS FURNACES AND KILNS

The Story of Steel (BM 11min sd MP). Describes the manufacture of steel and shows its important uses in the world today.

Iron Ore to Pig Iron (EBF 15min si MP). Outlines the mining of ore; how it is smelted and cast into pigs.

Bessemer and Open Hearth Steel (Bray 5min si MP). Process visualized by animation and actual photography; principle of regenerative process.

Aluminum: Mine to Metal (BM 18min sd MP). Uses in industry; treatment of bauxite to form aluminum hydroxide; production of metal by electrolysis.

SOURCES OF MATERIALS LISTED ABOVE

A&B—Akin & Bagshaw, Inc., 2023 E. Colfax Ave., Denver, Colo.

AM—American Museum of Natural History, 79th and Central Park W., New York 24.

Annis, R. B., Company, 1101 N. Delaware St., Indianapolis, Ind.

B&H—Bell & Howell Company, 1801 Larchmont Ave., Chicago 13.

- BM—U.S. Bureau of Mines, Experiment Station, 1600 Forbes St., Pittsburgh 13, Pa., and subdistributing centers.
- Brandon Films, Inc., 1600 Broadway, New York 19.
- Bray Studios, Inc., 729 Seventh Ave., New York 19.
- Calumet Oil Company, 4321 S. Western Ave., Chicago.
- Castle Films, Inc., 30 Rockefeller Plaza, New York 20.
- DeVry Films, Inc., 1111 Armitage Ave., Chicago 14.
- EBF—Encyclopaedia Britannica Films, Inc., 1841 Broadway, New York 17.
- Florez, Inc., 815 Bates St., Detroit, Mich.
- Goodyear Tire & Rubber Company, Motion Picture Dept., Akron, Ohio.
- IOCC—Interstate Oil Compact Commission, Oklahoma City, Okla.
- JH—Jam Handy Organization, 2900 E. Grand Boulevard, Detroit 11, Mich.
- Kansas—University of Kansas, Bureau of Visual Instruction, Lawrence, Kan.
- Pa. St. Col.—Pennsylvania State College, Film Library, State College, Pa.
- Shell Oil Company, Public Relations Dept., 50 W. 50th St., New York 20.
- Sun Oil Company, Sales Promotion Dept., 1608 Walnut St., Philadelphia 3, Pa.
- USOE—U. S. Office of Education (Obtainable from Castle Films, Inc.)
- Y.M.C.A., Motion Picture Bureau, 347 Madison Ave., New York 17.

AUTHOR INDEX

Company, association, editor, or journal names are sometimes listed in lieu of authors' names for anonymous, company, staff, series, chapter, or symposium references. Reproductions of graphs, illustrations, and tables are similarly indexed.

A

Air Preheater Corporation, 429
Altieri, V. J., 50, 248
Am. Gas Assoc., 208, 243, 247, 255-257,
260-262, 267-269, 410, 413
Am. Inst. of Chem. Engrs., 315
Am. Soc. for Testing Materials (ASTM),
51, 57, 77, 85, 333-334, 346, 351,
457-459
Arnold, J. H., 113
Augustine, C. E., 217
Automatic Burner Corporation, 279-280

B

Babcock and Wilcox Company, 305-306,
309-310, 313, 362, 368-369, 372, 382,
384, 387-388
Badger, P. A., 80
Badger, W. L., 253, 331
Baker, A. L., 397
Barkley, J. F., 20
Bayard, R. A., 421
Beatty, H. W., 192
Begeman, W. L., 412-413, 416, 418
Berl, E., 202
Best, W. N., Engineering Company, 279,
290
Bethlehem Steel Company, 415
Black, A. R., 281
Black, Sivalls, and Bryson, 37
Bogk, J. E., 66
Bone, W. A., 184, 191
Brooks, B. T., 72
Brown, G. G., 65, 80, 127
Buell Engineering Company, 314

C

Calingaert, G., 80
Campbell, J. M., 55
Carborundum Co., The, 345, 408

Carleton, L. T., 94
Carlson, C. J., 276
Castner, J. B., 390
Central Scientific Company, 47
Chem. & Met. Eng., 23, 108, 411, 415,
447-448
Chem. Reviews, 130
Coats, H., 80
Cohen, T. A., 295
Cooper, H. M., 136
Coppus Engineering Company, 271
Coward, H. F., 198, 206
Cox, E. R., 80
Cragoe, C. S., 136
Curtin, W. H., & Company, 46

D

Daniels, F., 167, 179
Davis, D. S., 80
Dean, D. K., 389
Deanesly, R. M., 94
Denig, F., 222
Detroit Stoker Company, 300, 302-303
Dodge, F. E., 27
Dow Chemical Company, 390
Drew, T. B., 461
Dubbs, J. A. 391
du Pont, E. I., de Nemours & Co., 445-
446

E

Eckman, D. P., 276
Egloff, G., 72
Elbe, G. von, 149, 150, 176, 183, 184, 195,
197, 198, 204, 214
Evans, J. E., 399
Eyring, H., 168

F

Fallon, J. F., 123
Fellows, C. H., 378

Ferris, S. W., 64
 Fieldner, A. C., 1
 Flock, E. F., 193, 205, 214
 Fitch Recuperator Company, 427
 Folkins, H. O., 148
 Foster-Wheeler Corporation, 310
 Frolich, P. K., 72
 Fuchs, W., 21
 Fulweiler, W. H., 248

G

Garton, F. L., 33
 Geiger, C. F., 355
 Getman, F. H., 179
 Gibbs, R., 422
 Gibson, F. H., 136
 Gilliland, E. R., 113, 227, 253, 331, 435,
 437
 Glasstone, A. C., 168
 Glendenning, E. B., 281
 Goff, J. A., 229
 Green, A. T., 339
 Greenwald, H. P., 206
 Griswold, J., 113

H

Hall, F. P., 348
 Hall, J. L., 42, 132
 Harbison-Walker Refractories Co., 337,
 339-344, 348-349, 352-353, 363-365
 Hartzell, F. W., 229
 Haslam, R. T., 12, 113, 127, 218, 227,
 233, 235, 245, 315, 360
 Hauck Mfg. Co., 282-283, 286, 295, 360,
 469-471
 Hauge, C. W., 276
 Headlee, A. J. W., 42, 132
 Heilman, R. H., 356
 Hepburn, W. M., 429
 Heron, S. D., 192
 Hitchcock, F. L., 218
 Hoeven, F. J. C., van der, 248
 Holbrook, E. A., 9
 Holcomb, D. E., 127
 Hottel, H. C., 190, 213, 327, 329-330,
 398-399
 Hougen, O. A., 113, 143

I

Ind. Eng. Chem., 18, 72, 88
 Insley, H., 348

J

Jeffrey Manufacturing Company, 10
 John Zink Company, 284
 Jones, G. W., 136, 198, 202
 Jones, W. H., 135
 Jost, W., 207

K

Kalichevsky, V. A., 44
 Kassel, L. S., 174
 Keenan, J. H., 450
 Kellogg, M. W., Co., 122
 Kennedy, R. E., 202
 Kent, R. T., "Mechanical Engineers'
 Handbook," 370, 405
 Keyes, F. G., 450
 Kirst, W. E., 390
 Kobe, K. A., 276
 Koppers Co., 22, 26, 42
 Kurtz, S. S., 85

L

Laidler, F. J., 168
 Lane, E. C., 33
 Letort, M., 159
 Lewis, B., 149, 150, 176, 183, 184, 195,
 197, 198, 204, 214
 Lewis, W. K., 113, 227, 253, 331, 435, 437
 Lobo, W. E., 392, 396-399
 Loux, J. H., 350
 Lovell, W. G., 55
 Lowry, H. H., 27
 Lukofsky, S. S., 94
 Lummus Company, 367, 394-395

M

McAdams, W. H., 108, 113, 217, 227, 228,
 253, 331, 435, 437
 McCabe, W. L., 253, 331
 McDowell, J. S., 344
 MacPherson, G. R., 52
 Maier, C. G., 421
 Marks, L. S., "Mechanical Engineers,
 Handbook," 463
 Mason, W., 199
 Maxwell, J. B., 80, 81
 Mayers, M. A., 315
 Meissner, H. P., 125

- Mellor, J. W., 339-340
 Miller, C. O., 423
 Miller, E. L., 148
 Mithoff, R. C., 52
 Monarch Manufacturing Works, 281
 Monrad, C. C., 398
 Moore, E. S., 27
 Moore, H., 191
 Morey, G. H., 357
 Morgan, J. J., 248
 Morris, J. W., 113
 Morton, J. M., 153, 161
 Murphy, G. B., 33, 86
- N
- Nagle, W. M., 390
 National Airoil Burner Company, 273,
 284-285, 291
 National Bureau of Standards, 76, 123,
 128, 130, 148, 263, 451
 National Transit Pump and Machine
 Company, 287
 Nelson, E. F., 33, 86
 Nelson, W. L., 163, 164, 405
 Nicholls, E. S., 425
 Nichols Engineering and Research Co.,
 423-425
 Norton, F. H., 357
- O
- Oesterle, J., 419
 Olive, T. R., 410
 Orning, A. A., 315
 Ostergaard, P., 66
 Ovitz, F. K., 217
- P
- Pacific Coast Gas Association, 27, 247-
 248, 276
 Parr, S. W., 13, 27
 Partridge, E. P., 378
 Payman, W., 202, 206
 Payne, J. W., 425
 Pease, R. N., 151, 153, 161, 179, 194
 Perry, J. H., "Chemical Engineers'
 Handbook," 125, 214, 276, 325, 331,
 405, 462, 464-468
 Pickering, S. F., 206, 207
 Plummer, F. B., 34
- Podbielniak, W. J., 47-49
 Prutton, C. F., 423
 Purdy, A. C., 378
- R
- Radasch, A. H., 113
 Ralston, O. C., 421
 Redding, E. M., 125
 Rhodes, T. J., 276
 Rickerman, J. H., 397
 Riley Stoker Corp., 301, 304, 311-312
 Roots-Connorsville Corporation, 292-293
 Rosenholtz, J. L., 419
 Rossini, F. D., 30, 357
 Rudow, E. W., 218
 Russell, R. P., 12, 113, 127, 227, 315, 360
- S
- Sachanen, A. N., 72
 Sandhoff, A. G., 21
 Sauveur, A., 447-448
 Schack, A., 331
 Schallis, A., 344
 Schuette, W. H., 423
 Schutte & Koerting Co., 283, 286, 288-
 289, 294
 Scott, G. S., 136
 Segeler, C. G., 248
 Selvig, W. A., 136
 Shaw, 157
 Shell Development Co., 127
 Silverman, A., 357
 Simpson, T. P., 425
 Sipos, F., 52
 Smith, B. A., 423
 Smith, F. A., 206, 207
 Smith, R. V., 80
 Smoley, E. R., 66
 Sortman, C. B., 192
 Sosman, R. B., 337
 Sprunk, G. C., 4
 Stagner, B. A., 44
 Starr, C. E., 135
 Steacie, E. W. R., 157, 163, 179
 Steere, G. W., 239
 Steiner, K., 295
 Stewart, I. McC., 213
 Stopes, M. C., 4
 Storrs, B., 42
 Strout, A. L., 63, 64

Sullivan, J. D., 421
 Sullivan, W. A., 281
 Sung, H. C., 65
 Surface Combustion Company, 275

T

Tagliabue, C. J., Mfg. Co., 53, 77, 82
 Texas Company, The, 56
 Texas Railroad Commission, 41
 Thacker, C. M., 148
 Thiessen, R., 4
 Townend, D. T. A., 184, 191
 Trinks, W., 276, 375, 407, 420, 429, 442
 Trostel, L. J., 347, 349, 352

U

United Gas Improvement Company,
 (UGI), 220, 237, 238
 U.S. Bureau of Mines, 6, 7, 13, 26, 35, 72

Universal Oil Products Co., 59, 86, 88-
 92, 186, 393, 395-396
 Uren, L. C., 72

V

Van Winkle, M., 72
 Ventres, L. H., 281
 Vulcan Iron Works, 420

W

Walker, W. H., 113, 227, 253, 331, 435,
 437
 Watson, K. M., 33, 86, 93, 113, 123-126,
 143
 Webster Engineering Company, 259,
 268-270, 272-274, 378-381, 383
 Wellman Engineering Company, 220, 221
 Werner, G., 202
 Wheeler, R. V., 199, 202
 White, R. R., 63
 Wilson, D. W., 398

SUBJECT INDEX

Inclusive page numbers usually indicate principal references.

A

Absolute pressure, definition of, 98-100
Absolute temperature, definition of, 98-100, 118
Absorption, of coke-oven gas, 24
 of natural gas, 38-42
Acetylene, flame temperature of, 139
Activation (*see* Kinetics)
Adiabatic combustion temperature, 138-139
Adiabatic humidification, 107
Air, dry, composition of, 100
 excess, 103-104, 110
 theoretical, calculation of, 103-104
 humidity of, 105-112
 molecular weight of, 100
 (*See also* specific subjects)
Aldehydes (*see* Combustion process)
Alkylation, 69-70
Amagat's law, 97-98
Ammonia, ammonium sulfate, 20, 23-24, 26
Analysis (*see* particular subjects)
Anthracene, 25, 30
Anthracite (*see* Coal)
Anthraxylon, 4
Appendix of data, 443-471
Arches (*see* Furnace roofs)
Aromatization, 68-69
Arrhenius equation, 160, 185
Ash, adherence of, to furnace walls, 361-363
 in coal (*see* Coal, ash)
 fly, 313-315
 methods of removal of, from grates, 298-307, 361-363
 from producers, 220-223
Asphalt, 32
Asphaltenes, 31, 62
Atmosphere (*see* Air; Furnace)
Attrition pulverizer, 309-311
Author index, 479

Autogenous ignition temperature (*see* Ignition temperature)

Aviation gasoline (*see* Gasoline)

Avogadro's number, 97, 168

B

Ball mill (pulverizer), 309-310, 424-425
Beehive coke ovens, 20-21
Benzene, in carbureted water gas, 240
 from coking of coal, 24-26
 in motor fuel, 45
 in petroleum, 30
Bergius process, 26-27
Bituminous coal (*see* Coal)
Blending of oils, 43-45, 51
Blast furnace, 414-416
Blast-furnace gas, 23, 452
Blowers, compressors, and fans, 290-293, 370
Blue gas, 216, 231, 248, 452
Bogs, peat, 2
Boilers, 377-388
 bent-tube, 382-385
 cast-iron, 378
 central-station, 362, 384-385, 442
 classification of, 378
 double-shell, 379
 draft losses in, 380
 efficiency of, 377
 feedwater treatment of, 378
 fire-tube, 377, 379-382
 forced-circulation, 386-387
 heat balance in, 406
 heat release in, 363, 377, 382
 heat-transfer coefficients of, 398-399
 heat-transfer duty of, 377, 381-382
 locomotive-type, 380-382
 longitudinal- and cross-drum, 382-383
 ratings of, 377
 Scotch marine, 381-382
 superheaters, 385-386
 waste-heat, 230, 387-388, 425
 water-tube, 368, 372, 377, 381-385

- Boilers, water walls in, 356, 361-369
- Boiling point, average (*see* Oils, boiling points of, average)
of hydrocarbons, 49-50, 451
- Boltzmann constant, 168
- Bottle gas, 209, 243, 258
- Boyle's law, 97-98
- Breaker, coal, 8
- British thermal unit (Btu), definition of, 118
- Bunker fuels, 43, 45, 60, 236 (*See also* specific property or test)
- Burners, bunsen, principle of, 202-209
coal, 297-315;
grates, 298-307
pulverized, 307-313
(*See also* Pulverized coal)
stokers, 297-307
(*See also* Stokers)
combination, 270-273, 312
gas, 231, 250-277
atmospheric, 253-266
automatic controls, 276
design factors (table), 257
large-port, 267-269
orifices, 253-266
tile-port, 272-275
oil, 212, 278-296
air-atomizing, 282
auxiliaries, 286-295
controls and safety devices, 293-295
mechanical atomizing, 279-281
oil-pressure atomizing, 281-282
steam or air atomizing, 282-286
vaporizing, 278
- Burning oils (*see* Oils, kerosine)
- Burning velocity (*see* Combustion process; Flames)
- Byproduct coke-oven plants, 20-26
Folder A, facing page 442
- C
- Calcining, in rotary kiln, 420
- Calorie, definition, 118
- Calorimeter, calorimetry gas, 127-132
liquid, 129-132
- Carbazole, 25
- Carbon, combustion of, 190
(*See also* specific subject)
- Carbon bisulfide, in carbureted water gas, 240, 242
- Carbon bisulfide, in coal gas, 20
- Carbon dioxide (*see* particular subject)
- Carbon monoxide (*see* context under particular subject)
- Carbon residue, 56, 59-60, 278
- Carbonization (*see* Coke; Coking)
- Carborundum (*see* Silicon carbide)
- Carbureted water gas, 216-243, 452
(*See also* specific heading)
- Catalysis, in coal hydrogenation, 26-27
in kinetics (*see* Kinetics)
in petroleum conversions, 68-71
- Catalysts (*see* Catalysis)
- Cement kilns, 310, 430-442
- Centipoise, centistoke, 458-459
- Central-station boilers, 362, 384-385
Folder B, facing page 442
- Ceramics (*see* Refractories)
- Cetane number, 59, 194
- Chain reactions (*see* Combustion reactions; Kinetics)
- Characterization factor (UOP), correlations with, 86-94, 123-127, 142
definition of, 33
- Charles's law, 97-98
- Checkers (*see* Regenerators; Carbureted water gas; Oil-gas)
- Chimneys, 373-375
- City gas, 216, 232, 247-248
- Clarain, 4-5
- Classifier, coal, 8, 10-11, 308-310
- Clinker (*see* Cement kilns; Gas producers; Stokers)
- Coal, 1-20
analyses of typical, 452
analytical tests of, 11-12, 16-17
anthracite, 6, 8, 14, 18, 136, 142
ash in, 10-19, 452
fusion of, 18-19, 361-363
banded, 4
bituminous, 4-5
(*See also* specific property or test)
boghead, 5, 143
brown, 3, 14
burning of, 212-214, 297-299, 308
(*See also* Burners, coal; Coal, firing of; Stokers)
calorific value of (*see* Coal, heating value of; Heating value)
cannel, 5, 143
carbonization of, 18, 20-27
in manufactured gas, 216, 225

- Coal, classifications of, 2, 12-15
 cleaning of, 10-11, 15
 coking of (*see* Carbonization; Coking)
 combustion of (*see* Coal, burning of)
 commercial varieties of, 3-5
 conversion of, 26-27
 evolution of, 2-3
 firing of, 17-18, 297-308, 312, 360-363
 grade of, 15-16
 grindability of, 17, 312
 heating value of, 14-16, 136-137, 142-143, 452
 hydrogen in, 12, 136-137, 143, 452
 hydrogenation of, 26-27
 ignition temperatures of, 213, 308
 lignite, 3, 14, 143
 for manufactured gas, 216-240
 mineral matter in, 5, 13-15
 mining of, 6-10
 moisture in, 11-12, 311-312, 452
 nitrogen in, 12, 23-24, 26, 452
 occurrence of, 5
 oxygen in, 12, 452
 petrographic structure of, 3-5
 preparation of, 8-11
 proximate analysis of, 11-12, 136-137, 142, 452
 pulverized (*see* Pulverized coal)
 pyrites in, 10, 13-15, 20, 112, 136
 rank of, 2-3, 14
 requisites for major uses of, 17-20
 shale in, 8, 13
 size designation of, 16
 splint, 5
 spontaneous combustion and storage of, 19-20
 sulfur in, 12-16, 19-20, 452
 types of, 3-5
 ultimate analysis of, 12, 452
 weathering of, 3
 index of, 16
- Coal gas, 18-19, 21-27, 232, 248, 252
 Coal tar, 24-27
 Coke, heating value of, 130, 143, 452
 manufacture of, 20-27
 specifications on, 19
 tests of (*see* Coal)
 ultimate analysis of, 452
 Coke breeze, 22
 Coke ovens, 21-23, 216
 Folder A, facing page 442
- Coking, 18-27
 Coking, byproduct recovery in, 23-27
 Folder A, facing page 442
 of petroleum, 68
 Coking mechanism, 20-21
 Combustion, forced-draft, in oil burners, 292-294
 in pulverized coal burners, 312-313
 in stokers, 298, 370
 heat of (*see* Heat; Heating value)
 ignition lag, 193-195
 ignition temperatures, 191-197, 213, 308
 inflammability, limits of, 195-202
 reactions, chain, 173-179, 182-187, 210
 of elementary carbon, 190
 gaseous, 181-190
 (*See also* Combustion process; Kinetics)
 over-all, 102, 217, 219, 226
 space requirements, 358-363
 stoichiometry, 196-113
 submerged, 276
 surface, 210
 thimbles, tile, rings, 268-275, 286, 293-294, 312, 359-360, 378, 381-382
 (*See also* Burners, gas; Oils, burning of)
- Combustion arches, 305-307, 361, 366
 Combustion chamber, heat balance on, 330-331
 (*See also* Fireboxes; Furnaces)
 Combustion process, 181-215
 aldehydes in, 182-184, 193-194, 203
 detonation, 189-190, 211
 explosion limits, 185-187, 193, 197, 201
 flame, 181-182, 186-190, 195-214
 Le Chatelier's rule, 199-200, 209
 Mallard-Le Chatelier equation, 195-197
 mechanism of reactions, 181-190
 (*See also* Combustion reactions)
 methanol, peracids, and peroxides, 183-184
 oxidation inhibitors, 193
 slow, 182-187
 types of, 187-190
 (*See also* Flames; Kinetics)
 Combustion temperatures, adiabatic, 138, 216
 of inflammability limits, 198-202

- Compressors, 291-293
 Condensation (*see* Dew point; Distillates)
 Condensers, coolers, 23, 39, 42, 43, 233, 234, 241
 (*See also* Scrubbers)
 Condenser-tube data, 461
 Conduction, 316-320
 (*See also* Furnace walls; Heat transfer)
 Controls, automatic, of gas burners, 276
 of oil burners, 293-295
 of stokers, 298-299
 Convection bank, 392-398
 Convection coefficients, 316-320, 355
 Convection furnaces, 358
 Convection section, 392-398
 Conversion factors, Appendix, 444-470
 essential, 99-100
 heat of combustion, 130
 Cool flames, 186, 192-194
 Corresponding states, 99
 Corrosiveness, test for, of oils, 31, 41
 Counterflow (heat exchanger), 313, 319
 Cracking (*see* Oils, cracking of)
 Creosote, cresols, 25
 Crucible furnace, 412-414
 Crude oil (*see* Oils, crude)
 Cupola, 416-417
 Cyclone separators, 221, 224, 313-315, 430
- D
- Dalton's law, 82, 97-98
 Dayton process, oil gas, 243
 Decomposition (*see* Kinetics; Oils, cracking of)
 Dehydration, of alcohol (catalytic), 170-171
 of carbureted water gas, 242-243
 of crude oil, 37-38
 of natural gas, 42
 Dehydrogenation, of alcohol (kinetic, catalytic), 170-171
 equilibrium, calculations of, 149-152
 kinetics, calculations of, 161-165
 (*See also* Oils, dehydrogenation of)
 Density (*see* Gas; Oil; Refractories)
 Desulfurization, of carbureted water-gas, 241-242
 of gasolines, 44
 of natural gas, 41
 Desulfurization, of oil gas, 246
 Dewaxing; effect of, on *K* value, 94
 Dew point, of air, flue gas, 106-109
 Diesel engines, 59, 194
 Diesel fuels (*see* Oils, diesel)
 Diphenyl, 30, 388-390
 Discharge coefficients, 252-253, 258, 260-261
 Dissociation (*see* particular subject)
 Distillates, crude oils, 35
 furnace, 43, 45, 60
 petroleum (*see* Oils)
 tractor, 53
 water-white, 43-45
 Distillation (*see* Coal tar; Gasoline; Oils; Stabilization)
 Doctor test, for sweetening, 31, 41, 44, 59
 Dolomite, 344, 420, 422
 Dowtherm, 388-390
 Draft, in boilers, 380, 385
 chimney, 373-374
 forced, 292-293, 298, 312, 370
 in furnace operation, 369-372, 410-411, 414, 426-428
 Driers, rotary, 423
 Dry-box process, 242
 Dry-hearth, 424
 Drying, in coal testing, 11
 of pulverized coal, 307, 311-312
 (*See also* Dehydration)
 Drying oven, 407
 Dulong and Petits' law, 125
 Durain, 4-5
 Dust (*see* Gas, purification of; Fly-ash; Precipitators)
 Dutch oven, 359
- E
- Edeleanu process, 44
 Emissivities, radiation, table of, 465-468
 Energy, conversion factors of, 446
 major sources of, 1
 (*See also* Enthalpy; Equilibrium; Heat; Kinetics)
 Engines, CFR, 55-58
 diesel, 59, 194
 gas, 414
 gas turbine, 212
 gasoline, 55, 57-58
 internal combustion, 54-56, 146, 211-212

- Engines, jet-propulsion, 212
 steam, 212, 385
- Enthalpy, of activation, 169-170
 calculations of, 120-122, 147-151
 charts, discussion of, 127
 definition of, 117-118
 (See also Energy; Heat; Heat content)
- Entropy, 147, 149
 of activation, 168-171
- Equilibrium, thermodynamic, 145-152
 calculations of, 149-152
 in combustion gases, 150, 179-180
 constants (gas reactions, chart of), 150
 in petroleum cracking, 61-63
 in producer- and water-gas reactions, 150, 179-180, 217-218, 225-231, 248-249
- Ethyl fluid, 45, 55, 59, 174, 192, 193
- Ethylbenzene, thermal dehydrogenation of, 161-162
- Ethylene, hydrogenation of, 149-151, 163
- Evaporation, by submerged combustion, 276
- Excess air, calculation of, 103-104, 110
- Explosion limits, kinetic, 176-179, 186-187, 197, 200-202
- Extraction (see Absorption)
- F
- Fans, 290-293, 370
- Film coefficients, heat-transfer, 320-326
- Fireboxes, 358-373
 burner arrangement, 371
 construction of, 363-369
 flame impingement in, 359
 (See also Furnaces)
- Fireclay (see Refractories)
- Firing (see specific fuel or furnace)
- Fischer-Tropsch process, 27
- Flame impingement, 359
- Flames, coal, 360
 cool, 186, 192-194
 definition of, 181
 diffusion, 188, 360, 419
 gas, 202-210, 359-360
 luminous, 203, 359-360
 oil, 360
- Flames, propagation of, 181, 185-214
 pulverized-coal, 213-214, 361-363
 (See also Burners; Combustion process; Combustion temperature)
- Flash point, of oils, 54-55, 59, 60
- Flash roaster, 424-425
- Flotation, of coal, 11, 15
- Flow diagrams, of blast furnace, 415
 of byproduct coke-oven plants, 23
 Folder A, facing page 442
 of carbureted water-gas generator, 235
 of carbureted water-gas set, 233
 of flash roaster, 424-425
 of fuel, air, and ash travel in stokers, 299
 of gas purification process, 42
 of natural gasoline plant, 39
 of petroleum-cracking furnaces, 392-396, 400
 of petroleum-cracking processes, 67
 of petroleum refining, 43
 of power plant, Folder B, facing page 442
- Flow measurement, 250-253
- Flue gas, 101-104 (see specific property)
- Flues, friction in, 374
- Fluid mechanics, pressure and flow measurement, 250-254
- Fly ash, 307, 313-315
- Fog, coal gas, 24
 oil, 242-243
 producer gas, 223
 tar, carbureted water-gas mist, 241
- Forced draft (see Draft)
- Forsterite refractories, 344-345
- Fouling coefficients, 322
- Free energy, 147-152
 of activation, 169
- Free radicals (see Kinetics)
- Frequency factor (see Kinetics)
- Friction, flues, 374
 in gas burners, 253, 258, 260, 263
 (See also specific headings)
- Fuels (see specific type, property, or test)
- Fugacity, 145-146
- Fuller's earth, decolorizing, 44, 420, 423, 426
- Fungi, in formation of coal, 2
- Furnace, accessories for (see Burners; Controls; Fans; Preheaters; Pumps; Recuperators; Regenerators)
 arches (see Furnace, roofs of)

- Furnace, atmospheres, 275, 350, 408, 414, 415
 baffles, 372-373
 blast, 414-416
 boiler (*see* Boilers; Fireboxes)
 burner arrangement, 371-372
 burners (*see* Burners)
 cement kiln, 414, 430-442
 ceramic kiln, 216, 409-412
 crucible (and pot), 412-414
 cupola, 416-417
 draft (and pressures), 369-374
 electric arc, 413-414
 flash roaster, 424-425
 gas-flow pattern, 371-373
 gas recirculation, 373
 glass (tank), 216, 419-420
 heat balance (*see* Heat balances),
 heat economy, 407, 408
 heat input, 407-408
 heat release (*see* Heat release)
 malleable-iron, 417-418
 metallurgical, 346-347, 412-425
 muffle, 358, 408-409
 multiple-hearth, 409, 423-424
 multistage, 362-363
 open-hearth, 216, 417-420
 process and kilns, 407-442
 reheating, 409-410
 retort, 409
 reverberatory, 417
 roofs of,
 bung, 418-419
 sprung arch, 351-353, 363-366
 suspended arch, 366-369
 rotary drier, 423
 rotary kilns, 420-423, 430-442
 shaft, 414-417
 slag-tap, 361-363
 smelting, 414-419
 steam superheater, 140-142
 steel open-hearth, 418-419
 temperatures of, 358-361, 407
 Thermofor kiln, 425-426
 tube, 377-406
 (*See also* Tube heaters)
 tunnel, 409-412
 vertical, 414-417
 walls of, ash adherence to, 361-363
 construction of, 363-369
 fluxing of, 346-350, 356-357, 366
 heat loss from, 316-319, 323-324,
 330-332, 354-356
- Furnace, walls of, heat loss from, tables
 of, 470-471
 spalling of, 352-354
 suspended, 366-369
 temperatures of, 316-319, 323-324,
 330-332, 356-367
 thermal conductivity of, 316-319,
 331-332, 354-355
 water-cooled, 356, 361-369
- Fusain, 4-5
- G
- Ganister, 337
- Gas, analysis and evaluation of, 40, 45-50
 blast-furnace, 23, 414, 452
 blau, 243
 blue, 216, 231, 248
 bottled, 209, 243, 248
 burners, 250-277
 (*See also* Burners, gas)
 burning of (*see* Burners, gas; Com-
 bustion process; Kinetics)
 calorific value of (*see* Heating value)
 carbureted water-gas, 216-243
 (*See also* specific item)
 city, 19, 216, 232, 247-248
 coal (coke-oven), 18, 21-27
 combustion of (*see* Gas, burning of;
 Gas firing; Flames)
 composition, properties, and purifi-
 cation of, blast furnace, 414
 blue (water gas), 216
 carbureted water gas, 232, 240-243
 city, 19, 232, 247-248
 coal (coke-oven), 23-24, 26
 mixed, 248
 natural, 38-42, 48-50, 95, 104, 242-
 243
 oil, 243-248
 producer, 216, 224-225, 229-231, 248
 refinery, 63, 65, 140
 typical values of, 452
- cookstoves, 19
 cracking, 63-66, 68-71, 452
 dehydration of, 42, 242-243
 distillation analysis of, 47-50
 explosion limits (pressure), 176-179,
 186-187, 197, 200-202
 firing, 359-360
 flue, composition of, 101-104
 fuel, typical analyses and heating
 values of, 452
 gravities of, 451-452

- Gas, gravities of, 451-452
 determination, 45-47
 heaters, 19, 265-267, 275-276
 (*See also* Boilers; Furnaces; Tube heaters)
 heating value of, 452
 blue (water gas), 216
 carbureted water-gas, 143, 232, 234
 city, 232, 248
 coal (coke-oven), 26
 mixed, 248
 natural, 50, 144, 247
 oil, 243-245
 producer, 216
 relations and correlations, 127-135, 142
 high-Btu, 216, 232, 244, 247-248, 452
 hydrogen sulfide in, 19, 20, 41-42, 44, 50, 71, 230, 240-242
 ignition temperatures (SIT), 191-197
 illuminants in, 21, 24, 26, 231-232, 452
 illuminating (*see* Carbureted water gas; City gas; Oil gas)
 laws, 97-100
 deviations from, 131, 145
 lifting (petroleum production), 36
 limits of inflammability, (II.), 195-202
 liquefied petroleum (LP), 248
 manufactured, 216-249 (*see* particular items)
 mixed, 248
 molar volumes of, 97-101
 molecular weight, calculations of, 75-76
 determination, 45-47
 natural, collection, 36-38
 in crude petroleum, 34-37
 dehydration, desulfurization of, 41-42
 occurrence and composition of, 29-35, 40, 452
 oil separator, 36-37
 sourness, 31, 41
 sulfur in, 41, 452
 supplies, 41, 247
 treatment of, 38-42
 oil fogging, 242-243
 oil, 243-248, 452
 Pintsch, 243
 polymerization of, 68-71
 producer, 23, 216-231, 452
 purification and treatment of (*see* Composition, etc.)
- Gas, radiation from, 316, 329-330, 359
 reaction equilibrium constants, chart of, 150
 refinery, 43, 50, 61-71, 140, 452
 reforming of, 247-248
 Siemens, 249
 standard conditions of, air and flue, 97, 100
 fuel, 128-133, 144
 sulfur in, 41-42, 50, 113, 134, 240-242
 water, 216, 218-219, 226, 231, 234, 452
 wet, 38-40, 48-49
- Gas stoves, 19
- Gasoil, 43-45, 60, 63-70
 (*See also* particular property or subject)
- Gasoline, alkylation, 69-70
 blending of, 43-45, 51, 94-95
 boiling range, 52-55, 58-60
 from coal, 26-27
 cracked, 43-45, 60-71
 distillation of, 52-54, 58
 doctor test, 31, 41, 44, 59
 gum in, 44, 59
 isomerization, 69-70
 knock characteristics, 54-56, 58-59, 61-63, 211-212
 natural, 38-41, 54, 55
 octane number (*see* Gasoline, knock characteristics)
 polymer, 43
 (*See also* Oils, polymerization of)
 reforming of, 66, 69
- Gasoline, Reid vapor pressure of, 54, 58, 82-84
 (*See also* Oils, vapor pressure)
 requirements of, 57-59
 sourness of, 31 (*See also* Gasoline, sweetening of)
 stabilization of, 39, 43-44
- Gasoline stoves, 278
 straight-run, 32, 44-45, 51
 sulfur in, 59, 135
 sweetening of, 40-41, 44
 vapor pressure of (*see* Reid vapor pressure)
 vapor recovery, 38, 43-44
 vaporization in engines, 58
 volatility of, 57, 58, 66
- Gay-Lussac's law, 97-98
- Girbotol process, 41
- Glass furnace, 216, 419-420

- Graphite, formation of, 3
 heat of combustion of, 130
- Grates (*see* Burners, coal; Stokers)
- Gravity (*see* Gas; Oil)
- Guldberg and Waage, 145
- Gum, in gasoline, and gum inhibitor, 44,
 45, 59
 liquid-phase, 241
 vapor-phase, 242
- Gunite, 364
- H**
- Half-life, kinetic, 153
- Head pressure (*see* Static pressure)
- Heat, 117-144
 balance on, boiler, 406
 carbureted water-gas set, 239
 cement kiln, 430-442
 combustion chamber, 330-331
 combustion operations, 137-139
 gas producer, 225
 industrial furnaces, 139-142
 petroleum tube heater, 399-405
 steam superheater furnace, 140-142
 of combustion, pure compounds (table
 of), 130, 451
 relations and correlations, 127-140,
 142-143
 temperature level and, 137
 typical fuels, 452
 (*See also* particular type of fuel)
 economy of, in furnaces, 408
 exchangers, 319, 322
 (*See also* Preheaters; Regenerators)
 of formation, 133-134, 431
 latent (of vaporization), petroleum
 fractions, 126-127
 pure compounds, discussion of, 125-
 126
 temperature level and, 137-138
 water, 100, 106, 108, 450
 losses, from furnace walls (*see* Furnace,
 walls of)
 from in pipes, 323-324
 nature of, 116-118
 recovery of (*see* Boilers, waste-heat;
 Furnace, accessories for)
 sensible (*see* Heat content; Heat,
 specific)
 specific, definition and units of, 119-
 120
 of hydrocarbon vapors, 123-124
- Heat, specific, of oils, 124-125
 of solids, 125
 of water, 119
- Heat capacity, definition of, 118-119
 of gases, 119-123
 of hydrocarbon vapors, 123-124
 of solids, 125
 of water, 119
 (*See also* Heat, specific)
- Heat content, calculation of, 120-127
 of metals, alloys, refractories, (table
 of), 469
 (*See also* Enthalpy; Heat, specific)
- Heat release, 358-360
 in boilers, 363, 377, 382
 in furnaces, 407
- Heat transfer, 316-332
 burning gases, 195-197
 combustion chamber, 330-331
 conduction, 316-320
 convection, 320-326
 (*See also* Furnace, walls of)
 duty (*see* Boilers)
 film coefficients, 320-326
 gas radiation, 316, 329-330, 359
 overall coefficients, 324-326
 in petroleum tubestills, 397-405
 by radiation, 326-331, 398-399
 refractories and walls, 345-347
 (*See also* Furnace, walls of)
- Heat units, 118-119
- Heaters (*see* particular type)
- Heating value, conversions of, 128-133
 definitions of, 118-119, 129
- Heating values (*see* particular type of
 fuel; Heat, of combustion)
- Hempel distillation, 33
- High-temperature fluid systems, 388-391
- HTS, 390-391
- Humidity, of air and flue gas, 105-112
 charts of, 108
 definitions of, 105-106
- Humidity temperature relations, 107-110
- Hydrocarbons, boiling points and proper-
 ties of, 451
 from coal tar, 24-27
 from petroleum, synthetic, 29-31
 vapor pressures, 79-81, 451
 (*See also* specific hydrocarbon; Gas,
 natural; Kinetics; Oil, cracking of;
 Oil, hydrogenation of)

Hydrocarbon hydrates, 42
 Hydroelectric power, 1
 Hydrogen (*see* particular subject)
 Hydrogen sulfide, 130, 134
 (*See also* Gas, hydrogen sulfide in)
 Hydrogenation, of coal, 26-27
 of ethylene, kinetics of, 149-151, 163
 of oils, 70-71

I

Ignition delay, 189, 193-195
 Ignition lag, 189, 193-195
 Ignition temperatures, of coal, 213, 308
 of gases and oils, 191-197
 Illuminants, in carburcted water gas,
 231-232, 452
 in coal gas, 21, 24, 452
 in oil gas, 244-245, 452
 Illuminating gas (*see* City gas)
 Induction period, combustion reactions,
 186-189
 Inflammability limits, 195-202
 Inspirator tube, 253
 Insulation, in furnace construction, 367-
 369
 of furnace walls, 357
 materials for (table of), 463
 of pipes, 323-324
 Internal energy (*see* Enthalpy; Heat)
 Isomerization, 69-70

J

Jig, in coal preparation, 8-11
 Jones process (oil gas), 245

K

Kaolinite, 340
 Kerosine (*see* Oils)
 Kilns, 407-442 (*see* Furnace)
 Kinetics, 152-179, 145-147, 181-187
 activated complex, 167-170
 activation energy, 160-171, 185
 catalysis and, 170-171
 chain reactions, 173-179, 182-187
 of combustion (*see* Combustion reac-
 tions)
 complex, consecutive, opposing, and
 side reactions, 171-172
 explosion limits, 176-179, 186-187
 free radicals, 174-179, 182-184, 186-
 187, 203

Kinetics, frequency factor, 161, 163, 167
 half-life, 153
 mechanisms, 159-179
 order of reactions, 153-160
 of petroleum cracking, 62-65, 164-165
 of producer- and water-gas reactions,
 217-219, 226
 rate constants and units, 153
 temperature coefficients, 161, 185-186,
 193-194
 thermal decomposition of hydrocar-
 bons, 153, 161-165
 of nitromethane, 157-158
 of oils, 164-165
 transition state concept, collision the-
 ory, 165-170
 (*See also* Combustion process)
 Kopp's rule, 125

L

Lampblack (*see* Soot)
 Latent heat (*see* Heat, latent)
 Le Chatelier's rule, 199-200, 209
 Limiting band, hydrocarbon conversion
 processes, 64
 Limits (*see* specific item)
 Liquids (*see* Oils or other specific heading)
 Log mean area, 319-320
 Log mean temperature difference, 319-
 320
 Louvers (*see* Ports, air)
 Lubricating oils, 43-45, 52, 71

M

Magnesite refractories, 343-344
 Mallard-Le Chatelier equation, 195-197
 Malleable-iron furnace, 417-418
 Manometers, 250-253
 Manufactured gas, 216-249
 (*See also* specific heading)
 Marshes, peat, 2
 Mass action, law of, 145, 153
 Material balance (*see* Stoichiometry)
 Maxwell vapor-pressure chart, 81
 Maxwell-Boltzmann curves, 165-166
 Mercury vapor systems, 389-390
 Metallurgical furnaces, 346-347, 412-425
 Minerals Yearbook (Bureau of Mines), 1,
 72
 Mining, coal, 6-10

Moisture (*see* Coal; Humidity)
 Molar heat capacity (*see* Heat, capacity of; Heat, specific)
 Molar units (*see* Units)
 Molar volumes, of gases, 97-101
 Momentum constant, gas-burners, 263
 Motor benzol, 24-26, 45
 Motor fuel (*see* Gasoline)
 Muffle furnace, 358, 408-409
 Mullite refractories, 338-339, 342-343
 Multiple-hearth furnace, 409, 423-424
 Multistage furnace, 362-363

N

Naphtha, coal tar, 25
 petroleum, 43-45 (*See also* Gasoline)
 Naphthalene, in carbureted water-gas manufacture, 240-241
 in coal tar, 25
 in oil gas, 246
 in petroleum hydrocarbon structures, 30
 Natural gas (*see* Gas, natural)
 Natural gasoline (*see* Gasoline, natural)
 Net heating value, 130-134, 138, 143
 Net hydrogen, 101-104, 136, 143
 Neumann reversion, 226
 Nitrogen (*see* Air; Coal; Oils; Combustion stoichiometry)
 Noise, burner flames, 189

O

Octane number (*see* Gasoline, knock characteristics of)
 Oil, ASTM tests, 53-60
 analyses of, API gravities, and heating values of, 452
 blending of, 43-45, 51-52, 74-95
 boiling points of, average, 87-93
 conversions of, 79-82
 latent heat and, 127
 boiling range of, 50-54, 55, 58-60
 relations, 87-88, 91-92
 bunker, 43, 45, 60, 236
 burners, 278-296 (*see* Burners, oil)
 burning, 59 (*see* Kerosine)
 burning of, 212, 360 (*See also* Burners, oil)
 carbon residue, 56, 59-60, 278
 carbureting, 231-248
 carbureting value, 238, 246

Oil, characterization factor (UOP), 86-94
 coefficients of expansion, 457
 combustion of (*see* Burners, oil; Combustion; Kinetics)
 conversion processes, 61-71
 cracking of, 43-44, 52, 61-71, 94, 164-165
 cracking stock (*see* Gasoil)
 crude, base, 32
 characterization, 32-33
 collection, 36-38
 constitution of, 30-33
 distillation of, 42-44, 399-405
 gasoline in, 32
 hydrocarbons in, 30-33
 dehydrogenation of, 62-65, 69, 71, 94
 density (*see* Gravity, API)
 diesel, 45, 51, 55-56, 59, 194
 distillation of, laboratory tests, 51-55, 87, 89
 range of, 55, 58, 60, 82
 evaluation tests, 50-60
 firing of, 212, 360
 flash points, 54, 55, 59, 60
 fuel specifications, 59-60
 (*See also* particular test)
 furnace, 43-45, 60
 gas, 243-248, 452
 gas separator, 36-37
 gasoil (*see* Gasoil)
 gravity, API determination, 58
 conversion tables, 453-457
 relations, 76-78
 heaters (*see* Boilers; Furnaces; Pre-heaters; Tube heaters)
 heating, 45, 56, 60
 heating values, 129-136, 142, 452
 hydrogen content, 93-94, 134-135, 142, 452
 hydrogenation of, 70-71
 ignition temperatures, 191-197
 kerosine, illuminating oil, manufacture of, 43-45
 range of test values, 55
 requirements of, 59
 latent heat of vaporization, 79
 lubricating, 43-45, 52, 71
 mineral seal, 59
 mixture properties of, 74-95
 molecular weight relations, 74-76, 91-92
 nitrogen and oxygen in, 32, 452

- Oil, polymerization of, 43, 61-70
 pour point, 57, 60
 proximate analysis, 74
 range, 60
 recycle (*see* Gasoil)
 refining of (*see* particular operation such as Oil, distillation, treating of, etc.)
 reservoirs, sands, wells, 33-36
 specific gravity (*see* Oil, gravity)
 specifications (fuel), 60
 straight-run fractions, 43-45, 51-53
 sulfur in, 31, 59, 134-135, 142, 452
 tar, 43-45
 (*See also* Oils, cracking of)
 test values, range of, 55, 60
 tractor fuel, 43, 45, 51, 53, 55, 59
 (*See also* Kerosine)
 treating of, 43-45
 true-boiling-point evaluation of, 51-53
 vapor pressure, charts of, 80, 81
 relations, 79-84
 (*See also* Gasoline)
 vaporization of, 126-127, 278, 401-404
 viscosity, conversion factors, 458-459
 determination, 56-57
 relations, 84-85, 89-91
 viscosity breaking, 66, 69
 water-white, 43, 45
 wax in, 31, 43, 57, 62, 94
- Open-hearth furnaces, 216, 417-420
- Organic acids, 24-25, 224
- Orifices, gas, 253-266
 oil, 281, 283
- Orsat analysis, by Orsat apparatus, 100, 102-104, 110-113
- Ovens (*see* Coking; Furnaces)
- Oxidation, in combustion (*see* Combustion; Kinetics)
- Oxygen (*see* particular subject)
- Oxygen bomb (calorimeter), 129, 132
- P**
- Paraffin hydrocarbons, burning velocities, 207
 cracking of, 61, 63
 inflammability limits, 198-202
 in petroleum, 30
 (*See also* Hydrocarbons; Oils)
- Paraffin wax, 31, 43, 57, 62
- Partial pressure, 98-101, 103
- Partial volume, 98-101
- Peat, 2
- Peroxides, in combustion (*see* Combustion process)
- Petroleum, 29-73
 (*See also* Oils; Gas)
 conversions, cracking, 60-71
 dehydration of, 37-38
 dirt, emulsions, and water in, 37-38
 formation of, 33-34
 fractions, fuels (*see* Oils)
 gas separator, 36-37
 hydrocarbons in, 30-33
 hydrogenation of, 70-71
 occurrence, 33-34
 oxygen and nitrogen in, 32, 452
 production of, 29, 34-38
 recovery of, 29-30
 secondary, 36
 refining, 42-45
 reserves, 29
 sourness of, 31
 structure of, 30-33
 sulfur compounds in, 31
 supplies 29-30
 water disposal, oilfield, 38-39
- Phenanthrene, phenol, 25
- Phenolate process, 41
- Phosphorus manufacture, 415
- Pintsch gas, 243
- Pipe, heat loss from, 322-326
- Pipe sizes and data, 460
- Pitot tube, 250-252
- Planck's constant, 168
- Poise, 458
- Polymerization (*see* Oils, cracking of, polymerization of)
- Ports, air, 257, 259, 263-264, 292-294, 306, 312-313, 370-371, 410-411, 418
 gas (burner), 254-275, 418
- Pound-centigrade unit (Pcu), definition, 118, 119
- Pour point (oils), 57, 60
- Power generation (*see* specific heading)
- Precipitators (Cottrell, electrical, electrostatic), fly-ash removal, 315
 tar removal, 24, 224, 241
- Preheaters, air, 216, 304, 313, 426-430
 (*See also* Recuperators; Regenerators)
 oil, 287-288, 382
- Pressure, equivalents, 451
 (*See also* specific headings)
- Producers (gas), 23, 216-231, 452

- Proximate analysis, of coal (*see* Coal)
of oils, 74
- Psychrometry (*see* Humidity)
- Pulverized coal, 18, 213-214, 307-312,
361-363, 371-372, 384
- Pulverizers, coal, 308-312
- Pumps, air (compressors, fans), 290-293
oil, 286-287, 290-291
- Pyridine, 25
- Pyrites (iron) in coal, 10, 13-15, 20,
112, 136
- Pyrometric cones, 333-334, 336, 338, 340,
350, 354
- Q
- Quartz, 336-338
- R
- Radiation, heat (*see* Heat transfer)
- Raoult's law, 82
- Rates (*see* specific subjects; Combustion;
Kinetics; Firing; etc.)
- Reactions, dissociation, 146
free energy of, 147-152
kinetics of (*see* Kinetics)
reversible, 145
(*See also* specific reaction or subject)
- Recuperators, 216, 426-428
- Referees' apparatus, 50
- Refinery gas (*see* Gas, refinery)
- Reforming, gas, 247-248
gasoline, 66, 69
- Refractories, 333-357
alumina-silica, 338-343
chrome, 345
densities, 350-352
dolomite, 344
fireclay, 337-342
fluxing and slagging of, 343-350
forsterite, 344-345
furnace atmospheres, effect of, 350
fused-cast, 342
fusing points of, 346-350
high-alumina, 338-340, 342
kaolinite, 340
magnesite, 343-344
mortar, 349, 363-364
mullite, 338-339, 342-343
petrology of, 335
phase equilibrium diagrams, 339, 348-
349
porosity, 350-352
power-press process, 342
- Refractories, pyrometric cones, PCE,
333-334, 336, 338, 340-341, 350, 354
reaction temperatures of, 347
refractoriness diagram, 339
service conditions, 346-352, 356-357
silica, 336-338
silicon carbide, 345-346, 408-409, 426-
427
spalling of, 352-354
spinels, 345
summary of properties, 354
thermal conductivity, 354-355
(*See also* Thermal conductivity)
thermal expansion, 337
- Refuse fuels, 300-301
- Regenerators, 23, 414, 418-419, 428-430
- Reheating furnace, 409-410
- Reid vapor pressure, 54, 58, 82-84
- Resins, 62
- Retort furnaces, 409
- Reverberatory furnace, 417
- Reynolds number, 251-253, 320
- Roofs (*see* Furnace, roofs of)
- Rotary drier, 423
- Rotary kiln, 420-423, 430-442
- S
- Salt, in coal, 10, 13
in crude oil, 37-38
high-temperature fluid (HTS), 390-391
- Saturation (*see* Gas, wet; Humidity;
Steam)
- Saturator (ammonia), 24
- Saybolt viscosity, 57, 60, 458-459
- Screening, sieves, 8, 10-11, 16-17
- Scrubbers, washers, carbureted water-
gas, 233-234, 241
coke-oven gas, 23-24
oil gas, 245, 246
producer gas, 224
SO₂ gas, 425
- Seaboard process, 41
- Semicoke, 24
- Sensible heat (*see* Enthalpy; Heat con-
tent)
- Separators, crude oil-water, 37-38
cyclone (dust), 221, 224, 313-315, 430
fly-ash, 313-315
oil-gas, 36-37
Pelouze and Andouin (P & A), 224, 241

- Separators, tar-water, 240
(*See also* Precipitators)
- Shaft furnaces, 414-417
- Shale, 5, 13, 15
- Sharp-edged orifice, 253
- Shutters (*see* Ports, air)
- Siemens gas, 249
- Silica (refractories), 336-338
- Silicon carbide, 345-346, 408-409, 426-427
- Slag, adherence of, to furnace walls, 361-363
compositions, eutectics, and fusing points of, 346-350
- Slag-tap furnace, 361-363
- Slate, 8
- Smelting furnaces, 414-419
- Smoke (*see* particular type of burner, fuel, or furnace operation)
- Smokeless fuel, 24, 26
- Soot, from burning of coal, 18
of gas, 203
of oil, 60
in carbureted water gas, 234, 240-241
in coke-oven gas, 23
in oil gas (lampblack), 245-247
in producer gas, 224
- Sourness (*see* Gas, natural; Gasoline; Oil)
- Specific gravity (*see* particular material; Density; Gravity)
- Specific heat (*see* Heat, specific)
- Spectrometer, discussion of uses, 121, 184, 186
- Spontaneous ignition, of coal, 19-20, 308
of gases and oils, 191-197
- Spray nozzles, oil burner, 281
- Sprung arches, 351-353, 363-366
- Stabilization, of gasoline, 39, 43-44
- Stacks (*see* Chimneys)
- Static pressure, 250-254
(*See also* context of particular subject)
- Steam, table of properties, 450
- Steam boilers, generation of (*see* Boilers)
- Steam superheaters, 140-142, 385-386, 400
- Steel furnace, open-hearth, 418-419
- Stefan-Boltzmann law, 327
- Stills (*see* Distillation; Tube heaters)
- Stoichiometry, combustion, 96-116
gas producer, 227-231
- Stoke, 458
- Stokers, 297-315
domestic, 297
overfeed, 300-301
retort, 301-305
spreader, 300-301
traveling-grate, 305-307, 366, 368, 382
underfeed, 301-305
- Stoves, blast-furnace, 414, 428
cook, domestic, gas, heating, oil, 19, 275, 278
- Straight-run gasoline, 32, 44-45, 51
- Strainers, oil burner, 289-290
- Sulfur compounds, combustion of, 100-102, 112-113, 130-138
in petroleum, 31
(*See also* parent fuels; Hydrogen sulfide; Pyrites)
- Sulfur content of fuels (*see* particular type of fuel)
- Sulfur dioxide manufacture, 423, 425
- Sulfuric acid, in coke-oven product refining, 23-24
in petroleum refining, 44
- Surface combustion, 210
- Suspended arches and walls, 366-369
- Sweetening, of natural gasoline, 40
of refinery gasolines, 44
- T
- Tank furnace (glass), 419-420
- Tar, carbureted water-gas, 234, 238, 240-241
coal, 24-27
cracked, 45, 60-68
oil gas, 244, 246
producer gas, 223-225, 230
- Temperature, 116-144
color scale for, 468
conversion table, 447-448
ignition, of coal, 213, 308
of gases and oils, 191-197
scales, 98, 100, 118-119
(*See also* particular subject)
- Tetraethyl lead (*see* Ethyl fluid)
- Thermal conductivity, calculations of, 317-326, 331-332, 354-355
of refractories, 354-355
tables of, 462-464
(*See also* Furnace walls)
- Thermal decomposition (*see* Coal, coking of; Oils, cracking of; Kinetics)

- Thermal expansion, in firebox construction, 364
 of refractories, 337
 Thermoform kiln, 425-426
 Tipple, 8-10
 Toluene, in carbureted water-gas tar, 240
 from coking of coal, 24-26
 from petroleum, 68
 Towers (*see* Absorption; Distillation; Scrubbers)
 Tractor fuel (*see* Oils)
 Treating, of gases (*see* Gas, composition, properties, and purification of) of oils, 43-45
 True-boiling-point apparatus, evaluation of, 51-53
 Tube heaters, 377-406
 boilers (*see* Boilers)
 construction, 364
 high-temperature fluid, 388-391
 petroleum, 391-405
 in cracking processes, 66-67
 design and operation of, 397-399
 evolution of, 391-392
 heat-transfer coefficients, 398-399
 heat-vaporization balance (illustration), 399-405
 steam superheaters, 140-142, 400
 Tunnel kilns, 409-412
 Tuyères, 414, 417
- U
- Ulmins, 4
 Ultimate analysis, of coal, 12, 452
 of oils, 452
 (*See also* Oils, hydrogen content of)
 Units, conversion factors, 99-100
 (*See also* Appendix, 444-470)
 molar, 96-99
- V
- Vacuum in combustion chamber, 369-370
 Van't-Hoff equation, 149, 161
 Vaporization (*see* Humidity; Oils, distillation of, vaporization of)
 Vaporizing burners, 278
 Vapor pressure, hydrocarbons, mixtures, 79-84, 451
 Reid, 54, 58, 82-84
 steam, 450
 water (30 to 219°F.) 449
- Velocity (*see* particular subject)
 Velocity pressure, 250-254
 Venturi tube, 252
 Viscosimeters, 56-57
 Viscosity (*see* Oils)
 Visual aids, list of, 473
 Vitrain, 4-5
 Volatility, of gasoline, 57, 58, 66
- W
- Wash box, 232-237, 240, 244-245
 Washers, gas (*see* Scrubbers)
 Washing of coal, 8-11
 Waste fuels, 300-301
 Waste-heat boilers, 239, 387-388, 425
 Water, drive, flooding oilfields, 36
 thermodynamic properties of (*see* particular property)
 Water gas (*see* Gas)
 Water heaters, 265-266
 Water vapor (*see* Humidity; Steam)
 Water walls (boiler), 356, 361-369
 Wax (paraffin), 31, 43, 57, 62
 Wet-and-dry-bulb temperatures, 109-110
 Wet-and-dry-bulb thermometers, 109-110
 Wind belt, 416
 Wind box, 292, 294, 416
 Wind furnace, 417-418
 Wind load, 375
- X
- Xylenes, 24-26
- Z
- Zones, in blast furnaces, 415
 in boiler furnaces, 362-363, 385
 in boiler tubes, 386
 in bunsen flames, 195-197, 202-206
 of explosion, 185
 in fuel beds, 216-218, 299-300
 in gas producers, 218-219, 225-226
 in glass furnaces, 419-420
 in multiple-hearth furnaces, 424
 of nonignition, 186, 192-193
 of pulverized coal flames (combustion stages), 213-214
 in rotary kilns, 421, 430
 in shaft furnaces, 414-417
 in tube heaters (sections), 392-397
 in tunnel kilns, 409-411

