

# Birla Central Library

PILANI (Jaipur State)

Class No :- 630.954

Book No :- M85H

Accession No :- 5649







HANDBOOK  
OF  
INDIAN AGRICULTURE

BY

*The Late* NITYA GOPAL MUKERJI, M.A.

*Holland Gold Medallist of the Royal Agricultural College, Cirencester (England)*  
*Fellow of the Highland and Agricultural Society (Scotland)*  
*and Professor of Agriculture and Agricultural Chemistry, Civil Engineering*  
*College, Sibpur (Bengal)*

FOURTH EDITION

BEING

A reprint of the Third Edition edited by a senior officer of the  
Indian Agricultural Department:

*"Discoveries made in the cultivation of the earth are not merely for the time and country in which they are developed, but they may be considered as extending to future ages, and as ultimately tending to benefit the whole race, as affording subsistence for generations to come, as multiplying life, and not only multiplying life, but likewise providing for its enjoyment."*—Sir Humphrey Davy.

CALCUTTA AND SIMLA  
THACKER, SPINK & CO

1923

PRINTED BY  
**THACKER, SPINK & CO.,**  
CALCUTTA.

DEDICATED  
TO  
THE HON'BLE MR. CHARLES EVELYN ARBUTHNOT  
WILLIAM OLDHAM  
OF THE INDIAN CIVIL SERVICE, LATE DIRECTOR OF AGRICULTURE, BENGAL  
AS A TOKEN  
OF  
HIGH ESTEEM AND DEEP GRATITUDE

## SYLHET LIME AS FERTILIZER.

**T**HE value of Lime as a Fertilizer has been conclusively proved by actual experiments both in the field and in the laboratory. Sylhet Lime has this fertilizing property to a wonderful extent. In India a very large quantity of Lime is used every year by Tea gardens with remarkably good result and satisfaction. This peculiar property of Sylhet Lime is due to the high percentage of Calcium and to the absence of substances injurious to the growth of trees. Its chemical composition shows a percentage of Calcium much higher than can be usually obtained from any other lime in India. Besides its Chemical properties it has unique physical properties inasmuch as being held in colloidal condition Calcium is easily assimilated by the soil. It has been proved without doubt that Lime is one of the materials fundamentally necessary to the growth of crops and also not only it is an essential food but it serves another important auxiliary purpose of increasing the efficiency of other fertilizers that may be required by the soil. It exercises a most beneficial influence on the microscopic bacteria which convert the Nitrogen in the organic matter in the soil and manures into the form of Nitrate for absorption by the plants. In fact the use of Lime in plant economy is essential and of multifarious character. Present day researches of the scientist are bringing these facts into light for the use of the public.

*Apply for Directions for use.*

**SYLHET LIME COMPANY, LIMITED.**

*Managing Agents :*

**KILBURN & CO.**

**25, Swallow Lane,**

**Calcutta.**

## PREFACE TO FIRST EDITION.

THE publication of the Sibpur Lectures in the form of a Handbook was found necessary owing to the want of a text-book on the whole subject of Indian Agriculture suitable for the use of advanced students. It is not possible to learn agriculture from a text-book, apart from a farm, and to learn the subject in a systematic manner, a museum and a laboratory are also necessary. Even one passing out of an agricultural college which is equipped with a farm, laboratory, and museum, and possessing a thorough knowledge of a text-book, must be prepared to buy his experience, either by apprenticeship in another person's farm, or by losing money on his own, for a year or two, before he can expect to acquire confidence in himself, his crops and his methods. Book-knowledge and college-education must be supplemented by detailed experience in that particular department of agriculture which one chooses to take up, in any particular locality, before one can expect to be a successful farmer. A book, however, is a valuable aid to the student and also to the man engaged in planting or farming. The Handbook of Indian Agriculture pretends to little originality. Facts which now lie scattered in hundreds of Reports, Notes, Monographs, Ledgers and Journals, have been brought together here in one volume and treated in a systematic manner. But even as a compilation the author hopes, that it will prove a useful companion to planters and students of agriculture generally.

CIVIL ENGINEERING COLLEGE, SIBPUR,

*The 11th August, 1901.*

N. G. MUKERJI.

ADVERTISEMENT.

# ALLEN BROS. & Co. (India), Ltd.

*Will be pleased to advise  
you on any matter regarding  
Soil Fertility and the Scientific  
application of Organic  
and Inorganic Fertilisers*



**FACTORIES AT**

**CALCUTTA, · CAWNPORE,  
MADRAS, & DELHI**



**HEAD OFFICE**

**“ALLEN HOUSE”**

**Telephone  
No.  
5140.**

**7, HARE STREET  
CALCUTTA**

**Telegrams :  
“Capricorn”  
Calcutta.**

## CONTENTS.

|   | <i>Page</i> |
|---|-------------|
| INTRODUCTION .. .. .  | I           |
| PART I—SOILS.   |             |
| CHAP. I. Geological Strata .. .. .                            | 11          |
| „ II. Surface Geology of Bengal Districts .. .. .             | 19          |
| „ III. Formation of Soils .. .. .                             | 24          |
| „ IV. Physical Classification of Soils .. .. .                | 31          |
| „ V. Chemical Classification of Soils .. .. .                 | 36          |
| „ VI. Chemical Classification of Indian Soils .. .. .         | 45          |
| „ VII. Physical Properties of Soils .. .. .                   | 54          |
| „ VIII. Sunlight, Rain and Hail .. .. .                       | 61          |
| „ IX. Fertility and Barrenness .. .. .                        | 68          |
| PART II—IMPLEMENTS.   |             |
| „ X. Theories Underlying Cultivation .. .. .                  | 72          |
| „ XI. Motive Power or Prime Movers .. .. .                    | 79          |
| „ XII. Ploughs and Ploughing .. .. .                          | 94          |
| „ XIII. Other Cultivation Appliances .. .. .                  | 110         |
| „ XIV. Theories Underlying the Question of Irrigation .. .. . | 116         |
| „ XV. Water-Lifts .. .. .                                     | 122         |
| „ XVI. Other Agricultural Implements .. .. .                  | 138         |
| „ XVII. Equipments of Farms .. .. .                           | 141         |
| PART III—CROPS.   |             |
| „ XVIII. Botanical Classification of Crops .. .. .            | 145         |
| „ XIX. Economic Classification of Crops .. .. .               | 149         |
| „ XX. Chemical Composition of the Principal Crops .. .. .     | 151         |
| „ XXI. Agricultural Statistics .. .. .                        | 153         |
| „ XXII. Systems of Farming .. .. .                            | 155         |
| „ XXIII. Rotation of Crops .. .. .                            | 161         |
| „ XXIV. Rice .. .. .  | 166         |
| „ XXV. Paddy Husking .. .. .                                  | 181         |
| „ XXVI. Wheat .. .. .   | 187         |
| „ XXVII. Barley .. .. .                                       | 192         |
| „ XXVIII. Oats .. .. .  | 194         |
| „ XXIX. Bhutta or Indian Corn ✓ .. .. .                       | 195         |
| „ XXX. Juar or Great Millet ✓ .. .. .                         | 197         |
| „ XXXI. Marua or Ragi and other Lesser Millets ✓ .. .. .      | 200         |
| „ XXXII. Buck-wheat .. .. .                                   | 202         |
| „ XXXIII. Pulses .. .. .                                      | 203         |
| „ XXXIV. Oil seeds .. .. .                                    | 203         |



|       |          | PART III—CROPS—(contd.)                           | Page. |
|-------|----------|---|-------|
| CHAP. | XXXV.    | Mustard and Rape .. .. .                          | 211   |
| "     | XXXVI.   | Linseed .. .. .                                   | 214   |
| "     | XXXVII.  | Gingelly or Til .. .. .                           | 216   |
| "     | XXXVIII. | Sorguja or Niger Oil Seed .. .. .                 | 216   |
| "     | XXXIX.   | Castor .. .. .                                    | 217   |
| "     | XL.      | Ground-nut .. .. .                                | 221   |
| "     | XLI.     | Cocconut .. .. .                                  | 223   |
| "     | XLII.    | Mahua .. .. .                                     | 225   |
| "     | XLIII.   | Safflower .. .. .                                 | 226   |
| "     | XLIV.    | Jute .. .. .                                      | 228   |
| "     | XLV.     | Deccan or Bombay Hemp .. .. .                     | 234   |
| "     | XLVI.    | Sunn-Hemp .. .. .                                 | 236   |
| "     | XLVII.   | Rhea .. .. .                                      | 237   |
| "     | XLVIII.  | Cotton .. .. .                                    | 242   |
| "     | XLIX.    | Aloe Fibre .. .. .                                | 248   |
| "     | L.       | Other Fibre Crops .. .. .                         | 250   |
| "     | LI.      | Pineapple .. .. .                                 | 252   |
| "     | LII.     | Plantains .. .. .                                 | 253   |
| "     | LIII.    | Potato .. .. .                                    | 256   |
| "     | LIV.     | Brinjal .. .. .                                   | 261   |
| "     | LV.      | Patal .. .. .                                     | 263   |
| "     | LVI.     | Chillies .. .. .                                  | 264   |
| "     | LVII.    | English Vegetables .. .. .                        | 266   |
| "     | LVIII.   | Carrot, Radish and Sweet Potatoes .. .. .         | 270   |
| "     | LIX.     | Turmeric and Ginger .. .. .                       | 272   |
| "     | LX.      | Sugarcane .. .. .                                 | 274   |
| "     | LXI.     | The Date-Sugar .. .. .                            | 289   |
| "     | LXII.    | Sugars .. .. .                                    | 296   |
| "     | LXIII.   | Indigo .. .. .                                    | 300   |
| "     | LXIV.    | Tobacco .. .. .                                   | 305   |
| "     | LXV.     | Pan or Betel-leaf .. .. .                         | 313   |
| "     | LXVI.    | Betel-nut .. .. .                                 | 316   |
| "     | LXVII.   | Camphor, Tejpata, and Cinnamon .. .. .            | 317   |
| "     | LXVIII.  | Other Spices .. .. .                              | 320   |
| "     | LXIX.    | Opium .. .. .                                     | 322   |
| "     | LXX.     | Tea .. .. .                                       | 325   |
| "     | LXXI.    | Coffee .. .. .                                    | 330   |
| "     | LXXII.   | Vanilla .. .. .                                   | 335   |
| "     | LXXIII.  | Papaya .. .. .                                    | 338   |
| "     | LXXIV.   | Cassava as Famine Food .. .. .                    | 339   |
| "     | LXXV.    | Arrowroot .. .. .                                 | 345   |
| "     | LXXVI.   | Bamboo, Grewia, Mat-Grass and Euisa Grass .. .. . | 346   |
| "     | LXXVII.  | Oranges .. .. .                                   | 348   |
| "     | LXXVIII. | India-rubber and Gutta-Percha .. .. .             | 350   |
| "     | LXXIX.   | Sericulture .. .. .                               | 353   |
| "     | LXXX.    | Lac-culture .. .. .                               | 381   |
| "     | LXXXI.   | Apiculture .. .. .                                | 384   |
| "     | LXXXII.  | Propagation of Trees .. .. .                      | 385   |
| "     | LXXXIII. | Agricultural Calendar for Lower Bengal .. .. .    | 394   |

|  |   | <i>Page.</i> |
|--|---|--------------|
| <b>PART IV—MANURES</b>                   |   |              |
| CHAP. LXXXIV.                            | General Summary .. .. .                                       | 397          |
| „ LXXXV.                                 | Exhaustion, Recuperation and Absorption .. .. .               | 402          |
| „ LXXXVI.                                | Nitrogenous Manures .. .. .                                   | 409          |
| „ LXXXVII.                               | Phosphatic Manures .. .. .                                    | 427          |
| „ LXXXVIII.                              | Potash Manures .. .. .  | 433          |
| „ LXXXIX.                                | Calcareous Manures .. .. .                                    | 439          |
| „ XC.                                    | Gypsum and Salt .. .. .                                       | 443          |
| <b>PART V—METHODS OF ANALYSIS.</b>       |   |              |
| „ XCI.                                   | General Remarks .. .. .                                       | 448          |
| „ XCII.                                  | The Standard Acid and Alkali .. .. .                          | 450          |
| „ XCIII.                                 | Analysis of Soil .. .. .                                      | 452          |
| „ XCIV.                                  | Analysis of Bone-meal .. .. .                                 | 457          |
| „ XCV.                                   | Analysis of Superphosphate .. .. .                            | 460          |
| „ XCVI.                                  | Analysis of Nitrate of Soda and Saltpetre .. .. .             | 464          |
| „ XCVII.                                 | Analysis of Oil-cake .. .. .                                  | 467          |
| „ XCVIII.                                | Analysis of Silage, Grass, etc. .. .. .                       | 472          |
| „ XCIX.                                  | Water Analysis .. .. .  | 474          |
| <b>PART VI—CATTLE.</b>                   |   |              |
| „ C.                                     | Buffaloes .. .. .   | 476          |
| „ CI.                                    | Oxen .. .. .  | 478          |
| „ CII.                                   | Goat-keeping .. .. .  | 487          |
| „ CIII.                                  | Calculation of weight of Livestock .. .. .                    | 487          |
| „ CIV.                                   | Poultry-keeping .. .. .                                       | 488          |
| „ CV.                                    | Diseases of Cattle .. .. .                                    | 492          |
| „ CVI.                                   | The Theory of Health in Relation to Foods and Fodders .. .. . | 497          |
| „ CVII.                                  | Utility of Growing Fodder Crops .. .. .                       | 501          |
| „ CVIII.                                 | Fodder Crops .. .. .  | 502          |
| „ CIX.                                   | Silos .. .. .   | 507          |
| „ CX.                                    | Proteid Ratio .. .. .   | 511          |
| „ CXI.                                   | Manurial Value of Food-stuffs .. .. .                         | 515          |
| „ CXII.                                  | Milk .. .. .  | 517          |
| „ CXIII.                                 | Cream and Butter .. .. .                                      | 520          |
| „ CXIV.                                  | Cheese-making .. .. .   | 523          |
| „ CXV.                                   | Bacon and Ham-Curing .. .. .                                  | 527          |
| „ CXVI.                                  | Curing Sheep and Other Skins .. .. .                          | 529          |
| <b>PART VII—INSECT AND FUNGUS PESTS.</b> |   |              |
| „ CXVII.                                 | General Remedies against Pests and Parasites .. .. .          | 531          |
| „ CXVIII.                                | Agricultural Zoology .. .. .                                  | 535          |
| „ CXIX.                                  | Insects .. .. .   | 540          |
| „ CXX.                                   | Locusts .. .. .   | 551          |
| „ CXXI.                                  | Grasshoppers and Crickets .. .. .                             | 554          |
| „ CXXII.                                 | Granary Pests .. .. .   | 555          |
| „ CXXIII.                                | Paddy Pests .. .. .   | 557          |
| „ CXXIV.                                 | Cut-Worms .. .. .   | 559          |
| „ CXXV.                                  | The Sugarcane Borer .. .. .                                   | 561          |
| „ CXXVI.                                 | White-ants and other Ants .. .. .                             | 563          |

| PART VII—INSECT AND FUNGUS PESTS—(contd) |  | Page.  |
|--|--|--------|
| CHAP.                                    | CXXVII. The Mango Weevil .. ..                                     | .. 565 |
| „  | CXXVIII. The Indian Golden-Apple-Beetle .. ..                      | .. 566 |
| „  | CXXIX. Plant-Lice and Scale-Insects .. ..                          | .. 567 |
| „  | CXXX. Insects Injurious to Indian Crops .. ..                      | .. 568 |
| „  | CXXXI. Zymotic Diseases and Remedies for Them .. ..                | .. 572 |
| „  | CXXXII. Agricultural Bacteriology .. ..                            | .. 575 |
| „  | CXXXIII. Dairy Bacteriology .. ..                                  | .. 581 |
| „  | CXXXIV. Soil Bacteriology .. ..                                    | .. 585 |
| „  | CXXXV. Vaccines and their Preparation .. ..                        | .. 587 |
| „  | CXXXVI. The Higher Fungi .. ..                                     | .. 593 |
| „  | CXXXVII. Mushrooms .. ..   | .. 600 |
| PART VIII—FAMINES.                       |  |        |
| „  | CXXXVIII. General Remarks on Indian Famines .. ..                  | .. 601 |
| „  | CXXXIX. The System of Land Revenue as Affecting the Question .. .. | 605    |
| „  | CXL. Measures of Protection and Relief .. ..                       | .. 609 |
| „  | CXLI. Agricultural Education .. ..                                 | .. 612 |

## INTRODUCTION.

[Progress of agricultural improvement within recent years; Favourable report on work of Saidapet College; Agricultural improvements already introduced, manifold. The system of Southern India worth following; The aim of the Handbook; No agricultural depression in India, Resources in normal years on the increase; Gentlemen farmers in India; Cultivation by partnership; Special courses of farming by expenditure of capital; Need for agricultural education among Revenue Officers; Conservatism of Indian *rayats*; Need for agricultural education in Engineering Colleges; Canal and well irrigation; Profitableness of canal irrigation to the State as well as *rayat*; Knowledge of agricultural science important for Canal Officers; Need of special scheme of agricultural education for agricultural classes; Division of subjects.]

THE inauguration of agricultural education in the different provinces of India is one of the outcomes of the deliberations of the Famine Commission that was sent out to India at the instance of the British Parliament in 1878. The Famine Commission submitted their Report in 1880, and during the period since that date the recommendations of this Commission have been kept steadily in view by Government, and given effect to, one after another. Canals and railways, the most important measures of protection against famine, have been extended since then with great rapidity, and a definite scheme of irrigation for the different provinces adopted. The systems of land administration and police administration have been greatly improved, chiefly with a view to give security of possession to cultivators, and to obtain correct statistics and prompt information regarding agricultural conditions and agricultural depressions. By the institution of agricultural experiments and agricultural education, a foundation has been laid for ascertaining facts with a view to increasing and improving the produce of land, and diffusing agricultural knowledge among the cultivating classes. The establishment of the Pusa Research Institute, of a College of Agriculture in each province, and the gradual institution in every province of a practical system of agricultural education in villages, are the most recent developments. The establishment of semi-official agricultural associations in district after district is a further means of making the results of agricultural experiments achieved in experimental farms known to the actual cultivator. I have endeavoured to remove the want of a text-book by publishing a book on agriculture in Bengali and one in Uriya, suitable for use among cultivating classes.

So satisfactory has been the result of agricultural education in Madras, where it has been the longest established, that a committee appointed by Government to report on the working of the agricultural department and the agricultural college of Madras, attached the highest importance to the agricultural education imparted in the college and the schools, and they devoted more than half their report to this subject.

It is often said that the native agricultural practices are the best for India and that they are not capable of improvement. I was surprised to find during my tours of 1898 and 1904 to 1906, that the native agricultural practices of the Madras, Bombay and the Central Provinces are far in advance of those of Bengal and the United Provinces of India. If agricultural education has been found beneficial in the Madras Presidency, where the existing system of agriculture is really superior, how much more beneficial will it be for Bengal, which is so backward! We have not only to benefit from our knowledge of western science and western practices, but we have also to learn the superior practices followed by the non-Aryan races of South India. Indeed, Indian agriculture has been actually vastly improved by our contact with the West. European planters have been the means of introducing important innovations. In the most out-of-the-way places of India we find European planters imperceptibly and noiselessly carrying on agricultural experiments and improvements. We find them growing the most delicate English vegetables even during the hot weather by cultivating them in trenches. Some of our commonest articles of food and fodder have been introduced by Europeans. Maize, oats, potatoes, tobacco, cabbages, beet, papaya, the superior varieties of plantains, lucerne and guinea-grass, are all exotics. Indeed, there are few English cereals, root-crops, vegetables and fruits that have not been introduced with success into India, and European farm implements are in common use in some plantations. It is difficult to think of any agricultural experiments that have not been already tried, successfully or unsuccessfully, by European planters. Even the steam-plough, which is still considered an expensive luxury in Europe, has been tried by planters within my own knowledge.

The aim of this book will be to consider how soils can be made to yield more than they do, how irrigation can be made possible for the poor *raiyat*, how to extend the cultivation of drought-resisting crops, how to preserve, without damage, food and fodder, the excess production of one year, for years of scarcity, how to organise measures of protection against famine. These pages will be mainly devoted to the consideration of the food and other necessities of life or what can become food, etc. for the masses. They will discuss only such appliances and machinery as can be used by the *raiyat* individually or collectively. They will analyse only such manures as may be placed within easy reach of

the *raiyat*. They will explain the means of getting rid of, and of avoiding, pests and parasites that are so destructive to ordinary crops. In one word, this handbook hopes to be able to be a guide, philosopher and friend, to the actual tiller of the soil and be the means of ameliorating his condition. Seventy per cent. of the people of India live directly by farming, and it is of paramount importance to study those questions which affect so large a proportion of the population of India. In no other country in the world does such a large proportion of the population depend on agriculture. In England only 7½ per cent. of the population live by agriculture.

The agricultural condition of India is not to be considered as being in a specially depressed condition, as it is in some countries of Europe. Except for the periodic recurrence of famines, local or general, which has always occurred and still occurs in India, and particularly within recent years, the agricultural population of India may be regarded as being in a prosperous condition. The area under cultivation is steadily increasing; exports of food-grains, which represent surplus stocks, have been also increasing, notwithstanding increase of population, and the rental and revenue from land are growing. There are few cases in India of lands, going out of cultivation, and farmers being ruined and emigrating to foreign countries in quest of a living. In spite of his debts, which are a hereditary thing with the Indian *raiyat*, we do not find many cultivators alienating their holdings and going in for other trades. Many crafts and trades have suffered of late years, but not agriculture. The agricultural produce of other lands has not been able to compete with India's own products, and she has always more and more to spare for the needs of other countries. The famine of 1897 in Bengal went to show that the resources of the masses had increased of late years. The failure of crops all over India since 1896 has been unprecedented, and, if this had taken place twenty years or even ten years earlier, the havoc among the agricultural population would have been terrible. But the resources of the country have been developing steadily for over half a century. It is a significant fact that, during the sixty-one years ending the 31st March, 1896, India imported foreign merchandise to the value of Rs. 19,31,00,00,000, while during the same period the value of her exports amounted to as much as Rs. 30,64,00,00,000. Her exports therefore exceeded her imports by Rs. 11,33,00,00,000. Of course, the whole of this does not represent so much into the pockets of the Indian peasantry. But that Indians, and especially Indian cultivators, have materially benefited by this excess of export of indigenous produce can be inferred from the fact that, during the same period, the balance of import of gold over export was of the value of Rs. 1,46,68,00,000. Of this only Rs. 2,44,40,000 worth of gold was used during the sixty-one years in the mint for coinage, and the balance of gold to the value of Rs. 1,44,00,00,000 must have been absorbed by the people, chiefly in making articles

of jewellery, which are pawned largely in famine times. To take a concrete example like jute, at the price of Rs. 10 a maund, fifteen maunds being taken as the average produce per acre, the *riayats'* share of the outturn may be regarded as Rs. 100 per acre, while the remaining Rs. 50 are shared by the Indian middleman and the European exporter. Poor as the Indian *riayat* has always been, his poverty is not so intense now as it used to be, and he can afford to spend money on little luxuries which his forefathers never dreamt of enjoying. The ambition of the landless labourer is to buy land and to become an agriculturist. The man who earns Rs. 10 or Rs. 12 a month in a Calcutta mill also looks forward to saving enough money for buying land and cattle and settling down as an agriculturist. Surely agriculture pays and it is not in that depressed condition in which it happens to be in some countries in Europe.

Let me not be misunderstood. I do not mean agriculture will pay a "gentleman." It is only by dint of hard labour and frugality that the Indian cultivator makes agriculture pay him. If a gentleman were to employ labourers and go in for ordinary farming, he will find these labourers (so industrious when working for themselves) sleeping over his work and accomplishing very little when pretending to be doing work actually in his presence. He can never compete with the actual cultivators in ordinary agriculture, as by their frugality and industry they will be able to get their outturn at a smaller cost and thus undersell him. He may succeed with a new crop, but only for a time. When the cultivator finds out how he grows it, and where he sells it, he (the cultivator) will grow it at a smaller cost and put it on the market at a smaller price. I have taught scientific methods of sericulture during eleven years to a large number of persons, among whom are a number of actual cocoon-rearers. It is these latter alone who are carrying out the new methods with profit, while all the educated men who have gone in for it have lost money. In a climate like that of India, agricultural industry is unsuitable for men who cannot be in the field with their labourers.

Capitalists and educated men can derive profit from agriculture by acting as middlemen.—finding land, seed, manure and appliances for cultivators, and using their labour and their cattle and sharing with them the profits. Cultivation by partnership is indeed a well-recognised system in Bengal, and, if trained agriculturists go in for it largely, this system may prove to be of the highest benefit in introducing superior staples and superior methods of cultivation. One has, say, five-hundred bighas of land. He gets some cultivators of the neighbourhood to go in partnership with him and to give him half the produce. He gives them seed, well-selected and of superior kinds; he finds them superior appliances for irrigation, hoeing, thrashing and winnowing; he buys for them manures, and he takes half the crop for himself. He

knows how to store his crop secure against insects, and he sells it for seed again at twice the price at which he would have sold his crop at harvest time. This would be an improvement over the ordinary system of cultivation by partnership.

Then, by the employment of capital, one can compete successfully with cultivators in such agricultural, or rather industrial, pursuits, as require a large outlay at the start. Two graduates of Saidapet College are making large profits by conducting dairies. The manufacture of cheese, butter and *ghi*, with appliances that cannot be ordinarily purchased by cultivators, would prove remunerative to a man with a capital. The method of sugar manufacture devised by Mr. S. M. Hadi, of Cawnpore, can be adopted in practice by men with capital of a few thousand rupees. Fruit-farming also would probably pay well in suitable situations. Fruits and vegetables can be preserved by a rapid process of desiccation. This is an industry which, properly developed, is likely to have an important future before it. The abundance of one year can be preserved from rotting for consumption in another year.

But some of the students of the agricultural classes will have to do with agriculture and agriculturists in the capacity of revenue officers. The knowledge of agriculture is of great value for revenue officers and district engineers. When the Director of the Agricultural Department, or the Reporter of Economic Products, or any expert officer of Government, seeks any information of an agricultural character, or any samples, he usually refers to district officers for such information or samples. The district officers consult their deputies or the district engineers, and they (the district officers) usually find out how ignorant their subordinate officers are regarding the circumstances and the wants of the cultivators. Revenue officers and district engineers with an agricultural training are likely to acquire some sympathy for the masses of the population who are employed in producing the staff of life, and whose interests these officers are now too apt to forget or to ignore. A mere literary and scientific training gives one little knowledge of the immediate surroundings, in the midst of which one's lot is likely to be cast in actual life, and little aptitude in dealing with such surroundings, in an official capacity. The agricultural statistics which ought to be of great value in estimating the resources of the people in times of famine, being compiled by men who have very little practical acquaintance with land and its produce, and who, owing partly to the very education they have received, are accustomed to take very little interest in such questions, were found to be of little use during the last famine in Bengal. The famine programmes, annually prepared in anticipation of famine by district engineers, were found wide of the mark and were, in practice, ignored. The district staffs might well in future be manned by officers who have received not only a literary and scientific education, but who have been accustomed



to see and handle the things with which they will be ordinarily surrounded in their practical life. Such officers will be able to draw up famine programmes in an intelligent manner after ascertaining local conditions, and enquiring of the cultivators themselves if they had any works to suggest, which might protect certain tracts against failure. In certain localities, I know of cultivators who have been accustomed to cut across roads and bunds admitting water into their fields, for the protection of their crops. They have been fruitlessly applying for years to the district engineer for a sluice-gate here, a channel there; and for permission to open a lock-gate a little earlier or a little later than usual, and so on. Having an eye to the protection of crops, officers with a rural training will be able to shape their famine programme and their annual programme in the interest of the cultivators. As men in charge of Government estates, officers with agricultural training will recognise the position of Government as a model zemindar for the *khas mahal raiyats*, and they will know how to utilise the "Khas Mahal Improvement Fund" to the best advantage. Government can depend upon their initiating the "*khas mahal*" tenants, under their charge, to at least one permanent improvement, for which they will be always grateful to Government and to the officers concerned, specially in times of famine. If, for instance, they can induce the "*khas mahal*" tenants under their charge to grow tapioca roots, and teach them to use the roots for food and to extract flour out of them, they will have done some permanent good, and they will have saved those tenants perhaps for all times from the jaws of famine. As managers of Court of Wards estates, officers with agricultural training will have ample opportunities of utilising the allotment annually made for agricultural improvements, by introducing well-thought-out reforms. They will find in most places it is some practicable method of irrigation that the *raiyyat* needs, and, if they can give him a canal here, a well there, a windmill somewhere else, and teach him how to lift water from small depths and great depths with fairly cheap appliances, the outlay they will incur on account of the estate they may happen to manage, may protect a certain precarious tract, for all time to come, from drought and failure of crops. In many parts of Bengal where water in wells is available at the driest season within twenty or twenty-five feet from the surface, the introduction of the most inexpensive method prevalent in the Western Coast of India from Dwarka to Ratnagiri of lifting water with hand and foot by means of a primitive Persian wheel, would become the means of giving an impetus to the cultivation of *rabi* crops, which are more or less ignored in Bengal.

And the educating influence of such innovations, even on the Indian *raiyyat*, who is proverbially conservative, though slow, will be lasting. For the *raiyyat*, though conservative, is only obliged to be so on account of his poverty. He cannot afford to lose money by launching out on mere speculations. But if the benefits of

some practicable methods are demonstrated—persistently demonstrated—before his eyes, even he will be induced to change his old ways. Have not the cultivators taken to growing potatoes and tobacco, and using the Behia mill for crushing sugarcane, and the microscope for selecting silkworm grain? You have to treat the *rayyat* with a little patience and you must have confidence in your own methods.

The question of famine in India is mainly a question of irrigation, and to manage irrigation properly, one must have a fairly solid knowledge of engineering and of agricultural science. It has been observed that the productive power of soil diminishes after a number of years where canal water is used too freely for the purpose of irrigation, and that localities too freely irrigated with canal water, become malarious. The question of well-irrigation is being seriously discussed as probably fraught with greater advantage, and along with this must be considered suitable implements for lifting water from various depths.

On the whole, however, there cannot be the slightest doubt that canals have proved the best protection against famine. I will quote a few figures from the reports of the famine year 1896-7, to prove that the construction of canals should be undertaken, wherever possible, by way of relief work, at any rate, in famine times.

In Bengal the capital outlay on canals up to the close of 1896-7, had reached a total of Rs. 7,61,23,817. The total length of canals in operation was 916 miles, including 738 miles used for irrigation, the rest being used for navigation only. There were also 2,605 miles of canal distributaries. These were capable of irrigating 1,572,005 acres. The receipts for 1896-7 amount to Rs. 25,63,047 and the working expenses to Rs. 19,37,142, the net revenue being Rs. 6,25,905, against Rs. 2,45,646 and Rs. 1,38,135 in the two preceding years. The areas actually irrigated from these canals in 1896-7 and the two previous years were, respectively, 805,387 acres, 579,933 acres and 509,811 acres. The average outturn of paddy per acre from canal-irrigated areas may be put down at twenty-four maunds, representing sixteen maunds of rice. The outturn of grain from the 805,387 acres served by canal water may be put down at 12,000,000 maunds. The annual consumption of grain per individual adult being put down at six maunds, the number of adult units directly saved from starvation by canal irrigation in Bengal during the famine may be calculated to have been two millions in 1896-7.

The figures for the United Provinces, the Punjab, Sind, Bombay and Madras are equally or still more satisfactory. In the Punjab the whole of the capital outlay of 841 lakhs of rupees has been more than recovered, the net revenue up to the end of 1896-7, amounting to 865 lakhs of rupees, or taking the interest charge of 556 lakhs of rupees into account, the State has already

recovered 310 lakhs out of the 841 lakhs spent on irrigation works in the Punjab. In 1896-7, the gross revenue exceeded 109 lakhs, while the working expenses were below 31 lakhs, leaving a net profit of about 78½ lakhs to the State, which is equivalent to 9.34 per cent. on the capital invested. The area irrigated in the Punjab in that famine year was 4,621,000 acres, *viz.*, one-fifth of the total cultivated area of the province. Of this 1,441,000 acres were under wheat (which alone must have saved between three and four million persons from starvation). The total quantity of food-crops of all kinds raised by canal water in the Punjab in 1896-7 sufficed to feed over six millions of people or a quarter of the entire population of that province. But the area actually irrigated does not represent the whole that it is possible to irrigate and grow food-grain on. The capital outlay on canal works, though enormous, represents but a small fraction of the benefit rendered to agriculture through their means. The value of the crops raised by canal irrigation in the Punjab in 1896-7 alone was estimated at 1,508 lakhs of rupees, *viz.*, nearly twice the amount of the whole capital outlay incurred from the commencement; the value per acre being estimated at Rs. 33, while the water-rate levied was Rs. 3-4. The figures for more recent years are still more encouraging, the interest on capital working up to more than 10 per cent. Even a canal like the Eden Canal in Bengal, which has not as yet proved remunerative, has brought immense benefit to the country, and the water-rate has been raised lately without any opposition worth speaking of, so that profit may be expected in future.

A knowledge of agricultural science will enable one to avoid bringing about a deterioration of soil by canal irrigation. Irrigation-water judiciously used adds to the fertility of the soil, while injudiciously and lavishly used, it can wash the good gradually out of the soil and render the locality unhealthy at the same time. The cultivator will take nine inches of water if he can get it, though two to six inches according to the season of the year will do him more good than nine inches, leaving the fertility of the soil intact, and the locality free from malaria.

It is somewhat unfortunate, however, that in this as in every other country, agricultural education is being taken advantage of almost exclusively by persons who are not directly interested in agriculture. Neither the farm labourer, nor the farmer, nor the landed proprietor cares, as a rule, for agricultural education. Agricultural colleges and schools in almost every country are crammed either by place-seekers or by town-bred men, who fancy they can make their fortune by scientific farming or by cattle ranching. In other countries such men do occasionally turn out successful farmers or colonists. But in India the caste system has ingrained and stamped in different classes, different abilities and disabilities in such an indelible manner, that the priestly and

writer castes who generally go in for high education are *a) initio* unfit subjects for agricultural training, and the high education they go in for makes them less suitable for an agricultural pursuit. Their instincts, their habits of body and of mind, are not suitable for an agricultural occupation. They are eminently fitted for other paths of life, but not for success in agricultural pursuits. It is doubly important therefore for India that the right classes of people should be encouraged to receive agricultural education that the benefit derived by them may easily filter down to their fellow-caste-men in rural tracts. To expect the benefits of agricultural education to filter down to rural tracts from the prospective gardens, farms and plantations that the Bengali or the Maratha "gentleman" may establish, after receiving agricultural education of a high order, is a far-fetched hope. Vernacular education, on the other hand, has spread so far in rural tracts in Bengal, that we can now find many actual cultivators who have passed the middle vernacular or even higher examinations. They are quite capable of receiving a systematic training in agriculture, and these are the men who will have influence among their fellow-caste-men. In dealing with agricultural pupils of the cultivator class a great deal of patience, a great deal of sympathy, is at first needed. But when once a headway has been made among them, agricultural progress will come directly through their agency. It is therefore of great importance to induce, by the offer of suitable scholarships or otherwise, sons of *bonâ fide* cultivators who have passed at least the middle vernacular examinations, to come for special agricultural training to a central institution, and then go back to their respective villages. Such men will not feel disappointed if they cannot secure Government appointments. Training a hundred men of this sort by the judicious allotment of a hundred scholarships, will have far more effect in ameliorating the agricultural condition of this province than training a dozen university graduates annually, who will probably give up all connection with agriculture in disgust, if they fail to secure Government appointments. It is by the spread of agricultural education rather than by reduction of revenue demand or opening of agricultural banks that the question of famine must be met. There is no occasion for the *raiya*t to starve when there is a shorter rainfall, but the *raiya*t does not know how he can help himself. He must be taught. So, while a class has been properly established in Bengal for higher training in agriculture given to a few University graduates and engineers or surveyors with the object of employing them as Government officers in certain special capacities in which agricultural knowledge is needed, it must not be forgotten that the more important scheme, of giving a thoroughly practical agricultural training in a properly equipped farm, to the actual cultivator, is yet to follow. It is the want of such a scheme of education that is really at the bottom of the small amount of practical success the agricultural departments have attained hitherto.

The object of agriculture is the production of food and other essential requirements of man, and the aim of the science of agriculture is the production, in the best condition, of the greatest amount of produce, in the shortest space of time, at the least cost and with the smallest deterioration of land. The sciences helpful to this end are : (1) Geology and Mineralogy (some knowledge of which is required in understanding Part I of this book) ; (2) Mechanics and Hydrostatics (*cf.* Part II) ; (3) Botany (*cf.* Part III) ; (4) Chemistry (*cf.* Parts IV & VII) ; (5) Veterinary Science (*cf.* Part V) ; (6) Zoology (*cf.* Part VI) ; (7) Bacteriology (*cf.* Part VI) and (8) Political Economy (*cf.* Part VIII).

# HANDBOOK OF AGRICULTURE.

## PART I.

### SOILS.

#### CHAPTER I.

##### GEOLOGICAL STRATA.

[General character of strata, how formed ; Order definite ; Stratified and unstratified rocks ; Strata from below upwards, Lower and Upper Magma ; the Azoic rocks ; the Vindhyan system ; the Mesozoic and Neozoic epochs ; Recent strata ; Laterite ; Strata from top to bottom ; Summary.]

If we make borings into the earth or study railway cuttings by hill-sides, we find the earth and rocks exposed are of *different character and consistency*, and we notice, as a rule, well-marked stratifications both in the loose earth and the hard rocks so exposed. The deepest mine is only about half a mile in depth, and so we can study the soils and rocks only of the outer crust of the earth. As the rocks, however, *do not always occur in horizontal layers*, and as the crust of the earth has evidently undergone violent contortions, we are able actually to study rocks situated down to a depth of about twenty miles, on the very surface of the earth. In other words, there are rocks on the surface of the earth which would have been buried twenty miles deep had not *violent eruptions brought them up to the surface*. The evidences for such eruptions are numerous. We find the temperature of the crust of the earth increases by about one degree Fahrenheit for every fifty-six feet of depth. The deeper we go down in a mine, the warmer it is, and we can only imagine how hot it is twenty miles below the surface of the earth. It is over 2000°F., a temperature at which all minerals and rocks must be in a fluid and disturbed condition. We have further evidence of this internal heat in hot-springs, earthquakes and volcanoes. Earthquakes and volcanic eruptions

were very much more violent in past ages than they are now. Take, for instance, the Deccan trap formation, two hundred-thousand square miles in area and as much as six thousand feet deep in some places. The volcanic outbursts that resulted in this deposit must have been most fearful. But all over the earth's crust we have evidence of contortions and dislocations of the strata that form the outer crust of the earth, which point to very great heat acting from within the bowels of the earth. This heat gradually becoming less, in other words, the earth getting cooler and cooler, the disturbances on the earth's surface have also become less and less. At one time the heat and the disturbances in the shape of earthquakes and dislocations were so great that no plant or animal could have lived on the surface of the earth. Gradually the surface getting cooler and quieter, plant and animal lives made their appearance. But thousands and perhaps millions of years elapsed before the surface of the earth became fit for human habitation. It is supposed that our planet was originally a portion of the sun, and that it was spitted out by the sun by a violent centrifugal action. This nebulous or fluid mass of burning and revolving matter has been gradually getting cooler and cooler and solidifying from the surface downwards. The composition of the whole of the solid crust of the earth can be studied and even of a portion of the fluid "magma," as it is called, lying underneath the crust, as volcanic action has exposed to the surface not only the solid strata, but also the liquid magma below.

Geologists have found out in the midst of all the contortions and dislocations to which the outer crust of the earth has been subjected for ages past, that the *strata forming the crust occur in a certain definite order* all over the earth's surface. In England these strata occur in beautiful regularity from south-east to north-west, the newer formations at the south-east and the older formations at the north-west. In other countries, although these strata do not occur in such regular succession exposed to the surface, a similar order can be traced all over the surface of the earth.

If we study the character of the rocks so exposed in succession, either vertically in cuttings or horizontally as we pass from field to field, and district to district, we find two classes of rocks, *stratified* and *unstratified*. Unstratified rocks are igneous in origin, *i.e.*, thrown up from the burning bowels of the earth. The stratified rocks have been formed by the action of rivers, lakes, or the sea. When rocks formed by such action have been afterward changed, by heat or by great pressure, they are called *metamorphic* rocks.

Studying the geological strata from below upwards, we find the following order prevailing in the deposition of these strata :—

**The first**, that is, the lowermost stratum, may be called the **Lower Magma**. This consists of basic rocks rich in earthy bases and oxides of iron. Volcanic action has exposed this deep liquid

layer to the surface of the earth in the form of Basalt and similar rocks. Greenstones and Basalts generally are called trap-rocks as they occur in the form of steps on hill-sides. The solidification of the Lower Magma has usually taken place after volcanic eruption on the surface of the earth, and therefore they occur chiefly as volcanic rocks. Many of the eruptions which have formed these rocks took place in, geologically speaking, fairly recent times, and hence the rocks often lie over others, sedimentary and metamorphic, which were formed at an earlier date. All over the plains of Deccan occur trap-rocks, usually in horizontal layers of six to ninety feet, each layer being a separate lava deposit evidencing a succession of volcanic eruptions. The total depth of these successive deposits of trap reaches in some places to 5,000 or 6,000 feet, and the total area covered by these trap-rocks is about 200,000 square miles. Soils formed from decomposition of trap-rocks are naturally very fertile, being rich in silica, alumina, iron, lime, magnesia, potash, phosphates and soda. The celebrated black-cotton-soil or *Regur* of Southern and Central India was formed chiefly out of trap-rocks.

**2nd.—The Upper Magma** resting on the Lower Magma is lighter and is more largely composed of silica. This stratum is therefore called the siliceous or acidic magma. It is mainly plutonic, that is to say, solidified by slow cooling under pressure, and occurs in consequence, in the form of coarse-grained crystals compacted together in the form of granite. The presence of plutonic granite is an indication of the earliest geological formation. They usually intrude into gneiss and it is sometimes difficult to distinguish between intruded dykes or veins of granite and the older metamorphic schists. Veins and dykes of granite occur throughout the vast metamorphic (or gneissose) rocks of India, all along the Himalayas, in the Arravali hills, and also in the Deccan. Granite consists of quartz, mica and felspar, in varying proportions. Quartz and mica are not of much value as fertilizers, but felspar is. Soils formed out of granite are therefore less fertile than those formed out of Basalt. But there are whole hills of feldspathic granite near Rajmahal, at the foot of which are some of the most fertile tracts of land suitable for rice, melons and mustard.

The acidic rocks contain 60 to 75 per cent. of silica, the basic rocks less than 50 per cent. The acidic rocks are light, and more infusible, while the basic rocks are very heavy and of fine texture, and they are not so infusible. The principal acidic rocks are:—*Granite, Felsite, Obsidian, Pumice, Syenite, Trachyte* and *Pophyrite*. The principal basic rocks are *Basalt, Dolerite, Diorite* and *Gabbro* (containing Diallage and Labradorite).

**3rd.—The Azoic or metamorphic rocks.**—These consist of gneiss, mica-schist and clay-slate, formed by the joint action of sedimentation in water and compaction by heat or pressure. They are called azoic because no trace of life has been discovered in



them. There are three distinct systems of azoic rocks which from above downwards may be called the Vindhyan, the Sub-metamorphic and the Metamorphic. The Vindhyan system consists of sandstones, limestones, shale and iron pyrites and the fern-like (dendritic) markings of earthy manganese oxide which may be easily mistaken for fossil plants, are characteristic of this system. The Sub-metamorphic system consists of quartzite, sandstone, slate, shale and limestone of more crystalline appearance. The older and still more crystalline rock which abounds in Southern India is called gneiss. More than half the Peninsular area is on gneiss. From Cape Comorin to Colgong on the Ganges, a distance of 1,400 miles with a mean width of 350 miles or an area of nearly 500,000 square miles, the land is composed of gneiss or soils formed mainly out of gneiss. Patches of newer strata occur here and there on the gneiss. The Bundelkhand gneiss is the oldest of all. Gneiss also occurs in the Himalayas, in the Chutia Nagpur Division of Bengal and in Assam. It is composed of quartz, felspar, hornblende, chlorite and mica, all or only two of which minerals may be present. Lead, silver, garnet, corundum and diamond are occasionally found in azoic rocks. The lead-ore or galena of Bhagalpur contains silver. Lead-ores occur in Chutia Nagpur also. The greatest depth of the azoic system is 26,000 feet. The soils are somewhat better than granitic soils, but mica-schists which contain no felspar, but only quartz and mica, are poor. Quite recently apatite has been discovered in the mica mines of Hazaribagh—a fact which is of considerable agricultural importance.

4th.—Above the Vindhyan system, which represents a transition between the true metamorphic gneiss and the true sedimentary rocks of the Lower Silurian system which are marked with ripples, come the **Palæozoic rocks**. The Palæozoic period is characterised by the first appearance of life, though the remains of very few animals have been discovered in the older of these rocks. A few zoophytes, trilobites and graptolites and some shells called Oldhamia are the fossil remains found in them. The greatest depth of the Lower Silurian rocks, as these older rocks are called, is about 30,000 feet, and of the Upper Silurians about 108,000 feet. The *Lower Silurian* rocks consist of shales, sandstones, limestones and conglomerates. This system is scarcely represented in India. Lower Silurian beds are found overlying the Himalayan gneiss. The *Upper Silurian* system consists of the *Old-red-sandstone* (90,000 feet), the *Carboniferous rock* (15,000 feet) and the *Permian group* (3,000 feet) or the *New-red-sandstone*. Of these the carboniferous rocks are chiefly represented in India. These consist of limestones, shallow beds of sandstone, and coal measures. The coal measures of Bengal are of great importance, and coal in them being associated with iron and limestone, their possible importance as centres of manufacture is evident. Coal exists in an igneous or crystalline form in the older metamorphic formations, for

instance, in the district of Sambalpur, in the more ordinary form in carboniferous rocks and in the later tertiary formations also and in the recent formations as peat. Peat can be dug out of a depth of only twenty feet in places south of Calcutta. The coal of Bengal is characterised by the usual fossils of the carboniferous systems, *viz.*, lepidodendron and calamite. The Raniganj coal-fields embrace an area of about 500 square miles, the Barrakar coal-fields about 220 square miles and the Jheria coal-fields about 200 square miles. The depth of some of the Raniganj coal seams is seventy to eighty feet. The Bengal carboniferous rocks come under what is called the *Gondwana system*. The soils of this system are indifferent, better than granite soils, but poorer than basaltic and alluvial soils. There is not much to choose between the gneissose soils of Chutia Nagpur and the soils of the coal-fields of Burdwan and Manbhum. As a rule, they are indifferent soils.

**Gondwana system.**—The upper strata of the Palæozoic and the lower strata of the Mesozoic groups in India (*i.e.*, from Jurassic down to Carboniferous rocks) are included under the Gondwana system. They have been probably deposited by rivers and are chiefly composed of sandstones and shales. Plant remains are common but not animal remains. The Rajmehal hills, the Damodar Valley the Tributary Mehals of Orissa and Chhatisgarh, Chutia Nagpur and the Upper Son Valley, and the Satpura range at the Godavery basin, are the localities representing the Gondwana system.

**5th.—The Mesozoic Epoch.**—Air-breathing animals which first made their appearance at the close of the Palæozoic epoch appeared in abundance at the Mesozoic epoch. The lowest group of this epoch is called the *Triassic* group (about 2,300 feet in maximum thickness). The next higher is called the *Oolitic* (about 4 500 feet in maximum thickness) and the topmost group is called the *Cretaceous* (maximum thickness, 11,000 feet). Fossil remains of Labyrinthodon reptiles have been discovered in the Damodar Valley above the coal-fields of the Panchet hills. These are characteristic of the Triassic period. They have been also discovered in the Central Provinces of India : but Triassic rocks occur chiefly in the North-Western Himalayas, where they occur to the thickness of 1,000 to 2,000 feet. The Oolitic group of rocks is subdivided into (1) *Liassic*, (2) *Jurassic* and (3) *Oolitic proper*. Monstrous reptiles (Ichthyosaurus, Plesiosaurus and Pterodactyle) were the characteristic animals of this period. The ammonite and belemnite of the Himalayas are Oolitic. The shales and limestones of the Himalayas are both Liassic and Oolitic. The Rajmehal hills which abound in fossil plants are Jurassic. The cretaceous system is not represented at all in Bengal, though portions of the Nizam's dominion and of the Bombay Presidency and also of Assam belong to this system. Tracts rich in fossil remains are very fertile, also those where gneiss and limestones meet.

**6th.—The Neozoic epoch** follows the mesozoic, and at this epoch for the first time we come across remains of animals and plants allied to those of the present time. The trilobite of the Silurian period, the peculiar bony-armoured fish of the Red-sandstone, the large club-mosses and reeds of the carboniferous system, the huge reptiles of the Oolite, the ammonites of the Lias and the chalk, give place to new forms of life. Only from 3 to 4 per cent. of the tertiary plants and animals of the earliest strata are modern; about 18 per cent. of the plants and animals of the middle tertiary period are modern, and there is no distinct gap between the close of the tertiary period and the recent period. The lowest tertiary period is called *Eocene* when the existing forms of life are first seen. The middle period is called *Miocene*, and the uppermost tertiary period is called *Pliocene*. The nummulitic limestone formations of the Himalayas, often attaining a height of 16,000 feet, are marine and belong to the eocene period. Mammals appeared first in the miocene period, and the extensive fossil remains of the Siwalik range belong to this period. The Sivatherium deer is the characteristic fossil of this period. Gigantic crocodiles and land turtles of modern times also occurred, and a huge but extinct species of tortoise, a shell of which can be seen in the Indian Museum. In the Pliocene period man first made his appearance, and agate knives have been discovered in the Upper Godavery characteristic of this period. The greatest depth of the Tertiary or *Neozoic* group of rocks is 9,000 feet.

**7th.—**Between the Indus and the Brahmaputra there lies a vast alluvial plain which consists mainly of miocene and pliocene tertiary deposits. These are the *Recent Formations*, the commencement of this period being coeval with the first appearance of man. In Bengal, though some of the other systems are represented, as we have already indicated, we are mainly concerned with these alluvial post-tertiary and recent deposits.

**8th.—Laterite.**—The origin of laterite and its position in the geological system are subjects of some dispute. Laterite is porous argillaceous rock much impregnated with iron peroxide. Some containing as much as 25 to 35 per cent. of iron. The iron exists chiefly as limonite or hydrated peroxide. The surface of laterite after exposure is covered with a brown or blackish brown crust of limonite, but the rock when freshly broken is mottled with tints of brown, red and yellow and a considerable proportion consists of white clay which contains no iron. Examples of all these forms are to be met with at Garhbeta in the district of Midnapur. The exposed surface is pitted with hollows and irregularities caused by washing away of softer portions. The rock has a scoriaceous and volcanic appearance, especially as it is associated usually with basalt and other igneous rocks. But it is now usually believed to be of detrital origin produced from other rocks, igneous and sedimentary. The high-level laterite of Central and Western India

does not appear to be detrital in origin as the iron is not sandy. The low-level laterite of Bengal is mixed up with sand, quartz, pebbles, ferruginous sandy clay and gravel. The high-level laterite always caps the highest lava flow, which makes the subject of its origin so difficult to understand. It becomes more and more probable, however, that it is simply the normal weathering product of highly basic rocks under the conditions of a tropical climate. The low-level laterite is probably the detritus of the high-level laterite. The action of rain and streams having carried away the lighter sand and clay, the heavy iron-sand is left as laterite, and to this may be due the concentration of the ferruginous element. The age of the low-level laterite is certainly post-tertiary, while the high-level laterite is being constantly produced.

**9.—Alluvial deposits and Blown sands.**—Blown sand forms the soil of places close to the sea, and its deposit is quite recent. Alluvial deposits will be dealt with in the next Chapter.

It should be noted that (1) clay, (2) sand, (3) gravel, (4) peat, (5) shell-marl, and (6) marine ooze of recent formation are analogous respectively to (1) shale, (2) sandstone, (3) conglomerate, (4) coal, (5) limestone, and (6) chalk of old geological formations. The older the sedimentary rocks, the more compact they are. But their age is indicated chiefly by fossils.

The strata of the crust of the earth as found in India, from the top to the bottom or from the most recent to the oldest, may be graphically represented as below :—

|                 |                  |                             |                      |                         |
|-----------------|------------------|-----------------------------|----------------------|-------------------------|
| A. NEOZOIC      | {                | Post-Tertiary               | { Recent (1st).      | } Cuddalore             |
|                 |                  | Tertiary                    | { Pleistocene (2nd). |                         |
| B. MESOZOIC     | {                |                             | Oolitic              | { Phocene (3rd).        |
|                 |                  | { Miocene (4th).            |                      |                         |
| C. PALÆOZOIC    | {                | Upper                       | { Eocene (5th).      | } Gondwana              |
|                 |                  |                             | Silurian             |                         |
| D. AZOIC        | {                | Lower Silurian              |                      | { Oolitic proper (7th). |
|                 |                  |                             | Vindhyan             | { Jurassic (8th).       |
| Sub-metamorphic | { Liassic (9th). | }                           |                      |                         |
|                 | Metamorphic      |                             | { Triassic (10th).   | }                       |
| Metamorphic     |                  | { Permian (11th).           | }                    |                         |
|                 | Metamorphic      | { Carboniferous (12th).     |                      | }                       |
| Metamorphic     |                  | { Old red-sandstone (13th). | }                    |                         |
|                 | Metamorphic      | { (14th).                   |                      | }                       |
| Metamorphic     |                  | { (15th).                   | }                    |                         |
|                 | Metamorphic      | { (16th).                   |                      | }                       |
| Metamorphic     |                  | { Peninsular Gneiss (17th). | }                    |                         |
|                 | Metamorphic      | { Bundelkand Gneiss (18th). |                      | }                       |

The following summary of the characters of the geological strata as they particularly refer to India may be found useful :—

#### A. NEOZOIC.

**1st. Recent.**—Blown sands, alluvium, fluvitile and marine, including deltas and lagoons, laterite and gravels. *Example*,—the united delta of the Ganges and the Brahmaputra, covering a space of 50,000 to 60,000 square miles and

- a depth of about 500 feet, and the whole of the Indo-Gangetic basin. *General character*,—fine sands and clay with occasional pebbles or pebble-beds, beds of peat and remains of trees, but no trace of marine organisms.
- 2nd. Pleistocene or Glacial period.**—Erratic boulders and moraines in the Himalayas and Upper Punjab. Modern fauna.
- 3rd. Pliocene period.**—Soft massive sandstone, also clays and conglomerates, many fresh-water, resting on the nummulitic limestones. *Example*,—Siwalik-beds, full of fossil remains of animals, chiefly mammals allied to modern fauna; also in Sind, the Punjab, the North-West Provinces of India, and along a narrow strip of hills from the Jhelum to the Brahmaputra in the Sub-Himalayan region, 1,500 miles long and 12 to 15,000 feet in thickness.
- 4th. Miocene.**—Marine sands, shales, clays with gypsum, sandstones and highly fossiliferous bands of limestones. Uppermost beds are clays with gypsum containing estuarine shells. This period is represented in Sind.
- 5th. Eocene.**—Sandstones, probably fresh-water; also marine limestones passing into sandstones and shales; nummulitic limestones; clays with gypsum and lignite abounding in marine fauna. Examples in Sind, the Punjab, Orissa Coast, Assam and Burma.

## B. MESOZOIC.

- 6th. Cretaceous or Chalky system 11,000 feet.**—Here and there in the Himalayas, especially in Assam, but all over the Indian Peninsula, where it is covered over in the middle and west by the Deccan basalt, which is the volcanic lava of this period.
- 7th. Oolitic proper.**—Himalayan shales and limestones.
- 8th. Jurassic.**—Rajmehal hills (characterised by fossil plants) and Upper Panchet Series.
- 9th. Liassic.**—Shales and limestones of the Himalayas. Lower beds of the Rajmehal hills and the Lias of India belong to the Gondwana system.
- 10th. Triassic 2,300 feet.**—Lower Panchet Series of the Damodar Valley showing remains of Labyrinthodon reptiles, also of the valleys of the Central Provinces and of North-West Himalayas, where they attain to a thickness of 1,000 to 2,000 feet chiefly in North Kashmir and the Salt Range of the Punjab. The fossils are like those of the Alpine trias. These belong to the Gondwana system.

## C. PALÆOZOIC.

- 11th. Permian group or New-red sandstone 3,000 feet.**—Thick beds of sandstones and shales of iluvitatile origin, belonging to the Gondwana system. The Lower Series are the Talchir and Damuda rocks which correspond with the Permian rocks of Europe.
- 12th. Carboniferous system 15,000 feet.**—Raniganj, Barrakar and Jheria fields. Belong to the Gondwana system.
- 13th. Old Red-Sandstone 90,000 feet.**—Scarcely represented in India.
- 14th. Lower Silurian 30,000 feet.**—Shales, limestones, sandstones and conglomerates. This is scarcely represented in India, but is found on the top of Himalayan gneiss.

## D. AZOIC.

- 15th to 18th. Archæan rocks 26,000 feet.**—Oldest known rocks of India are gneiss underlying the ancient Palæozoic rocks. They belong to two periods. The Older or Bundelkhand Gneiss (18th) is covered by certain transition or Sub-metamorphic rocks (called also Vindhyan system of rocks) which (15th) as they approach the younger gneiss become altered (16th) and intersected by

granite intrusions. In West Himalayas both the gneisses occur. The Upper Himalayan gneiss (16th) is formed by the metamorphism of older Palæozoic rocks.

## CHAPTER II.

### SURFACE-GEOLOGY OF THE BENGAL DISTRICTS.

[The Old and New Alluvial tracts, Laterite region and laterite patches; glacial boulders; the two Cuddalore bands; Tertiary and Cretaceous regions (in Eastern Bengal, Assam and Orissa Hills); Gondwana deposits consisting of (1) Rajmehal trap (from Raniganj Northwards and Westwards through Birbhum, Damodar Valley to Hazaribagh, also in Cuttack, in the Son Valley, and in Palamau). (2) Jurassic beds of Rajmehal. (3) Panchet and Dubrajpur rocks, (4) Barrakar rocks including coal, (5) Talchirs and (6) Damudas (Raniganj to Chanda); Upper Vindhians of Chunar; Lower Vindhians in the Son Valley; transition rocks in Manbhum and Singhbhum; gneiss and granitic intrusions in Chutia Nagpur Division and Monghyr; Domegneiss; trap dykes rare in Bengal gneiss; Bengal trap—(1) Cretaceous (W. of Chutia Nagpur), (2) Rajmehal and (3) Archæan (Singhbhum).]

Most districts of Bengal and Bihar are alluvial. This alluvial plain is a portion of the Indo-Gangetic basin which includes about 300,000 square miles, or one quarter of the whole of British India. It is the richest and most populous tract of land, consisting of clay, more or less sandy. Peat, gravels, conglomerate and pure sand occur at intervals. Pisolitic concretions of hydrated iron-peroxide abound in certain regions. In Dinajpur the nodules of iron-peroxide are as big as pigeons' eggs; but usually they are of the size of peas or even smaller. The alluvium is classified into Old and New. The older alluvium is at a higher level,—in the Burdwan Division, in some places, over one hundred feet above the sea-level. The newer alluvium occurs near channels of rivers. The delta of the Ganges and the Brahmaputra is also new alluvium. No marine fossils have been discovered in this alluvium, though in Calcutta a boring down to a depth of nearly five hundred feet was made. This boring clearly demonstrated that the surface of the land in the neighbourhood of Calcutta has sunk to at least this extent within the recent geological age. Fresh-water shells, pebbles and bits of wood that must have occurred at one time at the surface were brought out by this boring. The greater portion of the Ganges alluvium is o'd alluvium containing beds of *kankar* or carbonate of lime nodules, and of concretions of hydrated iron-peroxide. On the western edge of the delta of Bengal there is a large area of this older alluvium, where the surface is somewhat undulating, evidently in consequence of denudation. This tract, which is continuous with the newer alluvium of East Bengal, comprises the greater portion of the country to the westward of the Bhagirathi and the Hooghly, and owes its comparative elevation to the deposits from the Mourakshi, Ajay and Damodar,

brought down from the Rajmehal series of hills, extending north and south from the Ganges to the neighbourhood of Suri in Bengal. The Barh country of Bengal and the whole of the Bihar soil is composed of old alluvium. The old alluvium is under denudation, though occasional elevation by silt formation, due to inundation, also occurs in places. The newer alluvium is ordinarily under formation and it has the tendency to rise, though occasionally denudation and disappearance of whole tracts of new alluvium often takes place in different localities. This general depression of the older alluvium and this general elevation of the newer alluvium are to be distinguished from the geological upheaval and depression that have taken place in the alluvial tracts of Bengal since the tertiary period. The elevation of the Tippera hills and the coast of Orissa, and the depression of the Gangetic delta by nearly five hundred feet cannot be explained by alluvial action and denudation. There is some evidence to show that the drainage of the Indo-Gangetic plain took place at one time by one delta only, *viz.*, the delta of the Indus, and that the Gangetic delta has been formed since the depression of the lower part of Bengal, facilitating drainage by a second outlet. The extensive Madhupur jungles of Dacca are probably the remains of the old alluvium which existed prior to this depression which has resulted in the accumulation of new alluvium in the greater portion of East Bengal.

Though the prevailing rocks of Bengal and Bihar are alluvium, whether old and new, there are some important exceptions. First of all we will describe the laterite region of Bengal, which is also post-tertiary. This laterite region can be traced up from Cape Comorin along the east coast, through Orissa, Midnapur, Bankura, Burdwan, Birbhum, to the flanks of the Rajmehal hills as far as Patna. This fringe of laterite underlies the old alluvium and is older than alluvium. It is often seen capping older rocks. This is the high-level laterite already described. The low-level laterite is truly alluvial, and it occurs in patches throughout the old alluvium of the Ganges valley.

The Pleistocene or glacial boulders and moraines are not represented in Bengal, except in the lower hills of Sikkim, Bhutan and Nepal, down to a height of about 3,000 feet above the level of the sea.

Next we come across in Bengal a band of the Cuddalore group of rocks,—sandstones, grits and clays, underlying laterite, from east of Raniganj, extending northwards as far as Suri. These Cuddalore sandstones, etc., are tertiary. At a lower elevation in the Sub-Himalayan range, on the north of Bengal, there is a band of soft massive sandstones, also clays and conglomerates, resting on the older tertiary bed of nummulitic limestone. This belongs to the same age as the Cuddalore band from Raniganj to Suri.

Next come the Eocene sandstones, nummulitic limestones, the cretaceous rocks, and the pre-tertiary slates and sandstones that are found in the Chittagong, Tippera, Garo and Manipur hills. Tertiary rocks prevail in these hills which were probably elevated at the post-tertiary age about the same time as the Gangetic delta from Rajmehal to the Garo hills was depressed.

The Jurassic system is next represented in Bengal in the Rajmehal hills and the Upper Panchet series of rock. The typical Rajmehal rock is a basalt or trap consisting of dark-coloured dolerite interstratified with a hard, white and grey and carbonaceous shale, white and grey sandstones and hard quartzose grit. Trap-dykes and intrusions of the Rajmehal age are also abundant in the coal-fields of the Damodar valley and dykes and cores of basalt are common in Birbhum, South-West of Rajmehal. Trap-dykes diminish in the Damodar valley from east to west until in the south-west of Hazaribagh volcanic intrusions disappear almost entirely. Further west, of course, occurs the newer Deccan trap. The focus of eruption of the Rajmehal trap is at a point north of Raniganj. The Rajmehal beds extend to the east coast close up to Cuttack and southwards. Eastward, trap-dykes are less numerous, but they occur throughout the Upper Sone valley and they gradually die out in Palamau only two hundred miles west of the ground in which the older lava flows of the Rajmehal age are seen and within less than one hundred miles of the Gondwana basins in the Upper Damodar valley which are traversed by basalt dykes probably of the same age as the Rajmehal traps.

The Gondwana rocks appear in Bengal, in the Damodar valley and in Chutia Nagpur. In the former, the upper and the lower Gondwana rocks are both observable at the basal portion of the Panchet hill and the zemindari of Panchet, south of the Raniganj coal-field. The lower Panchet beds consist of coarse felspathic and micaceous sandstones, usually white or greenish-white in colour, with bands of red clay interstratified among the sandstones. The Panchet and Damuda rocks, though often occurring in close proximity, are of different age. The Panchet rocks are distinguishable from the typical Damudas by the presence of red clay and the absence of carbonaceous shales, and by the sandstone being usually more micaceous. Fragments of coal and shale are found in the conglomerates of the Panchet group, but they are evidently derived from the Damudas. The Dubrajpur rocks consisting of ferruginous sandstones and conglomerates belong to the Upper Gondwana age. The ridge of gneiss from the basaltic plateau of the Deccan to the Highlands of Chutia Nagpur is overlaid and crossed by Gondwana deposits stretching across from the Sone to the Mahanadi. The watershed between the Sone and the Mahanadi is pretty high and is occupied by the ~~Tertiary beds of the Sone~~ <sup>thick</sup> ~~beds of the Sone~~ <sup>of the Sone</sup> of great thickness, so that gneiss forms the rock barrier from east to west.



The Tributary Mahals of Orissa also belong to the Gondwana series. The coarseness of the rocks, the prevalence of sandstones, the frequent occurrence of bands of conglomerate and the absence of marine fossil, characterise them as Gondwanas.

Then come the typical Damuda or Barrakar rocks belonging to the carboniferous system. The Barrakar river and its tributaries traverse the whole of this region. It passes round the western portion of the Raniganj coal-field and falls into the Damodar within the limits of the field. In the higher portion of its course the Barrakar receives streams which drain the Karharbari coal-fields which are supposed to be Talchirs or the lowest Gondwana and not carboniferous. Conglomerates, sandstones, shales usually micaceous, and coal, characterise this region. The sandstones are felsphatic, consisting of grains of quartz and decomposed felspar. Knobs of calcareous concretions project through the sandstones. Felspar is at different places seen converted into pure kaolin. White felspathic sandstone may be traced all the way from Raniganj to Chanda in the Central Provinces. Another typical Barrakar rock is conglomerate of rounded-white quartz pebbles scattered over the surface of the soil.

Last of all we have the Archæan rocks of Bengal metamorphic and submetamorphic, transition or Vindhyan. Small hills in Bihar appearing through the alluvium are most of them Lower Vindhyan, and at the lowest level where the Ganges washes the base of the plateau at Chunar, only Upper Vindhyan are exposed. The concealment of the Lower Vindhyan here is probably due to the depression in the main axis of the basin. The Lower Vindhyan rocks of the Sone valley consist of limestones, shale, sandstone, shaley sandstone, trappoid beds, porcellanic shales and conglomeratic and calcareous sandstone. True metamorphic rocks, that is to say, gneiss and granitoids, encroach upon the zone of the transition rocks in Bihar where for some miles north of the Grand Trunk Road, west of Gaya, gneiss reaches quite across the strike of the slates. Several hills isolated on the alluvial plain in this neighbourhood are of pure granite. Immediately east of Gaya transition rocks appear again on the prolongation of those on the Sone valley and having the same strike. They form several groups of hills in East Bihar, known as the Maher, Rajagriha, Shaikhpura and Gidhour hills, which stand clear of the main gneissic area and more or less isolated in the alluvial plains, and those of Mohabar and Bhiaura on the northern margin of the gneissic upland. All these isolated Bihar rocks belong to one system, massive quartzites appearing on the sides of the hills and the associated schists or slates appearing obscurely in the valleys. On the north side of the Bhiaura ridge the bottom quartzites lie steeply against the "dome-gneiss" as the peculiar rounded and poised masses of gneiss are called. Elsewhere schistose gneiss occurs at the boundary. True granitic intrusion may be observed in the soft earthy schists. In

the neighbourhood of Gaya many forms of special metamorphism and of contact action are well exhibited. At Lukhisarai the quartzite rests against an amorphous mass of pseudo-crystalline granitoid rock of much less sharply defined texture than at Shaikh-pura in which strings of pebbles can be detected. This amorphous mass rests on beds of coarse conglomerate. Another outcrop of conglomeratic schist appears in the east end of the Gidhour range.

The gneissic uplands of Hazaribagh in Chutia Nagpur, about one hundred and twenty miles wide, separated the transition rocks of Bihar from those which occupy parts of Manbhum and Singhbhum in South-West Bengal and stretch far to the west, the whole transition area here being one hundred and fifty miles long from east to west and eighty miles wide. The prevailing character of the rocks here may be best explained by an enumeration of the principal kinds that occur on the surface. These are quartzite, quartzitic sandstone, slate, shales, hornblendic, micaceous, talcose and chloritic schists passing into bedded trap, and shales with ripple marks so little metamorphosed that they might be mistaken for Talchirs, or the lowest Gondwana shales, but for veins of quartz penetrating through them. The Chutia Nagpur gneiss is interbedded with micaceous hornblendic and siliceous schists, and occasionally with bands of porphyritic granite and highly metamorphic schists. In Singhbhum the oldest or Bundelkhand gneiss is seen in junction with transition rocks, interpenetrated by trap-dykes. Sandstones and mudstones, resting immediately on the rough and weathered surface of the granitic gneiss traversed by trap-dykes is the prevailing character of the Singhbhum soil. "Dome-gneiss" prevails in the northern fringe of the Hazaribagh plateau and the Mandar hill of Bhagalpur. Trap-dykes though common in the Bundelkhand gneiss are rare in the Bengal gneiss. We do not see the same extensive basaltic intrusions in Southern Monghyr, Hazaribagh and Chutia Nagpur as we do in Birbhum where they belong not to the Archæan but to the Rajmehal age.

We have thus seen that, although the prevailing character of the soil of Bengal and Bihar is alluvial, either old or new, we have important exceptions all over the outlying districts, where rocks of older epochs prevail.

The age of rocks can be only vaguely guessed by their texture. The study of fossils alone gives us exact clue as to which period a particular sandstone, or a particular limestone, or a particular shale, belongs. As an agriculturist one should be able to judge from the external appearance of soils and sub-soils and with such rough and ready test as is afforded by a little hydrochloric acid, their general character and composition, and a knowledge of the principal minerals and of the method of distinguishing and testing them will help one to judge still better whether a soil is rich or poor and whether it is capable of much improvement by the utilization

of local resources. The value of trap-rocks in the formation of rich soils has been mentioned. The presence of a large variety of rocks is also of great value in forming rich soils. A valley or a plain situated near a hill where shales, sandstones, limestones and felspathic granite or gneiss occur in abundance must be rich in plant-food. The junction of two geological formations is always rich. The alluvial deposits differ in character according to the difference in the character of rocks composing the hills from which they are derived. Usually, however, alluvial soils abound in plant-foods, especially the farther they are situated away from mountains. The delta of the Ganges represents washings of the finer particles of all the Bengal hills and what is of great importance, it is full of organic matter, being the receptacles of the drainage of a large and populous tract of country and of hills abounding in forests. The combination of minerals and organic matter is far greater in the lower part of the basin of the Ganges than in the upper parts. But where in the upper parts of the basin the soil is clearly derived from felspathic granite or trap-rocks and limestones, it is richer than alluvium.

### CHAPTER III.

#### FORMATION OF SOILS.

Sedentary and transported soils; Kankar; Knowledge of composition of soil and stones how far useful; External characters; Evidence of composition and fertility; Fossil remains indicative of fertility; Value of Archæan and metamorphic soils; Trap-rocks and volcanic tufts making superior soils; Presence of felspathic stones desirable; Disintegration by aqueous, atmospheric, physical and organic agencies; Nature's cultivators (earth-worms, etc.); Chemical and bacteriological disintegration: Physical and chemical properties of humus, Mixed soils.]

SOILS are formed by the weathering and disintegration of rocks. Soils are either *sedentary*, that is, formed out of the underlying rocks, or *transported*, that is, formed out of the disintegrated parts of rocks, brought down, mainly by the action of rivers from a distance. Sedimentary rocks containing fossil remains of plants were soils at some ancient geological period. The superposition of layer after layer of silt on them resulted in their becoming compacted under pressure. By volcanic or other action these solidified masses have often been brought again to the surface in the form of mountains and thus have become once more subject to the action of rain and heat and cold and the atmosphere, and once more they have been weathered and converted into soils. In geological language, the loose top-soil is also a rock, and in some future age, what is now soil with herbs and trees growing on it may become a fossil-bearing hard rock with other rocks superposed

on it. Underneath the loose matting of earth both on land and under the sea there is the uneven pavement of stone, jutting out into high mountains, or sinking deep in valleys and ravines, or extending far and wide in plains and table-lands. There are mountains and valleys and plains both under the sea and on land. The agriculturist is mainly concerned with the loose matting of soil and sub-soil on dry land and scarcely at all with the stone pavement underneath, unless it occurs within easy depth, in which case he can get building-stones, coals, or other minerals, or even valuable manurial substances for improving his soil by digging down a short depth or carrying from a short distance. An admixture of 10 to 15 per cent. of small stones of the right kinds with agricultural soils is not undesirable, as these contain valuable reserve materials of food which gradually get dissolved and made available as plant-food. But an admixture of large-sized stones in the soil is generally not desirable, as they interfere with proper aeration of soil, germination of seed and penetration of roots. The agriculturist should not only have an idea of the composition of his soil and of the stones which are found in the soil, but also of the sub-soil or the soil immediately below the surface soil interpenetrated with the roots of deep-rooted plants. The sub-soil is more compact in appearance and is usually of a lighter colour. It is very important that the sub-soil should be lighter but richer than the soil, and if the soil is sedentary, that the underlying rock should be composed of substances which are valuable for plant-life. In transported soils also, valuable minerals, such as lime or kankar and gypsum, may be found buried within easy reach of the surface. Chemical analysis does not always give a correct idea of the actual present value of a soil, sub-soil, or rock, but it tells us of their possible ultimate value. In a hard rock scarcely any plant-food exists in an available form, and nothing will grow on such a rock. In the case of soils also a great deal depends on cultivation and not on their potential richness as found out by chemical analysis. Analysis, for instance, shows, that the soil of the Sibpur Experimental Farm is richer than those of the Burdwan and the Dumraon Experimental Farms. But we actually get at Sibpur poorer crops. The soil of the Sibpur Farm is a hard clay which is difficult and more expensive to cultivate and under the same treatment this soil does not yield such heavy crops as soils actually poorer but which are easier to cultivate. Nevertheless a knowledge of the composition of soils and rocks is of great practical value to the scientific farmer. He knows what plant-food there is, and it rests with him how much of it he can or he ought to make available for a certain crop. A soil may be very fertile, but the fertility may be very quickly exhausted. Deep ploughing will give better results and so will liming for a time, but these processes are exhausting, and it is for the farmer to judge whether his soil is capable of such exhaustive operations. For exhausting and valuable crops, deep ploughing, burning, liming and other exhausting

processes are advisable if the soil is rich, but by bringing too large a quantity of food into a soluble state and by letting chiefly rain to wash it out of the land, though one or two heavier crops may be obtained, the soil in the long run may be impoverished. Chemical analysis is therefore a guide for ascertaining the value of rocks and soils, as the farmer has it in his power to utilise that value slowly or quickly according to his needs by the judicious application of tillage and by manuring.

Though chemical analysis alone gives one the right clue as to the composition and nature of rocks and soils, their external characters often give a rough idea as to what they are and what to expect of them. Indeed, the scientific farmer depends more on rough and ready tests than on careful chemical analysis for judging soils, rocks and minerals. He looks at a dark-coloured soil and may conclude it is rich in nitrogen and potash and suitable for growing corn. He looks at a yellow soil and may conclude it is rich in phosphorus and lime and other mineral matters, and suitable for growing root-crops and fruits as well as corn. He looks at a light-coloured soil and may conclude it is chiefly sand and will grow only mustard and rape and *kalai* to perfection. He looks at a field overgrown with rich and wild vegetation of various kinds, rank grasses, leguminous plants, and creepers, he digs it with his spade and finds he can easily manage that, and while digging he notices dead shells and channels made by earth-worms and insects and he concludes it is rich friable loam, and he prefers it to all the others. The dark-coloured soil, first mentioned, though rich, and though it may show on chemical analysis to contain a larger proportion of phosphorus, lime, and other mineral plant-foods as well as organic plant-food, is perhaps a stiff clay which he finds it difficult to dig with his spade and on the surface of which he notices deep and wide cracks. Though he knows it to be richer, he will not prefer it for ordinary agricultural crops, though he may for permanent pasture, and for such perennial crops, as Rhea, *Abroma augusta*, Sabai grass, Tapioca and such agricultural crops as take long growing, such as *arāhar* and sugarcane. If he can afford to keep it in proper tith and if there are special facilities for irrigation, he may prefer such clay soil to loam, unless the clay is too stiff. Different soils are particularly adapted for particular crops, and when one cannot choose his soil one can at least choose his crops. By cultivation and manuring it is possible to a limited extent to alter the natural adaptability of certain soils to certain crops and these should not be lost sight of in any case.

It has been said that certain stratified rocks were loose workable soil in former geological periods. Hence we find imbedded in hard rocks, fossils of plants and animals that once grew on the soil or disported themselves over it. As the remains of animals and plants are very valuable as plant-food, rocks showing an abundance of fossils, such as certain sandstones, and all limestones, are

productive of very fertile soils. The recognition of fossils is thus of some practical importance to farmers. The fertilising property of the rocks of the crystalline group, *viz.*, archaic and metamorphic rocks, consists chiefly in the presence of an abundance of felspar. Mica is of less importance, and quartz is of the least. All sedimentary rocks and soils being ultimately derived from these crystalline rocks, a knowledge of the composition of these is of value. Mica-schist consists of quartz and mica, and a soil formed out of mica-schist is therefore poor. Gneiss is the same as granite in composition, only it is metamorphic or, in other words, it has become compact and crystalline by the joint action of heat and pressure. Granites, though consisting of felspar, mica and quartz, vary very much in composition according to the proportion in which these minerals occur. The larger the proportion of felspar in granite, the richer it is for the purpose of formation of soils, and red-coloured granite and gneiss form richer soil than grey-coloured ones. Trap-rocks and volcanic tuffs form the richest soils, and a study of the minerals which compose these is of great importance.

The agencies operating in the disintegration of soils are: (1) Aqueous, (2) Atmospheric, (3) Physical and (4) Organic.

(1) Aqueous agency in the disintegration of rocks and soils is the most potent of all. What enormous quantities of solid matter in large and small sizes are dislocated by rain and brought down by streams and cataracts and rivers, may be judged from Everest's calculation of silt carried down by the Ganges alone. Everest calculated that 355,361,464 tons of solid matter are carried down annually to the sea by the Ganges. If 1,000 ships laden with about 1,000 tons of mud daily were employed in emptying their contents into the sea, they would perform the same work which is done by the Ganges. The Brahmaputra carries to the sea a still larger quantity of silt. The hardest and heaviest rocks become converted into rounded boulders and pebbles by the action of the moving water containing sand in motion. Water acts not only mechanically in denuding rocks, but it is also a solvent. The potash, soda, silica and lime get dissolved in water, and rocks may be denuded simply by the solvent action of water. The solvent action of water or minerals is increased by its containing salts in solution and gases in suspension. Besides disintegration due to rainfall and the denudation due to rivers and waterfalls, we have a third form of aqueous agency in operation: sea waves beating against cliffs help in the formation of soils. The action of glaciers in tearing down rocks and in the formation of moraines and erratic boulders may be also included under this head. The hydration of rocks in the presence of water may also be mentioned.

(2) Atmospheric agency acts on rocks chiefly in four ways. First, the carbon dioxide gas contained in the atmosphere renders

the calcium carbonate soluble. Limestones, chalk and *kankar* thus get dissolved and available as plant-food, and the rain-water from calcareous rocks charged with calcium carbonate, flows into the sea where shell-fish and corals and foraminifera utilise the lime in building up their own bodies, which in time settle in the form of dead shells and form new rocks. Secondly, the dew and water-vapour of the atmosphere getting into the interstices of rocks in cold regions become congealed, and the expansion resulting from this has the effect of disintegrating particles of rocks. Thirdly, the oxygen of the atmosphere is a very potent agent for oxidizing and disintegrating surfaces of hard rocks. Fourthly, strong currents of wind carry sand and finer particles of matter (such as common salt) from the sea-shore and the dry beds of rivers into the interior.

(3) Physical agencies operate in disintegrating soils chiefly in the form of heat. Earthquakes, hot-springs and volcanoes have the tendency to alter even the superficial layers of the earth's surface more than we think they do ; but these agencies were more potent in past ages than now. Electric agency is also at work. The water-vapour and the free nitrogen of the atmosphere combine in the presence of lightning and thunder in the form of nitric acid which being brought down by rain acts on the rocks and helps to dissolve their particles more quickly.

(4) Organic agencies are at work in various forms. Minute bacteria are continually at work in soils and on the surface of rocks. Higher forms of vegetation,—lichens mosses, grasses, shrubs, creepers and trees are also most potent in disintegrating rocks. Animal life also is at work chiefly in the sea in the formation of soils. Coral reefs, chalk cliffs, nummulitic and other limestones and marls. consist of dead shells, chiefly of marine animals, large and small. The lime carried in solution by rivers to the sea goes to form the shells of these animals. The silica carried in solution to the sea is used by a minute animal called radiolaria in the formation of its body, or rather the shell round its body. Tripoli-earth and Barbadoes-earth used for grinding purposes are old radiolarian deposits, as chalk is old foraminiferous deposit.

Light diatomaceous earth is of vegetable origin ; but the earth is nearly pure silica. Landshells, caterpillars, moles, voles, musk, shrews and pigs may be also mentioned as nature's cultivators, though they are also to be regarded in the light of pests. Locusts which are the worst of all pests may be also regarded in the light of nature's fertilizers. If locusts are frightened and prevented from alighting, they may not do any damage, but simply leave a thick deposit of droppings, rich in manurial substances culled from forest all along their track.

Earth-worms have also considerable influence in the formation of soils and in altering their character. They derive nourishment

from soil which passes through their intestinal canal, some of the organic matter being digested, while the whole of the earth is mixed up and triturated inside the canal. Worm-casts are particularly useful to the farmer, as they help to loosen and perforate the soil for the penetration of roots, water and air. Worms also drag down leaves, pieces of straw, etc., into their holes, thus incorporating organic matter into the soil, and making heavy soils lighter and light soils heavier. The presence of earth-worms on grass-land consisting of a shallow layer of soil resting on hard rocks is particularly beneficial in gradually adding to the depth of the soil in an imperceptible manner. Darwin computed that an acre of garden soil in England contains on an average about fifty-thousand earth-worms, and in ordinary arable soils about half this number. In India, it is probable that the number is smaller. In good soils ten tons of dry earth is passed through the intestines of earth-worms annually and the surface deposit of casts is about one-fifth of an inch per annum. Even in poor soils a surface deposit of .08 inch per annum has been estimated. As earth-worms go down several feet deep and come up again, the mixing of the soil effected by them is often more efficacious than that effected by cultivation.

It has been observed that a stream of lava takes sometimes several years to cool. Even when cool it is incapable of supporting higher vegetable life. Disintegration takes place by hydration, oxidation and physical action. Nitrification then proceeds with the help of bacteria. Then lichens and other minute forms of vegetation are observed to appear. Gradually the quantity of soil on the hard surface of the rock increases, and the growth of vegetation becomes more vigorous,—mosses, ferns and grasses gradually taking the place of lichens. When visible soil accumulates, and fissures and cracks appear on the rock, herbs and shrubs multiply and by their root-action further help to disintegrate the rock to some depth. The formation of soils now goes on apace. Lichens and bacteria are able to draw nourishment from the most insoluble rocks,—not only basalts, granites and schists, but also quartz. Even quartz gets covered with lichens when exposed long enough to air. The action of higher vegetation on rocks is partly mechanical and partly chemical. Roots get into the clefts of rocks and tear them asunder. Chemical action is concerned in the solution of some of the ingredients of the rock. The solvent action of roots is partly due to the formation of acids in them which act on particles of soil. All plants, large or small, die each year wholly or partly and deposit their dead organic matter on the rock. The falling leaves, seeds, etc., when they accumulate in forests, marshes or bogs, produce a black or brown mass which is called humus. By decay of roots of plants also a similar substance is formed. When organic matter decays in very high temperature, the carbon and hydrogen may get entirely oxidized into carbon dioxide and water, but with limited access of air



the oxidation is slow and the formation of bodies which resist decay for a long time is the result. These are found in the lower layers of turfs and in meadows and forests. The humus so formed is of a complex composition. The acids and other organic substances formed are not clearly understood. The commonest are humic acid ( $C_0 H_{12} O_6$ ), ulmic acid ( $C_{20} H_{14} O_6$ ), geic acid ( $C_{10} H_{12} O_7$ ), crenic acid and apocrenic acid. The composition of crenic and apocrenic acids, discovered by Berze ius, is uncertain. All these compounds retain ammonia with great tenacity. Humus is also a highly hygroscopic substance tending to keep rock moist, and thus helping their further disintegration by hydration. The generation of carbon dioxide in humus is profuse and constant. The air of all soils contains a much higher proportion of carbon dioxide than ordinary atmospheric air, which contains only four or five parts of carbon dioxide in ten thousand parts, while the air in soils contains from ten to two hundred and fifty parts of carbon dioxide in ten thousand parts. The organic acids and carbon dioxide of humus assist in the decomposition of minerals. The nitrogenous matters of humus are gradually converted into ammonium salts and nitrates, especially in the presence of lime and nitrifying bacteria. These salts in their turn assist in disintegration. Plants thus have the effect of disintegrating rocks in various ways, both in their living and dead state. Not only limestones, but even quartz and other hard silicates are found eaten into by roots of plants. Clubmosses, which contain a good deal of alumina (which is not an essential constituent of every plant), are of great help in disintegrating rocks containing alumina. Of agricultural plants, mangold-wurzel and *Chukí-Pálam*, containing a good deal of oxalic acid, have a considerable power of assimilating phosphate from the soil, and they have also considerable power of disintegrating rocks.

The decay of organic matter, helped by the various processes described, results in a supply of phosphoric acid and nitrogen in an available form for the nourishment of plants. Generally speaking, the more organic matter there is in a soil the more nitrogen does it contain, and the proportion of organic matter may be roughly considered as a direct measure of the fertility of a soil. Where *kankar* or other limestones occur in addition to humus matter the evidence of fertility is certain. Generally speaking also the more mixed a soil is (*i.e.*, the larger the number of rocks and minerals out of which it is formed), the more fertile it is. Hence alluvial soils, and soils formed at the junction of two geological formations, are more fertile than soils resting on single formations. Compare, for instance, the comparatively poor crops obtained in the Archæan soils of Singhbhum with the rich crops in the mixed geological formation a few miles outside the borders of this district beyond Katbari, in the Mourbhanj State.

## CHAPTER IV.

## PHYSICAL CLASSIFICATION OF SOILS.

[Diluvial, Alluvial and Colluvial soils ; Light, Heavy ; Warm, Cold ; Moist, Dry ; Garden-soils ; Pasture-land ; Wheat-soil ; *Ēk-phasli* and *Do-phasli* land ; Stony, gravelly, gritty, sandy, clayey and calcareous soils ; Peat ; Marsh ; Mechanical analysis ; Different kinds of loam ; Classifications of Settlement Officers of different Provinces ; Tilth, sub-soil and pans.]

THE classification of soils into sedentary and transported has been already mentioned. Transported soils are again sub-divided into diluvial and alluvial. Diluvial or drift soil consists of soil proper mixed up with stones and boulders, brought down by rain from hills. These are usually formed from various kinds of rocks. Alluvial soil consists of fragments or particles of minerals arranged according to their size and also partly according to their specific gravity. Alluvial soils are, as a rule, more fertile containing fragments of rocks of different geological periods. Alluvial soils mixed with more or less angular fragments of the rocks on which they lie are called colluvial.

Soils are also classed as light and heavy, warm and cold, moist and dry. They are also classified according to the crops which do best on them, or which ought to be grown on them for economical reasons. The richest soils form *garden-soils* ; middling clay-loam soils, *wheat-soils* : hard clay which is expensive to work, *pasture-land* ; poor harsh land, *wood-soil*. Soils are also classified according to their prevailing physical constituents. These are, stone, gravel, grit, sand, clay, calcium carbonate, vegetable matter and moisture. Soils are thus divided into stony, gravelly, gritty, sandy, clayey, calcareous, peaty and marshy. There is, however, no hard-and-fast distinction between one group and the next. It is difficult to say where sand begins and grit ends or where stone ends and gravel begins. Sand may be again siliceous, or micaceous, or calcareous, or felspathic, that is, either containing a good deal of plant-food or none at all. Stones and pebbles are not immediately useful for plant-life, but they serve a useful purpose in retaining moisture and acting as a reserve of plant-food. Stony soils therefore though usually poor are not so necessarily, and some stony soils, *viz.*, those which contain chiefly fossils, lime-stones, basaltic stones and felspars, are rich.

The *mechanical analysis* of soils is done by sifting and washing. Shifting separates the coarser particles and washing the finer particles. The sample of soil to be analysed is to be spread on the floor of a dry and warm room ; lumps are to be broken up and crushed as drying proceeds. The large *stones* are then to be picked out, cleaned, dried and weighed. The dry soil is then to be passed through a sieve, the meshes of which are three millimeters in diameter. That which passes through is weighed as *fine earth*, and

what remains on the sieve as *gravel*. The gravel is further washed and dried and weighed again as *true gravel*. The fine earth is then boiled for an hour to break up lumps, and it is then put into a *washing apparatus* (e.g., Schulz's apparatus) in which by introducing a flow of water at different rates, first the finest suspended matter is washed away and then successively the finest sand and coarser sand.

Another process of mechanical analysis of soils consists in arranging a series of vessels side by side and allowing the water from the one to flow into the next. This also divides the soil into portions of different consistency. For either process it is necessary finally to let the water evaporate completely from each vessel and to weigh the dry residue. This analysis enables us to separate the soil into (1) stones; (2) mechanical gravel; (3) coarse sand; (4) fine sand; (5) finest sand; and (6) clay and impalpable matter. Clay-soil proper is that which contains only clay and very fine sand.

A more rough and ready method of mechanical analysis consists in taking an ounce of soil, mixing it up with a pint of water, leaving it in the water for twenty-four hours, then shaking it up and allowing the heavier particles to settle for five minutes. The supernatant liquid can then be poured into another vessel which may be allowed to stand for another twenty-four hours. The sandy part will be seen settled in one vessel and the clayey part in the other. These may be dried and weighed separately.

If one hundred grains of dry soil, not peaty or unusually rich in vegetable matter, leave no more than ten grains of clay treated in this manner, it is called *sandy soil*; if from ten to forty *sandy loam*; if from forty to seventy a *loamy soil*; if from seventy to eighty-five a *clay loam*; from eighty-five to ninety-five a *strong clay soil*; and when no sand is separated at all by this process, it is a pure *agricultural clay*. Soil containing more than 5 per cent. of carbonate of lime is called *marl*, and more than 20 per cent. *calcareous soil*. *Peaty soils* contain more than 5 per cent. of humus or vegetable mould. Ferruginous soils contain over 5 per cent. of iron. Sandy soil is known in Bengal by the names *Balu Balmat*, *Balsundar*; sandy loam by the names *Balu-doas*, *Dhus* and *Dhusar*; loamy soil by the names *Doás*, *Do-ras*, *Do-áns*, *Khirmi*, *Pauru* and *Gurmat*, and clay-soil by the names *Kádá*, *Kewal* and *Matti-gar*; hard clay is known as *Anthial matti* and *Nágrú*; gritty soil is known as *Kankuria* or *Rugri*; while red ferruginous loam is called *Lal-mati*.

For practical purposes, however, the systems of classification of soils in vogue in Bengal and in the other Presidencies are numerous. They are based on various fundamental distinctions. Land is classified, for instance, as irrigated, irrigable and non-irrigable; also as *ek-phasli* and *do-phasli* or single-cropped and double-cropped; also as cultivated, culturable and non-culturable.

The cultivated land may be also divided according to crops, thus as *suna* or *bhadoi* land and *shali* or low land suitable for *aman* paddy (called also *aghani* land) and *rabi* land. Vegetables, *arabar*, and sugarcane are classed with *rabi* crops; indigo with *bhadoi* crops and sweet potatoes with *aghani* crops. *Pan* garden land is curiously enough classified with the uncropped area in settlement operations in Bengal and thatching grass also. The culturable area is sub-divided into (1) New (or less than three years') fallow; (2) Old fallow; (3) Groves; (4) Grass; (5) Bush; (6) other kinds 'including *pan* gardens, forest, bamboo clumps, threshing floors, waste adjoining village sites, temporary sheds, pathways and excavations). The non-culturable area is sub-divided into (1) Village sites; (2) Sites of temples and burial ground; (3) Unculturable waste as, for instance, "*usar*;" (4) Tanks; (5) Rivers; (6) Unculturable *Jhils* and *Churs*; (7) Government roads; (8) other roads; (9) other kinds of unculturable lands (e.g., camping grounds, embankments, mounds, railroads, barracks, bungalows, brick and lime kilns, permanent cattle-sheds, serais, etc.). Land is also classified as *áwál*, *doem*, *soem* and *cháháram*, or 1st, 2nd, 3rd and 4th class; also as (1) *bastu*, (2) *udbastu*, (3) garden, (4) bamboo and orchard, (5) *mathan*, (6) *bilan*, and (5) *dearh*. Each of these is sub-divided into *áwál*, *doem*, *soem* and *cháháram*. Lands are also classified according to proprietary rights: e.g., (1) Permanently Settled lands; (2) Waste-lands for which revenue has never been settled; (3) Temporarily settled estates or tenures the property of Government or of private individuals; (4) Estates or tenures purchased on account of Government or escheated or forfeited to Government; (5) Resumed revenue free lands; (6) Islands thrown up in navigable rivers; (7) Alluvial accretions; (8) Lands acquired but no longer required for public purposes; (9) Lands annexed by conquest; (10) Occupancy holding; (11) Non-occupancy *Khudkasta* and *Paikasta* holdings. A revenue officer describing a piece of land has thus several principles of classification to bear in mind. They all have some relation to the intrinsic value of the soil; and the farmer also must look into all these principles before deciding the value of a property he wishes to buy for agricultural purposes. The fixity of tenure and of rent is of the utmost value to the tenant in encouraging him to go in for agricultural improvements.

In addition to fertility and fixity of tenure, the following considerations also affect the value of lands:—

- (1) Climate, healthy or unhealthy.
- (2) Whether local labour is abundant, industrious and skilful.
- (3) Amount of rainfall whether more than sixty inches per annum.
- (4) Whether the tract has been subject to famine or local failure of crops due to drought or inundations.

(5) Whether the land is level and well exposed to sunshine, or whether it is steep ravine land.

(6) Distance from the purchaser's residence.

(7) Vicinity to good markets.

(8) Means of communication with the markets.

(9) Facilities for irrigation, for instance, the depth of water in wells.

(10) Depredations by cattle, wild boars, rabbits, etc.

(11) Local supply of manures.

In the United Provinces the following classification of soils is generally in vogue :—

1st.—*Gohani* land or land near villages and towns. In village *gohani* land the crops usually grown are, wheat, sugarcane for *gur*-making or *ukh*, vegetables, maize, radish, carrots and *chillies*. In town *gohani* land market-gardening is practised, that is to say, the growing of potatoes, cabbages and cauliflower, chewing canes or *poundash* and tobacco.

2nd.—*Loam*. Wheat, barley, gram, *jowar*, cotton, with *araha*r and maize are usually grown on such lands. *Jowar bajri* and cotton are grown, as a rule, with *araha*r both on *gohani* and loamy soils. When the land is very rich, *araha*r which occupies it for a whole year, is not grown in mixture.

3rd.—*Sandy loam*. *Bajri*, *kalai*, barley with gram, *jowar*, mustard with wheat and other *rabi* crops, are grown on such soils.

4th.—*Clay loam*. Barley mixed with gram (or gram alone) or with pea (or pea alone), sugarcane, *mung* and paddy, are grown on such soils.

5th.—*Clay-soil near tanks*. The same crops are chosen for such soils as for clay-loam. Only these are harder to work and, being more subject to floods, are more uncertain.

6th.—*Bhur or sandy soils*.—(a) near rivers (*dearh land*), suitable for growing melons and other similar crops: (b) in fields suitable for growing *bajri* along with *til* or *kalai* or *mung*, also barley with wheat or mustard.

7th.—*Kankreli soil*. Full of calcareous nodules, suitable for growing gram and leguminous crops generally. *Bajri*, *jowar*, *urd* gram, barley, pea and mustard are the usual crops grown on *kankreli* soils.

In the Madras Presidency the following classification of soils is generally in vogue :—1st.—*Karisol*, or Black soil, Nos. 1 and 2. 2nd.—*Seval*, or Red loam, Nos. 1 and 2. 3rd.—*Guruman*, or Clay-loam, Nos. 1 and 2. 4th.—*Veppal*, or dry and hungry sandy soil, which is so common in Madras, Nos. 1 and 2. 5th.—

*Pottal*, or barren soil, either too saline or too ferruginous (*laterite*) to grow crops of any value.

In the Central Provinces the recognised divisions are *Kali*, Nos. 1 and 2 (*i.e.*, Back soil); *Morun*, Nos. 1 and 2 (Loam); *Kherdi*, Nos. 1 and 2 (Sandy soil); and *Berdi*, Nos. 1 and 2 (Stony soil).

In the Bombay Presidency, Revenue officers follow a very systematic method of classifying soils. This method, however, is unsuitable for deep alluvial soils where depth is of no practical value for classifying soils which are all very deep. Soils in Bombay are divided into nine classes according to their depth and three orders according to their colour and texture. The following table gives an idea of the system followed :

| Class. | Anna-valuation. | ORDER I.   | ORDER II.   | ORDER III.  | REMARKS.  |
|--------|-----------------|--|---|---|---|
|        |                 | Uniform fine texture, black to dark brown in colour. | Uniform coarse texture, lighter in colour, usually red. | Gravelly or loose, friable texture, colour light brown to grey. |   |
| 1      | 16              | 1½ cubit or more                                     | ....  | ....  | A greater depth than 1½ cubit does not affect the fertility of land. Soils of the 3rd order are never more than 1 cubit deep.<br>If the rent of the 1st class soil is Re. 1, that of the 9th class soil is estimated at 2 as. |
| 2      | 14              | 1½ cubit   | 1½ cubit or more,                                       | ....  |   |
| 3      | 12              | 1¼ "   | 1½ cubit  | ....  |   |
| 4      | 10              | 1 "  | 1¼ "  | ....  |   |
| 5      | 8               | ¾ "  | 1 "   | ....  |   |
| 6      | 6               | ½ "  | ¾ "   | 1 cubit.  |   |
| 7      | 4½              | ¼ "  | ½ "   | ¾ "   |   |
| 8      | 3               | ....   | ¼ "   | ½ "   |   |
| 9      | 2               | ....   | ....  | ¼ "   |   |

The following conventional signs for peculiarities or defects of soils are in use in the Bombay Presidency :—

∴ Denotes a mixture containing nodules of limestone.

V An inordinate admixture of sand.

/ A sloping surface.

X Absence of cohesion among soil-particles.

△ More or less imperviousness to water.

Liability to be swept away by running water.

□ Excess of surface-water.

Besides the ordinary division into *surface soil* and *subsoil* layers, in between, known as *pans*, sometimes occur. These are

of three kinds : (1) *Moor-band pan* which exist as an impervious deposit a few inches below the surface. Salts of iron combining with dead plants washed down by rain, oxidise and form a cement which require to be broken up by strong subsoil cultivation ; (2) *Calcareous pan* is the result of long continued shallow ploughing of soils rich in lime, the lime sinking gradually and forming a cement ; (3) *Hard pan*. The cementing material in this case may be oxide of iron or alkali silicates or calcium carbonate. *Pans* should be broken up by deep ploughing. The use of country ploughs, however, prevents the formation of *pans*. Where European ploughs are used, subsoilers may have to be employed occasionally in breaking down or disturbing *pans*.

## CHAPTER V.

### CHEMICAL CLASSIFICATION OF SOILS.

[Chemical composition of plants ; Classification according to chemical requirement of plants (moist, nitrogenous, phosphatic, potassic, calcareous, ferruginous, siliceous, alkali soils and sulphurous soils) ; Excess of soluble salts over two parts of solids dissolved in 1,000 parts of water, injurious. Why urine burns up plants ; Schubler's Classification ; Proportions of nitrogen and phosphorus needed ; Ville's normal manure : five-plot and ten-plot experiments.]

PLANTS derive the bulk of their food from the air and from water. The largest proportion of a plant consists either of carbon or of water. Potatoes contain as much as 75 per cent. of water, carrots and beetroot 80 or 90 per cent., a tree felled when the leaves have shed in the cold weather contains from 30 to 50 per cent. of water, and when it is in leaf it contains 40 to 60 per cent. of water. The carbon or the charcoal portion of a plant also varies very much, but it usually comes next in importance to water. The carbon is fixed in plants with the help of sunlight acting on chlorophyll granules, out of the carbon dioxide of the air. Air contains, on the average, about four parts of carbon dioxide in every ten thousand parts, and the carbon of plants is therefore derived without any trouble on the part of the cultivator. The nitrogen of plants is partly derived from the atmosphere by means of rainfall without any trouble, but it is also derived mainly from the soil and manures applied to it. The presence of nitrates and ammonia in the soil is therefore of great importance. In fact, the amount of nitrogen present in a soil mainly determines its value. Besides water, carbon and nitrogen, there are also certain other constituents of plants which are essential, though usually occurring in minuter proportions. Plants depend entirely on soils for these minute but essential constituents. When a plant is

burnt into ashes, its carbon, water and nitrogen pass away, and the ash left always contains the following :—phosphoric acid, sulphuric acid, potash, lime, magnesia and iron as protoxide ( $\text{FeO}$ ) and sesquioxide  $\text{Fe O}_3$ , soda, silica and chlorine are also nearly always present, though some plants can do without these food constituents. Alumina is only sometimes present.

According to the chemical requirements of plants, soils can be divided into : (1) aqueous or boggy soils ; (2) nitrogenous soils ; (3) Phosphatic soils ; (4) Potassic soils ; (5) Calcareous soils ; (6) ferruginous soils ; (7) Siliceous soils ; (8) Alkali soils (containing an abundance of lime, magnesia, soda, and potash), and (9) Sulphureous soils. Water is of the highest value, then nitrogen, then phosphorus, then potash, then lime and magnesia, then sulphur, then iron, and lastly silica, chlorine and soda. The physical importance of silica or sand, as making the soil freer and lighter to work and for roots to penetrate, is very great, but not its chemical importance. The chemical importance of the soluble silicates in soils is, however, very great. The importance of chlorine and soda as present, for instance, in common salt for certain crops such as cocoanuts, mangoes, beet (not sugar-beet), onions, carrots, radishes, potatoes, cabbages, cotton, cashew-nuts, date, breadfruit tree, asparagus is undoubted, but the presence of these is not essential in the soil for every crop. Potash can replace soda in some plants, and the presence of potash is therefore doubly important. The absence of any of the essential constituents of plants just enumerated, makes a soil quite sterile. But it is rare to meet with a soil wanting altogether in moisture, or nitrogen, or phosphoric acid, or potash, or lime, or magnesia, or iron, or sulphuric acid. Plants generally grow in any soil which contains a sufficient proportion of these. The presence of an excess of certain salts or of some substances poisonous to plants may render the soil sterile in spite of the presence in sufficient quantities of all the essential constituents. Nearly every soil contains all the essential constituents for the growth of vegetation, and even the well-water or drainage-water percolating through soils contains all the essential constituents for the growth of vegetation, so much so, that water-culture with such well or drainage-water alone has been successful with reference to a good many plants, including oats. It is from solutions that plants can absorb food. The solubility is helped by the organic acids and the carbon-dioxide excreted by the rootlets. Soil digested in water ought to part with one part of solid for every thousand parts of water for plants to make proper use of the solid. If over two parts of solid are dissolved in every thousand parts of water, the rootlets cannot make proper use of the food, nor if less than one part in two thousand parts. A soil can be too rich in soluble plant-foods or too poor. A soil becomes too rich if in the dry season it is manured with fresh urine which contains nearly 2 per cent. of urea, a substance which can be directly used by plants as food. But a 2 per cent. solution even of a valuable plant-food is at



least ten times too rich. This accounts for Bengal cultivators regarding urine as injurious to crops, though it is really more valuable in the fresh state than cowdung. Diluted with ten times as much water urine proves a most excellent fertilizer of soils. As nearly all soils contain all constituents of plant-food, the chemical classification of soils is based not on absolute but only on relative grounds.

Schubler's classification is based on a consideration of only four of the proximate constituents of soils, *viz.*, Humus, Lime, Clay and Sand. It takes no direct cognizance of the proportion of nitrogen, phosphoric acid, and potash which are the important constituents of soils, the excess or deficiency of which chiefly determines the fertility or barrenness of soils. But humus implies nitrogen; and lime not only lime itself, but also usually phosphoric acid, clay, potash, sand and the soluble silicates, indicate the nature of fertility. Schubler's classification has also the merit of being easily applicable in practice to ordinary farming, as it does not depend on elaborate chemical analysis, but only on such rough and ready methods of analysis as an intelligent and educated farmer can easily command.

To determine the class of any soil according to Schubler's Table, the following direction should be followed:—

(1) Take one hundred grains of a well-pulverized soil after drying it for half an hour in an air or oil-bath at 250°F. Heat it in a platinum crucible over a clear flame for half an hour, stirring the mass occasionally. Cool it in a desiccator and weigh. The loss of weight is calculated as *Humus*.

(2) Digest the residue in the platinum crucible in a phial with cold diluted hydrochloric acid in the proportion of half an ounce of acid to ten ounces of water to one hundred grains of dry soil. Let the digesting go on for half an hour with occasional stirring. Filter through a weighed filter-paper, wash with distilled water until the water passing through ceases to give acid reaction tested with litmus paper. Dry the whole at 250°F.; weigh the substance in the filter-paper; deduct the weight of the filter-paper. The loss of weight represents very roughly the amount of lime.

(3) The contents of the filter-paper are now carefully removed into a tall glass cylinder, and the impalpable matter separated from the sand and coarser particles by repeated washing with water. Stir well, let it subside for a minute and then pour off the supernatant liquid. The impalpable matter thus separated is collected on a filter, dried as before and weighed. The weight represents the weight of clay.

(4) The remainder is sand.

Proceeding on the above method we can refer any soil to Schubler's Table which is given on the following pages.

CLASSIFICATION AND NOMENCLATURE OF SOILS AFTER SCHUBLER.

| Names of the Different Descriptions of Soils.   | Proportions of Ingredients in Every 100 Parts. |                                |          |            |            | Agricultural designation and general relations with reference to their produce. |
|---|--|--------------------------------|----------|------------|------------|---|
|   | Classes.                                       | Orders.                        | Species. | Clay.      | Lime.      |   |
| 1. <i>Argillaceous or Clayey Soils.</i><br>Above 50 per cent. of Clay. Not more than 5 per cent. of Lime.         | { Without Lime                                 | { Poor<br>Intermediate<br>Rich | Above 50 | Trace      | 0.0 to 0.5 | The   |
|   |  |                                | " 50     | Trace      | 0.5 to 1.5 | Remainder   |
|   | { With Lime                                    | { Poor<br>Intermediate<br>Rich | Above 50 | 0.5 to 5.0 | 0.0 to 0.5 | "   |
|   |  |                                | " 50     | 0.5 to 5.0 | 0.5 to 1.5 | "   |
|   | { Without Lime                                 | { Poor<br>Intermediate<br>Rich | 30 to 50 | Trace      | 0.0 to 0.5 | "   |
|   |  |                                | 30 to 50 | Trace      | 0.5 to 1.5 | "   |
| 2. <i>Loamy Soils.</i><br>Not more than 50 nor less than 30 per cent. of Clay. Not more than 5 per cent. of Lime. | { Without Lime                                 | { Poor<br>Intermediate<br>Rich | 30 to 50 | Trace      | 0.0 to 0.5 | "   |
|   |  |                                | 30 to 50 | Trace      | 0.5 to 1.5 | "   |
|   | { With Lime                                    | { Poor<br>Intermediate<br>Rich | 30 to 50 | 0.5 to 5.0 | 0.0 to 0.5 | "   |
|   |  |                                | 30 to 50 | 0.5 to 5.0 | 0.5 to 1.5 | "   |
|   | { Without Lime                                 | { Poor<br>Intermediate<br>Rich | 20 to 30 | Trace      | 0.0 to 0.5 | "   |
|   |  |                                | 20 to 30 | Trace      | 0.5 to 1.5 | "   |
| 3. <i>Sandy Loams.</i><br>Not more than 30 nor less than 20 per cent. of Clay. Not more than 5 per cent. of Lime. | { Without Lime                                 | { Poor<br>Intermediate<br>Rich | 20 to 30 | Trace      | 0.0 to 0.5 | "   |
|   |  |                                | 20 to 30 | Trace      | 0.5 to 1.5 | "   |
|   | { With Lime                                    | { Poor<br>Intermediate<br>Rich | 20 to 30 | 0.5 to 5.0 | 0.0 to 0.5 | "   |
|   |  |                                | 20 to 30 | 0.5 to 5.0 | 0.5 to 1.5 | "   |
|   | { Without Lime                                 | { Poor<br>Intermediate<br>Rich | 20 to 30 | Trace      | 0.0 to 0.5 | "   |
|   |  |                                | 20 to 30 | Trace      | 0.5 to 1.5 | "   |

(*Paddy Land.*)  
Sugarcane, paddy, wheat, *arab* gram, peas, beans, *mung*, muscad, cabbages do well on such land. The calcareous kinds, not too rich in clay and not too poor in sand and humus, give good returns. Those poor in humus are still suited for oats.

(*Vegetable Land.*)  
Wheat, barley, gram, *javar*, cotton, *arabhar*, maize, beans and cauliflower are the most appropriate crops for this class of land.

(*Suna Land.*)  
*Bajri*, *katari*, *aus* paddy, barley with wheat, *javar*, mustard with wheat, and other *rabi* crops, potatoes, turnips and other roots thrive well in lands with lime.

CLASSIFICATION AND NOMENCLATURE OF SOILS AFTER SCHUBLER.---(contd.).

| NAMES OF THE DIFFERENT DESCRIPTIONS OF SOILS   |              | PROPORTIONS OF INGREDIENTS IN EVERY 100 PARTS |          |            |            |               | Agricultural designation and general relations with reference to their produce.  |
|--|--------------|---|----------|------------|------------|---------------|--|
|  |              | Orders.                                       | Species  | Clay       | Lime       | Humus.        |  |
| 4. <i>Loamy Sands.</i><br>Not more than 20 per cent. of Clay. Less than 5 per cent. of Lime. | Without Lime | Poor Intermediate Rich                        | 10 to 20 | Trace      | 0.0 to 0.5 | The Remainder | <i>(Jowar and Khar Lands.)</i><br>Suitable for growing <i>kharai</i> , mustard, <i>soyaya</i> , cucurbaceous vegetables, barley if rich in humus, and <i>jowar</i> Indigo and buck wheat in lands with lime. Barley and buck wheat thrive well in those rich in humus.   |
|  |              |   | 10 to 20 | Trace      | 0.5 to 1.5 | "             |  |
|  | With Lime    | Poor Intermediate Rich                        | 10 to 20 | 0.5 to 5.0 | 0.0 to 0.5 | "             | <i>(Villet Land)</i><br><i>Bajri</i> with <i>titi</i> , <i>soyaya</i> , <i>kharai</i> or <i>mung</i> , also barley with mustard and wheat. Of less value, often cultivated only every third year, and the poor lands not at all. Those containing humus and lime are chiefly fit for buck wheat, oats, hemp, tobacco, potatoes, mullets and maize. |
|  |              |   | 10 to 20 | 0.5 to 5.0 | 0.5 to 1.5 | "             |  |
| 5. <i>Sandy Soils.</i><br>Not more than 10 per cent. of Clay. Less than 5 per cent. of Lime. | Without Lime | Poor Intermediate Rich                        | 0 to 10  | Trace      | 0.0 to 0.5 | "             | <i>(Paddy and arhar land.)</i><br>Land suited for paddy <i>arhar</i> , wheat, <i>khesari</i> , and <i>munar</i> .  |
|  |              |   | 0 to 10  | Trace      | 0.5 to 1.5 | "             |  |
|  | With Lime    | Poor Intermediate Rich                        | 0 to 10  | 0.5 to 5.0 | 0.0 to 0.5 | "             |  |
|  |              |   | 0 to 10  | 0.5 to 5.0 | 0.5 to 1.5 | "             |  |
| 6. <i>Marly Soils.</i><br>(More than 5 but not more than 20 per cent. of Lime).              | Argillaceous | Poor Intermediate Rich                        | Above 50 | 5 to 20    | 0.0 to 0.5 | "             |  |
|  |              |   | "        | 5 to 20    | 0.5 to 1.5 | "             |  |
|  |              |   | 50       | 5 to 20    | 1.5 to 5.0 | "             |  |

|                              |              |          |          |            |              |   |
|------------------------------|--------------|----------|----------|------------|--------------|---|
| Loamy                        | Poor         | 30 to 50 | 5 to 20  | 0.0 to 0.5 | ..           | (Pulse land.)<br>Wheat, potatoes, barley and pulses.  |
|                              | Intermediate | 30 to 50 | 5 to 20  | 0.5 to 1.5 | ..           |   |
|                              | Rich         | 30 to 50 | 5 to 20  | 1.5 to 5.0 | ..           |   |
| Belonging to the Sandy Loams | Poor         | 20 to 30 | 5 to 20  | 0.0 to 0.5 | ..           | (Barley land.)<br>Barley, oats, gram and maize.   |
|                              | Intermediate | 20 to 30 | 5 to 20  | 0.5 to 1.5 | ..           |   |
|                              | Rich         | 20 to 30 | 5 to 20  | 1.5 to 5.0 | ..           |   |
| Belonging to the Loamy Sands | Poor         | 10 to 20 | 5 to 20  | 0.0 to 0.5 | ..           | (Jowar and bajri land.)<br>Oats, jowar, pulses and bajri.   |
|                              | Intermediate | 10 to 20 | 5 to 20  | 0.5 to 1.5 | ..           |   |
|                              | Rich         | 10 to 20 | 5 to 20  | 1.5 to 5.0 | ..           |   |
| Humus                        | Clayey       | Above 50 | 5 to 20  | Above 5.0  | ..           | (Corn land.)<br>The humus and argillaceous marly soils are amongst the best that exist.   |
|                              | Loamy        | 30 to 50 | 5 to 20  | " 5.0      | ..           |   |
|                              | Sandy        | 20 to 50 | 5 to 20  | " 5.0      | ..           |   |
| Argillaceous                 | Poor         | Above 50 | Above 20 | 0.0 to 0.5 | ..           | (Pulse land.)<br>The argillaceous soils often approach in value to the argillaceous marls; the remaining orders of both these classes equally correspond one with the other; to the most valuable beings, as in the case of marly soils, the humus. Those wanting in humus require much manure. Those rich in clay are well suited for wheat. Oats and lucerne thrive in them. Their value is much decreased by |
|                              | Intermediate | " 50     | " 20     | 0.5 to 1.5 | ..           |   |
|                              | Rich         | " 50     | " 20     | 1.5 to 5.0 | ..           |   |
| Loamy                        | Poor         | 30 to 50 | " 20     | 0.0 to 1.5 | ..           |   |
|                              | Intermediate | 30 to 50 | " 20     | 0.5 to 1.5 | ..           |   |
|                              | Rich         | 30 to 50 | " 20     | 1.5 to 5.0 | ..           |   |
| Belonging to the Sandy Loams | Poor         | 20 to 30 | " 20     | 0.0 to 0.5 | ..           |   |
|                              | Intermediate | 20 to 30 | " 20     | 0.5 to 1.5 | ..           |   |
|                              | Rich         | 20 to 30 | " 20     | 1.5 to 5.0 | ..           |   |
| Belonging to the Loamy Sands | Poor         | 10 to 20 | " 20     | 0.0 to 0.5 | ..           |   |
|                              | Intermediate | 10 to 20 | " 20     | 0.5 to 1.5 | ..           |   |
|                              | Rich         | 10 to 20 | " 20     | 1.5 to 5.0 | ..           |   |
| Sandy                        | Poor         | 0 to 10  | " 20     | 0.0 to 0.5 | Any portion  |   |
|                              | Intermediate | 0 to 10  | " 20     | 0.5 to 1.5 | less than    |   |
|                              | Rich         | 0 to 10  | " 20     | 1.5 to 5.0 | 80 per cent. |   |

i. Marly Soils.—concl'd.

7. Calcareous Soils.  
(Containing more than 20 per cent. of Lime.)

## CLASSIFICATION AND NOMENCLATURE OF SOILS AFTER SCHUBLER.—(Concd.)

| Classes.   | NAMES OF THE DIFFERENT DESCRIPTIONS OF SOILS. |              | PROPORTIONS OF INGREDIENTS IN EVERY 100 PARTS. |                 |            |       | Agricultural designation and general relations with reference to their produce.   |
|--|---|--------------|--|-----------------|------------|-------|---|
|  | Orders.                                       | Species.     | Clay.  | Lime.           | Humus.     | Sand. |   |
| 7. <i>Calcareous Soils.</i><br>(Containing than more<br>20 per cent. of Lime.)<br><i>—concd.</i> | Pure  | Poor         | 0  | Above 99        | 0.0 to 0.5 | None  | containing an excess of lime. It makes soils both hungry and thirsty, <i>i.e.</i> , they need heavy manuring and irrigation, unless there is humus in them over 5 per cent. But oats and most pulses and lucerne will do on such soils.   |
|  |   | Intermediate | 0  | " 98            | 0.5 to 1.5 | "     |   |
|  | Rich  | 0            | " 94   | 1.5 to 5.0      | "          |       |   |
|  | Humus   | Clayey       | Above 50                                       | " 20            | Above 5.0  | The   |   |
| Loamy  |   | 30 to 50     | " 20   | " 5.0           | Remainder  |       |   |
| 8. <i>Humus Soils.</i><br>(Containing more than 5<br>per cent. of Humus.)                        | Soluble Mild<br>Humus                         | Sandy        | 20 to 50                                       | " 20            | " 5.0      | "     | <i>(Land for oil seeds and vegetables.)</i><br>The value of these soils is greatly augmented by admixture with lime. Those which contain lime and clay are suited for wheat, barley, cucurbitaceous vegetables, and oleaginous plants; the loamy and sandy are specially adapted for oats, and in most places for wheat. The peaty and acid humus may be made fruitful by admixture with lime, sand and clay. |
|  |   | Loamy        | Above 50                                       | With or without | Above 5.0  | "     |   |
|  | Sandy   | 30 to 50     | Lime.  | " 5.0           | "          |       |   |
|  | Insoluble Car-<br>bonized or<br>Acid Humus.   | Clayey       | Above 50                                       | With or without | " 5.0      | "     |   |
| Loamy  |   | 30 to 50     | Lime.  | " 5.0           | "          |       |   |
| Insoluble Fi-<br>brous Vege-<br>table matters.   | Bog and<br>Peat-Earth                         | Sandy        | 20 to 30                                       | With or without | " 5.0      | "     |   |
|  |   | Without      | 20 to 30                                       | Lime.           | " 5.0      | "     |   |

The fertility of soils from the chemical point of view depends mainly on the presence in sufficient quantities of four essential constituents of plant-food, *viz.*, nitrogen, phosphoric acid, potash and lime. In fact, lime and potash being almost invariably present in sufficient quantities, the excess or deficiency of nitrogen and phosphoric acid is mainly looked to in judging of the chemical character of soils. If a soil contains .1 to .5 per cent. of nitrogen and .08 to .5 of phosphoric acid, it may be classed as a good soil. Soils containing 1 per cent. of potash or lime (the latter not as insoluble silicate but as carbonate) are to be considered quite rich in these substances. A sample of dry soil showing .1 per cent. of nitrogen phosphoric acid and potash would yield out of a depth of nine inches, two to three thousand pounds of each of these constituents per acre; but no crop ordinarily takes up more than fifty to sixty pounds per acre of these substances. So that, properly tilled, a soil even left without manure would raise hundreds of crops. A soil containing .2 per cent. of nitrogen (calculated as ammonia), .2 per cent. of phosphoric acid and .5 per cent. of potash, and weighing when perfectly dry 1,600,000lbs. per acre to a depth of five inches, is capable of affording 3,200lbs. of nitrogen (calculated as ammonia), 3,200lbs. of phosphoric acid and 8,000lbs. of potash. A good crop of twenty maunds of wheat and thirty maunds of wheat-straw per acre would not require more than 40lbs. of nitrogen, 20lbs. of phosphoric acid and 26lbs. of potash. The object of manuring is to give a larger quantity of really available plant-food to growing crops and to help in dissolving the plant-food of the soil, and thus augmenting its quantity. A judiciously manured soil, also forest and pasture land, may go on getting more and more fertile. So few pounds of the chemical constituents of manures are taken up ordinarily by crops, that it is easy to more than recoup these by the use of proper manures. To ascertain, however, whether a particular soil needs the addition of any one of these constituents, whether nitrogen, phosphoric acid, potash or lime in the form of manure, or if it is already sufficiently rich in this or that constituent, and it will be superfluous to use one or another of the manures, it is not absolutely necessary to have recourse to chemical analysis. A ten-plot experiment may be made after Ville's method to understand the chemical character of a particular soil. There should be ten equal plots manured in the following way:—

No. 1. Sodium nitrate ( $\text{Na NO}_3$ ), 220lbs. or Ammonium Chloride ( $\text{NH}_4 \text{Cl}$ ), 140lbs., *i.e.*, the quantity containing 36lbs. of nitrogen, should be applied per acre.

No. 2. Unmanured plot.

No. 3. Sodium phosphate ( $\text{Na HPO}_4$ ), 44lbs., *i.e.*, the quantity containing 22lbs. of phosphoric acid should be applied per acre.

No. 4. Unmanured plot.

No. 5. Quick-lime (CaO), 40lbs. should be applied per acre after slaking.

No. 6. Unmanured plot.

No. 7. Potassium Chloride (KCl), 50lbs., *i.e.*, the quantity equivalent to 32lbs. of potash should be applied per acre.

No. 8. Unmanured plot.

Nos. 9 and 10 unmanured plots.

The plots need not be more than a few yards in length and width. They should be sown very thin with a mixed crop of gram and maize or some other cereal and pulse crop together. The effect of lime and potash will be manifest on the pulse crop and that of nitrogen and phosphoric acid and also potash on the cereal crop. The same quality and the same number of seeds should be sown in each plot at similar distances and the same treatment given to all. The crops must be protected from parasites and pests, from drought and from water-logging. The rainy season should be avoided for this experiment, and fast-growing crops, that take only three or four months to mature, chosen. The weight of grain and straw of the cereal and also of the leguminous crop should be noted. Such experiments are more usually conducted now in pots than in the field to secure accuracy at all seasons. If the plot which has received nitrate of soda shows special increase in the case of the cereal but not so in the case of the pulse crop, the soil should be considered rather poor in nitrogen, especially if the yield of the cereal in the unmanured plots is found to be invariably less than that of the plot manured with nitrate of soda.

If the sodium phosphate does not show any benefit, the soil should be considered only poor in nitrogen, especially if the yield of the cereal in the unmanured plots is found to be invariably less than that of the plot manured with nitrate of soda.

If the sodium phosphate does not show any benefit, the soil should be considered rich in phosphates.

If the plot manured with lime shows better yield, especially in the case of the pulse crop as compared to the yield from unmanured plots, the land should be considered deficient in lime.

If the potassium-chloride plot shows no benefit in either case, the land should be considered rich in potash.

If the cereal is benefited chiefly in the weight of the straw by the nitrate of soda, the soil should be considered poor in nitrogen. If the sodium phosphate plot shows better yield of grain, the soil should be considered wanting in phosphoric acid.

The object of having buffer plots without manure, is to keep the effects of the different manures quite distinct. The plots should be protected from heavy rain or the experiment conducted in the *rabi* season, lest there should be overflowing from one plot to the

other. Watering should be done gently and care should be taken that there is no mixing up of soils, weeds, and crops of different lots. This ten-plot experiment is recommended for practical purposes in judging of the chemical value of soils. It will not give absolutely correct ideas as to the potentiality of a soil, but it will give a very fair idea of the available plant-foods. If the plots are quite detached, one unmanured plot will be found sufficient, and in that case it will be a five-plot experiment. As experiments should be always conducted in duplicate, two such series of five-plot will also make a ten-plot experiment. If none of the applications prove of any use, *i.e.*, if the yield of the cereal and of the pulse crop are about the same in all the manured and unmanured plots, the soil must be considered extremely rich in all available plant-foods; and if notwithstanding all these applications one does not get any yield or only a very poor yield of pulses and cereals, the soil should be considered barren or very nearly so, that is containing (1) an excess of some salt, or (2) deficiency of some essential constituent, or (3) some poisonous substance.

Another method of carrying out this experiment is to apply a mixture of all the four manures to one plot, the same without lime to the next, the same without potash to a third, the same without phosphoric acid to a fourth, and the same without nitrogen to a fifth. This is called Ville's Five-Plot Experiment. There should, however, be unmanured plots for comparison, and the more the number of such plots, the more accurate is the check. Pot-culture experiments have given very useful results in Japan, as the conditions that are desired can be more readily controlled in pots than in fields.

## CHAPTER VI.

### CHEMICAL CLASSIFICATION OF INDIAN SOILS.

[Chemical composition of (1) Indo-Gangetic alluvium, of (2) Black cotton-soil, or (3) Red soils, of (4) Laterite soils, of (5) Deccan alluvial tracts, of (6) Dharwar soil; Peculiarities of Indian soils with reference to Iron, Manganese, Lime, Magnesia, Potash, Phosphoric acid, Sulphuric acid, Carbonic acid, and Nitrogen; available Phosphoric acid in Indian soils, high; Indian soils poor except in special localities.]

“THE four main types of soil,” says Dr. Leather, “which occupy by far the greater part of the Indian cultivated area, are (1) the Indo-Gangetic alluvium, (2) the black cotton-soil or *regur*, (3) the red soils lying on the metamorphic rocks of Madras, and (4) the laterite soils which are met with in many parts of India.” In addition to these we might mention (5) Stretches of alluvium which are situated at the mouths of the Mahanadi, Godaveri, and other rivers, which bear no comparison to the Indo-Gangetic alluvium. (6) The soil covering the Dharwar rocks which is also quite different from the red soils of the metamorphic rocks of the Madras



Presidency. Soils of other kinds also occur in smaller patches, but the main types of Indian soils are four alluvium, *regur*, the Madras red soils, and those popularly called laterite. The composition of the last two classes of soil varies very much.

**Alluvium.**—The soils of the Indo-Gangetic alluvium are generally of fine texture, containing no pebbles, and the only particles larger than sand to be met with in the alluvium consist of *kankar*, deposited within a few feet of the surface. The character varies within certain limits. In most places the alluvium is yellow loam. In some places it is sandy, and in others clayey. The clay is generally bluish grey. Occasionally also sand dunes or hills have been formed by the wind.

The following tables furnish the analyses by Dr. Leathe of the principal Indo-Gangetic alluvium soils:—

*I. Sandy soil from Ison sand belt near Cawnpore:—*

|  |       |    | Per<br>cent. |
|--|-------|----|--------------|
| Insoluble Silicates and Sand                     | ..    | .. | 91·72        |
| Oxide of Iron                                    | .. .. | .. | 2·36         |
| Alumina  | .. .. | .. | 2·92         |
| Lime   | .. .. | .. | ·35          |
| Magnesia   | .. .. | .. | ·78          |
| Potash   | .. .. | .. | ·33          |
| Soda   | .. .. | .. | ·08          |
| Phosphoric acid (P <sub>2</sub> O <sub>5</sub> ) | .. .. | .. | ·08          |
| Sulphuric acid (SO <sub>3</sub> )                | .. .. | .. | ·04          |
| Carbonic acid (CO <sub>2</sub> )                 | .. .. | .. | ·27          |
| * Organic matter and combined water              |       | .. | 1·07         |
|  |       |    | 100·00       |

\* Containing ·027 per cent. of Nitrogen.

*II. Sandy loams:—*

|                              | From Ison<br>Doab. | Ganges       | From Burdwan<br>Experimental<br>Farm. |
|------------------------------|--------------------|--------------|---------------------------------------|
|                              |                    | Per<br>cent. | Per<br>cent.                          |
| Insoluble Silicates and Sand |                    | 88·08        | 84·31                                 |
| Oxide of Iron                | ..                 | 3·10         | 5·58                                  |
| Alumina                      | ..                 | 4·38         | 6·09                                  |
| Oxide of Manganese           |                    | <i>Nil</i>   | ·12                                   |
| Lime                         | ..                 | ·47          | ·28                                   |

II. *Sandy loams* (concl'd.) :—

|  | From Ison<br>Doab. | Ganges       | From Burdwan<br>Experimental<br>Farm. |
|--|--------------------|--------------|---------------------------------------|
|  |                    | Per<br>cent. | Per<br>cent.                          |
| Magnesia ..                                      |                    | ·32          | ·66                                   |
| Potash ..  |                    | ·64          | } ·56                                 |
| Soda ..  |                    | ·09          |                                       |
| Phosphoric acid (P <sub>2</sub> O <sub>5</sub> ) |                    | ·08          | ·04                                   |
| Sulphuric acid (SO <sub>3</sub> ) ..             |                    | ·05          | ·02                                   |
| Carbonic acid (CO <sub>2</sub> )                 |                    | ·37          | ·21                                   |
| Organic matter and combined<br>water             |                    | * 2·42       | † 2·13                                |
|  |                    | 100·00       | 100·00                                |

\* Containing Nitrogen = ·081 per cent.

† Containing Nitrogen = ·042 per cent.

III. *Loamy soils* :—

|   | Cawnpore.    | Patna.       | Dumraon<br>Exper-<br>imental<br>Farm. |
|---|--------------|--------------|---------------------------------------|
|   | Per<br>cent. | Per<br>cent. | Per<br>cent.                          |
| Insoluble Silicates and Sand ..                     | 84·84        | 82·96        | 86·82                                 |
| Oxide of Iron ..                                    | 4·52         | 4·59         | 4·09                                  |
| Alumina ..  | 5·30         | 5·11         | 4·57                                  |
| Oxide of Manganese ..                               | <i>Nil</i>   | ·11          | ·10                                   |
| Lime ..   | ·91          | 1·78         | ·30                                   |
| Magnesia ..   | ·52          | 1·53         | ·76                                   |
| Potash ..   | ·16          | ·66          | } ·48                                 |
| Soda ..   | ·03          | ·30          |                                       |
| Phosphoric acid (P <sub>2</sub> O <sub>3</sub> ) .. | ·10          | ·13          | ·08                                   |
| Sulphuric acid (SO <sub>3</sub> ) ..                | Trace        | Trace        | Trace                                 |
| Carbonic acid (CO <sub>2</sub> ) ..                 | ·71          | 1·10         | ·01                                   |
| * Organic matter and combined<br>water ..           | 2·91         | 1·73         | 2·79                                  |
|   | 100·00       | 100·00       | 100·00                                |

\* Containing Nitrogen = ·046 per cent. ·045 per cent. ·049 per cent.

IV. *Clay loams* :—

|   | Bahr,<br>Patna. | Dumraon<br>Farm. | Sibpur<br>Farm. |
|---|-----------------|------------------|-----------------|
|   | Per<br>cent.    | Per<br>cent.     | Per<br>cent.    |
| Insoluble Silicates and Sand ..           | 72·64           | 80·90            | 73·58           |
| Oxide of Iron ..                          | 7·58            | 6·12             | 6·36            |
| Alumina ..                                | 9·89            | 6·50             | 7·93            |
| Oxide of Manganese ..                     | ·14             | ·14              | ·11             |
| Lime ..                                   | 1·01            | 2·07             | 1·52            |
| Magnesia ..                               | 1·64            | 1·17             | 1·61            |
| Potash ..                                 | ·82             | ·73              | ·64             |
| Soda ..                                   |                 |                  |                 |
| Phosphoric acid ..                        | ·07             | ·08              | ·11             |
| Sulphuric acid ..                         | Trace           | Trace            | ·03             |
| Carbonic acid ..                          | ·28             | ·05              | 1·35            |
| * Organic matter and combined<br>water .. | 5·93            | 2·24             | 6·76            |
|   | 100·00          | 100·00           | 100·00          |

\* Containing Nitrogen = ·051 per cent. ·041 per cent. ·065 per cent.

Two other samples of Sibpur Farm Soil analysed by Dr. Leather gave the following result :—

|   | Per<br>cent. | Per<br>cent. |
|---|--------------|--------------|
| Insoluble Silicates and Sand ..               | 78·95        | 72·88        |
| Soluble Silicates ..                          | ·03          | ·28          |
| Oxide of Iron ( $\text{Fe}_2\text{O}_3$ ) ..  | 4·73         | 6·28         |
| Alumina ( $\text{Al}_2\text{O}_3$ ) ..        | 4·47         | 7·96         |
| Oxide of Manganese ( $\text{MnO}$ ) ..        | ·11          | ·12          |
| Lime ( $\text{CaO}$ ) ..                      | 2·07         | 2·03         |
| Magnesia ( $\text{MgO}$ ) ..                  | 2·00         | 2·14         |
| Alkalis (soda and potash) ..                  | ·08          | 1·79         |
| Sulphuric acid ( $\text{SO}_3$ ) ..           | Trace        | Trace        |
| Phosphoric acid ( $\text{P}_2\text{O}_5$ ) .. | ·11          | ·12          |
| Carbonic acid ( $\text{CO}_2$ ) ..            | 3·82         | 3·95         |
| Organic matter and combined water ..          | 3·63         | 2·45         |
|   | 100·00       | 100·00       |
| Nitrogen (Total) ..                           | ·063         | ·065         |

The above three analyses give some idea of the variability of composition of the soil of Sibpur Farm, chiefly in lime and the alkalis.

V. *Calcareous soil from Pratapgarh (Oudh) :—*

|                                     |    |    | Per<br>cent. |
|-------------------------------------|----|----|--------------|
| Insoluble Silicates and Sand        | .. | .. | 57.52        |
| Oxide of Iron                       | .. | .. | 3.23         |
| Alumina                             | .. | .. | 3.39         |
| Oxide of Manganese                  | .. | .. | <i>Nil</i>   |
| Lime                                | .. | .. | 14.54        |
| Magnesia                            | .. | .. | 1.86         |
| Potash                              | .. | .. | .44          |
| Soda                                | .. | .. | .02          |
| Phosphoric acid                     | .. | .. | .18          |
| Sulphuric acid                      | .. | .. | .08          |
| Carbonic acid                       | .. | .. | 11.42        |
| * Organic matter and combined water | .. | .. | 7.32         |
|                                     |    |    | 100.00       |

\* Containing Nitrogen=.18 per cent.

Though calcareous soils are rare in India, beds of *kankar* commonly underlie the Indo-Gangetic alluvium, the black cotton-soil and other soils. The surface-soil of the alluvium is usually free from *kankar*, except where there is an outcrop of the bed of *kankar*. In the old alluvium and in the black cotton-soil, the *kankar* occurs in beds as well as mixed up with the soil. Some of the *regur* soils contain as much as 10 per cent. of calcium carbonate. *Kankar* often occurs on the surface of the rocky soils in many parts of the Santhal Parganas in such profusion that cart-loads of lumps of *kankar* are collected for six annas each. The soil of the Sibpur Farm is rich in calcium carbonate (about 2 per cent.). The amount of phosphoric acid also in Indo-Gangetic alluvial soils is usually more than in other Indian soils. The amount of potash in the samples examined is sufficient. The amount of nitrogen and organic matter in soils from the Indo-Gangetic alluvium is usually low. The amount of oxide of iron and alumina in the Indo-Gangetic alluvium is usually higher than in European loams and clays. The sandy soils contain about 2½ per cent. of these. The proportion is higher in loams, while in clays it is from 6 to 8 per cent. Sulphates are practically absent from the *regur*, the red-soils of Madras and the laterite soils, but alluvial soils sometimes contain a small amount.

**Regur.**—We next come to the black cotton-soils or *regurs*. Their composition is not very variable in *soluble silicates and sand* (65 to 75 per cent.). The amount of oxide of iron usually ranges from 5 to 9 per cent., while the amount of alumina is usually a little greater. Madras *regur* soils contain more alumina than iron, that from the Central Provinces more iron than alumina. *Manganese* is always present in small amount. Lime occurs in all these soils as calcium carbonate and calcium silicate. Where there is more than a small quantity present, calcium carbonate usually predominates. *Regurs* usually contain from 2 to 5 per cent. of lime. The potash is present in usually high amount in *regur* soils. The phosphoric acid is usually present in only small quantity, not more than 1 per cent. is the rule. *Regurs* are poor in nitrogen like most other Indian soils. "Organic matter and combined water" occur in very high proportion, but it is chiefly combined water and not organic matter. In heating, the *regur* changes colour from black to dark-brown and contracts very much in volume. This is due to the loss of the water of hydration from hydrated ferric oxide and alumina, in which substances the *regur* is specially rich. The *regur* is rather poor in organic matter and nitrogen, and its richness is chiefly due to its friability and its power of retaining moisture. Indeed the outturn of crops from unmanured land at the Nagpur Farm is lower than from similar loamy soil in the Gangetic alluvium. At any rate, it is Dr. Leather's opinion, that it is a common mistake to suppose that the black cotton-soil of Southern India is very rich, and it is only richer than the surrounding gravelly red and brown soils. If *regur* be boiled with concentrated sulphuric acid for several hours, the insoluble residue (*i.e.*, the silicates) becomes very dark-brown in colour. Other soils similarly treated usually give a white residue. The black colouring matter of the silicates digested with strong sulphuric acid, if due to organic matter, would disappear under this treatment, and it must be concluded that the blackness of the silicates in *regur* is due to some dark-coloured mineral and not to organic matter. This has now been shown to be largely magnetic oxide of iron.

**Brown alluvial soils of Madras.**—These soils which have been separately classed by Dr. Leather, the loamy ones contain high proportions of iron and alumina, the amount of lime is small and the amount of magnesia high. They are, as a rule, rich in potash but not in phosphoric acid and nitrogen. These are believed to be very fertile soils, but the analyses do not show them to be any more fertile than the Indo-Gangetic alluvium.

**Rocky Soils.**—With these and with alluvium soils we have chiefly to do in Bengal, and we give below the figures of Dr. Leather in connection with the analyses of some of the rocky soils of Hazaribagh, Lohardaga, Singhbhum and Manbhum. Most of these soils are gneissose and granitic soils, including basaltic soils. True

Table showing the composition of Rocky Soils of Bengal.

|                                   | HAZARIBAGH.   |        |          |        | RANCHI.       |          | SINGBHM.      | MANBHM.                       |        |        |        |
|-----------------------------------|---------------|--------|----------|--------|---------------|----------|---------------|-------------------------------|--------|--------|--------|
|                                   | Surface soil. |        | Subsoil. |        | Surface soil. | Subsoil. | Surface soil. | Surface soil overlying rocks. |        |        |        |
|                                   | A             | B      | A        | B      |               |          |               |                               |        |        |        |
| Insoluble Silicates and Sand      | 78.62         | 80.46  | 74.84    | 76.96  | 79.67         | 63.30    | 60.78         | 85.50                         | 90.29  | 90.34  |        |
| Oxide of Iron                     | 6.35          | 6.12   | 6.96     | 6.40   | 8.71          | 12.08    | 24.92         | 4.27                          | 5.68   | 3.17   |        |
| Alumina                           | 8.98          | 7.19   | 11.57    | 11.31  | 8.81          | 13.89    | 7.27          | 2.59                          | 4.00   | 2.95   |        |
| Oxide of Manganese                | .39           | .50    | .23      | .33    | .07           | .06      | .48           | .09                           | .11    | .09    | .06    |
| Lime                              | 1.50          | 1.72   | .96      | .94    | .38           | .45      | .28           | .14                           | .47    | .14    | .38    |
| Magnesia                          | .66           | .38    | .81      | .51    | .21           | .20      | .33           | .31                           | .60    | .28    | .36    |
| Potash                            | .43           | .38    | {        | .44    | .10           | .27      | .27           | .14                           | .40    | .19    | .25    |
| Soda                              | .21           | .32    |          |        | .04           |          |               |                               |        |        |        |
| Phosphoric Acid                   | Trace         | Trace  | Trace    | .04    | .64           | .62      | .08           | .13                           | .30    | .04    | .06    |
| Sulphuric Acid                    | Do.           | Do.    | Do.      | Trace  | Trace         | Trace    | Trace         | Trace                         | Trace  | Trace  | Trace  |
| Carbonic Acid                     | .12           | .12    | .08      | .05    | .06           | .12      | .16           | .28                           | .06    | .05    | .38    |
| Organic matter and combined water | 2.74          | 2.81   | 3.80     | 3.02   | 1.31          | 9.01     | 5.43          | 1.98                          | 2.88   | 1.53   | 2.05   |
|                                   | 100.00        | 100.00 | 100.00   | 100.00 | 100.00        | 100.00   | 100.00        | 100.00                        | 100.00 | 100.00 | 100.00 |
| Nitrogen                          | .039          | .030   | .023     | .026   | .010          | .010     | .024          | .016                          | .032   | .031   | .036   |

laterite occurs in a band and in patches; and where it is too stiff and ferruginous, it is barren for ordinary agricultural crops.

**The Red Soils of Madras.**—The amount of lime in these is small or only moderate that of magnesia also is not high, while that of phosphoric acid is uniformly low. The proportion of potash is indifferently high or low, that of ferric oxide and alumina rather high. The proportion of nitrogen and of organic matter is low. They resemble the rocky soils in composition the main difference being in the proportion of phosphoric acid. Some of the rocky soils have a high proportion of this constituent, and others very low, whilst the Madras red soils of Coimbatore, Madura, Karnool, Trichinopoly and Kistna are all uniformly poor in this constituent, the extreme variation in the samples analysed by Dr. Leather being between .04 and .11 per cent.

**General remarks about Indian Soils.**—*Iron* usually occurs in larger proportion than in English soils—in the Indo-Gangetic alluvium 2 to 7 per cent., in the *regur* 4 to 11 per cent., in the Madras red soils  $3\frac{1}{2}$  to 10 per cent., and in Madras alluvium 5 to 17 per cent. The proportion of alumina is also high in Indian soils. In the Indo-Gangetic alluvium 3 to 10 per cent., *regurs* 6 to 14 per cent., red soils  $1\frac{1}{2}$  to 15 per cent., rocky soils  $7\frac{1}{2}$  to 15 per cent., Madras alluvium 6 to 15 per cent., in loams, but less in sandy soils. Coffee soils of the Madras Presidency contain as much as 17 to 20 per cent. of this constituent.

Lime occurs more usually as silicate than as carbonate. Calculated as oxide, the figures run as follows:—Gangetic alluvium, 2 to 3 per cent., *regur* 1 to 8 per cent., Madras red soils, laterites and Madras alluvium less than 1 per cent.

An English farmer usually aims at maintaining a fair proportion of lime in his soil, say about 1 per cent. This is for the purpose of having free basic matter to combine with the organic acids as soon as they are formed from the humus,—and they are continuously being formed. The proportion of humus, however, in English soils is higher, and so it is doubtful if those Indian soils which contain less than 1 per cent. of lime really need to be brought up to the standard aimed at by English farmers. Lime as a plant-food is required only in a very minute proportion. The laterite soils which are particularly poor in organic matter are also poor in lime. They would not be benefited by any addition of lime alone. On the whole, it may be said Indian soils are rich in lime.

The potash is not usually deficient in Indian soils, though it can hardly be considered as specially abundant. Its application as manure would be often beneficial.

Phosphoric acid occurs normally in smaller amount in Indian soils than is customary in those of Western Europe. Of no class of Indian soils examined except the soils from Meerut district and the coffee soils of Shevaroy Hills, Madras, can it be said that it comes up to the English standard. Dr. Leather is obliged to admit that Dr. Voelcker's opinion that phosphoric acid is "more abundantly distributed in Indian than in English soils" is erroneous. Some of the soils of the Meerut district only analysed by Dr. Leather contains as much as .5 per cent. of phosphoric acid.

But although the proportion of total phosphoric acid in Indian soils is decidedly meagre, the proportion of *available* phosphoric acid is often not deficient, and it is the available phosphoric acid that immediately affects the question of fertility or of produce. The application of bone-meal has given the best results in Bankura and Burdwan, and not such a good result in Hooghly and Birbhum, applied to the paddy crop in conjunction with saltpetre. In some instances a remarkably good result was obtained from this combination, though not from saltpetre alone. This shows the value of phosphates for certain localities, but where these localities are, must be determined in each case by chemical analysis or field experiment. It is a great mistake to suppose that phosphates have only a doubtful value for Indian soils and that the export of bones can go on with impunity. Dr. Bernard Dyer, of London, has discovered an empirical method of finding out the available phosphoric acid and potash in soils. This consists in submitting soils to the action of a 1 per cent. solution of citric acid for seven days and determining the proportion of phosphoric acid and potash in the solution. Dr. Dyer aimed at demonstrating whether the results of such treatment would correspond with the known fertility of some of the standard soils of the Rothamsted experimental farm. The result of the research showed conclusively that a very close correspondence exists between the amount of phosphates and potash thus dissolved from the soils and their known fertility in the matter of phosphates and potash. Dr. Dyer concluded from his research that "when a soil is found to contain as little as about .01 per cent. of phosphoric acid soluble in a 1 per cent. solution of citric acid, it would be justifiable to assume that it stands in immediate need of phosphatic manure." Dr. Leather applying Dr. Dyer's method in a few cases showed that even in typical alluvial and *regur* soils the proportion of available phosphates is usually over .01 per cent. In two cases he found the proportion less than this. The soils of the Cawnpore, Dumraon and Nagpur experimental farms contain .05 to .09 per cent. of total phosphoric acid, but soil from only one plot in the case of the Nagpur and one plot in the case of Dumraon farm showed the proportion of available phosphates to be less than .01 per cent. About one-third or one-fourth of the total phosphates is usually in an available form in Indian soils, while in English unmanured soils the proportion of



available phosphates is about one-sixteenth and in manured soils higher,—about one-fourth.

Like phosphoric acid, when sulphuric acid is present in a soil, it always exists in combination with some one or other of the metallic oxides, with which it forms sulphates. The majority of Indian soils contain remarkably little sulphate,—in no case as much as 1 per cent. An exception occurs in the case of *usar* soils which are impregnated with sodium sulphate and sodium carbonate.

**Carbonic Acid.**—The determination of this is not of much consequence. It usually exists in proportions not sufficient to combine with the lime present, and it may therefore be assumed that the carbonic acid is present wholly or mainly in combination with lime

**Organic matter and nitrogen.**—As a rule, Indian soils contain little organic matter. The loss by heating is often due chiefly to loss of combined water, and a knowledge of the loss by combustion of a soil does not serve as means of even approximately determining the amount of that most valuable constituent,—humus. The loss by combustion occurs chiefly where the proportions of iron and alumina are great. The coffee soils of Shevaroy are rich in nitrogen and so are some soils of Pratapgarh. Speaking generally, Indian soils contain less than .1 per cent. of nitrogen. The Gangetic alluvium contains only about .05 per cent. In the Madras alluvium the proportion is the same or a little higher. The *regurs* and red soils usually contain less than .05 per cent. Laterite and other rocky soils contain only about .03 per cent. But soils that have had the opportunity of accumulating nitrogen, whether in old fallows or in forests, contain a higher proportion.

The reputed fertility of Indian soils is more a myth than a reality. Where the soil has been in cultivation for many years, the virgin richness has disappeared, except where it is irrigated by canals (*e.g.*, the Eden canal), bringing rich deposits of silt, or annually flooded by rivers leaving such deposits (*e.g.*, in Eastern Bengal). As a rule, Indian soils yield poor crops.

## CHAPTER VII.

### PHYSICAL PROPERTIES OF SOILS.

[Weight, Porosity, Retentivity for water, Capillarity, Hygroscopicity, Evaporation, Coagulation of soil-particles, Shrinkage and Expansion. Colour, Temperature, Specific heat, Radiation, Absorption and Retention of Heat, Evenness of temperature, Inclination, Electric influences, Elevation, Latitude and Longitude.]

**Weight.**—The specific gravity of soil as it naturally occurs, *i.e.*, the weight of natural soil as compared to that of distilled water varies from 1 to 2. Some peat-soils have less specific gravity

than 1. The floating vegetable gardens of Kashmir consist of light peat-soil of this kind. The absolute weight of soils varies from 50 to 120lbs. per cubic foot, a cubic foot of distilled water weighing 62·5lbs. A cubic foot of rich garden-mould weighs about 70lbs.; of ordinary arable land 80 to 90lbs.; of dry sand 110lbs. The weight of an acre of soil to the depth of one foot varies from one to five million pounds; of dry sand about 4,800,000lbs.; of loam consisting of half clay and half sand, 4,200,000lbs.; of ordinary arable soil 3,800,000 to 3,900,000lbs.; of stiff clay, 3,250,000lbs.; of garden-mould, 3,000 000lbs. An acre of peat to the depth of one foot weighs from one to two million pounds. A soil when perfectly dry was found to weigh 3,137,000lbs. The same soil when wet was found to weigh 4,000,000lbs. It should be remembered that one inch of rainfall increases the weight of an acre of soil to a depth of one foot by about one hundred tons (224,000lbs.). In agricultural language, a soil is said to be heavy which offers considerable resistance to the plough. Sandy soils which actually weigh heavier than other soils are called *light soils* because they offer least resistance to the plough. A stiff clay soil which is said to be very heavy becomes lighter, *i.e.*, less resistant to the plough, after there is a shower of rain, though the rain actually adds to the weight of the soil. The specific gravity of soils, not as they actually occur but of the materials of which they are composed varies from 2·5 to 2·8. The specific gravity of soils very rich in organic matter is sometimes less than 2. The specific gravity of quartz is 2·65.

**Porosity.**—The fineness of division of the particles of soil has great influence on vegetation. Food of plants must pass into solution before it can be assimilated. The rapidity with which this dissolving action can take place is in direct ratio to the surface. The finer the particles, the greater the surface and more the space the growing roots have for their development and spread. But when the particles are too fine, the soil becomes too compact for roots to penetrate, and it cracks in drying, which also interferes with the spread of roots. Up to a certain limit, therefore, fineness of division of the particles of soil is desirable. The condition known as loamy is the best in respect of porosity.

**Retention of water.**—This capacity of soils depends mainly on the fineness of division of their particles. Humus or vegetable organic matter in the soil has the greatest capacity for retaining moisture, and clay has a greater capacity in this respect than sand. Angular fragments have greater capacity than round fragments for retaining moisture. 100 parts of sand take up about 25 parts of water by weight and 49 parts by volume; clay 40 parts by weight and 68 by volume; fine calcareous soil, 85 by weight and 80 by volume; humus, 190 by weight and 93 by volume. Ordinary agricultural soil takes up about 50 per cent. by weight of water. It will thus be seen that an inch of irrigation or rainfall

at a time soaks it to a depth of about two inches, and provision in the matter of irrigation should be ordinarily made on this basis. Heat decreases this capacity for holding water. The porosity of soil though depending mainly on the fineness of its particles, also depends on looseness or fineness of filth. Loose agricultural soils can hold 59 per cent. of water, while the same soil shaken down will hold only 45 per cent. and pressed down, only 40 per cent.

**Capillarity.**—The capillary power of soils for drawing water up from below depends on their porosity : clay possesses the greatest capillarity and sand and chalk the least. A column of fine clay wetted from the bottom will become wet to a height of one to two yards. Quartz-sand similarly wetted becomes wet to a height of only half a yard, and chalky and calcareous soil (*i.e.*, soil, made up of particles of pure calcium carbonate) to a still less height. The capillary action of soils in lump is less than that of the same soils when finely powdered or broken down. This is one of the many reasons why cultivation benefits crops. Capillary action takes three or four days before it reaches its final limit. Capillarity is disturbed by digging up the surface-soil, or spreading on irrigated soils, dry earth. The retention of moisture under trees, or in sugarcane trenches, is thus helped by digging round the trees in November, and in earthing up sugarcane trenches with dry earth after irrigation. Loss of water raised by capillarity, by evaporation, is thus avoided.

**Hygroscopic power.**—All porous bodies have the power of absorbing moisture from the atmosphere. The proportion of moisture absorbed depends (1) upon the surface exposed, and (2) on the nature of the substance. Organic substances, as a rule, are more hygroscopic than mineral substances. Wool, silk and hair are highly hygroscopic. Wool absorbs 19 to 20 per cent. of moisture from air at the freezing temperature. In buying and selling, this must be borne in mind. Silk may contain 9 or 10 per cent. of latent moisture over and above the 11 per cent. of normal moisture, without one noticing it. In buying 100 maunds of silk it is quite possible to throw away Rs. 7,000 or Rs. 8,000 in buying superfluous water. Dry seasons should be chosen for buying these substances. Manuring soils with refuse from wool or silk factories or with hair, increases their absorbent power for moisture. Absorbent power varies very considerably in soils. Coarse quartz-sand absorbs little or no water from air, calcareous sand very little ; ordinary arable, clay and humus soils, more and more. Calcareous sand finely powdered absorbs twelve times as much aqueous vapour as in the coarse state. The rapidity of absorption depends upon the proportion of moisture present in the air ; but the total amount of water absorbed mainly depends on temperature, more being absorbed at a low than at a high temperature. Hence the necessity of desiccating the soil at a uniformly high temperature for purposes of analysis. Sowing 01

seed for *rabi* crops should be done in the evening after which the land should be harrowed and left in an open state for absorption of dew. In the morning rolling or laddering should be done so as to keep in the moisture absorbed at night.

**Evaporation.**—Soils becoming superficially dry in the day time absorb moisture at night. All soils exposed to air lose their moisture more or less rapidly—sandy soils most rapidly, clay less rapidly, and humus soils least rapidly. Exposed to a dry atmosphere at 19°C. for four hours in an experiment—

|                     |    |    |           |              |
|---------------------|----|----|-----------|--------------|
| Siliceous soil lost | .. | 88 | per cent. | of moisture. |
| Calcareous sand     | .. | 76 | „         | „            |
| Pure clay           | .. | 52 | „         | „            |
| Clay-soil           | .. | 35 | „         | „            |
| Chalk               | .. | 28 | „         | „            |
| Garden soil         | .. | 24 | „         | „            |
| Humus or peaty soil | .. | 20 | „         | „            |

**Coagulation.**—In fresh water, clay remains in suspension for a very long time, but in salt water it gets coagulated and deposited at the bottom. Hence formation of soils in the sea is facilitated. The addition of common salt or gypsum or of any soluble salt to a mixture of clay and fresh water, would demonstrate the action the sea has in the formation of clay-soils. The application of certain manures, such as castor-cake or gypsum, to clay-soils, is known to make it more friable. The use of gypsum in making plastic *usar* soils porous has been demonstrated.

**Shrinkage and expansion.**—Pure clay contracts 18 per cent. in volume when it becomes wet, and strong clay-soils may contract 8 to 10 per cent. Light sandy soils with little humus undergo little or no change in volume when wet. Humus soils expand up to 15 per cent. when wet, and more in frost. Clay-soil also expands in frost. This expansion often causes rupture of roots of crops growing on these soils. Clay-soils, in drying, crack. These cracks also damage the roots of growing crops.

**Colour.**—The colour of the soil somewhat affects its temperature. Dark-coloured bodies being more quickly heated than light-coloured bodies, humus soils and dark basalt soils are warmer than limestone soils and sandy soils. If dark-coloured shales are sprinkled over vineyards in cold countries, ripening takes place quicker. Smooth and white substances sprinkled over dark-coloured soil would keep such soil comparatively cool. As we are more interested in keeping soils cool rather than warm, we might try the effect of scattering white chips of stone or chalk on dark-coloured soils. For practical purposes the question of colour is not of much importance in a country where coolness is best secured by moisture which most soils are in need of, at certain critical

periods. The question of temperature of the soil, however, is of great importance.

**Temperature.**—The mean temperature of the surface soils differs in different climates, but even in the same locality some soils are recognised as *cold* and others as *warm*. The heat of the soil is derived from three sources and it is distinguished accordingly as solar heat, terrestrial heat, and chemical heat. The chemical heat derived from decaying organic matter, especially in porous soils, is very considerable; but as this heat is evolved very slowly, it has little perceptible effect on plant-life. Owing to the internal heat of the earth, there is very little change of temperature due to surface radiation, between day and night, below a depth of four feet from the surface in warm countries. In cold countries, below a depth of seventy-five to eighty feet the temperature is constant, *i.e.*, not affected by radiation at night, and solar heat by day. The mean annual temperature of the surface soil is slightly over that of the air; but moist clay-soils are colder than the atmosphere above them, as the continual evaporation going on from them continually lowers the temperature. Water ascending by capillary action from the subsoil and taking the place of that evaporated from the surface soil, keeps the surface soil always cold.

**Specific heat.**—The less the specific heat of the soil, the more rapidly is it heated. The specific heat of soils compared to that of water varies from  $\cdot 2$  to  $\cdot 5$  for equal volumes and from  $\cdot 16$  to  $\cdot 3$  for equal weights. Sand has a greater specific heat than clay. The actual capacity of soil for heat, however, is largely dependent on its capacity for water as water has four or five times the specific heat of soils. Quartz-sand becomes heated to the highest temperature and white chalk-soil to the lowest temperature under the same solar influence. The coolness of lime-soils is therefore of great advantage in warm climates, and the advantage of *kankar* beds can be viewed from this point also. Moist clay-soils which are considered very objectionable from the temperature point of view in cold countries should, from the same point of view, be looked upon as highly advantageous for this climate.

**Radiation.**—Radiation also affects temperature. Smooth and polished surfaces, which reflect heat most perfectly, absorb and radiate it least readily. The radiation from moist soils at night is less quick, but, on the whole, such soils are colder and are called "cold soils." Nocturnal radiation results in quicker formation of dew in the interstices of soils where water vapour accumulates in larger proportions than in the air.

**Retention of heat.**—Quick or slow cooling depends partly on specific heat but chiefly on fineness or largeness of particles of the soil, finely divided particles cooling more readily. Soils covered with gravels, cool more slowly than sandy soils. Sandy soils also retain heat longer than clay-soils and these longer than humus

soils. Water being a bad conductor of heat, wet soils differ little from one another, in the absorption and retention of heat. A wet plot may be as much as 7°C. higher in temperature early in the morning or 7°C. lower in temperature at 3 or 4 p.m. in the daytime than a neighbouring dry plot. The physical effect of irrigation on soils in equalising temperature and keeping soils from getting too hot cannot be overrated in a climate like that of India. In England coldness of soils is avoided by drainage. Drainage for this purpose alone is not required in this climate.

*Evenness of temperature* and slow nocturnal radiation are very helpful to the growth of plants. Uniformity of temperature occurs in sea-side places, the climate of which should be considered favourable to vegetation for this reason only. It should be noted, however, that cold is helpful for developing the germinating power of seed in the case of many agricultural crops of the temperature climates, and the difference of summer and winter is therefore beneficial. In sea-side places high winds prove an obstacle to agricultural operations. From January to May the difference between the day and night temperatures is the greatest in the plains of Bengal, while in July and August it is the least. Vegetative processes are hampered therefore from January to May and highly facilitate in July and August. The maximum and minimum temperatures of Calcutta throughout the year will be found from the following table :—

|           |       | Maximum. | Minimum. |
|-----------|-------|----------|----------|
| January   | .. .. | 83°F.    | 52°F.    |
| February  | .. .. | 91°      | 54°      |
| March     | .. .. | 99°      | 64°      |
| April     | .. .. | 103°     | 69°      |
| May       | .. .. | 100°     | 69°      |
| June      | .. .. | 98°      | 73°      |
| July      | .. .. | 93°      | 76°      |
| August    | .. .. | 92°      | 75°      |
| September | .. .. | 93°      | 75°      |
| October   | .. .. | 91°      | 68°      |
| November  | .. .. | 86°      | 57°      |
| December  | .. .. | 81°      | 52°      |

*The maximum and minimum* temperatures chiefly determine the crops that can be successfully grown at a certain locality. A temperature of over 90°F. is not suitable for growing wheat, and a temperature of under 60°F. is not suitable for the growth of rice. A temperature of 32°F., *i.e.*, frost, is unsuitable for the growth of vegetation, though it does not kill deep-rooted crops and trees, the roots of which are securely lodged in warmer layers of soil. **Evenness of temperature of the layers of soil in which the roots of plants are lodged is helpful to vegetation only when other conditions are equal.**

The following table gives the temperature of the soil of Calcutta at the surface and at the depth of three feet :—

|                            | Mean temperature<br>at the surface. | Mean temperature<br>at a depth of 3-ft. |
|----------------------------|-------------------------------------|---|
| January ..                 | 64·4°F.                             | 72·5°F.                                 |
| February ..                | 71·2°                               | 74·1°                                   |
| March ..                   | 82·7°                               | 78·4°                                   |
| April ..                   | 91·3°                               | 84·5°                                   |
| May ..                     | 90·4°                               | 87·1°                                   |
| June ..                    | 87·5°                               | 87·2°                                   |
| July ..                    | 86·2°                               | 86·4°                                   |
| August ..                  | 85·9°                               | 86·1°                                   |
| September ..               | 86·0°                               | 89·1°                                   |
| October ..                 | 83·2°                               | 85·2°                                   |
| November ..                | 73·3°                               | 81·0°                                   |
| December ..                | 64·8°                               | 75·1°                                   |
| Yearly mean temperature .. | 80·6°                               | 82·0°                                   |

*Inclination*, or the angle at which the sun's rays strike the earth, influences the temperature of the soil. Where there is a sufficiency of moisture, more direct rays of the sun causing greater heat of the soil, only result in richer vegetation of the indigenous kinds. A southern slope in the northern hemisphere is therefore desirable for moist climates; but a level soil helping retention of rainwater on it is by far the best for all ordinary purposes, in most parts of India. In cold climates even radiation from walls is taken advantage of in increasing the heat of the neighbouring soil and in growing fruits on the walls to greater perfection.

*The electrical influences* of various classes of soils on plant life in wet and in dry conditions have not been studied sufficiently minutely to enable us to give definite information on the subject. But this is the subject which is being largely studied at present, chiefly in France and Germany, and important results are anticipated from this study. Electricity has been applied to plants in three ways,—(1) through the soil by means of wires buried about two inches deep. (2) by a network of wires carried in the air above the growing crop, and (3) by powerful arc-lights which act like strong sun-light, the light being also softened by amber globes. Under the continuous action of the last of these crops have been matured in half the usual time, the light being kept burning the entire night. In the application of the first method, as soon as the seed is sown, the electric current is turned on by the underground wires. Germination takes place quicker and more freely and fully, and if the electric stimulation is kept up, growth goes on more vigorously. An increased yield of fifty per cent. over ordinary methods has been obtained by the application of electricity in this way. It has been shown by experiments conducted in Europe and in America that electricity can be applied to ordinary agricultural purposes on a large scale. The most recent method is

the second, and it consists of a network or wires carrying electric current some six feet above the ground where the crop is being grown.

*Elevation*, which mainly determines temperature and the amount of ammonia and nitric acid which the soil receives from rainfall, *Latitude* which also determines temperature and *Longitude* which partly determines directions of wind, are all potent meteorological agencies influencing growth of crops. As we ascend higher and higher up a hill, the temperature gets lower, and we notice the flora also changing and the character of cultivated crops, and the season of agricultural operations. At low elevations also a comparatively higher proportion of ammonia is obtained by means of rainfall but somewhat less of nitric acid, the formation of which in the higher regions of the atmosphere is due to electrical action in the clouds. Great elevation, *i.e.*, an elevation of over one thousand feet, is an evidence that the soil is likely to be of coarse texture, and also wet, and where high elevations are well wooded and protected from denudation, they indicate richness of soil in organic matter also. Calcutta is about 21 feet above the sea-level; Dacca, 35 feet; Sylhet, 53 feet; Cuttack, 80 feet; Chittagong, 86 feet; Burdwan, 99 feet; Durbhanga, 166 feet; Patna, 182 feet; and Darjeeling, 7,000 feet. From these figures one can infer that the soil near Calcutta is finer and better mixed than that of stations with higher elevations, while the soil of Darjeeling is the coarsest and rockiest, the fertility of each portion depending on the character of the underlying rock.

## CHAPTER VIII.

### SUNLIGHT, RAIN AND HAIL.

[Effect of different coloured rays on vegetation; Blue rays the best; Solar radiation how measured; Difference of endurance of plants for sunlight; Rainfall how governed; Regions beyond high hills, rainless; South-West and North-East monsoons; Receding monsoon; Regions of heavy rainfall; Effect of rain on soil; Loss of water by drainage and evaporation; Sinking of rain water in the soil; Rainfall getting more precarious on account of destruction of trees; Untimely rainfall should be utilised; Catch crops and fertilising crops; Brahmins' method of circulation of rainfall and meteorologists' methods both faulty; Table of rainfall, temperature, altitude, latitude and longitude of typical places in Bengal; What rainfall should be aimed at in securing site for a farm; Reading of weather charts; How hailstorms prevented in Austria and Italy.]

**Sunlight.**—Solar rays of different colours are known to produce different effects on vegetation. An experiment was conducted in glass compartments in which glass of the following colours was used: ruby, brown-red, orange, yellow, cobalt-blue and deep-green. The young plants first broke the soil in the box covered with the orange glass, and last under those covered by yellow,



green and blue glasses. It was subsequently found that the effect of the yellow rays was such as to prevent the germination of the seed, even although the rays only rested on the surface of the soil while the seed lay buried beneath; while, again, the blue light seemed to remarkably favour the process. Under the orange light the plants grew very tall, but then they had white stalks, and they refused to put forth any flowers. Under the yellow light it was remarkable that a number of little fungi or moulds sprang up and flourished luxuriantly while the plant themselves withered and died. Under the red light the plants only grew an inch or two high, had something of a reddish colour, and soon rotted and perished, although supplied with abundance of food in the soil in which they were placed. Under the green light the plants grew slowly but tolerably strong yet none would flower, notwithstanding the greatest care and attention paid to them. The results under the blue glass were very different. The seed germinated a little less quickly than in the open air, but the plants became compact and healthy in their character, putting forth their flower buds strongly and flowering in perfection. Under this light alone did the various processes go on with the vigour which is characteristic of vegetation in the open air. It is inferred that such would also probably be the case with plants grown under violet glass.

*Solar radiation* is recorded in meteorological stations with the help of a radiation thermometer. This consists of a delicate thermometer having a dull blackened bulb and inclosed in a glass tube from which the air has been removed. This instrument is freely exposed to the heat of the sun and its maximum reading registered. The greatest amount of solar radiation which occurs during the day is indicated by the excess of this temperature over the maximum temperature of the air in the shade. In the presence of moisture, solar heat is most potent in accelerating vegetative processes, but plants differ in the power of endurance of solar heat. Cotton, pineapple, and *Sida rhombifolia*, for example, though tropical plants, cannot bear the full blaze of the tropical sun, and they do better under the shade of trees.

**Rainfall.**—It cannot be said that the causes that govern rainfall in India are very well understood. Rainfall is regulated partly by the prevailing winds and partly by the contour of the country, chiefly with reference to the position of the seas and the mountains. In the neighbourhood of high mountains on the face turned towards the sea, the rainfall is heavy, as condensation of vapour takes place most readily on these mountainis. A tableland surrounded by mountains, *e.g.*, the Tibetan tableland, receives very little rain, since the winds which reach it have already parted with their moisture in ascending the hill-sides. Differences of temperature in different regions of the globe, stimulate currents of air, and when into a very hot and dry region currents of air flow from the sea and from cold and moist hill-tracts, cyclonic disturbances

accompanied by rain follow. In the greater part of Northern India the continuous heat of April, May and June tends to rarify the air and make the atmospheric pressure light in that region and continuous currents of air laden with moisture thereafter flow into these zones in definite directions. Thus in Bombay the monsoon current is from the south-west, *i.e.*, the Arabian Sea, while we have it from the south in Calcutta. These winds when they reach their full force in June, and when they are accompanied by cyclonic storms, are termed the south-west monsoon. Under normal conditions they begin in Ceylon between the 14th and 20th of May, at the Andamans and Rangoon a few days later, and at the head of Bay of Bengal during the first or second week of June. To obtain telegraphic information regarding the monsoon current from various stations in Southern India, from Ceylon and from the Andamans, is therefore of very great importance from an agricultural point of view, specially at the time of transplanting paddy.

The *amount and distribution of rainfall* which a particular locality receives, usually determine its productiveness, especially in the tropics. In the Malabar Coast of India and in parts of Assam the largest quantity of rainfall occurs, and these are among the most productive tracts in India. The regions of heavy rainfall, *i.e.*, of 70 to 100 inches or more, are Assam, parts of Eastern Bengal, the Cis-Himalayan region of Northern Bengal and the Eastern and Western Ghauts.

The effect of rainfall slowly but surely in changing the physical character of the surface soil, where such soil lies bare or is overgrown only by short grass, must not be ignored. The finer particles of clay getting washed out, the soil has a tendency to get lighter, which is an advantage only for soils which are too stiff. High winds, however, bring back some amount of fine dust and tend to keep up a balance. High winds which prevail on the seaside districts are therefore not to be regarded as absolutely inimical to agricultural pursuits. In course of time they help to make sandy tracts loamy and fit for cultivation. On the whole, however, boisterous winds are not helpful to the proper growth of crops unless they are very short crops. An occasional gale may lay low and spoil a crop nearly ready for the sickle and where high winds are the rule, very few crops can be grown and the landscape is generally found quite bare of trees in such localities.—and how helpful trees are to agriculture in various ways, we shall see later on.

What proportion of rain evaporates, what proportion sinks into the soil and feeds wells and springs, and what proportion finds its way by means of drains, streams and rivers, into the sea, depend upon the climate of the place, the season of the year, the porosity of the soil, the nature of the strata below, and the contour of the whole district or locality.

**Untimely rainfall.**—It is generally considered that the rainfall in India is becoming more precarious than used to be the case. How far this is really the case it is difficult to say, for the precariousness in recent years may be simply due to the fact that the character of the climate runs in cycles. But there are some elements in the present condition of things which are worthy of consideration from our present point of view. One form in which the uneven distribution of rainfall takes in India is the occurrence of heavy rains out of season. In 1906, for instance, after a fair amount of rainfall in January, in most parts of Bengal and Upper India, extraordinarily heavy rains occurred in February, in some places as much as ten inches. In March also, fairly heavy rains occurred and this was followed by the great drought of April. In Bengal, as a rule no use is made of this untimely rainfall, which is a very great pity. Such heavy rainfall, at any time of the year, would be at once made use of in Southern and Western India, in those parts where little rain is obtained. January rains should be always utilised in getting lands under the plough after the rice harvest. Once brought under the plough, the land can be afterwards kept stirred from time to time until the next rice sowing or transplanting season. This results in the soil retaining moisture much more effectively, absorbing fertility from the air and in being free from insect and fungus pests. If rain occur again in February after land has been prepared, sowing of catch-crops, or crops which take only about three months getting ready, should proceed vigorously. Such crops as have a beneficial effect on the future rice crop should be chosen in preference; so that if the crops come ultimately to nothing, the land at least may be fertilized. Melons and other cucurbitaceous crops, maize, *juar*, *til*, *bajri*, *marua*, buckwheat, cotton, cow-pea, ground-nut, *dhaincha*, sunn-hemp, *gowar sim* or *arharia sim* (*Cyamopsis psoralioides*) can be grown as catch-crops with untimely but heavy rain. The last five crops should be preferred as they have an excellent action in fertilizing the soil. When untimely but heavy rains occur in any month, usually there is heavy rain again the month after, at least that is our experience in Lower Bengal; so that there should be no hesitation on the part of cultivators to utilise heavy rains whenever they may happen. It is also our experience in Bengal, that heavy rains early in the season are compensated by short rainfall late in the season, and short rainfall early in the season is compensated by heavy rainfall late in the season. Cultivators make a great mistake to consult almanacs and Brahmin soothsayers in cultivating land and sowing seed. They ought to follow their own experience and common-sense in the matter, and rely on the beneficent dispensations of a wise Creator and Governor of the universe. In 1904, in the district of Sambalpur, the Hindu cultivators found they had made a serious mistake in neglecting the early rains of April and May and following their Brahmin's advice in the matter of cultivation, while their Mahommedan fellow-cultivators following their own

SUNLIGHT, RAIN AND HAIL.

|               | N. Lat. | E. Long. | Altitude above mean sea-level. | January. | February. | March. | April. | May. | June. | July. | August. | September. | October. | November. | December. | Yearly average.   |
|---------------|---------|----------|--------------------------------|----------|-----------|--------|--------|------|-------|-------|---------|------------|----------|-----------|-----------|-------------------|
| Burdwan ..    | 23°14'  | 87°54'   | 99 ft.                         | 0.30     | 0.84      | 1.27   | 2.59   | 4.99 | 10.04 | 12.42 | 12.33   | 7.90       | 4.92     | 0.58      | 0.17      | 58.33*<br>(78.4)  |
| Calcutta ..   | 22°33'  | 88°21'   | 21                             | 0.44     | 0.97      | 1.31   | 2.37   | 5.48 | 11.77 | 12.93 | 13.94   | 9.92       | 5.42     | 0.60      | 0.32      | 65.50*<br>(77.9)  |
| Cuttack ..    | 20°20'  | 85°54'   | 80                             | 0.40     | 0.47      | 0.93   | 1.44   | 3.19 | 10.30 | 12.77 | 11.41   | 9.71       | 5.79     | 1.03      | 0.48      | 57.82*<br>(80.7)  |
| Dacca ..      | 23°43'  | 90°27'   | 35                             | 0.29     | 0.97      | 2.45   | 5.84   | 9.25 | 13.25 | 12.93 | 12.38   | 10.19      | 5.40     | 0.68      | 0.23      | 73.86*<br>(78.7)  |
| Darjeeling .. | 27°3'   | 88°18'   | 7,421                          | 0.74     | 1.11      | 2.35   | 3.72   | 7.10 | 25.25 | 29.86 | 26.19   | 17.66      | 6.50     | 0.21      | 0.16      | 120.85*<br>(51.8) |
| Durbhanga ..  | 26°10'  | 86°0'    | 166                            | 0.47     | 0.57      | 0.28   | 0.61   | 2.23 | 8.20  | 11.90 | 11.32   | 8.92       | 2.70     | 0.08      | 0.11      | 47.39*<br>(76.8)  |
| Patna ..      | 25°10'  | 85°14'   | 182                            | 0.70     | 0.52      | 0.35   | 0.31   | 1.60 | 7.24  | 9.87  | 7.79    | 2.82       | 0.22     | 0.13      | 0.42      | 31.9*<br>(77.8)   |

R=Rainfall in inches. M. T.=Mean Temperature in degrees Fahrenheit.

judgment and cultivating their land and sowing the seed early in the season secured a bumper crop. It may be readily inferred that almanacs *cannot* be true, as they speak of rainfall, not of a particular village, but of the whole country, and we know from experience that rainfall differs from province to province, and district to district, and even from village to village. In 1904, the crops failed entirely in certain villages in the Chanda District, while in the neighbouring villages the crops were very good. A good shower of rain may save the situation in a village, while the absence of such rain may ruin the crop in the next village. Even for a particular village the Brahmin soothsayer's predictions often turn out wrong. He studies the state of the sky in the month of *Pous*, from day to day, and infers the character of the season for the whole of the next year. He divides the month into twelve equal parts, and notices if there are clouds or rain on any day or portion of a day. From this he concludes which months or which portion of a month in the year that is coming are to be rainy. We have studied their inferences and found them utterly in the wrong. Rain could not be predicted in such a simple way. Meteorologists are studying sun-spots, occurrence of snow in the hills, directions of winds in different parts of the world, and various other circumstances that are known or supposed to determine rainfall, but their forecasts also are generally out. We have no reliable means as yet for preparing forecasts of rainfall in India.

The table in the preceding page gives the latitude, longitude, elevation, mean temperature (M. T.) and rainfall (R.) of the principal towns of Bengal, Bihar and Orissa.

The rainfall of some parts of Assam is higher even than that of Darjeeling. The average annual rainfall of Cherrapunji is as much as 475 inches. In some years it runs up to 600 inches. In Sylhet the averages for the several months can be seen from the following figures:—January—0·39"; February—1·59"; March—5·74"; April—13·73"; May—21·64"; June—32·02"; July—25·48"; August—25·69"; September—20·05"; October—8·31"; November—1·18"; December—0·30"; Annual average—156·12". In Chittagong the annual average rainfall is 104 inches. It should be noted that even rice of the ordinary varieties grows better in the plains with a monthly rainfall of five or six inches at the germinating and ripening periods and ten or eleven inches at the growing period. The rainfall of twenty or twenty-five inches per month is suitable only for hill tracts where the excess water can be easily drained away. Excess is often as injurious as deficiency for most varieties of rice. Some varieties of rice, however, can stand a rainfall of twenty to thirty inches per month. A monthly rainfall of two to six inches is the most favourable for ordinary vegetation, the lower figure being more suited for the early and late periods of the growth of *Kharif* crops, and also for the cold weather crops,

as evaporation does not go on so rapidly in the cold weather as it does in the hot.

In selecting a site for a farm the average monthly rainfall registered in the nearest meteorological station should be consulted. If the average rainfall in any locality in April, May and June, and September, October and November is less than one to two inches, or very precarious, and that in July and August over twelve inches, and in some years as much as twenty or thirty inches or more, such a locality should be avoided as naturally unfavourable for general farming, unless it is a cool hill tract. Of course, the presence of canals, or other special facilities for irrigation, alters the question entirely.

**The Weather-chart.**—The agriculturist should be familiar with the reading of the weather-chart. The curved dotted lines that one sees on weather-charts, called *isobars*, are imaginary lines, each connecting all those places which have at a given time the same barometric pressure. From a number of these isobars on a chart one can see at a glance the nature of the distribution of atmospheric pressure over a country at any given time. The meteorological department issues these charts every morning. The difference of pressure between one *isobar* and the next is called the gradient. A gradient of "4" means, that over a distance of 1 degree or 60 miles the barometer has risen by  $\frac{1}{60}$  or  $\frac{1}{10}$ th of an inch. When the *isobars* are drawn close to one another they indicate high or steep gradient; when they are wider apart they indicate a low gradient. High gradient is followed by high winds and low gradient by light winds. Air does not blow directly from regions of high pressure to those of low pressure; the atmospheric movement caused by the rotations of the earth results in an alteration of the direction of the current. In the northern hemisphere if you stand with your back to the wind, the barometric pressure on the regions to your left hand is lower than on those to your right hand. In the southern hemisphere if you stand with your back to the wind, the regions of lower pressure will be on your right hand. The same principle is expressed in other words thus: if you stand with the high barometer to your right and the low barometer to your left, the wind will blow on your back. In the southern hemisphere the reverse will be the case. Thus the *isobars* indicate direction of the wind, and the distances between the lines its strength.

Actual barometric readings have to be reduced to a common standard by the Meteorological Office, as the elevation of the place of observation and the temperature at the time of observation, make a difference in the height of the column of mercury, apart from the difference of pressure causing movements of wind. All the readings are therefore corrected or reduced to sea-level and 32°F. for comparison. A reduction has also to be made on account of difference of gravity due to difference of length in the diameter of the

earth at different latitudes. All reduction is made for the latitude of 45°.

**Hail.**—The cause of hailstorms is not definitely known. They occur in Lower Bengal at the change of season from winter to summer, when southern breeze brings winds laden with moisture from the sea, and occasionally a northern wind brings the clouds back towards the south from the Himalayas. These clouds are formed high up in the air (*i.e.*, Cirrus clouds) and not low down as in the case of the clouds of the rainy season, and the colder regions of the atmosphere sometimes congeal the rain drops before they come down in the form of hail. Hailstones are larger or smaller in size as they come down from a greater or smaller height. The destruction caused by hailstones, though local, is often very considerable. In Italy the damage to vineyards annually caused by hail is estimated at over £4,000,000. In 1880 an Italian savant, Professor Bombicci of Bologna, observed that showers of rain were most frequent in those places where gun practice shook the air and filled it with smoke. Then followed the well-known American experiments (which have, however, led to no practical results) for artificially producing rain in a cloudless sky. In one direction Professor Bombicci's researches have led to a very practical result. In 1896 in Styria (Austria) a progressive vine-grower Burgomister Stieger started shooting with cannons against approaching storm clouds. He established shooting stations on the hills surrounding his vineyards at an altitude of from nine hundred to two thousand four hundred feet. At every station he had from five to six mortars in a wooden hut, so that shooting could be proceeded with even during rain. His mortars are eighteen inches long and they weigh about 160lb. each with a three centimetre chamber. He loads them with about 5ozs. of miner's powder. The clouds either disperse or come down in the form of rain and he has altogether avoided hail by this means. His example has been largely followed in Austria and Italy. There are now about six hundred hail-preventing stations in Italy.

## CHAPTER IX.

### FERTILITY AND BARRENNESS.

[No soils absolutely barren; How *usar* lands, sand-banks and saline soils can be rendered fertile; Presence of all essential ash-constituents in sufficient and available form; Plot experiments to ascertain fertility; Rough and ready tests of fertility; Earth-worms and grubs of insects, plants of various natural orders, specially of leguminous order; Bones and shells; Absorbent co-efficients; Solubility with dilute acids; Dr. Dyer's research; Minimum of a necessary ingredient; Barren lands, caused by ferrous salts, acids, ammonium cyanate, ammonium sulpho-cyanate, more than 2 per cent. of soluble salts, impermeability to water, and flow of water containing aluminium and magnesium salts; copper, lead and other heavy metals in excess.]

**FERTILITY** and sterility are relative terms. One soil is more fertile than another and one more sterile than another. In nature

there is no soil so absolutely barren that no method of draining, irrigation, manuring, or other treatment, has resulted or can result in vegetation. Even *usar* or salt lands in the United Provinces have been made to grow trees, grasses and superior crops, by a method of enclosing the land, of drainage and irrigation, and of manuring it with cowdung. Growing of *babul* trees on *usar* land is another means of reclaiming such land. Drainage and irrigation help the soil to get rid of its excess of soluble salts. Hard rock with no soil on it will, of course, grow no superior plants on it. But even soils which look like pure sand contain enough of plant-food to yield crops of indigo, mustard, *sorguja* and barley, if there is sufficient moisture in them. Nature's method of gradually converting sand-banks into fertile soils may be expedited by art. The lack of organic matter and of cohesion of particles may sometimes be made up in a single year by growing a crop of *sunh*-hemp or of *dhaincha*. A barren tract of saline soil may be rendered sweet and fertile by embankments and drainage, as is done in the Sunderbuns.

**Fertility.**—We have already seen that a fertile soil should contain all the essential ash-constituents of plants in a *sufficient* quantity and in an *available form*. A ten-plot or five-plot experiment is a practical guide for ascertaining their presence. A still readier method of judging the fertility of soils is the ascertaining of the following facts: *1st*, Do earthworms and grubs of insects abound to a sufficient depth in the soil? *2ndly*, Do plants of various natural orders, including the leguminosæ, grow abundantly and luxuriantly on the soil? *3rdly*, Are the bones of animals, habitually living on the soil, large-sized? *4thly*, Do shells of snails, etc., abound in the soil? A soil which is helpful to the growth of wild vegetation and which is able to support wild animal-life in abundance and build the solid parts of their body which are rich in phosphoric acid and lime, must be rich soil. Other things being equal the greater the absorbent co-efficient of a soil, the greater is its fertility; and the larger the proportion of the decomposable silicates present in it the more fertile it is. We will speak of absorption and decomposition of silicates more at length hereafter in the chapter on exhaustion, recuperation and absorption. By absorbent co-efficient is meant the number of cubic centimetres of nitrogen absorbed in the form of ammonia from a solution of ammonium chloride by one hundred grammes of soil.

Speaking generally, the greater the proportion of a soil which is dissolved by dilute acids the more fertile it is. The amount of soil-substances soluble in water usually varies from .1 to .5 per cent. But solubility in pure water is not a guide to the solubility of plant-food actually undergoing in the soil. Some chemists have assumed that dilute acetic acid dissolved all the os substances *available* to plants; but the acid secretions from rootlets are of a complex nature, and no absolute guide as to the dilution to be used is possible. Professor Stutzer of Bonn. was



the first to use 1 per cent. solution of citric acid for ascertaining the amount of *available* phosphoric acid in manures, and Dr. Dyer, of London, has carried out this method in dealing with soils, and arrived at very important practical results, in determining the proportions of available phosphoric acid and potash in soils. But the method gives no clue to the amount of available nitrogen in soils: and after all the question of fertility is mainly concerned with the amount of available nitrogen present in the soil. Besides, acid secretions from all rootlets are not all equivalent to a 1 per cent. solution of citric acid. Some secretions are more acid than others, and some plants therefore are better able to utilize the latent fertility of soils than others. The average acidity of root-secretions in terms of citric acid, shown by hundreds of plants examined by Dr. Dyer, is about 0.86 per cent. Coming to individual plants he found the variation was very great. Strawberry showed about 2 per cent. and a *Geum* (another plant of the order Rosaceæ) as much as 5.53 per cent.; while the examination of Solanaceæ and Liliaceæ gave very low results—about 0.36 per cent. Cruciferae and Leguminosæ averaged about 1 per cent. while Gramineæ, Umbelliferae, Compositæ and Chenopodiaceæ showed only about  $\frac{1}{2}$  per cent. These results, however, are very important in showing how some orders of plants such as Rosaceæ, Cruciferae, and Leguminosæ thrive on poor soils, while others, such as Solanææ, Liliaceæ, Gramineæ, Umbelliferae, Compositæ and Chenopodiaceæ, need liberal manuring. Some plants of the same natural orders differed widely from others in this property of acidity of root-secretions and the figures should be judged with this reservation.

Fertility is governed by the *minimum* of a necessary ingredient. A soil may be rich in all essential ash-constituents of plants but deficient or wanting only in one, and this deficiency or want may result in its barrenness. Soils derived from several rocks (*e.g.*, alluvial soils) are better than soils from one rock, as there is less likelihood of such soils being deficient in any necessary constituent.

**Barrenness.**—The following types of land are often barren. Soils containing an excess of ferrous salts, as, for instance, those formed by the oxidation of iron pyrites are barren. Land newly reclaimed from the sea contains ferrous salts and is therefore temporarily barren. Tank-earth freshly put on soils also makes them temporarily barren, probably also from the presence of ferrous salts. Drainage, liming and cultivation and exposure to the action of sun and air (which convert ferrus salts into ferric salts and sulphites into sulphates) are the means of reclaiming ands containing these poisons.

More than 2 per cent. of soluble salts in a soil makes it barren; but a very much less proportion of common salt would make a soil

barren. Lands reclaimed from the Sunderbuns have to be drained of their excess salt before they become fit for cultivation. The *usar* or barren lands of the United Provinces usually contain an excess of sodium carbonate or sodium sulphate which is locally called *Reh*. Attempts are being made to reclaim by drainage, enclosure and light manuring. In 1895-1896 Dr. Voelcker determined, by a series of carefully conducted experiments, the proportions of different sodium salts which might be present in a soil without preventing plant-growth. To good garden-soil, which was seen to contain no appreciable amount of any of the sodium salts, were added definite amounts of the three salts, sodium carbonate, sodium sulphate and sodium chloride. The amounts of salt varied from  $\cdot 1$  to 1 per cent. Cereals and pulses were sown in separate pots. It was found that each of these salts retarded the germination. The cereals were affected by  $\cdot 7$  per cent. of carbonate or sulphate and by  $\cdot 4$  per cent. of chloride. The germination of the pulses was retarded by smaller amounts, *i.e.*, by  $\cdot 2$  to  $\cdot 4$  per cent. of carbonate or chloride and  $\cdot 7$  per cent. of sulphate. In the after-growth  $\cdot 2$  per cent. of the carbonate did harm whilst  $\cdot 4$  per cent. was quite fatal. Up to  $\cdot 2$  per cent. of sodium chloride was found harmless in a few cases, whilst  $\cdot 1$  per cent. proved harmful in others. Sodium sulphate was less harmful, perfect growth both in the *kharif* and *rabi* seasons being maintained in the presence of  $\cdot 5$  per cent. of the salt. As in germination so in the aftergrowth, the leguminosæ were affected more than the cereals by the excess of soda salts. From this experiment it may be inferred how the lands reclaimed in the Sunderbuns though they become fit for growing rice very readily, are found unsuitable for pulse-crops for a long time. In the presence of lime, however, some leguminous crops, such as lucerne and *dhaincha*, can stand more common salt than they otherwise do, and in seaside places where there is no doubt of the presence of limestone lucerne and *dhaincha* can be readily grown.

Another cause of the barrenness of *usar* lands is their impermeability to water. Gypsum has been used with success in correcting this.

## PART II.

# IMPLEMENTS.

## CHAPTER X.

### THEORIES UNDERLYING CULTIVATION.

[Objects of cultivation; *Protracted cultivation* for dry season, but for *rabi* crops this may be overdone; Advantages and disadvantages of *deep cultivation*; Spacing for fibre and other crops; Drilling and hoeing; Jethro Tull and Lois-Weedon systems; Climatic influence on the nature of tillage; Nitrification; Drainage and irrigation; Bakharing; Trenching; Ridging, Drilling; Country-plough adapted for ridging; Subsoiling; Subsoil-ploughing, Rolling, Mulching; Harrowing—Burning sod and stubbles; Stifle-burning; Warping.]

THE objects of cultivation are:—(1) to allow roots to penetrate easily into the soil; (2) to allow air and water to find easy access into roots and the soil; (3) to allow absorption of moisture and of gases by soil to take place easily; (4) to allow the microbes which help in the formation of nitrates to thrive more freely with free access of oxygen and nitrogen; (5) to facilitate weathering of particles of soil chiefly by the action of oxygen, carbonic acid and water; (6) to break up nests of parasites. In one sentence, cultivation helps to bring about a suitable mechanical, chemical and biological condition in the soil.

The advantages of *protracted cultivation* are:—(a) better aeration, and specially nitrification; (b) better tilth; (c) exposure of insect and fungus pests to the action of birds, ants, sunlight, for a longer period; (d) the preservation of moisture in the lower layers of the soil. Cold weather preparation for *kharif* crops is actually practised by the best cultivators, who know it improves the soil and gives them a better return. In the *rabi* season in Bengal *protracted deep cultivation* is not always desirable as there is loss of moisture in the layer in which the seed is to be placed, the retention of which is needed for proper germination and growth; still it should extend for at least a fortnight during which four or five successive ploughings and ladderings should be done. *Rabi* cultivation should commence after the rains are properly over. *Kharif* cultivation should commence as soon after the rice harvest as possible. Valuable opportunities are usually lost when no advantage

is taken of rain from January to May in putting land under preparation for the rice or other rains crop.

The advantages of *deep cultivation* are:—(1) Roots can penetrate deeper and find food from the subsoil. Young plants have a great tendency towards root development. Hellriegel found that barley plants ten days' old and only in their third leaf had forty-two parts of dry matter in their roots for every fifty-eight of dry matter in the leaves and stem, while the proportion was twenty-nine to seventy-one when a month old, and eight to ninety-two when ripe. He also found that barley plants with only one leaf had roots nine or ten inches long, and when they had their second leaf, the roots were twenty inches long, and barley plants a month old had roots three feet long. A loose soil is of great help in developing the roots of agricultural crops. (2) Roots penetrating deep, a crop can resist drought better as the soil is, as a rule, more and more moist the deeper one goes. (3) By deep ploughing the distances between plants can be shortened as roots can then, instead of spreading out, sink deep in search of food. The *disadvantage* of deep cultivation lies in the fact of a great deal more of plant-food being made soluble and available than can be utilized by the crop, and the liability of this plant-food so get free, being washed out. This is a defect which has in the past been too much insisted upon.

**Spacing.**—One object of tillage operations is to allow just sufficient space to each class of crops. A rice plant should have at its disposal one-third cubic foot of earth. In Bengal we have found the common practice of transplanting several seedlings of paddy about nine inches apart very vicious, and better results have been obtained from single seedlings planted one foot apart. A bean plant should have at its disposal one cubic foot of earth, a potato plant three cubic feet, and a tobacco plant as much as seven cubic feet. In an experiment conducted by Hellriegel with barley plants grown on jars, it was found out that a plant grown on a large jar containing 28 lb. of earth weighed when ripe and perfectly dry 33,000 milligrammes and bore 636 seeds; while twenty-four plants grown in a jar containing 11 lb. of earth, weighed when dry 21,600 milligrammes and bore only 384 seeds (of a smaller size). The minimum space consistent with good yield should be allowed to each plant. For instance, though one potato plant will give the highest yield if it is given three cubic feet of space, it is more economical to have two plants in this space though these two will yield only a little more than the one plant. Potatoes planted in double rows four inches apart have been found at the Sibpur Farm to yield more than those planted in single rows, the distances in each case being eighteen inches by nine inches, though the proportion of increase in the latter case is larger.

**Drilling and Hoeing.**—The space allowed between plants not only helps in root development and better growth, but also in weeding.

Sowing in drills or regular lines and having a *perfectly level field*, one is able to do the weeding by bullock-hoes when plants are of that height (three inches to a foot) when bullock-hoes can be used without much loss by treading or breaking of stems. Where development of a large number of branches is considered undesirable, as in the case of fibre crops, deep cultivation and thick sowing are advisable. The objects of ploughing and reploughing a field of levelling it, of sowing seed in drills, and of weeding it with bullock hoes, are evident from what has been said here and in the chapter on physical properties of soils. There is a further object in constantly using the hoe, besides weeding. Stirring the soil helps in removing the surface-pan which is formed after rain or irrigation, and which prevents free access of air and the consequent weathering of soil particles. A sugarcane or potato crop should be hoed within a week after each irrigation to avoid caking of the soil, unless trench-irrigation is practised, as is desirable. So great is the benefit derived from constant stirring of soil during the growth of crops that Jethro Tull, a famous English farmer (1680-1740), jumped to the conclusion that tillage alone would serve, and no manure was needed. Tull's principle was carried out to better issue by the Revd. Mr. Smith of Lois-Weedon, Northamptonshire. Operating upon a clay-soil, Smith produced large wheat crops. His average for many years being thirty-four bushels in place of sixteen bushels, which was the average yield of the locality. He used no manure, but simply parcelled out his field in strips five feet wide and grew the crop in drills on alternate strips in successive years. The vacant strips were spaded and ploughed deeply and frequently, so that by the disintegration of soil and absorption of carbonic acid and nitrogen from the air, plant food enough for the next year's crop was secured. The Lois-Weedon system clearly shows what tillage and spacing can do without a particle of manure for a good many years.

**Climatic Influence.**—It should be mentioned here that deep cultivation is not, from the point of view of liberating plant food, so essential in warm climates as in cold climates. Disintegration of deep-seated soils is favoured by warmth, which generates carbon dioxide gas from organic matter and from disintegrating carbonates. Boussingault traced disintegration to a depth of three hundred feet in a warm mine. The corrosive action of air and water goes on much faster in warmer than in colder climates. The air in the pores of the cultivated soils is highly charged with carbon dioxide, it is also found in natural waters usually to the extent of nearly 1 per cent. and more in water that has passed through soils containing limestones and vegetable matter. The carbon dioxide enables water to dissolve and convey to the plants many fertilizing substances which are hardly soluble in pure water. Phosphate of lime and phosphate of iron even are not altogether insoluble in water charged with carbon dioxide.

**Formation of nitrates.**—Every well-tilled field may be regarded in the light of a saltpetre-bed. The value of nitrates for crops cannot be over-estimated, and the formation of potassium and calcium nitrates is facilitated by open tilth in the presence of organic matter and a little moisture, by the action of nitrifying bacteria. The value of keeping land in tilth during the dry months (*i.e.*, from December to May) cannot therefore be over-stated. During the wet months ploughed up soils should be in crop, or else the excess of plant-food made available by tillage operations may be washed away by rain.

**Drainage and Irrigation.**—The object of draining the soil is to admit air, which water-logging would prevent. Where a field is so situated that draining is not feasible, the land should be ridged before sowing for the *kharif* season or the ridging done after the plants (*e.g.*, maize, ground-nut, etc.), are nine inches high. Some crops are injured more than others by water-logging, but no crop, except some varieties of winter and *Boro* rice and aquatic plants, can stand water-logging throughout the season of its growth. Excess of moisture is specially injurious at and immediately after the period of germination, also at the periods of flowering and ripening. This is why *Nigarh* or letting out of water in September or October is practised in some districts as, for instance, in Orissa, for the rice-crop. *Nigarh* also helps tillering of the plants if done earlier in the season. If it is necessary to irrigate for helping on germination, it is better to irrigate the field before sowing than after sowing.

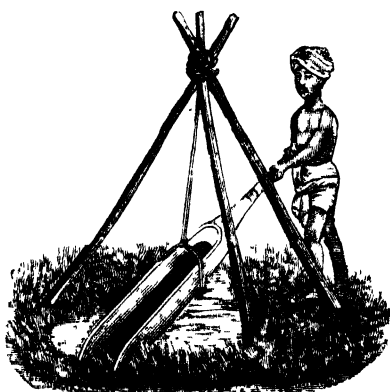

FIG. 1.—IRRIGATION SPOON.

If a field is irrigated in preparation for sowing, it is advisable to wait until the soil is sufficiently dry for passing the *Bakhar* for the preparation of a tilth and for breaking the surface-pan. Scattering of water on the fields after the sowing of seed, does, however, no harm. For this purpose, the use of irrigation ladles or spoons is advised. (Fig. 1.)

**Bakharing and Trenching.**—*Trenching* brings the subsoil to the top and where the subsoil is known to be as rich as the surface soil, this operation may be resorted to. It is, however, much more expensive than ploughing, as trenches have to be dug with spades. *Trenching* is done before valuable perennial plants, such as roses, are planted. *Trenching* is practised in Bengal for growing *man-kachu* and in Ireland for growing potatoes. The Irish system of

growing potatoes is called the lazy-bed system. The land is divided into strips as in the Lois-Weedon system already described, and from the bare strips, earth is dug out and spread over the strips on which potatoes are planted. Two such operations are equivalent to the two earthings. These bare strips or trenches are used for planting potatoes the next year and earth is dug out of the strips which had potatoes on them the previous year. Trenching may be done with advantage in growing high-class sugarcane. Even ordinary sugarcane should be grown in trenches in Bengal, as from January to March, when sugarcane should be planted, the soil is

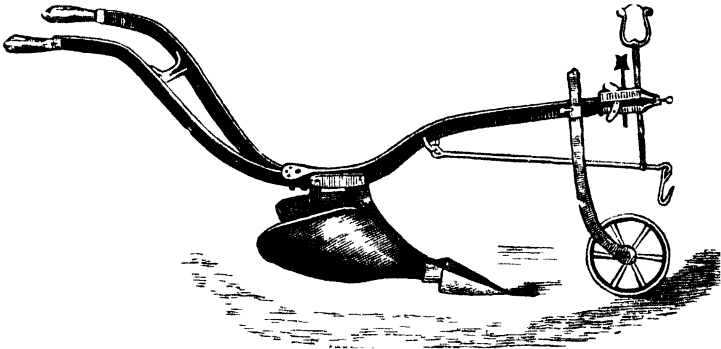

FIG. 2.—THE DOUBLE-MOULD-BOARD PLOUGH.

very dry at the surface. Shallow trenches may be dug with a double mould-board plough (Fig. 2). Making trenches with a double-mould-board plough costs less than one-sixth of what it does when trenching is done with spades. There are trenching ploughs used in Europe, but these require very powerful horses to work them.

**Ridging.**—The object of *ridging* or *hilling* is to expose the largest surface to the action of air, heat, cold and moisture, and also to prevent accumulation of water immediately at the base of plants. For clay-soils ridging is of great benefit especially when

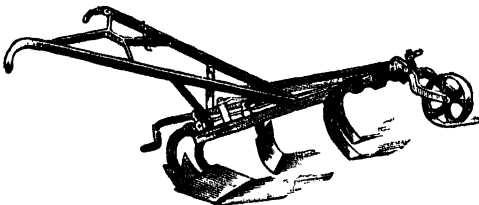

FIG. 3.—THE HUNTER HOE.

water-logging is feared, so that most crops which are cultivated from June to September should be grown on ridges or ridging done after the plants are a foot or two high. Sowing in trenches is advisable in the dry weather and so ridging should be done, specially in clay soils, for dry weather crops also. Ridging facilitates sowing in lines and using of hoes. The ridges can be split or spread out with the double-mould-board plough or a Hunter hoe (Fig. 3), and

the soil levelled, as in the case of sugarcane, potatoes, ground-nuts, mulberry and other crops which are benefited by subsequent earthing. The splitting of ridges after the plants are sufficiently high, acts like manuring. Sour and boggy soils are particularly benefited by ridging, as free access of oxygen reduces the organic acids and

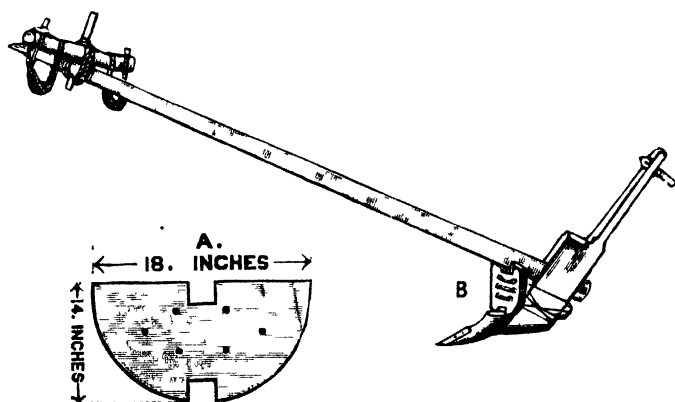

FIG. 4.—NATIVE PLOUGH FITTED UP AS A RIDGING PLOUGH.

converts sulphides into sulphates. Neither nitrites nor nitrates can exist in black, non-aerated, stiff and damp clay, until the soil is exposed to the action of air, which is best done by ridging. Ridging or splitting of ridges thus serves the following purposes: (a) Covering, say, potatoes, (b) preventing water-logging, (c) supporting maize, sugarcane and other tall crops and preventing their lodging, (d) manuring a growing crop with properly nitrified and aerated soil, (e) correcting acidity and poisons by aerification, and (f) earthing. Mr. F. Fletcher, late Deputy Director of Agriculture, Bombay, uses the country plough for making ridges on which irrigated crops are grown. He uses a *board* of the shape shown at A in Fig. 4. It has two slits that fit into the parts of the plough B and also holes through which a rope can be passed to fix the board in position.

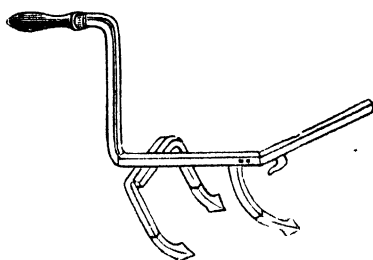

FIG. 5—THE SUBSOILER.

**Subsoiling.**—The use of mould-boards for ploughing is of great importance as they invert the soil, thus *burying sods* and *exposing a new layer* to the action of the elements. With the ordinary country plough, scratching of the soil is effected, but not over-turning of the soil. With the help of the mould-board the soil is overturned. *Subsoiling* and *subsoil-ploughing* are done with the object of admitting air and moisture into the subsoil.



Subsoiling only stirs the subsoil, but subsoil-ploughing brings the subsoil to the surface. A subsoiler (Fig. 5) may be attached to a plough if more bullocks are used. The surface-soil is usually richer, especially in organic matter, than the subsoil, and it is often undesirable to bring up the subsoil to the surface by trenching or subsoil-ploughing. But it is very desirable to stir the subsoil for certain crops with the object not only of admitting air and moisture into it and facilitating the penetration of roots, but also of breaking the impervious pan which is formed by the sole of the European plough. Subsoiling may be also done by a country-plough being passed behind a plough fitted with mould-board, the plough on the rear stirring the soil of the furrow made by the front plough in the same way as a subsoiler working behind a plough does the work. Deep-ploughing is best done in this country by passing one plough behind another along the same groove.

Another object of deep-ploughing, trenching or subsoiling is to increase the water-holding-capacity of soils. Loose earth receives and stores more water than compact earth. Ploughing a field in May after a very heavy shower of rain one may find the furrow turned up, wet only superficially, and dry at its deeper layers. Loose earth could retain over 40 per cent. of its weight of water, while the same earth in a very compact condition would hold only about 25 per cent.

**Rolling and Mulching.**—On the other hand, soil which is too loose, will not allow water to rise in it and does not firmly support the plants growing on it. A tilth too open is not desirable especially for light soils, which should be rolled after ploughing and harrowing. *Rolling and mulching* are practised to cause moisture to rise in the soil and to retain the moisture respectively. By “mulch” is meant anything laid on tilled soil to keep in moisture, such as leaves and straw, bits of cowdung cake, etc. Too free a subsoil may also result in water sinking too quickly, leaving the surface soil hungry. Extremes should therefore be avoided in tilling operations.

**Harrowing.**—The object of harrowing is to level the land after ploughing, produce a good tilth, and to collect the weeds. Where the land has to be ridged the operation of ridging follows that of harrowing. The native ladder acts both as a harrow and a roller inasmuch as it collects weeds, levels the land and gives it a certain amount of compactness. But the work is done very imperfectly by a ladder. The beam or the levelling board used in other parts of India is not effective in collecting weeds, but it is more effective than the ladder for levelling land and giving it compactness. It is advisable to introduce a light harrow and a light wooden roller (which can be easily managed by a pair of bullocks), in the farm operations of Bengal.

**Burning the sod** is recommended only for new jungle land, for peaty soils and for some clay lands, *i.e.*, on caly lands which

contain a good deal of silicate of potash and some lime. The lime decomposes the silicate and liberates some of the potash. All clays are benefited by moderate burning which makes the land more friable and less plastic. Moderate burning, *i.e.*, burning in slow heat, if necessary, stifle-burning, should be resorted to, except in new jungle land where the loss of nitrogenous matter would not be so severely felt as in ordinary agricultural land. Stifle-burning corrects acidity of soils, and clears if of weeds, insects, fungi and their seeds. If burning is done too freely, not only is there too much loss of organic matter and nitrates, but the physical character of the soil becomes deteriorated. *i.e.*, impervious brick-like masses are formed on the surface.

**Warping.** As it is not practicable to improve soil by mixing with it soil of a different character carted from another locality, the same result is sometimes achieved in sandy, stony or peaty soils, favourably situated, by the operation known as *warping*. A bund two or three feet in height is put up around the land to be improved, and the enclosed land is sometimes further partitioned off by smaller bunds. Then the muddy water of a stream, at the beginning of the rainy season, is diverted into this area, where it flows from one compartment to another, until the whole area is filled. A film of silt is deposited, and by repeating the operation several inches of silt may be accumulated on the land in one season. Where tides come in, warping is very easy to regulate by means of a sluice or flap-gate, as in the low lands to the south of the Sibpur College, where the object is not so much the fertilizing of the land as the raising of its level.

## CHAPTER XI.

### MOTIVE POWER OR PRIME MOVERS.

[Classification ; Work of man : English farm-labourer and different classes of Indian farm-labourers compared, Wages for piece-work ; animal-power, where suited ; Improvement of Indian Agriculture chiefly by means of a more extended employment of bullock-power ; Calculation comparing horse-power with Bengal bullock-power ; Bullock gears ; Wind-power ; Cheap wind-mills, aeromotors ; Power-mills ; Calculation for estimating efficiency of aeromotors ; Erection of aeromotors ; Water-power ; Efficiency of water-wheels and turbines compared ; Advantages of water-power over other forms of power for agricultural purposes ; Steam-power—Stationary, portable and traction engines ; Gas and oil-engines ; Oil-engine and centrifugal pumps for pumping water ; Electricity as a motive-power.]

WORK done on the farm may be divided into seven classes in those countries where agriculture has attained a very high state of efficiency. These are : (1) Work of man ; (2) Work done by animal-power, *viz.*, horses, mules, donkeys, bullocks, etc. ; (3) Work done by wind-power ; (4) Work done by water-power ; (5) Work done by steam-power ; (6) Work done by explosive action of gas and oil-engines ; (7) Work done by electricity.

**Work of Man.**—Where work has to be done on a large scale the first form of work is the most expensive, the second less expensive, the third still less, and so on. Wherever therefore animal-power, wind-power, water-power, steam-power, etc., can be made use of, the employment of hand-power should be avoided as a general rule. In this country the management of labour is of very great difficulty. An Indian labourer who will hand-weed one-tenth of an acre a day working for himself, can hardly be got to do one-fortieth of an acre for his employer. Apart from this, there is the general advantage of mechanical over hand-power. In hilling an acre of maize or potatoes, for instance, with *kodalies* the cost comes to Rs. 5 or Rs. 6 near Calcutta, while with a ridging plough or a Hunter hoe the same work can be accomplished at an expenditure of only about eight to twelve annas. Of course, work of such a nature as requires reason and judgment for guidance must be done by man, for instance, attendance on cattle and other live-stock, planting and transplanting, management of machinery, etc. Some work which can be done by machinery is more cheaply and conveniently done by hand-power, for instance, binding of sheaves. In managing Indian labour it is very necessary to have a *sivdar* or foreman, or overseer to look after the labourers, unless the proprietor of the farm can do so himself. If the proprietor is himself an expert cultivator accustomed to doing rough work, he can always get more work out of labourers by himself working with the gang. Working Indian labourers on the gang system is very important, and yet each man should be given a separate piece of work to do that the amount and quality of each man's work may be judged. It is not of course necessary to employ all the labourers on the same field and in the same work at the same time. It is enough if the overseer can easily see each man from where he is, doing his allotted piece of work. When labourers distribute themselves in different parts of a farm and work outside the immediate ken of the foreman, they do very little work. There are some works, such as broadcasting, dibbling or hand-drilling of seed, planting, cuttings, etc., which need close watching. There are usually two ways of doing a work,—a careful and a careless way. It is less troublesome doing work carelessly, and unless labourers are immediately corrected when they take to careless ways, they get into the habit of working carelessly. A great deal depends upon proper habits being engrafted to labourers. When Indian labourers once get into the habit of doing some work in the proper manner, they continue to do the work in the proper manner, even when they are not very closely watched. Some of the cultivator's habits are hereditary, and some castes are therefore found doing work faster and in a neater manner than others. It is less troublesome, for instance, sticking sugarcane cuttings in prepared soil, any how, so that some are planted six inches deep while others only one or two inches deep. But whenever a labourer plants a cutting one or two inches deep, he must be

made to plant it five or six inches deep, until a proper habit is established. A labourer, however, who is accustomed to do sugarcane planting in his own family, will habitually plant the cuttings at this depth, when planting them erect, or three inches deep when planting them horizontally. If expert labourers can be secured, it is always better. But cultivators in this country go in for cultivating so few crops that expert labourers can be had in any particular locality only for doing the cultivation of two or three crops properly. An ordinary cultivating labourer in Bengal will transplant paddy neatly and fast, broadcast jute and *kalai* seeds evenly, harvest the paddy and the jute in the proper style, but in doing the cultivation of a new kind of crop he will be found awkward and slow. An intelligent man must be behind him to insist on the work being done properly and fast.

The calculation for hand-power is fraught with more difficulty than that for steam-power, horse-power, or bullock-power. An English farm labourer in his own country does far more work than an Indian farm-labourer, and an Indian farm-labourer will do far more work for himself than for another party, while one class of labourers even in the same part of the country does habitually more work than another class of labourers. Further complication arises from the fact that a certain class of labourers will do a certain kind of work well while they will do another kind of work very imperfectly. The Sonthal labourer will dig more than a Bengali labourer, but the latter will transplant more paddy. The Sonthal woman will transplant a great deal more paddy than the Sonthal man. An English farm-labourer in digging does 250 ft.-lb. of work per minute. In the Bengal Famine operations of 1897 an average quantity of about 100 cubic feet of earth was raised 3 ft. during six hours and the weight of a cubic feet of earth being taken as 100 lb., the work done in six hours was about  $100 \times 100 \times 3$  ft.-lb. or,  $\frac{100 \times 100 \times 3}{6 \times 60}$ —about 83 ft.-lb. per minute. As the famine labourers were mostly non-professional diggers, and as they were somewhat weak, the work done by the average Bengali labourer habitually employed in digging may be calculated at about 125 ft.-lb. per minute. though cases of 200 to 300 cubic feet of earth being dug by one man sometimes came to notice even in the famine operation. Basing on this calculation of a Bengali labourer being able generally to perform only half the amount of work of an English labourer, he should be able to show :—

- |     |               |                                |                        |
|-----|---------------|--------------------------------|------------------------|
| (1) | 125 ft.-lb.   | of work per minute in digging. |                        |
| (2) | 165 ft.-lb.   | “ “ “                          | filling dung in carts. |
| (3) | 250 ft.-lb.   | “ “ “                          | pitching corn.         |
| (4) | 2,000 ft.-lb. | “ “ “                          | rowing a boat.         |

In filling dung in carts, an English labourer will load 30 to 40 cubic yards in ten hours to an average height of 4 ft. The weight of fresh dung is 12 to 14 cwts. and of well-made rotted dung, one ten per cubic yard. 50,000 lb. lifted into

carts 4 feet high means 200,000 lb. raised 1 foot high per day of ten hours, which is equivalent to 330 ft.-lb. per minute. In pitching corn an English labourer can pitch the corn of one acre per hour, *i.e.*, two tons of grain and straw. The average height to which the corn is pitched is 6 ft. 5,000 lb. lifted 6 ft. high = 30,000 ft.-lb. per hour, *i.e.*, 500 ft.-lb. per minute.

The relation between horse-power and human-power is as 7 : 1 in the case of the English labourer. We may approximately put down the relation between horse-power and the power exerted by a Bengali labourer as 14 : 1. But it entirely depends upon the character of the particular work whether human power is so much less efficient or still less so. For steady draught purposes a pair of Bengal bullocks is at least ten times as efficient as a labourer, though theoretically a Bengal bullock, as we shall presently see, is only one-and-a-half times as powerful as a Bengali labourer.

Calculating wages at three annas a day, the average cost of the principal farm operations where hand-power is partly or wholly employed, is given below. It must be remembered, however, that wages are steadily rising and that three annas a day, which was a good wage in Bengal a few years ago, is now very old except in certain tracts like Behar.

|   | PER ACRE. |    |   |
|---|-----------|----|---|
|   | Rs. A. P. |    |   |
| First ploughing with laddering (inclusive of the cost of keep of cattle) .. .. .                      | 1         | 2  | 0 |
| Ditto (exclusive of keep of cattle) .. .. .   | 0         | 12 | 0 |
| Second and subsequent ploughing with laddering .. .. .  | 0         | 12 | 0 |
| Ditto (exclusive of cattle) .. .. .   | 0         | 9  | 0 |
| Grubbing, harrowing, rolling, bakharing (inclusive of cattle) .. .. .                                 | 0         | 6  | 0 |
| Making furrows with ridging plough .. .. .  | 0         | 12 | 0 |
| Making furrows with <i>kodialies</i> (country spades) $3\frac{1}{2}$ ft. apart and 1 ft. deep .. .. . | 3         | 12 | 0 |
| Planting sugarcane or mulberry cuttings or seed-potatoes, including covering with earth .. .. .       | 4         | 8  | 0 |
| Irrigating with <i>sewny</i> , or Cawnpore pump .. .. .   | 3         | 0  | 0 |
| Irrigating with <i>dôn</i> .. .. .  | 1         | 8  | 0 |
| Spreading manure in trenches, including covering the manure .. .. .                                   | 1         | 8  | 0 |
| Spreading manure broadcast .. .. .  | 0         | 6  | 0 |
| Hilling with <i>kodialies</i> .. .. .   | 5         | 0  | 0 |
| Hilling with Hunter <i>hoe</i> (inclusive of cattle) .. .. .  | 0         | 8  | 0 |
| Spading fallow land for thorough digging .. .. .  | 6         | 0  | 0 |
| Hand-hoeing* .. .. .  | 3         | 0  | 0 |
| Wheel-hoeing with Planet Jr. hoe .. .. .  | 0         | 9  | 0 |

\* Cultivators usually spend Rs. 6 per acre for hand-weeding paddy, as they have to pay 6 to 8 annas a day to a labourer at the weeding season.

|  | PER ACRE. |    |    |
|--|-----------|----|----|
|  | Rs.       | A. | P. |
| Cutting and stripping sugarcane .. ..  | 11        | 4  | 0  |
| Cutting paddy with hooks or sickles .. ..                                      | 1         | 8  | 0  |
| Thrashing and winnowing paddy with hand thrashing and winnowing machines .. .. | 4         | 8  | 0  |
| Transplanting paddy .. ..  | 1         | 2  | 0  |
| Sowing seed broadcast .. ..  | 0         | 6  | 0  |
| Sowing seed in drill with Planet Jr. hoe .. ..                                 | 1         | 8  | 0  |

Wherever possible work should be got done by contract at the above rates, even by labourers employed by the month. Piece-work or work done by contract is, however, apt to be done carelessly unless proper supervision is exercised.

**Animal Power.** Horse, cattle, or donkey-power is utilised for three classes of work. (1) For direct draught or haulage as in drawing carts, ploughing, etc. (2) For application to machines to turn a capstan giving motion to a wheel or windlass, *e.g.*, in thrashing corn, ginning cotton, pumping water, etc., by animal power. (3) For pedalling to turn a tread-mill for communicating power or lifting water. Work done by draught-animals, aided by human reason, is less expensive per unit than work done by hand-power, and it is by the substitution of hand-power by cattle-power that a great many agricultural improvements may be effected in this country. With a Hunter hoe (it may be repeated here) which is easily drawn by a pair of country bullocks, maize or potato fields may be ridged at a cost of about eight annas per acre, while the same work done by hand-power with *kodalies* will cost Rs. 5, and if the labourers are not closely watched the cost will even exceed this amount. Hand-weeding is more efficient, but for most crops hoeing with bullock-hoes will be found sufficiently effective. Freeing land of weeds is not of such importance as giving vigour to the growing crop, which often results in weeds being smothered. When mechanical power (*i.e.*, steam, etc.) cannot be conveniently and extensively employed, *e.g.*, when fields are small, uneven and crooked, or cut by natural water-courses, it is better and cheaper to cultivate with the aid of draught-animals than with steam. As Bengal fields are not like English fields, which are, say, from ten to twenty acres in area, and as they are enclosed by *ahirs* or borders, and cut by natural water-courses, steam ploughing and steam cultivation generally are usually quite unsuitable for Bengal conditions. The introduction of implements suitable for the employment of bullock-power more extensively than it is now, is of the utmost importance. Indian cultivators are, as a rule, averse to using mechanical appliances. In this, as in other matters, they have got to be *habituated* to see the advantage of using mechanical appliances before they begin to take to them. Even when the advantage of some mechanical appliance or some new method has been demonstrated to them, they are apt to fall back on their own old appliances and

the methods to which they had been accustomed. In dealing with Indian raiyats the questions of habit and of local influence are of considerable importance.

**Bullock-power.**—Bengal bullock-power may be ascertained in the following way:—A pair of Bengal bullocks, it may be observed, walk about 66 ft. per minute while ploughing, the draught exerted being about 100 lb. The fields of the Sibpur Farm being all 66 ft. wide, the facts stated here have been constantly tested. The work done per minute by a pair of Bengal bullocks is therefore  $66 \times 100 = 6,600$  ft.-lb. per minute, *i.e.*, 3,300 ft.-lb. per bullock per minute. The work done by one English farm-horse can be similarly ascertained to be about 33,000 ft.-lb. (which is the theoretical horse-power, the unit of measurement for steam and other high powers). The Bengal bullock therefore performs ten times less work than the English farm-horse. The actual horse or bullock-power is only two-thirds of the nominal horse or bullock-power, as in the above calculation no account is taken of loss of times in turning, and for other stoppages. So compared to Watt's horse-power or theoretical horse-power the actual English horse-power and Bengal bullock-power are respectively as 33,000 : 22,000 : 2,200 ft.-lb.

Draught animals do not perform the same amount of work while working a chain pump or thrashing machine by walking round and round a track, as they do while ploughing. First, the position of the animals in a bullock-gear is inconvenient; secondly, they cannot exert their full power in a bullock-gear; and, thirdly, force is lost by pulling at an angle.

In England a pair of horses is calculated as sufficient for keeping fifty acres in cultivation; and our cultivators calculate one yoke of Bengal oxen as being sufficient for keeping sixteen bighas (about five acres) in cultivation. Thus from actual practice also it is deducible that an English farm-horse is able to do ten times as much work as a Bengal bullock, and that the work done by a Bengal bullock, while ploughing, is 2,200 ft.-lb., as stated above. On light soil, three horses are kept in England for every hundred acres of land. On this calculation we would require in Bengal thirty bullocks for working one hundred acres of light land or about one yoke of oxen for twenty bighas. In stocking a farm in Lower Bengal these figures should be borne in mind. A pair of Gujarat, Nellore, Dakshini, or Hissar bullocks do three times the work of Bengal bullocks. Gujarat bullocks are weaker footed than Dakshini animals and on hard soil they are not able to work long.

It will be long before bullock-power will be replaced by steam or electricity in this country for farm operations. Steam and other engines deteriorate as time goes on; cattle have a tendency to multiply. That horses are a farm-produce, is one of the chief considerations why horses are mainly employed in English farm operations even where steam is applicable. Judiciously managed

the employment of bullock-power in a farm not only costs little, but it actually becomes a source of income to the farm. From the third year of their life to the tenth year bullocks can be worked and afterwards they can be sold off, while a few cows may be maintained on the farm to keep up a supply of vigorous young stock. Such works as churning, thrashing, husking, pulping, pumping, ginning, which are more cheaply done by wind or steam-power, can be done by bullock-power when the bullocks have a slow time and when there is not much work to be done on the farm.

To help the more efficient employment of bullock-power it is necessary to have a bullock-gear to which such light machinery as thrasher, huller, winnower churn, pump, pulper, chaff-cutter or cake-crusher, can be attached. The attachment is made by means of a leather belt which communicates the motion of the revolving capstan (to which the bullock-shaft is attached by means of a large cog-wheel which turns a smaller pinion-wheel) to the machinery concerned. There are many forms of gearing for obtaining increased speed, even for working such high-speed machines

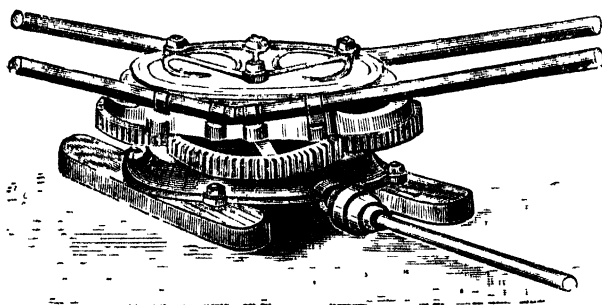

FIG. 6.—MESSRS LISTER'S TRIPLEX HORSE-GEAR.

as centrifugal cream-separators. The best and most efficient is Messrs. Lister's Triplex Horse-Gear (Fig. 6) which requires no intermediate gearing. The lay-shaft makes 64 revolutions to one of the horse, so that by attaching a 21-inch cog-wheel at the end of the shaft working in gear with a small pinion, it is possible to drive a cream-separator without the intervention of a leather belt or rope.

**Wind-power.**—Though windmills are gone out of fashion in highly civilized countries, they seem to be specially appropriate for India. The improved windmills or aeromotors, the introduction of which is being attempted by some of the agricultural departments of India, cost so much at the first setting up, that they do not seem to be adapted for the use of the ordinary *raiyat*. The old-fashioned English windmills which have been introduced into British colonies of South Africa with such success, seem well adap-



ted for India. Windmills of cheap construction are popular in the United States also, whence we get the Chicago aeromotors. A cheap windmill may be constructed without a vane, and the wheel is so fixed as to be driven only by the prevailing wind during the dry season, which in Lower Bengal are from north and south, or a few points off either way. The sails would catch the wind only when it is about northerly or southerly, and the mill would thus be set in motion. When the wind is easterly or westerly it would not move. It is necessary to enclose the lower part with boards or walls so as to exclude the wind from all sides except from the top and the action of the mill would correspond to that of an over-shot water-wheel. The figure given here (Fig. 7) illustrates a windmill which would cost only about Rs. 50 constructing. There is an iron axle to which are 6 fans or sails (5 ft. x 6 ft.) attached. The "Jumbo-box" is 12 ft. long by 8 ft. wide by 6 ft. high. The axle is mounted on posts. Such a windmill has been known to pump water for one hundred head of cattle from an 18 ft. well. The whole arrangement, if a pump is provided, can be set up by

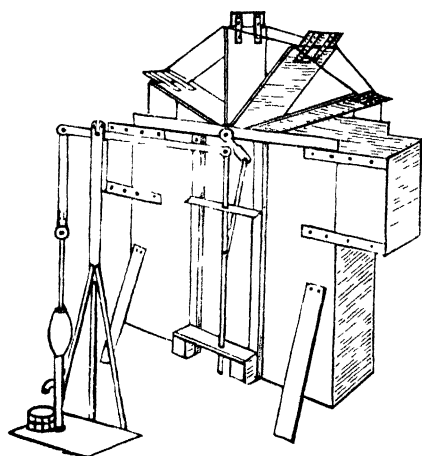

FIG. 7.—THE HOME-MADE WINDMILL.

a village carpenter and a blacksmith. Any old lumber, such as split rails, old packing boxes, tin from old tin roofs, can be pressed into the service in the construction of these mills. The sails may be constructed either narrow and tall or square or oblong, the object being the offering of a large surface of obstruction for the wind. With proper mechanical arrangements these home-made mills cannot only be used for pumping water, but also for working a grindstone, for ginning cotton, for sawing wood, for churning

butter, for cutting chaff, for crushing oil-cake and doing other ordinary barn-door work. The old forms of windmill (called post-tower, or smock-mill) with a  $15\frac{1}{2}$  ft. radius and with a breeze of eight miles per hour yield about one horse-power of energy.

**Power-Mill.**—In a large farm, where it is worth while having chaff-cutters, cake-crushers, etc., worked by wind or water-power, it is important to have the mill working at all seasons, specially at the wet season, when indoor work is preferable to out-door work. The self-adjusting windmills of modern construction are preferable for constant work, as even with very light wind they do fairly good work, and the vane turns the wheel in such a manner, that whatever the direction of the wind may be, the sails catch it and work

the mill. The whole expense is incurred in the first erection. Afterwards oiling once a week is all that is needed. Rs. 2,000 laid out in the erection of a power-mill, one form of which is represented here (Fig. 8), can be got back in two years in a properly organised farm.

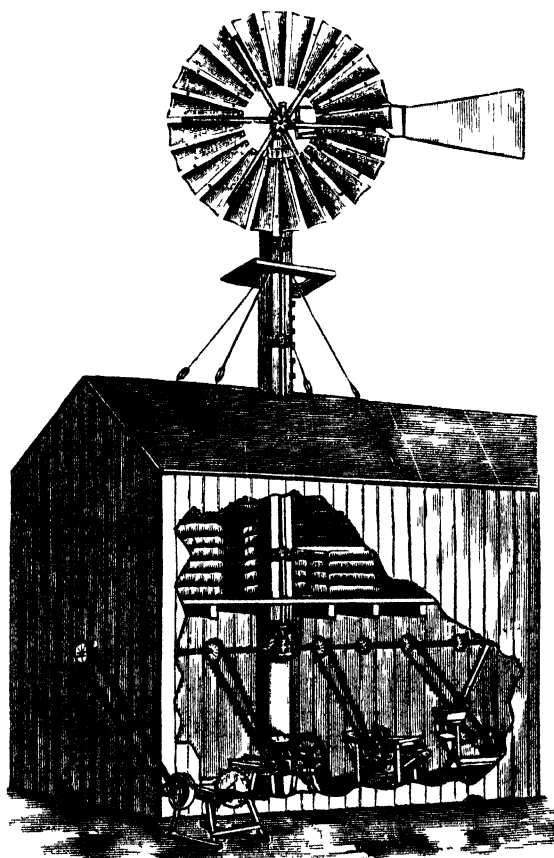

FIG. 8.—THE AEROMOTOR (POWER-MILL).

Windmills of modern construction, called also aeromotors, are either vertical or horizontal. The mill represented here in Fig. 8 is a vertical mill, the motion of the wheel being vertical. The sails of a horizontal mill move horizontally.

**Useful Tables.**—A few tables regarding velocity of wind, etc., may be found very useful in connection with the question of efficiency of windmills.

*Velocity of wind.*

| Popular Description.         | Equivalent in miles per hour. | Equivalent in feet per second. | Force exerted per square foot of sail. |
|------------------------------|-------------------------------|--------------------------------|--|
| Breeze hardly perceptible .. | 1                             | 1.47                           | .005 lb.                               |
| Gentle breeze ..             | 5                             | 7.33                           | .123 "                                 |
| Pleasant breeze .. {         | 10                            | 14.67                          | .492 "                                 |
|                              | 15                            | 22.00                          | 1.107 "                                |
| Brisk gale ..                | 20                            | 29.3                           | 1.968 "                                |
| Very high wind ..            | 40                            | 58.6                           | 7.872 "                                |
| Storm ..                     | 50                            | 73.3                           | 12.300 "                               |
| Hurricane ..                 | 100                           | 146.6                          | 49.200 "                               |

*Discharge of water by pump.*

| Diameter of pump-cylinder. | Weight of water contained in 1 ft. length of cylinder. | Amount of water discharged by every inch of pump-stroke. |
|----------------------------|--|--|
| 1½ inch                    | .774 lb.   | .0076 gallons.   |
| 2 inches                   | 1.372 "  | .0136 "  |
| 2½ "                       | 2.159 "  | .0212 "  |
| 3 "                        | 3.087 "  | .0306 "  |
| 3½ "                       | 4.214 "  | .0416 "  |
| 4 "                        | 5.488 "  | .0544 "  |
| 5 "                        | 8.575 "  | .0850 "  |

*Efficiency of Aeromotors.*

| Height to which water is to be lifted. | Diameter to pump-cylinder when 8 ft. mill used. | Gallons per hour when 8 ft. mill used. | Diameter of pump-cylinder when 12 ft. mill used. | Gallons per hour when 12 ft. mill used. |
|--|---|--|--|---|
| 5 ft.                                  | 8 inches.                                       | 3,634                                  | 10 inches.                                       | 5,508                                   |
| 10 "                                   | 6 "   | 1,763                                  | 8* "   | 4,700                                   |
| 15 "                                   | 5 "   | 1,224                                  | 8 "  | 3,525                                   |
| 20 "                                   | 4½ "  | 998                                    | 6* "   | 2,644                                   |
| 25 "                                   | 4 "   | 784                                    | 6 "  | 1,983                                   |
| 30 "                                   | 3¾ "  | 689                                    | 5 "  | 1,377                                   |
| 40 "                                   | 3½ "  | 600                                    | 5 "  | 1,377                                   |
| 50 "                                   | 3¼ "  | 518                                    | 4½ "   | 1,115                                   |
| 60 "                                   | 3 "   | 440                                    | 4 "  | 882                                     |
| 70 "                                   | 2¾ "  | 371                                    | 4 "  | 882                                     |
| 80 "                                   | 2½ "  | 306                                    | 3¾ "   | 776                                     |
| 100 "                                  | 2¼ "  | 248                                    | 3½ "   | 586                                     |

**Calibre of pump-cylinder.**—The above table gives the efficiency of aeromotors when the velocity of wind is of the average strength, *i.e.*, about sixteen miles an hour. A mill with a wheel eight feet in diameter is constructed to have a pump-stroke of six inches. A mill with a 12 ft. wheel is constructed either with nine inches or 1 ft. pump-stroke. The two pump-cylinders with eight inches and six inches diameters noted with asterisks(\*) in the above table are assumed to have the long stroke (1 ft.) attachment. With average velocity of wind, an 8 ft. mill undergoes about forty strokes and a 12 ft. mill about thirty strokes per minute. With lighter winds the efficiency is less, and with stronger winds, more, than is indicated in the table. For irrigation purposes it is best to employ a cylinder of the calibre indicated in the table so as to get the maximum benefit from the aeromotor. But cylinders of smaller calibre than those indicated



Measure a distance of, say, twenty yards, along the centre of the stream or channel intended to be utilized, and let a bit of cork, or any kind of light float be allowed to pass along this distance of twenty yards. This gives the velocity of the water at the middle of the channel. At the sides and at the bottom, the velocity is less. If the bottom and the sides of the channel are made of bricks, 17 per cent. of the velocity ascertained in the above manner should be taken off; if the sides and bottom are of earth, 29 per cent. should be taken off, and if they are stony, irregular and rough, 36 per cent. should be taken off, in estimating the average velocity of a stream. Then by multiplying the section of the stream utilized by the reduced velocity, one gets the quantity of water expressed in the terms of so many cubic feet per minute.

**Efficiency.**—The effective horse-power of the principal forms of water-motors are :—

|   | Of the theoretical horse-power |
|---|--------------------------------|
| For ordinary Undershot-wheels . . . . .         | 35 per cent.                   |
| For ordinary Breast wheels . . . . .            | 55 ..                          |
| For ordinary Overshot wheels . . . . .          | 68 ..                          |
| For Turbines . . . . .                          | 70 ..                          |
| For new fashioned wheels and turbines . . . . . | 75 to 80 ..                    |

The effective power varies according to the ingenuity of construction and erection, which minimises friction. Properly constructed, a breast and overshot-wheel and a turbine may have a 75 per cent. efficiency. On the 75 per cent. basis, it has been ascertained that the height of the fall in feet multiplied by the number of cubic feet of water per minute, and divided by 706 gives the actual horse-power. So,

$$\frac{\text{horse power} \times 706}{\text{height of the fall in feet}} = \text{number of cubic ft. of water required per}$$

$$\text{minute; and } \frac{\text{horse-power} \times 706}{\text{quantity of water in cubic feet per minute}} = \text{height}$$

of all in feet required to produce the horse-power. The undershot-wheel though less efficient is more suitable for level countries like Lower Bengal. If the floats are made curved with their concavity backwards, increased efficiency will be obtained to that which is obtained from flat vanes. The race or channel

should be short in the case of all the wheels, though the tank or reservoir of water should be as large as possible, that the current may be even and uninterrupted. If the stream is constant a reservoir is not required, but a burnt clay-pipe on a masonry channel or race, increases the efficiency of a wheel. When a water-wheel

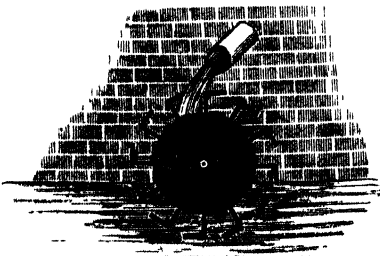

FIG. 9.—THE OVERSHOT WATER WHEEL

is drowned, *i.e.*, when the tail is not sufficiently low to allow the water to run off freely, its efficiency is reduced by about one-fourth. The breast wheel should have buckets instead of floats that by means of the weight of the water in the buckets the wheel may go down more readily, the buckets discharging their contents while going down. Thus constructed breast-wheel may be of the same efficiency as the overshot-wheel which receives the impulse earlier. But the bucket arrangement still further improves the efficiency

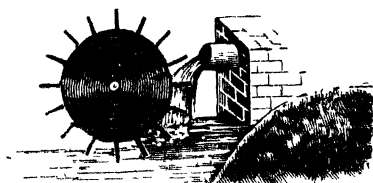

FIG. 10.—THE BREAST WHEEL

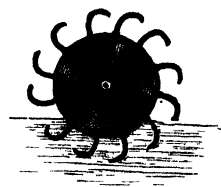

FIG. 11.—THE UNDERSHOT-WHEEL.

of the overshot-wheel. Fig. 9 represents in section an overshot-wheel with the bucket arrangement. Fig. 10 represents a breast-wheel with the ordinary kind of float while Fig. 11 represents an undershot-wheel with curved floats. The lower portion of the wheels should be encased in brickwork in each case, the axle of the wheel resting on this brickwork whence the power is transmitted

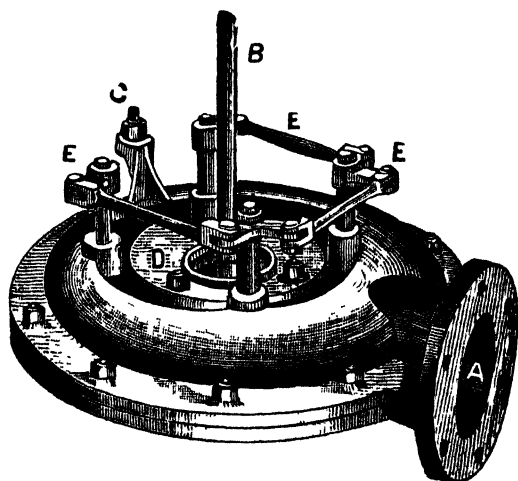

FIG. 12.—THE TURBINE.

to the various machinery worked in the barn. The diameter of the overshot-wheel should be a little less and that of the breast-wheel somewhat greater than the height of the fall of the water.

The *Turbine* (Fig. 12) is a more complicated machine than the ordinary water-wheels, and not being capable of repair in villages it is not so suited for agricultural requirements, though it

will prove far more useful where it can be introduced. It is not necessary to have a very great fall of water to work a turbine, and the wheel occupies very little space. As it can be run with high speed it is better adapted for driving machinery of different kinds. The water is received at the supply pipe (A), whence it is directed by curved guide-blades to the vanes of the wheel which revolves on a pivot. There is a screw arrangement at (C) for raising this pivot. The wheel is rigidly fixed at the bottom of a shaft (B) which communicates the power to the machinery employed. The wheel and the guide-plates are covered by a cast-iron case or shell, and the wheel is kept in an exactly horizontal position by a special cover (D). The guide-blades are also rigidly kept in position by bell cranks and coupling-rods (E.E.E.). The water having expended its force acting on the vanes at different points, passes out of the centre both above and below. The turbine may be placed close to an opening at the bottom of a tank or reservoir of water, or the water may be led by a pipe into the turbine, which may be placed in the barn instead of at the foot of the tank. The velocity of the wheel depends upon the height of the fall. But even with a small fall, the water has to squeeze its way in different directions between the guide-plates until it reaches the vanes of the wheel which it has to move before it can escape at the centre of the wheel above and below. In the figure the wheel inside the case is barely visible to the right of D, but the guide-plates are entirely hid from view.

The advantages of water-power over other forms of mechanical power are: (1) its constancy, (2) its inexpensiveness, and (3) its simplicity. Water-wheels and turbines do not require skill to drive them and they do not readily get out of order. (4) There is also less danger in using this mechanical power than any other. A hurricane may bring down the wheel of an aeromotor; steam may burst the boiler, and the fuel may burn the fire-box. Men and animals also do many kinds of damage, and where their work can be wholly or partially replaced by the mechanical powers, work goes on more smoothly. The importance of having a farm near a flowing stream of water can never be overstated. Water-power is more readily available in hilly districts where differences of water-level within short distances are of frequent occurrence.

**Steam-power.**—Steam-engines, which are employed in farming in highly civilised countries, are of three descriptions, *viz.*, stationary, portable and traction. Multitubular boilers are now in general use. Ordinarily  $2\frac{1}{2}$  to 3 lb. of coal are consumed per horse-power per hour. Low-power stationary engines are useful in farms for dairy purposes, *e.g.*, for steaming food, pulping and grinding and working the centrifugal cream separator. Steam is most essential for keeping dairy-utensils clean and free from germs. Portable engines are in more common use for ordinary farming. These are let out to farmers, who use them for thrashing

and winnowing their corn. The portable engines in general use are of eight horse-power. Traction engines, which are more powerful still, are used for ploughing, etc. They are not yet popular even in England, and we need make no further mention of them here.

**Gas-Engines and Oil-Engines** are worked on the same principle. In each case explosion results in the generation of gases which under ordinary atmospheric pressure occupy more space than the substance which exploded did before explosion. By keeping these gases controlled within a cylinder and preventing their expansion, pressure is generated on the walls of the cylinder. A piston inserted inside this cylinder moves exactly in the same way as the piston of a steam engine's cylinder by force of the steam. Explosion of coal-gas is a well-known phenomenon. In the case of oil-engines an explosive oil, such as kerosene, is used. The oil is vapoured and ignited in the presence of air which is introduced into the vapouring chamber at the commencement of each stroke of the piston,—this resulting in explosion. As oil is far more conveniently carried and stored than coal, oil-engines are getting very popular for use in farms which are usually situated in outlying districts where cartage becomes expensive. The actual expense is also less. In terms of coal an oil-engine consumes an equivalent of less than  $1\frac{1}{2}$  lb. per horse-power per hour against  $2\frac{1}{2}$  lb. consumed by ordinary steam-engines. About one-tenth of a gallon of oil per horse-power per hour is required to work an oil-engine. Oil and gas-engines require less skill in management than steam-engines, and they may be set in motion at less time, but they are, on the other hand, more liable to get out of order, having more little parts where soot may lodge, etc. Where sudden but temporary suspension of work causes great inconvenience, e.g., in electric lighting, steam-engines are found more satisfactory than oil or gas-engines, but in farm operations such occasional stoppage causes no particular inconvenience. Less water also is needed for working gas and oil-engines, as the water is required only for cooling the cylinders. Gas and oil-engines are particularly suitable for intermittent work. In working steam engines time is taken up in getting up steam, and if this has to be done two or three times a day there is waste of resources. Steam-engines are, however, very usefull where the use of steam for heating, cooking, clearing and sterilising is of primary consideration, as in a dairy-farm or a fruit-farm, where jam and jelly are made on the premises. Except for such special purposes, a portable oil-engine is to be preferred to a steam-engine for farm use, where the owner has the means of introducing such forms of power.

**Oil-Engines and Centrifugal Pumps for well-irrigation.**—Mr. A. Chatterton of Madras has been the great exponent in India of irrigation from wells with oil-engines. In Southern India there are many *ranyats* who can afford to have large wells fitted with pumps and



oil-engines at a cost of Rs. 4,000 or Rs. 5,000, but in Bengal such *raiya*t may be said to be non-existent. For ordinary crops also, the outlay for wells and oil-engines cannot be recommended. The Revd. A. Andrew of Chingleput, a prominent supporter of Mr. Chatterton's view, says: "The average value of crops per acre in the *raiya*t*wari* villages of the Presidency, excluding Malabar and South Canara, is only Rs. 30 for rice, Rs. 10½ for *Ragi*, Rs. 10 for *Ch lum*, and Rs. 9 for *Cumbu*. The average for all food-grains is only Rs. 15 per acre, for oil-seeds it is Rs. 22. The average for garden produce is very much higher and more profitable. Chillies bring in on an average Rs. 100; turmeric, Rs. 250; sugarcane, Rs. 200, and tobacco, Rs. 100. It is evident, therefore, that it will not pay to use an engine and pump to raise water for the cultivation of food-grains, but it is quite different with regard to the cultivation of the more valuable crops. With them there is a very much greater margin left for meeting the larger expenditure of running a pump." Even with reference to the more valuable crops (which occupy an insignificant area) Madras people are not convinced from Mr. Chatterton's experiments, that oil-engines and pumps would ever be able to replace the single *mot* except under special circumstances. Experienced planters in the Madras Presidency prefer Worthington's Pumps worked by highly efficient steam-engines to centrifugal pumps and oil-engines advocated by Mr. Chatterton. The maximum result attained at Mr. Andrew's farm with a well 24-ft. wide at the mouth and 23-ft. deep, with a smaller well 15-ft. wide at the mouth and 7-ft. deep, at the bottom of the larger well (which is 23-ft. deep), was that a 3½ h. p. oil-engine and a 3-inch centrifugal pump were able to pump out at different seasons from 67,000 to 100,000 gallons of water per day, at a cost of Rs. 46 to Rs. 60 per month. Twenty acres of land can be kept irrigated with this arrangement, but the initial cost of having this arrangement (which is not mentioned by Mr. Andrew) would be prohibitive for the Bengal *raiya*t.

## CHAPTER XII.

### PLOUGHS AND PLOUGHING.

[Indian ploughs of various sizes and efficiency; Defects of Indian ploughs; Deep ploughing with cheap implements; Improved plough; Principles of improvement; European ploughs swing-and-wheel-ploughs, multiple-ploughs, seeding ploughs, paring-ploughs, sub-soil-plough, double mould-board plough, pulverising-plough, one-way-plough, sulky-plough; Draught, swingle and yoke; The potato-digger, steam-ploughs; Judging of ploughing; English system of ploughing; Calculation of area that may be ploughed in one day; Expert opinions regarding possibility of improving the Indian plough.]

THE Indian plough, consisting of a tongue of wood fitted with an iron tooth, a stilt for holding and a pole for attachment of bullocks, ordinarily works the soil to a depth which varies

much with the district. In Bengal this depth is only from three to five inches. This primitive implement, however, varies very much in weight, size and form, and some are very much more effective than others. The Rungpur and Jalpaiguri ploughs, which are least efficient, scratch only about two inches of the soil, while the heavy Bundelkhand plough, weighing nearly three and a half maunds, stirs the soil to a depth of nine inches or a foot. This latter implement is worked by three pairs of oxen and nine men, and cultivators club together to use one another's bullocks in their fields. The Bihar ploughs generally are heavier and more effective than the Bengal ploughs, and they work the soil to a depth of five inches. The Cuttack and Noakhali ploughs are very heavy and the two sides of their body are shaped like two mould-boards, which give them the appearance of ridging ploughs. The ploughs of Saharanpur, Muzaffarnagar and Meerut districts are shod with a horse-shoe-shaped iron round the edge of the tongue and instead of a small iron tooth, are fitted with a long pointed bar of iron which projects out behind the heel, and which can be forced forward as it gets worn out. The "share" of the Gujarat plough is arrow-shaped and it is fixed on a wooden sole. This share also can be pushed forward as it gets worn out. But the forms of the Indian plough in each province are numerous and in each locality the local plough should be chosen at first in preference to others, as the peculiarity of the local conditions has probably determined the local form. Change may be thought of after sufficient experience has been gained of the local plough.

*The defects of the native plough* are, first, that it has no mould-board, and it cannot in consequence invert the soil; secondly, that it makes V-shaped furrows leaving ridges of unploughed land between, and thirdly, there is waste of power due to rudeness of construction. As a rule also, the native plough stirs the soil to a very slight depth and works only a bigha a day in place of three bighas or more which can be worked with ordinary English ploughs. But this is more the fault of the animals than the plough. Where, as in Gujarat and Nellore, large-sized cattle are used, the native plough is able to get over an acre a day. English or American ploughs make deeper rectangular furrows of wider width, and the upturned soil getting inverted, the grass and weeds get covered up in the process of ploughing. As a rule, European and American ploughs are too heavy and too expensive for India. But a Swedish plough is habitually used in preference to all others in the Nagpur and Saidapet Experimental Farms, and at Sibpur a ridging plough and a turn-wrest-plough are used with a pair of ordinary bullocks. The bullocks of the Central Provinces and Madras being very much superior to Bengal bullocks the use of the Swedish plough is not considered objectionable. For heavy soils the Swedish plough is unsuitable especially for Bengal bullocks, but for light soils it can be tried with success where a better class of bullocks is available. The European double-mould-board-plough or ridging-plough can

be worked with success on *ploughed fields* even by Bengal bullocks. There is some advantage in using this plough, especially on heavy soils, where sowing is to be done on ridges for rainy season crops, or in furrows for the dry season, or where subsequent earthing is done, as in the case of potatoes, ground-nuts, sugarcane and mulberry. The ridges can be split and the earth thrown on the furrows when required, for covering seed-potatoes, sugarcane-cutting, etc., or in the subsequent earthings.

**Deep ploughing** is done with the ordinary native plough as also with superior ploughs, by one plough being passed behind another in the same furrow. Deep ploughing with cheap appliances can be done in another way also. The loose soil stirred by the first ploughing can be gathered in the dry season in two rows separated by 8 or 9 ft. by passing a heavy A-shaped wedge of wood, which may be called the Meagher Dragger (Fig. 13), through the ploughed-up field.

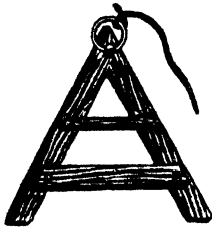

FIG. 13.—MEAGHER DRAGGER.

The driver sits on one of the cross-pieces and puts his legs against the other cross-piece when he is driving the bullocks along. The interval can be ploughed afterwards and the loose soil heaped up on the sides then spread over. This method of ploughing in two layers may be utilized with great advantage in introducing sewage-farming. The sewage-cart may be emptied in a very thin layer in the interval before the loose earth on the sides is spread over it. The deodorising effected is nearly complete.

About two or three months after the spreading of the sewage, if it is done between March and June, the land will be found perfectly inoffensive. The addition of a little lime makes the operation still more harmless. Colonel Meagher of the Allahabad Farm, has introduced a similar system of sewage farming to what is here described.

Of the *improved ploughs*, the plough recently invented by Babu Rajeshwar Das Gupta, of the Eastern Bengal and Assam Agricultural Department, may be mentioned as on the whole the *raiyat's* ideal of an Indian plough. It has a mould-board of wood shaped in the body of the plough, which is otherwise a native plough with a wrought-iron tongue driven into it in place of a share. It works as well at least as the Sibpur plough, though it costs only Rs. 4 in making and it can be made in any country-place. The Meston plough of the United Provinces Agricultural Department is another Rs. 4 plough, which is in some request among cultivators. It is light and very easy to work. It has a mould-board and its depth is easily adjustable. It is useless for heavy soils, as the cast-iron share breaks readily on such soils. The Watt's plough, also issued by the United Provinces Agricultural Department, is stronger and more efficient, but its price is Rs. 7. The Sibpur plough is rather

too heavy for ordinary Bengal bullocks, and its price is Rs. 7-8. Both Watt's plough and the Sibpur plough can be used for ploughing heavy soils. The Sibpur plough is no better than the Watt's plough, and its construction has been suspended by Government.

Jessop and Co.'s "Hindustani Plough," Seeley's "S.S. Plough," the "Kaiser Plough" and the "Baldeo Plough" of the United Provinces Agricultural Department are other improved ploughs that may be mentioned here. The Baldeo plough, which has also a mould-board

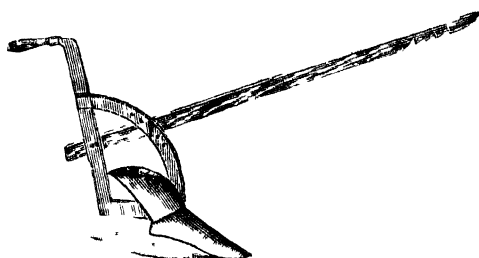

FIG. 14.—THE SIBPUR PLOUGH.

like the other improved ploughs, has been actually sold for Rs. 3 each, but it is too light and inefficient, and it is altogether unsuitable for heavy classes of soil.

The Sibpur plough or the Watt's plough does a little over one-third of an acre a day (eight hours) at the first ploughing and a little over half an acre a day at the subsequent ploughings. The bullocks should be at least high class Bengal bullocks. If the share of this plough is made an inch narrower and the mould-board a little larger and of less abrupt curve, it would answer for ordinary Bengal bullocks. On the whole, it may be said, that none of the so-called "improved ploughs" answer all the requirements of lightness, cheapness and efficiency which the *raiyat* looks for.

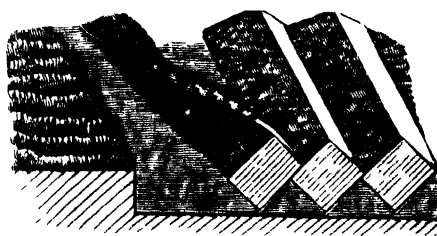

FIG. 15.—RECTANGULAR FURROW-SLICE.

The "improved ploughs" not being provided with a double stilt, the steering of the bullocks can be done by the

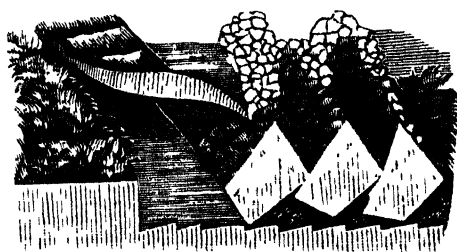

FIG. 16.—TRAPEZOIDAL FURROW-SLICES.

same man who holds down the plough. The Meston plough is so nicely balanced that it needs little effort on the part of the ploughman to hold it down, but, as already said, it is unsuitable for heavy soils. In Agricultural shows, where the trial takes place on *light soil*, the Meston plough attracts the greatest attention

and it commands some sale also among cultivators. The Das Gupta plough, which is of ruder construction, is stronger and more efficient even on heavy soils.

**Principles of improvements.**—As there is no doubt we have not come to the limit of improvement in the manufacture of ploughs on rational principles for Indian *raiya*t, it is necessary to have a clear idea of the principles on which the construction of European or American ploughs is based, and of the character of the chief forms of these ploughs and the methods of using them.

(1) The furrow-slices lifted by these ploughs are commonly rectangular in section (Fig. 15), but they are sometimes parallelogrammatic and sometimes crested or trapezoidal (Fig. 16). The rectangular furrow is the best and ploughs that turn up rectangular furrow-slices are the best, other things being equal. (2) The furrow-slices should be laid evenly at an angle of about  $45^\circ$  to the horizontal. (3) The depth to width should be as 7 : 10 (seven inches being the usual depth and ten inches the usual width of a furrow made by an English plough). The objects of these angles and proportions are to expose the greatest surface to the action of air and to allow the harrow passing through the crests to form a proper tilth and seed-bed. When the width is too great for the depth, the furrow-slices lie flat and the harrow has not the same effect. If the depth is too great for the width, the furrow-slices stand on edge and show a tendency to fall back. (4) There ought to be a coulter to give the vertical cut that the furrow-slice may turn over clean. (5) The mould-board should so gently curve backwards that it will not offer too great a resistance to the soil.

**European ploughs.**—The common forms in use in Europe and America are : (1) the Swing-Plough, (2) the Wheel-Plough, (3) the Double-Furrow-Plough, (4) the Three-Furrow-Plough, (5) the Paring-Plough, (6) the Subsoil-Plough, (7) the Subsoil-stirrer or Subsoiler, (8) the Ridging or Double-mould-board-Plough, (9) the Pulverising-Plough, (10) the One-way-Plough, including

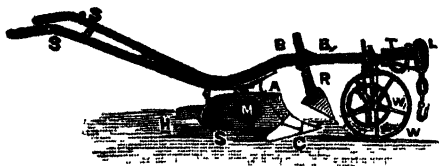

FIG. 17.—THE WHEEL-PLOUGH.

the Turn-wrest or Turn-wrist Plough, and the Balance-Plough, (11) the Sulky Plough, (12) the Potato Digging Plough, and (13) the Steam-Ploughs. We will now shortly go through these that the reader may judge

for himself whether any of these or any portion of these can be introduced with success in this country. As the wheel-plough is practically a swing-plough with wheels put on, the same figure (Fig. 17) will answer for illustrating both the ploughs.

**The Swing-plough** consists of the following parts: (1) The Body (A), or frame to which other parts are fixed. (2) The Sole, Bottom, Slav, or Plough-ground is the part to which the share or cutting part of the plough is attached. (3) The Share or Sock (C) which is often made of wrought-iron, when it can be relayed when damaged. For shallow stony soils shares are made more pointed and slightly bent downwards. It is usually fixed at an angle of  $7^{\circ}$  from the ground to prevent its yielding. For soft or clay-soil the shares are made wider. Shares are sold separately for ten pence or a shilling each. Cast-iron shares are more common and they are harder. (4) The Heel (H) is the posterior part of the sole which the ploughman uses as his fulcrum in turning or raising the plough. (5) The Beam (B.B.) is the front portion of the plough between the Body and the Bridle. (6) The Head (T) is the front end of the Beam to which the Bridle (L) is fixed. (7) The Bridle or Hake (L) by which the depth of the furrow is regulated in the swing-plough. (8) The Coulter (R) or knife which is fixed to the beam and which gives the perpendicular cut to a furrow-slice, slants slightly forwards. It can be easily removed like the share for sharpening or relaying or replacing. For stony soils, coulters like shares are made of wrought iron or steel, but they are ordinarily made of hard cast-iron (chilled iron). The coulter-blade is two and a half feet to three feet wide, and fixed at an angle of  $65^{\circ}$  to the share in wet weather, but at a smaller angle and more forward in the dry weather. Using the plough on fallow ground the coulter should point a little behind the point of the share. The coulter has usually a hole in it from which suspends a chain and a small iron ball which presses down long grass or dung as the furrow is turned, so that these may be better covered. A sharp revolving disc-coulter is used on grass-land or level lawns where there are no stones. (9) The Stilts (SS) terminating in wooden handles to hold by with both hands. (10) The Mould-board (M) is joined on to the right of the body behind the shoulder of the share and it is so modelled that it turns over the soil clean. The mould-board is kept smooth and clean, and not loaded with earth, which would give obstruction in working, and thus add to the draught. (11) The Cheek-plate is just below the land-side of the body, *v.e.*, opposite the mould-board, and it slides against the unploughed land. In the figure this part of the plough is not visible. The *weight of a swing-plough* is three to three and a half maunds and it costs in England from two to three pounds sterling.

The *Wheel-plough* resembles the swing-plough, but it has two wheels (W & W) attached to the beam (B) by means of two sliding bars or uprights coming down from the beam. One of the wheels (W), called the furrow-wheel, marches along the bottom of the furrow and the other (the smaller one), called the land-wheel (W), along the unploughed land to keep the plough in position. The lower end of the larger wheel should be adjusted at the same level with the sole. If one wants to make the furrow an inch deeper

than one has been getting, one raises the land-wheel (*i.e.*, the small wheel) an inch, and if one wants to make the furrow an inch shallower he sinks the small wheel an inch down. In the case of the swing-plough the experienced ploughman adjusts the depth by raising or lowering the bridle. The beam in the case of the wheel-plough is a little curved towards the furrow side, and the line of draught is a little higher than in the case of the swing-plough as the depth is automatically adjusted by the difference between the diameters of the two wheels. There is usually a second coulter called the skim-coulter in front of the ordinary coulter which skims dung, etc., and spreads them out. The wheel-plough, though heavier in weight and costlier, is lighter in draught and it is easier for the man also to work it. Shallow ploughing can be done more easily with the wheel-plough, which regulates depths to a nicety than with the swing-plough. The swing-plough requires to be handled by expert ploughmen. But there is waste of time in adjusting the depth in the case of the wheel-plough. In the hands of a good ploughman the swing-plough works at different depths with sufficient evenness for all practical purposes. Then the wheels get clogged in wet weather; and for steep and rough (*i.e.*, stony) soils the wheel-plough is unsuitable. The cost of a wheel-plough is also prohibitive for our cultivators, though where the land is suitable and where the workmen are not clever, the wheel-plough comes cheap in the long run. Besides, the wheels with the axle-bars and uprights may be taken off and the plough used as an ordinary swing-plough. A swing-plough of very much simpler construction but containing all the essential parts, *i.e.*, the share, mould-board, coulter and an adjustable bridle, ought to be introduced into this country. The advantage of the wheel-plough over the swing-plough in traction is ten to fifteen per cent. In the swing-plough the share and the coulter absorb forty-four per cent. of the friction or resistance, the sole, fifteen per cent., the cheek-plate, thirty five per cent., and the mould-board, six per cent. The directions of resistance are in three planes: (1) the perpendicular resistance which passes through the plough nearer the land than the furrow side; (2) the horizontal resistance which is along the sole-plate; and (3) the curved resistance which follows the course of the outer surface of the mould-board.

**Draught.**—The weight of the plough in the case of European and American ploughs contributes from thirty-four to fifty per cent. of its draught. The shape of the mould-board also affects the draught considerably, but the depth and width of the furrow and the nature of the soil chiefly influence the draught. A long and gradually curved mould-board offers the least resistance, a point which is generally overlooked in the construction of improved ploughs for India. Dry clay-soil offers very strong resistance, if the mould-board is not of the right shape. The draught of ploughs, harrows and other implements is *measured* by the dynamometer which is only a spring-balance of a special construction.

The draught of Madras ploughs has been found to vary from 280 to 390 lbs. Some experiments conducted at the Cawnpore Farm showed that draught of ploughs for up-country bullocks should not exceed 126 lbs. Madras bullocks are very much superior to up-country bullocks, and these latter are somewhat better than Bengal bullocks. The draught of a plough in Bengal should not exceed 100 lbs. The draught on fallow-land is considerably higher

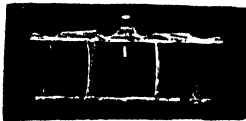

FIG. 18.—YOKK WITH BREAST-BEAM AND CROSS-PIECES.

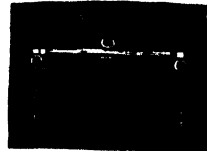

FIG. 19.—SWINGLE FOR ONE ANIMAL.

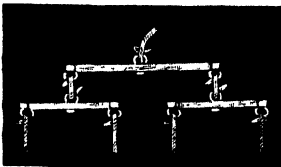

FIG. 20.—SWINGLE FOR TWO ANIMALS.

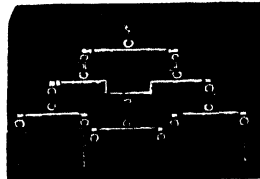

FIG. 21.—SWINGLE FOR THREE ANIMALS.

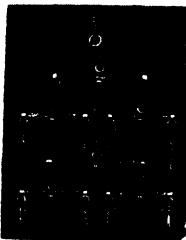

FIG. 22.—SWINGLE FOR FOUR ANIMALS.

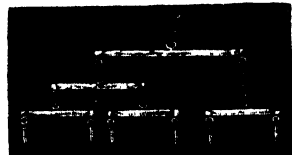

FIG. 23.—SWINGLE FOR THREE ANIMALS.

(Another pattern.)

than that on tilth, and it is therefore easy with a country or an improved plough to plough half an acre a day when ploughing for the second or third time, though it is difficult to do one-third of an acre at the first ploughing. With a wheel or swing-plough and even with South Indian ploughs as much as one acre can be ploughed per diem. With an ordinary pair of Bengal bullocks and with a light draught of 100 lbs., eight hours' work can be got out of the bullocks. If the draught is 200 lbs., one pair of bullocks should work for four hours, or two pairs for eight hours.

As the draught for ploughs used in Bengal should not exceed 100 lbs., and as the dead-weight of a plough properly constructed should account for only 34 to 50 per cent., or say about 40 per cent., of the draught, the ordinary swing-ploughs



or wheel-ploughs, which are over 300 lbs. in weight, are clearly unsuitable for use in Bengal, though a strong pair of bullocks can work the plough for a few days or only for a few hours at a show-yard, to apparent satisfaction. But by adding to the number of animals or giving them work for a shorter time, implements with heavy draught can be used.

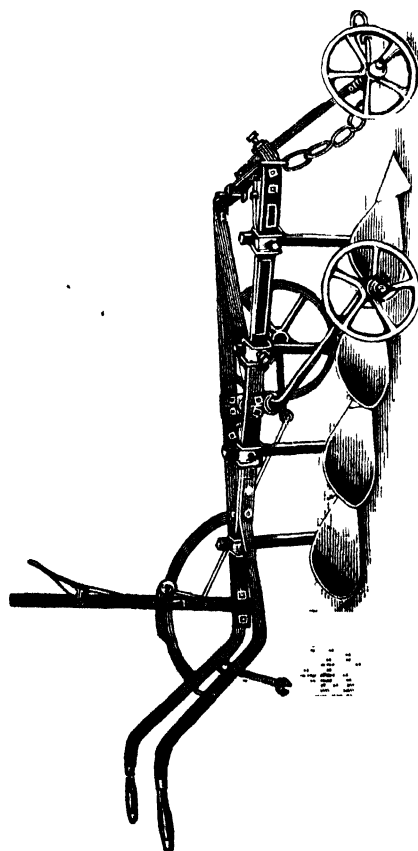

FIG. 24.—MULTIPLE-PLOUGH

*Swingles and Yokes.*—A plough or any other cultivating implement is attached in European countries to horses or bullocks by means of a swingle or whipple-tree or trees, and ropes or chains. The yoke to which the further ends of the chams or ropes are attached may be only a single piece of wood going across the necks of the animals, or the traction at the hump may be lightened by having another piece of wood for the chest with cross-pieces to keep the two in position. The chain or rope to which the whipple-tree is attached is called the draught-rope. The yokes are made of wood of the aerial roots of bar-tree or other light and strong wood having curved notches for the necks of the animals. Yokes furnished with breast-beams (Fig. 18) are used in some provinces. These distribute the resistance to a greater surface and thus lessen the occurrence of yoke-galls. The Bengal method of

yoking on two sides of a long pole rigidly attached to the plough has the advantage of simplicity and cheapness. It does away with the necessity of reins also, bullocks being guided by a touch or twist of the tail with one hand, while the single stilt is held by the ploughman by the other. The improved ploughs recognise the advantage of this simplicity and cheapness. Figs. 19, 20, 21 and 22 illustrate the method of attachment of one, two, three and four animals, respectively, to an implement. (Fig. 23) illustrates another method of attaching three animals.

*Multiple-ploughs.*—Two furrows are turned simultaneously with a two-furrow plough instead of one. The draught is therefore much greater, and three horses are required to drive this plough. Having a wider bottom it does as even and steady work on level soils free from stones as the wheel-plough. There are no side-plates or sole in this plough, and it does not therefore form pans. For preparing seed-bed on ploughed land, two horses can easily manage this plough. It does twice as much work as the wheel or swing-plough. The three-furrow plough turns three furrow-slices at the same time, each nine inches wide, and it can plough three or four acres of land per day if the soil is light. Having a wide bottom, the draught is very heavy, and four horses are required for drawing it. The price of the double-furrow plough is £7 to £10, and of a three-furrow plough as much as £12, or even more. These ploughs are altogether unsuitable for most Indian needs.

While referring to multiple-ploughs, however, may be mentioned the *seeding plough* of Messrs. Hornsby & Sons, Grant-ham (England). This implement can be used either with or without the seed-box. Without the seed-box (Fig. 24) it may be used for simple ploughing (three or four inches deep only), or for covering the seed after it has been broadcasted. It can be regulated to any depth up to four inches and in width to six and a half inches for each furrow. It is well within the power of a pair of light horses to do the work, as it is carried on three wheels. Best chilled iron is used for the shares, and all the wearing parts are easily renewable. Equipped with the seed-box (Fig. 25), it sows the seed directly into the furrow efficiently, covering it at the same time. The quantity of seed sown per acre is controlled to a nicety by

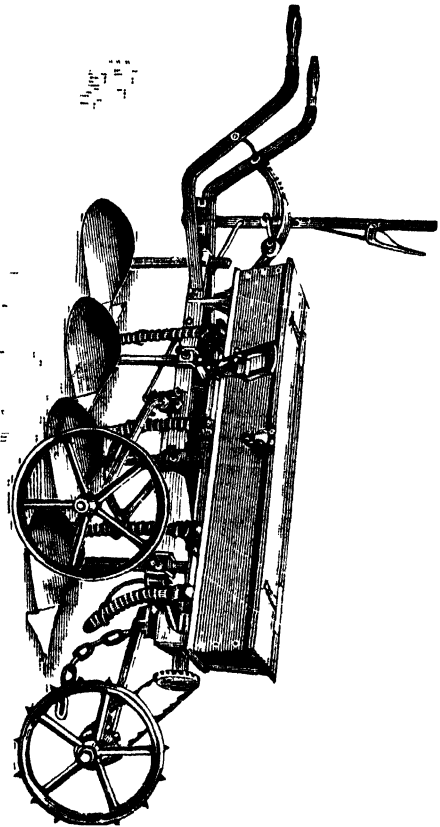

FIG. 25.—SEEDING PLOUGH

the simple movement of an indicating lever. The four-furrow improved seeding plough with seed-box and conductors complete is priced at £7. This plough used, not for the first ploughing but for subsequent operations, and specially for sowing, may have a very important future before it, if capitalists go in more largely for agriculture in this country.

*The paring plough.*—The paring plough is an ordinary wheel-plough fitted with a share twelve inches broad. It is used for doing very shallow work, and the wheels are adjusted so as to turn up slices one or two inches deep. The Deccan Bakhar (Fig. 26) can be used as a paring plough, either for stifle-burning sods or preparing a seed-bed on ploughed-up land which is fairly dry. The Bakhar does not work in wet clay-land for preparing a seed-bed. For ploughing wet fallow-land two or three inches deep, for destroying weeds, and for preparing a fine tilth on fairly dry soil, the Bakhar is an invaluable, though inexpensive, implement. The knife of the Bakhar is made about two feet long, and with a pair of strong bullocks one can prepare two to three acres of land for tilth, and at the same time destroy the weeds.

The *subsoil plough* is like an ordinary single-furrow plough, but of stronger construction, having a deep body and a large mould-board. It is used behind an ordinary swing or wheel-plough along the same furrow, and it turns up the subsoil. It may often be of advantage in deep soils in some of the drier Indian tracts.

The *subsoil-stirrer* or sub-soiler (Fig. 5) moves the subsoil without turning it up. This is also used behind an ordinary plough. It has no mould-board and it can hardly be called a plough. It

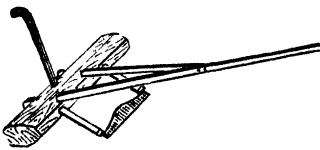

FIG. 26.—THE BAKHAR.

moves the soil twelve to eighteen inches deep. A subsoil-stirrer is sometimes attached to a strong wheel-plough on the right side and in a line with the point of the share. It passes along the bottom of the furrow raised and moves it. A subsoil plough on wheels adapted for light soils costs from £7 to £11 according as it is required for light or very heavy soils.

The *ridging or double-mould-board plough* (Fig. 2) is made like a swing or a wheel-plough. It has a mould-board on either side, but no coulter. The mould-boards are shorter and nearly flat. It is used for making ridges and splitting them, also for splitting drills for sowing turnips, potatoes, etc. A marker is hinged on to the beam of the ridging plough. It marks on the ground the line where the next ridge is to be. The marker is held in position by a chain. By another chain behind, the ploughman can turn the marker on either side of the plough. The cost is £4 and £1 extra for wheels. It has been already shown how a native plough can be used as a ridging plough.

The *pulverising plough* breaks up but does not turn over furrows. The Indian plough and the sub-soiler may be regarded as pulverising ploughs, and the improved ploughs as simple swing-ploughs.

The *one-way plough*.—With an ordinary plough ploughing cannot be done line after line in succession, as the slices are turned one-way during the forward march and in the opposite way during the return march. The whole of the land cannot in this way be both ploughed and turned over. With the one-way ploughs, of which one form is called the turn-wrest or turn-wrist plough, and another the balance plough, furrow-slices are all laid side by side one against another in the same direction, avoiding open unploughed furrows and ridges covered by furrow-slices. There are two sets of mould-boards and shares in the balance-plough. When one set is at work on one side, the other set is kept raised on the other side. At the end of the field the position is reversed, the set which was kept raised being now brought into action, and the plough is turned in the ordinary way as a carriage is turned. In the turn-wrest plough there is only one set of share and mould-board which are reversible round a hinge, while in the balance-plough there are two sets. In ploughing hill-sides the ordinary system of ploughing round and round a field is unsafe, as the bullocks are liable to go down a precipice or get choked with the ropes with which they are attached to the yoke. It is safer in hill-side ploughing to take line after line in the lateral direction only. If cross-ploughing is done at all, the bullocks should not be made to plough up-hill, but simply walked up, and the down-hill ploughing, if no terraces have been made, should be done with the greatest care. Turn-wrest ploughs have now been extensively introduced into India, and are used in large numbers on the Deccan and in Gujarat. The most popular is one made by Messrs. Ransome, Sims and Jefferies, of Ipswich, which is named by them “C. T. 2” and costs Rs. 40 in Bombay. This is suitable for the heavy soils of the Deccan. Local manufacture of a very similar plough has been undertaken, and Messrs. Kirloskar Bros. of Kundal Road, Satara District, in the Bombay Presidency, are doing a very extensive trade in the plough they make. In the tracts named, the turn-wrest plough is no longer an experiment, and is rapidly displacing the country plough.

The *sulky plough* is used in American prairies. The ploughman sits and drives and covers five acres a day, two furrows three or four inches deep are turned over at the same time. It is driven on light, but strong, wheels almost as fast as a carriage is driven. For perfectly level prairie land it is a very useful kind of plough.

The *potato-digging plough* is fashioned like an ordinary plough ; but it has two shares, one behind the other, both elevated posteriorly and divided or forked. The shares are driven in underneath the ridges to turn out potatoes. The *Potato-digger* by Story & Son of Jedburgh, Howard, and other makers, is not exactly a plough.

It consists of a strong framework run on four wheels, the two front ones being smaller than the hind ones. A broad sharp share passes underneath and lifts the potato-ridges, while a set of 8 revolving forks working at right-angles to the ridges above the share is worked by the hind wheels. This is put on or off gearing at will. It throws as the digger advances all the earth and potatoes from ridges on land that has been cleared, against a screen which keeps them from spreading far and wide. This bruises the potatoes to a certain extent, but when a canvas screen is used hardly any loss occurs. Potatoes are gathered carefully each time, else they get covered up. When potatoes do get covered up, they can be harrowed up again, but constant knocking about, especially with harrows, reduces the value of potatoes and makes them liable to putrefaction. On light land two horses can work the potato-digger, but on heavy soil three are required. Four acres can be dug out in a day. The cost of a potato-digger is £12 to £13. On heavy or wet soil it does not work satisfactorily. The work done by a potato-digger leaves the soil beautifully fine and mellow and free from weeds. The remains of the weeds and potato-haulms can be easily raked off and the land used immediately afterwards for growing sugarcane, maize, *jowar*, ground-nut or *arahar*. The potato-digger can be used also for digging out ground-nuts and yams of different kinds. The implement is unsuitable for the Indian *raiyat*, but a capitalist going in for growing potatoes or ground-nuts on a large scale will find a great saving on the cost of hand-picking. Four strong bullocks must, of course, be employed attached to a proper swingle. The Hunter-hoe has been employed with advantage for lifting potatoes at Sibpur.

*Steam ploughs* have been found unsuitable for most Indian surroundings. They have been tried by Mr. Archie Hills, of Patkabari (Dt. Murshidabad), and by Mr. Armstrong, of Dehra Dun, and others. Skilled supervision and the first outlay cost more in India than in England, and the advantage of the steam plough over the horse-plough even in England is only as 10 : 9. Where Englishmen have taken to farming on a large scale, *e.g.*, in the Fiji Islands, and where labour is dear and labourers scarce, steam ploughs are found of great use. At the first ploughing, the furrows are made twelve inches deep : at the second ploughing fifteen inches, and at the third ploughing eighteen inches, and thus the ground is disintegrated in a far more thorough manner than is possible with any other plough. In some parts of India, where the land is badly infested with deep rooting grasses which cannot be ploughed out by the ordinary plough, it is more than probable that the steam plough will be found of very considerable value.

If one were asked to judge a competition in ploughing, one should mark the following points :—

(1) Whether the furrow-slices are clean-cut on the land-side and the bottom.

(2) Whether they are laid regularly and compactly one against another at an angle of 45°.

(3) Whether grass, stubbles and weeds are turned in and covered.

(4) Whether the upper edges of the furrow-slices are on a level, so that an even seed-bed may be formed by harrowing.

(5) Whether furrows are straight and finished regularly at the ends.

(6) Whether the last furrow-slice is properly turned out and about the size of the rest.

(7) Whether the depth has been regulated according to the nature of the soil and the crop to be grown and for the time of the year, four inches to nine inches being the limit for this country.

(8) Whether the proportion between depth and width of the furrow-slices turned over is as 7 : 10.

To understand the *English system of ploughing*, it is necessary to comprehend a number of technical terms. These are : (1) Crown, (2) Open-furrow, (3) Gathering, (4) Splitting, and (5) Feering.

(1) The 'Crown' is the highest line of the ridge, running up the middle of one unit of a field under tilth, all the furrow-slices sloping up towards it.

(2) The 'Open-furrow' is the depression between two ridges, the furrow-slices slanting away from this.

(3) 'Gathering' is the name given to the system of ploughing in which the horses always turn towards the crown. When ploughing round and round by 'gathering' goes on in a field for some years, the field begins to have a wavy appearance, the hollows being 'open-furrows' and the elevated portions, 'crowns.'

(4) 'Scattering,' 'Splitting' or 'Scaring' is the name given to the system of ploughing in which the horses always turn away from the crown.

(5) 'Feering' is the marking out of land for the first time into sections, or units of tilth, by means of 'feering poles,' indicating where the future 'crowns' are to be. The width is fixed upon by the foreman or the first ploughman, a width of either 33ft. or 66ft. being chosen. Narrow width (16½ft. or 33ft.), involving close ridges, is best suited for stiff clay-lands inclined to be wet and which are benefited by surface-drainage. A feering-pole is 8½ft., that is to say, half a perch in length. Four or more feering-poles are used when a field is brought under plough for the first time or where no ridges and open furrows are observable for some reason (*e.g.*, after harvesting a green crop); or where the old ridges are not to be kept up. In very old fields which have been long under the plough, lines of the old 'open-furrows' are followed, to replace them by 'crowns,' 'gathering' being done round and round the 'open-furrows' instead of the crowns. This serves to keep the crowns down as low as possible. The two first slices are also cut thinner than the rest to keep down the crown.■

**Method of ploughing.**—It is along the future crown that the feering-poles are set up. The line along the poles is first ploughed

up to get all the land moved, the first one way and then in reverse way, so that a double furrow is left at the crown and the two slices turned, one, one way, and the other, the other way. In setting up the feering-poles, half the distance desirable between two ridges is measured from the end of the field, and the feering-poles set along this distance. The line along the poles is ploughed as described, and then the poles removed to the full distance between two ridges. This line along the poles where they are removed is also marked out by the plough as above, and the poles removed to the full distance between the ridges again, and the operation repeated until the whole field has been marked out. The ploughing is done round and round these lines by gathering. The horses turn at the headlands, which should be fairly broad, that no difficulty may be experienced by horses in turning at the ends of the fields. If headlands are left on all sides, these may be ploughed up afterwards by driving the plough round and round the field away from the fences and not towards them. When feering-poles are set up at the full width between ridges to start with, ploughing is done by splitting. With an 8½ft. staff, 66ft. or 33ft. may be easily measured, and an acre being 660ft. × 66ft., these widths are convenient for making mental calculations as to area. Light soil should not be made too wavy by ploughing. Sections of 132ft. may be taken for each gathering on such soil.

**Principle of calculation.**—A man ploughing an acre and turning over furrow-slices only an inch wide, would turn over 99 miles of furrow-slices (*i.e.*,  $\frac{660 \times 66 \times 12}{1760 \times 3}$ ). If he ploughed 12 inches wide he would cover one-twelfth this distance, *i.e.*, 8·25 miles. If he ploughed up slices six inches wide he would cover 16½ miles in a day if he succeeded in doing one acre. With an ordinary country plough, or with an improved plough the utmost width obtained is six inches. A third of an acre, which involves a walk of over five miles while working, may be considered a good day's work for a ploughman and bullocks, at least for the first ploughing. Attempt should be made to get the ploughman to do at least five or six miles of walk per day while ploughing. To get the number of miles walked in ploughing an acre, it is only necessary to divide 99 by the breadth of the furrow (in inches) turned out by a particular plough. With ploughs of different widths of share turning out different widths of furrow-slices, the ploughman should show different quantities of work.

**Expert opinions.**—With regard to the possible improvement that may be introduced into the ordinary system of ploughing, etc., in India, the following remarks of Dr. J. A. Voelcker, recorded in his report on the improvement of Indian agriculture, are worth noting :

“I cannot help suspecting that the system of shallow ploughing, as practised by the native, and his aversion to ploughs that turn over a broad slice and form a wide furrow, may have something to do with this matter of the retention of moisture, and that the

effect of deep ploughing would too generally be to lose the very moisture the cultivator so treasures." --(P. 43).

"After seeing for myself what is used, and what have been suggested for use, I am obliged to conclude that there is not much scope for improved implements under existing conditions." --(P. 217).

"Even if a thing be good in itself, patience, perseverance and energy are required to make the native comprehend its advantages, but when once he is thoroughly convinced of its utility he will not be slow to follow it up. It took several years of waiting before the Beheea sugar-mill began to make its way, but when once it was introduced into a district the demand for it often exceeded the supply." (P. 217).

With regard to the relative merits of Watt's plough and the country plough, Dr. Leather says: "At Cawnpore an improved plough having an iron share, and ploughing five inches deep, has been tested against the country plough since 1881. Six years' experiments, during four of which they were made in duplicate, showed, with one exception, a distinct increase in the cotton crop; and eight years' experiments, of which seven years were in duplicate, and in which wheat was the crop, showed, with one exception, an increase apparently due to the improved ploughs. Leaving out of consideration the actual increase obtained which varied considerably, it must be remarked that assuming no effect on the crop there is still a saving of half the labour. The improved plough is drawn perfectly well even by a small pair of bullocks, and the number of ploughings necessary is reduced to half."

With regard to the relative merits of the country plough and the Sibpur plough, the following remarks of Mr. B. C. Basu, regarding the experiments conducted at the Dumraon Farm, deserve attention:—

"To compare the soil-inverting, with the country plough, two plots, each 800 square yards (a little over five local cottahs), were ploughed up and both cropped with wheat, and treated exactly alike in all other respects. The cost of cultivation was the same in both plots. The increase in outturn obtained by means of the inverting plough over the outturn obtained with the country plough is shown below:—

| YEAR              | GRAIN PER ACRE. |           | STRAW PER ACRE |           |           |           |           |           |
|-------------------|-----------------|-----------|----------------|-----------|-----------|-----------|-----------|-----------|
|                   | Increase.       |           | Decrease.      |           | Increase. |           | Decrease. |           |
|                   | Mds.            | Srs.      | ..             | ..        | Mds.      | Srs.      | Mds.      | Srs.      |
| 1885-86 ..        | 2               | 16        | ..             | ..        | 3         | 21        | ..        | ..        |
| 1886-87 ..        | 1               | 14        | ..             | ..        | 1         | 8         | ..        | ..        |
| 1887-88 ..        | 1               | 35        | ..             | ..        | ..        | ..        | 0         | 14        |
| 1888-89 ..        | 1               | 4         | ..             | ..        | 1         | 35        | ..        | ..        |
| 1889-90 ..        | 2               | 4         | ..             | ..        | 4         | 16        | ..        | ..        |
| 1890-91 ..        | 0               | 30        | ..             | ..        | 0         | 19        | ..        | ..        |
| <b>AVERAGE ..</b> | <b>1</b>        | <b>24</b> | <b>..</b>      | <b>..</b> | <b>2</b>  | <b>10</b> | <b>..</b> | <b>..</b> |



“The effect of soil inversion was equally conspicuous on paddy. The trial with this crop was carried out exactly in the same way as with wheat. The results are shown in the following statement :—

| Year.   |    |    | Increase of grain per acre. |      | Increase of straw per acre. |      |
|---------|----|----|-----------------------------|------|-----------------------------|------|
|         |    |    | Mds.                        | Srs. | Mds.                        | Srs. |
| 1886    | .. | .. | 1                           | 6    | 9                           | 16   |
| 1887    | .. | .. | 0                           | 35   | 2                           | 38   |
| 1888    | .. | .. | 1                           | 8    | 2                           | 8    |
| 1889    | .. | .. | 3                           | 1    | 6                           | 2    |
| 1890    | .. | .. | 0                           | 24   | 3                           | 20   |
| AVERAGE |    |    | 1                           | 15   | 4                           | 33   |

The following remarks of Mr. J. Mollison, taken from Vol I, p. 135, of his Text-book on Indian Agriculture, are also worth serious consideration : “To those who are sceptical I can show in parts of the Bombay Presidency cultivation by means of indigenous tillage implements only, which in respect of neatness, thoroughness and profitableness cannot be excelled by the best gardeners or the best farmers in any other part of the world. This statement I deliberately make, and I am quite prepared to substantiate it.”

### CHAPTER XIII.

#### OTHER CULTIVATION APPLIANCES.

[The Grubber or Cultivator (the Madras Grubber); the Harrow, the Hand Rake; Seed drills; *Nari-nagar* with *Surtha*; Hoes; Bullock-hoes; Hand Weeders; Scythes; Threshers; Winnowers; Hausor's Grain cleaner.]

**The Grubber.**—*The ordinary cultivator or grubber* is a simple enough instrument for Indian use. A five-tined grubber with duck-foot coulters, mounted on two wheels can be easily worked by two bullocks on land already ploughed and reploughed, once one way and the second time across. The advantage of using the grubber consists in the fact that it stirs the soil to a varying depth of five to nine inches uprooting and dragging weeds and coarse grasses before it. It stirs the soil deep without turning it up. The practice of smashing up land by cultivators, instead of systematically ploughing it, has greatly increased in England of late years, and we can take the hint in this country. The grubber used in the Sibpur Farm (Fig. 27) can be easily made in country places in India, and the cost need

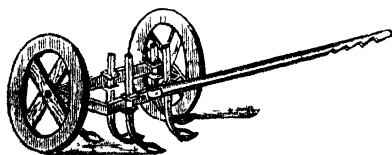

FIG. 27.—THE GRUBBER.

not exceed Rs. 20. The price of the 'Madras Grubber' is only Rs. 17. For early preparation of land for *rabi* crops, for which quick, and at the same time deep, cultivation is desirable, the grubber is an invaluable implement. It forms no pans. Grubbing should not be done in the *kharif* season, when opening up the soil too much results in too much loss of fertility by washing.

**The Harrow.**—These are either rectangular (Fig. 28) or cylindrical. The frame of the rectangular harrow is several feet wide and long. It is usually divided into two or three sections carrying equidistant teeth, usually eight to ten inches long, which serve to break the surface clods after the plough or grubber has been used in order to bring up clods to the surface to be afterwards smashed up by the roller, and to detach weeds from land which has been stirred. It is also used after the seed has been sown to cover it.

Chain harrows, constructed as a coarse coat of mail, are composed of plain, circular, or polyhedral rings, toothed rings and tripods, the latter connected by rings or links, the teeth being longer on one side than on the other, so that either surface of the harrows can be used as the nature of the land or meadow requires. They are serviceable for light action, as when seeds require to be lightly covered or when manures require to be spread on grass land. The ladder, or beam, or levelling board, used in this country takes the place of harrow, but the latter is a far more efficient implement, especially for uprooting weeds, and the lighter kinds can be used with bullocks. Heavy circular harrows, such as the cross-kill roller or clod-crusher, are unsuitable for this country on account of their cost and heaviness except in preparing the land on very hard soils like those of the Deccan for very valuable crops like sugarcane; but as even a chain-harrow would cost Rs. 40, the question of replacing our beams, ladders and *bidias* by harrows may be dismissed for the present. Iron-toothed harrow, called *bidias*, are in common use in India, and under existing circumstances it is hard to replace these. Steel hand-rakes (Fig. 29) may be used like *bidias*. A 15-teeth garden rake would cost only about Rs. 3.



FIG. 28.—THE HARROW.



FIG. 29.—HAND RAKE.

**Rollers** are useful for obtaining a level and compact seed-bed in which moisture is better retained. But they are too unwieldy and expensive for Indian use. Levelling boards and beams are in common use, especially in South India, and they answer the purpose fairly well. But a light wooden roller would be preferable.

**Seed Drill.**—When the soil has been prepared by ploughing (and cultivating or grubbing in the *rabi* season), harrowing and levelling, it is ready for sowing. Sowing is done either by scattering the seed broadcast, or by drilling, or by dibbling. By dibbling the greatest economy of seed is effected, but it is a slow process, and if the seed is not perfect and germination is partial, too many blanks may be left. Dibbling is sometimes done when large-sized seeds, such as *araha*r, maize and cotton, of reliable germinating quality, are sown, two in each hole. Smaller seeds should be either broadcasted or drilled. Broadcasting in experienced hands does not involve much waste of seed, nor irregular sowing, and it is the cheapest way of sowing. But drilling is the most desirable system as it does not require an expert hand, and as its application enables one to employ afterwards

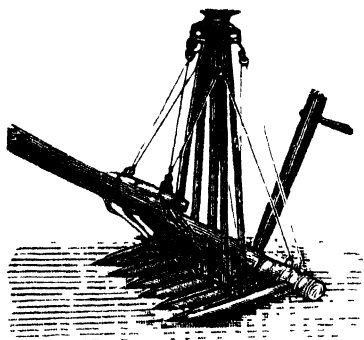

FIG. 30.—MADRAS SIX-TINED SEED-DRILL.

the bullock-hoe and hand-wheel-hoe, saving cost of weeding, and enabling one to keep the land stirred and aerified. The English and American seed-drills with eight or twelve tines would be too expensive, as the arrangements of these drills are too elaborate. The Madras three-tined and six-tined (Fig. 30) Seed-drills and the *Surtha* or *Tari*, a seed-drilling

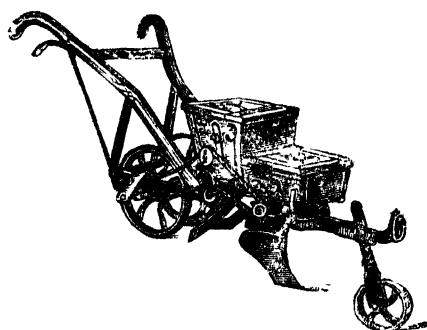

FIG. 31.—HENDERSON CORN PLANTER AND FERTILIZER DISTRIBUTOR.

bamboo cylinder with a funnel-shaped hopper at the top, fixed to a hole in the body of the plough, called *Nari-Nagar* in the Central Provinces, are adapted for the existing stage of Indian agriculture. When seeds for a mixed crop, such as *araha*r and cotton or *jowar* and *araha*r, or maize and cotton, are drilled, the hopper of a three or six-tined seed-drill with one hole stopped is fed by one person, while a *Surtha* dragged behind is provided with wheels the Native seed-drills require experienced plough-bullocks and ploughmen to work them, and it requires long patience to introduce them successfully in a new locality. On the whole, perhaps, the one-furrow garden drills of American make (Fig. 31) have the best prospect of success in India.

Some of these hand-drills are fitted with two boxes, one for holding seed and the other for some concentrated fertilizer, such as super or sulphate of ammonia, etc. Fig. 31 illustrates the Henderson Corn Planter and Fertilizer Distributor. One can sow with this three acres of land per day, dropping the seeds at any distance apart and sowing at the same time, if needed, any kind of pulverized fertilizer. Each machine is furnished with four dropping rings and pinions to regulate the number of seeds and distance apart of sowing. Extra rings are also supplied for sowing peas, beans and other special sized seeds. The price with the fertilizer box is eighteen dollars, each extra ring costing twenty-five cents. Without the fertilizer box, the price of the Henderson Corn Planter is only fourteen dollars in New York. Planet Jr. Seeder No. 5 (price twelve dollars) is also recommended.



FIG. 32.—AMERICAN HAND HOE.

**Hoes.**—When seed has been sown and the young plants have come up, one hand-weeding with *khurpi*s is necessary for most crops. Afterwards the soil between the rows of plants should be kept stirred and clean as often as convenient,—say once a fortnight or once a month, according to circumstances,—until the plants are about eighteen inches high. Two or three hoeings give the crop a very good start and the land is also left clean. With an American wheeled hand-hoe (Fig. 32), one can easily work one-third of an acre a day. With a bullock-hoe (Fig. 33), however, one acre a day can be done. The use of the hand-hoe or bullock-hoe presupposes the use of a seed-drill. The Planet Jr. hoe (Fig. 32) may be used as a seed-drilled or hilling plough, or rake, by substituting one working part by another. The various working parts that can be substituted for the hoe are shown in Fig. 32. A hand-hoe of the American pattern can be constructed for less than Rs. 10. The essential parts are: (1) four curved tines screwed on to (2), which is a bar with a slit in the middle, along which the tines can be arranged close together, or somewhat apart from one another, according to the width of the drill, (3) a wheel going in front of the tines which serves as a guide, and (4) a double handle for the labourer to push the implement with. If instead of four tines only

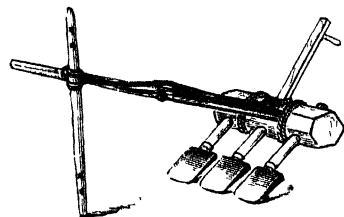

FIG. 33.—MADRAS BULLOCK-HOE.

one tine is used, or two tines at the two extremities of the slit, the furrow, or the two furrows made by the implement, may be sown with seed by a man walking behind who can cover up the furrows with his feet as he walks along. Planet Jr. hoe with two wheels has an arched bar instead of a simple straight bar with a slit. This goes over the young plants, while the tines on the two sides open up the soil. This is a more costly implement than the single wheel-hoe.

The Madras or Central Provinces *bullock-hoes* cost only Rs. 5 or Rs. 6. They require trained bullocks to work these hoes straight. There is always a little damage done by the feet of cattle. The cattle must, of course, be muzzled. The use of the

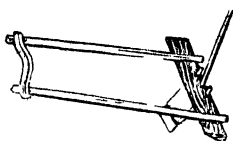

FIG. 34.—THE C. P. DUNDIA

hand-hoe is accompanied by no loss if the rows and lines are regular. Where the distance between the rows of plants is sufficiently great a Dundia (Fig. 34), which is a Central Provinces bullock-hoe with a single knife may be used. But the combined hoe and rake (Fig. 35) which is used in the vineyards of France is a more effective instrument for this purpose. For hand-weeding, besides ordinary *khurpies* and *nranies*, certain special forms of weeders (Fig. 36) called Eureka Weeder, Hazeltine Weeder and Excelsior Weeder have been found very useful.

Mowers and reapers are unsuitable for many kinds of Indian farming. The machines are too heavy and expensive and the fields

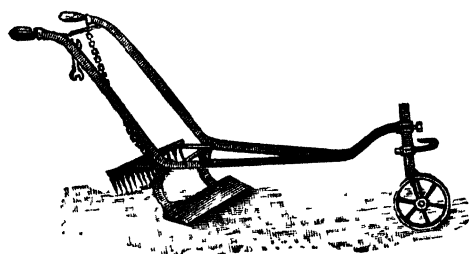

FIG. 35.—FRENCH COMBINED HOE AND RAKE.

in India are often too small. Labour being cheap, the harvesting sickle must hold its own in most places for a long time to come, as the cost of harvesting is comparatively small. But there is no reason why our labourers should not be trained to use the scythe, which does far more work than the reaping hook (*kachhi* or *kastia*).

**Threshers.**—Steam threshers are unsuitable for Indian husbandry. But hand-threshers could be introduced with success by middle-class men wishing to launch out in farming. Even flailing is a better mode of separating the grain from the straw than treading the corn out by bullocks. The bullocks voiding excrements on the straw and grain they tread upon, the system is decidedly objectionable. Instead of flails with wooden handles and leather thongs flails could be improvised of green bamboos about 8 feet long, 1½ ft. of which can be left cylindrical for the handle

and the rest made semi-cylindrical and cut into three strips. Only the ears of grains should be gathered and the heap of ears beaten with 3 or 4 flails by as many men and the heap stirred and formed again and again and beaten upon, until separation of grains from the ears is complete. Beating bunches of straw with grain on boards is another clean and simple method of threshing which is in vogue in some parts of this country. But with the flail work is executed faster and it can be applied to all sorts of crops, including pulses, for which the beating board is unsuitable.

The European hand threshers that have been found useful are : (1) Mayfurth & Co.'s Hand Thresher, price Rs. 85, exclusive of freight, etc., which would come to another Rs. 50 ; (2) Ransome's Bullock-power Thresher ; and (3) Ruston Proctor & Co.'s Threshing Machine. The first is obtainable of Messrs. Mayfurth & Co. of Frankfort-on-Main, Germany, and it can be ordered through any local European firm who deal in agricultural machinery. It is used at the Nagpur Experimental Farm, where it is found to thresh three and a half maunds of grain per hour. It is kept working by five labourers. It is well made, strong, compact and simple in construction, consisting of a revolving drum on which are fixed strong iron spikes which pass in close proximity along a series of spikes fixed on a curved plate below which the drum revolves. The straw with grain is put in at the hopper or feeding board. The revolving drum sucks it in. The spikes or beaters detach the grain and the straw, and the grains fall out at the bottom separated. The space between the spikes on the drum and the spikes on the surrounding plate is adjustable, so that the machine can be used for separating large grains as well as small grains.

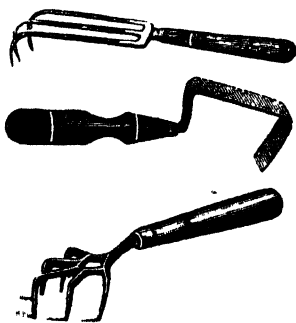

FIG. 36.—HAND WEEDERS.

It does excellent work for paddy, *jowar*, *arahar* and similar grains, but it does not do so well with wheat, linseed and gram. Ransome's Bullock-power Thresher is also in use at the Nagpur Farm. It does better work and works much faster than Mayfurth's Hand Thresher, but it is an expensive machine. It is very well adapted for threshing wheat, linseed and gram, as well as paddy, *jowar* and *arahar*. This machine is obtainable of Messrs. Ransome, Sims and Jefferies, Ipswich, England. Ruston Proctor's Threshing Machine costs Rs. 160. It is worked by twelve persons, and it is said to execute the work very rapidly. It has been introduced into and mostly used by the members of the Salvation Army at Ahmedabad.

**Winnowers.**—Dell's Winnower costs Rs. 265. It cleans the grain from the straw and chaff very rapidly. A Winnower is made at the Cawnpur Farm which is sold for Rs. 60. It is said to work

as well as Dell's Winnower. The ordinary fan (*sup* or *kula*) helped by a good breeze is well adapted for the system of cottage husbandry prevalent in India, especially if basketfuls of grain and chaff are gradually let fall from a height. A winnower adapted for separating grain from chaff is sold by Messrs. Burn & Co. for Rs. 65. Mr. Hauser, an American gentleman, while staying in Calcutta invented a winnower and grain-cleaner which is now sold

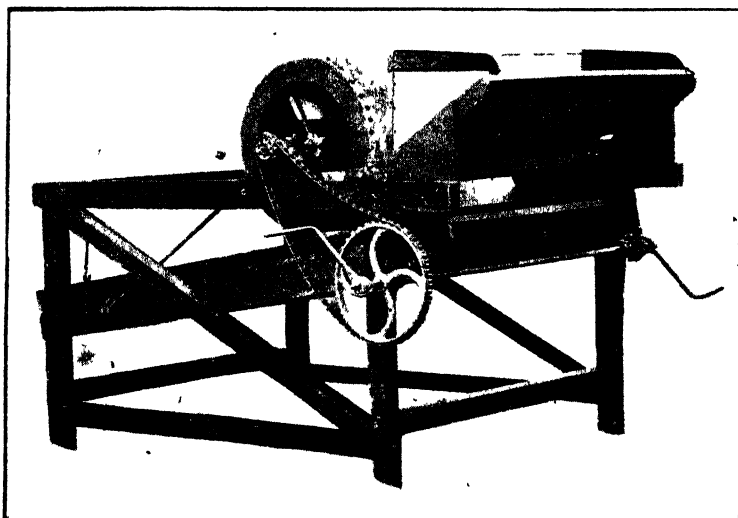

FIG. 37.—HAUSER'S WINNOWER AND GRAIN-CLEANER.

by Messrs. Burn & Co. for Rs. 250. After a crop has been trodden down by bullocks or otherwise threshed, it can be passed through this cleaner (after separating out by hand the long straw), and it will be found that not only the straw and chaff are blown away behind, but the grain of different sizes comes out at different spouts in front. Grains of a mixed crop, such as gram, linseed and wheat, come out at the different spouts quite separate (Fig. 37).

## CHAPTER XIV.

### THEORIES UNDERLYING THE QUESTION OF IRRIGATION.

[Character of water used of great importance; rain, well, canal, river, and sea-waters compared; evaporation; storage tank; solids in solution; endosmosed sap must be thinner than exosmosed sap; how quantity to be determined; irrigation of paddy fields; duty in canal irrigation; drainage depth of water.]

**The problem stated.**—Before entering into a description of the various irrigation appliances, it is necessary to deal with certain theories connected with this subject. The question of irrigation

is not only the most important, but also the most complicated of all questions connected with Indian agriculture. Experienced cultivators in certain localities are of opinion that well-water is injurious to crops. Where canal-irrigation has been in vogue for a long time, *e.g.*, in parts of the United Provinces and the Punjab, cultivators are of opinion that well-irrigation is to be preferred to canal-irrigation. Again, generally speaking, rain-water has been found to do more good to crops than either canal or well-water, especially at the beginning of the rainy season. If well-water or canal-water, or tank-water under certain circumstances has the property of doing harm to crops, and if rain-water is more generally beneficial, then we must be cautious before venturing on any scheme of irrigation, lest it should afterwards prove to have been initiated without due thought. A further complication arises from the different effects of irrigation on different crops. At Sibpur Farni, we have observed that the use of the canal-water benefits potatoes and cabbages, while it hurts country peas and beans, when owing to late sowing the latter crops had to be irrigated in December and January. Irrigation with this canal-water benefits all kinds of crops in May and June, while at the driest season from December to April, this canal-water injures leguminous crops and seedlings of all kinds. What is the explanation of all this? It is only if we understand the theories underlying the question of water adapted for irrigation that we can avoid mistakes in the use of irrigation-water, both as regards quantity and quality.

**Rain-water.** -At the beginning of the rainy season rain-water contains in solution and suspension a large amount of foreign substances which are all more or less helpful to agriculture. As the rainy season advances, the water becomes freer and freer from nitrates, ammonia, organic dust, etc. Hence the greater invigorating effect on plants of the early showers of rain. Even in the latter part of the rainy season, one hundred cubic inches of rain would contain two or three cubic inches of atmospheric gases. Every hundred volumes of water are capable of holding in solution under normal conditions of temperature and pressure about one and a half volumes of nitrogen, about three volumes of oxygen, about 100 volumes of carbon-dioxide and about 7,800 volumes of ammonia. The capacity of rain-water for holding large quantities of carbon-dioxide and ammonia in solution is of special importance for agriculture. We thus understand how rain-water should benefit the crops in more ways than one, and at the early part of the rainy season more than at a later season.

**Well and canal-water.** -But why should not spring, well, or canal-water do more good than rain-water? The former contains more substances in solution than rain-water, not only more carbon-dioxide, but also saline substances of various kinds, most of which are actually required for the growth of plants. The danger in using irrigation-water lies, not in the fact of the possibility of this



water being too poor in soluble substances, but of its being too rich in such substances. Spring or well-water may look purer than river-water, but the latter may contain only about one part or less of solids in solution in every thousand parts, while the former may contain as much as two or three parts in a hundred. The water of a low and dirty pool may not look very clean, but it contains a high proportion of solids in solution. We have said before that plants can take up nourishment only in a very dilute solution, the dilution best adapted for nourishment of plants generally being one part of solid food in solution in more than a thousand parts of water. Five parts in one thousand may be taken as the extreme limit of endurance for plants, while two and a half to three parts of solids in solution in a thousand parts of water indicate the danger-point, *i.e.*, the degree of solution at which the results of the use of water become uncertain, specially for leguminous crops and seedlings. The salts in solution may be one or more of the following :—Sodium chloride, sodium sulphate, magnesium sulphate, calcium chloride, magnesium chloride, sodium bicarbonate, calcium carbonate, calcium sulphate, and some silicate, iron, and alumina compounds, also some nitrates and borates. Of these salts, the calcium carbonate, calcium sulphate, silicon, iron and alumina compounds do no harm when they are present in large proportions in irrigation-water, as upon the evaporation of the water after it has been applied to the land, these compounds crystallize out and do not collect in the soil in a soluble form. The accumulation of the other salts in solution may go on until the proportion of soluble salts in the soil reaches the danger-point. Herein lies the danger of irrigating with well-water or water from low cess-pools or canals, which contain a high proportion of undesirable solids in solution. There is another side of the question. Some *soils* contain a high proportion of these undesirable salts in a soluble state, and when to such soils water surcharged with the same salts is applied, the proportion readily reaches the danger-point. Soils containing a large excess of these salts are *usar*, *i.e.*, altogether barren and unfit for cropping, but soils not containing such excess but only a high proportion may be *rendered usar* by injudicious irrigation.

**Evaporation.**—The question of evaporation then comes in, which is further complicated by the fact that evaporation is much slower from land under crop than from bare land, and is different at different seasons, and the whole question of evaporation is of minor importance when one takes into consideration the loss by surface flow and percolation in certain soils. But leaving all side issues out of consideration, and assuming that a tank 30ft. deep loses by evaporation 15ft. of water in course of the year, it would be obviously an advantage to have irrigation from such a deep tank than from one, say, 20ft. or 18ft. deep. Just as the 30ft. tank would lose by evaporation 15ft., so would the 20ft. or 18ft. tank. Now the remaining quantity of the water in the tank would be

more or less rich in solids, and the residual 5ft. or 3ft. of water is likely to be too rich in solids unless the water in the tank is rain-water and not water containing an excess of solids in solution to begin with. Here comes the danger of utilising water pumped up from a well or shallow pool of water and stored in a tank for future use for watering plants in the dry season. As evaporation goes on, the residual water becomes more and more concentrated in soluble salts, and the water used for irrigation afterwards may do more harm than good. If storage tanks are made at all for irrigation, and well or pool water stored in such tanks, they must be made as deep as possible, or evaporation should be prevented. But storing of water for agricultural purposes in high level masonry tanks is not a practicable project, except for such purposes as irrigation of seed-beds, etc. But it is in the watering of seedlings specially that the question of the proportion of solids in solution in the water assumes importance.

Sap usually contains about four grammes of solid in solution to every litre. The water, therefore, in which the plants-food is dissolved should contain less than four grammes of soluble matter of any kind per litre, that absorption may go on with success. Excessive manuring with soluble manures results in plants getting dried and burnt up. If horse-dung and horse-urine, for instance, are heaped up round the base of a large mango or other tree, the tree will dry up and perish in a few months.

**Quantity.**—The proportion of moisture imbibed and transpired by a leguminous crop during the whole period of its growth has been determined by actual experiments to be about two hundred and eighty times the weight of the dry matter of the crop; while in the case of cereals the proportion is about 1 : 320. But one crop differs from another, and even one variety of one crop differs from another variety (*e.g.*, *aus* and *aman* paddies) very much in this respect. Roughly speaking 1 : 300 may be taken as the average for crops during the cold weather (which is the result of European experience) and 1 : 600 for the hot weather crops of this country. But as hot weather crops can depend chiefly on rainfall, even in a bad year, the maximum requirement of crops irrigation-water may be put down at 300 times the dry weight of the crop. Suppose an acre of wheat including straw weights 3 tons, the dry weight of the crop is about  $2\frac{1}{2}$  tons. The maximum requirement of irrigation water for this crop is  $2\frac{1}{2} \times 300 = 750$  tons of water, or nearly 200,000 gallons. A *don* lifting 10,000 gallons of water per hour, or 80,000 gallons per day, is found in practice to be able to irrigate an acre of wheat in one day; and to irrigations are found ample for the wheat crop even in the worst season. Thus the maximum quantity of irrigation-water required for this crop, as theoretically determined, agrees very nearly with what is actually allowed in practice. But there are extreme cases of peculiar habits of plants. *Cicer arietinum* (*gram*), *Panicum*

*muticum* and some other crops are able to utilise very large quantities of moisture from the nocturnal dew while most varieties of rice are benefitted by an accumulation of water at their base continuously for about seventy days. Probably plants covered with leaf-hairs are able to utilize the moisture from dew, hence the flourishing condition of *gram* and *Panicum muticum* in dry weather without irrigation.

**Value of canal-irrigation.**—Canals and distributaries have been made leading from the Son, Rupnarayan, Banka and other rivers for watering the rice and other crops in the surrounding tracts. These are not only of the greatest benefit to the *raiyats*, but they have actually proved remunerative to the State. The silt brought down by the Damodar and the Banka and distributed to fields by the Eden Canal has also proved one of the best fertilizers. The manurial value of the silt itself is found to be between Rs. 4 and Rs. 5 per acre per annum; so that even in years of abundant rainfall the *raiyats* find that it pays them to take water from the canal, specially in May and June, when the silt is richer in organic matter. In years of scanty rainfall the canal-water brings salvation to the crop. There is a tendency on the part of *raiyats* to take more water than is necessary for their rice crop. They want nine inches of water in their fields five times in the year for the rice crop. While experiments have proved that in ordinary years four and a half inches of water twice, and in dry years three times, are enough. The excessive distribution of water in the country has resulted in the canal-irrigated tracts, specially of Burdwan and Midnapur, having become very malarious. Even in bad years there is some rainfall, and the rainfall only requires to be supplemented by canal-irrigation. The excessive use of canal-water results also in fewer people being benefitted than might be otherwise the case. A quantity of water that is now spread over ten square miles might be distributed with greater advantage over fifty square miles.

**Duty for rice crop.**—If an acre of land is irrigated with  $4\frac{1}{2}$  inches of water once, the quantity used up is 660ft.  $\times$  66ft.  $\times$   $\frac{4\frac{1}{2}}{12}$  cub. ft., i.e., 16,335 cub. ft. In Bengal proper, the effect of one irrigation of  $4\frac{1}{2}$  inches lasts at least for 15 days. The quantity of water that can flow out of a channel in 15 days at the rate of one cubic foot per second is  $15 \times 24 \times 60 \times 60 = 1,296,000$  cub. ft., and the water being distributed at the rate of 16,335 cub. ft. per acre, about 80 acres can be irrigated. The *duty* of each cub. ft. of water flowing per second is therefore said to be 80 acres. According to the area of the opening of the channel and the rate of flow, the *duty* of any channel can be determined according to the above calculation. Canal Engineers should see that each lock-gate and sluice-gate is doing its full *duty* and that no water is wasted. If, for instance, the opening of a channel is 4ft.  $\times$  1ft., and the flow as ascertained by a pith-float floated along the middle of the

channel, is  $2\frac{1}{2}$  ft. per second, the duty of such a channel is  $10 \times 80$ , or 800 acres.

The question of quantity of water needed for irrigation is also of great importance. Wherever canal-irrigation has been introduced, there *raiyats* feel that the more water they use the better value they get for the water rates they pay. This is a very serious error, which it is the duty of irrigation officers to dispel. By using too much canal or well-water, one is bound to suffer sooner or later from the effects of over-irrigation. The complaint is already being heard, that canal-irrigation has ruined large tracts of land in the United Provinces. It is not the fault of the canals, but of over-irrigation, and of utilizing the water at the driest season when it is low down, and when it contains in solution too high a proportion of solids; one inch of water once a month, or at most twice a month, should be the maximum allowance in the cold weather, and two to six inches in the dry weather, according to the period of growth of the plants. From this, the quantity obtained by rainfall should be deducted. For winter-rice, a larger amount of water is required at the growing period, *i.e.*, about twelve inches per month for a little over two months, one-half of which quantity may have to be ordinarily supplied by irrigation.

**Irrigation of paddy-fields.**—Suppose one wishes to provide for the irrigation of paddy-fields what provision of water should be made? It is enough if rice plants have half an inch of water at their base for 72 days, *i.e.*, if they have 36 inches of rainfall during the three months of vigorous growth from July to September. An acre (4,840 sq. yds.) would thus require 4,840 cub. yds. of water. An allowance of 2 160 cub. yds. may be made for evaporation and percolation, and the total maximum requirements per acre may be thus put down at 7,000 cub. yds. for the 72 days. Now there are 640 acres in a square mile. If a square mile of rice-fields has to be provided with the maximum quantity of water (for a season of severe drought), and the water in the canal runs at the rate of 1 mile an hour, a vent of only about 9 sq. feet is required. To provide means of irrigation for paddy for any considerable agricultural area by means of tanks and wells is not feasible.

**Drainage.**—We have said over-irrigation, or irrigation with water surcharged with soluble salts, results in an accumulation of these salts in the soil which gradually renders it barren. When canal-irrigation is provided, the means of correcting the evils of irrigation should be also provided. This consists in having drainage channels. Drainage would make much *usar* land fertile. A land which is drained readily parts with its soluble salts. Irrigation-canals should be built with a fall of one foot per mile and the drainage channels should have a fall of two feet to the mile, and the drains empty themselves finally into a canal, stream, or river farther down where the level is six to eight feet below the level of the highest portion of the channel where the particular irrigation

section begins. Drainage and irrigation channels should be simultaneously provided wherever water, other than rain-water, is used for growing crops, whether it is well, or canal, or tank-water.

**Purity of waters.**—What quantity of solids is contained in solution in a particular water, intended to be used for irrigation, cannot be determined except by an analysis. This analysis for agricultural purposes need not be an elaborate analysis at all. Of all natural waters, rain-water is the purest and safest to use for irrigation. Water of a river flowing through a granite country is also very pure, containing only two or three grains of solid matter in solution per gallon (*i.e.*, 70,000 grains). The water of a river flowing through a country containing more easily soluble rocks (such as limestones) often contains twenty to thirty grains of solid matter in solution in every gallon. Springs, or well-water, contains a larger proportion of solids in solution, as under pressure at great depth such water absorbs larger volumes of carbon-dioxide, sulphuretted hydrogen and other gases, and it also dissolves saline matters of different kinds from different rocks. Sea-water contains as much as 2,400 grains of solids in solution per gallon, of which about 2,000 grains are common salt. Sea-water is thus absolutely unfit for purposes of irrigation.

## CHAPTER XV.

### WATER-LIFTS.

[Classification according to depth of water to which each lift is adapted—net result of Indian experience: The single *môt* with self delivery tube; The double *môt*; Stoney's water-lift, The Sultan water-lift; Mr. Chatterton's experiments; The Madras *Paikota*; *Tera* or *Láthá*; Chain-Pumps; Persian wheels; Egyptian appliances for irrigation (Sackiyeh, Taboot and Shadoof); The *Noria*; Windmills; *Baldea-Bálu*, Artesian and Tube-wells; Windlass-and-Bucket-lift; Pumps and Fire-engines; Centrifugal Pumps; Comparison of cost of irrigation with different appliances]

**Classification.**—By far the most important implement for the Indian *ranyat* is the water-lift. Various forms of water-lifts are in use. The following are adapted for depths of over 25 feet :—(1) *Môts*, single and double; (2) Stoney's Water-lift; and (3) Force-pumps and Fire-engines. The following are adapted for medium depths, *i.e.*, depths varying from 10 to 25 feet :—(1) *Paikota*; (2) *Tera*, *Dhenkli* or *Latha*; (3) Persian wheels; (4) Cawnpore chain-pump; (5) Subba Rao's see-saw water-lift; (6) Deck-pumps; (7) Centrifugal pumps; (8) Windmills. The water-lifts adapted for depths smaller than 10 feet are: (1) *Sewni* or *Swing-basket*; (2) *Irrigation-spoon* or *ladle*; (3) *Baldeo-bálu*; and (4) *Don*.

Of all these water-lifts experimented with, the single *môt* has been pronounced by the authorities in charge of the various Experimental Farms as the best for deep wells, everything being

taken into account, and the *paikota*, the *don* and the *baldeo-balti* the best for short lifts.

The *Single môť* (Fig. 38) with a self-delivery tube, which will be understood by a reference to the position of the bucket (which is shown in two positions in the figure), costs only about Rs. 25 setting up, and as it does not require such a wide well as the double *môť* to work it successfully, it is the most suitable water-lift for fairly well-to-do cultivators. In the United Provinces *môťs* are not provided with self-delivery tubes, and there an additional person is therefore needed for emptying the bucket or leather-bag when it comes up at the mouth of the well.

The record of an experiment with a single *môť* conducted in Madras gives the following data :—“ The *môť* was worked by two bullocks weighing 732lbs. and 616lbs. respectively, or in the aggregate 1,348lbs. The bucket, which was of iron and fitted with a leathern discharging trunk, weighed 43lbs., and when full held 31 gallons of water, but the mean quantity lifted, as measured into a tank, was 24·2 gallons per lift, the rest being spilt or lost by leakage. With the bullocks employed, the rate of working was 90 lifts

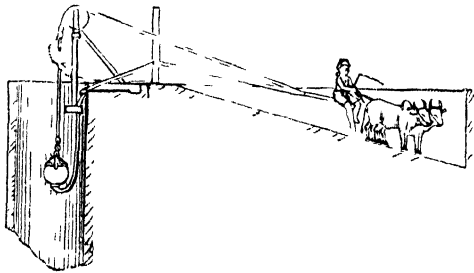

FIG. 38.—THE SINGLE MÔT.

per hour, and the height of the lift being 23ft., the total quantity of work usefully done amounted to 500,940ft.lbs. per hour. The draught exerted by the bullocks down the inclined plane was found to be 383lbs. The useful work done in a single lift was  $24\cdot2 \times 10 \times 23$ , or 5,570ft.lbs., whilst the bullocks exerted a pull of 383lbs. through  $25\frac{1}{2}$ ft., the bucket having to be raised an extra  $2\frac{1}{2}$ ft. to enable it to discharge its contents, and the work done is equal to 9,760ft.lbs. The bullocks then had to return up a gradient of 1 in 5·28ft., in doing which they expended  $6,510 (1,300 * \times \frac{1}{5\cdot28} \times 25\frac{1}{2})$ , ft.-lbs. of energy in lifting their own weight against the action of gravity. The total amount of work done by them in a single lift was therefore 16,270 ft.-lbs., and the useful outturn 5,570 ft. lbs., so that the efficiency of this method of lifting water is not greater than 33 per cent.”

**The double môť.**—The following data occur for an experiment with the Double *môť* conducted in Madras :—“ The buckets were of iron with leathern discharging trunks and were in good order and discharged an average of 28 gallons per bucket as measured into a tank. The trial lasted 3 hours, and in that time

\* The figure 1,300 is for the weight of the two bullocks, minus the weight of bucket and rope (i.e., 1,348-43-5.)

200 buckets of the water raised. The mean lift was 22·125ft. and the useful work done per hour was 413,000 ft.-lbs. The circumference of the drum of the winch was 12ft. 11½in., and the circumference of the circle in which the bullocks walked was 60ft. 9in., so that the velocity ratio was 4·67. The pull on the dynamometer at the ordinary speed of working was 90lbs., and the pull to just prevent a full bucket descending, 59lbs., and the pull to just raise a full bucket, 81lbs. The mean between these last two quantities, 70lbs., is the force at the end of the lever-arm required to balance a full bucket of water when friction is eliminated. Multiplying by the mechanical advantage, the unbalanced weight is 327lbs., a result probably not very much in error, as the water in the bucket weighed about 300lbs. The mechanical efficiency of the lift just moving is therefore 74 per cent., and working at its normal speed, 6·6 per cent. The lifts average, 1·111 per minute, and the animal was therefore usefully employed for 52·5 per cent. of the time, and the absolute efficiency of the lift as a machine for utilizing the energy of the bullock is  $0·66 \times 52·5$ , or 35 per cent."

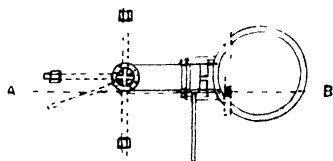

FIG. 39.—THE DOUBLE MÔT (PLAN).

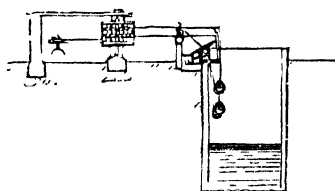

FIG. 40.—THE DOUBLE MÔT.  
(SECTION THROUGH A. B.)

**Stoney's Water-lift.**—The principal feature in this lift is the employment of buckets of wrought iron suspended in a stirrup by two adjustable pivots attached to the bucket very slightly above the centre of gravity of the bucket when full of water. The mouth of the bucket is inclined and the lower ends of the stirrup are turned outwards and encircled steel wires which are suspended in

the well from screwed eye-bolts attached to the framing above. The wires are fastened by some convenient means to the bottom of the well and act as guides to the bucket, ascending and descending, and prevent it from either turning round or swaying to and fro and thus striking either the sides of the well or the second bucket. On the bucket being lowered into the water, it turns horizontal, and rapidly fills with water, and on being drawn up assumes a vertical position and rises steadily out of the water till the discharging level is reached, when the upper side of the inclined mouth comes into contact with an iron bar fixed across the framing of the lift, and the stirrup continuing its upward motion, causes the bucket to revolve about the point of contact of the bucket with the iron rod and thus discharge its contents into the delivery trough. The lift, as arranged at Saidapet during the trials, was worked by arranging the ropes which hold the buckets over guide-pulleys to a winch turned by

either a pair of bullocks or a single bullock. Two buckets were attached and the ropes arranged so that as one bucket ascended the other descended and the dead-weight of the bucket was balanced. The winch consisted of a drum built of wood and carried by an iron spindle on the top of a post firmly built into the ground. The bullocks worked at the end of a long arm, the circumference swept out by which was 3.85 times the circumference of the drum. Thus Stoney's Water-lift is only an adaptation of the double *môt*, where the buckets slide up two wires instead of thumping against the sides and instead of the self-delivery tubes there is a tilting arrangement.

Mr. Subba Rao of the Madras Agricultural Department has introduced an improvement in the single *môt* which consists in balancing the empty *môt* or bucket by a weight attached over a pulley. It adds considerably to the expense, and "it is doubtful if it contributes any real increase to the efficiency of the lift, as the friction of the extra pulley absorbs power, and more work is thrown on the drivers since the unbalanced bucket materially assists the driver in climbing the steep ramp." (Bulletin No. 35, Madras Water-lifts, by A. Chatterton, 1897.)

**The Sultan Water-lift.** -

This is a modification of the double *môt*. The buckets are balanced and each is fitted with a valve which opens and allows the water to fill the bucket. When new, the valves are water-tight, but they soon begin to

leak. The bullocks walk in a straight and horizontal path and they do not need to be driven backwards. So far the Sultan Water-lift has not been found acceptable, the dead pull being too great for the cattle and the rope. The tilting arrangement is not unlike that of Stoney's Water-lift.

**Subba Rao's See-saw Water-lift.** - (Figs. 41 and 42) also, though a very ingenious contrivance, is not a complete success as yet. "In this form of Water-lift the bullock, is made to walk along a platform supported on a roller and by his weight it is caused to oscillate up and down. Two ropes are attached to one end of the platform and wound round two small drums, forming part of a species of windlass at the two ends of the large drum round which a rope working an ordinary single *môt* is passed. The platform is not supported at the middle, but at some distance therefrom, so that the working end of the platform greatly preponderates, and the bullock has to walk to the free end of the platform to tilt the longer segment up and lower the bucket into the well. The

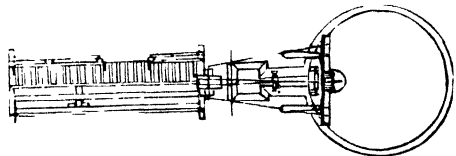

FIG. 41.—SUBBA RAO'S WATER-LIFT (PLAN).

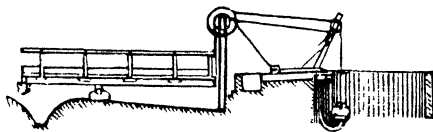

FIG. 42.—SUBBA RAO'S WATER-LIFT (SECTION).



platform is 24 ft. long and the supporting roller is fixed 15 ft.  $3\frac{3}{4}$  in. from the working end." The weight of the two sections of the platform is 1,450lbs. and 850 lb., respectively. To diminish the shock when the free end falls and the bucket is lowered into the water, 230lbs. of iron rails are fastened underneath the platform by a short chain, so that just before the end of the platform reaches its lowest position, the rails rest on the ground and their weights cease to act, and the platform comes to rest more gently than would be the case if the velocity of descent continued to accelerate to the very end. The ropes from the platform are wound round drums, the circumference of which is three feet two and a half inches, as measured by unwinding one coil of the rope, and the *môt* rope is worked from a drum seven ft. ten inches in circumference, so that the motion of the working end of the platform is multiplied 2.443 times. Mr. Subba Rao told me he intended substituting chains for ropes, as ropes lengthen in time and the efficiency of the lift is reduced in time thereby. With the bucket empty and the platform horizontal, the load at the free end can be varied from 160lbs. to 362lbs. without disturbing the equilibrium, whilst with a load of 247lbs. in the bucket, equal to 24.7 gallons of water, the platform remained horizontal, though the loads at the working end varied between 58lbs. and 275lbs. Taking the mean between the two extreme values to be the actual weights required to balance the platform, it is possible by taking moments about the centre, to determine the only force acting on the platform which is not measured, *viz.*, the weight of the empty bucket and ropes acting with a leverage of 2.443 to 1. With the bucket unloaded, the weight works out as 65.4lbs. and when loaded, 65lbs.,—a remarkably close agreement. The lift was worked during the trial by a bullock weighing 700lbs. and a man weighing 117lb. The rate of working was 81 lifts per hour from a well 18 ft. 1 in. deep. The average quantity of water brought up by the bucket, as measured into a tank, was 23.5 gallons, and the usefull work done per hour amounted to 344,210ft.-lbs. The mechanical efficiency of the lift can be ascertained by multiplying the fall of the front end of the platform by the force required to set it in steady motion when lifting a bucket full of water. The total height the bucket had to rise to discharge its contents was 22 ft., and the end of the platform therefore fell 9 ft. and the work done was  $584 \times 9 = 5,256$ ft.-lbs. To raise the platform back to its initial position, the free end then falls 5.18 ft. and the load on it is 362lbs., and the work done is equal to 1,875ft.-lbs. The total work therefore done in a single lift is 7,131ft.-lbs. and the useful work given to the water is 4,245ft.-lbs.; so that the mechanical efficiency when just working is 59.6 per cent.; at the normal rate of working it is much lower, probably not more than 50 per cent.

Mr. Chatterton thus summarises the trials of the various Madras Water-lifts :—

Foot-tons of work per lb. weight.

|   |       |
|---|-------|
| Mr. Stoney's Water-lift .. ..               | 2.253 |
| Double <i>Môt</i> (Saidapet) .. ..          | 1.930 |
| Single <i>Môt</i> (Subba Rao's Improved) .. | 2.323 |
| Subba Rao's See-saw Water-lift .. ..        | 3.511 |

He also gives the following figures for comparison of the results of the trials :--

|  | Stoney's Water-lift. | Double <i>Môt</i> (Saidapet). | Single <i>Môt</i> (Subba Rao's Improved). | Subba Rao's See-saw Water-lift. |
|--|----------------------|-------------------------------|---|---------------------------------|
| Useful work in ft.-lbs. per hour (A) ..  | 571,500              | 413,000                       | 500,940                                   | 344,210                         |
| Weight of animals in lb. (B) ..          | 1,146                | 1,146                         | 1,348                                     | 700                             |
| $\frac{A}{B} = C$ .. ..                  | 498                  | 360                           | 371                                       | 492                             |
| Mechanical efficiency just moving ..     | 83.6%                | 74%                           | .   | 59.6%                           |
| Mechanical efficiency at working speed.. | 79%                  | 66.6%                         | 34.25%                                    | ..                              |
| Absolute efficiency ..                   | 47.2%                | 35%                           | ..  | ..                              |

It may be noted here that the ordinary *Paicota* (Fig. 43) though a dangerous instrument, it still considered in the Madras Presidency the best appliance for lifting water from small depths (say 10 to 12ft.), and the single *môt* the best for lifting water from great depths. The inexpensiveness of the appliances, the ease with which they are set up and repaired, cannot very well be surpassed for very small depths. The swing-basket (Fig. 49), and the irrigation-spoon (Fig. 1), such as is used in Madras by a single person, are also considered very efficient for small depths.

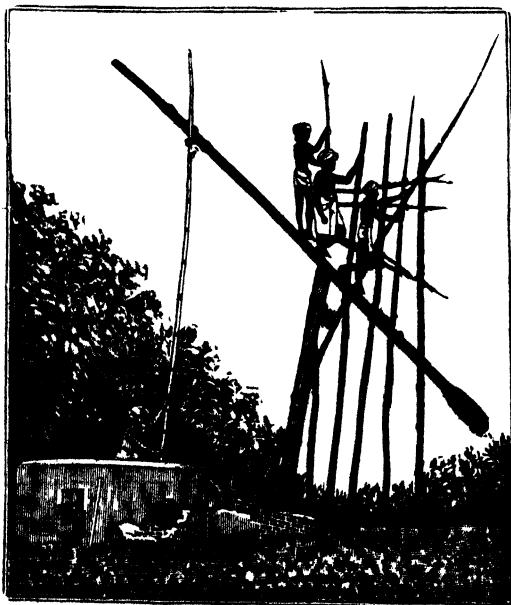

FIG. 43.—PAICOTA.

**Chain-pumps.**—Of the chain-pumps in use the Cawnpur Pump has found favour with the Agricultural Departments. This chain-

pump, the chain-discs of which are fitted with leather washers, works well when new, but they require to be renewed or repaired from time to time. They are to be had at the Government farm at Cawnpur.

**Chain-pumps Hand-lift.**—(Fig. 44, I, II and III) works well up to a depth of 25 feet, but it is doubtful whether it is more efficient

FIG. 44.—THE CAWNPORE CHAIN-PUMP

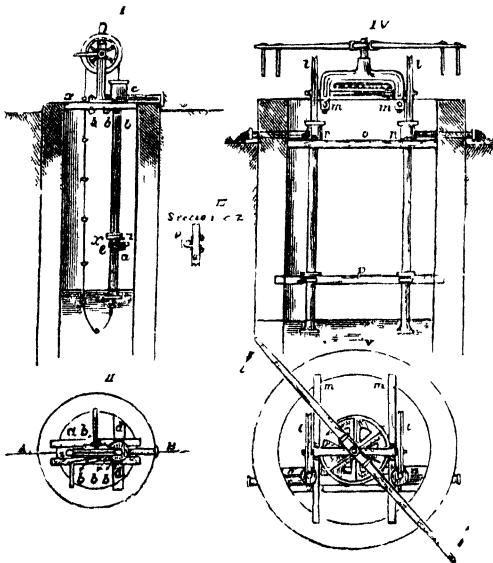

HAND-LIFT.

BULLOCK POWER LIFT.

than the *mot* at depth above 15 feet. The cast-iron stand (1), as well as the top part of the pipe, are fixed on two beams *a a*, (I and II), walled into the masonry on the top of the well by means of six bolts, *b b*. The pipe with top *c* is to be fixed in such a way that the centre of the pipe and the centre of the wheel are in one line *A B* (II). The lower end of the bell-mouthed pipe should extend at least six inches below the surface of the water. The pipes, for lifts of more than 10 feet depth of well, ought to be fixed on a beam, *d* (I, II and III), walled into the masonry of the well at a vertical distance of about 2 or 3 feet above the water-level by means of an iron strap, *e*, with bolts (I and III) in order to keep them firmly in their proper position. The pipe should not be fixed vertically, but on an incline, according to the slope of the chain (Fig. 1) in order to avoid friction as much as possible. The chain-pulley should be worked at the rate of 25 to 40 revolutions per minute, according to depth of well, from 4 to 25 feet, respectively. The following are the approximate capacities of a Chain-pump Hand-lift for different depths of well, if worked by two good coolies:—

| Depth of well. | Diameter of pipe. | Approximate quantity of water raised per hour. | Price. |
|----------------|-------------------|--|--------|
| 4 feet         | 4½ inches         | 15,000 gallons                                 | Rs. 35 |
| 6 "            | 4 "               | 8,000 "  | " 37   |
| 10 "           | 3½ "              | 4,500 "  | " 40   |
| 15 "           | 3 "               | 2,500 "  | " 45   |
| 20 "           | 2½ "              | 1,800 "  | " 50   |
| 25 "           | 2½ "              | 1,300 "  | " 55   |

Fig. 44 (IV and V) shows a *Double Chain-pump Lift worked by bullock-power*. It has about three to four times the capacity of a Hand-power Lift, and it can be conveniently worked up to a depth of 40 feet. But it is probably not as efficient as the *môt* at depths greater than 20 feet. It consists of a bullock gear, the horizontal shaft of which carries two chain-pulleys, *ll*, each working a chain-pump. The gear is fixed with four bolts on two beams, *mm*, walled into the masonry on the top of the well. The top parts of the pipings, *nn*, are fixed with four bolts on two other beams, *oo*, also walled into the masonry of the well. A fifth beam *p* serves for fixing the lower part of the pipes similarly as described before for the Hand-lift.

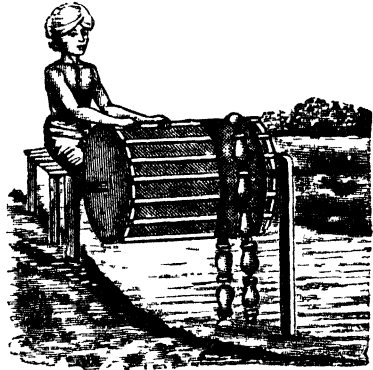

FIG. 45.—PERSIAN WHEEL WORKED BY HAND AND FOOT.

**Persian Wheels.**—PERSIAN  
Wheels are in use in the Malabar Coast, Rajputana, Kathiawar and in the Punjab. Some (Fig. 45) are of very simple and cheap construction. The type illustrated in the figure is used chiefly in the coast of Kathiawar, Gujrat and the west coast of India generally. A bamboo or wooden drum of light framework turns on an axle which rests on two pivots. One

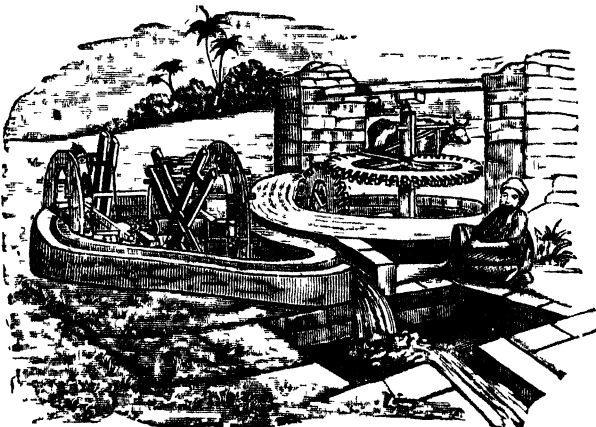

FIG. 46.—THE EGYPTIAN PERSIAN WHEEL.

is at the top of a strong support fixed in water and the other on the top of another support fixed on dry land, or both the pivots are on the sides of a well. A man sits and turns the drum with his hands and feet. Round the drum is attached an endless garland of mud vassels which are brought up by the revolution of the drums carrying

water in them, and discharging the water (from three mud vessels at a time) into a trough of stone, whence it flows out to the field. Each mud vessel is tied on both sides with ropes, and a bamboo or a rope hanging down on one side of the well, *i.e.*, the side at which

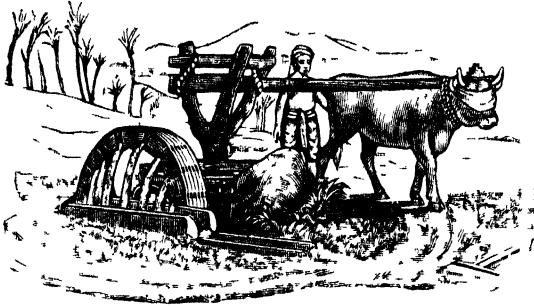

FIG. 47.—THE TABOOT.

the mud vessels filled with water are coming up, bumping against the side of the well is prevented. With this implement one man can irrigate one-tenth of an acre a day.

Mr. Andrews, a missionary of Chingleput, has

built a Persian Wheel out of old railway rails, over a circular well 24 ft. 6 inches in diameter. The rotating drum is six feet in diameter and three feet eight inches wide and carries a double chain of sheet-iron buckets, each holding 1·80 gallons. The axle

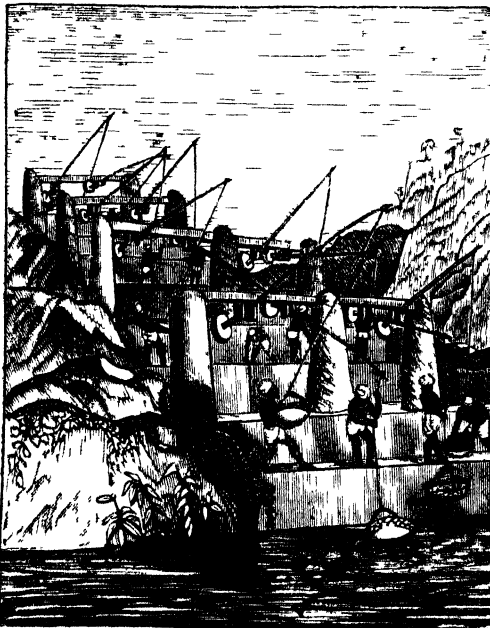

FIG. 48.—THE SHADOOF.

is prolonged on one side and driven through a pair of bevel wheels by a winch. Each bucket is provided with a leather flapvalve to permit of the escape of air from the descending buckets as they enter the water. This improved Persian Wheel works very satisfactorily. From a *raiyat's* point of view, however, it is too costly and it has too many working parts.

**Egyptian appliances.**

—The Persian Wheel of the Punjab pattern, which is the same

as, the Egyptian Persian Wheel, is also somewhat too complicated for ordinary *raiyats'* use (Fig. 46) in Bengal,

though commonly employed in Bombay. The Egyptian Persian Wheel or Sackiyeh, as illustrated in p. 129 is thus described in Lane's *Modern Egyptians*: "The Sackiyeh mainly consists of a vertical wheel which raises the water in earthen pots attached to cords, and forms a continuous series; a second vertical wheel, fixed to the same axis, with cogs, and a large horizontal cogged wheel, which, being turned by a pair of cows or bulls, or by a single beast, puts in motion the former wheels and pots." Another beautiful Egyptian arrangement for raising water is the Taboot (Fig. 47), which resembles the Persian Wheel in some respects, the chief difference being that pots are not used, but the water is raised up in a large wheel with hollow joints or fellies. The bullock is blind-folded, and it goes round and round even without a driver, while the cog-wheel to which the shaft of the bullock is attached moves

the other two wheels. The wheel with the hollow fellies faces a channel to which seven or eight of the hollows pour out their contents simultaneously, while others are coming up in an endless series. This arrangement is adapted only for small depths. The môt (without the self-delivery tube) and the swing-basket are also in use in Egypt, as also the *Tera* or Shadoof. The Shadoof (Fig. 48) consists of

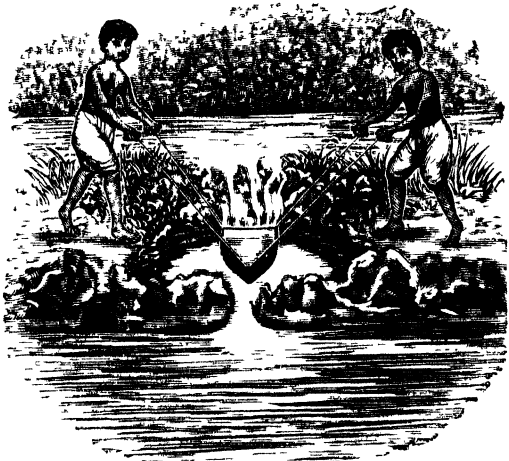

FIG. 49 — THE BENGAL SWING-BASKET.

two posts or pillars of wood, or of mud and cane or rushes about five feet in height and less than three feet apart, with a horizontal piece of wood extending, from top to top, to which is suspended a slender lever formed of a branch of a tree having at one end a weight, chiefly composed of mud, and at the other, suspended from two long palm sticks, a vessel in the form of a bowl made of basket-work, or of a hoop and piece of woollen stuff or leather. With this vessel the water is thrown up to the height of about eight feet into a trough hollowed out for its reception. The Shadoof is thus a combined *lithi* and swingbasket. The ordinary swing-basket of Bengal is illustrated in Fig. 49.

The *Noria* or Bucket-pump is another form of improved Persian Wheel, which consists of buckets chained one to another in an endless series and worked by hand or animal power. The following facts and figures taken from the catalogue of Messrs. W. J. &

C. T. Burgess (Victoria Works, Brentwood, Essex, England) give a general idea of the efficiency of this kind of water-lift :—

|                     | Gals.<br>pr. hr. | 20 feet. | 30 feet. | 40 feet.                                | 50 feet. | 60 feet. | 70 feet. | 80 feet. |
|---------------------|------------------|----------|----------|---|----------|----------|----------|----------|
|                     |                  | † £ s.   | † £ s.   | † £ s.                                  | † £ s.   | † £ s.   | † £ s.   | † £ s.   |
| Single chain. 1,000 | 1 16 10          | 1 19 10  | 1 22 10  | Not intended for gtr. depth than 40 ft. |          |          |          |          |
| Double „ 1,000      | 1 18 3           | 1 21 9   | 1 24 15  | 1 28 1                                  | 1 31 8   | 1 34 15  | 1 38 1   |          |
| Single „ 1,500      | 1 22 9           | 1 26 10  | 1 31 9   | Not intended for gtr. depth than 40 ft. |          |          |          |          |
| Double „ 1,500      | 1 22 0           | 1 26 10  | 1 31 0   | 1 35 10                                 | 1 40 0   | 2 45 12  | 2 50 2   |          |

† Number of bullocks or donkeys needed.

Wind-mills, aeromotors, and oil-engines with centrifugal pumps, as other means of raising water, have been already described in

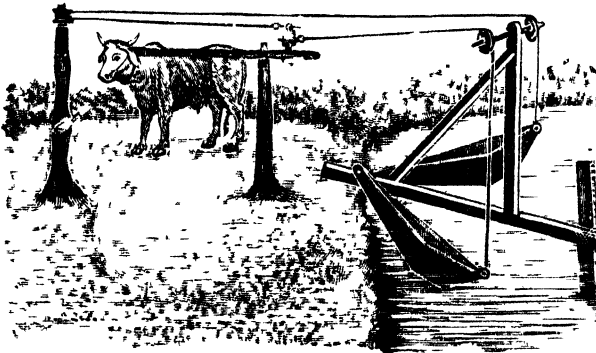

FIG. 50.—THE BALDEO BALTI.

Chapter XI. Full directions for erecting aeromotors are given in the catalogues of the Companies constructing and supplying them.

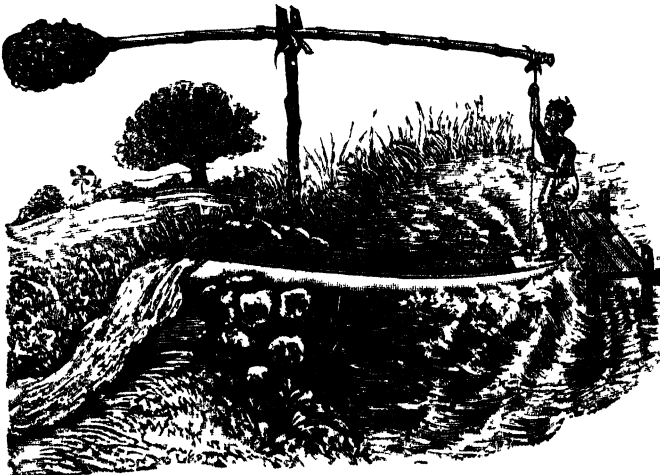

FIG. 51.—THE ORDINARY DON.

(Vide Part I of Catalogue No. 29 of Freeman Steel Wind-mills S. Freeman & Sons, Manufacturing Co., Racine, Wis., U. S. A.)

**The Baldeo Balti.**—An ingenious mechanical adaptation of the *din* (or canoe-shaped water-lift) for watering from small depths, known as the Baldeo Balti, is the invention of Baldeo, the agricultural-mechanic of the United Provinces Agricultural Department. It is a double *din* worked by a single bullock. The bullock goes round and round a tree or post to which the yoke-pole is attached. When one of the *dins* rises and discharges its water, the other goes down, the entrance of water into the empty *din* being facilitated by means of a valve. The arrangement of the strings to which the two *dins* are tied after passing over three pulleys, can be best understood from the above diagram (Fig. 50). The single *din*, which is either a hollowed-out trunk of palm or simul tree, or manufactured of iron, is largely employed all over the country. Iron *dins* (Fig. 51) are obtainable of Tara-prasanna Chakdar of Gushkara, E. I. R., for Re. 1-4 per cubit.

**Artesian Wells.**—The question of sinking artesian wells and tube-wells (Fig. 52), both for irrigation and drinking purposes, is a very important one, but its solution cannot be said to have been accomplished as yet in this country. Dr. Dyson, late Sanitary Commissioner for Bengal, drew special attention to this subject in a note, dated the 31st March, 1896. In concluding this note, Dr. Dyson remarks: "The Saidpore investigation confirms my favourable impression of tube-wells as an easy means of obtaining pure and wholesome water. I am not, however, prepared to recommend their universal use, because they are not suitable for all soils, but wherever they can be got to work, I think they ought to be used in preference to ordinary wells and tanks, than which they are much cheaper and far more satisfactory. They are specially suited for a loose, sandy soil like that of Saidpore. In hard laterite soil or in clay, they cannot, of course, be got to work, and in alluvial soil, like that of Chittagong, Noakhali, Backergunge, etc., it is not desirable that they should be tried, as in these places, which are subject to the influence of sea-waves and salt tides, the water is brackish. It might be mentioned that in soil which is suitable, the sandy beds of *nalas* and the dry beds of good tanks, offer the best prospects of rapidly sinking a water-supply which is practically inexhaustible."

There are not many successful artesian wells in India, and it is still a question how far artesian water exists and can be tapped.



FIG. 52.—NUBIAN TUBE-WELL.

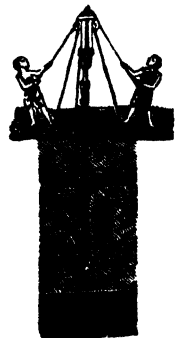

FIG. 53.—MANNER OF FIXING NUBIAN TUBE-WELLS.



There are also many tube-wells working satisfactorily at Pondicherry. Borings at the bottom of wells up to a depth of 200 ft. have been made successfully in the Baroda State by Mr. Kasherao Jadhav, and by the Bombay Agricultural Department in other parts of Gujarat, to keep up a continuous supply in wells.

Of the firms which manufacture and supply artesian and tube-wells and the driving apparatus and boring tools, may be mentioned Messrs. C. Isler & Co., Artesian Works, Bear Lane, Southwark, London, S. E. Messrs. W. Leslie & Co., of Calcutta, supply tube-wells at the following prices :—

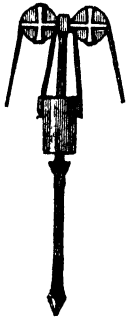

FIG. 54.—THE DRIVE POINT AND MONKEY GEAR

Drive point and 20 ft.  $1\frac{1}{2}$  in., wrought-iron tube in short lengths with a *putcher pump* —

|                | Rs. |
|----------------|-----|
| 20 ft. . . . . | 45  |
| 25 „ . . . . . | 50  |
| 30 „ . . . . . | 55  |
| 40 „ . . . . . | 60  |

The price of the driving apparatus, the same set serving for any number, is Rs. 15. The manner of planting the drive-point first, is illustrated in Fig. 54, and the whole arrangement for fixing the well in Fig. 53.

Another device for irrigation, called the Windlass and Bucket-lift, is illustrated in Fig. 55. It is useful for bringing water from a stream or canal to adjoining fields. The two positions of the same bucket are illustrated in the figure. A tilting arrangement, some-

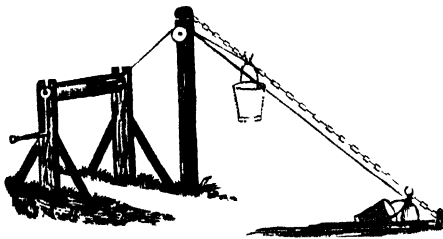

FIG. 55.—WINDLASS AND BUCKET-LIFT.

what resembling that in use in Stoney's Water Lift, occurs at the top of the post, and when the bucket reaches this position, it gets upset coming in contact with the tilting rod. The bucket slides up and down a steel rope, and with an ordinary rope it is worked with the windlass. Two buckets may be simultaneously worked when there are two steel-ropes, one bucket travelling up while the other marches down. This arrangement is suitable for lifting water on hill-sides from a stream at the bottom, and in other suitable sites.

**Fire-engines and other pumps.**—Of suction and force pumps suitable for irrigation, the first place must be given to Fire-engines. Heathman's Platform Fire-engine and Hand Curricule Fire-engine are excellent for pumping sewage, irrigating, as well as for putting out fires. Village unions or *tehsildars* should have these for letting out on emergencies and also for regular irrigation purposes, at so

much per day. The suction can take place from a depth of 28 ft. and as much as 600 ft. of delivery hose can be forced through. Heathman's Platform Fire-engine No. 1 worked by 2 to 4 persons and discharging about 2,000 gallons of water per hour over a height of 60 ft. is priced £12 10s. 6d. Heathman's\* Truck-Force-Pump, which can be moved about from place to place, and worked by one man, pumps up about 500 gallons of water or liquid manure per hour. This pump is also used as a fire-engine. Its price, with 10 ft. of suction-hose and 2 ft. of discharge-hose and spray fan and nozzle complete, is £5 10s. 0d. for a 3-inch pump and £5 for a 2½-inch pump.

Of suction and force pumps may be also recommended the "Handy" or Semi-rotary Wing Pump mounted on wheels (Fig. 56). These are priced by Messrs. W. Leslie & Co., of Calcutta, at Rs. 125. They raise 300 to 500 gallons of water per hour.

Handier syringe pumps are specially adapted for applying

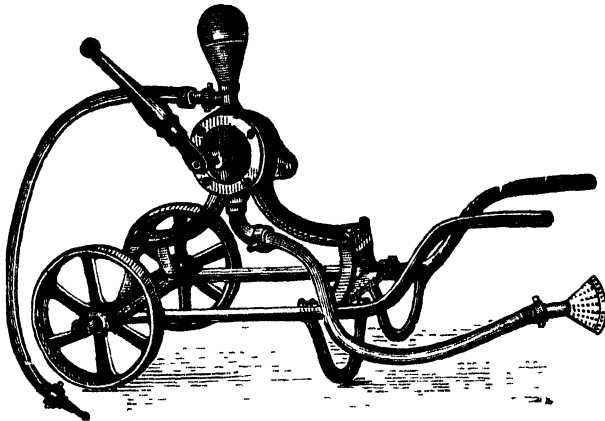

FIG 56.—SEMI-ROTARY WING PUMP.

insecticides and fungicides. Of these may be recommended Messrs. Heathman's Brigade Suction Pump, made of brass and copper. It ejects to a distance of about 30 ft. 300 gallons of liquid per hour. With 6 ft. suction-hose and strainer, 2 ft. delivery-hose and nozzle, the price is 50 shillings. Extra suction-hose costs 1s. 2d. per foot and extra delivery-hose, 8½d. per foot.

**Centrifugal pumps** which do not possess valves and washers are not so liable to get out of order as ordinary suction and force pumps, and if such are made with multiplying wheels suitable for hand-driving, they may prove a boon to our raiyats. Centrifugal pumps are in common use in indigo plantations and in factories in this country, but these are worked with steam-power and they are too expensive for the ordinary raiyat.

---

\* J. H. Heathman & Co., Manufacturers, 2 & 37, Endell Street, London, W. C.

**Comparison of costs, etc.**—The centrifugal pump worked by an 8 H.-P. steam-engine and used for irrigation purposes at the Cawnpore Experimental Firm, irrigates four acres of land per day and it costs Rs. 5 per day in coal, oil and wages of the mechanic. The Cawnpore chain pump worked by 2 men (4 men being required for working it without interruption) irrigates about an acre a day at a cost of about eight annas where the water is within 4 ft., as at Cawnpore. Where the water is deeper, say 10 to 12 ft., as at Sibpur, the Barakar pump (which is very like the Cawnpore pump) is able to irrigate only one-third of an acre a day, *i.e.*, less than the swing-basket does, and the wages of labour also are at Sibpur double what they are at Cawnpore, so that the cost per acre is about Rs. 3 at Sibpur against eight annas, the cost incurred at Cawnpore. The Baldeo Water-lift irrigates about one-third of an acre per day at a cost of six annas (one bullock and one man) under conditions prevailing at Cawnpore. The Stoney's Water-lift worked by a strong pair of bullocks, and a man irrigates from a deep well of 30 to 40 ft. about one-third of an acre per diem at a cost of 12 annas (about Re. 1-8 in Calcutta). On sandy soils less work can be done and on stiff clay-soils more. The figures given apply to a medium loam. It is important to compare these high class or improved irrigation appliances with those in common use in this country, *viz.*, the swing-basket, the *terí* or *láthí*, the *dôn*, the single and double *môt* and the single Persian Wheel (Punjab pattern). (1) To work the swing-basket three men at least are required, the man distributing the water relieving in turn the two men employed in baling out the water. The height to which the water can be lifted with the swing-basket is from 5 up to 10 ft. About one-third of a cubic foot of water is thrown up each time, and there are about 20 deliveries per minute, which gives 400 cub. ft. of water per hour. If 25 per cent. is allowed for wastage, percolation, etc., the actual discharge comes to 300 cub. ft., *i.e.*, 1,890 gallons. (2) To work the *terá*, *láthá* or *dhenkh* (*i.e.*, the ordinary lever and bucket-lift) one man is employed at the bucket and one man for distributing the water. The water can be easily raised 16 ft. high. The contents of the bucket or *dól* is about half a cubic foot. The number of discharges per minute is about three. The discharge per hour is therefore 90 cub. ft. Allowing 10 per cent. in this case for wastage, we get about 81 cub. ft.—500 gallons per hour. (3) The *dôn* or canoe-shaped lift, made of trunks of trees hollowed out or of iron (iron *dóns* being now in common use in Birbhum and Murshidabad), is also worked by one man. It raises water only up to a height of 5 or 6 ft. There are 10 deliveries per minute, each delivery being about 3 cub. ft.; 1,800 cub. ft. are thus lifted per hour. Waste of only about 10 per cent. takes place in this case. The actual quantity of water lifted is therefore 1,620 cub. ft., which at  $6\frac{3}{8}$  gallons per cub. ft. gives 10,206 gallons per hour. (4) To work the single *môt* with self delivery tube, one man and two bullocks are required, besides the man distributing

the water. Water can be lifted from a depth of 40 to 80 ft. The bullocks walk at the rate of 2 miles an hour. For each lift of 40 ft. the bullocks traverse 80 ft. The contents of the bag or bucket is 3 cub. ft. The number of lifts per minute is only one. So the discharge per hour is  $60 \times 3$ , i.e., 180 cub. ft. Allowing 25 per cent. of loss by spilling 135 cub. ft. or 850 gallons per hour is the result obtained. But whereas, at the Sibpur farm, spilling is avoided by the bucket being made to slide up two tight steel ropes as in Stoney's Water-lift, the loss may be put down at only 10 per cent., and in that case we get over 1,000 gallons per hour. The draught or traction required being 255 lb., two bullocks are essential. (5) The double *môt* also requires one man and two bullocks. The diameter of the whim being 3 ft. and the diameter of the bullock-walk being 16 ft., the bullocks walking at the rate of 2 miles per hour can take 3.4 turns per minute. The time taken for raising the bag or bucket from a depth of 40 ft. is 1.4 minutes. The contents of the bag or bucket being 3 cub. ft., the discharge per hour from the two bags or buckets comes to 252 cub. ft., of which 35 per cent. may be calculated for wastage. Thus we arrive at 165 cub. ft. or 1,045 gallons per hour. The ratio of power to weight where the diameter of whim and bullock-walk are 3 ft. and 16 ft. is 3 : 16. The total weight raised each time being 460 lb., the draught exerted is 124 lb. or considerably less than in the case of the single *môt*. (6) To work the single Persian Wheel also one man and two bullocks (or even one bullock), besides the man distributing water, are required. The water being raised 40 ft., the diameter of the driving wheel being 4 ft., the diameter of the wheel to which the buckets or pots are attached being also 4 ft., assuming the content of each bucket one-eighth of a cubic foot and 6 buckets being emptied at each turn of the bullocks, the discharge at each turn comes to three-quarters of a cubic foot. The length of the bullock-walk being 62.8 ft., and the speed of bullocks being 2 miles an hour, the bullocks make 2.8 turns per minute. The discharge per hour is therefore 126 cub. ft., of which 45 per cent. may be allowed for wastage. The actual discharge thus comes to 69.3 cub. ft. or 429 gallons per hour. The buckets being tied 2 ft. apart from middle to middle, the number of buckets in one endless chain is 40. The weight of buckets is about 180 lb. Twenty buckets being always full, the weight of water they contain is 156 lb. The weight of the rope is 22 lb. The total weight raised is therefore 258 lb. The modulus being .6, the power required to raise 258 lb. is 430 lb. The ratio between this power and the power exerted by bullocks being about 1.5, the draught or power exerted is only 86 lb., which is lighter still than in the case of the double *môt*. Such a Persian Wheel can be worked by one bullock only.

From the above figures it may be seen that the native irrigation appliances are by no means to be despised, and that taking all things into consideration we come to the following conclusions :—

(1) The *dîn* is the best implement for Indian use for small depths (up to 6 ft.), its lifting capacity being 10,000 gallons per hour. (2) Next to it comes the swing-basket, which in the hands of dexterous coolies will lift about 2,000 gallons of water per hour from a depth of 10 ft. (3) For medium depths, either a double or triple series of *dîns*, or the lever and bucket-lift (*terî*) is the best. 500 gallons of water can be raised per hour with the *tera*. (4) For great depths, the single and double *môt* and the Egyptian or Punjab pattern Persian Wheel are the best. The *môts* will give about 1,000 gallons per hour, and the Persian Wheel about 500 gallons. Considering the cost, the single *môt* is to be preferred to all others for great depths, and to adapt ordinary ring wells of only 3 ft. diameter, and to avoid spilling of water, the bucket can be made to slide up two steel ropes stretched vertically from the bottom of the well up to the beam whence the pulley is suspended. To irrigate an acre of land, 50,000 gallons are required for clay soils, and 100,000 gallons for sandy loams. The latter quantity is equivalent to about half an inch of rainfall, which is enough to soak thoroughly six inches of soil. For more thorough irrigation double the above quantities may be allowed, *viz.*, 100,000 gallons per acre for clay soils and 200,000 gallons per acre for sandy loams, and the arrangements needed for irrigating a particular locality with any of the water-lifts or pumps described above, can be worked out for every particular locality.

## CHAPTER XVI.

### OTHER AGRICULTURAL IMPLEMENTS.

[Bull's dredger, rice-huskers, chaff-cutters, root-cutter, root-pulper, kibbler, oil-cake-crusher, meal-grinder, hay-trusser, oil-mill, feeding troughs and hurdles, bone and stone-grinder, maize-huller, cotton gin, sugar-cane mill, silos, dairy implements; insecticidal and fungicidal appliances; carts; balances (steel-yard); tea and coffee planters' machinery; machinery found useful in the Sripur Farm.]

Of other implements and machinery that are or may be used in agricultural operations may be mentioned the following:—

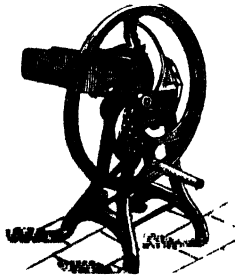

FIG. 57.—CHAFF-CUTTER

(1) *Bull's Dredger* for sinking wells. These are made in the workshop of the Cawnpore Experimental Farm and sold for Rs. 180 to Rs. 210.

(2) *Rice-huskers* or hullers and polishers, which will be dealt with separately in the next part in connection with the rice crop.

(3) *Chaff-cutter* (Fig. 57), by Messrs. Burn & Co., price Rs. 53.

(4) *Root-cutter*.—Ordinary *dao* or *kâtîri* does the work more slowly.

(5) *Root-Pulper*.—*Dhenki* with cemented mortar answers fairly well.

(6) *Kibbler* or a mill for crushing grain, oats, maize, barley and other corn. One crushing three bushels of corn per hour is sold at the Cawnpore Experimental Farm for Rs. 35.

(7) *Oil-cake Crusher*, by Messrs. Oakes & Co., of Madras, price Rs. 57.

(8) *Steel hand-mill for grinding wheat* for whole-meal (*áttá*), also barley, oats, maize, etc., by Messrs. Burn & Co. The Flour Dressing Machine No. 5 is said to grind and dress 30 to 45 seers per hour, and it is priced Rs. 210.

(9) *Hand-power hay-trusser*.

(10) *Ghání, Kolu* or *Oil-mill*.

(11) *Feeding troughs and hurdles*.

(12) *Bone-mill* and *stone-grinder*.

(13) *Maize-huller* (Fig. 58).

(14) *Cotton-gin*.—The Macarthy Hand-Cotton-gin (price Rs. 220), obtainable of Messrs. N. D. Maxwell & Co., of Bombay, cleans 140 lb. of cotton in seed per diem, about one-third lint and two-thirds seed (according to the variety of cotton ginned) being obtained. The seed is not injured and it remains fit for sowing.

(15) *Sugar-cane mill, etc.*, to be described in Part III in connection with the sugar-cane crop.

(16) *Silos* to be described in Part V in connection with fodder crops.

(17) *Dairy implements*, to be described in Part V in connection with milch-cows.

(18) *Appliances for spraying or dusting insecticides and fungicides*, to be described in connection with Insect and Fungus Pests.

(19) *Carts*.

(20) *Balances*.—Platform weighing-machines, though highly useful for experimental farms where weighing of cattle or of cartloads of crops, straw, manure, etc., has to be done, are too expensive for ordinary agricultural use. The common scale-beam with wooden pans and iron weights, obtainable in bazaars, is the best for such use. As weights are liable to get lost if they are too frequently used for daily weighings of small quantities up to 50 lb., the balance best adapted is the steel-yard.

Fig. 59 represents the position of the steel-yard in which weights from 2 to 16 lb. can be determined, as the figures marked on the iron-bar will show. It should be hung on something high by the hook nearest to the arm. The middle hook will not be used at all in this case. The article to be weighed is to be hung on the double hooks. This being done, move the weight on the arm or bar till it assumes a perfectly horizontal position. The figure on which the weight will rest will indicate the weight in pounds of the article weighed. Figure 60 represents the position of the same instrument reversed, in which weights from 15 to 50 lb. can be determined

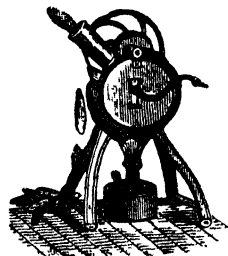

FIG. 58.—MAIZE-HULLER.

as is shown by the figures on the iron-bar or arm. In this case, the steel-yard is suspended by the middle hook and the hook nearest the arm is not used at all.

(21) Machinery for tea, indigo, coffee and other planting enterprises in which European capital and intellect are employed

FIG. 59.—STEEL-YARD FOR WEIGHING UP TO 6 lbs.

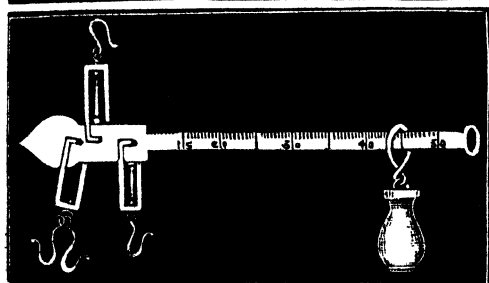
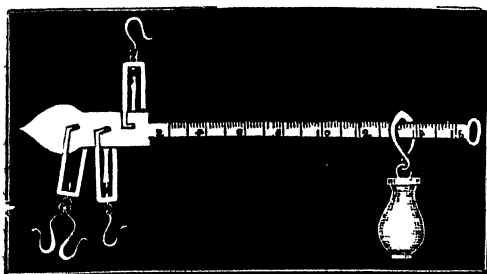

FIG. 60.—STEEL-YARD FOR WEIGHING 15 TO 50 lb. (60 RESERVED).

(2) Donaldson's Patent Oil-mill, by Messrs. Jessop & Co., Calcutta, and costing Rs. 120 which was found more economical and efficient than the local *Kolu*, when two or three are worked together with the help of steam-power.

(3) Two and Three-Coulter Native Seed Drill worked by bullocks with some training.

(4) South Indian bullock hoes.

(5) The Behar Indigo-Drill used for drilling oats and wheat.

(6) Assam Cotton-Gin, which was found more efficient than the Country Cotton-Gin, and which is worked with treadles.

are hardly necessary to be described in a handbook of agriculture, though these subjects will receive some attention in their proper places in Part III.

The following implements and machinery have been reported by Mr. N. N. Banerji as having been tried and found useful in the Sripur Farm, Hatwa Raj, District Saran :—

(1) A Steam Thresher, by Messrs. Ben, Reed & Co., Aberdeen, costing Rs. 3,500, and adapted for threshing oats, wheat, barley, etc., and turning out 8 maunds of grain per hour.

## CHAPTER XVII.

### EQUIPMENT OF FARMS.

[Principles governing equipment of farms of different classes; a typical case; inferences as to capital charges and annual expenditure per acre; outturn and expenditure in ordinary farming balance each other.]

**Principles stated.**—Having described the principal agricultural machinery that are or may be employed with advantage in this country, it now remains for us to find out some principles of equipment that may be applied in each case. We have said that heavy soils require a large number of cattle and men and consequently a larger number of some of the cultivating appliances than light soils. There is another consideration that will materially affect the question of equipment, *viz.*, the system of farming adopted. One labourer for two acres and one yoke of oxen for every five acres of heavy land is the allowance for ordinary arable or mixed farming. Where gardening instead of farming is the system mainly employed, *e.g.*, in market-gardening near large towns, where the largest outturn from the smallest area by high farming is the aim, the allotment for cattle and farm implements should be insignificant and the allotments for hand-labour, garden-tools (spade, hoe, rake, scissors, *dio*, etc.), and manure should be higher. In ordinary arable farming, so far as manure is concerned, the aim should be (1) feeding the bullocks well with oil-cake, which enriches the natural manure of cattle, (2) fallowing, (3) growing of leguminous crops, and (4) returning to the land the straw in the form of litter mixed with urine. But in growing special crops, such as tobacco, mulberry, sugar-cane and potatoes, direct manuring is essential. The equipment needed in each case thus depends on the land chosen, the crops chosen, and the system of farming adopted. In dairy farming again, no allotment is necessary for manure, and proportionately less allotment is needed for bullocks, farm labourers, ordinary agricultural implements, but for stocking the land with suitable cows and one or more bulls, for providing fodder at all seasons, for equipping a proper dairy, special allotments are needed. Then, again, the allotment for buildings and implements should be proportionately higher for a small farm than for a large farm. If Rs. 10 per acre is set apart for buildings, Rs. 10 per acre for implements and Rs. 10 per acre for cattle, for a 500-acre farm, and Rs. 50 per acre per annum for working the farm, it should be sufficient. Though Rs. 10 per acre for cattle and Rs. 50 per acre per annum for expenses will answer for a 10-acre farm, Rs. 10 per acre for buildings and Rs. 10 per acre for implements will hardly suffice in that case; but a man with a 10-acre farm ought to work with his own hands and live cheap, and in this country such a man would not actually spend more than Rs. 100 for a house and Rs. 100 for implements. Local circumstances also determine cost. In healthy localities cheap buildings answer. In places close to town there are certain special facilities and disadvantages.



In an *experimental farm* again, where the fodder, the dung, the urine, etc., have to be weighed, where small lots of corn have to be separately thrashed, dried, weighed and stored, where detailed accounts of experiments have to be recorded, more money must be spent on buildings, implements, the supervising staff and labour force, if the experiments are to give really reliable results. Manures also must be bought in an experimental farm. For such a farm Rs. 20 per acre on each item instead of Rs. 10 will be needed and Rs. 100 per acre for annual expenditure; while the outturn per acre for such a farm may come to less than Rs. 50 per acre.

As the circumstances may thus vary almost infinitely, and as we shall separately estimate the cost of growing each of the principal crops, our aim for the present will be to give a typical example, draw certain definite conclusions from it, and recommend the application of these deduced principles in each particular case, *mutatis mutandis*. In fact, we have already hinted what we are going to do, *i.e.*, infer from a typical case of a 400-acre farm in Lower Bengal, that about Rs. 10 per acre should be allotted for buildings, Rs. 10 per acre for cattle, Rs. 10 per acre for implements, by way of capital charge, and Rs. 50 per acre by way of annual expenditure. If, however, the farm is very much smaller, an increased proportion for buildings and implements, and if the farm is very much larger, a diminished proportion for buildings and implements will be needed. The principle enunciated here refers only to mixed farms and not to gardens or plantations.

**Capital charge.**—(1) Laying out at Rs. 10 an acre (*i.e.*, cutting down trees, burning low bushes, levelling, and making roads, and channels), Rs. 4,000. (2) 160 bullocks at Rs. 25 (*i.e.*, Rs. 10 per acre), Rs. 4,000. (3) Cost of buying the principal implements, etc., required for a farm of 400 acres of heavy arable land like that of the Sibpur Farm, which are :—

|  | Rs. |
|--|-----|
| 16 Carts .. ..                               | 240 |
| 1 Water-Cart .. ..                           | 100 |
| 1 Spring-Cart for market .. ..               | 200 |
| 1 Pony with harness for market .. ..         | 100 |
| 1 Gun for killing jackals, etc. .. ..        | 100 |
| 80 Improved ploughs .. ..                    | 640 |
| 2 Ridging ploughs .. ..                      | 100 |
| 4 Five-tinned grubbers .. ..                 | 80  |
| 4 Zig-zag harrows .. ..                      | 160 |
| 4 Bakhars .. ..                              | 20  |
| 4 Wooden rollers .. ..                       | 80  |
| 8 Ladders .. ..                              | 4   |
| 4 Beam-harrows .. ..                         | 20  |
| 1 American Seed-drill .. ..                  | 50  |
| 4 Wide bullock-hoes ( <i>Dundras</i> ) .. .. | 32  |
| 4 Narrow bullock-hoes .. ..                  | 20  |
| 8 Planet Junior Hand-hoes .. ..              | 160 |

|  | Rs. |
|--|-----|
| 2 Chaff-cutters .. .. .  | 80  |
| 1 Corn-crusher .. .. .   | 40  |
| 1 Cake-crusher .. .. .   | 100 |
| 1 Turnip pulper .. .. .  | 100 |
| 40 <i>dóns</i> .. .. .   | 400 |
| Other suitable irrigation appliances, <i>mót</i> ,<br>etc. .. .. . | 500 |
| 20 Dozen hurdles .. .. .   | 250 |
| Scales and weights for weighing up to 2<br>mds. .. .. .            | 20  |
| 1 Steel-yard .. .. .   | 4   |
| 1 Small pair of scales and weights .. .. .                         | 2   |
| 1 Grindstone, 24" diameter .. .. .                                 | 20  |
| 4 Scythes .. .. .  | 40  |
| 20 Hooks or sickles .. .. .  | 8   |
| 1 Hand-thresher .. .. .  | 200 |
| 1 Winnower .. .. .   | 65  |
| Chains, rope, bamboos, etc. .. .. .                                | 115 |

Rs. 4,000

*i.e.*, Rs. 10 per acre for implements.

|                                      | Rs.   |
|--------------------------------------|-------|
| Sheds for 100 resident labourers     | 2,000 |
| Covered shed for manure pits .. .. . | 200   |
| Shed for bullocks .. .. .            | 300   |
| Barn and godown .. .. .              | 1,000 |
| House for residence of Farm Overseer | 500   |

Rs. 4,000

*i.e.*, Rs. 10 per acre for sheds and godowns.

Hedging and ditching should be done when a farm is started and they are included under "laying out" of the farm. The mere clearing of the jungle costs about Rs. 3 per acre, if the work is done on contract. This item is necessary only when a farm has to be started quite fresh from land in jungle.

The *annual expense* of working the above farm can be estimated thus :—

|  | Rs.    |
|--|--------|
| 200 labourers at Rs. 6 per month .. .. .                                 | 14,400 |
| Overseer or bailiff on Rs. 50 .. .. .                                    | 600    |
| Oil-cake @ 1 maund per bullock per<br>month, @ Re. 1-8 per maund .. .. . | 3,000  |
| Rent .. .. .   | 1,200  |
| Other expenses .. .. .   | 800    |

Rs. 20,000

*i.e.*, Rs. 50 per acre.

By ordinary farming, *i.e.*, by cultivating rice and pulses, with hired labour, a capitalist cannot expect to make farming pay in this country. Fifteen maunds of paddy and ten maunds of pulses per acre are obtained and when these are sold at Rs. 2 a maund the yield is only Rs. 50 per acre. By judicious cropping, two crops can be taken every year out of the land, or one crop of double value such as sugar-cane, tobacco, jute, etc., or a crop which costs much less in cultivating, as maize, pulses, etc. But the average outturn per acre from mixed farming may be safely put down at Rs. 50 and the cost also is at Rs. 50. Ordinary farming therefore just keeps the cultivators who are their own field labourers, and it pays them no better than service as a coolie.

It is only by growing special crops, such as sugar-cane, jute, etc., that a capitalist or a gentleman-farmer may hope to make farming pay. But it is never safe to rely on one crop only, and it is best to choose four or five paying crops, and grow these in rotation, though the cost of growing such crops is greater. An acre of sugar-cane will cost in Bengal about Rs. 150 growing, but the *gur* from it may be worth Rs. 200 or more. What each principal crop costs and what outturn we may expect from it, is a question which we will discuss in the next part of the handbook.

We should mention here that one-tenth of the land should be set apart for roads and paths, and one-tenth for farmstead, canals, water-courses and irrigation channels.

## PART III. CROPS.

### CHAPTER XVIII.

#### BOTANICAL CLASSIFICATION OF CROPS. ,

[Principal Indian crops coming under Gramineæ, Cyperaceæ, Amaryllidaceæ, Liliaceæ, Aroidæ, Bromeliaceæ, Dioscoreæ, Musaceæ, Zingiberaceæ, Cannaceæ, Piperaceæ, Euphorbiaceæ, Moreæ, Sesameæ, Solaneæ, Convolvulaceæ, Cucurbitaceæ, Leguminosæ, Linæ, Tiliaceæ, Malvaceæ, Cruciferae, Compositæ, Polygonaceæ, Chenopodiaceæ, Umbelliferae, Urticaceæ, and Onagraceæ; Character of these crops; soils on which each grows.]

#### *Abbreviations explained:—*

[Ce=Cereal crop; F=Fodder; M=Miscellaneous crop; Fb=Fibre-crop; V=Vegetable crop; R=Root-crop; Ft=Frut; Sp=Spices; O=Oil-seed-crop; T=Timber; D=Drug; De=Dye; P=Pulse crop; P H=Pot-herb; Cl=Clay; L=Loam; S=Sandy soil; St=Stony soil; Bl=Bil land.]

THE principal agricultural crops, etc., may be thus exhibited under the various natural orders to which they belong:—

#### A. MONOCOTYLEDONS.

##### (I) GRAMINEÆ—

1. Paddy (*Oryza sativa*), Ce (Cl, L & S for Aus).
2. Wheat (*Triticum sativum*), Ce (Cl & L).
3. Barley (*Hordeum hexastichum*), Ce (L & S).
4. Oats (*Avena sativa*), Ce & F. (L, Cl, S & St).
5. Deodhan or Juar (*Andropogon sorghum*), Ce & F (L, S & St).
6. Cheena (*Panicum miliaceum*), Ce & F (S).
7. Kayon (*Panicum Italicum*), Ce (S).
8. Maize (*Zea mays*), Ce (Cl, L & St).
9. Shámá or Bhura (*Panicum frumentaceum*), Ce & F (S & St).
10. Gondli (*Panicum miliare*), Ce (S. & St).
11. Menjhri (*Panicum pilopodeum*), Ce (S. & St).
12. Maruá (*Eleusine coracana*), Ce (S & St).
13. Kodo (*Paspalum scrobiculatum*), Ce (S & St).
14. Bájrá (*Pennisetum typhoideum*), Ce (S & St).
15. Ulu or thatching grass (*Imperata arundinacea*), M (Cl & L).
16. Káshá, *khág* or reed (*Saccharum spontaneum*), M (S).

(I) GRAMINEÆ—*contd.*

17. Sugarcane (*Saccharum officinarum*), M (Cl & L).
18. Munj (*Saccharum ciliare*), Fb (St).
19. Durba (*Cynodon dactylon*), F (Cl).
20. Bamboo (*Bambusa arundinacea*), M (Cl, & L & St).
21. Latá-grass or para-grass (*Panicum muticum*), F (Cl).
22. Erá-kati (*Ischæmum rugosum*), F (Cl).
23. Guinea-grass (*Panicum jumentorum*), F (Cl, St & L).
24. Spear-grass (*Heteropogon contortus*), F (St).
25. Roisa and Poina grasses (*Andropogon* Sp), M (St).

## (II) CYPERACEÆ—

1. Mádur Kathi (*Cyperus tagetum*), M (L).
2. Chuḡa (*Scirpus kysoor*), M (Bl).
3. Muthá grass (*Cyperus rotundus*), F (Cl & L).

## (III) AMARYLLIDACEÆ—Agaves, Fb (S &amp; St).

## (IV) LILIACEÆ—

1. Onions (*Allium ascalonicum*), V (L).
2. Garlic (*Allium sativum*), V (L).
3. Asparagus (*Asparagus officinalis*), V (L).
4. Yucca gigantea, aloifolia, and gloriosa, Fb (Cl)
5. *Dracæna ovalifolia*, F (Cl).
6. *Sansievierias*, Fb (L).

## (V) AROIDEÆ—

1. Mán-Kachu (*Alocasia indica*), R (L).
2. Kachu (*Colocasia antiquorum*), R & V (L).
3. Ol (*Arum Campanulatum*), R (L & S).

(VI) BROMELIACEÆ—Pineapple (*Ananas sativa*), Ft & Fb (L).

## (VII) DIOSCOREÆ—

1. Khím álu (*Dioscorea sativa*), R (Cl & L).
2. Chupri alu (*Dioscorea globosa*), R (Cl & L).
3. Lál garaniya alu (*Dioscorea purpurea*), R (Cl & L).
4. Sutni-álu (*Dioscorea fasciculatá*), R (L & S).

(VIII) MUSACEÆ—Plantains (*Musa Sapientum*), Ft & V (Cl & L).  
Manila hemp (*Musa textilis*), Fb (Cl & L).

## (IX) ZINGIBERACEÆ—

1. Ginger (*Zingiber officinale*), Sp (L & S).
2. Turmeric (*Curcuma longa*), Sp (L & S).
3. Amada (*Curcuma amada*), Sp (L & S).
4. Sathi or zedoary (*Curcuma zedoaria*), R (L & S).

## (X) CANNACEÆ—

1. Arrowroot (*Maranta arundinacea*), R (L & S).
2. *Canna Edulis*, R (L & S).

## (B) DICOTYLEDONS.

## (XI) PIPERACÆ—

1. Betel (Piper betle), Sp (Cl & L).
2. Long pepper (Piper longum), Sp (Cl).
3. Chai (Piper chaba), Sp (L & S).
4. Round pepper (Piper nigrum), Sp (Cl).

## (XII) EUPHORBIACÆ—

1. Castor (*Ricinus communis*), O (S & St).
2. Cassava (*Manihot utilissima*, and *airi*), R (L & S).
3. Ceara rubber (*Manihot Glaziovii*), M (St).
4. Papaya (*Carica papaya*), Ft & V (Cl & St).

(XIII) MOREÆ (*Mulberry*)—

1. *Morea alba*, F and Ft (Cl & St).
2. *Morea serrata*, F, T and Ft (Cl & St).
3. *Morea nigra*, Ft (Cl & St).

(XIV) SESAMEÆ—Sesamum, gingelly or *tal* (*Sesamum indicum*),  
O (S & L).

## (XV) SOLANÆ—

1. Potatoes (*Solanum tuberosum*), R (L & S).
2. Brinjals (*Solanum melongena*), V (L & S).
3. Kulibegun and bāromeshe begun (*Solanum longum*), V (L & S).
4. Chillies (*Capsicum frutescens*), Sp (L, St & S).
5. Teepari or Cape Gooseberry (*Physalis peruviana*), Ft (C & L).
6. Tomato (*Lycopersicum esculentum*), V (Cl & L).
7. Tree-tomato or Java plum (*Cyphomandra betacea*), Ft (St & L).
8. Tobacco (*Nicotina rustica* & *Nicotana tabacum*), D (L).

(XVI) CONVULVULACÆ—Ranga-alu, sáda-álu (*Batatus edulis*),  
R (S & L).

## (XVII) CUCURBITACÆ—

1. Líu (*Lagenaria vulgaris*), V (S & L).
2. Kumrú, biliti and deshi (*Cucurbita maxima* and pepo), V (S & L).
3. Uchhe (*Momordica muricata*), V (S & L).
4. Jhinga (*Luffa acutangula*), V (S & L).
5. Dhundul (*Luffa Ægyptiaca*), V (S & L).
6. Tarmuj (*Citrulus vulgaris*), Ft (S).
7. Khero (round cucumber), V (S & L).
8. Shasha (ordinary cucumber), (*Cucumis sativus*) V and Ft (Cl & L).
9. Phuti (*Cucumis momordica*), Ft (S & L).
10. Gomukh (*Cucumis maderaspatanus*), V (S).
11. Kánkri or bákharí (*Cucumis utilissimus*), V (S).
12. Kánkrol (*Momordica Cochinchinensis*), V (St & L).

**(XVII) CUCURBITACEÆ—contd.**

13. Karala (*Momordica charantia*), V (S & L).
14. Chichinga (*Trichosanthes anguina*), V (S & L).
15. Patal (*Trichosanthes dioica*), V (S).
16. Kundruki (*Trichosanthes diseca*), V & Ft (L & St).

**(XVIII) LEGUMINOSÆ—**

1. Peas (*Pisum arvense*), P (L & S).
2. English peas (*Pisum sativum*), V (L).
3. Payra Matar (*Pisum quadratum*), P (L & Cl).
4. Kalái (*Phaseolus radiatus*), P (S & Cl).
5. Mug (*Phaseolus Mungo*), P (L & Cl).
6. Gram (*Cicer arietinum*), P (Cl & L).
7. Musuri (*Ervum lens*), P (Cl & L).
8. Khesari (*Lathyrus sativus*), P (Cl & L).
9. Arahar (*Cajanus indicus*), P (Cl).
10. Rambha and Barbati (*Vigna catianga*), P & V (Cl & St).
11. Sunn-hemp (*Crotolaria juncea*), Fb (S).
12. Indigo (*Indigofera tinctoria*), De (S & L).
13. Dhaincha (*Sesbania aculeata*), Fb (Cl).
14. Sajná (*Moringa pterygosperma*), V (Cl & St).
15. Bhringi (*Phaseolus aconitifolius*), P & F (Cl & L).
16. Kulthi (*Dolichos biflorus*), P & F (S & St).
17. Arharia Sim (*Cyamopsis psoraloides*), F & V (Cl, L & S).
18. Ground-nut (*Arachis hypogea*), O (S).
19. Babul (*Acacia arabica*), F, T & De (Cl & St).
20. Palas (*Butea frondosa*), M (Cl & St).
21. Baklá (*Vicia faba*), P (L).
22. Sim (*Dolichos lablab*), P & V (Cl & L).
23. Mákhan Sim (*Canavalia gladiata*), V (Cl & L).
24. Sola (*Aeschynomena aspera*), M (Bl).
25. Tamarind (*Tamarindas indica*), S (Cl & St).
26. Soy Bean (*Glycine soja*), V (S & St).
27. Sank-álu (*Pachyrhizus angulatus*), R (L).

**(XIX) LINEÆ—Linseed (*Linum usitatissimum*), O (L & C).****(XX) TILIACÆ—**

1. Sirajgunj Jute (*Corchorus capsularis*), Fb & P H (Cl & L).
2. Deshi Jute (*Corchorus olitorius*), Fb (Cl & L).

**(XXI) MALVACEÆ—**

1. Cotton or Kápás (*Gossypium herbaceum & arboreum*), Fb (L, S & St).
2. Silk-Cotton or Simul (*Bombax malabaricum*), Fb (Cl & St).
3. Musk-mallow (*Hibiscus abelmoschus*), Fb and D (S & L).
4. Ambari hemp or mestá-pát (*Hibiscus cannabinus*), Fb (S & L).
5. Roselle or mestá (*Hibiscus sabdariffa*), V (Cl & L).
6. Bhindi or Ladies' finger (*Hibiscus esculentus*), V (Cl & S).

**(XXII) CRUCIFERÆ—**

1. Mustard (*Brassica campestris* and *juncea*), O (S & L).
2. Cabbages, Cauliflower and Kohl rabi (*Brassica oleracea*), V (Cl & S L).
3. Turnips (*Brassica napa*), V (L & S).
4. Radishes (*Raphanus sativus*), V (L & S).
5. Taramani (*Eruca sativa*), O (L & Cl).

**(XXIII) COMPOSITÆ—**

1. Sunflower (*Helianthus annuus*), O (L & S).
2. Artichoke (*Cynara scolymus*), V (S & L).
3. Jerusalem artichoke (*Helianthus tuberosus*), V (S).
4. Safflower (*Carthamus tinctorius*), O & De (S).
5. Lettuce (*Lactuca sativa*), V (L & S).
6. Sorguja or Niger (*Guizotia abyssinica*), O (S & St).

**(XXIV) POLYGONACEÆ—Buck-wheat (*Fagopyrum esculentum*)  
Ce (S & St).****(XXV) CHENOPODIACEÆ—**

1. Beet and mangold (*Beta vulgaris*), V & F (L & S).
2. Pálam (*Beta bengalensis*), P H (L).
3. Chukapálam (*Rumex vesicaris*), P H (L).

**(XXVI) UMBELLIFERÆ—**

1. Carrot (*Daucus carota*), V (S & L).
2. Celery (*Apium graveolens*), V & Sp (L).
3. Coriander (*Coriandrum sativum*), Sp (L & S).
4. Anise (*Pimpinella anisum*), Sp (L & S).

**(XXVII) URTICACEÆ—**

1. Rhea (*Bœhmeria nivea*), Fb (Cl).

**(XXVIII) ONAGRACEÆ—**

1. Water-nut or *Singhírú* (*Trapa bispinosa*), Ft (Bl).

## CHAPTER XIX.

## ECONOMIC CLASSIFICATION OF CROPS.

[Indian cereals, pulses, oil-seeds, fibres, dyes, drugs, spices, table-vegetables, pot-herbs, fruits, fodder-crops, roots, timber trees, and miscellaneous crops.]

CROPS are divided into—

(1) Cereals (Ce), *e.g.*, rice, wheat, buck-wheat, millets, maize, etc.

(2) Pulses (P), *e.g.*, gram, peas, lentils, horsegram (kulthi), pigeon-pea (arahar), cow-pea (barbati), etc.

(3) Oil-seeds (O), *e.g.*, rapeseed, mustard, linseed, gingelly, niger-oil-seed, castor, ground-nut, bhela (*Semecarpus anacardium*), kurunja (*Galedupa indica*) and pittaraj (*Amoora rohituka*), etc.



(4) Fibres (Fb), *e.g.*, jute, sunn-hemp, cotton, musk-mallow, munj-grass, aloe (*Agave lurida* and other agaves), Manila hemp, (*Musa textilis*), Mauritius hemp (*Furcraea gigantea*), rhea, *ulat-kambal* (*Abroma augusta*), etc.

(5) Dyes (De.), *e.g.*, indigo, safflower, arnatto (*Bixa orellana*), *palás*, *haritaki* (*Terminalia chebula bahera* (*Terminalia belerica*), *ámlaki* (*Phyllanthus emblica*), aich or al (*Morinda sitrifolia*), etc.

(6) Drugs (D), *e.g.*, Cinchona officinalis, *Plantago ovata* (Ishap-gul), *Acorus calamus* (*bach*), tea (*Camellia theifera*), *Coffea arabica*, *Nicotiana rustica* and *tabacum*, *Papaver somniferum*, *Cannabis sativa*, *Datura metel*, etc.

(7) Spices (Sp), *e.g.*, turmeric, ginger, *ámidí*, chillies, onions, garlic, coriander seed, *jira* (*Cuminum cyminum*), anise, fenugreek (*Trigonella foenumgræcum*), *rídhuní* (*Apium graveolens*), *tejjitá* (*Laurus cassia*), *sulpa* (*Fumaria parviflora*), *peepul*, *pín chai*, *keyaphul* (*Pandanus odoratissimus*), cardamom (*Amomum subulatum*), mint (*Mentha arvensis*), *supári*, etc.

(8) Table-vegetables (V), *e.g.*, potatoes, brinjals, radishes, yams, gourd, pumpkin (Deshi-kumra), bottle gourd (Láu), snake-gourd (Chichingí), ladies' finger, country figs or dumbur (*Ficus cunia*), roselle, beans, arums, Indian horse-radish, tomato, cabbage, cauliflower, knol-kol, turnip, carrot, beet, lettuce, artichoke, Jerusalem artichoke, *palval*, asparagus, etc., etc.

(9) Pot-herbs or sags (PH), *e.g.*, Indian Spinach or Puinság, (*Basella alba* and *rubra*), Kalmi-ság (*Ipomæa serpiaria*), Champ-noté ság (*Amarantus polygamus*), Gobra noté (*Amarantus lividus*), Dengoság (*Amarantus giganteus*), Palam, Betoság (*Chenopodium viride*), helancha ság (*Hingcha repens*), Sushni ság (*Marselia quadrifolia*), etc.

(10) Miscellaneous crops (M), such as, sugar-cane, Madurkátí, bamboo, Ulu, Supari (*Areca catechu*), mulberry, asan (*Terminalia tomentosa*), cucumber, melons, chufa (*Scirpus kysoor*), Sank-alu, date (*Phoenix sylvestris*), sago (*Caryota urens*), etc.

(11) Fruits (F), *e.g.*, Mango (*Mangifera indica*), cocoanut (*Cocos nucifera*), Papaya (*Carica papaya*), Cashew nuts (*Anacardium occidentale*), jack (*Artocarpus integrifolia*), etc.

(12) Fodder crops (F), *e.g.*, Guinea-grass, spear-grass, sugar-sorghum, *Sorghum halipense*, lata-grass, *Reana luxurians*, Bhringi, etc.

(13) Yams, potatoes, turnips, arrowroot, cassava, cauliflower, cabbages, beet, carrots, etc., are sometimes called root-crops (R). Cucumbers, melons and water-nuts may be classed also as fruits as they can be eaten raw.

(14) Timber trees (T) can be hardly classed as agricultural crops, but the Bábul timber, being largely used for making agricultural appliances, and the fruits and leaves of this tree being in common use for feeding cattle, are largely grown by cultivators.

(15) Sandal-wood, Rosa grass and Poina grass yielding valuable essences are protected in the wild state, though not cultivated.

## CHAPTER XX.

## CHEMICAL COMPOSITION OF THE PRINCIPAL CROPS.

[Considered under the six heads—moisture, albuminoids, carbohydrates, fibres, fat and ash. Average composition of the commonest food-substances compared with that of agricultural crops; variability of composition chiefly of green and succulent.]

THE chemical composition of crops is usually considered under six heads, viz., (1) Water, (2) Albuminoid or flesh-forming matter, (3) Carbohydrates or heat-forming matter, (4) Fibre, (5) Fat and (6) Ash. Of these the albuminoids and the fat make the richest food. Carbohydrates though less concentrated, are also highly digestible. Fibres are more or less digested by ruminant animals, but in large quantity, they are not an economical component of food-substances. The ash constituents of plants are not altogether useless, though in estimating the feeding value of a crop, these may usually be neglected. The bones and the ash constituents generally of the animal frame are derived from the ash constituents of plants, and hence they have a great value. Before giving the chemical composition of the principal crops it is best to give at the outset the composition of the principal articles of food and fodder as a guide for judging the value of all food-substances and fodders.

*Average composition of the commonest food-substances.*

|                   | Water. | Albumi-<br>noids. | Carbohy-<br>drates. | Fibre.     | Fat. | Ash. |
|-------------------|--------|-------------------|---------------------|------------|------|------|
| Flesh .. ..       | 68.5   | 20.4              | <i>Nil</i>          | <i>Nil</i> | 10   | 1.1  |
| Fish .. ..        | 82.6   | 15.8              | <i>Nil</i>          | <i>Nil</i> | .4   | 1.2  |
| Flour .. ..       | 12.5   | 11.3              | 74.6                | <i>Nil</i> | 1.1  | .5   |
| Average cereal .. | 11.7   | 9.1               | 71.2                | 3          | 3    | 2    |
| Average pulse ..  | 10     | 24                | 52.5                | 7          | 3.5  | 3    |
| Potatoes .. ..    | 77.9   | 2.1               | 18                  | 1          | .1   | .9   |
| Turnips .. ..     | 91.7   | 1.1               | 5.3                 | 1          | .2   | .7   |
| Cabbages .. ..    | 89.5   | 1.5               | 7                   | 1.1        | .1   | .8   |
| Paddy straw ..    | 8.1    | 1.8               | 40.6                | 30.0       | 2.1  | 16.8 |
| Oil-cake .. ..    | 10.2   | 40.7              | 23.8                | 6.4        | 11.8 | 6.9  |

**Variability of Composition.**—The composition of grains and seeds is tolerably constant, but that of straw, leaves, roots and tubers, varies very considerably according to the variety, soil, manure and season. The same variety of wheat, rice, maize or any other grain or seed, has about the same composition, but different varieties often differ very much in composition. The hill rices, for instance, contain much more fat than the ordinary rices. With regard to fodders, the chemical composition differs very much according as the crops are cut in a mature or immature condition, and also according to the process of drying they afterwards undergo. Too much exposure to sun impoverishes them considerably.

The results of analyses of the principal fodders, grains, etc., are given in the following pages:—

|  | Moisture. | Insoluble siliceous matter. | Albuminoids. | Carbohydrates, starch, oil, etc.   | Woody fibre. | Ash.  | Total nitrogen. |
|--|-----------|-----------------------------|--------------|------------------------------------|--------------|-------|-----------------|
| 1. Fresh juár, 1st cutting (October).      | 56·10     | 2·54                        | 3·10         | 20·65                              | 15·32        | 4·83  | ·56             |
| 2. Fresh juár, cut in March (2nd cutting). | 63·77     | 4·07                        | 1·54         | 18·50                              | 10·35        | 5·84  | ·41             |
| 3. Dry juár (1st cutting).                 | Nil       | 5·78                        | 7·06         | 47·04                              | 34·90        | 11·00 | 1·28            |
| 4. Dry juár (2nd cutting).                 | Nil       | 11·24                       | 4·25         | 51·06                              | 28·56        | 16·13 | 1·15            |
| 5a. Fresh deodhán juár, (reaped ripe)      | 67·02     | 1·6                         | ·64          | 16·42                              | 12·78        | 3·14  | 1·73            |
| 5b. Do. (dry.)                             | Nil       | 4·85                        | 1·94         | 49·78                              | 38·75        | 9·52  | 1·05            |
| 6. Commissariat hay.                       | 11·07     | 6·72                        | 2·69         | 45·40                              | 32·07        | 8·77  | ·47             |
| 7. Ordinary hay (grass cut ripe).          | 9·81      | 12·01                       | 1·54         | 39·39                              | 34·58        | 14·68 | ·26             |
| 8. Do. (grass cut tender and green).       | 9·23      | 10·66                       | 2·46         | 44·16                              | 31·75        | 12·40 | ·41             |
| 9. English hay                             | ·15       | 2·                          | 10·          | 44·                                | 26·          | 6·    | 1·5             |
| 10. Sorghum halipense (reaped green)       | 70·96     | 2·2                         | 1·12         | 12·14                              | 12·57        | 3·52  | ·18             |
| 11. Sorghum halipense (reaped ripe).       | 67·02     | 1·6                         | 1·06         | 16·42                              | 12·78        | 3·14  | ·17             |
| 12. Deodhán or juár grain.                 | 9·96      | ·63                         | 7·66         | 77·84<br>(including 3·40% of oil). | 2·24         | 2·30  | 1·26            |
| 13. Juar bhusá.                            | 10·79     | 6·94                        | 2·24         | 51·57                              | 25·42        | 9·98  | ·48             |
| 14. Wheat bhusá.                           | 7·56      | 11·77                       | 2·37         | 43·06                              | 34·68        | 12·33 | ·50             |
| 15. Barley bhusá.                          | 7·93      | 6·25                        | 4·00         | 41·45                              | 34·82        | 11·80 | ·95             |
| 16. Oat bhusá..                            | 9·53      | 5·81                        | 1·37         | 43·48                              | 36·09        | 9·58  | ·35             |
| 17. Gram bhusá.                            | 10·11     | 9·30                        | 4·46         | 38·84                              | 27·63        | 18·96 | 1·00            |
| 18. Aráhar bhusá.                          | 6·58      | 8·37                        | 7·39         | 45·74                              | 25·69        | 14·60 | 1·5             |
| 19. Pea bhusá..                            | 9·88      | 5·73                        | 9·94         | 42·83                              | 22·27        | 15·08 | 2               |
| 20. Peas ..                                | 14·3      | ..                          | 22·4         | 54·5<br>(including 2% of oil).     | 6·4          | 2·4   |                 |
| 21. Oats ..                                | 13·0      | ..                          | 12·9         | 59·8<br>(including 6% of oil).     | 10·8         | 3·5   |                 |
| 22. Wheat ..                               | 14·4      | ..                          | 11·3         | 69·6<br>(including 1·5% of oil).   | 3·0          | 1·7   |                 |

|   | Moisture. | Albuminoids. | Fat.  | Soluble carbo-<br>hydrates. | Fibre. | Ash. |
|---|-----------|--------------|-------|-----------------------------|--------|------|
| 23. Barley ..                           | 14.0      | 10.6         | 2.0   | 63.7                        | 7.1    | 2.6  |
| 24. Maize ..                            | 11.0      | 10.5         | 5.1   | 68.5                        | 3.0    | 1.6  |
| 25. Wheat straw ..                      | 14.3      | 3.           | 1.5   | 32.6                        | 44.0   | 4.6  |
| 26. Rice ..                             | 14.5      | 6.5          | 0.5   | 76.00                       | 1.50   | 1.7  |
| 27. Potatoes ..                         | 75.0      | 2.1          | .3    | 20.5                        | 1.1    | 1.0  |
| 28. Turnips ..                          | 91.7      | 1.1          | .2    | 5.3                         | 1.0    | 0.7  |
| 29. Drumhead Cabbage<br>(inner leaves). | 89.42     | 1.50         | 0.08  | 7.01                        | 1.14   | 0.85 |
| 30. Carrot ..                           | 84.0      | 3.2          | ..    | 7.2                         | 3.1    | 2.5  |
| 31. Mangold ..                          | 90.0      | 2.0          | ..    | 3.8                         | 2.6    | 1.6  |
| 32. Linseed ..                          | 7.50      | 24.44        | 34.00 | ..                          | 30.73  | 3.33 |
| 33a. Rapeseed ..                        | 7.13      | 20.50        | 36.81 | 18.73                       | 6.86   | 8.97 |
| 33b. Do. ..                             | 7.12      | 18.00        | 41.33 | 23.26                       | 5.66   | 4.63 |
| 34. Cotton Seed ..                      | 6.57      | 22.60        | 31.24 | ..                          | 32.72  | 6.37 |
| 35. Lentils (musuri) ..                 | 13.00     | 24.00        | 2.    | 46.50                       | 10.00  | 2.5  |
| 36. Beans ..                            | 14.5      | 23.00        | ..    | 47.7                        | 10.00  | 3.8  |

## CHAPTER XXI.

## AGRICULTURAL STATISTICS.

[Uncultivated and cultivated areas; Area and yield under different crops; Relative importance of crops in Bengal.]

**Uncultivated Land.**— Agricultural statistics for India are still on the whole in an unreliable condition; those of the Native States being more unreliable than of British India. Indeed, very few Native States send in any returns. Still a good beginning has been made, and the figures, even regarded as mere estimates, are getting more and more reliable. With these remarks kept in view, the following figures compiled from the Agricultural Statistics for India for 1906-07 will be found interesting. The area of all Asiatic possessions of Great Britain, including India, is 1,100,800,000 acres. The area of British India professionally surveyed is 554,234,736 acres. The area under forests in British India is 67,136,162 acres. The area not available for cultivation in British India is 138,373,825

acres. The culturable waste in British India is estimated at 103,395,256 acres, to which may be added 10,550,759 acres in the few Native States like Mysore, Jaipur, Gwalior, etc., which submit returns. The area of fallow land in British India is estimated at 36,908,596 acres, and in the few Native States already mentioned 4,261,151 acres.

**Cultivated Land.**—The cropped area in British India is estimated at 208,901,314 acres, and in the Native States mentioned 15,002,673 acres, of which the irrigated areas are 34,244,590 acres and 2,125,202 acres, respectively.

**Area under the principal crops.**—The areas under the principal crops in British India in 1903-04 were :—

| Name of crop.            | Acreage.   | Average yield per acre. |
|--------------------------|------------|-------------------------|
|                          |            | lb.                     |
| Rice .. .. .             | 73,541,128 | 1,000                   |
| Wheat .. .. .            | 25,137,982 | 816                     |
| Barley .. .. .           | 7,700,100  | 922                     |
| ✓ Jowar .. .. .          | 20,781,722 | 686                     |
| ✓ Bajra .. .. .          | 15,033,742 | 550                     |
| ✓ Ragi .. .. .           | 3,567,712  | 873                     |
| ✓ Maize .. .. .          | 6,171,751  | 1,000                   |
| ✓ Gram .. .. .           | 13,293,149 | 642                     |
| Sugar-cane (gur) .. .. . | 2,456,861  | 2,575                   |
| Coffee .. .. .           | 96,050     | 336                     |
| Tea .. .. .              | 505,417    | 480                     |
| Linseed .. .. .          | 2,514,861  | 480                     |
| Sesamum (til) .. .. .    | 3,908,376  | 312                     |
| Rape and Mustard .. .. . | 4,231,479  | 466                     |
| Fodder Crops .. .. .     | 4,547,733  | 16,000                  |
| Cotton .. .. .           | 13,771,214 | 130 (lint).             |
| Jute .. .. .             | 3,523,558  | 1,200                   |
| Indigo .. .. .           | 448,594    | 15                      |
| Opium .. .. .            | 614,915    | 25                      |
| Tobacco .. .. .          | 1,009,210  | 1,600                   |

In Bengal the important crops stand in the following order of precedence in point of area : rice, oil-seeds, jute, maize, wheat, sugar-cane, marua (ragi) and tobacco. In Southern India, jowar or cholam occupies the second place next to rice, and in many parts of Southern India, either jowar, or bajra, or ragi, occupies the first place, either one or the other grain being the staple food of the people, instead of rice. In some districts mulberry, chillies, sun-hemp *pan*, potatoes, *palval*, brinjals, onions, turmeric, ginger, English table-vegetables, thatching grass, bamboo, mango, jack, date, papaya, plantains, *supari*, cocoanut, rubber trees, are grown as crops and occupy extensive areas. Agave and rubber plantations have been started in many places, and the latter are likely to rank as crops of considerable importance in South India. Lac-growing and sericulture will be also treated in this book as agricultural industries.

## CHAPTER XXII.

## SYSTEMS OF FARMING.

[Demonstration farms; Exchange of seed; Selection of seed; Seed-farms; *Jum*-cultivation; Mixed crops; Farming and planting; Farming by middle-class men; The one-crop system; Bare-fallowing system; Green-crop-fallowing system; Prout's plan; All-stock-and-no-crop system; Irrigation system; Mixed farming; Market-gardening; Dairy-farming; Fruit-farming.]

**Demonstration of best methods of farming.**—The agricultural resources of India may be said to be more or less in an undeveloped condition. The large variety of crops that may be raised and the quantity in which they can be raised, are not to be judged by those actually grown and the average outturns obtained. In places, here and there, excellent crops are raised, and great care is given. The crops of rice and sugar-cane obtained in the district of Burdwan, of tobacco at Petlad north of Baroda, of onions, lucerne and carrots obtained at Veraval, in Kathiawar, are as good as any obtained in any part of the world. Some castes are habitually more intelligent and industrious than others, but the average yield of crops is very poor. The demonstration farms that are being established in different parts of the country will do well to secure the services of the best cultivators in the country in various departments, and demonstrate the best methods practised in the country. This cannot be done without the help of science. One system of cropping, irrigation, or manuring is not applicable everywhere, but the scientific agriculturist can easily see what has proved so successful in one place, can prove successful under similar conditions elsewhere. Every crop, or every method is not suitable for every demonstration farm, but some can be chosen for each farm by the scientific agriculturist. What is best for each district and division has to be found out by experienced agriculturists, and such alone adhered to, to the exclusion of others. No centralised policy will answer in the case of agriculture. Saltpetre may prove to be an excellent manure for paddy in Surat, but it may not be a suitable manure for this crop in the regions of heavy rainfall in Bengal. Egyptian cotton is an excellent staple for Sind, where irrigation is readily available and where the climate is dry and the soil sandy, but it will not do to grow this cotton all over the country. We cannot dogmatise for all places in India, that so many irrigations (or any irrigation at all) are needed for sugar-cane and potatoes. In one place ten and even twenty irrigations may be required, and in others none at all. Distribution of seeds and advice from a common source in India, or even in each province in India, would not answer for each part. Each division, nay each district, should have its agricultural farm and bureau, where the crops and method suitable for that division or district are to be studied, and seed and information distributed thence to the cultivators of the division or district. Each area with similar soil and climatic conditions has to be separately dealt with, and the system of farming best suited

for it judged by men who have experience of crops and conditions in other districts, divisions and provinces of India. The agriculture organization of India is shaping to this end, but the scheme, as indicated here, is too vast to be at once realised. A great deal of time and patience will be required, and the money that should be spent to attain this end bears no comparison to what is being spent at present.

**Choice of site.**—It is a great mistake to choose for demonstration farms, sites with exceptional favourable environments, such as very fertile soil, presence of a canal, close proximity to a good market, etc. A private farmer should seek all these conditions. An *educational farm* may also be favourably situated. An *experimental farm* may require certain special facilities to be present for the purpose of special experiments, *e.g.*, of a canal for irrigation experiments. But for a demonstration farm the object aimed at should be the removal or avoidance of a certain *felt defect*. There are large tracts of land even in such districts as Nadia, Mushidabad and Birbhum, that are lying without cultivation. Ask the cultivators why these are lying without cultivation, and they will at once say, they cannot be cultivated. Demonstration farms should be set up in these tracts to show that these lands can be improved and brought under cultivation. The effect of such demonstration will be practical; these lands will be taken up by raiyats and cultivated, if they see the demonstration farm methods are successful. Some of these lands are too sandy. These may be improved by the cultivation of ground-nut. Some have too much iron and are too hard. These may be proved by growing trees on them by digging holes in which manure may be put. Some have too much common salt or soda salt. These might be drained and improved further by planting of *Babul* or other trees. Some are too dry for the ordinary crops of the locality, rice, jute, etc. These may be utilized for growing cotton, agaves, etc. The effect of such demonstrations will be of benefit to zemindars in the first instance and the members of each District and Divisional Agricultural Association should start small demonstration farms in such unfavourable situations under the expert advice of the Agricultural Department. For demonstration farms to grow good crops, where raiyats also get good crops and feel no want, is useless. "Nothing succeeds like success" is the valueless excuse that may be pointed out in selecting particularly good sites for demonstration farms, but the "success" of such farms is of no practical value. Utilization for agriculture of such lands as are not at present utilized for any good purpose, should be one principal aim of demonstration farms.

**Exchange.**—By the advocating of a local system as opposed to a centralised system of dissemination of agricultural information, it is not meant that exchange of seed between one division and another, or even between one province or country and another,

should not be constantly practised. Indeed, whether in the case of indigo, or potatoes, or paddy, or silkworms, or lac, exchange of seed has been found to be of the greatest benefit. But the theories underlying exchange must be understood, or else the exchange instead of giving good results, will give poorer results. For the hot weather, seed should be obtained from a hotter place. For a dry season, or for dry land seed should be procured from a dry region. For the cold weather, seed should be obtained from a cooler place. In the hot weather in Bengal, silkworm seed from Europe or from Mysore is likely to fail, while in cold weather they are likely to do well. For the hot weather one should go to a warmer place for seed. For sandy soil, seed from clay soil should be obtained from time to time.

**Selection.**—It is not meant that selection should not be practised *pari passu* with exchange. Selection means selection of good points and good individuals. Out of a thousand heads, if one or two show an unusually large number of grain, these heads should be reserved for seed. If out of a thousand plants some show an unusual tendency for tillering these should be reserved for seeding. These tendencies may be further stimulated by special systems of cultivation. Spacing and hoeing are the two best methods for increasing these tendencies.

**Seed-farms.**—There should arise in fact in the different divisions and provinces of India, seed-farms pursuing similar methods of selection and of culture, as are followed in the civilized countries of the West. Exchange of seed may take place among the various seed-farms. Seed-farms should not go in for pampering the crops with excessive manuring, as the use of seed grown with too much manure is likely to give, under ordinary treatment, poorer, rather than better results. By better spacing, by deep cultivation and more constant hoeing the habits of the plants will be altered and they will become deeper rooted. These general remarks apply to plants and animals, both. Selecting plants and animals with specially good points, weeding out all that do not show such points in a marked degree, tending them in a special manner, will cost the farmer more money than under the ordinary system, and seed therefore cannot be sold at the same price as ordinary grain or stock. The cultivators of this country will grudge paying twice or four times the value of ordinary grain for seed, and for the present it will be difficult for private capitalists to start seed-farms. But there is no reason why each Divisional Agricultural Association should not patronise one seed-farm to begin with, and thus create a demand for good seed among cultivators.

**Various systems of farming.**—From the *Jum* cultivation practised by some of the hill-tribes of the Sonthal Parganas and the hills of Eastern Bengal and Assam, to the one-crop-system practised by planters, there are an immense variety of systems of farming in vogue in this country. The hill-tribes aim at obtaining their



means of subsistence with the least trouble ; the planters aim at obtaining the largest value off their land. The hill-tribes of Garo, Khasia, Chittagong and Rajmehal Hills are accustomed to hacking down trees, making holes in the ground, and sowing several kinds of seed without using cattle or regular implements of cultivation. *Rahar*, maize, *jowar*, *mestá-pát*, *mestá* cow-pea, cotton, Italian millet, *tíl*, *aus* paddy, cucumber, country beans and pumpkin are some of the crops, the seeds of which are put in the holes, and the crops harvested as they get ready. On the virgin soils of forests. the result obtained is by no means bad. But the system is quite barbarous, and on ordinary soils it gives very poor results. Terracing of hill-sides, clearing and levelling them, and growing crops by civilized methods of cultivation are not very easy for hill-side places, and yet advanced nation like the Japanese and Italians, cultivate their hill-sides up to the very top. The special objection to *jumming* consists in special methods of cultivation adapted for different crops not being possible where so many crops are grown together. They are left to nature without harrowing and without weeding, and the return is poor. Santals, Kols and Beharies, though industrious cultivators using both ploughs and plough-bullocks, are still addicted to the growing of mixed crops. Ordinarily mixed crops should be avoided, though a few mixtures, such as *rahar* with castor or cotton, and mustard with peas are found remunerative to grow together. In the cotton-districts proper of Western India, even cotton is grown by itself though cotton is probably benefited by a little shade, such as is afforded by *rahar* or castor. In the case of peas and mustard, mustard seed should be sown first, and after a fortnight the pea seed. In this case the mustard affords means of climbing to the peas, and is itself perhaps benefited by the root-nodules of the peas. In other cases the value of the mixed crops does not come up to the value of each crop grown singly. Mixed crops besides are apt to result in mixture of grains which are very much objected to by exporters.

**Farming and Planting.**—Such crops as tea, opium, coffee, indigo, mulberry, round-pepper, sugar-cane, tobacco, etc., which are of exceptional value and which respond specially to a large outlay of capital, are best suited for planting enterprise. *Planting* differs from *farming* proper, inasmuch as it is concerned with the growing of one valuable crop only. *Gardening*, on the other hand, differs from both, inasmuch as the methods, the tools, the manures, used in gardening, are different from those used in farming or planting. A planter is a one-crop farmer. A gardener usually grows a great many crops and flowers. But his aim is not to get the maximum amount of nourishing food at the smallest expenditure of capital, but rather to produce the best size, shape, flavour, in fruits, flowers and vegetables, by expensive and highly careful methods of work. The farmer aims at doing without manures, as much as possible, at keeping up the fertility of his land simply by feeding

his cattle with nourishing oil-cakes and utilizing all the cattle dung, urine and litter in manuring his fields. By growing leguminous crops and by adopting a judicious system of rotation, he also tries to avoid the purchase of manures. The farmer's methods of cultivation are of a wholesale character. He does not aim at straight lines and neat curves, at absolute freedom from weeds, all of which are attainable by the use of hand tools and at a great cost. By judicious crossing and hybridizing, by budding and grafting, and similar methods, the gardener attains exceptional results at a great cost; and yet gardening pays near large and rich towns, where there are always people who are ready to pay a large price for a particularly fine pineapple; where the value of articles is not judged from quantity and intrinsic merit in the shape of nourishment but from bloom, flavour, look and size. The gardener does not, as a rule, trouble himself with rotation, nor does the planter, but the latter growing only one crop has no choice in the matter, while the former usually grows far too many things in small patches on land for which he pays a very high rent, to be able to choose a definite course of rotation, or to adopt the methods in general use in farms. Then there are various kinds of gardens. In tea-gardens, though garden-tools (spades, rakes, forks, etc.) are in use, the one-crop system makes them partake of the nature of plantations. Then there are gardens which are laid out once for all, such as flower-gardens and orchards, and also tea-gardens; while market-gardens have to be laid out at least twice a year. A garden, which contains mainly perennial plants, and which is once laid out at a great initial cost, does not cost any more keeping up than a farm. One labourer can look after two to three acres of garden land as of farm land. But market-gardening costs a great deal more in labour. Even one labourer per acre is not sufficient for every kind of market-gardening, though a mixed garden, where English vegetables, sugar-cane, green maize, etc., are grown, can be worked with one labourer per acre, if some farm appliances and bullocks are kept. In tea-gardens, where no farm implements, such as ploughs and bullocks-hoes are used, two labourers are considered necessary to properly work every acre of land. In planting and farming, animal and other powers are utilized as much as possible while in gardening hand-power is the mainstay.

The single-crop system, however remunerative at first, is *liable to end in failure sooner or later*. Competition brings down prices, increases wages and diminishes profit: the land gets exhausted for this special crop: special insect and fungus parasites accumulate: and the proprietor or the manager understanding only the handling of this special crop thoroughly, sticks to it to the very last and is unable to take to anything else for want of experience and for fear of losing more, until the crop fails entirely.

Middle-class men going in for farming should go in for mixed cropping, which gives rest to land if a judicious system of rotation is adopted. They should not say, "We will go in for dairying,

or for tea, or vanilla, or coffee, or banana, or sugar-cane, or rice." They should go in for as many things as have a good local sale. They must proceed tentatively, *i.e.*, at first grow only such things as they can consume at home, or what they require for the consumption of the members of their family, for their servants and their farm animals. That is the market ready for them. They should grow only such crops at first as are ordinarily grown in the locality, though superior staples and better methods and appliances may be introduced from the very first. Then they can extend the cultivation of anything that they find they can grow particularly well on their land, or which suits their tastes and fancies best. If they come to find that cows are doing very well under their management, that they understand them, and that they would like to keep more of them, they must give dairying some prominence, and begin selling milk and butter and bullocks and bulls. If they find goat-breeding does well and that they would like keeping more goats, they should extend this branch of their farming, though at first they should keep only just as many goats as they require for supplying meat to their family and perhaps some of their neighbours. In this way they should advance from supplying the needs of their own family, to supplying the needs of their friends and neighbours, and then supplying the general market. It is easier and more lucrative to create a special market for produce which shows any speciality. Bearing the above general principle in mind, one should determine the system of farming he is to follow eventually which must be governed very much by local circumstances.

The principal systems of farming may be enumerated as follows :—

(1) *The one-crop system.*—Growing the same crop year after year on the same land without manure is the common system of this country. The Jethro Tull system is only a slight departure from this, the land being cultivated deep and well. Deep cultivation and hoeing are not, however, in vogue in India. The one-crop system suits only a new tract of country. But sooner or later the land gets exhausted. In settling in the Sunderbans, one finds the one-crop system of growing rice only pays best. But as time goes on the system must be altered.

(2) *Bare-fallowing system.*—According to this system no manure is used, and no crop is grown on a particular field once in three, four, five or six years. In some parts of this country poor land under the *utbandi* system of tenancy is bare-fallowed for two or three years successively after two or three years successive cropping. The Lois Weedon system is an ingenious variation of the bare-fallow system, according to which three rows of wheat are drilled 12 inches apart and three feet of space left fallow alongside the drilled strip, and this succession of cropped and fallowed strips is repeated. The fallow strips are kept cultivated deep and exposed to the action of air. Keeping land cultivated and exposed without crop should not be done in the rainy season. The Jewish system of

giving rest to all land every seventh year, also comes under the bare-fallow system.

(3) *Green-crop-fallowing system*.—This is where a green or root-crop is substituted for fallow. The land is well cleaned and thoroughly manured, either by direct manuring for the previous crops, and by tethering cattle or sheep on the land and giving them oil-cake in addition.

(4) *Prout's plan*.—Under this system all things are grown by artificial manures. No live-stock is kept and all the crops are sold off as they get ready. This is a wasteful plan, except in certain localities where there is a railway station close by and a ready market and special facility for obtaining manures cheap. The ploughing, etc., is done by hired bullocks, and no crop is used for feeding farm animals, even the straw of cereals being sold off.

(5) *All-stock-and-no-crop* system is the opposite of Prout's plan. The land is mostly let down in grass. Such foods as cake, bean-meal, chaff, etc., are bought. The dung is returned to the meadows and the liquid manure is used for irrigating the meadows. On poor land and on hill-sides this system may be found profitable.

(6) *Irrigation system*.—If water, liquid manure, or town sewage, is available in abundance, this system may be followed. For market gardens, for meadow pastures and for green crops, this system is adapted, but not for growing cereals (except rice) and pulses. Manures need not be applied where there are special facilities for irrigation with sewage, as sewage water itself contains sufficient plant food.

(7) *Mixed arable-and-stock-farming* is the safest system for most agricultural lands.

(8) Near large towns *market-gardening* and *dairy-farming* pay better.

(9) *Fruit farming and jam and jelly-making* are best adapted for lands away from towns but not far removed from railway station or river, etc., leading to a large town.

## CHAPTER XXIII.

### ROTATION OF CROPS.

[Principles: (1) Growing of a large variety of crops; (2) Interposition of leguminous crops rich in root-nodules; (3) Fallowing; (4) Prevention of insect and fungus pests; (5) Recuperation after temporary exhaustion; (6) Avoiding of poisonous excreta; (7) Availing food-substance from different strata; (8) Growing of catch-crops; (9) Of different crops suited for different classes of soils; (10) Typical rotations for different classes of soil; (11) Local crops to be at first grown; (12) Rotation necessary even in planting.]

**Principles.**—The principle of dividing up the land and growing various crops according to man's natural requirements, is so obvious, that it has been adopted by cultivators all over the world ;

but the principle of growing one crop one year and another crop the next, is difficult to follow in a country where cultivators grow only a few crops, and where a certain piece of land is reserved for rice, another for jute or cotton, and so on. Good cultivators avoid growing the same crop on the same piece of land two years in succession, as much as possible. They usually grow jute and *aus* paddy or cotton and *juar* in succession on the same land. Another principle good cultivators follow is to grow a crop of *rahar*, or *sunhemp*, or a pulse crop for renovating their land. They are not aware, however, of the fact, that the roots of leguminous crops are



FIG. 61.—*Dhaincha* PLANT,  
SHOWING ROOT-NODULES.

more or less rich in root-nodules, and that these nodules are caused by bacteria harbouring on the roots, as beneficent parasites. If one were to take up a vigorously growing plant of *Dhaincha* (*Sesbania aculeata*), or *sunhemp*, or *rahar*, or ground-nut, one finds the roots full of well-developed nodules. These nodules when squeezed throw out a viscous fluid, which contains innumerable bacteria which can be readily recognised under a powerful microscope. The bacteria which form these nodules are able to derive their sustenance from the air, which higher vegetation is unable to do. The larger the quantity of root-nodules, the greater the amount of nourishment derived from the air and stored in the soil. The advantage of growing beans and clover is well understood in England, but *Dhaincha* and *sunhemp* are far richer in root nodules than perhaps any other plant, and being fast growing they can be grown just before or after the rainy season as a preparatory catch-crop, and ploughed into the soil to the benefit of the succeeding crops.

**Fallowing.**—Another principle involved in rotation, is the economising of the manure available in the farm, by keeping a portion of the lands by turns fallow and having the cattle tethered here for one year under some temporary structure made of wooden posts and roof on which fodder is stored for the year. This is an excellent system of making the best use of the manure available in the *raiya's* holding, and it is one which is practised in **Mymensingh** and other districts.

**Protection from Insect and Fungus Pests.**—Another great advantage derived from crops being grown in rotation on the same land is, that the pests of a crop, which would have multiplied if the same crop had been grown again on the same piece of land, die out for want of the host-plant in the immediate neighbourhood. The one-crop system of planters is the worst for encouraging insect and fungus pests.

**Recuperation after temporary exhaustion.**—Another principle which underlies rotation is a somewhat theoretical one. It is this: A crop exhausts some minute but necessary ingredient of the soil which another crop probably does not require, and also that the crop leaves in the soil some excrementitious matter in the soil which is injurious to that crop, but which is dispersed by growing another crop in the soil. The soil gets rest with regard to certain principles by growing a crop of a different kind, but in what way exactly does not appear clear. Jute following jute on the same land is found to yield a poorer result than when an intermediate crop of rice is taken.

**Food-substances from different strata** are taken up by different crops, some, such as barley, exhausting the top soil, while others, such as cotton or maize, drawing up food from deeper layers of the soil.

**Growing of Catch-crops.**—Another principle which should guide a farmer in the choice of crops to be grown on a piece of land is the taking advantage of occasional showers of rain by growing catch-crops between two regular crops. Catch-crops take only about three months' maturing, and some of these can be grown to perfection when there is heavy fall of rain out of season. Certain varieties of ordinary crops, such as the *shati* or sixty-day variety of *aus* paddy, the *mathia kapas*, which is a poor variety of cotton grown in Kathiawar, which matures in less than three months, may be grown as catch-crops. Other crops, which are particularly adapted for growing as catch-crops, are *cheena*, buck-wheat, cow-pea, *Cyamopsis psoraloides*, and various kinds of *sag*.

The main aim of rotation is to grow in succession different varieties of crops interspersed with crops rich in root-nodules.

Different rotations are applicable for different kinds of soil, as certain soils are particularly suited for certain crops, but not so well for others.

(1) *Stony and gritty soils* are well suited for growing the following crops: maize, oats, *jowar*, *gondli* (including the superior winter variety called *laidi*), *marua*, *kodo*, *bajra*; agaves, *mesta-pat*, cotton, *mesta* or sorrel, ladies' finger, *sabai* grass, buck-wheat, yams, cassava, sweet-potatoes, *sank-alu*; cow-pea, coarse mung, *kulti rahar*, *bhringi*, *Cyamopsis psoraloides*, *makkan-sim*, ordinary country bean, soy-bean, *dengo sag*, mulberry, indigo, chillies, cape gooseberry, tomato, tobacco; *kankri*, *kankrol*, *chichinga*, castor, *sorguja*, safflower; also such trees as Ceara rubber, *kusum*, *asan* and *baer*, for lac cultivation; *bhela* or marking-nut tree; *asn* for

growing tusser silk ; *simul* tree, myrobalan trees, tea, coffee, laurel leaf tree, and cashew-nuts in seaside places which are not too dry and hot. The coffee would grow under the shade of other trees. Low-lying land and hollows in hilly places can be utilized by growing *aman* and *aus* paddy.

(2) In *sandy soils*.—The crops that could be grown well are : *bajra*, barley, oats, cheena, *kayon*, *aus* paddy ; til, *sorguja*, mustard, ground-nut, safflower ; *mesta-pat*, *sunh-hemp*, *dhaincha*, *kalai*, *mung*, *kulti*, indigo ; buck-wheat on hill-sides ; melons, *patol*, and *sank-alu*. *Sank-alu* being a leguminous crop should be grown largely as a catch-crop where possible after *aus* or *mesta-pat*. Ground-nut should be more largely grown on such soils, harvest and it can be sown, if there is sufficient rainfall, either in February, or in May or June, or in October.

(3) In *loamy soils* should be grown potatoes, tobacco ; rhea (if soil is very rich and moist), jute, *huri-cotton* ; paddy, *jowar*, maize, wheat, barley, oats, sugar-cane, English and country vegetables, linseed, ground-nut, gram, pea, *musuri*, *khesari*, *mung*, *kalai*, *mesta* turmeric, ginger, arrowroot, melons, cassava, sweet-potatoes, *ol-kachhu*, *man-kachhu*, yams, plantains and mulberry.

(4) The crops suited to *clay soils* are winter paddy, wheat, oats, jute, sugar-cane, *rahar*, mat-grass, mulberry, gram, peas, beans, *mung*, linseed, and cabbages. In lands subject to flooding only winter paddy and jute of certain special kinds can be grown. Mat-grass and mulberry like *sabai* grass are perennial crops and are not suited for ordinary rotation.

(5) For *calcareous soils* the crops suited are : (1) paddy and *rahar* in rotation ; (2) wheat and gram in rotation ; or barley, and *khesari* or *musuri*, followed by *jowar*, and *sank-alu* in rotation ; (3) maize followed by potatoes ; (4) *Cyamopsis psoralioides* followed by *bajra* ; (5) *Kulthi* followed by oats ; (6) lucerne ; (7) carrots, cotton or onions. Lucerne being a perennial crop is not subject to ordinary rotation.

(6) For *peaty soils* the following rotations may be adopted : pumpkin, gourd, luffa or cucumber, followed by linseed, mustard, oats, wheat or barley, or brinjals, and other vegetables grown all the year round.

(7) The following rotations may be adopted in soils within a hundred miles of the seaside : paddy may be followed by radishes, carrots, onions, cabbages, beet or mangold (for fodder only and not for sugar) ; *dhaincha* followed by potatoes and afterwards by sugar-cane or *jowar* ; ground-nut followed by cotton ; gourds and pumpkins followed by barley. The perennial crops suited to such lands are plantains, date, cocoanut, *supari*, cashew-nut, and lucerne, if soil is calcareous.

For the first four classes of soil, *viz.*, stony, sandy, loamy and clayey, various crops are mentioned, and the rotations possible in these lands would be innumerable. A few typical rotations suitable for Bengal may be given here, but only by way of example.

(1) For *stony soil* the following 4-course system of rotation is suitable : maize followed by *cow-pea* in the first year, cotton in the second year, and *mesta-pat* followed by *sank-alu* the third year, buck-wheat followed by bare-fallowing the fourth.

(2) For *sandy soil* the following 5-course rotation is suitable : *aus* paddy followed by mustard and peas the first year ; jute followed by *mung* and *til* the second year ; *aus* paddy followed by potatoes the third year ; sugar-cane the fourth year, and *aus* paddy followed by *kalai*, the fifth year.

(3) For *loamy soil*, if particularly rich and moist or irrigable, three crops can be taken off the same soil annually : from March to July a crop of Jaunpur maize ; from July to October transplanted *aus* paddy grown with bonemeal and saltpetre manure ; from November to February, potatoes with heavy manuring. This is intensive cultivation. Instead of maize or *aus* paddy, a crop of *Dhaincha* may be taken. This will make the system less intensive and costly.

(4) For *clay soils*, fallowing of land once in five or six years is desirable. The following typical rotation for clay soils may be adopted :—

*Aman* paddy followed by melons the first year.

*Aman* paddy followed by winter-fallowing the second year.

Jute followed by *khesari* and *musari* the third year.

*Aman* paddy or sugar-cane the fourth year, and *aman* paddy followed by winter-fallowing the fifth year.

Bare-fallowing the sixth year (with cattle pasturing on the land).

This is a conservative system of rotation suitable for cultivators. One should always study the local crops and the rotations actually followed by the best cultivators, and follow these at first, and gradually and tentatively introduce changes, until a definite course of rotation is fixed upon.

**A rotation is necessary** even when the object is to grow one crop only, subsidiary crops of fodder, etc., being grown as accessory crops to give the land some rest from the main crop. Suppose, for instance, a ratooned crop of sugar-cane is grown in a large plantation, and the same land is under the sugar-cane for three or four years at a stretch, it is a good thing afterwards to set fire to the land, plough it up, and grow on it a cleaning crop of *Dhaincha*, or *Sunn-hemp*, or ground-nut, or cow-pea, or all the four crops mentioned, and renovate the soil before putting down sugar-cane once more. Even in starting a sugar-cane plantation, after burning the jungle in May, and ploughing the land up, a preparatory crop of *aus* paddy or *kulti* should be taken, and after that a crop of potatoes, if possible, before the land is brought into a thoroughly fit state for sugar-cane cultivation. If an annual variety of sugar-cane is grown by a planter, he may grow it in rotation with indigo, and continue to take both the indigo and sugar crops instead of depending on one crop only.



## CHAPTER XXIV.

RICE (*ORYZA SATIVA*).

[The wild rices of swamps, dry land and hills; The typical cultivated rices; Area; Principal paddies of the Burdwan Division, specially those grown at the Sibpur Farm; *Aus* paddy; rotation, manuring; soil; tillage; irrigation; harvesting; outturn; cost; husking; Peshwai paddy; a discovery in connection with *aus* paddy; *Boro* paddy; *Boran* or long stemmed paddy; *Rayda* paddy; Best conditions for paddy cultivation; Average outturn of all paddies; Outturn of *aman* and *aus* paddies at Sibpur and at Dumraon, the latter irrigated and manured; Mixed rice crops; Paddy cultivation in the Sunderbans; Chemical Composition.]

**The wild rice.**—Rice is indigenous to the East Indies and Australia, but cultivated from very ancient times throughout the warmer regions of the Old and the New World. Some of the wild varieties are awned and others awnless. But other peculiarities, such as ability to stand drought or inundation, are of more economic importance and should be studied by collectors of wild and cultivated species of rice. *Oryza granulata* is found on dry soils at altitudes up to 3,000 feet, in Sikkim, Assam, Burmah, Pareshnath and Rajmehal Hills, and Malabar. It is a perennial species with an almost woody root-stock. The flavour of the grain is so good that it is collected and eaten by children. The granular structure of the inner glume is its characteristic peculiarity. No cultivated rice seems to have been derived from this wild species as this peculiarity is not possessed by any. *Oryza officinalis*, another perennial species, with a sub-woody root-stock, with tall and sparse branches, multi-nerved leaves and profuse branched panicles, has its characters intermediate between *Oryza granulata* and *Oryza sativa*. This wild rice occurs in Sikkim, Khasia Hills, and Burmah. Hairy glumes which are found in some cultivated rices are present in this wild species. The umbellate, naked peduncles are also sometimes met with in the cultivated hill rice, which is distinctly *Oryza sativa*. The *Oryza sativa* is met with in the wild state wherever marshy lands occur, in Madras, Orissa, throughout Bengal, Arracan and Cochin China. The plant is generally an annual. The inflorescence is a panicle of spikes on short peduncles which have hairy scales, frequently a distinct tuft of hairs, as in *Oryza officinalis* at the point of origin of the spikes. The outer glumes are large, very often tridentate, midrib prominent, inner glumes variously shaped, but in the wild state considerably elongated, being, as a rule, .325 inch in length, and in the majority of cases the larger one is produced into a long awn which is distinctly articulated and possessed at its base of two glandular processes which correspond to the extremities of the lateral nerves: the surface is more or less hairy especially on the keel and nerves. Whilst the vast majority of forms of *Oryza sativa* possess only one grain, certain forms have two or even three grains. The *Uri* or *Jhara* rice of Bengal is only one form of wild *Oryza sativa*, which may be the origin of the various *aus*, *aman* and *boro* paddies. The wild rice is hardier than cultivated rices, and

as it is self-sown and is easily carried from field to field, it has been sometimes known to exterminate the cultivated rice and take its place. Fishermen collect the easily detached grain by binding the ears into tufts before they are ripe. When ripe they go in their palm canoes collecting the ears or simply shaking the grain into their primitive barges. Wild rice is met with even in the dry regions of the Central Provinces, usually in shallow pools of water, for instance in railway cuttings. In the dry regions of Partabgarh (Oudh), I have seen wild rice growing where there is no accumulation of water. Roxburgh distinguishes between *early* and *late* rices. He distinguishes eight forms of late rice—all awnless—affording white grains. Of his early rices, four are awned and yield red or coloured grains, one is awned but yielding a white grain, while there are awnless yielding white grains. Of the early rices six have coloured husks, while two have white or pale husks; of the late rices four have coloured and four white husks. The progress of cultivation is from awned to awnless and from coloured to colourless. Against these suppositions should be mentioned the fact that the *Oryza Bengalensis* or *Uri-dhan* has a white husk and grain, and some of the best and finest cultivated rices have an awned spikelet, e.g., the *karpurkati*, and some, such as *kelejira* and *daudkhani*, have coloured husks. Roxburgh's classification probably does not include the *bilán* rices, which may have been alone derived from the wild *Uru* rice, while the ordinary red rices are probably derived from *Oryza rufipogon* and the blackish ones from *Oryza abuensis*. That *aman* paddy has originated from *aus* can be actually proved by an experiment. If grains from a second cutting of an *aus* that yields a second cutting are sown, the plants yield *aman* paddy instead of *aus*, i.e., they ripen in four to five months instead of three, give a larger yield and the grains do not shed easily.

**Area.**—The area under rice in India is enormous, and this crop stands easily first among all the cereals grown in the country. The total area lies usually between seventy and seventy-five million acres, of which nearly forty million lie in the three provinces of Behar and Orissa, Bengal and Assam. Burma stands second with an area of between nine and ten million acres, much being grown for export, while between eight and nine million acres are cultivated with this crop in Madras. Of the remainder of India, the Central Provinces and Berar grow four and a half million acres under this crop, the United Provinces about six million acres, Bombay (with Sind) two and a half million acres, and the Punjab (with the Frontier Province) nearly three-quarters of a million acres. The importance of North East India (the three provinces) for rice cultivation will be seen from these figures, as more than half the rice land of India is included in them.

The *varieties* of rice recognised in Bengal alone are innumerable. Dr. Watt, as Reporter of Economic Products, had occasion to examine four thousand varieties of Bengal rice at one time. Of the rices grown in the Burdwan Division the following *aman* varieties

may be mentioned as suited for *bil* lands : (1) Atirang, (2) Hati shal, (3) Sada-ora, (4) Meghi, (5) Rupshal, (6) Ora, (7) Paramayushal, (8) Ora-meghi, (9) Chile-rangi, (10) Bankmal, (11) Uttarkalma, (12) Lal-ora, (13) Shankchur, (14) Dhuki-lata-mól, (15) Kanakchur, (16) Uri, (17) Lakshmi-bilash, (18) Muktashal, (19) Sindurtupi, (20) Bhut-kaurabi, (21) Páshákáti, (22) Soura, (23) Rati-ramshal, (24) Nilkanthashal, (25) Kal-bayra, (26) Pánikalma, (27) Shol-paná, (28) Paramananda, (29) Amán, (30) Nádánghátta, (31) Sambará, (32) Kaláshál, (33) Mete-kuji, (34) Nilratan, (35) Nilkantha, (36) Boyal-dánr, and (37) Ure-shals. Of the above the following peculiarities may be noticed : (1) Hatishal paddy has a very big grain, though the yield per acre is not exceptionally high. It goes up occasionally to thirty-six or forty maunds per acre. (2) The yield of the following varieties is large : Atirang, Sada-ora, Meghi, Ora, Boyal-dánr, Chile-rangi, Bankmal, Uttarkalma, Lal-ora, Dhuki-lata-mól, Uri, Lakshmi-bilash, Sindurtupi, Bhut-kaurabi, Pashakati, Soura, Rati-ramshal, Kalbayra, Panikalma, Sholpana, Amán, Nádánghátta, Sambará, Kalashal, Mete-kuji, and Nilkantha. These are expected to yield as much as forty-five to fifty maunds per acre. (3) Paramayu-shal, the yield of which often goes up to twenty to thirty maunds per acre, is a sweet-scented variety considered to be very easily digested, and highly valued for this reason. The grains of this variety are not very fine. (4) Kanakchur the yield of which may also come to twenty to thirty maunds per acre, is valued because *khái* (popped-corn) is made out of it.

Of *aman* paddies suited for ordinary paddy land (not *bil* land), the following Burdwan varieties may be mentioned as noted for special virtues : (1) Gobindabhog, Khásh-kháni, Bansmati, Bena-phuli, Kamini, and Badshabhog, are fine and scented varieties, which are highly prized. (2) Paramanna-shal and Ramdhunipagal are also scented varieties, but not very fine. (3) Harinakhuri and Bankchur are paddies out of which *khái* (pop-corn) is made. (4) Khejurchari is a rice, the inflorescence of which has some resemblance to a bunch of dates ; and (5) Pakshiraj, a paddy of winged appearance, is supposed to have medicinal properties. (6) Chhotabangotá, Chhanchi-mól, Bánkui, Harinakhuri, Dhale-kalma, Kalikalma, Jhingashal, Ajan, Kate-noná, Lál-kalma, Lata-mól, Chhotadhole, Chhanchi-orá, Jatá-kalmá, Dudhe-noná, Hara-káli, Mánikkalmá, Kártik-shál, Kártik-kalmá, Khepá, Rángibangotá, Nadnashal, Mehupal, Jal-shuka, Altapati-nona, Mugarshal, Dhole, Shunno-gangajal, Mota-nagra, Bangota Patalegara, Dhukishal, Kashphul, Nona-Laushal, Kalmá, Gádhashál, Dudh-kanrá, Kalamkátá, Laushenkátá, Sindurmukhi, Bankátá, Chámpáshal, Neulipátuni, Bári-ámpla, Máchyiyán, Akindi, Bagi-lal-pátuni, Leajkata, Sondálmukhi, Noyachur, Khayershal and Noyan, are heavy yielders. The superior fine and scented rices are produce in only about half the quantity of the coarser kinds.

High class *aman* paddies also grow best on land which does not get too much under water. On very wet land fine rices show a

tendency to become coarse. At the Sibpur Farm, the Kataribhog paddy of Dinajpur is steadily becoming coarser and coarser; but the Samudrabali variety of Bhagalpur, the finest variety of all, has remained fine so far. The yield of Samudrabali variety is heavy, and it is worth cultivating largely. The Badsabhog variety of *aman* paddy is also worth cultivating extensively, not only for its high quality, but for its large yield. The introduction of this variety of paddy in Hazaribagh, through the Reformatory School, has proved a great boon. Not only in the school farm, but also in the lands of others who have taken to growing this variety of paddy, it has given a larger produce than the coarsest variety of local paddy. The Daudkhani variety of fine paddy is also prolific, but whether it will be found so prolific outside the Burdwan Division is not known.

The *aus* rice of Bengal is nearly all coarse, difficult to digest and eaten by the poorer classes alone. It is grown on high-lands and sandy banks of rivers, and the plant requires much less water than the ordinary *aman* and *boro* paddies. As the sowing is ordinarily done broadcast, it is more troublesome to hoe than the *aman*. It yields a smaller outturn and fetches a lower price. But it supplies the *ravyat* with a food-grain and fodder (in common with other inferior grains, the millets, maize, etc.), at a time of the year when these get scarce. When the rainy season is of short duration and the *aman* fails, poor people depend for their subsistence on the *aus* and the millets. The growing of *aus* paddy, millets and maize is therefore highly advisable as a provision against famine, and the introduction of fine varieties of *aus*, more palatable and easily digested, would be a great improvement. The possibility of growing very fine *aus* rice has been demonstrated at Sibpur Farm. The average of the yield of fine *aus* paddy from the Central Provinces for seven years in the Sibpur Farm has been 1,303lbs. or a little less than 16 maunds per acre, the average yield of straw being 1,531lbs. or a little less than 19 maunds per acre. In 1901 from  $\frac{1}{12}$ th of an acre, 34 seers of paddy and 52 seers of straw were obtained from the first cutting, and 9 seers of paddy and 20 seers of straw from the second cutting. The growing of *aus* paddy is also desirable owing to the opportunity it gives for early preparation of land for *rabi* (winter) crops, such as pulses and oil-seeds. Potatoes and sugar cane which are sown later are also benefited by a longer preparation. There are some varieties of Burdwan *aus* paddy such as Niali, Kele, Aswingota, Kartiksal, etc., which form a sort of a connecting link between the *aus* and the *aman*. These are also transplanted like *aman*, and require more water than the *aus*. The time of transplanting these is somewhat later than that of ordinary *aus*, but they are reaped a month or two before the *aman*, which is a great advantage.

**Peshwari paddy** is also an early variety of paddy which is greatly appreciated all over India, specially by rich Mahomedans.

It is a highly absorbent variety of paddy which is in great request for the preparation of *pelao*. Naturally it produces a small crop in Bengal, the average of three years' produce at Sibpur being 1,096lbs. of paddy and 1,303lbs. of straw, or  $13\frac{1}{2}$  and  $15\frac{1}{2}$  maunds, respectively per acre.

A new discovery which is of the highest practical benefit was made by the author at Sibpur in connection with fine *aus*, the seed of which he originally brought to Sibpur from the Central Provinces, and the Swati variety of Peshwari paddy which was sent for experiment at Sibpur by the Bengal Agricultural Department. The Central Provinces *aus* gave the first year a good result, *i.e.*, about 20 maunds of paddy per acre, but the Peshwari Swati, which is a large grained variety and which produced a very healthy and exuberant growth of leaf, produced a very small crop of only 7 maunds of grain per acre. A small second crop was taken from both, which was used for seed the next year. The seed from the second cutting or the aftermath, produced a remarkable result. The crop withstood drought when paddy from other seeds failed and gave a very fair yield. The result in grain from the ordinary seed of the Central Provinces *aus* was—

|          |           |         |           |               |              |
|----------|-----------|---------|-----------|---------------|--------------|
| In 1902— | 1,476lbs. | against | 1,804lbs. | obtained from | ratoon seed. |
| In 1903— | 716       | ..      | 927       | ..            | .. ..        |
| In 1904— | 1,640     | ..      | 2,050     | ..            | .. ..        |

The result from Swati from ordinary seed in 1902 was *nil* (the crop failing from drought) against 1,250lbs. from ratoon-seed, and in 1904, 1,558lbs. against 1,570lbs. obtained from ratoon-seed under favourable climatic conditions. The second cutting or ratoon-seed has uniformly given a higher yield for a number of years at this farm. A high-class paddy like the Swati giving a large yield even in droughty weather is an extremely valuable production. These two high class varieties of autumn paddy should be extensively grown from the second-cutting-seed. The second-cutting-seed produces a deeper rooted plant which accounts for its producing a larger yield even in droughty weather. There is another reason for the Swati specially benefiting by the process. The Swati has an open panicle, and in August when it ordinarily flowers the rainfall is so heavy, that the pollen grains get washed out and fertilization is prevented. All *aus* paddy has more or less empty grain (*agra*) in consequence, but the Peshwari paddies contain a larger proportion of *agra* than any other for the reason just mentioned. Using the second-cutting-seed the crop matures fully a month later and the flowering takes place at a season (in September) when the rainfall is not so incessant, and when, in consequence, grains get the opportunity of forming properly.

**Rotation.**—*Aus* grown on *dearh* land is often followed by another cereal crop such as wheat or barley. Potatoes and *aus* paddy form a rotation in parts of the Burdwan Division.

The following rotation is recommended :—

**First year.**—*Aus* paddy followed by a pulse or oil-seed or the two mixed together.

**Second year.**—Jute or *Mestá-pát*, followed by a pulse or oil-seed or the two mixed together.

**Third year.**—*Aus* paddy followed by sugar-cane.

**Fourth year.**—Sugar-cane followed *aus* paddy.

**Fifth year.**—Potatoes followed by *aus* paddy.

**Sixth year.**—Bare fallow with tethering of cattle.

*Aus* paddy is considered the best *cleaning crop*, as it eradicates *ulu* grass (*Imperata arundinacea*) and other weeds. When an orchard has to be made on foul *ulu* land, *aus* paddy is sown, and in the midst of the standing crop, plantains and other fruit trees are planted.

**Manuring.**—*Aus* paddy is often grown with manure. It is also largely grown without manure on river sides where there is silt deposit. The manures used are cowdung, ashes, tank-earth and, rarely, oil-cake. Whatever quantity of dung the *rariyat* gets hold of or can afford to apply, he applies, and there is no rule observed as to quantity. The application benefits the subsequent *rabi* crop also, and it is for this reason that *aus* paddy is heavily manured. *Aus* rice grown after potatoes is not manured. 250lbs. (1 maund per bigha) of oil-cake per acre is the usual quantity used, when this manure is applied. Tank-earth is applied once in 3 or 4 years, 30 to 100 cart-loads per acre ; 80lbs. of bone-dust and 80lbs. of saltpetre per acre would be a good substitute for oil-cake, and would give a greater yield. The cost would be Rs. 6 or Rs. 7 (*i.e.*, Rs. 2 or Rs. 2-8 for 80lbs. of bone-dust and Rs. 4-4 or Rs. 4-8 for 80lbs. of crude saltpetre). The outlay will be more than realised by the increased outturn. The bone-dust should be applied at the time of cultivation, and the saltpetre a fortnight after transplanting, mixed up thoroughly with the earth along the lines of transplanting.

**Soil.**—The soils considered best for *aus* paddy are loam, sandy loam and loamy sand, situated rather high..

**Tillage.**—The first ploughing and cross-ploughing should be done in the cold weather, or as soon after the *rabi* harvest as possible. If the land is too hard to plough, ploughing should be done after the first shower of rain in February or March. The longer the interval allowed between the first ploughing and the sowing, the better, hence the importance of doing the ploughing as early as possible. The plough need not be used after the first ploughing and cross-ploughing, but the *bakhar* may be substituted in its place twice or three times, as occasion will arise, for killing the weeds and preparing a seed-bed. The burning heat of summer will destroy the weeds and leave the land clean. Six or seven ploughings are not

required if one ploughing and one cross-ploughing are done early in the season. Later, after a fairly heavy shower of rain, two successive *bakharings* followed by harrowing and laddering will level the land. Sowing should be done by drilling, but transplanting is still better even for *aus*. If sowing is done broadcast or by drilling, a light wooden roller should be used to cover the seed and give the land the proper compactness. A rounded log of wood or a beam can be used as a roller. The transplanting should be done at intervals of nine inches, one seedling being planted at each spot and not several as is the custom. The seed-bed for *aus* paddy should be close to water, that it may be kept watered and transplanting done at the very commencement of the regular rainy season, say, about the 15th or 20th of June. The sowing in seed-bed or in field should be done early in May, and the first heavy shower of rain from the middle of April to the middle of May may be utilized for this purpose, *i.e.*, for final preparation of land and sowing. Ten seers of seed are required per acre if transplanting is done. If sowing is done broadcast 30 seers of seed is ample; if drilling is done, 20 seers. For seed-bed, 3 maunds per acre may be sown. Transplanted paddy (if transplanting is done early, *i.e.*, when the plants are only about 9 inches high) grows more vigorously than paddy grown from broadcasted or drilled seed. Transplanting also gives facility for the after-ploughing operations, *i.e.*, hoeing, or running the spade in lines and overturning the soil, either of which operation gives vigour to the plants. This ploughing with a small plough called *lánglá*, or hoeing, or spading, should be done when the transplanted seedlings are well established. Seedlings can be kept even three or four days after uprooting them with impunity, but it is safe to have the bundles of seedlings in damp and shady places, or actually in water if they cannot be planted out at once. The produce of each *cottah* of seed-bed is made into 30 or 32 bundles. The tops of the bundles should be cut off before each is untied and the planting out is done. Before transplanting, water should accumulate in the field and ploughing in puddle should be done. The ladder should be also passed over the puddle. But in sandy soil laddering of puddle before transplanting is not necessary. The seed should be sown early in the season in light showery weather, as the caking of the soil after a heavy shower of rain prevents free germination. Broadcasted *aus* seedlings when they are about nine inches high are harrowed with a *bidia*. It is an operation which does as much harm as good and it is not recommended. The harm done by the uprooting of seedlings is not very noticeable, as a great deal more seed is used than is necessary. The hoeing and weeding done by the *bidia* are very imperfect. Passing the bullock-hoe, or the wheel hand-hoe, or the *lánglá*, or the spade, along straight drills, is much better. Seedlings from one acre of seed-bed would suffice for at least ten acres of *aus* and more of *aman*, and in the case of fine paddy still more.

**Irrigation.**—If the soil looks dry, especially when the plants are coming to ear, irrigation should be resorted to. Irrigation at this, the *thor-mukh*, stage of growth, results in heavy yield, unless seasonable showers make irrigation superfluous. In the case of *aman* paddy, *Hathia*-irrigation is considered for the same reason most important.

**Harvesting.**—*Aus* paddy should not be allowed to get too ripe. It sheds more easily than *aman* paddy. The end of September is the usual time for harvesting, but early varieties (Shati, etc.), are harvested as early as July and August. *Aus* straw is also more brittle than *aman* straw, and it easily gets broken. This is another reason for cutting *aus* while it is still somewhat green. The corn is cut close to the ground and left in parallel lines in the field for about a week. Afterwards sheaves are made, and 100 to 150 sheaves stoked together, and soon after removed and threshed in the threshing floor.

**Outturn.**—The outturn per acre of paddy is 12 to 25 maunds and of straw 20 to 40 maunds.

**Diseases** will be treated separately in the part devoted to Insect and Fungus Pests.

**Cost.**—The cost of growing a crop of *aus* paddy will be approximately as follows :—

|   | Per acre. |        |       |
|---|-----------|--------|-------|
|   | Rs.       | s.     | p.    |
| 1 ploughing and 1 cross-ploughing, with laddering @ 12 annas  | ..        | 1      | 8 0   |
| 2 bakharrings with laddering or rolling   | ..        | 0      | 12 0  |
| 1 ploughing in puddle   | ..        | 0      | 12 0  |
| 6 men employed in transplanting seedlings   | ..        | 1      | 3 0   |
| Proportion of cost for seed nursery $\frac{1}{10}$ (th)   | ..        | 0      | 8 0   |
| Cost of 12 seers of seed @ Rs. 2-8 a md.  | ..        | 0      | 12 0  |
| 3 mds. of powdered oil-cake 6-0<br>or 1 md. of bone-dust 2-8<br>and 30 seers of saltpetre 4-0       | } say     | ..     | 6 8 0 |
| Cost of applying the same   | ..        | 0      | 6 0   |
| Cost of turning up the soil with spades (15 men)  | ..        | 2      | 13 0  |
| Reaping, 6 men  | ..        | 1      | 2 0   |
| Binding and carrying, 6 men   | ..        | 1      | 2 0   |
| Threshing (with threshing machine, 4 men employed for 2 days), or by bullock-treading and winnowing | ..        | 1      | 8 0   |
| Rent (half calculated against <i>aus</i> crop)  | ..        | 1      | 8 0   |
|   |           | 20     | 6 0   |
| <b>YIELD.</b> —Paddy, 20 mds.   | ..        | Rs. 20 | 0 0   |
| Straw, say 25 mds.  | ..        | .. 3   | 0 0   |
|   |           | Rs. 23 | 0 0   |

The *net profit* thus comes to less than Rs. 3 per acre. But if high class autumn-paddy is sown, the 20 mds. of paddy will sell for as much as Rs. 40, and with such heavy manuring with saltpetre and bone-dust one can expect even more than 20 mds. of paddy per acre. If a fine variety is grown, the yield may come to only



12 mds. per acre, but the money-value will be about the same. The fine *aus* paddy grown at Sibpur actually yields 20 mds. per acre when the second-cutting-seed is used.

**Husking.**—By husking the paddy after steaming, 20 mds. should give at least 14 mds. of rice, and the cost of husking (3 women doing 2 mds. a day at a cost of 7 annas per md. of rice) may be calculated at about Rs. 6. 14 mds. of *aus* rice at Rs. 2 a md. may be valued at Rs. 28, this adding to the net profit another Rs. 2 per acre. If a fine variety is chosen the 14 mds. of rice may bring Rs. 70, and the profit in this case (if no manure is used) may come to Rs. 50 per acre.

**Aman paddy.**—Most of the remarks and calculations about *aus* paddy apply to *aman* paddy also, and it is only the distinctive characters of this crop that will be described here.

**Soil.**—Low-lying clay-soils are preferred for this crop. High lands, which cannot be easily irrigated, are not suited. The fine varieties specially are supposed to need to be under 6 inches or 9 inches of water from the time of transplanting to that of the plants coming to ear; but the need for a large accumulation of water at the base of the fine varieties of *aman* has been much exaggerated. Paddy plants not being injured like most other plants by water-logging, the water-logged condition of the soil has the effect of killing out weeds and leaving the land very clean. But even in the case of paddies (notably the Peshwari and other superior varieties) change of water, *i.e.*, letting out of old water, once or twice, is an advantage. In growing Peshwari paddy this precaution shall be taken. *Nigurh* or letting out of water early in August (before the *Hathia* period) is considered necessary for ordinary paddies also. In light soils *aman* paddy is sometimes sown broadcast. It is a lazy system which is prevalent in the southern portion of Murshidabad and northern portion of Nadia and perhaps in other parts of Bengal also.

**Cultivation.**—The land should be ploughed and cross-ploughed immediately after the previous *aman* harvest, if feasible, *i.e.*, in December. Time should not be wasted allowing the land to get too dry for ploughing. If the land has become too dry already, a shower in January or February should be taken advantage of in ploughing up new fields. If gram or any *rabi* crop follows the *aman* crop, the first ploughing and cross-ploughing should take place in March or April, *i.e.*, as soon as there is a shower of rain following the *rabi* harvest heavy enough to allow ploughing of the land. But as the ploughed up land under *rabi* crops is generally in an open condition, there is seldom any difficulty about ploughing up fields immediately after the *rabi* harvest. At the beginning of the rainy season, or a little earlier, *i.e.*, about the end of May, if possible (in June in Behar and in April in Eastern Bengal), seed is to be sown in properly cultivated seed-beds. The paddy-fields should then

undergo regular cultivation after the commencement of the rains, ploughing being done in puddle. The object of this is to bury the grasses and weeds. Two ploughings and two cross-ploughings, followed by one laddering in each case, are enough for the field to receive seedlings.

The method of transplanting is the same in the case of *aus* and *aman*, only in the latter case, transplanting is done later and further apart (one seedling being put in 1 foot apart in each spot). *Aus* paddy is commonly sown broadcast and no transplanting is done; *aman* paddy is commonly transplanted. The earlier the transplanting can be safely done, the better it is for securing a good outturn. The seed-bed can be kept in a flourishing condition by irrigation if necessary in June, and transplanting can be commenced when the regular rainy season just sets in, *i.e.*, about the first week of July or earlier. If transplanting is put off to August because there is not sufficient accumulation of rain-water, the result will be poor, and need for irrigation may be felt if the rains stop early in the season. Early preparation and early transplantation are a great security against failure, and where there is facility for canal irrigation, and for taking in water early in the season, say in June, a silt deposit rich in manurial matters can be secured. The reports of the Meteorological Department should be closely watched at this season; but the preparation of the seed-bed should on no account be put off to the regular commencement of the monsoon. It is better to resort to irrigation to keep seedlings alive, if necessary, early in the season. So instead of sowing seed in July, as is usually done, sowing should be done by the beginning of June and transplanting by the end of June, instead of in August. In unusual years there is sometimes no rain till the end of June and beginning of July. In such years preparations must perforce be delayed, except where there are canals, but in this case it is advisable to drill paddy seed in fields instead of sowing it in seed-bed and afterwards transplanting the seedlings. This saves time, and time is of the greatest importance when the rainy season threatens to be a short one. At such a season it is advisable also to grow as much *aus* paddy, maize and millets, as the high lands will carry.

**Manuring.**—*Aman* land is seldom manured, but manuring with oil-cakes, at three maunds per acre, would generally give a better yield, and perhaps pay for the outlay by the increased outturn. Where the accumulation of water is too great, and surface damage too free, oil-cake, or dung, or tank-earth should be applied in preference to saltpetre. But even these retentive manures are liable to be washed out during very heavy rainfall, and, on the whole, application of manures for *aman* paddy is not recommended. Saltpetre should not be used as manure for *aman* paddy in Bengal, though in regions of short rainfall, this manure is suitable for all kinds of paddy.

**Thrashing.**—*Aman* paddy need not be thrashed soon after harvesting, but kept stacked for two or three months and thrashed at leisure.

The flood of September 1900 enabled us to find out, that of the superior varieties of *aman* paddy, the following stand the flood remarkably well, viz., Kapursal, Kéléjira, Samudrabali and Mohanbhog, the first three being scented varieties, and the third and, particularly, the fourth, prolific varieties. The seed of Kéléjira is black, small, but long : of Samudrabali, dark brown, small and short, and of Kapursal, light coloured and small, but long. After the water subsided, the plants of these three varieties after being 12 days under water yielded a crop as if nothing had happened. The grain of Mohanbhog are light coloured and large. It is an Eastern Bengal variety and very prolific. This also came out of the flood unscathed, while most other varieties perished or suffered more or less in the immediate vicinity.

The proportion of grain to straw is higher in the case of *aman* paddy, and the absolute yield is also larger, as much as 40 or 50 maunds of grain per acre being often obtained. The net profit per acre is, therefore, larger in the case of *aman* paddy. Rs. 10 to Rs. 15 of net profit per acre may be expected by an intelligent cultivator adopting proper methods.

**Boro-paddy.**—This is a comparatively minor crop. Two successive crops of *boro* paddy may be obtained in a year, one being cultivated as a *rabi* or winter-crop, and the other as a *kharif* or rain-crop. The *kharif* variety is sown in the seed-bed in June or July, transplanted in July or August and harvested in September or October. The *rabi* variety is sown in seed-bed in October or November, transplanted in November or December, and harvested in May. The *kharif boro* is grown with the aid of artificial irrigation. A low-lying and soft piece of land by a river or *bil* side is chosen for seed-bed. If necessary, the land is flooded artificially before it is ploughed. The seed is sown on soft mud, but not in water. Newly thrashed grain is used. For three days and nights the grain is alternately dried in the sun and exposed to the night dews. It is then put in a bag, which is kept under water all the night and dried all the day. This process is repeated for three days and nights. If the seeds have all germinated by this time they are immediately sown. Otherwise they are filled into a bag and covered with blankets. After a day or two the seeds are taken out and broadcasted in the nursery at the rate of four maunds per acre. The seedling from an acre are sufficient for 8 or 10 acres. After the seedlings are two inches high, the nursery is watered once a week. They are transplanted when 8 or 9 inches high. After transplantation the field is kept irrigated when necessary till harvest time. The *rabi boro* is grown in low-lying fields, where there is water in October or November. No ploughing is needed in such lands, which are usually soft, and seedlings are simply transplanted when 10 inches

or 12 inches high into the soft mud. One or two ploughings are given when the land is not quite soft. All that is needed afterwards, to the time of harvesting, is pulling out of weeds and burying them in the soft mud.

The *outurn* of *boro* paddy is 20 to 25 maunds per acre. The winter (*rabi*) variety gives a better outturn.

In most districts *boro* is broadcasted only in November and December, or even in January and February, and harvested in April and May or in June. *Boro* is sometimes transplanted, two three or four times, between December and February.

**Boran Aman or Long-stemmed Aman.**—These are coarse varieties of *aman* which habitually grow in water 5 to 15 feet deep. They are sown broadcast in *bil* or low-lying lands. As the water rises the plant also grows, growth of as much as 9" to 12" in 24 hours at the beginning of the rainy season having been observed. When submerged through a sudden flooding for more than three days the crop is completely destroyed. This accounts for the failure of the experiment in the growing of the long-stemmed paddy in the Argoal Circuit of Midnapur. The sowing and harvesting take place at the same time as the sowing and harvesting of ordinary *aman*. Only the ears and a foot or two of straw are harvested. The rest of the straw is used for fuel or gathered and burnt.

**Rayda.**—A peculiar kind of *boro* rice is known as *ráydá* or *bhásá-nárangá*. This is sown along with ordinary *boro* rice in December. The young stems are shorn when the *boro* crop is removed, but this does not seem to do the *ráydá* any harm. It continues to grow in water, attaining a height of 10 and even 20 feet, and is not harvested till September or October, thus remaining on the land for 10 months. Only the ears with a foot and-a-half of straw are harvested, the rest of the straw or *nara* being left to rot on the land, or gathered and set fire to.

**Aus, Boro and Rayda** paddies supply the food of the poorest people of Bengal. Fully one-third of the whole produce of Dacca belongs to the *aus* and *boro* classes of rice, and even the *aman* paddy of Dacca, especially the long-stemmed variety, is a coarse and inferior grain. *Ráydá* and *Borán* paddies are grown in Eastern Bengal and Sylhet.

The most *favourable climatic conditions* for the rice crop are : (1) Premonitory showers in May, facilitating final preparation of land and sowing in seed-beds ; (2) heavy showers during June and in July, facilitating transplantation ; (3) fair weather for a fortnight in August, facilitating *nigarh* and weeding operations ; (4) heavy rains in September, when the *aman* is coming into ear ; (5) casual but heavy showers in October, about once a week, especially during the first fortnight ; and (6) one or two good showers at the end of January facilitating ploughing up of rice-land in the cold weather. The *aus* crop does not need such a heavy rainfall, nor late rainfall, as the *aman* does.

**Average Outturn**—The outturn differs so much in different districts, under different conditions and for different varieties, that it is difficult to strike an average. Sir W. Hunter gives 15 maunds of clean rice per acre as the average yield, while Sir A. P. Macdonell gives 10 maunds of rice for *aman* and 8 maunds of rice for *aus* and *boro* as the average yield per acre. About 12 maunds, or 1,000lb of rice, or 16 maunds of paddy, is probably a better of average yield per acre.

The following figures, gathered from the Report of the Sibpur Experimental Farm for 1904-5, give the average outturn of different races of fine and coarse varieties of paddy for several years grown on clay soil without manure:—

|  | Average<br>produce of<br>grain per<br>acre. | Average<br>produce of<br>straw per<br>acre. |
|--|---|---|
|  | lb  | lb  |
| 1. Badsábhog fine scented <i>aman</i> grown on proper <i>aman</i> land, i.e., low, rich land ..  | 2,600                                       | 4,400                                       |
| 2. Badsábhog grown on high land suitable for <i>aus</i> ..                                       | 1,423                                       | 2,039                                       |
| 3. Ránipágal (fine scented <i>aman</i> ) grown on <i>aus</i> land ..                             | 1,011                                       | 1,711                                       |
| 4. Rándhum-págal (fine scented <i>aman</i> ) grown on <i>aus</i> land ..                         | 1,045                                       | 1,921                                       |
| 5. Chinor (very fine scented <i>aman</i> from the Central Provinces) grown on <i>aus</i> land .. | 400   | 710   |
| 6. Bántshul (fine <i>aman</i> ) grown on <i>aus</i> land ..                                      | 875   | 2,136                                       |
| 7. Dáudkháni ( <i>aman</i> , for ordinary table-rice) grown on <i>aus</i> land ..                | 1,405                                       | 2,184                                       |
| 8. Kanakchur (fine <i>aman</i> ) grown on <i>aus</i> land ..                                     | 910   | 1,303                                       |
| 9. Karpurkátí (second <i>aman</i> ; awned, fairly fine) grown on <i>aus</i> land ..              | 992   | 2,910                                       |
| 10. Samudrabáli (very fine and scented <i>aman</i> ) grown on <i>aus</i> land ..                 | 1,239                                       | 2,039                                       |
| 11. Kátaribhog (fine <i>aman</i> ) grown on <i>aus</i> land ..                                   | 1,175                                       | 1,430                                       |
| 12. Hatishal (coarser <i>aman</i> ) grown on <i>aus</i> land ..                                  | 820   | 1,880                                       |
| 13. Swati, Peshwari (big and scented grain, <i>aus</i> paddy) ..                                 | 1,096                                       | 1,764                                       |
| 14. Madhumati, Peshwari ..   | 1,041                                       | 1,462                                       |
| 15. Bara, Peshwari ..  | 1,378                                       | 1,435                                       |
| 16. Very coarse <i>aman</i> paddy grown on <i>aus</i> land ..                                    | 1,826                                       | 2,173                                       |
| 17. Very fine Central Provinces <i>aus</i> paddy grown on <i>aus</i> land ..                     | 1,303                                       | 1,825                                       |
| General average ..   | 1,208                                       | 1,960                                       |

This comes, roughly, to 15 maunds of paddy and 24½ maunds of straw per acre. The produce of Badsábhog, which is a fine and scented variety, obtained from a low-lying field where there was water throughout the growing period, shows what the possibilities are in good and properly situated land. The outturn actually obtained from the Badsábhog variety represents a produce of over 30 maunds of grain and over 50 maunds of straw per acre. The *ráiyat's* expectation of 50 maunds per acre in the case of coarse paddy is not, therefore, altogether vain, and this is frequently

obtained by the Eden Canal in Burdwan and in the Sunderbans. The figures given above show how difficult it is to arrive at a fair average, and unless a fair average for each subdivision and district is reached it is not possible to estimate the potential food-stock of the country.

**Outturn of irrigated and manured paddy.**—How the outturn is affected by heavy manuring and by irrigation can be seen from the following table compiled from the Report of the Dumraon Farm for 1904-5. Four irrigations were given in each case, and cow-dung and saltpetre enough for supplying 40lb of nitrogen per acre. It will be seen that the increase in yield is chiefly in the straw :-

| No. | Name of variety.                  | Average yield of grain per acre. | Average yield of straw per acre. |
|-----|-----------------------------------|----------------------------------|----------------------------------|
| 1.  | Sukvel of Bombay .. ..            | 1,885                            | 4,968                            |
| 2.  | Kamode .. ..                      | 1,351                            | 4,180                            |
| 3.  | Ambamohor .. ..                   | 1,370                            | 4,533                            |
| 4.  | Jirasal .. ..                     | 1,160                            | 4,063                            |
| 5.  | Zina Kalumbia .. ..               | 1,470                            | 5,890                            |
| 6.  | Sherabuttu .. ..                  | 695                              | 4,560                            |
| 7.  | Halvagadhya .. ..                 | 1,010                            | 4,780                            |
| 8.  | Tinpakhaha (Kamoda) .. ..         | 1,300                            | 4,710                            |
| 9.  | Bangalia .. ..                    | 1,160                            | 6,180                            |
| 10. | Welch .. ..                       | 710                              | 4,080                            |
| 11. | Rajavil .. ..                     | 785                              | 5,430                            |
| 12. | Tinpakhaha (black) .. ..          | 202                              | 2,850                            |
| 13. | Chinor or Central Provinces .. .. | 1,113                            | 4,190                            |
| 14. | Daudkhani of Bengal .. ..         | 1,413                            | 4,800                            |
| 15. | Banktulasi do. .. ..              | 1,680                            | 5,066                            |
| 16. | Rándhunpagal .. ..                | 1,460                            | 5,466                            |
| 17. | Samudrabali .. ..                 | 906                              | 4,233                            |
| 18. | Bansmati .. ..                    | 1,278                            | 3,650                            |
| 19. | Bádsábhog .. ..                   | 1,516                            | 4,291                            |
| 20. | Patnai of Bengal .. ..            | 2,000                            | 4,480                            |
| 21. | Ramsal .. ..                      | 1,100                            | 4,350                            |
| 22. | Karpurkátí .. ..                  | 1,253                            | 5,710                            |
| 23. | Kalajira .. ..                    | 1,040                            | 4,500                            |
| 24. | Balam .. ..                       | 1,086                            | 4,500                            |
| 25. | Bansphul (local) .. ..            | 2,150                            | 5,000                            |
| 26. | Srikole (do.) .. ..               | 1,476                            | 4,936                            |
| 27. | Moharajoa (do.) .. ..             | 2,150                            | 5,591                            |
| 28. | Batasfeni (do.) .. ..             | 1,210                            | 4,865                            |
| 29. | Shella (do.) .. ..                | 1,400                            | 5,080                            |
| 30. | Bagami of the Punjab .. ..        | 510                              | 2,965                            |
| 31. | Bansmati (do.) .. ..              | 1,110                            | 2,230                            |

$38,942 \div 31 = 1,256$  lb.  $142,127 \div 31 = 4,584$  lb.

From the above table, it seems, the Moharajoa variety of Behar paddy, the Patnai variety of a paddy grown near Calcutta, the superior Sukvel paddy of Bombay and the Bádsábhog are the most prolific. Two other prolific paddies may be mentioned which belong to Chittagong, the Chandramuni variety of fine *Aus*, and the Rasail variety of *Aman*, which is also a fairly fine variety.

**Mixed Rice Crops.**—The mixture of *boro* and *ráydá* paddies has been already mentioned. *Aman* and *Aus* are often grown mixed in the same field, e.g., in *Rajshahi* and Chittagong. When a mixed crop like this is grown, usually a full crop of *Aus* and only a 12-anna crop of *Aman* is obtained, if everything goes well. But if there is short rainfall early or late in the season, one or the other of the crops fails more or less. 36 seers of *Aus* and 18 seers of *Aman* seed are sown broadcast together per acre. The sowing is preceded by a ploughing and followed by a ploughing and two laddering. After the seeds have germinated, the field is once ploughed and twice levelled with the ladder. The ladder is used again a week after. The *bidia* or bullock-rake is also passed, and one or two hand-weedings given afterwards. It is obvious that this rough treatment is withstood only because such a large quantity of seed is sown broadcast in an irregular manner.

The description of rice cultivation in the Sunderbans, given in Dr. Watt's Dictionary, is of considerable interest, and should be studied by those who have any intention of taking up lands in the Sunderbans.

**Chemical Composition.**—Rice is deficient in mineral and nitrogenous matters. The average composition is—

|   |    |    |    |    |    |           |
|---|----|----|----|----|----|-----------|
| Water ..                                  | .. | .. | .. | .. | 13 | per cent. |
| Ash ..                                    | .. | .. | .. | .. | 1  | „         |
| Fat ..                                    | .. | .. | .. | .. | 1  | „         |
| Nitrogenous matter treated as albuminoids | .. | .. | .. | .. | 7  | „         |
| Fibre ..                                  | .. | .. | .. | .. | 1½ | „         |
| Starch                                    | .. | .. | .. | .. | 76 | „         |

So-called glutinous rice has not any more nitrogen than ordinary rice. Rice contains a higher proportion of phosphoric acid but a lower proportion of potash and nitrogen than wheat. The husk of rice contains a great deal of silica and is of little feeding value; but the *kunra* or rice-dust, consisting, as it does, largely of the inner husk and germ of the grain, is richer than rice in feeding value, the average composition of this substance being—

|   |    |    |    |    |    |           |
|---|----|----|----|----|----|-----------|
| Water ..                                  | .. | .. | .. | .. | 11 | per cent. |
| Ash ..                                    | .. | .. | .. | .. | 9  | „         |
| Fat ..                                    | .. | .. | .. | .. | 14 | „         |
| Nitrogenous matter treated as albuminoids | .. | .. | .. | .. | 13 | „         |
| Fibre ..                                  | .. | .. | .. | .. | 8  | „         |
| Starch                                    | .. | .. | .. | .. | 45 | „         |

Containing a high proportion of oil, *kunra* gets rancid by keeping, and it should be therefore used as fresh as possible. The water in which the rice is boiled renders the cooked rice still more deficient, especially in ash constituents, than uncooked or steamed rice.

## CHAPTER XXV.

## PADDY HUSKING.

[Unhusked Paddy to be stored ; Protection of rice with carbon-bisulphide : the Dhenki ; the Engelberg Huller ; Trial of Ghatak's Huller ; Burn & Co.'s Winnower ; Comparison of Cost ; Bullock-power Engelberg Huller ; Engelberg Winnower ; Rakhai Das Khan's Hullers.]

PADDY is safer to store in godowns for a long time than rice, but even rice can be stored free from weevils and other pests if carbon-bisulphide is used, say 1 lb for every 20 maunds of rice stored in air-tight vessels, such as *jalas* tarred inside and out, and covered with *sharas* sealed up with cow-dung paste after the *jalas* have been filled with rice. Carbon-bisulphide is a highly explosive substance, and it should be never brought close to fire.

The husking of paddy should be deferred for 7 or 8 months after harvest, but if steaming is done, very little breakage takes place even in the case of new rice. As a precaution against famine, the *storing of new paddy* for about 8 months before husking and sale of rice are undertaken, should again come into fashion, as it used to be in olden times. Village-unions and agricultural banks should insist upon this.

The *ordinary method of husking* paddy with *dhenkis*, or tread-mills, is too well known to need description. Of all the mechanical appliances in use in the New and the Old worlds, the Rice Huller and Polisher manufactured by the Engelberg Huller Co. of Syracuse, New York, is the most popular. In Surat, however, German machinery is supplanting the Engelberg Huller and Polisher. There are several mills in Southern India and in the Punjab, where this Huller and Polisher are in use, and some of these machines have been lately set up at Howrah. The Rice Huller and Polisher manufactured by Messrs. S. Howes & Co. of London is a machine which scarcely differs from the Engelberg Rice Huller and Polisher ; and Ghatak's Rice Huller is only a cheap and inefficient imitation of these machines. With Ghatak's hand-power (or foot-power) paddy-husking machine, fine paddy has to be put through the mill at least 12 times before complete husking takes place.

**Ghatak's Bullock-power Paddy-husking Machine**, as modified and sold by Messrs. Burn & Co. for Rs. 60 only, is well adapted for use in jails and also for famine operations. The rice from this mill does not get broken, but there is a proportion of paddy in it even after three turns, and it is more unclean than ordinary bazar rice. At a trial held at Messrs. Burn & Co.'s workshop at Howrah on the 12th January, 1901, the following information was gathered :—The trial lasted for 2 hours exactly. The paddy used was new paddy of the Kátáribhog variety grown at Sibpur. It had been steamed and dried before the trial. The quantity used for a full charge was 29 seers. Instead of 2 bullocks, 8 men were employed at the



shaft and one man for feeding the mill. The paddy came out at the vent at the bottom only partially husked the first time ; it had to be run through the mill twice more before a satisfactory result was obtained. The rice obtained at the third turn weighed after winnowing 17 seers. The winnowing machine, which is quite a separate machine, is priced Rs. 65. It does its work very well and it is capable of winnowing 40 to 50 maunds of rice per day.

The mill looks from outside like an ordinary *ghani* or *kalu* (oil-mill). The vertical cylinder worked by the bullock-shaft has attached to it three sets of slanting vanes. The cylinder is kept in position by rings joined to the outer cask of the mill by three sets of bars. The paddy in working its way down from the hopper through the bars into the vent is subjected to the squeezing action of the vanes. It is by this action that the husk gets detached from the rice, in the same way as the detachment takes place if paddy is rubbed or squeezed between the palm and the thumb.

**Comparing the cost** of husking paddy with the *dhenki* with that of husking it with Messrs. Burn & Co.'s mill, it will be found that there is some advantage in favour of the latter for husking coolie rice, *i.e.*, coarse rice for consumption by poor people. The 29 seers of paddy filled the mill at first, but as the twisting action went on, the volume steadily diminished. The trial would have given a better result if the mill had been kept filled up by a continuous supply of paddy or partially husked rice. From the trial itself, however, it could be inferred that each maund of rice would cost about 4 annas husking with this mill. The wages of 1 man for 2 hours may be taken as 9 pies, and the cost of keep of a pair of bullocks for one-fourth of a day as 1 anna. 17 seers of rice costing 1 anna 9 pies, each maund would cost about 4 annas, exclusive of the cost of steaming and drying the paddy. One woman can steam and dry 3 maunds of paddy per diem from which, with the *dhenki*, 2 maunds of clean rice is obtained. So the cost of steaming and drying per maund of rice turned out is put down at one anna. To husk 3 maunds of paddy with the *dhenki* 6 women are required. Thus the wages of 7 women, *i.e.*, about 14 annas, are needed for obtaining 2 maunds of clean rice. So the difference in favour of Messrs. Burn & Co.'s system is 2 annas per maund of clean rice. The rice turned out is, however, somewhat inferior to ordinary bazar rice, and if this makes a difference of 2 annas or more per maund, there is no advantage in introducing Messrs. Burn & Co.'s machine. But, as already pointed out, continuous feeding would have considerably diminished the cost.

As to the *quantity* that the machine turns out *per diem*, on the 17 seers basis, we can expect only 68 seers per day of 8 hours per day. Even with continuous feeding probably not more than 5 maunds of clean rice could be expected per day. If it does this much, the cost of husking comes to only about 1½ annas per maund

of clean rice, which is a great improvement over 7 annas per maund, which is the average cost of husking with the *dhenki*. If, however, instead of 2 bullocks, 8 prisoners are employed in jails for husking paddy with Burn & Co.'s mill, the advantage in its favour disappears.

A rice-mill driven by a portable engine and turning out 140 maunds of white rice per day is also advertised by Messrs. Burn & Co. for Rs. 7,700, the engine and the paddy snatter being priced separately.

The "Engelberg" Rice Huller (Fig. 62), an American machine sold by Messrs. Marshall & Sons, and by Messrs. Macbeth Brothers & Co., of Calcutta, and which can be seen at work at Ramkristopore, Howrah, yields 300lb of cleaned rice per hour. It is capable of dealing with fine as well as coarse varieties of paddy, both unsteamed and steamed, and the husking is done completely in one operation. The machine itself, without the oil or steam-engine required to drive it, weighs only 500lb, and it occupies a superficial space of 3ft. square. The power required to drive it is about 4-H.P., and with a 16-H.P. engine a set of four machines can be worked. For a single machine an oil-engine without a boiler is quite sufficient, and being driven direct by a belt from the engine, the arrangement is very simple to manage. If a special mechanic is employed to look after the engine and the paddy-husking machine, it is best to employ a set of four or five machines driven by a 16-H.P. steam engine furnished with a boiler. The cost of a single huller is Rs. 1,100, of a separating fan or winnower for taking out the dirt, sticks, straw, and stones from the paddy, Rs. 125; and of a grader for separating rice of different sizes, Rs. 100. A 12-H.P. (nominal) engine (which usually generates 15 to 16 indicated H.P.) can be bought in Calcutta for about Rs. 5,000 and four sets of hullers would cost Rs. 4,400. Thus for about Rs. 10,000 the whole plant (exclusive of buildings) can be set up.

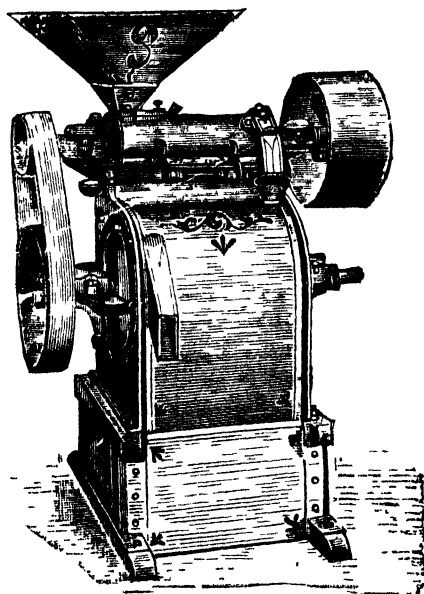

FIG. 62.—ENGELBERG HULLER.

The cost of working the engine will consist of—(1) the price of coal used, (2) the wages of the mechanic, and an attendant to the

hullers, and (3) price of oil used for lubricating the engine and huller. If there is a well or tank near at hand, there should not be any extra expense in keeping the boiler supplied with water. The expenditure of coal used may be put down at 4lb per H.P. per hour, which for a 16-H.P. engine working for nine hours a day is equal to  $4 \times 16 \times 9 = 576$ lb or about seven maunds costing about Rs. 2-8. The wages of the mechanic may be put down at Re. 1 a day and of the attendant at 5 annas a day. Inclusive of oil the daily cost will thus come to about Rs. 4. Interest and depreciation at 10% calculated on the capital of Rs. 10,000 will come to another Rs. 5 per day, if the work of the machine is distributed over 200 days in the year. The outturn per hour from four sets of hullers being 1,203lb daily, 10,800, or, say, 10,000, lb of clean rice can be obtained. So the cost comes to less than a rupee for every 1,000 lb (about 12 maunds) of cleaned rice turned out. This is at least four times cheaper than the rate at which paddy husking can be done with the ordinary village appliances.

The Engelberg Rice Huller and Polisher No. 3 the cost of which at Syracuse, New York, U. S. A., is \$150 (say Rs. 450 to Rs. 500 landed in Calcutta), meets the demands of smaller capitalists or farmers who do not require to shell such a large quantity of paddy as indicated above. Not being such a powerful machine as the Hullers Nos. 1 & 2 which are adapted for steam-power, the paddy used for Huller No. 3 must be free from sticks, straws, and grit. It requires two horse-power to drive it, and a high-speed horse or bullock gear may be employed for the purpose. The Engelberg Huller Company supply horse-gear for 65 dollars. Two pairs of powerful Hissar bullocks may be employed to drive it instead of two horses. The outturn of clean rice per hour from this huller is about 70lb, which is equivalent to about seven maunds per day. The whole of the capital outlay inclusive of bullocks (but exclusive of the building or shed) in this case would be about Rs. 1,000. The pay of the two attendants, one looking after the bullocks and the other feeding the huller and removing sacks of rice when full, need not exceed 6 annas a day in a country-place, and the feed of the 4 bullocks need not cost more than 8 annas a day. The cost of husking in this case, therefore, comes to only about 3 annas per maund of rice turned out, inclusive of interest on capital and wear and tear.

We have, in discussing the efficiency of Messrs. Burn & Co.'s Mill already given the average cost of husking paddy with the *dhenki*. It is possible with the help of expert women to get more work out of the *dhenki*. Two parties of such women, one working from 6 to 12 in the morning and the other from 12 to 6 in the evening, can turn out from four maunds of paddy, an average quantity of either  $2\frac{1}{2}$  maunds (more exactly 2 maunds 25 seers) of steamed (*siddha*) rice, or  $2\frac{1}{4}$  maunds of unsteamed (*atap*) rice. In obtaining the former an extra woman besides the three at the *dhenki* is required for steaming and drying the paddy and thus keeping the supply at the *dhenki* uninterrupted. Two parties of four women at 2 annas a day

will cost 1 rupee, and the cost of husking thus comes to about 6 annas per maund. In the case of *atap* rice where no steaming has to be done, the cost comes to about  $5\frac{1}{2}$  annas per maund under the most favourable conditions. The advantage of having rice husked by the Engelberg Huller is thus obvious.

The working parts of the machine, being made of chilled steel, are extremely substantial. Still the outer coat of the paddy is a very tough substance, and no machine can work this grain, without undergoing some wear and tear, which has been allowed for in the above calculations. The huller-screen (duplicates of which cost only 2 dollars each) is the part of the machine which requires renewing from time to time, say, 4 or 5 times every year. The cylinder also is apt to get worn out, and although the blade-adjusting screw helps to keep the space between the blades on the cylinder and the cylinder shell properly adjusted, the huller cannot be expected to work when the blades get

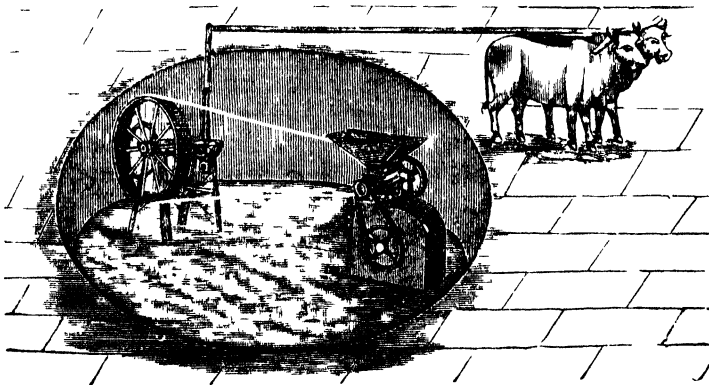

FIG 63.—ENGELBERG HULLER (BULLOCK-POWER).

altogether worn out, which they do in three or four years. These cannot be renewed in this country, and a duplicate huller-cylinder costs in New York 20 dollars. The paddy must be fed into the hopper of the huller in the same condition in which it is considered necessary to feed the mortar of the *dhenki*. In the case of unsteamed paddy, the paddy should be sunned and then spread out for a night in a cool (cemented) floor before it is husked the next day. The breakage is greater if the paddy is not properly dried in the sun and also if it is in a brittle condition immediately after exposure to the sun in a hot day. In the case of steamed paddy the outturn is nearly 10 per cent. more both with the *dhenki* and with the Engelberg Huller. The produce of steamed rice is on the average 68 per cent. and of unsteamed rice 50 per cent. of the paddy used a result which is equal to what is obtained with *dhenkis*.

The Engelberg Huller Company also supply a gear for man-power to drive Huller No. 3, a shaft being moved round by 12 men and the motion communicated to a pulley to which the huller is

attached by a leather belt. At least 20<sup>1</sup> Indian coolies would be needed to work this gear, and the cost for husking per maund of rice would thus come to over 8 annas. There would be therefore no advantage in having this gear unless the shaft is adapted for attaching bullocks, which can be easily done as shown in the figure 63. The price of this man-power at New York is 75 dollars. It is easier to adapt this for bullock-power than the horse-gear already mentioned above. The huller and the pulley or bullock-gear should be both placed in a circular hollow, and the shaft driving the pulley should work above, the bullocks being attached to the end of the shaft and going round and round above the hollow. A railing or a parapet should protect the bullocks from slipping into the hollow through any accident.

Huller No. 2 is constructed without the fan or polisher, a separate arrangement being made for a polisher, the rice being conveyed from a series of 10 or 12 hullers to a single polisher placed at the end of the series. For large mills this huller is better adapted than the more complete one represented in Fig. 62 where the polisher is enclosed at the lower portion of each huller. Huller No. 2 not being provided with the polisher costs less (about Rs. 900 instead of Rs. 1,100). The price of a separate polisher capable of cleaning 2,400 to 3,600lb of rice per hour is 300 dollars (about Rs. 1,000). For a large mill, Huller No. 2, and a separate polisher for each series of 12 hullers, are the best to have.

The winnowing machine supplied by the Engelberg Company is priced at 30 dollars, *i.e.*, it would cost about Rs. 125 brought out to India. It is scarcely distinguishable from Dell's Winnower.

A very ingenious mechanic, of the name of Rakhal Das Khan, of Howrah, has constructed a number of steam-power, bullock-power, and hand-power rice hullers and polishers, which do excellent work. For want of capital he is unable to push his business, but his machines are certainly worthy of extended patronage. The hand-power machine is priced only Rs. 10, and it does the husking in one operation, but not polishing. The bullock-power huller and polisher he has priced at Rs. 400. It consists of a huller and polisher and a winnower, all worked simultaneously by a pair of bullocks. With this polished rice is obtained in one operation. The daily out-turn of rice from this machine is about 20 maunds. Five sets of hullers, polishers, and winnowers are simultaneously worked by a steam engine. From each set 50 maunds of rice is either husked or polished. The polishing is best done by adding with each maund of unpolished rice only half a seer of dust (*kunrá*) of unsteamed rice and passing it through a set of hullers and winnowers. With five sets of hullers 250 maunds are either husked or polished, and with one set of winnower 250 maunds of rice can be divested of husk and cleaned. Each set of huller or winnower is priced at Rs. 300. If to this is added Rs. 5,000 for purchase of an engine and boiler, the total cost of machinery will cost (Rs. 300 × 5 + Rs. 300 + Rs. 5,000 = Rs. 6,800, and with leather straps and a shed, the capital charge

will be at least Rs. 8,000. As each part of this machine is made in the country, it can be also renewed in the country, and for this reason alone it should be regarded as a better machine than the Engelberg Huller, or the German machinery which have been found better than the Engelberg Huller in Surat. In the hands of a capitalist Rakhal Das Khan's machines will have a great future before them. It may be mentioned that now Babu Rakhal Das Khan has taken to constructing boilers and steam engines, and a  $\frac{1}{2}$ -H.P. boiler with steam engine and a set of husking and polishing machine is priced only at Rs. 500. It husks 45 maunds of rice a day, and if polished rice is wanted, the daily produce out of this machine is 25 maunds. I commend these as well as the *dal*-splitting machine invented by this gentleman to the notice of my countrymen.

## CHAPTER XXVI.

### WHEAT (TRITICUM SATIVUM).

[Classification ; Excellence of Indian Wheats ; the best varieties, the Muzaffernagar Wheat ; Acreage ; Soil ; Cultivation ; Manuring ; Rotation ; Harvest ; Outturn ; Improvements suggested.]

WHEATS are divided into two main classes, soft and hard. The latter are more glutinous, rendering the grain more suitable for making semolina (*suji*), while the soft, starchy grains are especially suitable for the production of fine flour or *maidá*. Wheats are also divided according to the colour of the grain into white and red. The following races or strains of wheat are recognised in Bengal :—

(1) *Dudhíá* wheat especially suitable for making fine flour, *maidá*—grain—white, soft, plump, and rounded ; leaves—usually broader than those of other varieties.

(2) *Jámáli* wheat—grain—fairly large, soft, pale-red ; leaves—narrow.

(3) GANGA JALI wheat—grain—pale-grey, large, hard, elongated, with somewhat angular outline, difficult to break or bite. Best adapted for making *suji* and *atta* (whole meal). Leaves—broad.

(4) KHERI wheat—hard, pale-grey grains of medium size ; leaves—narrow.

(5) PIUSA wheat—grain—soft, pale-grey, very small ; leaves—narrow.

(6) NANBIA wheat—grain—hard, reddish, very small ; leaves—narrow.

A variety of the *Jámáli* wheat (soft red wheat) is called *Maghia*, as it ripens very early, in Magh or Falgun (about February). A bald or beardless variety of dark brown but soft grained wheat, grown in Singbhum, is locally known as Ghyochangmed. All the other Bengal wheats are more or less bearded.

Better classes of wheat are, however, grown in the Central Provinces, the Punjab, and the United Provinces. In the Central

Provinces the best hard wheats are grown, while the best soft wheats are grown in Northern India, in the basins of the Ganges and the Indus, and their tributaries. In Southern India, in the moist parts of the Gangetic Delta, in Orissa, and in Burma poor hard red wheats are grown, and a tendency has been noticed for high class wheats to degenerate in these regions. In the United Provinces, Central Provinces, and Behar soft white wheats realise higher values than any others. The relative value of Indian, English, and some other high class wheats can be judged from the following figures :—

|  | Wt. of 100<br>separate<br>grains. | Impurities. | Percentage of<br>gluten by<br>water test. | Yield of<br>flour. |
|--|-----------------------------------|-------------|---|--------------------|
|  | grns. avdps.                      |             |   |                    |
| 1. Soft white Indian wheat               | 55.4                              | 1.52%       | 6.6                                       | 75%                |
| 2. Soft red Indian wheat                 | 51.8                              | 0.72 "      | 9.9                                       | 76 "               |
| 3. Hard white Indian<br>wheat . . . . .  | 68.3                              | 3.7 "       | 12.1                                      | 77 "               |
| 4. Hard red Indian wheat                 | 77.7                              | 1.2 "       | 13.2                                      | 76 "               |
| 5. English wheat . . . . .               | 57.4                              | 1.5 "       | 11.0                                      | 69 "               |
| 6. Australian wheat . . . . .            | 80.5                              | 1.0 "       | 11.9                                      | 72 "               |
| 7. Russian (Saxonska<br>wheat) . . . . . | 37.3                              | 0.9 "       | 22.6                                      | 72 "               |

From the above table it would seem that Indian wheat compares very favourably with other wheats, and it is superseded only by the finest Russian and Australian varieties. The Indian wheat is also remarkably free from excess of moisture and is therefore well adapted for mixing with English wheats which are too moist. The thinness of skin of Indian wheats and the consequent largeness of yield must always place them in the front rank as millers' wheat, whenever they are handled with intelligence. Indeed, Indian wheats are fully known in the English market, and their value is equal to that of some of the best European and American wheats.

The names of the Indian wheats which are prized as equal to any in the world are :—(1) *Gundun Safed* of Delhi, (2) *Daudi* of *Unao* in Oudh, (3) *Saman* of Bulandshahr and Meerut in the United Provinces, (4) *Safed* of Dera Ismail Khan in the Punjab, (5) *White Pissi* of the Central Provinces, (6) Buxar No. 1 Club wheat, and (7) *Muzaffernagar* wheat. The weight per bushel of Indian wheat varies from 60 to 65 lb, while the recognised weight of a bushel of English wheat is 63lb. Calcutta wheat is burdened with a refraction of 5 per cent., and Bombay wheat of 4 per cent., in the English market, which only induces cultivators or *mahajans* to mix earth or other foreign matter with the wheat. In post-monsoon consignments the impurities in Indian wheat are chiefly due to weevils. The Agricultural Departments of Northern India have succeeded in popularising the *Muzaffernagar* wheat which is as good as any of the soft white wheats. The demand in recent years, however, has tended to be more and more for hard wheats,

owing to their better baking qualities, and a hard high-yielding wheat suitable for many parts of Northern India has been bred at the agricultural research station at Pusa, which is being now spread over some of the wheat-growing districts.

India is, next to the United States and Canada, the largest wheat-producing country in the world, and the significance of this fact is very great when we consider England's relation with India, as England depends mainly on imported wheat, and India is supplying a large proportion of this. The production of wheat in the provinces under direct British rule has been estimated at 35,000,000 to 40,000,000 quarters, *i. e.*, about the same quantity as is produced by Russia or France. Great Britain and Ireland produce only 10,000,000 to 13,000,000 quarters per annum.

**Area.**—The area under wheat in India varies very much owing to the varying character of the seasons. The average is about twenty-five million acres.

Of this area by far the larger proportion lies in North India, and the extension of canal irrigation in the Punjab and United Provinces has made these provinces relatively more and more important in this respect. Taken together they have about two-thirds of the wheat area. The Central Provinces, especially the Nerbudda Valley, stand next in importance, with about one-tenth of the total area, while Bombay follows closely. With the exception of a few thousand acres in Mysore, there is no extensive area of wheat grown in India, south of Bombay and the Nizam's Dominions.

So far as Bengal and the new province of Behar and Orissa are concerned, the wheat area seems chiefly concentrated in the parts lying north and west of Calcutta. The largest areas are found in the districts lying in and on the borders of Bihar, Bhagalpur, Gaya, Patna, Champaran, Monghyr are among the districts which grow most of this crop. To the east and north-east of Calcutta, that is to say in Eastern Bengal and in Assam, practically no wheat is grown at all.

**Irrigation.**—Wheat is always a *rabi* crop, and it is apparent from the figures quoted that a dry and fairly cold winter is favourable for the growth of wheat. Districts which are always moist and warm are unsuitable for growing this crop. With the exception of a few sandy tracts, the value of irrigation for wheat is doubtful in Bengal, and the crop in clay soils is usually raised without irrigation. The advantage in favour of irrigation, however, is great in the United Provinces and the Punjab. In the former, the average yield of wheat in unirrigated areas is 800lb and in irrigated areas 1,250lb per acre; and in the latter, 576lb. in unirrigated areas and 917lb in irrigated areas. In the Bombay Presidency the difference is still greater in favour of irrigation, 1,250lb per acre being the yield of irrigated areas against 510lb, the yield of those unirrigated. The difference in the Central Provinces is about the same as is in the case of the Punjab.



**Soil.**—Clay loam, easy of irrigation, situated in a dry locality is the best soil to choose for wheat. Sandy loams are also utilised for growing wheat, especially *deark* or new alluvial lands, where mixtures of wheat and barley or wheat and mustard or linseed are commonly taken. The best crops of wheat are grown on lands newly brought under canal-irrigation. Where canal-water is used for irrigation for a number of years the outturn is found to fall off even below the original level. This is due (1) to excessive use of water for irrigation which washes away valuable food-constituents and brings up to the soil undesirable soluble salts, and (2) exhaustion caused by the taking of heavy crops at first without manure.

**Cultivation.**—Shortly, the land is to be ploughed and cross-ploughed, first with the country plough or some improved plough and then cultivated with the grubber, as often as convenient, and operations commenced as soon after the rains are over as possible. When by ploughing, cross-ploughing, grubbing, harrowing and rolling, land has been prepared deeply and thoroughly (all the operations following close one upon another, that there may be no undue loss of moisture), seed should be sown by drilling. At least a fortnight's time must be allowed for the proper aerification of soil between the first ploughing and the sowing. If rolling or laddering is done after each operation there will be little loss of moisture in a fortnight's time soon after the monsoons are over. Deep cultivation is advisable for the wheat crop, hence grubbing is recommended. Sowing should be done after the cold weather properly sets in, *i.e.*, somewhat later than when barley and other *rabi* crops are sown. The middle of November is ordinarily the best time for Lower Bengal. In rocky and laterite soils sowing should be done earlier, say about the 20th or 25th October, or earlier still if the rains cease early in October. About 100lb. of seed are commonly used per acre, but this is too much. 50lb are quite enough. After sowing, the field should be divided out into irrigation-beds by scraping up little banks of earth with a wooden shovel which is usually worked by two boys in the United Provinces. This wooden shovel may very well be introduced into practice in Bengal for making little irrigation-beds. If the soil is too dry, it should be irrigated before sowing. Three or four irrigations altogether are ample for dry localities; but one or two irrigations are usually required, though in moist tracts irrigation may be altogether dispensed with for the wheat and barley crops. In such tracts, however, wheat does not do well. Where the natural climatic conditions in any season are exceptionally favourable, no irrigation may be required. One hand-weeding should be done within a week or ten days after the first watering. Two hoeings with the American wheel-hoe may be given afterwards to promote the growth of the crop.

**Manure.**—Saltpetre  $1\frac{1}{2}$  maund per acre (top-dressed) is the best manure for wheat. If the land is known to be poor,  $1\frac{1}{2}$  maund of bonemeal should be used beforehand at the time of ploughing,

though no immediate benefit will be derived from such application. Five maunds of oil-cake may be used instead. But better immediate effect will be obtained from the saltpetre. The best manure to apply varies much, however, with the locality, and no general statements can be made. No manure is required for *dearh* land which is annually renovated with silt.

**Rotation.**—*Juar* or other millets and wheat are commonly grown in rotation, though both are grain-crops. *Juar* and barley being surface feeders may be grown together or successively with wheat which is a deep-rooted crop. But better result would be obtained from *Kulki*, or *Bhadoi Mung*, or *Bhadoi Kalai* being grown before wheat. Lentils or gram grown along with wheat is, theoretically speaking, not a bad practice as the leguminous crop supports the wheat-crop and prevents exhaustion of soil; but mixed crops with wheat are found to be undesirable for more than one reason.

**Harvest.**—The wheat harvest should be commenced after the grains are quite ripe and the straw quite dry and crisp.

**Outturn.**—9 or 10 maunds per acre is about the average yield of grain, and 10 to 12 maunds of straw.

**Cost (in Bengal)—**

|   | Rs. | A. | P.   |
|---|-----|----|------|
| 1 Ploughing .. .. .                                 | ..  | 0  | 12 0 |
| 1 Cross ploughing followed by laddering             | ..  | 0  | 12 0 |
| 1 Bakharing .. .. .                                 | ..  | 0  | 6 0  |
| 1 Cross-bakharing .. .. .                           | ..  | 0  | 6 0  |
| 1 Grubbing .. .. .                                  | ..  | 0  | 6 0  |
| 1 Cross-grubbing .. .. .                            | ..  | 0  | 6 0  |
| 1 Harrowing .. .. .                                 | ..  | 0  | 4 0  |
| 1 Rolling .. .. .                                   | ..  | 0  | 4 0  |
| 1 Drilling* .. .. .                                 | ..  | 1  | 0 0  |
| Cost of 50lb of seed @ Rs. 3 per maund              | ..  | 2  | 0 0  |
| Cost of pickling .. .. .                            | ..  | 0  | 8 0  |
| 1 Rolling after sowing .. .. .                      | ..  | 0  | 4 0  |
| 1 Maund of saltpetre .. .. .                        | ..  | 6  | 0 0  |
| Watering with saltpetre solution .. .. .            | ..  | 1  | 8 0  |
| 1 Regular irrigation after application of saltpetre | ..  | 2  | 8 0  |
| 1 Hand-weeding .. .. .                              | ..  | 2  | 0 0  |
| 2 Wheel-hoings .. .. .                              | ..  | 1  | 2 0  |
| Reaping .. .. .                                     | ..  | 1  | 2 0  |
| Threshing and winnowing with machine                | ..  | 3  | 0 0  |
| Rent (half-year's) .. .. .                          | ..  | 1  | 8 0  |
| Depreciation on implements .. .. .                  | ..  | 0  | 8 0  |
| Total cost  | ..  | 26 | 8 0  |
| Produce—12 maunds of grain @ Rs. 3                  | ..  | 36 | 0 0  |
| and straw 16 maunds .. .. .                         | ..  | 1  | 8 0  |
| Total outturn                                       | ..  | 37 | 8 0  |
| Net profit per acre, about Rs. 11.                  |     |    |      |

\* Cost of drilling seed with the help of an American wheel-hoe (1 tine only being used) comes to nearly Re. 1 per acre. But with a proper seed-drill the cost would come to only about 6 annas per acre or less.

The points that should be borne in mind in extending the cultivation of wheat in any part of India are :—(1) the seed should be of the best variety suited to the locality in which it is grown ; (2) a rust-resisting variety should be chosen ; (3) the soil should be deeply cultivated, as deeper cultivation is required for wheat than for rice, barley, and oats ; (4) saltpetre should be used for top-dressing ; (5) it should not be sown mixed with other crops, and the seed used should be unmixed and select, and the threshing should be as clean as possible ; (6) sowing should not be done until the cold weather fairly sets in, barley and oats being sown earlier in the season ; (7) if there is not sufficient moisture at the time, land should be irrigated and *bakhared* afterwards before sowing ; (8) wheat should be twice irrigated, if possible, in wheat districts proper, and the sites chosen for wheat land should therefore be close to water ; (9) harvesting should be done after the grain is thoroughly ripe ; (10) grain should be stored so that there may be complete protection against weevils. Paddy and oats are not so subject to the attack of weevils as wheat, and cultivators often find their wheat seed completely destroyed by weevils at sowing time, and their sowing of wheat seed results always in more or less partial germination. (11) Wheat seed should be sown after pickling, to avoid smut, insect-pests, and damage by birds.

The subject of storing of grains against weevils and pickling will be discussed in the part devoted to Insect and Fungus Pests.

## CHAPTER XXVII.

### BARLEY (*HORDEUM HEXASTICHUM*).

[Occurrence in wild state ; Two-rowed, four-rowed, and six-rowed Barley ; Composition of Indian Barley ; Huskless Barley ; Cultivation ; Seed ; Cost, Barley Meal ; Barley Straw ; Exhaustion of Surface Soil.]

**Barley**, like wheat, is one of the most ancient of cultivated crops, but the two-rowed barley (*Hordeum distichum*) alone has been discovered in the wild state in several parts of Central Asia, while wheat has not been so discovered. The six-rowed barley (*Hordeum hexastichum*) or bigg, which is the staple of Indian cultivation, has not been discovered in the wild state, though this is the variety which was cultivated in Europe, Asia, and Africa in very old times. The four-rowed barley (*Hordeum vulgare*) is the staple of European cultivation now. Probably the four-rowed and six-rowed barleys are derived from the wild two-rowed variety. Indian barley is richer in albuminoids than English barley. The composition of the former is, on the average :—

|             |    |    |    |    |              |
|-------------|----|----|----|----|--------------|
| Starch      | .. | .. | .. | .. | 63 per cent. |
| Cellulose   | .. | .. | —  | .. | 7 "          |
| Oil         | .. | .. | .. | .. | 1 "          |
| Albuminoids | .. | .. | .. | .. | 11.5 "       |
| Ash         | .. | .. | .. | .. | 3 "          |
| Water       | .. | .. | .. | .. | 12.5 "       |

**Cultivation.**—Barley is grown to a small extent all over India and chiefly in the United Provinces, either by itself, or mixed with wheat, or gram, or with peas, or lentils. The most favourite mixture is barley and gram. Barley and wheat as a mixture is not so popular, but barley as surface feeder and wheat as a sub-soil feeder may be grown together in rich soils. Rape (*Brassica campestris*), mustard (*Brassica rupea*), taramani or tiramira (*Eruca sativa*), and linseed are also grown along with barley. Lighter soil is preferred for barley than for wheat. The land is prepared, and the seed sown a little earlier in the season than wheat, unless they are sown together. About 100lbs. of seed are used per acre. A little more seed is required for barley than for wheat, but 100lbs. per acre is too liberal an allowance. Seed properly stored and protected against weevils germinates properly and smaller quantities of such seed are sufficient; 60 to 70lbs. of barley should be ample to sow an acre. Barley is a hardier crop than wheat and it does not require the same amount of weeding and irrigation, and it is not so subject to rust. It can be also grown more successfully in different climates than wheat, which does not do so well in warm and moist regions as barley does. One hoeing with the American (Planet Jr.) wheel-hoe and one manuring with 1 maund of saltpetre per acre may be applied with great advantage when the plants are above six inches high. In Bengal no irrigation is practised for barley. The harvesting should be done earlier than wheat, i.e., before the grains are very ripe. The cut sheaves may be made to stand with ears upwards, near the threshing floor and when the grains are quite dry they can be threshed or flailed out.

**Cost (in Bengal)—**

|  | Rs. | A. | P. |
|--|-----|----|----|
| 1 Ploughing and cross-ploughing .. ..  | 1   | 8  | 0  |
| 1 Bakharig and 1 cross-bakharig .. ..  | 0   | 12 | 0  |
| Seed (60lbs.) .. ..  | 1   | 8  | 0  |
| Pickling the same .. ..  | 0   | 4  | 0  |
| Cost of sowing in drills .. ..   | 1   | 0  | 0  |
| Reaping .. ..  | 1   | 8  | 0  |
| Threshing and winnowing .. ..  | 3   | 0  | 0  |
| Irrigation, if necessary .. ..   | 1   | 8  | 0  |
| Manure, 1 md. of saltpetre .. ..   | 4   | 0  | 0  |
| Applying the same with water .. ..   | 1   | 8  | 0  |
| Rent (half charged against this crop) .. ..                                      | 1   | 8  | 0  |
| Depreciation, etc. .. ..   | 0   | 8  | 0  |
|  | 18  | 8  | 0  |
| <i>Outturn.</i> —12 mds. of grain at Rs. 2, and 16 mds. of straw at 1 anna .. .. | 25  | 0  | 0  |
| Net profit per acre, about .. ..   | 6   | 8  | 0  |

To separate the adherent glumes from barley grains husking does not answer, trying or parching being necessary. Barley grain, parched and mixed with gram, is given to animals as food. Barley meal (*sattu*), prepared after parching, is eaten largely by up-country

men and is given to animals also. Barley straw is not a safe straw to give to horses and cattle, as it is liable to cause colic, being bearded and spiny. It may be used for litter with great advantage. Barley, leaving little crop-residue and being a surface feeder, is a greater exhauster of surface-soil than wheat or rice. For this reason this crop should be either sparingly grown, or only the ears should be harvested and the straw ploughed in.

## CHAPTER XXVIII.

### OATS (*AVENA SATIVA*).

[Soils suitable for this crop; Range of Temperature; Cultivation; Seed; Harvesting; Grown for fodder by irrigation.]

OATS are a very minor crop in India, especially in Bengal. Like wheat and barley, oats may be grown on lands suitable for *Aus* paddy after the *Aus* paddy or jute has been harvested. This crop can be also grown well on *dearh* lands and low-lying lands which are dry by October and November. In fact, oats can be grown on all kinds of soil, light and heavy, rocky and calcareous, the best result of course being obtained from rich friable loam, somewhat lighter than typical wheat land. The range of temperature at which oats grow properly is greater than in the case of wheat or rice. The range of temperature at which oats will grow well is also very great.

As soon as the rains have stopped in September or October the land should be ploughed and cross-ploughed and *bakhared*, then harrowed and rolled before drilling. Rotten cow-dung 150 maunds per acre, applied on the land at the time of cultivation, and  $\frac{1}{2}$  maund or 30 seers of saltpetre top-dressed when the seedlings are about six inches high, give the best result. 50lbs. of seed (which is lighter than wheat seed) is ample per acre. After drilling the seed, a light wooden roller should be passed to bury the seed and give compactness to the soil. Seed should be pickled with Sulphate of Copper as usual before sowing. One watering at the time of applying the saltpetre in solution is necessary. If the crop looks vigorous and if the land is not very harsh and dry, no other watering will be required. One hand-hoeing and one wheel-hoeing with the Planet Jr. American hoe should be sufficient.

The harvesting of oats requires special care, as it should be done when the grains are not fully ripe and the straw is still somewhat green. Harvested late, the grains shed and the straw loses in feeding value. Oat-straw is more nutritious than rice or wheat straw. An acre should yield 20 maunds of grain and 30 maunds of straw cultivated as above.

Oats are sometimes grown by irrigation to supply green fodder, *e.g.*, at the Hissar Government Cattle Farm, where three cuttings of the green fodder are taken, and the fourth cutting left to bear a thin crop of grain.

## CHAPTER XXIX.

BHUTTA OR INDIAN CORN (*ZEA MAYS*).

[Area : Origin ; American maize ; Indian types ; Quality of food ; Straw as fodder ; Manure ; Soil ; Cultivation ; Outturn ; Jaunpur maize ; Maize huller.]

**Area.**—The area under maize in British India is about six million acres, of which nearly two million acres are in Bengal and Bihar. In all the districts of the Patna Division, in Monghyr, Bhagalpur, Sonthal Parganas, Hazaribagh, Singhbhum, and Darjeeling, maize forms a principal article of diet among the poor.

**Classification.**—This plant has not been discovered in the wild state. In remote antiquity it was not known in the Old World, but grown only by the Peruvians and the Mexicans. It has been, however, found suitable for nearly every climate, and it is now grown successfully in the cold hills of Sikkim and Bhutan, as well as in the hot and arid soil of Manbhum and Singhbhum. It does well in the moist climate of Bengal and in the dry climate of the United Provinces, Rajputana and the Punjab. The American varieties are the best, but these introduced into India, degenerate into types similar to those grown in India in the course of a few generations. Improvement on the lines of cultivating the best Indian maizes only seems to be the most practical way of dealing with the question. Originally maize must have come from America to India, but there are now regular Indian types. The three recognised Indian classes are : (1) large-cobbed dry-grain producing class, usually yellow ; (2) the class that produces sweet and large green cobs, usually white, for roasting or boiling purposes ; and (3) the class that gives the best "popped corn" (or *khai*), which is usually a many, but small-cobbed, class. White, yellow, red and black varieties are also distinguished, and then there is the further distinction between *hharif* and *rabi* maize, also between those which take only about three months growing and those which take as many as six. The stalks of maize being very tough and free from siliceous matter, are used in Germany for making high class paper. Bank-notes are made from maize-stalk pulp. Attempts may be made to grow maize largely in the vicinity of Indian paper-mills and induce the paper manufacturers to use maize-stalks.

**Cornflour.**—Maize grain, both green and dry, cooked and uncooked, is somewhat difficult to digest. But made into meal and cooked, it is easily digested. Cornflour is manufactured by first steeping the maize in hot water and then grinding it between large mill-stones. The pulp is then passed through sieves into huge vats where the cornflour settles, the gluten remaining in the sieves. Maize diet gives the tendency to accumulate internal fat which is injurious to working animals like bullocks and horses. If cattle are fed with maize it should be given mixed with other food, such as straw, grass and oil-cake. Too much maize produces acute

indigestion, colic, impaction of the rumen, swelled legs, etc. But climate and habit have a great deal to do with the question of diet. Bhutia ponies and Sonthal coolies are able to digest maize even outside their own native climate. Maize contains more fat and is more fattening than other grains if it can be digested. The cobs divested of grains are rich in carbonate of potash, containing as much as 1.762 per cent., i.e., twice as much as is contained in wood, and they should, therefore, be thrown into the manure pit. The straw is not of much value as fodder (except for elephants), if the cobs are allowed to ripen; but if the cobs are disposed of in the green state, maize-stalks are as valuable for fodder as juar stalks, specially if they are converted into silage.

**Manuring and Rotation.** Maize is an exhausting crop and it requires *heavy manuring* or very good soil to produce good yield. Carrots are frequently sown in the United Provinces between the lines of *rabi* maize, while the crop is still standing, especially when drought is threatened. The leaves of the carrots are given to cattle and the roots are eaten by people. In years of heavy rainfall, gram, poppy, mustard or safflower follows maize. But wheat or barley is often grown after maize, though it is against the principle of rotation of crops to do so. In some parts of the Punjab three crops are taken in succession in the same year from the same land. Melon is grown after wheat or barley is off the ground in March and the land is prepared early in July for the maize crop as by then the melon crop is over.

**Soil.** - Maize prefers high open and even rough gritty soil, with plenty of humus in it. The hilly regions of the Darjeeling district are especially suited for growing high class maizes. In Lohardaga, Singhbhum, Manbhum and in Bihar districts also, large crops of maize are obtained especially near homestead lands. The damp alluvial low-lands of Bengal are not so suited for this crop, if it is intended for grain. But homesteads, throughout Bengal, where no water-logging takes place, are well adapted for growing maize for green cobs. Maize may be grown either as a *kharif* or a *rabi* crop, but it is not profitable to grow it as a *rabi* crop unless there are special facilities for irrigation.

**Cultivation.**—In May or June after a good shower of rain, land already ploughed up once in the cold weather should be ploughed and cross-ploughed and harrowed, and the seed should be dibbled  $1\frac{1}{2}$  to 2 inches deep in regular lines eighteen inches apart at the rate of three to four seers per acre. When the plants are all well up, one hand-weeding should be given. If the soil is found too dry three days after sowing and no rain is immediately expected, it is safe to irrigate the land once. Early sowing with irrigation (if necessary), gives much better result than late sowing when no irrigation is required owing to the monsoon being in full swing. Heavy rain does the greatest harm to maize-plants when they are yet of small size. No harm is done to maize-plants by heavy rains

if they come after they are nine to eighteen inches high. If irrigation is easy, it is better to sow the seed in April or May after irrigation, or after a good shower of rain, as the drought subsequent to a free germination is not so injurious to maize plants which are deep rooted plants, and irrigation may be resorted to if there is prolonged draught. After one hand-weeding, two hoeings with the Planet Jr. hoe would give the plants a very good start. The use of saltpetre would be of further benefit. If the land is known to be poor, cow-dung or some other general manure, applied in the cold weather or before sowing would give better results. Continuous rainfall is not helpful to the growth of maize. There should be periods of fair weather intervening between heavy showers of rain. Before the rains set in, earthing should be done that there may be no water-logging at the base of the plants.

**Outturn.** It is more profitable to sell the green cobs and use the stalks for fodder wherever there is a demand for them than to let the grain ripen. The cobs can be picked and sold in June, July and August. If they are allowed to mature, harvesting should be done in September, or when the grains are quite red ripe and dry. In Bihar districts sowing takes place in July and harvesting from October to December according to variety. Ordinarily five to eight maunds of grain per acre is considered a fair yield, but 30 or 40 mds. are sometimes obtained. The value of a five to eight maund crop is only about Rs. 10. An acre (if ravages of jackals are prevented) may produce 20,000 green cobs. If these are sold at an average price of 8 cobs per pice, the produce of one acre may come up to Rs. 35 to Rs. 40. In fact, about Rs. 40 were realised in 1898 and Rs. 75 in 1901 from the maize crop at the Sibpur Farm, out of nine-tenths of an acre only. Maize is a profitable crop to grow near large towns, where there is a ready market for the green cobs. The precaution of watching the crop day and night, not only against jackals but also against crows and other birds, squirrels, rats, and in some parts of the country, against pigs, monkeys and porcupines, is most essential. The Jaunpur variety has been found to be the most prolific and yet early.

**Hulling.**—It is convenient to use a maize-huller (Fig. 58) for detaching grains from the cobs. By flailing or beating with sticks, the operation is done rather imperfectly.

## CHAPTER XXX.

### JUAR OR GREAT MILLET (SORGHUM VULGARE).

[Classification; Varieties of sorghum vulgare; *Shalu juar* worth introducing; Composition of grain and straw; fodder value of the crop; Cultivation for grain and fodder; Soil; Drought-resisting property; Smut; Poisonous *juar*; Feasibility of improvement in Nadia and Murshidabad.]

**Varieties.**—This crop, though of minor importance in Bengal, is the staple grain-crop of many of the drier parts of India. Three



varieties of sorghum should be recognized as of special merit : (1) Sugar Sorghum, *Sorghum saccharatum*, which yields several cuttings of sweet and palatable fodder ; (2) the Gahamā or Karmi sorghum (*Sorghum Roxburghi*), which yields the heaviest crops of fodder ; and (3) the Deo-dhan sorghum, the Cholam of Southern India (*Sorghum vulgare*), which yields the best grain, inferior only to the best wheat for bread-making. The first is also known as Sorgho or Imphe and is grown in America and Africa. There are three distinct varieties of *Sorghum vulgare*, a Bhadoi variety, a winter or late variety, and a spring variety (called *Shalu juar*). In Bengal the Shalu variety should be introduced as a catch-crop, as the rice-crop is sometimes a failure, and no use is made of late rain in October and November in districts where rice, maize and millet are the principal crops.

**Chemistry.**—The high value possessed by Sorghum grain will be evident from the following table :—

|                |    | Albuminoid. | Starch. | Oil.   |
|----------------|----|-------------|---------|--------|
| Indian Sorghum | .. | .. 9.3%     | 72.3%   | 2. %   |
| Indian Rice    | .. | .. 7.3 ..   | 78.3 .. | 6 ..   |
| Indian Wheat   | .. | .. 13.5 ..  | 68.4 .. | 1.2 .. |
| Indian Oats    | .. | .. 10.1 ..  | 56.0 .. | 2.3 .. |

The following figures show the high value of green *juar* as fodder compared to turnips which are greatly prized as fodder in England :—

|                |    |    | Green Juar. | Turnips. |
|----------------|----|----|-------------|----------|
| Water          | .. | .. | 85.17       | 90.43    |
| Albuminoids    | .. | .. | 2.55        | 1.04     |
| Starch and fat | .. | .. | 11.14       | 7.89     |
| Ash            | .. | .. | 1.14        | .64      |

To the agricultural population, in many parts of India, *juar* is a more important crop than even wheat and rice. It yields a nourishing grain, and about the same quantity per acre as wheat (900lbs.) and ten times as much in fuel and fodder as the ordinary cereal crops. As fodder crops are at a discount in India, the growing of superior varieties of *juar* for food and fodder should be encouraged as much as possible. When grain is allowed to ripen, the lower half of the *juar* stalk should be used for fuel and the upper half for fodder. But the best fodder is obtained from green *juar* just when the heads are visible, when it is in full vigour of growth and not too tall. Cut at this stage, it affords a more nutritious fodder than turnips, and a second and a third cutting, and sometimes even a fourth, may be also obtained if the land is cultivated after each cutting. The second cutting is of less nutrient value and weight, and third cutting of still less value, but these are obtained at the dry season when there is great scarcity of fodder. The hard lower portion of *juar* stalks can be silaged and converted into fodder.

**Juar for fodder** should be sown with the help of irrigation, if necessary, in May, and sowings should continue through June

and July, that there may be a succession of fodder crops of first, second and third cuttings, from July to March or April, a portion of which can be dried and preserved for use from April to June. The dry stalks should be stacked and thatched, either on high land, or over temporary cattle sheds. About 280 maunds per acre, *i.e.*, about 22,000lbs. is the average weight of the first cutting and the second and third cuttings, if irrigated, produce as much again, or if left unirrigated but cultivated in proper season, about 10,000lbs. more. Dried, the fodder loses about two-thirds in weight. If the first cutting is taken when the rainy season is still on, and the second cutting when the land is still moist, say early in November and if the land is ploughed both times, very fair results can be had even without irrigation. 30,000lbs. to 40,000lbs. of green fodder will keep a yoke of oxen receiving 60lbs. per diem for one year. Any of the *juar* that is allowed to run into grain will also afford about 10,000lbs. of dry straw per acre, half of which can be used as fuel and half as fodder, but this fodder is less valuable than green *juar* (dried). *Juar* straw is considerably better as a fodder than rice straw, and it should be given at the rate of half a maund per bullock of ordinary Bengal size, properly chopped up and mixed with oil-cake and water. If 500lbs. of grain and 10,000lbs. of straw are obtained per acre of *juar*, an acre will support a man and a bullock, the man being allowed 40lbs. of grain per month.

**Soil.**—*Juar* is grown both on rich and on poor soil, and though it does best on deeply cultivated rich loam (like the black cotton soil of Central and Southern India), it is a very hardy crop and it stands drought fairly well, though it is not a deep-rooted crop like maize. For very dry soils, *juar* is not a suitable crop, and for such *bajra* and *kodo* are more suitable. If rich land is chosen for this crop the yield of grain is proportionately very small, the straw showing a most luxuriant growth. Low-lying land is unsuitable for *juar* as water-logging kills it.

**Cultivation.**—The same sort of cultivation as is recommended for maize should be adopted. The roots are easily spoilt by water-logging, hence ridging or earthing is advisable and water accumulating in the field should be let out. In dry climates this precaution is unnecessary but interculture here is essential. Ten pounds of seed should be used per acre, if it is grown for grain, but 30lbs per acre if it is grown for fodder, sowing being done 18" × 9" apart in the former case, and 9" × 6" in the latter. It is usually grown mixed with *arahar*, cotton, etc. But the best result is obtained by growing it singly.

**Diseases.**—The *juar* crop is very much subject to fungoid diseases, specially if the heads appear in the rainy season. Rust, smut and bunt having been all noticed. Insects, birds and squirrels also do a great deal of damage. We have seen smut in a very exaggerated form in the *juar* grown at the Sibpur Farm. The seed should always be sown pickled with sulphate of copper

for preventing fungoid diseases. Another means of avoiding smut and obtaining a better yield of grain is to do the sowing in July instead of in May or June, when the flowering takes place after the rains are over. Grown in a damp climate it is impossible to avoid diseases in *juar* grown for grain, and in such a climate *juar* for fodder alone should be grown.

**Poisonous juar.**—It should be noted here, that stunted *juar* grown when there is deficiency of rainfall, is poisonous to cattle, and contains prussic acid. If irrigation is not available *juar* should not be sown till June, *i.e.*, the commencement of the monsoon, that the ill-effects of early drought on this crop may be avoided. Sowing late in August should not be done either, that the ill-effects of late drought may be also avoided. Death among cattle from eating stunted and parched up sorghum is fairly common in the Punjab.

**Extension of cultivation.**—It will not be easy introducing the cultivation of *juar* where people do not know this crop, but where *juar* is grown by a few cultivators, as in parts of Nadia and Murshidabad, the cultivation can be extended and the superior Matichur *juar* of the Central Provinces introduced. The introduction of *juar* fodder is not attended with such difficulty, as cattle are less conservative than men in their choice of food.

## CHAPTER XXXI.

### MARUA OR RAGI (ELEUSINE CORACANA) AND OTHER LESSER MILLETS.

[Value of the *Marua* crop; Yield; Cultivation; Chemical Composition; Beverage; Area; *Cheena*; *Shama*; *Gondls*, *Lavo*; *Menjhri* or *Kutki*; *Kaon* or *Shyal*; *Naja*; *Bajra*; *Kodo*.]

**Marua** is more commonly grown in Bengal than *juar* though its yield is rather poor, the average being about eight maunds per acre. In some parts of Madras it produces over 2,000 lbs. per acre in the red soils with irrigation. At the summit of each stem are four cruciform digitate spikes full of grain. This grain is supposed never to be attacked by insects and to keep for any length of time. There is some advantage therefore in growing this grain for storing it against years of famine, whenever that may happen. 4,000lbs. of straw per acre is obtained in some irrigated soils in the Madras Presidency.

**Cultivation.**—Immediately after wheat or some other *rabi* crop is harvested, the land is prepared in the same manner as it is prepared for *aus* paddy. The seed (7 to 10lbs. per acre) is sown broadcast, and a log of wood or roller is passed over the land to cover the seed. When the plants are two or three inches high, harrowing is done, and vacant spots are filled in by plants taken

out from those spots where they are too thick. In the Punjab, in Mysore and in parts of Bihar the seed is sown in seed-beds and afterwards transplanted. This is a better system. The harvesting is done in September, *i.e.*, about three months after sowing. It is a difficult crop to harvest as the ears ripen very irregularly. The proportion between the quantity of seed sown and the outturn of grain is about 1 : 40. The straw is more nutritious than rice-straw, though it is said to decrease the flow of milk. The quantity of straw ordinarily obtained per acre in Bengal is less than 1,000lbs. The grain contains very little husk, only about 5 per cent. The chemical composition of the husked grain is given below :—

|                   |    |    |    |    |        |
|-------------------|----|----|----|----|--------|
| Water ..          | .. | .. | .. | .. | 13.2 % |
| Albuminoids ..    | .. | .. | .. | .. | 7. "   |
| Starch ..         | .. | .. | .. | .. | 73.2 " |
| Oil ..            | .. | .. | .. | .. | 1.5 "  |
| Fibre ..          | .. | .. | .. | .. | 2.5 "  |
| Ash ..            | .. | .. | .. | .. | 2.3 "  |
| Nutrient ratio .. | .. | .. | .. | .. | 1.11,  |

The grain is somewhat indigestible and is eaten only by the poor classes. The hill tribes of Bengal make a fermented beverage out of this grain.

The area under this millet in British India is estimated at over three million acres, of which nearly a million acres are in Bengal and Bihar. The crop is grown in the districts of Bihar, Chhota Nagpur and in Darjiling.

**Other millets.**—With regard to the other less important cereals, a table may be given summarising the principal facts regarding their cultivation :—

|  | Time of sowing.      | Quantity sown per acre. | Time of harvesting. | Outturn of grain.                       | REMARKS.  |
|--|----------------------|-------------------------|---------------------|---|---|
| 1. <i>Panicum miliaceum</i> .—common millet or <i>cheena</i> . | Feb. & March or Aug. | 10lbs.                  | May or Oct.         | 600lbs. of grain + 1,000 lbs. of straw. | Grown sometimes by irrigation. Digestible and cooked like rice; grown also for fodder only in the Punjab. Seed shed easily. <i>Paramanna</i> made out of it is delicious. |
| <i>Panicum frumentaceum</i> or <i>shyama</i> .                 | End of June.         | 2lbs.                   | Oct.                | 400lbs. of grain + 80 lbs. of straw.    | Rough jungle land is chosen. Considered a poor grain. No manuring or irrigation needed. Good fodder.  |

|  | Time of sowing.              | Quantity sown per acre. | Time of harvesting. | Outturn of grain.   | REMARKS.   |
|--|------------------------------|-------------------------|---------------------|---|--|
| 3. <i>Panicum mi-<br/>liare</i> or <i>gondli</i>                             | June &<br>July.              | 10lbs.                  | Oct. &<br>Nov.      | 500+1,000<br>lbs.   | Dry and sandy localities chosen. A superior winter variety called <i>Laro</i> is harvested with winter rice.   |
| 4. <i>Panicum psi-<br/>lopodium</i> ,—<br><i>Menjhi</i> or<br><i>Kutki</i> . | End of<br>June               | 2lbs.                   | Oct.                | 600lbs<br>(grain)   | Grain husked like paddy and eaten like boiled rice.  |
| 5. <i>Panicum itali-<br/>cum</i> ,— <i>Kaon</i> and<br><i>Shyatnaja</i> .    | June and<br>July.            | 5lbs.                   | Oct &<br>Nov.       | 500lbs<br>of grain<br>+ 1 000<br>lbs of<br>straw.             | Dry, sandy soil.   |
| 6. <i>Pennisetum<br/>typhoideum</i> or<br>spiked millet<br>( <i>bajra</i> ). | Middle to<br>end of<br>July. | 6 to 10lbs.             | Oct. &<br>Nov.      | 300 to 500<br>lbs. of<br>grain<br>+1,000<br>lbs. of<br>straw. | Poor free, dry, sandy soil. Village refuse sometimes used as manure. No irrigation required: considered poor fodder. Pollen washed away if sowing is done early. |
| 7. <i>Paspalum<br/>serobiculatum</i><br>or <i>kodo</i> .                     | End of<br>June.              | 2lbs.                   | Oct.                | 600lbs.   | Jungle land and rough rocky soil chosen. No manuring or irrigation done. Straw is poisonous, especially for horses. Grain has intoxicating property.             |

## CHAPTER XXXII.

BUCK-WHEAT (*POLYGONUM FAGOPYRUM*).

THOUGH not a graminaceous crop, buck-wheat is classed among cereals, as bread is made out of the flour from this grain. Its straw is more nutritious than cereal straw. It is grown in the Darjiling hills, where it is called *Phápar*, also in Bihar and in the Central Provinces, where it is known as *Rájjír*. It is sown at the end of June-

on roughly prepared land at the rate of 50lbs. per acre when broadcasted or 12 to 25lbs. when drilled. Harvesting is done in October. The seed sheds easily when it is ripe, and it is therefore necessary to get on with the harvesting operation early. Harvested early, the straw also is more nutritious. The green leaves are cooked and eaten as *sîg*. 1,200lbs. of grain may be taken as the average produce per acre on suitable soils. Clay soil is not suitable for this crop, and it is very curious, that it grows best on poor granitic soils and that it is scarcely ever manured. The grain of buck-wheat is very nourishing. A bushel of buck-wheat weighs about 50lbs. and a bushel of oats about 40lbs. One bushel of buck-wheat is considered equal to two of oats in feeding value. 8lbs. of buck-wheat flour is equal to 12lbs. of barley meal. For feeding hens, buck-wheat is specially appropriate, as it induces them to lay eggs earlier. Another advantage of growing buck-wheat consists in the fact of its getting ready in ten weeks after sowing, and it is therefore a splendid catch-crop. Its suitability for growing on poor soils is further enhanced by the fact of its being able to stand greater extremes of cold and heat than most crops. Hence it is suitable for growing both in the Darjiling hills and in the soils of Chhota Nagpur which are poor even in lime. It is killed by frost, but it can stand a temperature of 105° to 110°F. It should be introduced as a catch-crop for utilising rain out of season.

## CHAPTER XXXIII.

## PULSES.

[Acreage under gram and pulse crops generally; export; the principal pulse-crops; recuperative effect of growing pulse-crops; leguminous weeds, indicative of rich soil; best weeds for pasture land; *Arahar*, *Maghi* and *Chastali*; gram; *Kulthi* or Madras gram; *Popat*-bean or *Val*; *Soy* bean; *Khesari*; *Musurs*; *Bhringi*; *Urd*; *Mash kalas*; *Mung*; French beans; country peas; English peas; *Barbati* and *Ghangra*; cluster-beans; cost; mixtures; best soils.]

NEXT to cereals, pulses occupy the most important place as food-grains, though oil-seeds and jute occupy more land in Bengal. The only pulse-crop for which separate statistics are obtainable is the gram, under which there are more than eleven million acres in British India, including over one million acres in Bengal. The districts of Bengal specially suited for the gram crop are Gaya, Monghyr, Bhagalpur, Patna, Murshidabad, Nadia, Shahabad, Darbhanga, Santhal Parganas, Hazaribagh and Palamau. The other pulses are included in Government returns under "other grains and pulse," of which there are nearly 30 million acres in India, including about 5½ million acres in Bengal. It has been estimated that the total area under pulse-crops in India is about 48,000,000 acres, i.e., about 15,000,000 acres more than the area

occupied by wheat. The export of gram, which is fairly constant, amounts to only about 315,000 cwt. valued at about 10 lakhs of rupees, and of other pulses put together about 632,000 cwt. valued at 18 lakhs of rupees. The principal pulses of India are, according to their relative importance :—

- (1) *Cajanus indicus*, pigeon-pea, *dāl*, *tuer* or *arahar*.
- (2) *Cicer arietinum*, chicken-pea, gram, *chholā* or *chenā*.
- (3) *Dolichos biflorus*, the horse-gram, *kurthi-kalai* or *kulthi*.
- (4) *Pisum arvense*, field-pea, *desi matar*.
- (5) *Pisum sativum*, European and American pea, *bilati matar*.
- (6) *Dolichos lablab vulgare*, Indian bean. *Shim*, *popat*, *val*.
- (7) *Glycine hispida*, Soy-bean, *bhāt* or *gari-kalāi*.
- (8) *Lathyrus sativus*, *khesari*. *tur* or *tewra*.
- (9) *Ervum lens*, the lentil, *musuri*.
- (10) *Phaseolus aconitifolius*, *moth*, *mothi* or *bhringi*.
- (11) *Phaseolus Mungo*, var. *glabar*, green gram, *mung* or *mug*.
- (12) *Phaseolus Mungo*, var. *radiatus*, *mish-kalai* or *urd*.
- (13) *Phaseolus vulgaris*, Kidney-bean, French-bean or haricot.
- (14) *Vigna catiāng*, Cow-gram, *barbati* and *ghangra*.
- (15) *Cyamopsis psoralioides* or cluster-beans, *urhariā shim*, *gamhar simmi* : or *bilati sim*.

The general recuperative effect of pulse-crops on soils should be remembered. Lime and ashes are the best manure for pulse crops, and cowdung and other organic manures, the worst. The commonest leguminous weeds of Sibpur, which are also excellent fodder for milch cattle, are *Pisyrā matar* (*Pisum quadratum*), *Chunā kabīi* or *Ankrī* (*Vicia sativa*) and *Chunā musuri* or *Ankrī* (*Vicia hirsuta*). The following table summarises the principal facts regarding the cultivation of pulse-crops :—

| Name of crop.  | Time of sowing.   | Quantity sown per acre. | Time of harvesting.    | Quantity harvested per acre.                  | REMARKS.   |
|--|---|-------------------------|------------------------|---|--|
| 1. (1) <i>Arahar</i><br><i>Maphy</i><br>& (2) <i>Chaitāi</i> . | May.<br>End of June<br>(Central Provinces) up to July<br>(Madia). | 5 to 10 lbs.            | (1) Jan.<br>(2) April. | 400 to 800 lbs (up to 1200 lbs in up-country) | (Often sown mixed with a millet, etc. Not suitable for sandy soil or land subject to inundation. Red clay-loam best. Stands drought well. <i>Chaitāi arahar</i> is harder and keeps better. United Provinces and Bihar seeds give better result in Lower Bengal than local seed. Best crop to grow from time to time for renovating soil. No irrigation necessary. |

| Name of crop.                     | Time of sowing.   | Quantity sown per acre.                      | Time of harvesting.  | Quantity harvested per acre.   | REMARKS.   |
|-----------------------------------|---|--|--|--|--|
| 2. Gram.                          | End of October.   | 15 to 50 lbs.<br>(Cabul gram 75lbs.)         | February to middle of March.   | 200 to 400 lbs. (up to 1,000 lbs. in up-country), also 1,000lbs. of straw which is excellent fodder. | Gram requires no irrigation either, but there should be sufficient moisture in the soil at sowing time and the land should be kept properly open for reception of nocturnal dews. If rains cease early, sowing can be done in September, but this is risky in Lower Bengal. Cotton, wheat, linseed, barley or rape is often sown with gram. Does best on the clay-loam which is not too damp. Heavy rain or irrigation spoils this crop. Heads should be nipped off, or sheep let loose for a day or for a shorter time. Soils containing a good deal of lime are specially adapted for gram. The Cabul gram grown at Sibpur Farm is the best variety to grow in Bengal. |
| 3. <i>Kulthi</i> , Madras gram.   | October or November, if for grain. If for fodder, may be sown in dry regions in (1) June, (2) August and (3) November, three times on the same field. | 20lbs., if for grain, 25lbs., if for fodder. | February, if for grain; if for fodder, (1) August or Septr., (2) Octr or Novr. and (3) January. If this 3rd crop is seeded the grain is harvested in Febr. | 300 lbs. of grain or 5 tons of green fodder, per crop.   | Stands drought well. Is the staple horse-gram of South India. Considered the best cleaning crop, like <i>Aus</i> paddy. No falling off of yield is noticed if three crops are taken in succession. Light dry soil is preferred. The grain being very hard should be given boiled to cattle and broken and wetted with water to horses.   |
| 4. <i>Popat</i> or <i>Val</i> .   | July or later   | 5 to 8lbs.                                   | Jany. and Febr.  | 250lbs. to 400lbs.   | This is a large crop of the Central Provinces and Western India. The pods resemble <i>sim</i> but they are inferior to Bengal <i>sim</i> as a table vegetable, though the seed inside the legumes is quite as good to taste as haricot beans.  |
| 5 Soy-bean ( <i>Gari-kafai</i> ). | Beginning of November.  | 30lbs.                                       | End of March.  | 400 to 500lbs.   | This contains 40 per cent of albuminoids. Grows abundantly in the Manipur and Naga hills. It is the richest pulse-crop of China and Japan. Experiments are being conducted with a view to introducing this pulse in several districts of India.  |



| Name of crop.  | Time of sowing.  | Quantity sown per acre. | Time of harvesting.  | Quantity harvested per acre.                     | REMARKS.   |
|--|--|-------------------------|----------------------|--|--|
| 6. <i>Khesari</i>                                      | October.   | 12 to 16lbs             | March.               | 300lbs +400lbs. of straw                         | Usually sown when winter paddy is growing. In the <i>Rarh</i> , gram, teola or <i>khesari</i> , linseed, and sometimes <i>mash-kalai</i> are sown together broadcast in October in wet rice land without any preparation. <i>Khesari</i> actually does better sown in this way. Gram and linseed fruit more profusely though the plants become shorter under this treatment. |
| 7. <i>Musuri</i>                                       | October to December.   | 12lbs. ..               | February & March.    | 350 to 750lbs. and same quantity of straw        | Better land than <i>khesari</i> is chosen for this crop and more ploughing is necessary for this than for <i>kalai</i>   |
| 8. <i>Bhringi</i>                                      | End of June  | 8lbs. ..                | End of Sept          | 200 lbs & 800lbs. of straw.                      | Rough, sandy or gummy soil is usually chosen. Usually grown along with <i>Juar</i> as fodder crop, in some of the upper districts of Bengal. Harvested before <i>Juar</i> .  |
| 9. <i>Urd</i> or <i>Birhi</i> or <i>Kalkid-Kalai</i> . | June ..  | 8lbs.                   | Sept. ..             | 300lbs. & 800lbs. of straw.                      | Grown with <i>Juar</i> or <i>Aus</i> paddy, or separately. The cultivation of those pulses which grow in the rainy season should be extended. These should be sown in ridges and the ridging plough is therefore invaluable if <i>Kurthi</i> , <i>Bhringi</i> , <i>Popat</i> , <i>Atharia</i> shim and <i>Urd</i> are grown.   |
| 10. <i>Mash-Kalai</i> .                                | September in lower districts; 15th July to 15th August in <i>Sonthal Parganas</i> and other hilly and dry districts. | 8lbs. ..                | (1) Jany<br>(2) Nov. | 300lbs to 600lbs & 400lbs. to 800 lbs. of straw. | Grown largely on <i>Aus</i> lands and <i>dearh</i> tracts. This is the staple <i>kalai</i> of the cultivator.  |

| Name of crops.   | Time of sowing.  | Quantity sown per acre.                         | Time of harvesting.  | Outturn per acre.   | REMARKS.  |
|--|--|---|--|---|---|
| 11. <i>Mung</i><br>or <i>Mung</i> .  | June (in high and dry localities).<br>October (in lower districts) | 5 to 8 lbs.<br>..                               | Sept. or Oct. (in high & dry localities)<br>February (in lower districts). | 200lbs. to 500lbs. and about the same quantity of straw                         | Red loamy soil or dry and sandy soils are chosen for this crop. In the United Provinces and the Central Provinces mung is sown in dry and sandy soil at the commencement of the rainy season. This practice can be adopted in high and dry and rocky soils of Sonthal Parganas, Birbhum, Manbhum, etc., where mung can be sown with juar. The sowing should be done in ridges if done in June or July.  |
| 12. French-beans.  | Oct.,<br>Novr &<br>Decr.   | 20lbs.  | December to March.   | 1,600lbs. to 2,000lbs. of green vegetables.                                     | This is a fairly profitable crop to grow near large towns where there is a European population. Clay soil is better than sandy soil for beans.  |
| 13. Country peas.  | Beginning of<br>Novr.  | 10lbs., if for grain;<br>20lbs., if for fodder. | March &<br>April.  | 250lbs. or 3,000lbs. of green fodder.   | Country peas are grown on <i>dearh</i> land after the water goes down and in low-lying clay rice-fields, after the rice harvest.  |
| 14. English peas.  | Novr &<br>Decr.  | 15lbs.  | December to March.   | 1,200lbs. to 2,000lbs. of green vegetables.                                     | European or American peas are best to grow near large towns as table-vegetables. Rich clay soil is better than sandy soil for English or American peas.   |
| 15. <i>Vigna catiang</i><br>tender legumed<br><i>barbati</i><br>or harsh legumed<br><i>ghangra</i> .   | April &<br>May, or<br>Octr. &<br>Novr.                             | 12lbs.  | August or March.   | 50 mds. legumes ( <i>barbati</i> ) or 10 mds. of <i>dāl</i> of <i>ghangra</i> . | Only about 20 or 30 Rupees per acre can be expected by growing beans or peas, even as English vegetables, of which Rs. 15 will go out in expense. French-beans are more profitable than peas. Imported seed is better than even "Olonda" or "Patani" or "Kabli" peas seed. European peas and beans are benefited by light irrigation. Ashes and phosphatic manures are the best manures to use. Beans are benefited by organic manures (cow-dung, etc) when used sparingly on land which is rough and open. |
| 16. Cluster-beans, or <i>Oyamopsis psora</i> .<br><i>Hoides Gamhar</i><br>or <i>Gavar</i> ,<br><i>Būati sim</i> , or<br><i>Atharia sim</i> . | April &<br>May, or<br>Sept. &<br>October.                          | 10lbs.  | August or February.  | 100 to 200 mds. of green fodder or 40 to 50 mds. of green legumes.              | Grows in parts of Orissa, Chhota Nagpur, Sonthal Parganas, Bihar and Gujarat. It is worth cultivating largely, as it is a fertilizer of soils, it yields a nourishing little legume which is relished by man, and a fodder highly useful for cattle.  |

The *expense* of growing leguminous crops generally is very little, Rs. 5 per acre for the country pulses and Rs. 15 to Rs. 20 for European peas and beans.

**Green fodder.**—Kalai, country peas, arhariá sim, bhringi, and khesari plants are sometimes grown only as green fodder for cattle. Sometimes two or more of the following crops, *viz.*, rape, musuri, country peas, khesari, wheat, barley, gram and linseed are sown mixed together. Rape ripens first, then ordinary mustard, then musuri, then linseed, then matar, then khesari, wheat, barley, and gram. Barbati is of two varieties. The one with soft skinned pods and short bushy creepers is eaten as a table-vegetable in the green state; the other with harsh skin and larger plants is grown for *dál*. It is a highly fertilising crop, and is largely grown as a preparatory crop for sugarcane.

In the United Provinces and in Bihar where land is lighter and generally richer in lime than in Lower Bengal, pulse-crops give a heavier yield. In the deltaic portion of Bengal pulse-crops do not grow well, an excess of ordinary salt in the soil being very injurious to these crops. Well-drained land annually renovated with silt produces the best pulse-crops in Lower Bengal.

## CHAPTER XXXIV.

### OIL-SEEDS.

[The principal oil-seed crops; the minor oil-seeds; acreage; export trade in oil-seeds and oils; the former trade to be deprecated. Sunflower, cashew-nut, Pittaraj, Nim. Drying and non-drying oils.]

The principal oil-seed crops of India are, Brassica (rape, colza and mustard), *Linum usitatissimum* (linseed), *Sesamum indicum* (*til* or *gingelly*), *Eruca sativa*, *tírímani*, *Carthamus tinctorius* (safflower), *Guizotia abyssinica* (niger), *Ricinus communis* (castor), *Papaver somniferum* (poppy), *Arachis hypogæa* (groundnut), and *Gossypium* (cotton).

**Minor oil-seeds.**—Besides, the oil-seeds which are in common use, for which separate chapters are provided in this book, there are some minor oil-seeds, which are used in some parts of the country for extraction of oil. These are *Helianthus annuus* or sunflower, *Anacardium occidentale* or cashew-nut (*Hijli-badam*), *Semecarpus anacardium* or marking-nut, *Amoora rohituka* (*Rayna* or *Pittaraj*), *Melia Azadirachta* or margosa (*Nim*), *Galedupa indica* or *Pongamia glabra* (*Kenja* or *Karanja*) *Argemone mexicana* (*Sialkanta*) *Calophyllum inophyllum* (*Punang*), *Schl'ichera trijuga* (*Kusum*), and *Buchanania latifolia* (*Chironji*, the seed of Piyal tree). The oil of *Cocos nucifera* (cocoanut) and of *Bassia latifolia* (*Mahua*) are in more common use and separate chapters will be provided for these.

**Acreage.**—The recognized oil-seed crops of British India occupy an area of about 14½ million acres, of which the Province

of Bengal furnishes nearly 4 million acres. Next to cereals, oil-seed crops occupy the largest area in Bengal. According to the extent of cultivation of these crops the different districts of the three provinces of North-East India come in the following order :—

|                               |                |
|-------------------------------|----------------|
| 1st, Mymensingh .. .. .       | 462,300 acres. |
| 2nd, Sonthal Parganas .. .. . | 230,300 „      |
| 3rd, Darbhanga .. .. .        | 229,400 „      |
| 4th, Gaya .. .. .             | 210,500 „      |
| 5th, Rungpur .. .. .          | 178,700 „      |
| 6th, Purnea .. .. .           | 173,900 „      |
| 7th, Pubna .. .. .            | 148,200 „      |
| 8th, Dacca .. .. .            | 146,300 „      |
| 9th, Nadia .. .. .            | 140,500 „      |
| 10th, Dinajpur .. .. .        | 130,200 „      |
| 11th, Sylhet .. .. .          | 110,600 „      |
| 12th, Hazaribagh .. .. .      | 108,520 „      |
| 13th, Jessore .. .. .         | 103,500 „      |

**Trade.** - The enormous export trade in oil-seeds is a great loss to the country, and it is highly advisable to organise a system of pressing the oil in this country, exporting only the oil and retaining the cake for use as animal food or manure in the country. The export of oils from India is a little over eight million gallons per annum, valued at about one crore of rupees. Of this quantity three-fourths consist of castor-oil, which is highly valued for lubricating, soap-making and other purposes in Europe. One-and-a-half million gallons of cocoonut oil, valued at 16 lakhs of rupees, is the oil of next importance which is exported. Against this, there is a rapidly increasing export of oil-seeds, valued at over 12 crores of rupees from India. The question of the fertility of Indian soils is intimately blended with that of the export of oil-seeds and bones. To England goes most of the linseed. America also buys a good deal. The other oil-seeds go chiefly to the Continent of Europe.

**Helianthus annuus (sunflower).**—Sunflower oil is used in Europe as a substitute for olive and almond oil for culinary and table uses and it is largely used in Russia. For candle and soap-making it is superior to most oils. Sunflower seed and oil-cake are a valuable food for cattle. Poultry, pigeons and rabbits are specially fond of the seed. Experiments conducted in India have shown that it is a costly crop to grow. The leaves and stalks are eaten by cattle and they make a fairly good manure. The stalks may be also used as fuel and the ashes employed as a potash manure. As a garden plant only, yielding seeds which are useful for feeding home poultry, its propagation can be encouraged but not as a regular oil-seed crop.

**Anacardium occidentale (cashew-nut or hijli badam).**—Originally a native of South America, this tree has established itself in the coast forests of India—in the Contai sub-division of Midnapore, in Orissa, in Chittagong and in Madras. A weak solution of the gum of this plant which is very slightly soluble in water may be used as a

preventive against the attack of insects. To this may be added a little asafœtida and a little aloe to make it more effective. The juice issuing from the bark is used as an indelible marking ink like *bhela-nut* juice. The bark is used for tanning. The ripe fruit is eaten. The pericarp of the seed which is partly outside the fruit, contains an acrid oil, black in colour, which is a good preventive against white ants and which is used for tanning or colouring boats and fishing lines and fishing nets, like the mesocarp of the *gab* fruit. The kernels of the seed are delicious eating, and about 40 per cent. of an oil which is equal to almond oil and superior to olive oil is obtained from the kernels.

**Amoora rohituka (Pittaraj or rayna)**.—The oil from the seed of this tree is used in some parts of Northern and Eastern Bengal as a lamp oil. The seeds are fried and bruised, then boiled with water, when the oil floats on the top. The timber is good but little used.

**Melia azidrachta** —Nim seed being very common, the value of *nim* oil as an antiseptic and anthelmintic veterinary medicine, and of *nim* oil-cake as a fertiliser containing 5 to 5½ per cent. of nitrogen and about 1½ per cent. of phosphoric acid should be here mentioned. The oil can be painted on young cocoanut and other trees to protect them against insect pests. In districts where *nim* trees are plentiful the crushing of the *nim* seed for oil and oil-cake may be taken up as a secondary mill industry in connection with a cotton-ginning and cotton-seed-crushing establishments, for instance. Dried *nim* leaves are often used for storing grains safe from *weevils*.

The *kenja* oil and *siálkántá* oil, as lamp-oils, need be only mentioned here as being actually in use. In Orissa the cultivator who possesses twenty Galedupa (*Kenja*) trees considers himself quite independent in the matter of lamp-oil. *Siálkántá* oil is used chiefly among the Sonthals of Rajmehal. Punang seed which is globular and large (about an inch in diameter) contains a large proportion of oil which is used by Uriyas and also in Western India, for burning. The seeds of *Schleichera trijuga* or kusum contains a valuable oil which is used for making Macassar oils and for soap-making. *Chironji* seed which is full of a rich oil is used for making sweetmeats but not for extraction of oil.

**Drying and non-Drying Oils.**—The principal drying oils are obtained from the following plants :—

|   |    |    |           |
|---|----|----|-----------|
| <i>Juglans regia</i> (walnut, <i>ákrót</i> ) which yields                 | .. | 50 | % of oil. |
| <i>Carthamus tinctorius</i> (safflower, <i>kusum</i> ) which yields about | .. | 25 | „         |
| <i>Guizotia abyssinica</i> (niger seed, <i>sorguja</i> )                  | .. | 23 | „ to 27%  |
| <i>Linum usitatissimum</i> (linseed, <i>masiná</i> )                      | .. | 28 | „         |
| <i>Papaver somniferum</i> (poppy, <i>postádáná</i> )                      | .. | 33 | „ to 47 „ |
| <i>Amoora rohituka</i> ( <i>pittaraj</i> ).                               |    |    |           |
| <i>Argemone mexicana</i> (Mexican prickly poppy, <i>Shiálkántá</i> ).     |    |    |           |

The principal non-drying oils are obtained from the following plants :—

|   |    |    |    |                   |
|---|----|----|----|-------------------|
| <i>Brassica juncea</i> ( <i>rái</i> )             | .. | .. | .. | 21 to 28 % of oil |
| <i>Brassica napus</i> ( <i>lutni</i> )            | .. | .. | .. | 32 to 40 „ „      |
| <i>Brassica campestris</i> ( <i>var. sarson</i> ) | .. | .. | .. | 33 „ „            |
| <i>Brassica campestris</i> ( <i>var. toria</i> )  | .. | .. | .. | 33 „ „            |
| <i>Ricinus communis</i>                           | .. | .. | .. | 47 „ „            |
| <i>Cocos nucifera</i> ( <i>cocoanut</i> )         | .. | .. | .. | 52 to 57 „ „      |
| <i>Sesamum indicum</i> ( <i>tíl</i> )             | .. | .. | .. | 45 „ „            |
| <i>Eruca sativa</i> ( <i>tárámáni</i> )           | .. | .. | .. | 12 to 25 „ „      |
| <i>Bassia latifolia</i> ( <i>mahua</i> )          | .. | .. | .. | 27 to 37 „ „      |
| <i>Helianthus annuus</i>                          | .. | .. | .. | 27 „ „            |

The commonest drying oil used for paints and varnishes is linseed-oil. Boiled linseed oil dries up quicker and helps the paint to stick faster to the substance painted, hence about one-fourth of the boiled oil is added to three-fourths of the unboiled oil when it is used for paint and varnish.

## CHAPTER XXXV.

### MUSTARD AND RAPE.

[Botanical classification; mustard, colza, rape, *ulti sarson*, four-rowed *sarson*, Kalimpong mustard, China cabbage, the black and white mustards of Europe : Distinguishing features of mustard or *Rái*, *Tori* or rape and *Sarson* or colza ; Chittagong mustard, Nepalese mustard ; *Eruca sativa* ; cultivation ; acreage.]

**Botanical classification.**—The Bengal mustards have been studied closely by Dr. Prain, and according to him there are three distinct types of mustard, which may be distinguished thus :—

1ST.—Indian Mustard or *Rái*, the *Sinapis ramosa* of Roxburgh and *Brassica juncea* of Hooker and Thomson.

2ND.—Indian Colza or *Sarson*, the *swét-rái* of Central Bengal, very tall, grown all over Bengal except Chittagong, plants resembling turnip or swede, the *Sinapis glauca* of Roxburgh, and *Brassica campestris*, sub-species *genuina*, variety *glauca* of Hooker and Thomson.

3RD.—Indian Rape or *Tori*, the *Sorshé* of Central Bengal, the *Sinapis dichotoma* of Roxburgh, and *Brassica campestris*, sub-species *napus*, variety *dichotoma* of Hooker and Thomson.

Besides these staple varieties, there are some others also cultivated in some parts of Bengal, *e.g.* (1) *Brassica trilocularis* (*Ulti Sarson*), which is unlike ordinary *Sarson* only in having pendent pods ; (2) *Brassica quadrivalvis* which is a variety of *Sarson* which has four rows of seed instead of two ; (3) *Brassica rugosa*, Prain, or the Kalimpong *rái* ; (4) *Brassica rugosa*, *var. Cuneifolia*, Prain, grown by Cacharis and Rajbansis throughout Upper Bengal and Assam ; (5) *Brassica Chinensis* or China Cabbage may be also regarded as a mustard. Indeed Turnip, Cabbage and Cauliflower

are botanically closely allied to mustard, all of which are included under the genus *Brassica* of Linnæus.

The black and white mustards (*Brassica nigra* and *alba*) of Europe are not grown in Bengal. It is from these that the mustard of European condiment and hospital poultices are obtained. The oil of these mustards, though very useful medicinally as a very strong antiseptic, is not so suitable for food as the oil of Indian mustards, though the meal of European mustards is a better condiment.

**Rai.**—First, Rai, Láhi, Li, or Ráichi-rai is grown in all the Divisions of Bengal and Bihar, except Chhota Nagpur, where it is practically unknown, except in Singhbhum. It is easily recognised by having none of its leaves stem-clasping, and after reaping, its seeds, which are brown, can be readily distinguished from those of *Tori* or Indian rape, by their small size, and their being distinctly reddish brown all over. From *Sarson* which has white seeds, or, as occasionally happens, brown seeds, it is easily distinguished. *Sarson* seeds are always considerably, often very much, larger, and even when brown, have the seed-coat smooth. There are three sub-races of *Rái*, a tall late kind and two shorter earlier kinds, one of these latter roughing with bristly hairs, the other smooth with darker coloured stems. The taller sub-race is quite absent from Chhota Nagpur and from Tippera and Chittagong. The shorter sub-races are quite absent from Orissa and are absent from North Bengal and Bihar. *Rái* or *Rái-shorshé* is called *chhota-sarisha* in Orissa, because the seeds are small.

**Tori.**—Second, *Tori*, Lutni (Chhota Nagpur) and *Sarisha* or *shorshe* (Indian rape) is next in importance to *Rái*, and it is grown in every district in Bengal and Bihar except perhaps Saran and Shahabad. It is easily distinguished from *Rái* by its stem-clasping leaves and its small size. When reaped the seed is recognized as being larger, though of the same colour, and by having a paler spot at the base of the seed; the seed-coat too is only slightly rough. From *Sarson* or Indian Colza it is easily distinguished by its smaller size and by its leaves, though stem-clasping, as in *Sarson*, being less lobed and having much less bloom. The seeds of *Tori* and ordinary *Sarson* are much of the same size, but as a rule the seed of *Sarson* in Bengal is white. When *Sarson* seeds are brown they are of an amber colour and they have no paler spot. The seed-coat is smooth. The seeds of *Sarson* are sometimes considerably larger than those of *Tori*. When this is the case the two are easily distinguished. There are two kinds of *Tori*, a taller, rather later, and a shorter, and very early kind which is the commoner variety. Both kinds, however, ripen well ahead of any *Rái* or any *Sarson*. The earlier kind of *Tori* probably does not occur in North-West Bihar and the later kind is unknown in Eastern Bengal and Chittagong; with these exceptions both sorts prevail throughout Bengal and Bihar.

**Sarson.**—Third, Sarson or Indian Colza, the *shwēti shorshē* or simply *shwēti* of Bengal, and (*Ganga-toria*) of Orissa, occur in every distinct of Bengal and Bihar, except Chittagong, where it is replaced by a different mustard. It is easily distinguished from *Rai* by its stem-clasping leaves, and from *Tori* by the greater amount of bloom on its foliage, by its taller stature, its more rigid habit and its thicker and plumper pods. When reaped the seeds are distinguished by their usually white colour; when brown the seeds are distinguished readily from those of *Rai* by the larger size, and the smooth seed-coat, and from those of *Tori* by their being of a lighter brown, and by not having a paler spot at the base of the seed. There are two races of *Sarson*, one with erect pods, the Natwa Sarson or Sarson proper and one with pendent pods or Tero Sarson. Each race has two distinct sub-races, one with 2-valved and the other with 3- to 4-valved pods. The forms with hanging pods are not common except in Northern Bengal and Eastern Tirhut (Purnea), the sub-race with 2-valved pods being almost confined to this area. But the 4-valved kind extends sparingly throughout Western Tirhut and crossing the Ganges spreads southwards through South-West Bihar and Western Chhota Nagpur. The forms with erect pods occur all over Bengal; the 2-valved sub-race, however, is not much grown in Bihar. The 4-valved sub-race occupies West Tirhut and West Bihar and extends in a south-west direction to Midnapore. It is also grown in Northern and North-Eastern Bengal. Roughly speaking, the 2-valved erect Sarson is grown chiefly in Chhota Nagpur, Orissa, and in West Central and East Bengal; the 4-valved erect Sarson is grown chiefly in West Bihar and North Bengal; and the pendent Sarson occurs in the area to the north of the Ganges beyond the region occupied by the 4-valved Sarson.

Fourth, the Chittagong mustard, which is closely allied to European colza.

Fifth, the Nepalese mustard, which is the same as the Cabbage-mustard of the Chinese cultivator.

Sixth, the China cabbage, which is quite distinct from the last, has been only lately introduced into Bengal jails.

Seventh, *Eruca sativa* or *Taramani* (*Tiramira*) is commonly confounded with mustard. It also belongs to the natural order, *Cruciferae* and *tribe Brassicæ*. The seeds are compressed and light reddish brown in colour.

**Cultivation.**—*Tori* or *Sorshē* and *Sarson* or *Swet sorshē* are usually sown with wheat or barley, or in gardens with carrots and *Ramdana* (*Amaranthus paniculatus*), while *Rai* is usually grown by itself, as it is a tall crop, which has the tendency to smother other crops grown with it. Mustards are sown in September, *i.e.*, six weeks to two months before the regular *rabi* sowings. The sowing of *rāi* is done earlier, and it is harvested in February or March, while *sarson* and *tori* are sown\* and harvested later. There are,



however early and late varieties of all three crops. It should be, however, borne in mind that all sorts of mustard crops are very much subject to the attack of aphides, and a crop which is late is always badly infected if there is an earlier crop in the neighbourhood. Mustard should therefore be all sown at the same time and not in different lots, and very early in the season. When tori or sarson is sown with wheat or barley at the rate of  $1\frac{1}{2}$  lbs. per acre, the produce is only  $1\frac{1}{2}$  to 2 maunds per acre. Sown by itself, at the rate of 4 to 6 lbs. per acre, the produce is 4 to 6 maunds. Rái is usually sown at 3 lbs. per acre and peas are sown afterwards on the same land. Grown in this way the outturn per acre of rái is 3 to 4 maunds. Grown by itself, without peas, scarcely any higher yield is obtained. Rái with peas sown in the same field afterwards is therefore a splendid mixture, specially as the pea using the tall stems of ráias support, bear more pods and give a better yield than when it is sown by itself. Rái seed yields less oil than sorshé and shwéti-sorshé seeds. In the former case the yield is ten seers per maund and in the latter 13 to 14 seers. All the three varieties of mustard are sometimes grown as a green manure and sometimes for green fodder only, the plants being cut and given to cattle in January and February, *i.e.*, when they are just in flower. Sometimes a crop of mustard is ploughed in as manure, but this form of green manuring has not the special merit as the ploughing in of *dhaincha*, sunn-hemp, indigo, or *barbati*.

**Acreage.**—Rape and mustard occupy about  $3\frac{1}{2}$  million acres of land in British India, Bengal including Assam accounting for two million acres. In Bengal it is the most important oil-seed-crop, though in the rest of the country *tíl* occupies the first place.

## CHAPTER XXXVI.

### LINSEED (LINUM USITATISSIMUM).

[Flax for fibre and seed ; Acreage ; Cultivation ; Linseed-cake.]

**History.**—This plant has been discovered in the wild state in the region between the Black and Caspian Seas and the Persian Gulf, the original home of the Aryan race. It is one of the most ancient fibre plants of India, being mentioned in Panini thus :—“*Atasi syat-uma-kshuma.*” Whether the “*Kshouma-bashan*” of the Vedas is silk cloth or linen cloth is doubtful. Probably the word *kshuma* was applied first to silk and afterwards to linen, as “*kshaume bashane bashanam agnimadihyatam*” has always been understood in practice with reference to silken wedding robes. What is most ancient survives in the most ancient religious customs. Besides it is not at all certain that linen cloth was ever made in India. Flax is grown not for its fibre but for its seed in India, and though the knowledge that linen fibre was obtained from the flax plant existed in ancient India, the use of silken cloth has been

prescribed for religious observances among all classes of Hindus. The growing of flax for fibre instead of seed (fibre and seed cannot be both grown to perfection from the same plants) with imported seed and by sowing the seed thick, has been tried with success in Tirhut and elsewhere, and reports of these will be found in the Bulletins of the Pusa Institute. The growing of white linseed, the oil of which is more valuable than that of the ordinary brown linseed, is another improvement which should not be lost sight of. White linseed grew quite as well as brown linseed at the Sibpur Farm.

**Acreege.**—The total area under linseed in British India is over 3 million acres, of which the area in Bengal and Bihar is estimated at 924,000 acres only, or 1.25 per cent. of the total cultivated area of the province. Darbhanga, Saran, Gaya, Nadia, and Champaran are the most important linseed-growing districts in Bengal. Expansion of cultivation has been chiefly in the districts of Nadia, Gaya and Darbhanga, while in Patna and Mymensingh there has been great contraction of area under linseed of late years.

**Soil.**—Linseed grows well on heavy land, and it is not so suitable for light and sandy soils, which are particularly well adapted for mustard and *til* crops. In fact, linseed can be grown on *Aman* land which is unsuitable for *til* and mustard crops. In rocky sub-Himalayan tracts, however, linseed does very well. Wheat, gram and linseed require the same kind of land. Gram and linseed are usually grown together, gram doing well also on heavy loam, if it is fairly rich in lime. The sowing of linseed should be done early and preparations may commence in September, when the rains are still on, actual sowing being done immediately after or even before the monsoon is over, at the rate of four to six seers per acre. Sowing is sometimes done when the *Aman* rice is still standing. Water logging does not do this crop so much harm in rocky and laterite soils. Thorough and deep cultivation is as beneficial to this crop as to wheat, but seed may be scattered in between the lines of paddy and simply ploughed in. Sown later, linseed needs irrigation, but when the crop is in flower or nearly mature, rainfall does harm.

The plants are cut down when ripe, at the end of February or beginning of March, and the seed extracted by flailing. Six to eight maunds of seeds being the average produce per acre. The straw is useless as fodder, and it is said that green plants of linseed eaten by cattle prove fatal to them.

The seed yields about one-quarter its weight of oil. Linseed-cake is a more valuable cattle food and a more valuable manure, especially for milch cows, than *rai* or *tori* cakes, though the butter produced from milk given by cows eating linseed-cake is softer than that from cows eating mustard or cotton-seed cake. Linseed-cake is more potent in fattening cattle than any other food.

## CHAPTER XXXVII.

## GINGELLY OR TIL (SESAMUM INDICUM).

LIKE white linseed, white *til* yields a more valuable oil than the black variety. White *til* is often grown along with cotton as a *rabi* crop, while black *til* is grown along with a tall crop, such as *juar*, as a *kharif* crop. The high and light alluvial (*Dearh*) lands and rocky soils are suitable for the *til* crop. Indeed, all oil-seed crops prefer soils *rich* in mineral matters, *til* doing better on lighter classes of soils, either rocky or riparian. *Til* occupies the largest area among oil-seed crops in British India, though in Bengal it is a crop of secondary importance. The total area under this crop in Bengal, and Behar including Assam, has been estimated at 430,000 acres, while the area under this crop in all India is over 4½ million acres.

*Til* may be grown on poor soils provided they are not too low or heavy. It does not require such deep preparation of land as linseed does. Eight to ten seers of seed are used per acre when it is grown by itself. Both the varieties of *til* are grown in some districts, the coarser variety called *Bhadoi til* or *kat-til* is sown in January and reaped in June or July, about 6 maunds being obtained per acre. The sowing of this variety of *til* is done in Birbhum on low *Aman* land after a *maghi* shower of rain. The seed needs husking and the oil extracted is rather thin and poor. The *rabi til* is sown in August and reaped in November or December, 4 to 6 maunds being obtained per acre. *Til* is sown in October also like ordinary *rabi* crops as in Orissa and Chhota Nagpur. On *dearh* lands of East Bengal, sowing is done in January and February. The stocks of harvested *til* stalks should be left to dry in a standing position, the seed being afterwards detached by flailing.

If scented flowers are kept in between layers of *til*, the *til* being sifted out next day, and this operation being repeated for a fortnight and the scented *til* afterwards pressed, *phulel* oil is produced which fetches over Rs. 150 per maund, but the demand for this article is limited. The oil-cake is used not only as animal but also as human food mixed with *gur* or sugar. The yield of oil from *til* seed is about 45 per cent. About 25 per cent. of *phulel* oil is obtained from *til* seed treated with flower.

## CHAPTER XXXVIII.

## SORGUJA OR NIGER OIL SEED (GUIZOTIA ABYSSINICA).

THIS crop usually follows *Aus* paddy, and is sown in August, either by itself or with some pulse-crop (*kulthi*, etc). Rough and rocky laterite soil or light sandy soil is chosen for this crop. The preparation of land is of the simplest character. Two ploughings followed by a laddering are all that is done before sowing. About

half a maund of seed is sown per acre. The crop is harvested in November or December, the produce coming to only about 4 maunds valued at Rs. 5 or Rs. 5-8 per maund. A considerable proportion of land is under this crop in Chhota Nagpur.

The yield of oil is about 35 per cent. of the weight of the seed. The oil-cake is highly appreciated for milch-cows in the Deccan. Mr. Mollison speaks highly of this oil-cake as a manure for the sugar cane crop. Mustard and castor oils are adulterated with *sorguja* oil. The relative value of rape seed and *sorguja* seed in the English market is 48s. : 37s. per quarter. While rape seed yields 20 gallons of oil per quarter in England, *sorguja* seed which dries up quicker, yields only 16 gallons per quarter, but a mixture of *sorguja* with rape actually increases the yield of oil of the latter seed. Hence the universal use of *sorguja* seed for mixing with mustard seed before pressing oil out of the latter seed.

For lubricating and for lighting, this oil is useful, and it is used in some parts of India for cooking and for anointing the body.

## CHAPTER XXXIX.

### CASTOR (*RICINUS COMMUNIS*).

[Use for extraction of oil; use for silk rearing; uses of oil; cold-drawing desirable; cake as a manure, as a substance for extraction of gas; yield, cultivation; varieties; different processes of extraction of oil.]

THE value of this crop is of a two-fold nature: (1) the Eri silkworms are reared on its leaf, and (2) the oil extracted from castor-seed is highly valued for lubricating machinery, for dressing tanned hides and skin, for lighting, for soap and candle-making and other arts, and lastly, as a medicine. The large seeded varieties are appreciated for extracting lubricating and lighting oils, while the small seeded varieties, for extracting a fine quality of oil used for medicine. The slowness with which castor-oil burns effects a saving of consumption ranging from a quarter to one half in comparison with other lighting oils, such as kerosine, mustard oil, linseed oil, etc. Being comparatively freer from danger and giving little soot, it is used in railways all over India. The qualities of castor-oil for keeping the head cool and the pores of the skin and roots of the hair soft and open, are availed of in the manufacture of golden-oil, pomatum and perfumed oils of various kinds. Cold-drawn castor-oil gives more brilliant light than castor-oil from boiled or roasted seed. The oil, therefore, extracted from unheated shelled seeds is more valuable. The manufacturing of cold-drawn castor-oil in India offers a great opening for capitalists. Castor-oil agitated with nitric acid is used for lubricating wheels of railway carriages. Castor-cake is one of the best vegetable manures in use. This cake is also used for extracting gas which is actually in use in the Allahabad Railway station for lighting purposes.

Several of the Indian railways have their own castor-oil mills and they use the oil and cake both for lighting. Castor-oil is also in use for extraction of gas for lighting the streets of Jeypore. As a manure, castor-cake and bone-meal together have been found better for sugarcane than the cake alone, while for rice and potatoes castor-cake alone has given the best results in India. Castor-cake is considered injurious to the *pan* plant, the manure used in *pan barojas* being mustard-cake. It is a common mistake to suppose that castor-cake is richer in phosphates than linseed or rape-seed cakes. Poppy-seed cake is the richest in phosphates and castor-cake is not any richer than rape or linseed-cake in this respect.

It is very curious that while castor-oil plant leaves eaten by milch cows to help increase the flow of milk, a pulp made out of castor leaves is used externally by women to stop the flow of milk from their breasts. Sometimes whole leaves are applied to the breasts for this purpose. The dried stalks are used for thatch and as wattle and also as fuel. The stalks are not attacked by white-ants.

The *yield* of oil is about 25% to 36% of the weight of seed, and of cake from 36% to 44%, the rest being husk, etc., which has to be got rid of before the oil is extracted.

The *cultivation* of castor-oil plant, so far as Bengal and Bihar are concerned, is done chiefly in the Patna and Bhagalpur Divisions, where it is usually grown along with potatoes. In other parts of Bengal also it is grown more or less abundantly with cotton, or *juar*, or *araha*r. A small sized, a middle sized and a large sized variety, are recognised. The first and the last are sown from May to July and grown with some *bhadoi* crop. The seeds ripen in January and February. The winter variety is sown in September and the seeds are gathered in March or April. This variety yields a larger proportion of oil than the *bhadoi* varieties. On *dearh* land the cost of cultivation is little and the yield is large. Like other oil-seed crops, the castor-crop is benefited by mineral manures, and the annual renovation of soil by silt is an appropriate substitute for manure. Red soils situated at the foot of hills are also specially chosen for growing castor-oil plants. Such soils if very poor in organic matter, get an application of 20 to 30 cart-loads of dung (7 or 8 tons) per acre, or flocks of sheep are hurdled on them. Two or three ploughings are then given at the commencement of the rainy season and the seed sown by dibbling six feet apart, about 6lbs. of seed being used per acre for the larger variety. In each hole 2 seeds are put and if the soil is too dry at the time, water is put in each hole before it is covered up. The smaller variety is planted 18 in. by 36 in. apart, 4lbs. of seed being used. Castor is an exhausting crop, and it should not be grown on the same land oftener than once in five or six years. It is never irrigated, which is a great advantage, all the operation necessary after sowing being ploughing the land a month after sowing in between the rows of seedlings, to keep it free from weeds.

Castor plantations being very much subject to the attack of caterpillars, preparation of land in the cold weather is necessary that grubs may be exposed to the attack of birds and ants, also stirring of the soil once a month until sowing time. The seed should also be pickled with an insecticidal mixture before sowing.

The *picking of capsules* continues from the seventh to the ninth month after sowing, after which the remaining leaves are given to cattle and the stems cut and used for fuel, or for making charcoal which is used in the preparation of fireworks. The seed-pods are stacked in a corner of a house, covered with straw and weighted. After a week the capsules are found soft and rotten. They are then exposed to the sun for two days, dried and beaten with heavy mallets 2ft. long by 1½ft. broad, which process extracts about half the seed. The remaining capsules are again dried and beaten, until all the seeds have been extracted.

A small seeded Deccan variety goes on bearing for five years in succession. The quality of oil of this variety is also superior.

When castor is grown with other crops, the *yield* of cleaned seed per acre is about 250lbs., while grown by itself, the yield comes to 500 to 900lbs. per acre. The cost of cultivation being very little (about Rs. 10 per acre), it is a profitable crop to grow.

There are four processes of extraction of oil which can be followed without much difficulty :—

(1) The shelled seed may be crushed in a screw-press with horizontal rollers and the resulting pulp put into *ghanies* and pressed. This cold-drawn castor-oil can be obtained at as high a proportion as 36 per cent. of the shelled seed. 37 per cent. of cake and 27 per cent. of husk being also obtained.

(2) The seed may be roasted in a pot, pounded in a mortar and placed in four times its volume of water, which is kept boiling. The mixture is constantly stirred with a wooden spoon. After a time the pot is removed from the fire and the oil skimmed off. The residue is then allowed to cool, and next day it is again boiled and skimmed. The second day's skimming gives better oil which is kept separate. If the beans are over-roasted a smaller proportion of oil is obtained. The proportions of oil to cake, etc., obtained by this method are 30½ per cent. of oil : 43½ per cent. of cake : 26 per cent. of husk-wastage.

(3) The seed may be first boiled and then dried in the sun for two or three days, then pounded in a mortar, placed in four times its volume of water which is kept boiling, while the mixture is stirred with a wooden spoon as before. The skimming of the oil takes place as in process No. 2. The oil thus obtained is a superior lamp-oil to that obtained by process No. 2, though it is inferior to that obtained by process No. 1.

(4) The seed may be soaked for a night in water, and next morning ground up in an ordinary *ghani*. The oil is removed gradually by putting a piece of cloth into the pulp and squeezing the oil out of the cloth into a pot. This oil is also a better lamp oil

than that obtained by roasting the beans. This process gives the best oil-cake.

That cold-drawing with proper machinery gives a larger yield ought to encourage capitalists to adopt this method of extraction more and more. After the cold-drawn oil has been obtained by pressing the kernels in gunny bags, it is put in galvanized iron vats and bleached by exposure to the sun, which also causes the sediment to precipitate. The oil is then filtered through vegetable charcoal and flannel bags. In the Rajshahi Jail, fire is put underneath the machine when the kernels are pressed in canvas bags. This increases the yield of oil by 10 per cent., but some of the irritating and noxious properties of the seed go into the oil, which make it unsuitable for medicinal purposes. But cold-drawn medicinal oil is also made in this jail. The processes adopted in jails are :--

- (1) Cleaning and grading of the seed with hand.
- (2) Splitting of the seed with mallets or with a machine, consisting of two iron rollers, set parallel to each other and at adjustable distance.
- (3) Sunning the seed and winnowing with *kulo* or *sup*, so as to separate the kernel from the husk on a wide masonry platform.
- (4) Crushing the kernels with *dhenki* or with another roller machine.
- (5) Putting the pulp into canvas bags 15" × 12" and pressing it in screw presses in between plates of iron, about 150 bags being put in at each feed of the press.
- (6) Boiling (40 parts of oil with 5 to 8 parts of water) in copper pans; great experience is needed for this operation.
- (7) Straining through a bed of charcoal and 8 folds of calico.

The growing of castor in plantations for the purpose of rearing Eri silkworms on a large scale cannot be recommended. Eri silk-rearing, to be profitable, must be carried on as a domestic industry by the poor. Poor delicate women who have no other avocation in particular can profitably employ their time in rearing a few thousand silkworms indoors on *dalas*, picking leaves from near the immediate vicinity of their homesteads, utilising the cocoons for spinning thread with wheel or *takur* (spindle), and weaving a coarse but substantial cloth out of it. Two or three pieces of *chadder* cloth woven annually by a woman would bring her a gross outturn of Rs. 36, with no outgoings whatever. This in some districts would be considered a profitable industry for women.

## CHAPTER XL.

GROUND-NUT (*ARACHIS HYPOGÆA*).

THIS is a native of America, introduced into India probably through China about seventy years ago. It grows best on dry, sandy soil, and it is cultivated chiefly in the light soils of the Madras Presidency, but in increasing amount over many parts of Peninsular India and in Burma. The seed can be put down either in February or in May or June, or in September and October, or, in fact at any time except during the two rainy months. Sown in May or June the crop can be lifted in November and December, and sown in September or October, the crop can be lifted in March or April. In heavy clay soils, the cost of lifting the crop is not covered by the value of nuts obtained, and so many nuts remain behind undiscovered in the unbroken clods, that the plant comes up always afterwards like a weed. In such soils flooding may be done before lifting which makes digging easier. In light soils the yield is larger and the cost of cultivation less. In heavy soils it can however, be grown as a fodder crop only, and in this case it is of high value for milch cows. It does not require irrigation (unless sowing is



FIG. 64.—GROUND-NUT PLANT, SHOWING ROOT-NODULES, AND FULL-GROWN FRUITS.

done at a dry season) and it grows without any trouble. It has the great advantage of enriching lands, specially sandy lands. The roots are full of nodules like the roots of *arahaar*, *dhaincha* and *sunh-hemp*. The nut of the ground-nut plant is shown in full size



in the figure. Grown year after year in tracts near Pondicherry the crop has degenerated and has become subject to diseases. It is necessary to observe the principle of rotation in dealing with this crop as with other crops. A judicious system of manuring with ashes and lime is also a desideratum. That the crop seems to stand a good deal of neglect and does equally well at first with or without manure, are facts which have the tendency of throwing cultivators off their guard, as after taking several crops successfully out of the same land, they are surprised that the crop should show a tendency to deteriorate all of a sudden. This is the case now with the ground-nut cultivation of the Madras Presidency which is threatened with ruin. The demand for ground-nut and ground-nut-oil is very great, especially in France, and light soils in Bengal may be chosen for growing this crop in a judicious manner, that the demand may be met from Bengal *pari passu* with the failure of supply from Madras. Half a maund of seed may be sown per acre at a distance of nine inches either way. The outturn may come to forty maunds per acre. Many types of foreign seed from Spain, Japan and America have been tried with success, particularly in Western India and in Burma, and consequently the area under the crop in these regions has rapidly increased.

The oil burns slowly, but it does not give a brilliant light. It is almost as good as olive oil, and is largely used even for medicinal purposes as a substitute for olive oil. It does not get rancid so quickly as other oils do. It is largely used for adulterating cocoa-nut and other oils. In Europe it is extensively employed for soap-making, for dressing cloth, and for lubricating machinery. The yield of oil is about forty per cent. It is unfortunate that the export should be chiefly in the form of nuts and not in the form of oil only, as the cake would be of great benefit to the country as a food and as manure for the soil.

The ground-nut oil-cake fattens cattle very rapidly. Indeed it has been recommended as a highly nutritious and agreeable human food in a cooked condition. The cake is actually richer than peas and lentils in flesh-forming matter, while it contains more fat and phosphoric acid than pulses. The percentage composition of the cake is given below :—

|                    |    |    |    |    |      |
|--------------------|----|----|----|----|------|
| Moisture           | .. | .. | .. | .. | 9.6  |
| Fat                | .. | .. | .. | .. | 11.8 |
| Nitrogenous matter | .. | .. | .. | .. | 31.9 |
| Sugar and starch   | .. | .. | .. | .. | 37.8 |
| Fibre              | .. | .. | .. | .. | 4.3  |
| Ash                | .. | .. | .. | .. | 4.6  |

## CHAPTER XLI.

COCOANUT (*Cocos nucifera*).

ALTHOUGH in the ordinary sense cocoanut cannot be regarded as a crop, yet cocoanut-oil is so extensively used in India, and so largely exported, that it should find a place in our description of the oil-seed crops. The area under cocoanut in India has been estimated at 480,000 acres. The tree is put to such varied uses that it can be regarded as much in the light of an oil-crop, as in that of timber, fibre, fuel, vegetable, fruit or miscellaneous crop. A vinegar is made of the juice of this palm, also toddy, punch and liqueur. *Gur* and sugar are also made out of the juice. Soap and candles made out of cocoanut oil has a larger percentage of water than any other soap and candles. Being soluble in saline or hard water, it is used in the manufacture of marine soap, but the smell being offensive, it is not used in the manufacture of high class toilet soaps. One to two million gallons of cocoanut oil is exported annually, chiefly to England.

The sliced kernel, dried in the sun, or artificially dried, contains from 30 to 50 per cent. of oil. The country methods of extraction of oil fall under two heads : (1) Dry expression : (2) Extraction by boiling.

(1) Half a cwt. of dried kernel is a charge for a full-sized *ghani* and a pair of stout bullocks will get through four charges a day, so that 20 *ghanis* are required to get through two tons of kernels in 24 hours. The man who drives has a boy to assist him in taking oil, which is got out of the mortar by dipping a piece of rag into the fluid and squeezing it out into an earthen vessel, but if the bullocks are trained the boy can be dispensed with.

(2) The second process consists in boiling the kernels with an equal quantity of water, then grating and squeezing in a press. The emulsion thus obtained is again boiled until the oil is found to rise to the surface. Fifteen to twenty nuts yield two quarts of oil treated in either way.

The first method is the one commonly employed.

The merits of coir as a rope-fibre, possessing elasticity and lightness and a high power of resistance to the action of water are now recognised all over the world. About ten million pounds of coir and coir-made rope are now exported annually from India. Fifty cocoanuts yield about 6lbs. of coir. About six lakhs of rupees worth of *nuts* are also exported annually from India.

An acre planted with 200 cocoanut palms (about 15ft. apart) would yield in coir alone 2 to 2½ annas per tree or nearly Rs. 30 for the 200 trees. The average yield of fruits may be put down at eight annas per tree or R. 100 per acre. But the plantation to yield so much must be situated within 100 miles of the sea-coast, that the sea-breeze may bring enough of salt into the soil to keep up its vigour for this crop. At the time of planting also, half a

seer of *khari nimak* (crude salt) should be used per plant. The seed-cocoanuts used should, if possible, be imported from Ceylon or Madras. In Madras, coconut plantations are kept regularly irrigated.

The coconut flowers in about five years after planting, in the hot weather. The nuts are ripe and ready for plucking in ten months after flowering. Nuts allowed to remain too long on trees, the fibre gets coarse and brittle. The fibre of green nuts is lighter and finer, but there is less quantity and it is weaker. The removal of the fibre from the shell is effected by forcing the nut upon a pointed implement struck into the ground. With this arrangement, one man can clean 1,000 nuts a day. The fibrous husks are next submitted to a soaking, which is variously conducted. In some places they are placed in pits of salt or brackish water for 6 to 18 months (fresh water spoiling the fibre). If steam is admitted into the steeping vat to warm the water, the operation is rendered shorter and the fibre is also softened and improved. The further separation of the fibre from the husk is largely effected by the hand. After thorough soaking the husks are beaten with heavy wooden mallets and then rubbed between the hands, until all the interstitial cellular substances are separated from the fibrous portion. When quite clean, it is arranged into a loose roping preparatory to being twisted, which is done between the palms of the hands in such a way as to produce a yarn of two strands at once.

*Analysis of coconut.*

|   | Husk.      | Shell. | Kernel. | Milk.  |         |
|---|------------|--------|---------|--------|---------|
| Total weight per cent.  | .. 57.28   | 11.59  | 18.54   |        | 12.58   |
| Moisture  | .. 65.56   | 15.20  | 52.80   | nearly | 100     |
| Dry matter  | .. 34.44   | 84.80  | 47.20   | Trace  |         |
| Nitrogen  | .. 0.137   | 0.100  | 0.504   | "      |         |
| Pure ash  | .. 1.63    | 0.29   | 0.79    |        | 0.38    |
| Including—  |            |        |         |        |         |
| Silica (SiO <sub>2</sub> )  | .. 1.22    | 4.64   | 1.31    |        | 2.95    |
| Oxide of iron and alumina<br>(Fe <sub>2</sub> O <sub>3</sub> and Al <sub>2</sub> O <sub>3</sub> ) | .. 0.54    | 1.59   | 0.59    | Trace  |         |
| Lime (CaO)  | .. 4.14    | 6.26   | 3.10    |        | 7.43    |
| Magnesia (MgO)  | .. 2.19    | 1.32   | 1.98    |        | 3.97    |
| Potash (K <sub>2</sub> O)   | .. 30.71   | 45.01  | 45.84   |        | 8.62    |
| Soda (Na <sub>2</sub> O)  | .. 3.19    | 15.42  | ..      |        | ..      |
| Potassium chloride (KCl)  | .. ..      | ..     | 13.04   |        | 41.09   |
| Sodium chloride (NaCl)  | .. 45.95   | 15.56  | 5.01    |        | 26.32   |
| Phosphoric acid (P <sub>2</sub> O <sub>5</sub> )  | .. 1.92    | 4.64   | 20.33   |        | 5.68    |
| Sulphuric acid (SO <sub>3</sub> )   | .. 3.13    | 5.75   | 8.79    |        | 3.94    |
| 1,000 nuts removed<br>from the soil.  | Husk.      | Shell. | Kernel. | Milk.  | Total.  |
|   | lbs.       | lbs.   | lbs.    | lbs.   | lbs.    |
| Nitrogen  | .. 3.7017  | 0.5460 | 4.4100  | Trace  | 8.6577  |
| Phosphoric acid   | .. 0.8456  | 0.0735 | 1.4053  | 0.1279 | 2.4523  |
| Potash  | .. 13.5255 | 0.7127 | 3.7362  | 0.7783 | 18.7527 |
| Lime  | .. 1.8234  | 0.0991 | 0.2143  | 0.1674 | 2.3042  |
| Sodium chloride   | .. 20.2375 | 0.2464 | 0.3563  | 0.5431 | 21.4235 |

## CHAPTER XLII.

MAHUA (*BASSIA LATIFOLIA*, etc.).

As a sugar and fat yielding tree, the '*Bassia butyracea*' is of greater value than the common *Bassia* or *mahua* tree. This tree which is also called the Indian Butter tree grows in the Sub-Himalayan tract between Kumaon and Bhutan at 1,000 to 5,000 ft. above the level of the sea. The pulp of the fruit and even the cake left after the expression of oil are eaten by men. The flowers are not eaten like the flowers of the ordinary *mahua* tree but from them a syrup is prepared which is boiled down into sugar. It is equal, if not superior, to ordinary date-sugar. The *gur* having small grain fetches a smaller price. The oil is used as a substitute for *ghi* and is largely employed for adulterating *ghi*. It burns with a bright light without smoke or smell, and it makes excellent soap and candles. This tree has not been taken such notice of, as it deserves. The oil is extracted in the following way. The seed is beaten to pulp and put in bags and subjected to pressure until all the fat is expressed. About 35 per cent of fat is obtained out of the seed. It is largely used, mixed up with *attar* as a hair-oil by up-country people, who call the fat *phulwa*.

The common *mahua* tree which is found abundantly in the dry and stony regions of Bengal and, in fact, over the greater part of Central India, is highly appreciated by the poorer people for its edible flowers, which drop in abundance in March and April. The fruit from which an edible oil is extracted ripen three months after the shedding of the flowers. In famine times the *mahua* tree is regarded as a life-saving tree. The timber of the *mahua* tree is also of considerable value, and in dry and arid regions in the plains where ordinary agricultural pursuits prove difficult, the propagation of this tree should be encouraged as much as possible. The dried flowers being steeped in water and allowed to ferment, yield a spirit by distillation which is largely consumed by aboriginal tribes and others. Over six gallons of proof spirit can be produced from 1 cwt. of *mahua*. Each tree yields five to eight maunds of fresh flowers, which give about one maund of dry food. The dry flowers are an excellent fattening food for cattle. They keep very long and they seem to resist the attack of weevils.

The *mahua* oil is extracted from the kernel of the fruit. The kernels are taken out from the smooth-chestnut, coloured pericard by being bruised, rubbed and subjected to moderate pressure. They are then ground and the oil obtained by expression. In the Central Provinces, the kernels are pounded and boiled and then wrapped up in two or three folds of cloth and the oil thereafter expressed. In the western tracts of Bengal and in the Central Provinces, the oil is largely used for lighting and as a substitute for *ghi*. It is of equal value with cocoanut oil for soap-making and has been valued at £35 per ton in London.

## CHAPTER XLIII.

SAFFLOWER (*CARTHAMUS TINCTORIUS*).

THIS crop was formerly grown both as a dye-crop and as an oil seed crop; now it is exclusively produced for the sake of the oily seed. In the Central Provinces, safflower oil, though it is slightly bitter, is in common use for culinary and other purposes, and it is sold at about 200 tolas per rupee like any other ordinary oil. Formerly it was chiefly for its red dye that it was cultivated all over India, as well as in Spain, Southern Germany, Italy, Hungary, Persia, China, Egypt, South America, and Southern Russia. It is found in a wild state in the Punjab and elsewhere, the seeds of the wild safflower being much smaller than those of the cultivated kind. Safflower dye being fugitive, and aniline colours gradually replacing it, the cultivation of this crop as a dye has almost entirely died out.

It is usually sown along with some other *rabi* crop, such as gram, wheat, barley, tobacco, chillies, opium, or carrots, from the middle of October to the end of November. In Chittagong sowing is done as late as January. Low *chur* land is preferred for this crop. It is an exhausting crop and grown for three years in succession on the same soil: it is known to yield very poor crops. In Jessore the crop is grown both on lowlands and on highlands, and it is found that the crop on highlands comes on earlier. It requires a light, well-ploughed, sandy soil, with a fair amount of moisture, and on highlands it does not succeed, unless there are three or four showers of rain or as many irrigations during the early stage of the plant. It is, therefore, usually grown as a subsidiary crop along with others that require irrigation and weeding. Rain is very injurious to the crop after the flowers have formed, as the dye is washed out by rain. The central bud is usually nipped off to encourage side-shoots and the growth of a larger number of flower heads. The flowers or rather florets are picked every second or third day, in January and February. They must be picked when they begin to get brightly coloured. Delay causes weakening of the dye. The picking of the flowers in favourable seasons may go on through March and even up to May. As fertilisation usually takes place before the picking, the removal of the florets from the heads does not interfere with the subsequent formation of seed which is gathered afterwards for oil. The price of the dry florets varies from Rs. 20 to 30 per maund. The average yield of dry flowers is about 80lbs. per acre, and of seed 400lbs., 16lbs. of seed being broadcasted per acre when it is sown by itself. There is also a thorny variety grown for oil, which is especially adapted for growing round fields as a protection against cattle. The spineless variety is preferred for flowers.

**Dye.**—The florets are dried in shade (as exposure to sun weakens the dye) and sold afterwards; or sometimes the dry florets

are powdered and sifted. The first and the last pickings give inferior dye. The pickings in the middle of the season give the best result. The dry florets contain two yellow dyes and a red dye, the latter being sought for in preference to the former. The yellow dye have to be first extracted. One of them is highly soluble in water, and if the florets are kept in a basket and if clean river water slightly acidulated, (as alkaline water washes out the red dye) be poured on them, yellow dye will be found coming out. Trampling or kneading is continued at intervals while the yellow dye is being washed out, the operation taking three or four days, the mass being allowed to get dry between the washings. To ascertain if all the yellow colour has been removed, a small quantity of the stuff is thrown into a glass of clean water and it is seen if any yellow colour comes out. The pulpy mass is now squeezed between the hands into small, flat, round cakes, which when dry are sold in the market or exported as "stripped safflower."

The quality of this safflower cake is estimated by dyeing a known weight of cotton. Four ounces of safflower will dye 1 lb. of cotton cloth light pink; 8 ozs. will dye it rose pink; 12 ozs. to 1 lb. will dye it full crimson. The cotton must be dyed several times in fresh solutions that it may take up the whole of the dye. The red dye of safflower is Carthamin or Carthamic Acid ( $C_{14}H_{16}O_7$ ). Cold water or oil removes only one of the two yellow dyes in safflower which form 26 to 36 per cent. of the weight of the dry florets, while there is only .3 to .6 per cent. of Carthamin. The second yellow dye is removed in this way:—Acidulate with acetic acid the "stripped safflower," filter, add acetate of lead and then ammonia to the filtrate, and the second yellow colour will be precipitated along with the lead salt. To extract Carthamin in a pure state, take carbonate of soda (washing soda) 15 per cent. of the weight of florets, after both the yellow dyes have been got rid of; digest the florets in the alkaline solution; filter and then precipitate the dye (which is insoluble in acids) by addition of an acid. In India, pearl-ash from *bajra* or *saji* is used for obtaining the red dye.

**Oil.** The dry husk of the seeds is removed by pounding in the *dhenki*. The oil is expressed in a *ghani*. One maund of seed yields 7 seers of oil, 14 seers of oil-cake and 19 seers of husk. The oil-cake is considered a very good manure for sugarcane, etc.

**Other economic uses.**—It is due to Dr. Watt that a most valuable property of safflower-oil has been only recently brought to light. Boiled slowly for four hours the oil becomes one of the best waterproofing materials known. It can be mixed with black oxide of manganese, or white lead, or yellow ochre, and the boiled oil so dyed applied with a brush on canvas or drill, or any other cloth to convert it into paulin or waterproof cloth. The boiled oil poured into cold water becomes a rubber-like substance, which can be used as a cement for sealing glass or

fixing ornamental stones or tiles on walls. For this purpose it is a much better substance to use than plaster of Paris. It is this rubber-like substance that is applied on ornamental cloths made in the Punjab, to preserve the ornamentations intact. A small proportion (say 1 : 400) of arsenic should be used if the rubber-like substance is meant to keep out the attack of insects permanently.

## CHAPTER XLIV.

### JUTE (*CORCHORUS CAPSULARIS* AND *OLITORIUS*).

[Botanical classification; economic uses; history of the jute industry, area; main classes of jute grown; trade classification; early cultivation in East Bengal, climate and soil suitable; sowing of seed, preparation; harvesting; steeping; washing; cost; chemistry of jute fibre; improvements suggested.]

*Botanical classification.*—The four common varieties of jute all of which may be found in a wild state in India even in localities where jute is not cultivated (e.g., in the district of Pertabgarh in Oudh, if one looks for the plants there in October) are the *Corchorus olitorius* (the long cylindrical podded and black-seeded variety), the *Corchorus capsularis* (the round capsuled and brown-seeded variety), the *Corchorus acutangulus* (the short and winged podded variety), and *Corchorus antichorus*, the *bil-nalita*, which is wild and never cultivated. The third variety is also rarely cultivated. The first which is more common in Southern Bengal, may be designated *Deshi pit*; the second which is more common in Northern and Eastern Bengal may be designated *Serajgunj pit*.

*Uses.*—The young leaves specially of *Corchorus capsularis* are eaten as a pot-herb; and the dry leaves, specially of the *Deshi pit* (*Corchorus olitorius*), as an alterative and febrifuge medicine (*nalita*). The stems, after the removal of the fibre are sometimes used for making gunpowder charcoal.

*The jute-cultivating industry* is practically a creation of the last century. The first separate mention of jute as an article of export is made in the customs returns for 1828, when only 364 cwt. of this fibre went to Europe. In 1854, the first European factory was established at Rishra near Serampore. Several jute factories for baling of raw jute and manufacture of rope and gunny bags, sprang up round about Calcutta in the course of a few years, until at the present time the total value of the fibre has reached the sum of many crores of rupees. The out-turn is annually increasing; and within the five years 1900 to 1905 the out turn rose more than twenty-five per cent. There are now between thirty and forty jute mills at work in Bengal for the manufacture of gunny bags. These contain about two hundred thousand spindles and fourteen thousand looms.

*Area.*—The area under jute in India is over two and a half million acres. The jute-growing area is practically confined to the damp and warm districts of Eastern, Northern and Southern Bengal and of Assam.

The principal jute-growing districts of Bengal and Assam are :—

|             |    |    |    |         |        |
|-------------|----|----|----|---------|--------|
| Maimensingh | .. | .. | .. | 650,000 | acres. |
| Rangpur     | .. | .. | .. | 302,000 | ..     |
| Purnea      | .. | .. | .. | 300,000 | ..     |
| Tippera     | .. | .. | .. | 266,400 | ..     |
| Dacca       | .. | .. | .. | 171,000 | ..     |
| Pabna       | .. | .. | .. | 140,000 | ..     |
| Faridpur    | .. | .. | .. | 95,000  | ..     |
| Rajshahi    | .. | .. | .. | 84,000  | ..     |
| Bogra       | .. | .. | .. | 72,000  | ..     |
| Jalpaiguri  | .. | .. | .. | 66,000  | ..     |
| Dinajpur    | .. | .. | .. | 60,000  | ..     |

*Varieties.*—The round fruited variety (the *Corchorus capsularis*) is more commonly grown, except in the districts round about Calcutta and in Midnapur where the long fruited variety (the *Corchorus olitorius*) prevails. The latter cannot stand water-logging and is therefore grown only on high land which never gets under water. There are varieties of *Corchorus capsularis* which can stand four or five feet of water at the latter part of growth, and such varieties are harvested by people wading and diving in water. In the *bil* land north of Rajshahi this variety can be seen, and it is sown very early in the season, in February and March, when the *bil* land is quite dry. The Serajgunj *Deswal* jute is a very early, short and branched variety of *Corchorus capsularis* which has very white fibre. It is grown on *dearh* land, and is cut as the water rises. The Kakaya-Bombay is an unbranched, late and a more prolific variety of *Corchorus capsularis* which also produces very white fibre. Red stemmed varieties of *Corchorus capsularis* known by various names (such as *Vidyasundar*) produces yellowish or brownish fibre, which, though as strong, fetches a little lower price. Early and late varieties of *Corchorus olitorius* are also recognized, the late varieties, as in the case of *Corchorus capsularis*, being always more prolific. The fibre of *Corchorus olitorius* is stronger than that of *Corchorus capsularis*, but its specific gravity being greater it fetches a little lower price. The fibre of *Corchorus olitorius* is never so bright and white as that of the other species. For the mat-weaving trade in Midnapur, is always preferred the fibre of *Corchorus olitorius* on account of its strength, and locally therefore it enjoys a greater value than the fibre of *Corchorus capsularis*. The *Corchorus olitorius* is known at Serajgunj as *Tosha p'it*. Round about Calcutta it is known as *Deshi p'it*. *Dowrah* is another name by which the fibre of *Corchorus olitorius* is known in the deltaic area of Bengal. In trade all jute comes under the following classes :—(1) *Deshi*, (2) *Dowrah*, (3) *Naraingunge*, (4) *Serajgunj*, and (5) *Uttariya*; these being the five geographical areas into which the jute districts are divided, but the division is entirely arbitrary, and it does not imply quality of fibre, which varies very much in each local area. *Corchorus capsularis* prefers a lighter class of soil than *Corchorus olitorius*.



**Yield.**—Fifteen maunds of fibre may be taken as the average produce per acre, twelve maunds being the produce of the early varieties and twenty maunds, of the late varieties. As 75 per cent. of the jute is grown for sale and export, 16 crores of rupees per annum at present represent the reserve or potential food-earning capacity of raiyats, which may be utilized in course of time for its legitimate purpose as population increases and greater stress is felt by the cultivator. All non-food crops grown chiefly for sale and export by the cultivator may be looked upon in this light. In 1905 the price of jute prevailing was so great (about Rs. 10 per maund), that the raiyats of Eastern Bengal reached the extreme limit in cultivating jute, and as the rice crop was not a good one that year, the stock of food-supply in 1906 was found to be too short. But there was, of course, money in the hands of raiyats, and they could import and buy grain. There was thus no actual famine, though the local supply of food grains was deficient, and hardship was felt by the poor who had no connection with the jute trade.

**Conditions of success.**—A damp and warm climate and yet not too incessant rainfall, are the essential conditions of success of this crop. Experiments in growing jute in Madras and Bombay have been unfavourably reported upon, and there is not much prospect of competition elsewhere ruining the jute industry of Bengal. Attempts at growing jute in South Bihar, Chota-Nagpur, Orissa and other dry places in Bengal are not very successful either.

**Soil.**—With the exception of rocky, laterite and poor sandy soils, all soils are adapted for jute cultivation. Rich loam, of course, gives the best result. The coarse varieties grow luxuriantly in low-lying lands, but a better quality of fibre is obtained from *Aus* land. Pulses, oats, barley, wheat, tobacco and *Aus* paddy are grown on such lands in rotation. *Dearh* and *chur* lands and islands, also *bil* lands and ordinary *Aman* lands produce more vigorous growth and longer fibre, but the quality of the fibre is poorer. An excess of salt (such as occurs in the Sunderbun soils) does not injuriously effect the *Corchorus olitorius*, though it is not quite suitable for the *Corchorus capsularis*. In lands south of Calcutta therefore the *Corchorus olitorius* should be grown in preference, on highlands. If possible, sunn-hemp or *dhaincha* should precede jute; and on no account should two crops of jute be taken in succession on the same land.

**Cultivation.**—In lowlands, *preparation* ought to begin in November or December, though usually the winter cultivation is neglected and the first ploughing given in February or March before sowing. Two ploughings and two cross-ploughings with laddering and one harrowing or collecting of weeds, are a sufficient preparation, but previous ærification by occasional stirring continued for a long period is essential. The sowing in lands subject to

flooding takes place in March, and in some parts of Eastern Bengal in February. Sowing goes on from February till June according to the position of the soil and amount of rainfall. In the *bil* land north of Rajshahi where very heavy out-turns are obtained sowing is done as early as February. In 1906 the rainfall in February was so heavy that even in Nadia a good deal of jute was sown in February, and February sowing that year gave the best result. July sowing usually fails, but it may succeed in Bihar and Chota Nagpur. One and a half seers per bigha (*i.e.*, nine pounds per acre) is the quantity of seed to be used. Exchange of seed is practised to a certain extent by the cultivators. The ordinary time for harvesting the crop is from the middle of August to the middle of September. But jute-washing begins in July in some parts and goes on to the end of November in others, the early varieties being harvested in July and the late varieties from October. Ten to thirty maunds of fibre are obtained per acre; but the average may be put down at fifteen maunds. By using two or two and a half seers of seed per bigha, *i.e.*, by thicker sowing, no better yield in fibre is obtained, and the direction in which improvement should be aimed at to arrest the degeneracy that is at present going on in the jute crop, would be to get the cultivators to do the sowing thin in growing this crop for seed-purposes. By thick sowing the crop yields poorer seed, and the degeneracy comes through poverty of seed.

The *seed* should be sown by drilling, only nine inches apart, so that hoeing with wheel-hoe or bullock-hoe may be done. Hoeing at least once should be done after sowing when the plants are well up, and if possible, one hand-hoeing and one wheel-hoeing or bullock-hoeing should be given at an interval of a fortnight or twenty days between the two operations before the rains set in regularly, when wheel or bullock-hoeing will not be feasible; or the wheel or bullock-hoeing may be done when the land is not too wet, say, at the end of June; and the weeds pulled up with hand when the rains have set in properly. Native cultivators use the *bidia* after germination to loosen the soil and uproot extra plants.

**Maturing.**—Where there is silt deposit no manuring is required. Elsewhere cowdung, at the rate of 150 maunds per acre, may be applied where necessary. All fibre crops are appreciably benefited by cowdung manure, except those belonging to the leguminous order. Growing of a preparatory crop of *dhaincha* or sunn-hemp has been already recommended.

The proper time for *harvesting* is when the fruits have just commenced to form. Cut earlier, the produce is less and somewhat weak, though whiter and more glossy. Cut later, the fibre is coarser and rougher, though slightly heavier, but it does not do getting a heavier outturn of coarse and dirty fibre. The degeneracy complained of by jute merchants is also due to the cultivators allowing the jute to stand till the seed has begun to mature.

In this way they secure some partially mature seed, and get a little heavier out-turn, but of coarser fibre.

*Steeping* should be done in fairly deep, clear, sweet (not salt) but stagnant water. If steeping is done in running water a longer time is required for retting, and the fibre is infiltrated with a grey deposit of iron salts. Salt water also delays the process of retting. Steeped in shallow and dirty water also the fibre is somewhat grey, and it takes longer retting, specially if the whole heap is not entirely submerged in water. The grey colour is due to the deposit of iron salts. Districts of which the soil is too rich in iron are not suitable for growing high class jute.

**Method employed.**—After the plants have been cut, they are left in the field for two or three days for their leaves to shed. The stalks are then gathered, tied in small bundles and arranged in heaps of about two maunds each, which are covered with leaves and weeds and earth, and left in this state for three or four days. These heaps should be made on high ground and not in water-logged fields. The bundles are then well shaken of leaves, the branching tops being lopped off, and then removed to water where they are kept submerged under a weight of logs or wood, earth, and weeds being also used for weighting the bundles. If it is not feasible to give back to the soil the shed leaves and the tops which are of great manorial value, the stems may be removed for retting to water as soon as they are cut, with leaves and all. In the hot weather, *i.e.*, from July to September, the retting is finished in ten days to a fortnight. If cold weather sets in it takes longer, sometimes as long as two months, in which case some of the fibre gets too much retted, or rotten, and others not retted enough; and the colour of the fibre is grey and the outer bark is not entirely removed from the lower part of the fibre. The submerged bundles should be examined from time to time after a week to see that the stems are not over-retted. Over-retting not only makes the fibre darker in colour, but it also weakens it. When the retting is complete, bundle after bundle is taken by a man going down into water, and the lower end of the bundle is battered with a flat stick or mallet, usually made out of palm-leaf midrib. The pith-sticks of the lower end are separated from the fibre by shaking them out in water. The man then takes hold of the bundle of fibre and by alternate pushing and pulling with a jerky motion, the whole of the fibre out of the bundle is drawn out. Each bundle of fibres is rinsed and washed, the excess water wrung out from it, and it is then opened out in long strands and hung up in the sun to get dry. The wet bundles of fibre are kept in a heap for one day, and the exposure to the sun given from the second day. This improves the colour of the fibre. Another plan is to break off the bundle against the knee in the middle (a smaller bundle which can be conveniently broken being taken), to shake off the portions of the pith stalks at the thicker end, to wrap the fibres

from these portions round the palm of the right hand and then pull and push the rest of the stalks as before, in water, until all the fibres are removed. Instead of merely rinsing and wringing the fibres clean, it is better to wash them cleaner by taking larger handfuls at a time and swinging them round the head and dashing them repeatedly against the surface of the water, until the impurities are washed out. After exposing the fibres for two or three days in the sun, they should be tied in bales and got ready for sale. If the washing can be done away from the steeping place in clean and running water the fibre would be cleaner, but this is generally not feasible.

The *cost of cultivation* inclusive of manure comes to about Rs. 32 per acre, as will appear from the following calculation :—

|           |    |    |   |           |        |
|-----------|----|----|---|-----------|--------|
| March     | .. | .. | 1st ploughing and cross-ploughing followed by laddering | Rs. A. P. | 1 8 0  |
| April     | .. | .. | 2nd ploughing and cross-ploughing with beaming          | ..        | 1 8 0  |
| Do.       | .. | .. | Spreading 150 mds. of cowdung before 2nd ploughing      | ..        | 5 6 0  |
| Do.       | .. | .. | Broadcasting 4½ seers seed (with cost of seed)          | ..        | 0 11 0 |
| Do.       | .. | .. | Harrowing immediately afterwards                        | ..        | 0 4 0  |
| May       | .. | .. | One hand weeding  | ..        | 6 0 0  |
| July      | .. | .. | Pulling up of weeds                                     | ..        | 1 8 0  |
| August    | .. | .. | Cutting of stems (10 men)                               | ..        | 1 14 0 |
| Do.       | .. | .. | Tying bundles   | ..        | 0 15 0 |
| Do.       | .. | .. | Making heaps  | ..        | 0 6 0  |
| Do.       | .. | .. | Removing to water                                       | ..        | 0 9 0  |
| Do.       | .. | .. | Cost of weighting                                       | ..        | 2 0 0  |
| September | .. | .. | Washing (40 men)  | ..        | 7 8 0  |
| Do.       | .. | .. | Drying and making bundles                               | ..        | 1 8 0  |
|           |    |    | Rent for half year                                      | ..        | 1 8 0  |
|           |    |    |   | Rs. ..    | 32 8 0 |

The *outturn* when so much money is spent, ought to come to 15 maunds per acre, which at Rs. 6 per maund, would bring a net profit of Rs. 58 per acre. The price of jute varies from Rs. 5 to Rs. 10 per maund.

**Chemistry of jute.**—Jute may be called a ligno-cellulose, standing midway between cotton, which is almost pure cellulose, and lignose of woody fibre. Good qualities of jute have the following composition :—

|                   |    |    |                    |
|-------------------|----|----|--------------------|
| Cellulose         | .. | .. | 64 to 70 per cent. |
| Pectose matters   | .. | .. | 24 to 28 "         |
| Mineral matter    | .. | .. | 0.2 to 2 "         |
| Fat and wax       | .. | .. | 0.4 to 0.8 "       |
| Extractive matter | .. | .. | 1 to 2 "           |

The proportion of cellulose in jute is much less than in cotton. In fact, jute-fibre when young is richer in cellulose but gradually this becomes partly converted into lignose. Like

cotton, jute can be dissolved by a concentrated solution of zinc chloride or by a mixture of zinc chloride and hydrochloric acid. By dilution and acidification of the solution, the fibre is precipitated as a gelatinous hydrate to the extent of 75 to 80 per cent of the original fibre when the solution is fresh. It is important to distinguish between jute and cotton, as jute cloths are now commonly sold in the market. Chlorine combines readily with jute, the latter taking up fifteen to sixteen per cent. of this element. If the chlorinated fibre be treated with a solution of sodium sulphite, a magenta red colour is obtained, which is characteristic only of jute fibre. To distinguish jute from flax and hemp, an aqueous solution of iodine should be used. Jute is coloured deep brown, while flax and hemp are coloured blue or violet. Jute absorbs acids and alkalis from solutions much more readily than cotton, and it is therefore not such a lasting fibre as cotton. If the alkaline treatment is carried on at high temperatures, (as in the *Dhobis' boiler*) the non-cellulose constituents of the jute are attacked and converted into soluble products, the fibre finally getting disintegrated.

**Improvement recommended**—(1) thin sowing : (2) reservation of the best portion of crop for seed which should be allowed to mature fully ; (3) harvesting when pods have begun to form : (4) long preparation of soil : (5) exchange of seed with some district where the soil and climate are somewhat different.

## CHAPTER XLV.

### DECCAN OR BOMBAY HEMP (*HIBISCUS CANNABINUS*).

BOMBAY hemp, *Ambari* hemp, or Deccan hemp, called in Bengal *Mesta-pât*, in Orissa *Kaunria* and in Bihar *Pattua* or *Kudrun*, is grown largely as a crop and as a hedge-plant in Madras, the Central Provinces and Bombay. It is also grown to a certain extent in the United Provinces and the Punjab. In Bengal, it is grown chiefly in Chota-Nagpur. The merits of this fibre have not hitherto been recognised as they deserve, by exporters. It is superior to jute in every respect and its cultivation should be encouraged wherever possible, and the method of cultivation changed. The lower part of the stem contains the best fibre, and as much as possible of this should be secured in harvesting. It is not only used as substitute for jute but also for making fishing nets and paper. The pulp for making paper out of *mesta-pât* is made by adding six seers of kaolin and a maund of clean water to every maund of fibre. Slips of sized paper weighing 39 grains, made from maize stalk pulp, jute pulp and *mesta-pât* pulp, bore respectively the weights of 47lbs., 60lbs. and 71lbs., which show the superiority of the *mesta-pât* as an article for the paper-manufacturing industry. The length of the fibre is five to ten feet as

in the case of jute. The best, *i.e.*, strongest and glossiest, fibre is obtained when the plant is in flower, and not as in the case of jute, *Crotalaria juncea*, and *Abroma augusta*, when it is just in fruit. Jute contains 76 per cent. of cellulose, *mesta-pât* 73 per cent., *nomi* fibre 62·3 per cent., plantain fibre 64·6 per cent., sunn-hemp 83 per cent. and *sida* fibre as much as 83·8 per cent. Though in respect of cellulose it is not equal to the best fibres, in point of strength it is almost as good as *sunn-hemp* and it is much glossier than jute, and stronger. The following facts illustrate the strength of the *mesta-pât* fibre :

(a) A line prepared from *mesta-pât* fibre obtained from plants cut when in blossom and steeped immediately, sustained the weight of 133lbs. when wet, and 115lbs. when dry

(b) A line prepared from *mesta-pât* fibre obtained from plants cut when the seed was ripe, sustained a weight of 118lbs. when wet, and 110lbs. when dry.

(c) A line prepared from *sunn-hemp* fibre obtained from plants cut when in flower, sustained a weight of 185lbs. when wet, and 130lbs. when dry.

(b) A line prepared from *sunn-hemp* fibre obtained from plants cut when in fruit, sustained a weight of 209lbs. when wet, and 160lbs. when dry.

Rocky and laterite soils which are not suitable for jute cultivation are well adapted for the cultivation of *mesta-pât*, and areas that are not considered suitable for growing ordinary jute may be well utilized in growing *mesta-pât*; while it should be also noted that low lying lands which are flooded are not suitable for this crop, though jute may be grown in them. The yield of this fibre is about the same as that of jute, and the fibre is extracted even more easily than jute-fibre. At Sibpur the average yield of jute is twenty maunds per acre, and of *mesta-pât* twelve to fifteen maunds. From water-logged plots a smaller outturn was obtained. The best result in quality is obtained by the bundles of stems being steeped in water immediately after cutting.

The young leaves of this plant are eaten as a pot-herb, and the seed, which is rich in oil, makes a good cattle-food and is so used in Poona and also as a source of edible oil.

All the remarks regarding the cultivation of the jute crop apply to this crop also. The extension of the cultivation of this crop is an important measure of agricultural improvement. The fibre has a bad reputation in the Calcutta market, but it is not the fault of the plant but of the extraction of fibre. Cultivators get seed and fibre out of the same plants and allow them to get too mature. The plants being cut at the proper time, *i.e.*, when just coming to flower, the fibre is superior to jute fibre. Mr. Benson, Manager of the Shalimar Rope Works, who buys the *mesta-pât* grown at the Sibpur Farm, speaks highly of it, and he pays a higher price for it than for jute. Fifteen seers of seed are sown per acre, if the crop is grown singly as it should be.

The improvements recommended in the cultivation of this crop are : (1) long preparation of the soil ; (2) growing it as a single crop and not in mixture with other crops ; (3) harvesting the crop for fibre when the plants are just in flower and reserving the best plants for seed till they are dead ripe ; and (4) removing the cut plants in the fresh state to water for retting.

## CHAPTER XLVI.

### SUNN-HEMP (*CROTALARIA JUNCEA*).

THIS is the ordinary *sunn*, but not the true hemp, or *Cannabis sativa*. of commerce. *Hibiscus cannabinus* (see above) is also called *sunn* or Bombay hemp. The *Cannabis sativa* or *bhong* plant is found in a wild state in most parts of India ; but the fibre is rarely extracted from the wild or cultivated hemp plant, except by some hill tribes. In fact, the hemp plant does not produce a valuable fibre in the plains of India. The *sunn* of India is either *Crotalaria juncea* or *Hibiscus cannabinus*. That *Hibiscus cannabinus* is classed in the Indian markets sometimes with jute and sometimes with *sunn*-hemp, shows also the greater value of this article than of ordinary jute. The true hemp plant, producing *ganja* and *siddhi*, is an excisable article and its cultivation is prohibited by law. This may also account for the non-recognition of true hemp as a fibre-yielding crop in India.

Two varieties of *sunn*-hemp are commonly grown in India, a tall variety having a weaker fibre and a short variety with a stronger fibre. The former is recognised in Mymensingh as a great fertiliser of the soil.

The seed of the Indian *sunn* (*Crotalaria juncea*) is sown very thick from the 15th April to 15th June, and in Eastern Bengal in September and October also. The plant flowers in August, but it should not be cut till September when the seeds have properly formed. Sown in September or October, the harvesting season is February. It is not a profitable crop to grow in the ordinary low lying districts of Bengal, except as a fertiliser of the soil. Clay soil, rich soils and low damp soils give vigorous growth, but poor yield of a coarser fibre. High and light soils are better suited for this crop. Old alluvium is better adapted for this crop than new alluvium, when it is grown for fibre. As a leguminous crop, *sunn*-hemp is recognised even by cultivators as a renovator of soils, and it is a good preparation to grow this before a valuable crop, especially before sugarcane, tobacco, potato, jute, and some other crops. It is sometimes ploughed in, in young state, as a green manure, by cultivators of Mymensingh and many other parts of India.

In rough or sandy soil very little tillage is required for the crop. Two ploughings followed by one laddering is a sufficient preparation for sowing. The seed should be drilled six inches by four inches apart, that is thicker than in the case of jute and *mesta-pát*. Twelve to fifteen lbs. of seed per acre will be found sufficient if the seed is drilled. If sown broadcast, it is best to use half a maund of seed per acre.

The steeping of *sun*n stalks is sometimes done exactly in the same way as that of jute stalks, but in dry regions the plants are sometimes left to dry in the fields after they are cut, and the steeping done afterwards. In Lower Bengal however, the climate is too moist, and dry stacking would spoil the fibre. The yield of fibre per acre is 200 to 1,200lbs.; the average being about 640 lbs. (8 maunds), worth about Rs. 100.

There is some difference of opinion as to when *sun*n plants should be cut; whether in flower, or in fruit, or when the fruits are ripe. Every system has its supporter, and practice varies. Experiments conducted in different regions can alone decide the point. There is difference of opinion also as regards the best method of extracting the fibre. Various systems are followed: (1) The stems are buried in some places in mud in the margin of tanks. (2) In other places they are submerged in water and weighted like jute. (3) In some places running water is chosen and in others stagnant water. (4) In dry regions the stems are tied in bundles of twenty to one hundred, and left on the field until they are quite dry. After two days' steeping in water, the fibres are easily detached. (5) Separation is also effected without retting. When steeped like jute, four days' to a weeks' steeping is sufficient in the hot weather; and oversteeping must be avoided. When retting is complete, bundle after bundle is taken and threshed in water until the fibre separates out. The drying of bundles of *sun*n is done in the same way as drying of jute fibre; but heckling is afterwards required to get clean fibres parallel one to another. One-third of the weight of the fibre is lost in this heckling process, but the tow obtained is a useful material for making paper.

The seed of *sun*n-hemp used as fodder increases the flow of milk of milch cows.

## CHAPTER XLVII.

### RHEA (BOEMERIA NIVEA, ETC.).

[Prospects of the crop; Very fertile and damp soil necessary; Land must never be water-logged; Native methods of preparing fibre; Yield, Indian, European and Chinese figures; Method of cultivation; Propagation from seed, roots and cuttings; European methods of extraction of fibre; Faure's method taken up by the Bihar Rhea Syndicate; Burn & Co.'s method; merits of the fibre.]

**THIS CROP** is also known as Ramie, China-grass, and *Kankurá*. Inordinate hopes are raised from time to time regarding the prospects of the rhea-planting industry, but there is little hope of its



being worked with profit in this country, except with very expensive European machinery. The hand-stripping of ribbons or bark, as practised in China and in this country, is very expensive. The crudely cleaned and unbleached fibre is used by the Burmese, Assamese, Nagas and by the people of Rangpur, Jalpaiguri, Bogra, Dinajpur, Purneah, and Bhagalpur, for making fishing lines and nets. It is grown by a few cultivators only, each on a few square yards of land. But in none of these districts could the raw fibre be procured for less than eight annas a seer; and if any considerable quantity is wanted from any of these districts, the raw article would not be forthcoming for less than Rs. 50 to Rs. 100 per maund. A decorticating machine could no doubt render the raw produce cheap, and there are now several of these claiming public favour; but more extensive trial is needed before one can say definitely that the rhea-cultivating industry will become profitable. £20 or even £40 a ton for the raw hand-stripped ribbons is not a sufficiently remunerative price for this article, and though such prices have been offered for some years, practically no rhea ribbons have been exported into Europe. Besides it is a mistake to suppose that rhea will grow anywhere and under any conditions; and that crop after crop can be taken in any soil without manure. It is no doubt a perennial, but it grows best in shade, on rich loam; and the land must be above inundation level, but at the same time sufficiently moist to keep the plants in vigour. It demands the rankest and richest soils if a continuous series of crops is to be obtained. The crop luxuriates in fact only on the best tobacco soils of Rungpur. But even in Rungpur, the crop is of so little importance, that the village called Kankurapara (named after this crop) and where only the crop is considered of any importance, has only about twenty cultivators growing it.

**Native method of extraction.**—In Bogra the ribbons stripped from the stems are boiled in turmeric water for a few minutes, or in water in which rice has been boiled. This operation softens the fibre and assists in the subsequent cleaning process. In Bhagalpur the green stems divested of leaves are boiled in water with the addition of 10 chhitaks of *saji* per maund of plant put in the boiler, and the whole allowed to simmer or boil for one and a half to two hours. Bundles of boiled stems are afterwards dashed on a board, first one end, then the other, until all the pith is removed. The fibre is again boiled for half an hour in the original liquor, and then again beaten and washed on the board which is arranged like a *dhobi's* board by the side of water.

Scraping off the outer bark or parenchyma is practised in most districts, before the fibre is hand-stripped. In Assam after the leaves have been stripped off a stem it is divested of the outer skin by rubbing it with a blunt knife, after which the stem is left to dry for two or three days in the hot sun. The third

morning, after the stem has been exposed to dew for several hours, the fibre is drawn off the stem by breaking the woody stalk right through towards the thicker end and then separating the fibre therefrom by drawing it off gently towards the slender end ; some care being required in giving the fibre the peculiar twist in order to draw it off without breaking. A good deal of the fibre (about one-fifth) remains adhering to the stem after the drawing off has been done as described.

**Yield.**—A maund of green stems produces about a seer of fairly white fibre treated in this way, *i.e.*, only two and a half per cent. Seven to eight maunds of fibre may be obtained per acre, per annum ; but the separation of the fibre from the stems is so difficult and costly that cultivators actually go in for cultivating a few square yards each ; and no deductions as to cost and outturn can be definitely drawn with regard to this fibre from the data they are able to furnish. Some estimate the produce at as much as 50 to 55 maunds per acre.

In Spain and other European and American countries where rhea is being grown experimentally and where machinery is used for the extraction of fibre, 500 acres of a properly managed plantation is estimated to produce 7,000 to 9,000 tons of green stems per annum ; out of which it is estimated that five per cent. of fibre can be obtained, which is equivalent to 1,792 lbs. of fibre per acre per annum. The average weight of 100 stems of full-grown rhea without leaves is about 24lbs. The Chinese grow about 80,000 stems per acre, *i.e.*, about 19,200lbs. Faure's decorticating machine which extracts 3 per cent. of fibre, which is in a purer state than China-grass, is said to produce, in European experiments 576lbs. of fibre from one cutting. In the remaining two cuttings another 576lbs. at least may be reasonably expected, or a total of 1,152lbs. per acre per annum ; which at £30 per ton (the price paid in London for high class 'China-grass') is worth about £15 or Rs. 225. From the European and American estimates and from the Chinese figures it seems, one may fairly estimate the produce of rhea fibre at 1,000lbs. or say 12 maunds per acre per annum ; which is a more reliable figure to go upon than either 7 to 8 maunds or 50 to 55 maunds per acre, which are the figures variously given by Bengal cultivators. Of course, the climate and soil have everything to do with the produce. Where the climate is damp and at the foot of a hill where the soil is renewed annually by silt deposit, and the soil is always more or less damp, *without ever getting water-logged*, twenty-five maunds of fibre may be obtained ; while in dry localities the produce may not reach even five maunds to the acre.

**Method of cultivation.**—Rhea is propagated from stem-cuttings and root-cuttings, also from seed. The cuttings, six inches to nine inches long may be planted horizontally three to four inches under soil, one foot apart each way. Forty to fifty thousand

cuttings are required to plant an acre. The fields should be weeded and hoed after each cutting of stems, and heavily manured each year during the dry season. Blanks should be filled up from time to time by planting cuttings horizontally three inches deep, as already mentioned. The shoots are cut down when the bottom portion of the stem begins to turn brown and the leaves low down the stem begin to fall off. Two to five cuttings are obtained annually, according to the richness of the soil and the care with which the plants are tended; three cuttings being a good average crop. Six cuttings can be obtained in shade if the plants are heavily manured and watered. If stems ready for cutting are alone selected, as is the practice with some intelligent cultivators, cuttings can be had uninterruptedly throughout the year. If the cuttings are first planted in September, the first crop may be harvested in May (which is the shortest crop), the second in June (the best crop), the third in July, and the fourth in August. Planting of cuttings can take place in May and June also.

If rhea is *propagated from seed*, it is necessary to sow the seed superficially on light, sandy soil, well manured with rotten dung. Rhea seed should not be covered with earth after sowing. Even a light covering of earth prevents germination. But on the seed-bed there should be a covering of mat put on as is done in sowing cabbage and cauliflower seed. This mat should be kept moist; and the seed should not be watered direct. When plants have fully appeared the covering of mat should be taken off, and watering done occasionally as required. September is the best time for sowing and transplanting rhea. The seedlings should be transplanted when they are about three inches high.

The question of the *extraction of fibre* from the stems is so important, that the Government of India offered at one time a reward of £5,000 for a rhea fibre-extracting machine; but this offer was withdrawn by a Resolution, dated 19th March, 1881. This Resolution says: "From the low valuation put by the English firms on the samples of fibre produced at the late competition, it does not seem probable that Indian rhea fibre will be able, for the present at least, to compete successfully with the Chinese product; while the experience which has been so far gained also points to the conclusion that in most parts of India the cultivation of rhea cannot be undertaken with profit. Rhea is naturally an equatorial plant and it requires a moist air, and rich soil, and plenty of water, while extremes of temperature are unfavourable to it. Such conditions may be found in parts of Burma, in Upper Assam, and in some districts of Eastern and Northern Bengal; and rhea can be grown in such places with only so much care as is required in an ordinary well-farmed field for a rather superior crop, it is possible that it may succeed commercially. Until, however, private enterprise has shown that the cultivation of the plant can be undertaken with profit in these or other parts of the country, and that a real need has arisen for an improved method of preparing the

fibre in order to stimulate its production, the Government of India think it inadvisable to renew the offer, which it has now made for the second time without result, of rewards for suitable machines."

It is difficult to say whether the inventions lately made of machinery for decorticating and degumming the rhea fibre will really prove so valuable as they claim to be : but there seem to be some very good machines among them. The inventions which should be prominently mentioned are those of Messrs. Burn & Co., of M. Faure, of Mr. Gomes, of Messrs. Macdonald, Boyle & Co., of 39, Victoria Street, Westminster, London, S. W., and of Mr. Charles J. Dear, of 28, Victoria Street, Westminster.

Messrs. Macdonald, Boyle & Co., recommend two sets of decorticating battery, each set comprising of forty drums, for a plantation of 400 acres. The machinery for a plant of this size will cost £3,000, without buildings. From this they anticipate an outturn of two tons of clean and dry fibre per day, at a cost of Rs. 282.

Mr. Dear's process aims at decorticating the fresh cut stems on the plantations and degumming the crude fibre in England, where, in Yorkshire, Mr. Dear has equipped a factory to turn out per day 600 to 1,000lbs. of fibre ready for spinning, at a cost of only £1,000, exclusive of the motive power, but inclusive of the installation of electric light. The supply of crude fibre comes to him from China.

Faure's New Patent Ramie Fibre Decorticator is also highly spoken of, and has been used to a considerable extent in Behar. A full account of it and its work by Mr. Bernard Coventry will be found in the Agricultural Journal of India, Vol. II.

The fibre produced from the rhea plant is exceedingly durable. M. C. N. Riviere, the French Government Botanist at Algiers, states that the ramie linen supplied to the steamers of the Compagnie Transatlantique was in good condition after ninety voyages, while ordinary linen was worn out in forty-five trips. There seems little doubt as to the lasting qualities of ramie, and this, in addition to its silky character, would make it a highly valuable textile product if it could be introduced as an agricultural and commercial article of the country.

The fibre of a stinging nettle, *Girardinia heterophylla*, the leaves of which resemble those of grape vines, is extracted and used by the Nepalese, and also by the tribes of the Nilgiri hills. This nettle grows to a height of about ten feet in the Nepal terai.

## CHAPTER XLVIII.

## COTTON (GOSSYPIUM).

[Area of cotton in India. History of attempts at cotton improvement; on what the value of cotton depends; stems may be used for extraction of fibre; oil; trade; acreage; mixture; yield; times for sowing and picking; conditions of profitableness of the crop; cost of cultivation; silk-cotton or *simul*; *Akanda*.]

The area devoted to cotton in India is about twenty million acres. It varies considerably from year to year, but the general tendency is upward. The actual outturn of cotton (estimated) is about four million bales of 400 pounds each. The average annual yield of cotton per acre seems to be from 80 to 100 pounds of clean cotton per acre.

Bengal is a very minor factor in this production. There is only about 60,000 acres devoted to the crop; and of this half the area is in the Saran district. It is sown partly before and partly after the rainy season. In Eastern Bengal and Assam the crop is also only a minor one, and the production is almost entirely in the hills surrounding the various Assam valleys.

The other important cotton-producing provinces have approximate areas as follows:—

| AREA.              |                  |
|--------------------|------------------|
| Bombay Presidency  | 6,000,000 acres. |
| Central Provinces  | 1,200,000 "      |
| Berar              | 3,000,000 "      |
| Madras Presidency  | 1,500,000 "      |
| Punjab             | 1,500,000 "      |
| United Provinces   | 1,250,000 "      |
| Burma              | 200,000 "        |
| Hyderabad (Deccan) | 3,400,000 "      |
| Ajmere Merwara     | 40,000 "         |
| Central India      | 1,000,000 "      |
| Rajputana          | 450,000 "        |

A very great many efforts have been made during the past seventy years to improve the character of Indian cottons. Exotic cottons have been introduced again and again. American planters have been brought to grow them. But the general effect of such introductions has been small. In a few cases some of the varieties have established themselves over small areas, but except in the case of Cambodia cotton in South India in the past few years, none have become a very large factor in the produce of the country. On the whole it may be said that the character of Indian cotton is practically the same as it was fifty years ago. So much is this the case that the authorities have largely abandoned the idea of importing varieties from abroad, and Mr. Gammie, the present Imperial Cotton Specialist, has summarised recently the position as follows:—

“1. That long season cottons are quite unsuitable for early season cotton districts and *vice versa*, and that slight differences

of climate cause large differences in the quality of cotton produced.

2. That varieties characteristic of the black cotton soil fall away in some inherent quality if transferred to another class of soil.

3. That exotic varieties thrive better in red or sandy soils, and have thus only been introduced permanently with varying degrees of success outside the regular superior Indian areas, *e.g.*, Dharwar American, Bourbon in Coimbatore, North Gujarat, and the Konkan; Egyptian in Sind; upland Georgian in the Punjab and the United Provinces.

4. That inferior varieties are in many tracts ousting superior chiefly on account of their greater hardiness and more certain yield of a large outturn of cotton, and that the so-called deterioration of Indian cotton is really due to this, *plus* the fraudulent practice of middlemen.

5. Good varieties from the first, when isolated, are superior to the remaining constituents of the general mixture too often found growing in the fields, *e.g.*, *Malvensis* in the Central Provinces and Khandesh and *Karunganie* in Madras.

6. That in rare cases, provided conditions are similar, a superior variety of the same type can be substituted with advantage, for instance, Broach cotton for Kumpta in the Dharwar District of Bombay.

7. That cross-fertilisation *inter se* has in many cases undoubtedly strengthened the stock, but the same method employed between different varieties has, up to the present, yielded nothing of permanent advantage.

8. In conclusion, the cotton plant is so influenced by its environment that in some provinces, for instance, in Gujarat, varieties which appear to be absolutely the same from a botanical point of view have, nevertheless, individual characteristics which allow them to be grown in perfection and with profit only in the tracts where they have become the actual children of the soil.

These statements should give pause to attempts to make general statements as to the desirability of large scale introduction of cottons from outside, or even large transferences of one type of cotton from one place to another in India without very careful experiment beforehand.

**Points of cotton.**—The points which determine the value of a particular cotton plant to a cultivator are several, and some of these are often ignored by outsiders, who look to the character and value of the marketed cotton only. Thus it is necessary to take into account—

(1) The length of the period of growth of the cotton. This may vary from  $3\frac{1}{2}$  months to 7 months.

(2) The hardiness of the plant, and its liability to attack by insect pests.

(3) The yield of seed cotton per acre.

(4) The ginning percentage, or the percentage of lint to seed in the crop. The lint may be as low as 25 per cent. of the crop with some of the fine varieties, or may reach over 50 per cent. in some of the very poor cottons of the Assam hills. When marketed the factors which determine the value of cotton are :—

(1) the length of staple. This may vary from over 1½ inches with the best Sea-island cotton to ½ an inch with very poor Indian varieties ;

(2) the colours ;

(3) the glossiness of the fibre ;

(4) the strength of the fibre.

As a rule the introduction of a new variety is so difficult and so doubtful that it would be well for a would-be cotton grower to begin with the variety already grown in the district in which he desires to plant this crop, and only after thoroughly understanding the local difficulties of soil, climate and other conditions, to make large developments in new directions.

**Points of cotton.**—The relative value of cotton fibre depends mainly on the length, strength and fineness of the staple. The Sea-island cotton has its staple 1·65 inches long, the Egyptian 1·50 inches, the Bourbon or ordinary American 1·10 inches, and the ordinary Indian '65 to 1·3 inches, the latter figure applying to the best varieties of *Gossypium arboreum*, and the former to the *Gossypium herbaceum*. The strength of the Egyptian cotton is very great, but the Sambalpur and Bhagalpur tree-cotton that have been lately collected and examined are also very strong.

**Stems and seed.**—The stems of the plant, if rotted, yield a good fibre. Up to the time of the American War of Independence cotton-seed was regarded as a useless article. In India, even now it is thrown away in many places as a useless article ; but in many places also the seed is given to cattle, especially to milch-cows, to increase the flow of their milk. In the district of Patna, cotton-seed is used for making a high-class sweet-meat. In the Nagpur Experimental Farm, two seers of cotton-seed per diem are given to each bullock in place of oil-cake, and one seer a day may be given to Bengal cattle. Smooth seeds yield a larger proportion of oil than fuzzy seeds. The extraction of oil has been, until very recently, practically unknown in India, but a considerable development of mills extracting cotton-seed oil has taken place in the Bombay Presidency and in the Berars in the last two or three years. Decorticated cotton-cake is considered one of the best oil-cakes both for feeding cattle and for fertilizing the soil. It is as good as the best Bengal and United Provinces castor-cake as a manure, containing 6 to 7 per cent. of Nitrogen against 6 to 8 per cent. which is the proportion of Nitrogen in the best castor-cake. The ash of cotton-cake is particularly rich in

phosphoric acid, potash and lime, the constituents of the ash being shown below :—

|                           |    |    |    |    |       |
|---------------------------|----|----|----|----|-------|
| Potash                    | .. | .. | .. | .. | 35·4  |
| Phosphoric Acid           | .. | .. | .. | .. | 30·0  |
| Lime                      | .. | .. | .. | .. | 4·4   |
| Magnesia                  | .. | .. | .. | .. | 15·1  |
| Soda                      | .. | .. | .. | .. | 0·8   |
| Sulphuric Acid            | .. | .. | .. | .. | 3·2   |
| Oxide of Iron and Alumina | .. | .. | .. | .. | 1·1   |
| Chlorine                  | .. | .. | .. | .. | 0·5   |
| Carbonic Acid             | .. | .. | .. | .. | 3·5   |
| Sand, etc.                | .. | .. | .. | .. | 6·0   |
|                           |    |    |    |    | 100·0 |

The most economical way of applying cotton-cake and other edible oil-cakes to the soil, is to use them as cattle-food, on the land intended to be enriched, the cattle being hurdled in here and fed in movable troughs.

For every pound of lint there are two to three pounds of seed. One hundred pounds of American cotton-seed yield about two gallons of oil, forty-eight pounds of oil-cake and six pounds refuse oil fit for soap-making. With the ordinary *ghani* about twelve to fourteen per cent. of oil can be obtained from the seed but the seed should be very free from adhering cotton. Ginning establishments in the midst of cotton-growing districts may well be employed in extracting oil and supplying oil-cake. This is an industry for which there is a fine opening in India. It is the income from seed that makes all the difference in America between a profitable and an unprofitable cotton crop. The magnitude of this opening in a new direction can be inferred from the fact that India produces about ten million cwt. of cleaned cotton. This represents about twenty to thirty million cwt. of seed. Allowing half this quantity as required for seed and feeding of bullocks in localities where the seed is used for feeding bullocks, nearly 700,000 tons would be still available for extraction of oil for export and obtaining of oil-cake for cattle-food and manure. 100 to 200lbs. of clean cotton and 300 to 600lbs. of seed may be taken as the yield per acre. The most important cotton-growing districts in Bengal are:—Saran, Chittagong Hill Tracts, Cuttack, Lohardaga, Darbhanga, Midnapore, and Manbhum. The best cotton lands in Bengal are the Chittagong Hill Tracts, Chota Nagpur, Midnapore, Cuttack and Jalpaiguri.

**Trade.**—In the struggle between America and India in the European cotton market, which has gone on for 100 years, America has gradually supplanted India. In 1818, the export of



Indian cotton to England amounted to as much as 86,555,000lbs. or 247,300 bales (a bale of cotton =  $3\frac{1}{2}$  cwt.). In 1821, only 20,000 bales were exported. In 1841, however, the export rose to 278,000 bales. In 1848, the export fell to 49,000 bales. During the American Civil War, India again became the chief source of supply of cotton to the English market. At the end of the war, American cotton regained its footing in the English market. The objections to the Indian cotton in the English market were,—(1) imperfection of picking, cleaning and packing, (2) adulteration, (3) the higher price which has to be paid for the inferior hand-ginned cotton, compared with the price paid for the superior machine-ginned American cotton, and (4) the shorter-staple of the Indian cotton. The improvement in cotton cultivation in recent years is mainly due to the establishment of numerous cotton mills in India chiefly in Bombay, Ahmedabad, Cawnpore and Nagpur.

**Mixtures.**—*Arahar, castor, til, maize* and *juar* are often grown along with cotton. Groundnut can be grown with cotton. Where cotton is grown with other crops the yield of lint is 50 to 80lbs. per acre; where it is grown by itself, the yield is 75 to 150lbs. per acre, though the best varieties, such as the Nausari cotton and the *Buri kapas*, often yield as much as 400lbs. lint per acre and more. Grown by itself the common *Gossypium herbaceum* varieties are sown about nine inches apart; while the more bushy *Burhi* variety is grown  $2\frac{1}{2}$  to 3ft. apart. The tree-cottons are grown 8ft. apart. The last are grown by transplanting seedlings at the commencement of the monsoon, the seedlings being grown in prepared seedbeds beforehand. From sowing or transplanting to picking of bolls, two hoeings and one nipping of buds are desirable. By nipping fresh branches are thrown out, and the plants bear more fruits.

*The time for sowing and picking* cotton in the principal cotton growing districts of Bengal are given below :—

|                         | <i>Sowing time.</i>   | <i>Harvest time.</i>  |
|-------------------------|---|---|
| Midnapore ..            | May and June.   | September to March.   |
| Cuttack ..              | (1) June to July.<br>(2) February.<br>(3) October and November. | (1) October and November.<br>(2) May and June.<br>(3) February to June. |
| Manbhum ..              | (1) May to July.<br>(2) September to December.                  | (1) October to December.<br>(2) February to April.                      |
| Lohardaga ..            | (1) June.<br>(2) October.                                       | (1) November to January.<br>(2) April and May.                          |
| Durbhanga ..            | (1) May and June.<br>(2) October.                               | (1) March and April.<br>(2) August and September.                       |
| Saran ..                | June and July.  | April and May.  |
| Chittagong Hill Tracts. | (1) April and May.<br><br>(2) January and February.             | (1) November and December<br>(2) August and September.                  |

According to the above table, March and August are the only months when cotton is not sown and July the only month when

picking is not done. For Egyptian cotton, the late Mr. Tata recommended October and November as the best months for sowing. But we have found that the plants require more irrigation in this case, and when they are in full bearing the rainy season comes in and spoils the bolls. June is the best month for sowing and July for transplanting in Bengal. The cotton sown after August is called "late cotton." Though no manure is used, as a rule for cotton, the use of bonemeal (2 mds.), or lime (3 mds.), and salt (40lbs. per acre) has sometimes proved beneficial.

**Seed.**—Five to ten lbs. of seed is used per acre. For tree-cottons which may be sown in seed-bed and afterwards transplanted, 1lb. of seed is a sufficient allowance for an acre. Between the rows of cotton groundnut can be grown. The first picked and clean bolls should be reserved for seed.

**Conditions of success.**—On an average, to every 30 parts of cotton (*i.e.*, lint and seed) there are 20 parts of seed and 10 parts of lint, and the feeding value of 200lbs. of cotton-seed obtained per acre is at least Rs. 5. The profitableness or otherwise of the crop therefore depends mainly on three considerations: (1) the staple chosen, (2) the use of the cotton gin, (3) the utilisation of the seed as cattle food. One variety would yield 300 to 400lbs. of lint per acre, whereas another will yield only 75lbs. On the whole the *Burhi* cotton seems to be the best to grow in Bengal, though persistent attempts should be made to grow the superior tree-cottons.

The *cost of cultivation* per acre for the cotton crop in Bengal may be calculated as below:—

|  | Rs.   | A. | P. |
|--|-------|----|----|
| Four ploughings with laddering before sowing ..                                      | 3     | 0  | 0  |
| Manuring with cowdung and lime (150 maunds of dung and 4 maunds of lime per acre) .. | 7     | 8  | 0  |
| Watering before sowing (unless there is rain) ..                                     | 2     | 8  | 0  |
| Pickling of seed (5 seers) ..  | 0     | 8  | 0  |
| (Rubbing with cowdung, lime and ashes) ..  | 0     | 8  | 0  |
| Cost of sowing behind plough ..  | 1     | 0  | 0  |
| Watering after sowing (not needed if sowing done in June or July) ..                 | 2     | 8  | 0  |
| Hoing and thinning or patching ..  | 2     | 0  | 0  |
| Nipping of tips ..   | 1     | 0  | 0  |
| Picking (1-10th of produce) ..   | 2     | 0  | 0  |
| Rent ..  | 3     | 0  | 0  |
| Cleaning or ginning (1½ annas per 10lbs.) ..   | 1     | 0  | 0  |
|  | <hr/> |    |    |
|  | 26    | 8  | 0  |

The price of cotton lint varies much. One hundred lbs. of cotton at 4 as. a lb. can fetch only Rs. 25, and unless a heavy yielding variety of cotton is chosen, cotton-growing does not pay. Hand-ginning usually costs a good deal more than the amount calculated above, but where the industry is well established poor women do actually work at these low wages.

*Silk cotton* or *simul* (*Bombax Malabaricum*) is a tree. The fibre of this is almost worthless for textile purposes, and it is used chiefly as padding for pillows. Blankets and other articles are being now made out of this fibre, and the demand for it is increasing. *Akanda* or *Midir* (*Calotropis gigantea*) pod fibre may be looked upon in the same light. But the fibre obtained from the stems of this plant is one of the strongest fibres known. The stems are cut into sticks about eighteen inches, long dried in the sun for two or three days, battered afterwards, and then the outer bark peeled off and the fibre picked out with teeth and fingers from the inner bark, and then twisted into rope for cordage or fishing net. No water is used either for retting or for helping in the twisting of the rope.

## CHAPTER XLIX.

## ALOE FIBRES.

VARIOUS plants of the natural order Liliaceæ and its allied order Amaryllidaceæ, yield leaves rich in very strong and beautiful fibres. To the former belong Yuccas and Sansievierias and to the latter Agaves, - all being popularly called aloes.

**Yuccas.**—The fibre of *Yucca gloriosa* or *Adam's needle*, which we have as a hedge at Sibpore, is fine, silky and strong, but the length is so short that this plant cannot compete with Sansievierias, Agaves, or Pineapple plants. The fibre is not unlike pineapple fibre but the average length is less than two feet.

**Sansievierias.**—These produce the celebrated bow-string hemp. This fibre being silky white, is superior to Agave fibre, but the length is seldom over three feet while agaves often reach six feet. The wild Sansievieria (*Sansievieria Zeylanica*) of Faridpur and other districts of E. Bengal (called *Chhunchmukhi* or *moorva*) produces as good fibre as the more famous foreign varieties, but the length of the fibre is very short, not more than two feet. Of all the Sansievierias, the *Sansievieria trifasciata* which is to be commonly seen in Calcutta gardens, grows best, and is on the whole, the best variety to choose. The length which the leaves attain is generally three to four feet while the length of the other kinds is generally under three feet. This does not require so much watering or manuring as the other varieties. The strength of the Sansievieria fibre compared to some other fibres can be judged from the following figures :—

|                                     |    |    |          |
|-------------------------------------|----|----|----------|
| Line made of cocoa-nut fibre (coir) | .. | .. | 224 lbs. |
| „ Hibiscus cannabinus fibre         | .. | .. | 290 „    |
| „ Sansievieria zeylanica            | .. | .. | 316 „    |
| „ Gossypium herbaeeum               | .. | .. | 346 „    |
| „ Agave lurida                      | .. | .. | 362 „    |
| „ Crotolaria juncea                 | .. | .. | 497 „    |
| „ Calotropis gigantea               | .  | .. | 552 ..   |

**Agaves.**—Though coarser than *Sansieviera* fibre, *Agave* fibre being stronger, and being produced by plants which seem to grow better on poorer soils, is likely to respond better to cultivation operations. All the plants were originally American, and imported into India probably within the last four hundred years. They have, however, spread all over the country, and can be found growing in a semi-wild condition in most parts of India. One or other of them has been used as a fence along railway lines in almost every province. The classification of the agaves is difficult, and the botanical names by which they have been commonly known have been frequently changed. A very thorough examination of the whole subject and a reclassification of the Indian agaves was recently made by Drummond (*see Agricultural Ledger*). All of them, with the exception of *Agave sisalana* or Sisal-hemp, yield about the same amount of fibre, namely, two to three per cent. This last, however, yields much more, or from four to five per cent. as a rule. This plant has few or no spines on the sides of the leaves, and hence is much more easy to work with than most of the other kinds.

The *general rules* to be observed in planting all *Agaves* are :—  
 (1) Plant about 400 suckers to the acre,—eight feet between rows and six feet between plant to plant. With a smooth edged variety somewhat closer planting than this is advisable. (2) Whenever a leaf assumes the horizontal position cut it out for extraction of fibre. (3) The cutting out of leaves generally commences from the fourth year after planting and it goes on until the plant flowers which it does in seven to fifteen years. Flowers or bulbils often appear in the fourth or fifth year after planting, in the plants of India. (4) All suckers should be removed from the bases of plants as soon as they appear as they weaken the main plant. They may be planted in a separate nursery to be afterwards transplanted into the field. (5) Planting of suckers between the older plants for renewing the plantation should commence as soon as leaves begin to be cut, that the plantation may be always in full bearing. (6) Each plant after four or five years should be divested only of twenty-five to thirty-five leaves per annum, a quantity which will yield 1½ lb. to 1¾ lb. of clean fibre. About one-third of a ton of fibre per annum is all that can be expected per acre. (8) Rich, moist good soils should not be chosen for growing *Agaves*, as such soils are only wasted on this crop. The growth is luxuriant, but the fibre on such soils is weak, and if there is water-logging, the plants perish. At the same time it must not be supposed that poor rocky hilly soil is suitable. A good light or medium land will answer well, but cultivation between the plants is essential, and great care altogether in the early days of the plantation. A full account of the whole question of planting Sisal-hemp will be found in Mann and Hunter's '*Sisal*'-hemp planting in the Indian tea districts, published by the Indian Tea Association, Calcutta.

**The Mauritius hemp.**—The fibre plant grown in Mauritius is the green or foetid aloë (*Furcraea gigantea*). This plant is now cultivated in many parts of Ceylon and India. In German East Africa also the Mauritius hemp and hemp-extracting machine have been introduced. It grows on fairly poor land. Gravelly soil produces the best fibre. Moist and rich lands are not suitable, and that probably accounts for this variety producing such a small proportion of fibre in East Bengal and Assam, where 2 to 2½ per cent. were obtained against 4 and 4½ per cent. obtained in Sambalpur. In fact the plant flourishes best where ordinary vegetation does not cover the land. The leaves are four to seven feet long, four to six inches broad at the middle, bright green in colour, and either armed with small black marginal spines or altogether smooth. The pulp, when the leaves are crushed, gives off a strong pungent odour. Planting of bulbils should be done in the open in the rainy season or just before the season. The plant reaching maturity, a flower-stalk fifteen to twenty feet in height grows out from its centre. The blossoms form into bulbils that develop into young plants which are planted in nurseries six inches apart and transplanted when one or two years old. Thus it goes on propagating itself. The Mauritius hemp has the tendency to send up flower-stalks, at least in Lower Bengal, from the fourth year and a plantation of this aloë would not last for more than twelve years.

All these fibres can be extracted from the leaves either by retting or by scutching the leaves. Though the former is usually adopted by the people for their own use, yet it weakens the fibre seriously and there is no export market whatever for such retted fibre. Apart from this the only method is by scutching, the simplest form of the machine used being a wheel fitted with a number of metal plates or beaters on the circumference, which on rotation beat against the leaf and scrape away the pulp leaving the fibre behind. The simplest of such machines is the so-called 'Raspador' used in Yucatan, and worked by hand. From this have developed machines of all sizes up to the huge automatic apparatus capable of dealing with 100,000 leaves per day, and with the produce of say six hundred acres of sisal-hemp or other agave plant.

## CHAPTER L.

### OTHER FIBRE CROPS.

**Abroma augusta.** (*Ulat-kambal*).—This is a perennial bush or small tree, the stems of which yield a valuable silky fibre. The stems can be cut three times in the year and as the retting and extraction of fibre can be done as in the case of jute, it is very desirable to introduce this crop rather than rhea as a high class

perennial fibre crop. It flowers in the rainy season and the seed ripens in the cold season. Roxburgh says that the fibre of *ulat-kambal* is one-tenth part stronger than *sun*n and much more durable in water.

**Hibiscus abelmoschus** (*kasturi*), etc.—Nearly all malvaceous plants yield useful fibres. The common *Hibiscus esculentus* or Ladies finger, the Roselle (*Hibiscus sabdariffa*), the *Hibiscus mutabilis*<sup>8</sup> (*Sthal-padma*), and *Hibiscus ficulneus* (*Ban-dhenras* or *Belun-pit*), have been all used for their valuable fibre. Indeed the last named plant is preferred to jute by the cultivators of Murshidabad for their own domestic use. In an experiment conducted by the Agri-Horticultural Society of India, *Hibiscus abelmoschus* yielded the best crop of all the fibre-yielding plants experimented with and the yield came to 800lbs. of fibre per acre, with a Death and Ellwood's machine, while a larger yield (12½ maunds per acre) was obtained by the ordinary process of retting. The seed also has a commercial value and it is known to perfumery makers in Europe by the name of *grains d'ambrette*. The seed when ground gives the smell of musk and amber and it is used for making sachet-powder and perfumery.

Of other fibre-yielding plants the following may be mentioned :—

*Ananas sativa*.

*Musa paradisaica* (plantain stalks).

*Musa textilis* (Manila hemp).

*Pandanus utilissimus* (*Keyaphul*).

*Sesbania ægyptiaca* (*Jainti*).

*Seshania aculeata* (*Dhaincha*).

*Passiflora* sp. (*Jhumkalata*).

*Bauhinia vahlii*.

*Anona reticulata* (bullock's heart).

*Sida rhomboidea* (*Berela*).

*Saccharum ciliare* (*munj*).

*Ischœmum angustifolium* (the *Bhabur* or *Babui* grass which is largely used for paper-making).

The "Quaxima" fibre of Rio-de-Janeiro being considered one of the coming rivals of jute may be also mentioned here. The fibre is long and strong and it can resist the action of water. The plant grows in low-lands near the sea. Of fine linen-like fibres may be mentioned the "Ibira" fibre of Paraguay. Pineapple, Sida and Babui grass growing under the shade of trees, they can occupy land which ordinary crops cannot.

## CHAPTER LI.

PINEAPPLE (*ANANAS SATIVA*).

PINEAPPLE plants should be guarded against excessive heat and cold ; that is why they are often grown under shade. They do best on low, rich land that will not overflow, and near water. High land if irrigable and shaded is suitable. In Florida they are planted eighteen to twenty-four inches apart in pineries, *i.e.*, under *michins*. As many as 20,000 plants (planted 2 ft.  $\times$  1 ft. apart) are crammed into an acre in the Bahamas islands, whence the fruits are largely exported to the United States. The ground chosen in these islands is more or less rocky. The owners of land share with the cultivators in the produce. The proprietors of land make advances in cash or provisions to the cultivating labourers, until the reaping of a crop, and the cultivator is precluded under an agreement from selling his share to any other than the landlord, the price paid for being 1s. to 1s. 6d. per dozen according to the date of production. Eighteen months to two years must elapse between the planting and the reaping of the first crop each plant producing one fruit. Sometimes a plant bears in twelve to fifteen months. When ripe, the pineapples are cut and carried on the heads of men and women to the beach nearest the plantation whence they are shipped in large American vessels. The London Market is principally supplied by the Azores and Canary Islands. But the best pineapples are grown in English hot-houses. It is a mistake to suppose that the best fruits grow in shade. Pineapple does grow in shade, but it grows better in the open especially in the lower districts of Bengal where the climate is moist and equable. In districts where the soil is dry, or rocky and harsh, it grows better in shade. The Mauritius variety which we have in the Sibpur Farm is a superior variety. The Sylhet and Assam pineapples generally, are also famous.

**Manure.**—Cotton-seed-meal and tobacco-dust at planting have been found to be the best preparatory manures for pineapples. A month before fruiting bone-dust gives the best result.

Pineapple fibre has been sold at one hundred and fifty dollars per ton in London and New York, but there is no regular market for it. Ten leaves weigh about a pound and 22,000 leaves a ton. A ton of leaves yields 50 to 60lbs. of clean fibre obtained by scraping and beating, steeping, washing and finally exposing the fibre to the sun. The steeping, washing and exposing to the sun are repeated until the fibre is white.

If the fruits can be preserved or even the juice of the fruit by our cultivators, pineapple-growing would prove highly remunerative. The following recipe is recommended for preserving the juice of all soft fruits :—Press out the juice of the fresh fruit, separating it completely from seeds and skin. Then submit the juice to heat of 180°F. (never higher than 190°F. nor lower than 175°F.)

for half an hour. Next filter it through a conical flannel bag, to extract the coagulated albumen and other flocculent matter. Then put the juice in bottles. Place these in a trough of water up to their necks and bring the water to a temperature of 200°F. (keeping it always below the boiling temperature, *i.e.* 212°F.) The bottles are to be kept at this temperature only for a quarter of an hour, and then corked and sealed at once before cooling. The corks used should remain in the hot water in which the bottles are placed. Another method of preserving juices of fruits will be described in the chapter on "Planting of Trees."

A word of caution is necessary to persons desirous of introducing such new fibres as rhea, pineapple and agave. The fibres of these like the fibres of jute are not of uniform fineness. Only 10 or 15 per cent. of the pine fibre is of silky and delicate fineness which would fetch £30 or £35 per ton in the London market. It should be also remembered with regard to pineapple fibre, that about one hundred and fifty years ago it formed an important article of export from Chittagong and the Straits Settlements and it was woven into *dhoties* and sheetings in the Dutch possessions. Cotton has gradually ousted it from the field. With improved machinery capable of spinning even yarns out of short staples, pineapple fibre may become a favourite textile material again, but its re-introduction must be looked upon only in the light of a hopeful experiment.

## CHAPTER LII.

### PLANTAINS (*MUSA PARADISAICA*).

**Banana Jelly.**—Plantains being largely grown in Bengal, a simple method of preserving this fruit, successfully carried out at Sibpur, may be described with advantage. Peel the ripe fruits, cut them into slices, add 1lb. of water to each pound of slices and boil for about one hour until the mixture is soft enough to be strained through calico. After straining add one pound of sugar and sufficient citric or tartaric acid, or simply lime juice, to give the mixture an agreeable acid taste. If citric or tartaric acid is used it should be dissolved in water before it is added to the fruit pulp. The boiling should then be repeated for at least another hour. Finally the jelly is bottled up when fairly hot, the bottles used being fumigated inside with a taper of burning sulphur introduced immediately before the warm jelly is put in. A piece of parchment paper is put on the top of the jelly before the cork or stopper is put on, after the jelly has become quite cool. From the refuse stuff after the straining of the pulp through calico banana-meal may be prepared.

**Banana-meal.**—The *banana* plantation is looked upon in some parts of Africa as an important source of food-supply. Banana



meal is a highly nutritious and light food. The Negroes prepare banana-meal in a primitive fashion. They dry the fruits and pound them in a mortar. Placed in jars or sacks, away from damp, it remains good for a long time. But a quick-drying apparatus should be used if the meal-industry is to be introduced into a damp country like Bengal. The fruits are stripped of skin and cut in rounds and placed on a perfectly cleaned and heat-disinfected trays in the desiccator. When perfectly dry the chips are ground and passed through a sieve. In a climate like that of Lower Bengal, it is best to make banana-meal out of the refuse obtained after the extraction of jelly. The refuse pulp is pressed (say with a cheese-press), dried in the sun, then powdered with the *dhenki* or *janta*. The meal so made keeps good. The produce of meal is 20 to 25 per cent. of the weight of fruits used. 15lbs. of fruits will give 3lbs. of meal. It contains 1·4 per cent. of Nitrogen or =9·01 per cent. of albuminoids. For making meal it is preferable to use fruits which are not altogether ripe and which contain more starch than ripe fruits. The fruits on analysis give the following average results :—

|                       | Untipe bananas. | Ripe bananas. |
|-----------------------|-----------------|---------------|
| Water .. .. .         | 70·92           | 67·78         |
| Starch .. .. .        | 12·06           | Trace         |
| Grape-sugar .. .. .   | 0·08            | 20·47         |
| Cane-Sugar .. .. .    | 1·34            | 0·50          |
| Fat .. .. .           | 0·21            | 0·58          |
| Albuminoids .. .. .   | 3·04            | 4·72          |
| Crude fibre .. .. .   | 0·36            | 0·17          |
| Tannin .. .. .        | 6·53            | 0·34          |
| Ash .. .. .           | 1·04            | 0·95          |
| Other matters .. .. . | 4·62            | 0·79          |

Mr. R. Swaminathan, analysing a sample of banana-meal from *Kánch-kalá* sent to him from Madras to Cambridge gives the following figures comparing the feeding value of banana-meal with those of wheat, rice and potato :—

|                       | Banana-meal. | Wheat. | Rice. | Potato. |
|-----------------------|--------------|--------|-------|---------|
| Water .. .. .         | 13·70        | 13·4   | 11·3  | 11·0    |
| Proteid .. .. .       | 3·78         | 11·7   | 7·3   | 7·4     |
| Fat .. .. .           | 0·75         | 2·0    | 1·2   | 0·7     |
| Carbohydrates .. .. . | 77·17        | 69·3   | 77·6  | 74·0    |
| Fibre .. .. .         | 1·50         | 1·8    | 1·6   | 2·5     |
| Ash .. .. .           | 3·10         | 1·8    | 1·0   | 3·5     |
|                       | 100·0        | 100·0  | 100·0 | 100·0   |

**Varieties.**—The principal varieties that are ordinarily cultivated in Bengal, or have been introduced with success, are :—*Martamán*, *Chámpá*, *Chini-champa*, *Kántháli*, *Sábrí*, *Anupam*, *Ram-rambhát*, *Kanai-bashi*, *Agnishwar*, *Bombay*, *Kabuli*, *Singapuri* and *Penang*. *Kánch-kalá*, which is ordinarily used as a

table-vegetable, is also eaten in the ripe state by the poorer classes. *Martamin* and *Chimpá* are the ordinary good varieties. Banana jelly is best made out of the *Martamin* variety.

**Soil.**—Clay-loam soil not subject to water-logging and situated close to a tank, ditch, jhil, or canal, should be chosen. The land should be ploughed up and while a crop of *Aus* paddy is growing, the suckers should be planted 8 cubits apart in the beginning of the rainy season. The pit should be made a cubit deep and manured with cowdung. The intervals should be ploughed and cross-ploughed once a year, and silt from the tank, canal, or jhil, applied in April as manure round the base of each clump. In one year the tree should be in bearing. When the bunch of fruits has formed the portion of the inflorescence hanging on, should be cut away and a little *chunam* lime should be smeared at the cicatrix that the nourishment which would have been wasted on it might go to develop the plantains. The tree should be cut down from the base as soon as a bunch has ripened. No clump should have more than three suckers at its base when the older tree fruits. All suckers should be taken out after a year, *i.e.*, in the next May, June or July and planted elsewhere, if necessary. It is intended to keep up the old plantain garden for a second, third or a fourth year, instead of planting suckers at the old spots or letting the suckers already there to grow undisturbed, the planting should be done on the second year between the two original lines and in subsequent years also in new spots, that the whole of the soil of the garden may be made use of by the plantain crop before it is abandoned for a new garden. This is not the system prevalent at Baidyabati, where the old clumps are kept up by manuring, but it is the system adopted in Dacca. The suckers planted should not be too large, and they should be divested of all expanded leaves as they are planted. The only operation needed after the suckers have been planted is the heaping up of earth round each, if the Dacca system is followed. The leaves should not be cut away except from trees that are cut down after they have borne fruits. 300 to 600 bunches of plantains yielding about Rs. 150, may be expected per acre per annum from a plantation of bananas. The coarser kinds being more prolific than the finer kind, the variety makes little difference to the profit under ordinary treatment.

The *kántháli* variety produces the best fibre. The leaf sheaths may be passed through a sugarcane mill with smooth rollers then combed on both sides with a brass comb, which will bring out most of the cellular substance. The blunt edge of a sickle may be afterwards used for getting more of the cellular substance out. The bundles of fibre are then to be washed in water and afterwards boiled with ashes or soft-soap and then rinsed well in plain water, wrung and exposed in *thin layers* to dry in *shade*. They are then to be exposed to dew for three successive nights,

and in day time the drying should proceed in the shade. A simple machine consisting of a large curved knife worked by a spring handle over a block of wood is now in use in many parts of southern India for cleaning the fibre out of leaf-sheaths. Plantain fibre is not in demand but should be worth at least twice as much as jute.

Manila hemp is the produce of a plant (*Musa textilis*) allied to banana. It is very much superior to the fibre obtained from *kinthola* plantain trees.

## CHAPTER LIII.

### POTATO (*SOLANUM TUBEROSUM*).

[Rotation ; Two crops of potatoes in succession in the same year . Potatoes grown year after year in the same land ; *Dhaincha* crop an excellent preparation , Liming after ploughing in *dhamcha* , Soils suitable for the crop . Cultivation for growing potatoes on the garden system and the field system , Irrigation ; Manuring ; Lifting ; Use of the Hunter hoe for lifting potatoes , Preservation of seed ; Varieties , Cost ]

**Rotation.**—Potato is usually grown in Bengal after *Aus* paddy or jute, or maize, or, in tracts of country where the potato is the principal crop, it often forms the only crop of the year. In the district of Baghelkand, in parts of Bihar, and in the Khasi hills, two crops of potatoes are taken from the same land in one year. There is a common notion both in this country and in England that potatoes do well grown on the same land year after year. The texture of the soil is no doubt rendered fitter and fitter for the potato crop by the cultivation operations done for this crop, but insect and fungus-pests predominating prove the injuriousness of this system after a few years. It is best to grow a crop of *dhaincha* (*Sesbania aculeata*) or *sunm*-hemp, between June and August and plough the crop in, in August or September. This green manuring adds considerably to the produce of potatoes. Lime and fresh ashes together, say fifteen maunds per acre, should be used if green manuring is done, to hasten the decomposition of the manure and prevent insect pests. Even when the *dhaincha* crop is not ploughed in but sold off, the land is enriched by the crop residue and the root-nodules.

**Soil.**—The soil should be a sandy loam, of a fine texture, but not a heavy clay loam. Such soil, if it contains a good deal of humus matter, which makes it retentive of moisture, is best suited for the crop. Shallow, sandy or stony soils and heavy clay soils, are not suitable for potatoes. Sandy soil improved by the admixture of *jhil* or pond silt answers very well. Stagnant water is very injurious to this crop and if sowing is done early, in September or October, the land chosen must be high and capable of easy draining. The site selected must also be close to water, as irrigation is very necessary for this crop in most districts.

**Cultivation, garden system.**—Deep cultivation and thorough pulverizing of the soil are essential. Two ploughings and two cross-ploughings with an improved plough followed by one grubbing with a five-tinned grubber and one cross-grubbing should be done as soon as the rainy season is over, the three series of operations being conducted at intervals of one week between the operations. Then should follow one or two harrowings for collecting weeds. It may be necessary to hand-pick the *sunni* or *dhaincha* stalks before commencing ploughing, if either of these crops is grown as a preparation for the potato crop. The highest manurial value is attained by these preparatory crops, when they are in flower, and they should be cut then, and if from August to September the stalks do not get sufficiently decomposed by submergence under water, ploughing and liming should be done after hand-picking. The cost of picking, however, will be more than realized by the sale of the dry stalks afterwards for fuel or as stakes for the pea or *pan* crop. The harrowing should be followed by a *bakharing* or laddering to bring the land to a level seed-bed. The land should then be prepared for irrigation before sowing is done, as the making of irrigation channels after sowing uproots a number of seed tubers. The field is first divided from its head, or main channel for irrigation, to its bottom, into a number of long strips six feet wide, separated by water-channels about a foot wide, leading from the main channel at the head of the field to the bottom. The strip of land six feet wide should then be divided into ridges and furrows eighteen inches from one another. Along these ridges six feet long and eighteen inches wide, potatoes should be planted in double rows four inches apart early, say in September or early in October, four inches from one another and four inches deep. This is a very costly method of preparing the land for potato cultivation and one which can be practised by cultivators only on a small scale with the object of bringing the crop early to market. Early sowing is however very risky. Heavy rain taking place after sowing may do a great deal of damage by actually rotting the seed or disturbing the irrigation arrangements and washing down the ridges. Early sowing also very often results in insects destroying a portion of the crop. But in localities such as parts of Burdwan, Birbhum and Sonthal Perganas, where rain water sinks into the soil or flows out freely, early sowing is advantageous. Pickling of seed in a mixture consisting of sulphate of copper, ashes and castor-cake and the use of lime or ashes to rot the *dhaincha* or *sunni*, are great preventives against insects.

**Field-system.**—For cultivating potatoes on a large scale, the ridging plough should follow the *bakhar* or the levelling board, beam, or ladder. The field should be as long as possible and the ridges should be at right angles to the main irrigation channel. The ridges made by the ridging plough will not be absolutely

straight, but if trained bullocks are employed they will be sufficiently straight for the purpose of the agriculturist, and they should be about twenty-four inches apart. The sowing in this case should be done after all fear of late rain is over, say about the 20th to the 31st of October or even, later. The sowing should be done in this case not along the ridges but along the furrows. A man should make a straight channel four inches to five inches deep with a narrow spade or Planet Jr. hoe simply by running the implement along each furrow and between two adjacent ridges. Another man should put in two rows of pickled potatoes six inches apart both ways, and cover up the channel as he goes on, following the man who is making the channel, while a third man goes on putting manure along the covered channels only. Instead of spreading the manure all over the field this will be found a more economical way of using the manure. Planting deep in between ridges also saves the cost of irrigation. The two earthings are to follow the manuring. The practice of applying the manure in two doses, at the time of the two earthings, does not seem to be justified, unless highly soluble manures, such as saltpetre are used. Castor-cake, bone-meal and cowdung, which are ordinarily recommended for use, are not highly soluble, and applying them in one dose after planting the seed, is advisable. In fact, cowdung should be applied at an early period of preparation of soil, and bone-meal should be first converted into superphosphate by the addition of sulphuric acid before applying it to the trenches after planting seed. Bone-meal being a comparatively insoluble manure does not have much effect on a short-lived crop like the potato. Potatoes are benefited by high manuring and one of the following manures is recommended for use :—

|                                | Maunds<br>per acre. |                       | Cost.           |      |
|--------------------------------|---------------------|-----------------------|-----------------|------|
|                                |                     |                       | Rs.             | Rs.  |
| (1) Bone-superphosphate ..     | 6                   | } applied immediately | 30              | } 66 |
| with castor-cake (powdered) .. | 18                  |                       | after planting. |      |
| (2) Rotten cowdung ..          | 400                 | } applied before      | 10              | } 55 |
| with ashes or lime ..          | 15                  |                       | planting.       |      |
| and Castor-cake ..             | 15                  | applied after         | 30              |      |
| (3) Rotten cowdung ..          | 600                 | planting.             | 15              |      |
| with bone-superphosphate ..    | 6                   | } applied before      | 30              | } 45 |
|                                |                     |                       | planting.       |      |
| 4) Castor-cake ..              | 30                  | } applied immediately |                 | } 60 |
|                                |                     |                       | after planting. |      |

**Irrigation.**—Whether the plants all come out within a fortnight or not, first watering should take place within ten days to a fortnight after planting unless a good shower of rain makes this watering superfluous. The tardy sprouts will come up after the watering. If seed-potatoes are kept in-doors under a heap of moist straw or over damp sand for a week or ten days before planting, the sprouting will be quicker and more even after planting.

Instead of flooding the field or running the water along the channels in which the seed-potatoes are imbedded, it is best to run the water along channels between the rows of potatoes, or to distribute the water from the channel by means of an irrigation spoon or *thali*. This prevents caking of the soil. But if the water is run along the channels in which the potatoes are imbedded, hoeing should be done within a week after the irrigation to allow the sprouts to come up without resistance. The first earthing up with *kodalas* or by splitting the ridges with a double mould-board plough should take place when the plants are six to nine inches high. There should follow two waterings at the interval of a fortnight and then the second earthing. If the soil looks dry, irrigation should take place before and after the two earthings at shorter intervals, say, once in ten days. Three to six irrigations are necessary, according to the nature of the locality and of the season. But in some northern and eastern districts of Bengal, potatoes can be grown without irrigation, which is a great advantage.

**Lifting.**—Potatoes are not ready for lifting until the leaves and haulms have withered completely and the land has become quite dry. Another way of lifting potatoes is doing it in two instalments, the first lifting of large sized tubers being done when the plants are still green by carefully digging under each plant with the *Khurpi* and putting the earth back, that growth may continue. This is a costlier operation, but it pays where early potatoes sell at a high price. Potatoes require about three months to mature from the time of sowing, and February and March are the ordinary months for harvesting, though by sowing early in September or October lifting can be done in December and January. Lifting is best done with the Hunter hoe unless a potato-digging plough or a potato-digger is used. Perhaps a slightly larger proportion of tubers gets cut when the Hunter hoe is used than when spades are used. 100 maunds to 150 maunds per acre is a fair outturn, though as much as 300 maunds per acre are sometimes obtained.

**Preservation of seeds.**—It is difficult to preserve the seed of the superior and large sized hill potatoes in the plains, and one of the chief obstacles to the spread of the cultivation of the Naini Tal potatoes has been the high price that has to be paid for the imported seed at the time of sowing. If each cultivator could store his own Naini Tal potato-seed there would be no occasion to grow the inferior *Deshi* varieties. The following plan may be tried. In a dark but well ventilated room erect shelves on which sand is to be spread and the potatoes spread one deep on the shelves, covered by the sand. Ten or twelve shelves may be arranged one above another on a *machan*. All rotten potatoes must be weeded out and the seed-godown examined constantly for this purpose. Small sized potatoes keep better than large ones.

Only the high and dry districts of Bengal are suitable for preservation of seed.

Steeping of potatoes in a dilute solution of sulphuric acid (2%) for 10 hours and then wiping them dry and storing on sand has been recommended for preserving potatoes meant for food; but this experiment has failed both at Sibpur and at Berhampore, and the method is probably inapplicable for this climate. New and vigorous races of potatoes are established in temperate countries by propagating the plants from seed. Seed-tubers from hill-stations or from a temperate climate give better crops than those grown from tubers raised in the plains. As it is difficult to preserve the seed of these superior varieties in the plains until the next sowing season, and as the exchange of seed with a hill country or a temperate climate has been found beneficial, the attempt to preserve seed may not be attended with good results. The cost of seed is the great obstacle to extensive cultivation of high-class potatoes. In October, when sowing is done in Lower Bengal, seed costs Rs. 5 or Rs. 6 a maund; and an acre of potatoes costs about Rs. 75 in seed alone. As very small sized potatoes do not give good result, a large weight of seed is required. So far all attempts to preserve seed-potatoes (except of the poor country varieties) has only partially succeeded in Lower Bengal.

**Varieties.**—The Patna variety of potatoes with red skin, though wanting in flavour, gives a better yield than the Naini Tal variety, and the seed of this variety can be preserved in the plains like the seed of the *Deshi* variety, and the popularising of the Patna potatoes would be an improvement. A Madras variety is also very prolific, but it does not keep so well as the Patna or the *Deshi*.

**Cost**—The expense per acre may be calculated thus:—

|  | Rs.        | A.       | P.       |
|--|------------|----------|----------|
| Two ploughings and 2 cross-ploughings with improved plough .. .. . | 3          | 0        | 0        |
| Two grubblings .. .. .   | 1          | 8        | 0        |
| Picking <i>dhaincha</i> stalks or 2 harrowings .. .. .             | 1          | 8        | 0        |
| Twenty maunds of lime .. .. .                                      | 12         | 0        | 0        |
| Spreading do. .. .. .  | 1          | 8        | 0        |
| Laddering or bakharung .. .. .                                     | 0          | 12       | 0        |
| Ridging with double mould-board plough .. .. .                     | 0          | 12       | 0        |
| Seed 10 maunds .. .. .   | 50         | 0        | 0        |
| Pickling seed .. .. .  | 3          | 8        | 0        |
| Planting seed .. .. .  | 6          | 0        | 0        |
| Castor-cake (30 maunds) .. .. .                                    | 60         | 0        | 0        |
| Spreading .. .. .  | 2          | 8        | 0        |
| Two earthings .. .. .  | 6          | 0        | 0        |
| Four irrigations .. .. .   | 12         | 0        | 0        |
| Harvesting .. .. .   | 6          | 0        | 0        |
| Rent .. .. .   | 3          | 0        | 0        |
| <b>Total Rs.</b> ..  | <b>170</b> | <b>0</b> | <b>0</b> |
| <b>Outturn 150 maunds at Rs.</b> ..                                | <b>225</b> | <b>0</b> | <b>0</b> |

**Net profit about Rs. 50.**

## CHAPTER LIV.

BRINJAL (*SOLANUM MELONGENA*).

[Soils suitable, Excess of organic matter or nitrogenous manure injurious; Lime, Phosphates and Potash, useful manures; Varieties; Seed-bed; Transplanting Cultivation; *Kuli begun*; Cost and outturn.]

NEXT to potatoes *beguns* or brinjals (called also egg-fruits and aubergines) is the most highly prized vegetable of Bengal.

**Soil.**—High, well, drained sandy loam or garden soil not too rich in organic matter, suits this crop best. In clayey soil the fruits of *begun* and *patal* become small though sweeter. An excess of organic, or nitrogenous manure, present in the soil, gives rise to the development of leaves at the expense of flower. At the Sibpur farm it has been noticed that unmanured plots give better result than plots manured with saltpetre and cowdung. Being very subject to diseases and attack of insects, it should not be grown in the same locality oftener than once in five or six years, and the land should be kept well drained, as stagnant water gives rise to fungoid diseases. The free use of lime and ashes at the time of sowing and transplanting is also recommended and thorough and protracted cultivation before planting.

**Varieties.**—There are two distinct varieties of brinjals. *Muktakeshi*, *Makra*, *Chhatare* and *Elokeshi* belong to the ordinary class, but *kuli begun*, growing in bunches and bearing fruits for a much longer period, is botanically a different variety and is sometimes designated *Solanum longum*.

**Seed.**—When the biggest first fruits are ripe and golden yellow in colour they are removed from the plants and cut right through the middle. In this state they are kept in a heap for two days. The seeds are then easily detached, washed clean in water and dried in the sun. The sowing is done in a seed-bed for which a cool and shady place should be chosen. The soil is well pulverised with the *kodali* and by hand, and well rotted manure mixed with lime and ashes applied. This should be done in January or February, while the sowing should be deferred till the end of March or still later, the usual time of sowing the seed in Lower Bengal being early in May. Thorough weathering of the soil should take place before sowing is done. After a shower of rain or watering of the bed by sprinkling, seed is sown evenly but pretty thickly; and the hand is lightly rubbed over the bed to give the seed a covering. Every evening except when there is rain, the seed-bed should have a light sprinkling of water (say with a water-can furnished with a rose). If the seed-bed is in shade, well protected from the sun, no other protection will be required; otherwise the bed should be covered with palm or plantain leaves until the germination takes place in three or four days. Light watering should be continued every evening after germination also. If a



heavy shower of rain takes place the seed-bed should be carefully drained of standing water. If insect pests appear, ashes and lime should be dusted on the plants.

**Transplanting.**—The field where the seedlings are transplanted should be also prepared very early in the season, *i.e.*, in December or January. This should be done with a *kodali* or with an improved plough and grubber. The grubber should be passed afterwards once a month until planting. By the middle of May the land should be levelled and got ready for planting. Drains are made all round the field and a few water channels running through the field, as in the garden cultivation of potatoes. Then *julis* or furrows are made thirty-six inches apart and the *begun* seedlings planted along the middle of the *julis* after a heavy shower of rain. If planting is done early in the season, *i.e.*, in April or May, transplanting the seedling may be done on the level plot thirty-six inches apart instead of in furrows; and the water channels are made afterwards. Mustard-cake and ashes and lime should be applied finely powdered under each plant at the time of transplanting. Cowdung and castor-cake encourage the growth of vegetation at the expense of flowering and fruiting; and six maunds of mustard-cake and three maunds of ashes and one maund of lime are a sufficient application for one acre. In a fortnight or ten days the *kodali* should be passed between the rows of plants, thus levelling the field. Blanks noticed should be filled up at this time. After another fortnight the *kodali* should be passed once more between the rows of plants converting the furrows into ridges. Irrigation may or may not be necessary according to the character of the season and the time of planting. If planting is done after a heavy shower of rain, in June, irrigation will not be generally necessary till November; but if it is done in April or May, irrigation will be necessary at least once to save the crop from drought. From November to March irrigate once a month. The fruits will begin to bear in August. From August to October one more earthing is required when the land is somewhat dry.

*Kuli begun* seed is sown in September and October; the seedlings are transplanted in October and November, and they bear from February to June. From May to August the ordinary brinjal plants may be made to bear fruits if trees that show signs of decay by February or March are pruned, manured with mustard-cake and ashes and watered. Fresh shoots will be thrown out, and fruits of a somewhat inferior quality will be borne.

*Dhashalaga* and *Tulshimara* are the commonest fungoid diseases of brinjal, which the cultivators attribute to not cutting the tap-root at the time of transplanting and also to the roots getting cut at the time of earthing. These are fictitious causes. Root-cutting has something to do, no doubt, with the vigour of plants; and cutting of the roots when there is water-logging may

indirectly cause spores of fungi to settle in the tissues of the plants ; but the exciting cause of the diseases is the presence of the spores, in the seed, of a bacillus (*Bacillus solanacearum*). Water-logging helps the spread of the bacillus. Every plant affected with a fungoid disease must be uprooted and burnt. The seed used should be pickled, and the same locality always avoided for growing this crop from year to year.

The cost per acre might be estimated as below :—

|  | Rs. | A. | P. |
|--|-----|----|----|
| January—Ploughing and cross-ploughing, with laddering ..           | 1   | 8  | 0  |
| February—Grubbing and cross-grubbing, with harrowing ..            | 1   | 0  | 0  |
| June—Making irrigation channels .. ..                              | 1   | 0  | 0  |
| „ Making furrows 3 ft. apart .. ..                                 | 4   | 0  | 0  |
| „ Transplanting seedlings 3 ft. apart .. ..                        | 3   | 0  | 0  |
| „ Cost of manure .. ..   | 10  | 0  | 0  |
| „ Manuring seedlings .. ..   | 5   | 0  | 0  |
| „ First earthing .. ..   | 4   | 0  | 0  |
| July—Second earthing .. ..   | 4   | 0  | 0  |
| August—One hand-weeding .. ..                                      | 5   | 0  | 0  |
| October—Hoing .. ..  | 4   | 0  | 0  |
| December to February—Three irrigations followed by<br>hoeing .. .. | 19  | 8  | 0  |
| Gathering fruits .. ..   | 9   | 0  | 0  |
| Rent .. ..   | 3   | 0  | 0  |
|  | 74  | 0  | 0  |

The outturn of 150 maunds of brinjals at a pice a seer comes to about Rs. 90, and the net profit to only about Rs. 15 per acre.

## CHAPTER LV.

### *Patal* (TRICHOSANTHES DIOICA).

NEXT to potatoes and brinjals, this is the favourite table-vegetable in use in Bengal. The leaves and tender shoots of the creeper (called *Paltá*) are eaten cooked, specially by convalescents. *Sandy loam* is best suited for this crop as for most cucurbitaceous vegetables. It grows well on river sides, even on the sides of rivers containing an excess of common salt, provided the soil is not heavy. The male and female vines are distinct, and as propagation takes place from cuttings, *patal* cultivators usually cheat others desiring to cultivate this crop, by supplying them with cuttings from male plants only. About five per cent. of male plants are quite sufficient for the purpose of fertilization.

Four or five ploughings and harrowings at the end of the rainy season, followed by making of holes in parallel lines six feet apart, and planting of adventitious roots and joints cut up into lengths of about three inches each, two in each hole, are the first operations required. The holes are covered with straw and watered every other day to hasten sprouting, except when there are

seasonable showers. *Patal* being a diceicious plant, the cuttings should be mainly chosen from female vines, though the presence of a few male vines is also necessary. When the plants have all come up, *i.e.*, about November, one hoeing is given and then raised beds are made, as water-logging is highly injurious to the creepers. Each bed should have one row of plants, and the bed is made sloping towards the channels. The earth dug up in making the channels is utilised in raising the beds. If the field is very long, one or two water channels are made across the field also, intersecting the other channels at right angles. One irrigation done in February hastens the fruiting in March. Fruiting goes on from March to September, after which a light ploughing, followed by weeding in October, and one or two irrigations in February and March, will keep the crop for a second year. Usually no manuring is done for *patal*, silt being depended upon. Ashes and lime or bone-dust would be of benefit if the crop is kept on a second year on high land.

*Cost*—

|  | Rs. | A. | P.     |
|--|-----|----|--------|
| 4 ploughings .. .. .                       | ..  | .. | 3 0 0  |
| Planting, including making of beds .. .. . | ..  | .. | 6 0 0  |
| Spading or earthing (15 men) .. .. .       | ..  | .. | 3 0 0  |
| Watering .. .. .                           | ..  | .. | 4 8 0  |
| 2 weedings (12 men each time) .. .. .      | ..  | .. | 3 0 0  |
| Cost of cuttings or roots .. .. .          | ..  | .. | 4 0 0  |
| Rent .. .. .                               | ..  | .. | 3 0 0  |
| Total ..                                   | ..  | .. | 26 8 0 |

*Outturn*.—100 maunds at 1 pice a seer comes to about Rs. 60 and at 4 annas a seer, Rs. 1,000.

## CHAPTER LVI.

### CHILLIES (*CAPSICUM FRUTESCENS*).

LIKE brinjals, chillies are very much subject to fungoid diseases, but they are not so subject to the attack of insects. *Dalbhangra rog* and *Kutèlaga* are the commonest fungoid diseases. When these overtake a crop it is not feasible to stop them. In fact, chillie cultivation has to be given up for two years successively in a locality affected with either of these diseases before it can be taken up again. The Bordeaux mixture and invigorating manures have been used in vain. Besides the ordinary *Capsicum frutescens* of Bengal may be mentioned the *Capsicum annuum* or Nepal chillies, and the *Capsicum minimum* or *Dhani lanka* which are varieties more highly prized for their greater pungency. Cayenne pepper is made out of *Capsicum annuum*. Some bright coloured varieties of *Capsicum annuum* have, however, no pungency at all, and these are preferred for the feeding of birds as they are supposed to heighten the colour of their feathers.

**Soil.**—Sandy loam and newly-formed alluvium on the banks of rivers do well for this crop, but dry rocky soils containing plenty of lime produce the best crops if they are sufficiently loamy. The finest crops of chillies are grown in Bogra, Backergunge, Chaibasa, Patna and in parts of Gujarat.

**Rotation.**—This crop generally follows one of the pulses or oilseed crops, and it is sometimes grown after potatoes. It is followed by *aus* paddy.

**Cultivation.**—The land is to be prepared exactly as in the case of brinjals. The seed is sown in May or June in a nursery situated in the shade as in the case of brinjals. When six or seven inches high in the seed-bed, the seedlings are transplanted after a good shower of rain 27×18 inches apart. The time of transplanting is July and August. When the plants have established themselves in raised beds well protected from stagnant water, their roots should be partially exposed to light and air by removing the earth from their bottom. A month after this, mustard-cake at the rate of six maunds per acre is put at the bottom of each plant and the plant earthed up at the same time. The field should be kept clean of weeds, two hand-weedings and two wheel-hoings being recommended. One or two irrigations may be required after November and a hoeing after each irrigation.

**Harvesting.**—December to February is the proper harvest season for ripe chillies, though chillies are also plucked green in October and November and sent fresh to market. Plucking should be done about four times, five men being required per acre each time. The ripe chillies are spread out in the sun for about a fortnight. Night dew does them no harm and they may be left out day and night for a fortnight, but if rain is feared they must be brought indoors.

**Yield.**—The yield per acre is 6 to 15 mds., each maund selling from Rs. 4 to Rs. 7. Unless a tract is known to be particularly adapted for chillies, it is risky growing this crop for profit. The cost per acre comes uniformly to about Rs. 50, while the outturn may vary from Rs. 25 to Rs. 100.

The *cost* may be estimated as below :—

|   | Rs. | A.        | P.         |
|---|-----|-----------|------------|
| Ploughing and making of beds .. ..        | ..  | 12        | 0 0        |
| Transplanting .. ..                       | ..  | 2         | 8 0        |
| 2 Earthings .. ..                         | ..  | 6         | 0 0        |
| 2 Hand-hoings .. ..                       | ..  | 6         | 0 0        |
| 2 Wheel-hoings .. ..                      | ..  | 1         | 8 0        |
| 1 Irrigation .. ..                        | ..  | 2         | 8 0        |
| 1 Hocking with shades after irrigation .. | ..  | 3         | 8 0        |
| Plucking and drying .. ..                 | ..  | 5         | 0 0        |
| Rent .. ..                                | ..  | 3         | 0 0        |
| <b>Total Rs.</b> .. ..                    | ..  | <b>42</b> | <b>0 0</b> |

## CHAPTER LVII.

## ENGLISH VEGETABLES.

[Origin ; Soaking of seed in water and delicate seed in camphor water ; Preparation of seed-bed ; Treatment of seed-bed ; Watering ; Transplanting ; Which vegetables need not be transplanted ; Distances apart ; Quantity of seed required ; Protection of seedlings after transplanting ; Previous preparation of land, thorough and protracted ; Soils suitable for different vegetables ; Suitable manures ; Special mixed manure for vegetables ; Irrigation with hoeing or channel irrigation ; Whence seed to be obtained ; Germinating power, how tested ; Sowing in seed-bed also in regular lines ; Growing of English vegetables in the hot weather in trenches ; Site for market-gardening.]

NEXT to potatoes, palvals, and brinjals, the English vegetables, *viz.*, cabbages, cauliflowers, tomatoes, knol-kohl, turnips and beet, have come to be regarded as the important cold weather table-vegetables, specially in Bengal towns.

**Origin.**—What are known in India as English vegetables did not all originally come from England. The original home of cabbage, carrot, celery, parsnip, salsify, sea-kale and turnip is believed to be England. But beans came originally from Persia and India ; beet, broccoli, cauliflower, lettuce, parsley, and peas came originally from Southern Europe or Asia ; Brussels sprouts as the name implies, originally came from Belgium ; kohlrabi from Germany ; leek from Switzerland ; endive from the East Indian Islands ; Jerusalem artichoke from Brazil ; potatoes from Peru ; tomatoes from South America ; onions from Africa ; radish and rhubarb from China, and spinach from Northern Asia.

**Climate.**—Taking into consideration the land of their origin we should infer that for this climate cabbage, carrot, celery, parsnip, salsify, sea-kale, turnip, Brussels sprouts, kohlrabi, leek, and spinach are not suitable. But experience shows that nearly all the vegetables mentioned above can be successfully grown even in the climate of Lower Bengal, specially in the cold weather ; though it is necessary to import the seeds of those varieties, which are natives of the temperate climate, from such climate. Cabbage and cauliflower seeds from Patna, onion seed from Poona and Verawal, and carrot seed from any part of Bihar and also from Verawal (Junagadh State) give good results.

**Cultivation.**—The following points may be particularly noted in connection with the growing of English vegetables :—

(1) Any seed with a tough coat should be soaked in cool water (at a temperature of about 60°F.) before sowing. The seed should be sown when still damp, and it should be covered with fine leaf-mould one to three inches deep according to the size and strength of the seed. Pea and bean seeds, for instance, should be sown three inches deep, while only a very light covering of less than a quarter inch of loam or mould should be put on celery or lettuce or

cabbage seed. Delicate seed should be soaked in camphor water, the bottles in which they are kept soaked stoppered up for an hour, and the seed sown immediately afterwards. The percentage of germination is higher from seed thus treated.

(2) The seed is to be sown in a raised and well pulverised seed-bed manured with well-rotted manure and leaf-mould, the soil consisting of friable sandy loam, clean and without grit or stones. There should be a cover of mats on the seed-bed; or sowing should be done in boxes in a verandah. Seed should be sown towards the close of the rainy season. After scattering the seed on the seed-bed a light cover of leaf-mould should be put on it and on that ashes are to be sprinkled. Ashes should be sprinkled on the seedlings also, as soon as they appear.

(3) After germination, the covering mats are to be taken off every evening if no rainfall is apprehended at night, and the cover put on again at 8 or 9 A.M. Some sunlight is needed for seedlings or else they grow up into sickly plants.

(4) Water is to be gently sprinkled on the seedlings as occasion requires—say, once in two or three days if the soil looks dry.

(5) When there are four to six leaves on the seedlings they are ready for transplanting.

(6) Carrots, turnips, beet, mangel, tomatoes, salsify, spinach, onions, peas and beans, are not transplanted from seed-beds, but sown where they are meant to grow. Where plants grow too thickly they are thinned out. Beet and tomatoes may be sown in seed-beds and afterwards transplanted.

(7) Before transplanting the seed-bed is to be well soaked with water.

(8) Transplanting should take place in straight lines and at such distances apart that water channels may be made easily.

(9) In transplanting, a dull or showery day should be chosen, if possible, or else the plants thoroughly watered, or transplanting done after a heavy shower of rain and the soil round them mulched if mulching materials are available. The plants are to be set a little deeper in the soil than they were in the seed-bed, and the soil round the roots should be made firm with the hand without, however, bruising the necks of the plants. The plants should never be pulled up from the seed-beds, but always lifted up with a little soil adhering to the rootlets. Watering the seed-beds before lifting, helps this. Watering the transplanted seedlings should be done two or three times a week early in the morning or late in the afternoon, until they are well established. If mulching is done, saving in watering and hoeing will be effected.

(10) In transplanting, the spacing should be regulated by two considerations—1st, that two adjacent plants when fully grown up may not touch each other, and 2ndly, that there may be sufficient space for water channels between two rows of plants. The plants may be thus set closer in lines than in rows. When sowing is done in the open as in the case of radish, turnips, carrots,

onions, etc., the plants should be thinned out, the strongest plants being left, wherever possible, proper regard being had to regularity of the lines and the evenness of distance among the plants.

(11) Transplanted into deep and wide trenches, English vegetables can be grown in the plains, up to June. The irrigation should be done in the trenches, the plants being set on two ridges at the bottom of the trench. The trenches should be made 2 or  $2\frac{1}{2}$  feet deep and about the same in width at the bottom, where two rows of plants should be planted with a water channel in the middle.

(12) Dwarf beans, both broad and kidney, should be sown two feet apart and five inches in the lines, from plant to plant. Tall beans should be sown 3 ft.  $\times$  5 inches apart; peas 4 ft.  $\times$  2 inches; and beet 18 inches  $\times$  9 inches apart. Broccoli and cabbages should be planted 2 ft.  $\times$   $2\frac{1}{2}$  ft. apart; Brussels sprouts (which are suited to poor soils and do well even without manuring) 2 feet  $\times$   $1\frac{1}{2}$  feet apart; carrots 10 inches  $\times$  6 inches apart; celery and leek 6 inches apart in nursery-beds before they are transplanted for the second time into trenches which should be 1 foot deep and  $1\frac{1}{4}$  ft. wide, the trenches being 4 ft. apart. Endive salad should be planted 1 ft.  $\times$   $1\frac{1}{2}$  feet apart; onion 15 inches  $\times$  9 inches apart; garlic 1 foot 6 inches apart; parsley 1 foot  $\times$  1 foot apart; kohlrabi 18 inches  $\times$  15 inches apart; parsnips 15 inches  $\times$  12 inches apart; and turnips 1 foot  $\times$  6 inches apart.

(13) Quantity of seed required per acre—

|   |         |   |
|---|---------|---|
| Brussels sprouts, broccoli, and parsley | ..      | 2 ounces.   |
| Cabbages                                | .. .. . | 4 ounces.   |
| Onion (sets)                            | .. .. . | 1 maund.  |
| Onions and carrots (seeds)              | .. .. . | 8 ounces.   |
| Radish                                  | .. .. . | 8 ounces.   |
| Leek and celery                         | .. .. . | 1 ounce.  |
| Endive                                  | .. .. . | $1\frac{1}{2}$ ounce.                               |
| Lettuce                                 | .. .. . | 3 ounces.   |
| Turnips and parsnips                    | .. .. . | 6 ounces.   |
| Beet                                    | .. .. . | $2\frac{1}{2}$ seers.                               |
| Peas and beans                          | .. .. . | 1 maund.  |
| Country peas                            | .. .. . | 15 seers to $4\frac{1}{2}$ mds.<br>(if for fodder). |
| Jerusalem artichoke (bulbs)             | .. .. . | 5 maunds.   |

(14) Castor leaf, arum leaf, *bur* leaf, plantain leaf or leaf sheath, or some such article must be used in the day-time for protecting the seedling against the sun for a week after transplanting.

(15) Thorough previous preparation of land where the seedlings are transplanted is necessary to avoid insect pests. Also some of the following things may be used—mustard cake, ashes, lime, salt, white arsenic, asafœtida and aloes, as an insecticidal mixture at the time of transplanting. A handful of the mixture can be mixed up with the soil where each seedling is planted.

(16) Cabbages, kohl-rabi or knol-kohl, broad beans and tomatoes do well on the heavier classes of loam, and broccoli, cauliflower, kidney beans, turnips, onions, garlic, beet, radishes and carrots, on the lighter classes.

(17) Cabbages are specially benefited by saltpetre at 10 mds. per acre ; cauliflower by mustard-cake and lime or ashes at 10 mds. and 5 mds., respectively per acre ; but turnips and knol-kohl are especially benefited by bone-superphosphate at 6 mds. per acre accompanied by heavy manuring with farm-yard manure. Carrots and radishes prefer cowdung at 200 mds. per acre, and tomatoes are specially benefited by cowdung ashes.

(18) The following mixture has been found particularly good for growing English vegetables :- Fowl manure, two baskets ; powdered cowdung cake, three baskets ; ashes, one basket ; gypsum, one basket. Moisten the whole with fresh urine at the time of application of the mixture, and apply one handful at the bottom of each plant, after it is fairly well established in the field. Vegetable-marrows, beans, maize and potatoes are specially benefited by this manure.

(19) Irrigation is most essential, and whenever the land looks dry, irrigation must be resorted to followed each time by one wheel-hoeing, or channel irrigation effected, in which hoeing is not necessary so often. Four to eight irrigations are needed according to the climate and the character of the soil. The land should be divided into ridges along the natural slope, in making the irrigation channels which will involve loosening of the bases of the plants and earthing them up.

(20) It is best to buy reliable English seeds or seeds from Mussoorie or some other hill station grown by a well-established and reliable firm, instead of depending on plains seeds, though they may be had cheaper. Patna cabbage and cauliflower seeds and Poona onion seeds, however, give very good results.

(21) Cabbage and turnip seeds, like cucumber and melon seeds, retain their germinating power for several years when kept protected from insects in a dark receptacle ; while seeds of peas, beans, carrots, parsnips and onions are of no use after a year. The germinating power of seeds may be tested by placing them between two pieces of damp flannel kept continuously moist for a week.

(22) It is better to sow the seeds of all crops ( not merely English vegetables ) the seedlings of which are raised in seed-beds, i.e., cotton, tobacco, cabbages, lettuce, tomatoes, etc., in narrow shallow drills in the bed, than to sow them broadcast. Young plants grown in drills are much easier to lift and transplant and to keep clean from weeds, and, as a rule, they are hardier. In sowing small-sized seeds in seed-beds one-quarter to half an inch of soil above the seed is enough. If the drills are covered in with a little very fine and thoroughly rotten manure, germination takes place quickly ; and in transplanting some of the manure will be mixed up with the ball of earth surrounding the roots. In sowing



seeds of onion, carrots, radishes and turnips in open ground, have the soil thoroughly tilled, pulverised, cleaned from weeds and levelled previous to sowing. These seeds should be sown in drills two feet apart, so that a bullock-hoe may be used between the drills

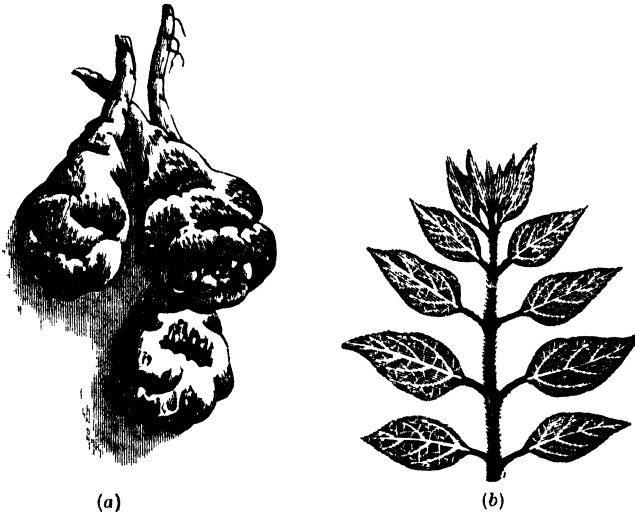

FIG. 65.—JERUSALEM ARTICHOKE  
(a) BULBS : (b) STEM WITH LEAVES.

(23) Near large towns, vegetable-gardening (called also market-gardening) that is to say, the growing of potatoes, brinjals, palval, cabbages, cauliflower, turnips, beet, knol-kohl, carrots, asparagus, artichoke, Jerusalem artichoke, *palam ság*, *dengo ság* (in the rainy season), chewing sugarcane and English peas and beans pays well. Ample provision for manuring and irrigation is necessary. Dairying and goat-farming ought also to prove highly remunerative if carried on within a short distance from towns. Vegetable-gardening and dairying may well be combined, as any vegetables that are not readily sold can be given to cattle. Goat-farming may also go well with vegetable-farming if proper arrangements for hurdling the goats in can be made.

## CHAPTER LVIII.

### CARROT, RADISH AND SWEET POTATOES.

**CARROT.**—The English root-crop which has a special value as a nourishing famine-food and fodder is the carrot. Up-country carrot or *gájrá* is not such a nourishing and palatable food as the European carrot ; and of all the carrots experimented with in this country, the Red Mediterranean variety grown at the Cawnpore Experimental Farm seems to be the best. The Yellow Mediterranean carrot is a heavier yielder, but it is more suited as a cattle food.

The yield of the White Mediterranean carrot is almost equal to, or even higher than that of country carrot, but the roots are hard, coarse and insipid. Without manure the country variety gives a much larger yield than any of the European varieties. Carrots should if possible, not be directly manured. The previous crop should be highly manured, but the carrot itself grown without manure. There should be plenty of lime in the soil where carrot is grown.

The proper time for sowing carrot seed in the plains is between the 15th September to 15th October, and if famine or scarcity is feared, sowing is done still earlier in the United Provinces. It is best to sow in drills made along the natural inclination of the land, and ridge the drills after the plants have appeared and then to thin out the plants. Two hundred maunds of well rotten dung should be used before sowing, or better still before sowing the previous *aus* paddy crop. Eight to twelve ounces per acre is the quantity of seed which should be used. The yield comes to 200 to 500 maunds per acre, if good loose soil near a village site is chosen and if the soil is deeply cultivated, well pulverised, weeded two or three times and irrigated five or six times. The seed should be mixed up with wood-ashes at the time of sowing and, unless the soil is quite moist at the time, water should be poured in the drills immediately after sowing.

The following analysis of carrots give an idea of the high feeding value of this vegetable :—

|                              | White Medtn.<br>carrots. | Red Medtn.<br>carrots. | Engish.<br>carrots. |
|------------------------------|--------------------------|------------------------|---------------------|
| Water .. ..                  | 84.57                    | 84.43                  | 87.30               |
| Soluble albuminoids ..       | .35                      | .48                    | } .66               |
| Insoluble do. ..             | .17                      | .30                    |                     |
| Sugar and starch ..          | 8.98                     | 7.98                   | 8.10                |
| Crude fibre ..               | 2.37                     | 3.70                   | } 3.20              |
| Woody fibre ..               | 2.19                     | 1.80                   |                     |
| Soluble mineral matters ..   | 1.09                     | .99                    | } .74               |
| Insoluble mineral matters .. | .28                      | .32                    |                     |
|                              | 100                      | 100                    | 100                 |
| TOTAL Nitrogen .. ..         | 1.75                     | .230                   | .200                |

So important is the carrot regarded in the United Provinces as a stay during famine, that numerous applications were received by District Collectors during the famine of 1896-97 for carrot seed, when the local supply was exhausted. Telegraphic order was sent off at once to Messrs. Carter & Co. for seed, and they sent out over 100 tons of seed. It was not before December and January, however, that the seed was in the hands of cultivators, and the imported carrot either failed to germinate or produced only very meagre crops.

**Radish.**—This also belongs to the cabbage family and although it is a cold weather crop, the *sag* can be grown nearly all the year

round. It and the China cabbage are therefore grown in the Bengal Jails as vegetables for prisoners. In the hills the radish can be grown all the year round. The large and small pale pink radish is liked by Indians, while the small red and round radish is grown to a small extent for European consumers. There are special localities in Midnapur, Birbhum, etc., where very huge radishes are grown, but the seeds of these tried in the Sibpur Farm gave the ordinary small sized radishes that we see sold in the Calcutta bazaar. There are certain light soils rich in mineral matters that are therefore specially suitable for the crop. The sowing time is June to December, though the best time is September; and the crop takes only two months maturing, which is a great advantage. The seed should be sown in lines nine inches apart and seedlings should be thinned out so as to have them three inches apart in the lines. Thorough and deep cultivation and watering once in ten or twelve days are essential. As there is no very great demand for this crop, except in large towns, and as it is not such a nourishing crop as the carrot, any extension in the cultivation of this crop cannot be recommended, but as a fast growing vegetable, it can be grown by cultivators for domestic use on homestead lands.

**Sweet-potatoes.**—Sweet potatoes. *Batatus edulis*, are also a common root-crop of the country, and the principal stay in famine times. This crop is propagated from stem cuttings of the vine which are planted on ridges in August or on the flat in October in moist localities six inches apart, the ridges or lines being made one foot apart. No further cultivation is necessary and the crop lifted in January or February is 100 to 300 maunds per acre. *Sánk álu* is also called sweet-potato. It is a leguminous crop, the seed of which is sown in June or July. The creepers are relished by cattle. The roots are eaten raw and not cooked as *Batatus edulis* roots are. The roots are lifted in February.

## CHAPTER LIX.

### TURMERIC AND GINGER.

THERE are certain crops that grow well in the shade. Of these turmeric, ginger, arrowroot, pine-apple, *pipul*, groundnut, rhea, *Sida rhomboidea* and *babui* grass may be mentioned prominently. As it is desirable to have trees at the outskirts of farm land, which would otherwise remain uncultivated and harbour insect-pests, such land could be utilized with great advantage by growing turmeric and ginger. Trees (such as mangoes, jack, liches, etc.) are themselves benefited, if the land underneath is kept cultivated. This is one of the principal preventive methods that should be employed in combating orchard-pests. Stiff clayey soils are not

suitable for any root-crops, but any soil which is not too stony, gritty or gravelly will do for growing these crops. The cultivation for both the crops is similar. In putting down virgin soil under trees for the first time under turmeric or ginger, it is desirable to plough up the land in October or November, *i.e.*, after the rainy season is over and when the land is still in a fit state for ploughing. One ploughing and cross-ploughing with an improved plough, or a thorough spade-cultivation, followed by laddering should be a sufficient coldweather preparation for these crops. In April, *i.e.*, after the first shower of rain in the hot weather, another ploughing followed by cross-ploughing and laddering, will render the land fit for planting the bulbs of ginger or turmeric. These should be planted nine inches apart in the line, and the lines should be 25 or 30 inches apart. About two maunds of turmeric or ginger-seed bulbs are required for planting an acre. When the plants have come up and before the approach of the regular rainy season, ridging or earthing should be done along the natural inclination of the land, to exclude water from the immediate surroundings of the plants. Water should be let out from the field whenever there is any accumulation, or such land should be chosen, whence water flows out naturally and readily. Manuring is scarcely ever done for ginger or turmeric, but a maund of ashes and three maunds of oil-cake per acre would benefit both these and the trees under which they are grown. If manuring of crops grown under trees is neglected, the trees themselves are injured in the long run by growing crops under them. The manuring should be done soon after planting and before earthing. Two hand-weedings or hoeings are necessary, one in July and the other in September. The root should be lifted up after the leaves have completely withered, *i.e.*, in December and January. The small outgrowths of the roots should be set apart for seed. These before being planted in April or May should be kept under a heap of damp straw to hasten sprouting. The rest of the turmeric roots should be cut into two, if too fat, dried and then boiled in water mixed up with cowdung. As soon as the water begins to boil, the boiler is to be taken down from the fire, and the turmeric taken out afterwards and spread out in the sun. The heap should be stirred and turned two or three times a day, and when the smaller sections have become quite dry, they should be separated out, leaving the fatter sections to dry for another day or two. Daily, in the evening, the turmeric exposed to the sun should be rubbed, the rubbing making the roots clean and smooth.

The outturn of turmeric (boiled and dried) comes to about 16 maunds per acre, and of fresh ginger about 50 maunds, but as much as 50 and 150 maunds per acre respectively have been sometimes obtained. The ginger can be sold off in the undried state at about Rs. 4 per maund, while dry turmeric may fetch as much as Rs. 5 per maund. The cost of cultivation comes to about Rs. 50 per acre, in either case.

## CHAPTER LX.

SUGARCANE (*SACCHARUM OFFICINARUM*).

(Sugar-yielding plants ; Superior foreign varieties of sugarcane ; Superior indigenous varieties ; Yield of *gur* , Acreage ; State of the Indian sugar industry ; Conditions of success ; Use of phosphates ; Seedling-canes ; Preservation of cuttings , Topping ; Pitting , Planting ; Pickling of cuttings ; Rotation ; Manuring ; Irrigation ; Other operations ; Harvesting , Cost of cultivation and *gur*-making ; Chewing canes ; Pests , Crushing mills ; Mr. Hadi's method of *gur* and sugar-making.]

THE sugarcane plant is indigenous to India, and it yields a higher proportion of sugar than any other plant, beet coming next to it, and the date-palm after beet. The maple-tree of America may be regarded as fourth in importance.

**Foreign canes.**—Though indigenous to India, the best varieties of sugarcane are now generally found in those countries where European and American planters have been employed in its cultivation. Even the Chinese cane, called by Dr. Roxburgh, *Saccharum Chinensis*, is said to be a better yielder and hardier than the ordinary variety of Indian canes. The best varieties of Mauritius canes are the Big Tanna, Port Mackay, Lousier, Iscambine, Bamboo, and Bois Rouge. The best Queensland cane is the Rappoe or Rose Bamboo, which is a very hardy variety, though yielding the largest proportion of cane-sugar. In the Straits Settlements the Striped Bourbon and Yellow Mauritius are considered the best canes, though for chewing purpose the Otaheite is preferred to all others. For weight and length the Tanna variety excels the others. Of good seedling canes may be mentioned White Bamboo, Singapore, Bourbon and Demerara. The standard cane of the Barbadoes is the White Transparent ; but a seedling cane lately established excels this and all other good varieties of canes grown in Barbadoes, such as the Bourbon, the Jamaica, and the Queensland Creole. The White Transparent yields about 5,400 lbs. of *gur* and 4,500 lbs. of cane-sugar per acre in low-lying black soils. The Bourbon cane, which yields very good results on high red soils, gives only 1,000 lbs. of *gur* and 840 lbs. of cane-sugar per acre grown on low-lying black soils. Some seedling canes which has been lately established in the West Indies suit both high and low soils, the average yield exceeding 6 000 lbs. of *gur* per acre. The average obtained on low-lying black soils is still higher. A red Jamaica cane has been successfully introduced in Bihar, and it promises better than the indigenous Samsara.

**Indigenous varieties.**—The names of the indigenous varieties of sugarcane are very numerous, but they do not necessarily indicate distinction. Their habits must be closely studied before they can be classified into distinct groups. Here and there canes equal to the best found in many parts of the world are to be seen, and the yield of raw sugar from them also is equal to the best yield obtained

anywhere, so that there is no necessity for going out of India for good seed. There is, in fact, risk of importing diseases with seed canes from Java, Mauritius or West Indies. The following varieties have been grown at the Sibpur Farm—Samsara, Bombay, Khari, Chittagong-Patnai, Saharanpur, Poona, Dhalasundar, Mongo, Malohi, Puri, Bagdia, and Baghi. Of these, Chittagong-Patnai, Samsara, Bombay and Khari sugarcanes have been found to be the best. The first two are good chewing varieties, and the last a very good variety for planters to grow as it is thick-skinned, and not so subject to the attack of jackals and insects, and it is a free ratooner. After four years the yield falls off rapidly, and as it is not safe to keep sugarcane growing on the same land for more than three or four years, the ratooning should not be carried on beyond the fourth year, after which insect and fungus pests predominating, the crop becomes a source of infection to the neighbourhood. The Chittagong-Patnai variety, though producing fatter and longer canes, is very much more subject to the rind fungus than the Samsara or other Bengal varieties. The Bombay canes, which were probably derived from Otaheite, are softer and richer in juice. The *gur* from it is darker in colour than *gur* from Samsara canes, and the crystals of larger size. On the whole, therefore, it is best to grow Samsara or the Dhalasundar of Dacca, if the attention and care necessary for growing a superior variety can be bestowed, or else to grow the Khari cane. For low-lying *bil* lands, which remain under three or four feet of water for a month or more, a variety of canes known as *Kulera* or *Jali-ák*, in Faridpur, can be grown. The straw-cane and the grass-cane of Bombay, and the red sugarcane of Assam are also suitable for swampy lands. Besides the Samsara and the Chittagong-Patnai sugarcane, other superior chewing canes are the white or red canes grown in Bogra, Khulna and Dacca, which, owing to the climate of these districts or on account of special facilities for irrigation, often grow to remarkable size, sometimes attaining a length of 20 ft. and a girth of six inches. The produce of raw sugar has been, in some instances, 7,000 to 8,000 lbs. per acre, quite equal to the highest obtained in the West Indies. The Madras Paunda of the United Provinces, the Poona and the Saharanpur sugarcane are other good varieties. The Chinia or Chini cane of Bhagalpur and Patna is another good chewing variety suitable for Bihar districts. In some districts of Western Bengal a hardy variety of sugarcane known as Uri, sends out arrows and seeds very freely. Other hardy varieties, suitable for agriculturists are Kajli, Puri and Katari. The Puri variety grown in Orissa Division produces canes somewhat more slender than those produced by the Kajli variety which is grown by cultivators all over Bengal. The canes of both these varieties are somewhat thicker than Khari canes, but they are not such free ratooners nor can they stand water-logging so well as the Khari, though like the Khari they can be grown without irrigation. The chewing canes make better jaggery than the hardier varieties. The Samsara or Dhalasundar cane makes

the lightest coloured jaggery, though the crystals are somewhat smaller than the crystals of the jaggery or *gur* made from Bombay or Khari sugarcane.

**Yield of gur.**—The average yield of *gur* under a proper system of cultivation and manuring such as is practicable on a large scale by planters, can be put down at 3,500 lbs. per acre, though as much as 8,000 lbs. per acre have been often obtained in Poona and Burdwan. From Samsara and other superior varieties, by very careful cultivation and high manuring 8,000 lbs. per acre may be sometimes obtained, but from Khari and the hardy varieties 3,500 lbs. of *gur* per acre can be obtained at a comparatively small cost. The average produce of *gur* of the whole country has been estimated at a ton (2,240 lbs.) per acre, and the maximum yield obtained by cultivators is three tons. The Bengal cultivator's ideal average is 60 maunds or 4,800 lbs. per acre, *i.e.*, a maund of *gur* per *cottah*.

**Sugar growing localities.**—The area under sugarcane in the whole of British India has been estimated at 2,500,000 acres, and in Bengal, including Assam, at 700,000 acres. On the basis of 1 ton per acre, we have about six crore maunds as the annual produce of *gur* in India, while the import of sugar per annum is great and increasing yearly. Mauritius and Java supply the largest proportion of sugar imported to India. Besides sugar there is a large import of molasses. The extension of jute cultivation has prejudicially affected the area under sugarcane.

**Soil.**—A mere enumeration of the principal sugar-growing districts in Bengal would lead one to infer, that all kinds of soils answer for growing sugarcane, including as they do, the rough Archæan soils of the Chota Nagpur Division, the old alluvium of Bihar, and the new alluvium of Eastern Bengal including low-lying lands in Faridpur. The best canes grow at the junction of old and new alluvia on the sides of streams and rivulets. These are red clay-loam soils specially rich in mineral matters. For growing the superior varieties of cane, the two principal considerations that should guide one in the selection of a site are : (1) Is the land close to water from which it can be easily irrigated ? (2) Is the land above inundation level and easily drained and yet level ? Some red soils of Burdwan, Birbhum and Kandi Sub-divisions of Murshidabad, though very light, are highly valued for growing sugarcane. Probably they contain a high proportion of phosphorus. Phosphates are greatly valued for manuring sugarcane wherever European and American planters have taken to growing this crop. A very large proportion of the bones collected for export, in India, goes to the sugarcane plantations of Mauritius. If our cultivators will not use bones, they can at least prevent their being collected and taken away from their fields and from village golgothas. They do some good even when they lie about in the fields in a neglected condition.

Of course the effect of such an insoluble manure as bones, even when powdered is very slow and will be hardly seen unless an invigorating manure such as sulphate of ammonia or saltpetre, is used also. Even those hardy varieties of sugarcane that can stand drought and inundation and for which any soil seems to answer, ought to have phosphatic manure applied to them in addition to cattle-dung, oil-cake, saltpetre, or other manure that may be used. Where the land is annually renovated by silt, and where such land is utilised for growing an aquatic variety of sugarcane, no special manuring is needed or will be of much use.

The following yields of canes, juice and *gur* for two plots of Khari sugarcane grown at Sibpur were obtained in 1900-1901, one manured with the refuse of Cossipore Sugar Factory (*i.e.*, principally bone-charcoal) at the rate of 5 maunds, with saltpetre at the rate of  $2\frac{1}{2}$  maunds per acre added to it, and the other manured with 10 maunds of castor-cake per acre. The crushing of the canes was done in both cases with a two-rollered Behia mill :

|                                 | Bone-charcoal<br>plot.                  | Castor-cake<br>plot.                    |
|---------------------------------|---|---|
| Yield of canes per acre ..      | 483 maunds.                             | 405 maunds.                             |
| Yield of juice .. ..            | 59 per cent. of the<br>weight of canes. | 56 per cent. of the<br>weight of canes. |
| Yield of <i>gur</i> per acre .. | 38 maunds.                              | 37 maunds.                              |

It should be noted here that the crushing of the canes out of the bone-charcoal plot was done a month too early, and had it been done at the same time as the other, this plot would have probably shown still better result. The value of phosphatic manures for sugarcane is so well recognised, that confirmation of the fact is hardly needed.

**Seedling canes.**—New and hardy varieties of canes are obtained by Dutch planters in Java and elsewhere by a laborious and costly process of selection. The following directions for growing sugarcane from seed are given by the Dutch firm of Messrs. Erdmann and Sielcken of Samarang, Java :—

“ The capacity of producing fertile seed is not confined to some single varieties of sugarcane. Every variety examined up to now could produce germs, though some varieties yield more and stronger seeds than others. One of the chief difficulties in sowing cane is to cut the ‘ arrow ’ just at the time of its seeds being ripe and not yet blown away by the wind. The criterion is found to be in the topmost leaflet of the cane just under the arrow. As soon as this begins to wither, the seed is ripe and the arrow should be cut. The separate small ears are stripped and laid flat in a wooden box, filled with a mixture of sand, clay and well-rotten pen manure. The ears are not to be covered with earth, and the box should be placed in the sunshine and kept constantly moist by watering it with a common watering pot having a very fine rose in order not to disturb the minute seeds.



“ After five to seven days the seeds will germinate, and small plants, just like young grass, will come forth.

“ In order to watch the growth of the young germs, it is good to place a mark near every one, which enables one to find them back easily.

“ If after eight days the arrow did not yet germinate, it is a sign that the seed was not fertile, as beyond that time no more germination will take place. As soon as the young plants have reached a height of three to four inches they are transplanted into big flower pots, filled with the same soil-mixture as referred to above. The pots are placed in the full sunshine and kept constantly moist, as the plants require a rich soil, much water, and much sunshine. After a few weeks, when they are 1 to 1½ feet high they are brought over into the field and treated just as ordinary sugarcane.

“ According to Benecke’s and Soltwedel’s researches sugarcane seed loses its germinating power within six weeks. Therefore everything has to be prepared beforehand in order to allow the sowing to be started immediately after the arrival of the seeds.

“ It ought to be well understood that the only purpose of sugarcane sowing is the raising of a new variety with possibly better qualities than the ordinary existing ones and not the change of the old way of planting with tops into planting from seed.

“ From thousands of young plants raised in the horticulturists’ nurseries, only those are picked which look promising; the others are destroyed. The picked plants are tested, and if some of them prove to be of superior quality they are propagated in the usual way by cuttings.

“ The few planters in Java, who have their estates partly or entirely under seedling canes, do not sow their estate, but plant it with cuttings from canes, the ancestors of which have been raised from seed.”

**Cuttings.**—Canes that are chosen for seed, that is for cuttings, should be ‘topped’ when they are mature; in other words, the topmost bud should be cut away, that the nourishment may flow to the lateral buds and develop them to a sprouting condition. The sprouting is helped in this country by keeping the cuttings in a cool pit, by putting a layer of damp straw and ashes at the bottom of the pit and then arranging on this successive layers of cuttings and wet straw and ashes until the pit is filled, when over the last layer of ashes and straw, earth is put on, and the whole allowed to remain for a week. After this, the cuttings will be found to have sprouted and rootlets come out of the knots. The cuttings, though ready for planting out, may yet be kept for a month if the covering of earth is removed from the pit, and the cuttings kept in a standing position in the pit with a covering of straw and ashes, which should be kept damp by sprinkling of water as occasion arises. The top two feet of canes make the best cuttings, but the topmost bud must

be rejected beforehand as already directed. The practice prevalent in most parts of India of utilising for cuttings the very topmost portion only is based on a false idea of economy. If topping is done, there is no difficulty in selecting the most promising cuttings for planting. In any case, that is, whether topping is done or not, the healthiest and best canes should be chosen for seed, and the top two feet of these used. As the bud occurs on the upper side of a knot, and the nourishment is derived from the portion of cane above this knot and below the next knot above it, cuttings should be so made that there may be no superfluous cane below the lowest node and that a whole joint above the highest bud may be included. Each cutting need not have more than three buds, and if they are made after sprouting has taken place subsequent to topping, one can be almost sure of three buds going to every cutting. With regard to the sprouting of lateral buds either in the cane while it is still standing or after planting the whole cane in the soil, it should be noted that the topmost bud of the cane sprouts first, then the next one below it, and so on towards the lower end of the cane. But if the cane is cut up into sections and planted, every bud at the upper end of each cutting will come out first simultaneously, and then the next ones towards the thicker end, and so on until the third or fourth bud, *i.e.*, as many as are left on each section, finishes sprouting. So although the planting of cuttings along a line is almost continuous, whole canes or sections which are too long should not be planted, as is done in many parts of India, but to make sure of at least one healthy and uninjured bud per cutting it is best to have each cutting about nine inches long.

**Planting.**—Sugarcane harvesting and sugarcane planting can proceed for eight months in the year, *viz.*, from September to April; but the best time for harvesting sugarcane is December to February, and the best month for planting the cuttings is February. Harvesting and planting in September and October, one gets very high price for the canes during the Pujahs, and sprouting of the cuttings also takes place freely at this season, as the heat and moisture are both sufficient to help the growth of the young plant. But the cold weather that follows retards the growth, and makes the nodes of the canes very short. From November to May as many as twelve irrigations may have to be given to keep the plants in proper condition. From February the growth is again normal, and there are no short nodes formed, but, on the whole, the time and expense from September to February are wasted, and the only advantage in doing the planting in September or October is the obtaining of a crop of chewing canes during the Pujahs when they fetch a very high price in a town like Calcutta. Planting in November to January, the sprouting is most tardy, and most of the cuttings may perish before they have time to sprout through the attack of white-ants or from the caking of the soil preventing the sprouts from forcing their way upwards. Cuttings planted from

November to January do not make any more progress than those planted in February. If harvesting is done in December and January which months are as well suited as February for making high class *gur*, the seed-cane may be topped and left to sprout on the fields, or they may be made into cuttings and stored in pits in the manner described before. The actual planting should be put off till February. By planting in March one saves one irrigation, but the growth from cuttings planted in February is better. March planting answers where, as in Bihar, Chota Nagpur, etc., this month is cool. The conditions as to temperature prevailing in the delta of the Ganges are not the same as those prevailing in the hills, or in the rocky western districts of this Province. But the principle of planting in mild temperature and after the cold weather has well passed off, but a good while before the rains set in, may be followed in every locality. Planting in May or June is very risky, except in free and gritty soils, as water-logging or even heavy rainfall, when the plants are still very short, is injurious to sugarcane as to most crops. Sugarcane, like maize or *juar*, is benefited by heavy rainfall if it commences after the plants are about a foot high.

Various *modes of planting* are adopted. In Mauritius where high winds prevail, planting is done in deep trenches or in holes, to give the canes a good support at the base. After the land has been ploughed up, holes or continuous trenches are made about a foot deep and  $4\frac{1}{2}$  to 5 ft. apart from centre to centre from line to line and the cuttings are planted in the lines with an interval of nine inches between two lots of three cuttings planted in each spot in the form of an arrow. Three inches of loose soil are put in the holes or trenches, and these are watered, and then the cuttings are planted and another three inches of earth put on. When the plants are a foot high, the land is levelled, that is, the trenches are entirely filled up, and a second earthing makes shallow trenches between the rows of plant. At each of the two earthings a measured quantity of powdered manure (consisting usually of human or animal excreta and bone-meal or oil-cake) is applied at the bottom of each clump, *i.e.*, about a quarter of a pound each time.

In Bengal, the cuttings are planted in shallow trenches (about 6 inches deep) made with *kodialies*,  $1\frac{1}{4}$  to  $2\frac{1}{4}$  ft. apart. This is much too close planting, involving the use of *kodialies* for hoeing, earthing and trenching. The system prevalent in Queensland, New South Wales and Fiji Islands, seems worth adopting in this country. The cuttings are planted in double rows, 6 ft. apart, the two rows close together being only 18 inches apart. This is equivalent to planting single rows 3 ft. apart. But a distance of 3 ft. from centre to centre of lines of plants does not allow interculture by bullocks; while a distance of 6 ft. from centre to centre does allow such interculture being practised. In working on a large scale the employment of hand-tools should be avoided as much as possible, and bullock-power substituted. The trenches may not be so straight, there may be some injury done by bullock treading on plants, but

these are not of much consequence, as the saving of labour and time effected by the employment of proper farm-inplements instead of garden-tools, is enormous. The 18-inch trenches can be made with the double mould-board plough the cuttings planted lengthwise in two rows at the two sides of the trenches, say three cuttings being planted in every 4 ft. of length in each row, and the trenches after irrigation being filled up by splitting of the ridges in between with mould-boards. The subsequent hoeings and earthings can be done with the Hunter hoe, when the planting is done in the above described manner. Planting in this way, nearly 12,000 cuttings are required per acre (theoretically 10,890), and as Bengal cultivators use about 2 *kahans* ( $2 \times 1,280$ ) of cuttings per bigha (one-third of an acre), there is really not much sacrifice of space made for effecting saving in the cost of labour. The growth of canes is also healthier under such a treatment, as the plants get more air and sunlight throughout the period of growth and a proper elaboration of sugar is the consequence, *i.e.*, a *gur* richer in cane-sugar crystals.

**Pickling.**—As sugarcane is very much subject to the attack of insect and fungus pests, it is important to sow the cuttings or seedlings after pickling, *i.e.*, after smearing each lot of cuttings or seedlings with a mixture of insecticides and fungicides. But as these substances even when used in a dilute form are generally injurious to vegetable cells, it is best to dry up the substances with which the cuttings or seedlings are smeared *immediately afterwards* with such manurial substances as have some effect in keeping out insects also. Thus half a pound of powdered sulphate of copper is mixed up with 100 lbs. of hot water and if 8 ounces of powdered white arsenic with 1 lb. of lime are added to the vat containing the sulphate of copper solution, the sugarcane cuttings can be dipped in this insecticidal and fungicidal mixture, immediately before planting, but the cuttings after being dipped in this liquid mixture should have a coating of powdered castor-cake (100 lbs.), ashes (2 lbs.) and soot (1 lb.), that the growth of the young plant may be helped by these manurial substances. If sulphate of copper is not available 1 lb. of alum may be used in place of  $\frac{1}{2}$  lb. of sulphate of copper for making the fungicidal solution. Half an ounce of asafœtida may be mixed with every 100 lbs. of the fungicidal solution, as the strong smell of asafœtida keeps out most insects. The mixture should be used up the same day that it is made. The quantities mentioned will suffice for pickling cuttings required for 1 acre of land.

**Rotation.**—Except in the case of a ratooned variety, sugarcane should not be grown on the same land more than once in four years. It is best to grow sugarcane after a preparatory crop of Dhaincha (*Sesbania aculeata*), Sunn-hemp (*Crotolaria juncea*), or Barbati (*Vigna catiang*), cut down when in flower, in August. A crop of potatoes may be grown from October to February, and the land



Sulphate of potash costs about the same. Superphosphate of lime would cost about Rs. 4 per maund.

**Subsequent operations.**—When the land has been thoroughly prepared by deep cultivation, harrowing and rolling, and cuttings planted after trenching and watering, and when manuring has been done, the intervals between the plants should be given one hoeing with the Hunter hoe after each watering. From March to June four irrigations may be needed in Bengal. In Bengal sugarcane is irrigated from one to eight times, but in the Bombay Presidency 20 irrigations are quite common. Mr. Mollison actually recommends 34 irrigations giving 50 inches of water in addition to that derived from rainfall (p. 119 of Vol. III of the Text-Book on Indian Agriculture). But the need for irrigation depends mainly on the variety of sugarcane grown, the time of sowing and the locality. If a coarse variety (such as Khari or Kajli) is grown, and if the sowing is done in April (after irrigation), one subsequent irrigation will be found sufficient to bring the plants on in most parts of Bengal. But even in this case two or three hoeings and one hand-weeding will be found helpful during May and June, after which nothing need be done till harvest time. To break up the surface pan it is important to do a hoeing after each irrigation: the first hoeing should be with hand-tools. If trench-irrigation is practised no caking takes place at the foot of plants and constant hoeing is not required. The superior varieties of canes that have soft skins are particularly benefited by tying. The tying protects the canes from the attack of insect and fungus-pests and jackals, and the growth is more uniform and clean. The opposite practice of ‘trashing,’ or tearing away the older leaves as the canes grow, probably accounts for the ravages of fungus diseases in European and American cane plantations. The scars formed by trashing offer excellent resting places for spores of fungi, while the enveloping of canes from below upwards with the leaves, as practised in this country, probably offers a great protection not only against the spores of the fungi resting on the canes, but also against the insects laying eggs on the canes. It is said that tying increases the yield of *gur*, but this point must be established by repeated comparative experiments. But so far the results of experiments made at Sibpur and Burdwan confirm the current belief that tying increases the yield of *gur*. The operation costs about Rs. 6 per acre, but as 3 maunds of *gur* more were obtained in these experiments, the cost is more than made up by the outturn. From July to October, the canes should be tied twice, the tying being so done that the canes may also support one another, and not lodge in the soil.

**Harvesting.**—When there is little moisture in the soil, and when the top leaves have begun to wither, the canes should be considered fit for cutting. The practical farmer would also judge from the taste of the canes whether they are sweet enough to be cut. If too much time is wasted in judging whether canes are quite ready for cutting

or not, the excessively hot and dry weather may come on during the progress of the harvest operations, and then the yield of juice and the quality of the *gur* turned out will be inferior. December to February is the proper season for harvesting canes in Lower Bengal; but if owing to late rains, or late sowing the plants look quite vigorous and green in December, and if the canes do not taste sweet enough, one must wait for a fortnight or perhaps a month, before commencing cutting the canes. The canes should be cut with *lodadies* close to the ground, rather two or three inches underground. If stumps are allowed to be left on the ground, these send out in the case of ratooned canes, poor shoots which yield a poor return next year. Sometimes from these prominent stumps flower-stalks come out, but owing to their want of strength, the arrows cannot come out of them, and they become smutted and dried up. This smutting of flower-stalks in the case of the Khari sugarcane is said to do no harm, as shoots coming afterwards from deep down the earth grow up vigorously and continue to grow side by side with the smutted flower-stalks, apparently unaffected by them. But it is never safe to allow a luxuriant growth of parasitic fungus, as a fungus may sometimes prove very injurious though at other times it does not seem to do any practical harm. Lodged canes contain a large proportion of glucose. More than 0.5 per cent. of glucose should be avoided. Immature canes also contain a higher proportion of glucose, and also canes which are diseased specially with the rind fungus. Canes should be cleaned with water and put on a piece of mat near the crushing mill to avoid dirt.

**Cost of growing an acre of Sugarcane.**—In the following estimate made out for Bengal conditions, the wages have been calculated at the rate of 4 annas, and the most approved system only taken into account.

|  | Rs. | A. | P. |
|--|-----|----|----|
| Harrowing the field after lifting potatoes .. .. .                                       | 0   | 6  | 0  |
| Rolling .. .. .  | 0   | 6  | 0  |
| Trenching with double mould-board plough .. .. .   | 0   | 12 | 0  |
| 12,000 cuttings at Rs. 2 per 1,000 .. .. .   | 24  | 0  | 0  |
| Cost of getting the cuttings sprouted in a pit (if previous topping is not done) .. .. . | 1   | 8  | 0  |
| Cost of pickling the cuttings .. .. .  | 5   | 0  | 0  |
| Two maunds of apatite (i.e., 10 maunds per acre once in 5 years)                         | 6   | 0  | 0  |
| Castor-cake 15 maunds .. .. .  | 30  | 0  | 0  |
| Saltpetre, 2½ maunds .. .. .   | 15  | 0  | 0  |
| Cost of planting cuttings (24 men) .. .. .   | 6   | 0  | 0  |
| Cost of filling up blanks, a month afterwards .. .. .                                    | 0   | 8  | 0  |
| Cost of applying the manure before the two earthings .. .. .                             | 4   | 0  | 0  |
| Cost of three irrigations (February, March and April) .. .. .                            | 9   | 0  | 0  |
| Cost of one irrigation in November (if necessary) .. .. .                                | 3   | 0  | 0  |
| Cost of one hand-weeding in March .. .. .  | 4   | 8  | 0  |
| Cost of one hoeing with Hunter hoe in May .. .. .  | 0   | 12 | 0  |
| Cost of two more hoeings (earthings) with Hunter hoe, June .. .. .                       | 1   | 8  | 0  |
| Two tyings .. .. .   | 6   | 0  | 0  |

|   | Rs. | A. | P. |
|---|-----|----|----|
| One hoeing with <i>kodalies</i> (15 men) after the November irrigation ..             | 3   | 12 | 0  |
| 60 men employed in cutting and stripping the canes (distributed over 12 days) .. .. . | 15  | 0  | 0  |
| One man employed for 12 days at the crushing mill ..                                  | 3   | 0  | 0  |
| One man employed for 12 days for driving bullocks ..                                  | 3   | 0  | 0  |
| Hire of 2 pairs of bullocks for 12 days .. .. .                                       | 6   | 0  | 0  |
| One man clarifying and boiling the juice for 12 days ..                               | 3   | 0  | 0  |
| Fuel for the first 2 days .. .. .   | 1   | 0  | 0  |
| Quick-lime, phosphoric acid, and litmus paper .. .. .                                 | 1   | 0  | 0  |
| Cost of employing a man for making sugar and assisting in <i>gur</i> -making .. .. .  | 3   | 0  | 0  |
| 80 earthen pots .. .. .   | 4   | 0  | 0  |
| Interest and depreciation .. .. .   | 2   | 0  | 0  |
| Rent of land .. .. .  | 3   | 0  | 0  |
| TOTAL Rs.   | 166 | 0  | 0  |
| <i>Outtura</i> —40 maunds of native white sugar at Rs. 5 ..                           | 200 | 0  | 0  |
| 5 maunds of clean molasses at Rs. 2 per maund .. .. .                                 | 10  | 0  | 0  |
| TOTAL ..  | 210 | 0  | 0  |

If *Chewing Canes* are sold, 20,000 canes sold at 1 pice each, would mean a gross income of about Rs. 300 per acre. In this case the cost of *gur*-making is saved, but for growing superior varieties, a little more expenditure on account of irrigation, hoeing and tying the canes, will bring up the total to about Rs. 150 per acre without the cost of *gur*-making. The cost after the first year in the case of ratooned varieties, is less by about Rs. 30 per acre. In Bihar, where wages can be calculated at 2 as., the cost of growing an acre of sugarcane may come to only about Rs. 100 or even less.

For killing jackals and pigs, a gun should be in constant use in a sugarcane plantation. Dogs may be also kept for the same purpose, specially as they may prove very useful against thieves.

**Crushing of Canes.**—With a two-rollered Behia mill, one gets only about 58 per cent. of juice out of coarse canes (such as Khari and Kajli) and 68 to 69 per cent. out of Samsara and Bombay. With a three-rollered Behia mill one gets about 64 per cent. from the coarser canes, 69½ per cent. from Samsara, and 71 per cent. from Bombay canes. The former costs Rs. 80 and the latter Rs. 100. A still higher yield (about 72 per cent. in the case of coarse canes) is obtained with the help of a horizontal roller-mill worked by steam-power. The three-rollers of this mill are each 6 or 7 ft. long and 30 to 32 inches in diameter, and a large quantity of sugarcane can be thus put in at once into these rollers, while only three or four canes can be fed into the Behia mill at a time. The roller mills set up in the Bamra State (Sambalpur) and at the Begum Serai Indigo Factory in Bihar (which have been supplied by Messrs. Jessop & Co. of Calcutta) and which are worked by a 6-H. P. engine, are capable of crushing 20 tons of sugarcane per day, while a



crop of 20 tons of sugarcane (which is usually obtained out of an acre) requires 10 to 12 days' crushing with the Behia mill. With the help of a shredder which divides up the canes longitudinally before they are crushed, a higher percentage still than 72 is obtained. Sugarcane contains naturally 85 to 91 per cent. of its weight of juice, which is the maximum possible yield, but no mechanical pressure can be applied to get the whole of the maximum 91 per cent. out. By the diffusion process, which consists in getting the sugar from shredded canes extracted by means of very hot steam forced through cylinders containing the shredded canes, almost the whole of the sugar is got out of the canes. The percentage of juice that is obtainable from the cane does not altogether depend on the crushing mill. A cane which contains 16 per cent. of fibrous matter, and 18 per cent. of cane-sugar, would yield only 45 to 50 per cent. of juice, while one containing 10 per cent. of fibrous matter and 18 per cent. of cane-sugar, will yield about 70 per cent. with the same crushing appliance. The rind and other fibrous matters act like a sponge in retaining the juice. By getting rid of the rind, one gets a higher yield of juice. There may be considerations that may determine a planter to prefer a hardy fibrous variety to a soft cellular variety, such as the Samsara or the Otaheite cane, and in such a case the use of a decorticator or at least a shredder before crushing is advisable. But as the horizontal mill, the shredder, or the decorticator, would cost more money than our cultivator could afford to spend, these improvements are meant for planters and capitalists, who may wish to launch out into sugarcane planting. Usually canes are passed twice through the mill to get as much juice out as possible.

Whether steam-power, bullock-power, or buffalo-power is employed for crushing canes, it should be borne in mind that too great a speed or jerky motion of the rollers, results in diminished yield. This precaution is specially needed where steam-power is employed for working the mills. A roller of 30-inch diameter should make only about four revolutions per minute. Modern appliances for crushing sugarcanes, and for clarifying and boiling the juice, are obtainable of Messrs. Pott, Cassels and Williamson and Messrs. Watson Laidlaw & Co., both of Glasgow, of the Sangerhauser Engineering Co., Ltd., of Berlin, and of Messrs. Krajewski & Pesant Co., 32-34, Broadway, New York.

*Mr. Hadi's method of gur and sugar-making.*—Most important improvements have been recently introduced in *gur* and sugar-making by Mr. S. M. Hadi, M.R.A.C., till recently Assistant Director of Agriculture in the United Provinces. As these are capable of being put into practice by small capitalists, they are well worth learning, and the Agricultural Department of the United Provinces has made suitable arrangements for teaching the methods. A short description of these methods will not be out of place here, though without practice it is not possible to learn them to any advantage.

**Clarifying.**—The clean bundles of cane are crushed within 24 hours of cutting, the crushing commencing at 4 A.M., and the boiling soon afterwards. The juice, as the canes are crushed, falls through a strainer into a kerosine tin provided with an iron handle, and as each tin gets filled, it is removed at once to the boiling shed and put in the copper clarifier, or if the clarifier is full, in the reserve tank above it, which is in contact with the flue running up from the underground oven to the chimney. The reserve tank may be of galvanized iron. Twenty kerosine tinfuls (about 10 maunds) is a full charge. As the juice gets heated in the clarifier, the scum rises to the top, which is not to be touched until it splits. In the meantime one pound of pink *saji* (crude carbonate of soda) should be boiled in water, cooled and strained, and one pound of *bhundi* (ladies' finger) stalks should be washed, pounded and immersed in clean water, and afterwards the mucilage inside the stalks rubbed out between the hands till the water becomes thick and mucilaginous. When the scum in the clarifier has split, half the *bhundi*-water should be put in the clarifier and the scum should then be removed. The remaining half of the *bhundi*-water should be then put in, and the *saji*-water also put in afterwards. The scum should be continuously removed, and if the liquor does not become quite transparent by this time, cold water should be sprinkled in the clarifier and more *saji*-water or *saji* and *bhindi*-water both added, until the liquor becomes quite clear. Instead of pink *saji*, the more impure dark *saji* may be used, and better still bicarbonate of soda, about 3 to 4 drams (a little over 1 tola) of the soda being sufficient for clarifying a full charge of juice (10 to 12 maunds). If the juice is poor in quality or obtained from stale cane, it is desirable to use about 3 pints of limewater along with *saji*-water after the liquor has become transparent. The limewater should be added gradually, continuing so long as the liquor does not show any floating particles. As soon as these particles appear, the liming is to be stopped.

**Concentrating.**—As soon as the juice in the clarifier has acquired the desired degree of brilliancy, the tap should be opened and the liquor allowed to flow into the concentrator through a double blanket filter placed over the concentrator. The liquor in the concentrator is to be skimmed from time to time for removing the froth that rises on the liquor. When the liquor has acquired the requisite consistency in the concentrator, which is to be determined from experience, it is to be run into the third vessel also situated on the oven, called the evaporator, which is divided up into several compartments. Care should be taken that the sugar in the evaporator does not get burnt into caramel. A little skimming will be necessary when the liquor is passing through the different compartments of the evaporator. At the last compartment ebullition will be very violent, and if there is fear of the *rab* overflowing, a few drops of castor-oil mixed with *saji*-water or a little *ghi* may be thrown

into the boiling mass and the liquid will subside at once. The oven has to be fed very carefully that the *rab* may not get burnt. Each vessel, the clarifier, the concentrator and each compartment of the evaporator is to be constantly charged with liquor, and in the absence of liquor, with water, that the vessels may not get spoilt with heat. The boiling of the juice into *rab* is a work of experience and it must be learnt by practice.

**Airing.** -As soon as the boiling liquor in the evaporator has thickened sufficiently, it should be let out into an earthen *gamlá* or *nánd*. As soon as about 20 or 30 seers of *rab* have accumulated in the earthen vessel, it should be removed from its place and another vessel put in its place, and the *rab* in the first subjected to the process of *airing*. This is done with a ladle, by stirring and letting fall the liquid from a height of 2 feet, until the liquid is sufficiently cool to be touched. Experience is needed for carrying out this operation also with success. If airing is not done sufficiently, crystallization will be imperfect and slow; if it is overdone, the crystals will be of small size.

**Separation of Sugar.** -The *rab* is to be then put in *kalsies* and, when quite cool, the *kalsies* may be removed elsewhere, and after at least 10 days the contents of the *kalsies* are to be emptied into a centrifugal hydro-extractor such as that constructed by Messrs. Thomas Broadbent and Sons of Huddersfield, England, under Mr. Hadi's instructions. The cost of each machine is £25, and the freight and other charges are about Rs. 10 extra. Messrs. Macbeth Brothers of Calcutta sell this centrifugal machine for Rs. 425. Before the machine with the *rab* is put in motion, a liquor consisting of molasses (half a seer) and bicarbonate of soda (one dram) well mixed together, should be put over the *rab*, and then the machine turned by four labourers at full speed. The molasses will go through the *rab* and the wire gauze of the machine and come out, while the white sugar will adhere to the sides of the machine. To make the sugar whiter, a warm decoction of *riṭha* or soap-nut (*Sapindus mukossī*) is sprinkled from time to time over the *rab* while the machine is turning. To prepare the decoction about 1 seer of *riṭha* should be pounded and thrown into 8 seers of water which should be then boiled. The use of the bicarbonate of soda and the *riṭha*-decoction makes the sugar perfectly white like sugar from European factories. It should be then taken out and ground lightly with a wooden roller, dried in the sun, and passed through a sieve.

## CHAPTER LXI.

## THE DATE-SUGAR.

[Extracts from Westland's report on the Date-sugar industry of Jessore; the Khandwa experiments.]

THE following account of the date-palm and date-sugar, taken from Westland's Report of the Jessore district, will give some idea of the great value of the date-palm as a source of sugar supply. There are forests of date trees in many parts of Central India, the Central Provinces and Madras Presidency, and some experiments are already in progress.

“ One of the most important industries in the district of Jessore is the cultivation and manufacture of date-sugar. There are so many people who derive from sugar all that they have, above the mere necessaries of life, that it may be considered that the sugar cultivation and trade is the root of all their prosperity. In a statistical table prepared in 1791, we find it recorded that 20,000 maunds was the annual produce of the sugar cultivation, and that of this about half was exported to Calcutta. In these later years the date-sugar has almost entirely driven away the cane-sugar from the fields as well as from the market. European factories began to be set up in the district, and it was these factories that gave such impulse to the trade. The first sugar factory in the country was at Dhoba, in Burdwan, a little below Nuddea, and it was erected by Mr. Blake. When his success began to diminish, he changed the business into that of a company, from which he gradually withdrew. This Dhoba Sugar Company established a factory at Kotchandpur, in Jessore, getting up English machinery and afterwards applied the English system to the Dhoba factory also. The history of the English sugar refinery is not a record of success. The truth was, that when they gave a great impulse to the sugar cultivation native merchants stepped in and appropriated all the trade which the factories had given birth to. The methods used by native merchants impart to the sugar all the purity which is required by the consumers. Had the European market remained open, the European factories might have competed with the native with some chance of success. But the duties levied in Europe appear to have been sufficient to prevent the development of the export trade, and the factories established at Cossipore and Bally, near Calcutta, appear, through the more favourable circumstances in which they were placed, to have monopolised the European market in Calcutta.

“ The ground chosen for date cultivation is the higher ground, that which is too high for rice to grow well, and the rent paid for such ground is at least three times that for rice land.\* The trees

---

\* High and low land are, however, equally suitable for date cultivation. In fact date trees should be grown in small hollows, where the rain water would collect and play round them, but too much of it would kill them. Planting should be done 3 yds. apart each way. Pits in which they are planted should be manured

are planted in regular rows, each tree being about twelve feet from its neighbour. If so planted and left for seven years before being touched, good healthy trees may be expected. Those who cultivate dates keep the land, specially in the cold season, perfectly bare of any vegetation, ploughing up the turf, so that the whole strength of the ground may expend itself in the trees. Of course, there are people who cultivate other crops upon the land where the date trees grow, and there are very many who have not patience enough to wait for the expiration of full seven years ; such people, however, lose in the end by their trees failing to give the same richness in juice that is obtained from trees more carefully tended. When the tree is ripe, the process of tapping begins, and it is continued each year thereafter. There are in the date-palm two series, or stories as it were, of leaves ; the crown-leaves, which rise straight out from the top of the trunk, being, so to speak, a continuation of it : and the lateral leaves, which spring out of the side of the top part of the trunk. When the rainy season has completely passed, and there is no more fear of rain, the cultivator cuts off the lateral leaves for one half of the circumference, and thus leaves bare a surface measuring about ten or twelve inches each way. This surface is at first a brilliant white, but becomes by exposure quite brown, and puts on the appearance of coarse matting. The surface thus laid bare is not the woody fibre of the tree, but is a bark formed of many thin layers, and it is these layers which thus change their colour and texture.

“ After the tree has remained for a few days thus exposed, the tapping is performed by making a cut into this exposed surface, in the shape of a very broad V, about 3 inches across and  $\frac{1}{4}$  or  $\frac{1}{2}$  inch deep. Then the surface inside the angle of the V is cut down, so that a triangular surface is cut into the tree. From this surface exudation of the sap takes place, and caught by the sides of the V, it runs down to the angle, where a bamboo of the size of a lead-pencil (*i.e.*, a narrow bamboo channel) is inserted into the tree to catch the dropping sap and carry it out as by a spout.

“ The tapping is arranged throughout the season, by periods of six days each. On the first evening a cut is made as just described and the juice is allowed to run during the night. The juice so flowing is the strongest and best, and is called “ *jiran* ” juice. In the morning the juice collected in a pot hanging beneath the bamboo spout is removed and the heat of the sun causes the exuding juice to ferment over and shut up the pores in the tree. So in the evening the new cut is made, not nearly so deep as the last, but rather a mere paring, and for the second night the juice is allowed to run.

---

at the end of each season and the ground ploughed up before and after the rainy season until they are fairly well grown up. Each palm, before it enters into its full adult stage, throws up about 15 to 20 offshoots which may be detached and transplanted. One per cent. of male trees for fecundating purposes would be quite enough. But male and female trees should be grown indiscriminately where obtaining of juice is the only object.

This juice is termed "*do-kat*," and is not quite so abundant or so good as the "*jiran*." The third night no new cutting is made but the exuding surface is merely made quite clean, and the juice which runs this third night is called "*jharna*." It is less abundant and less rich than the *do-kat*, and towards the end of the season, when it is getting hot, it is even unfit for sugar manufacture, the *gur* made from it (and also from day *jharna*) being sold simply as "droppings." These three nights are the periods of activity in the tree, and after these three, it is allowed to remain for three nights at rest, when the same process again begins. Of course, every tree in the same grove does not run in the same cycle. Some are at their first, some at their second night, and so on; and thus the owner is always busy.

"Since every sixth day a new cut is made over the previous one, it follows that the tree gets more and more hewed into as the season progresses, and towards the end of the season, the exuding surface may be, and often is, as much as four inches below the surface. The cuts are during the whole of one season made about the same place, but in alternate seasons, alternate sides of the tree are used for the tapping; and as each season's cutting is thus above the previous season's, and on the opposite side, the stem of the tree has, if looked at from the side, a curious zigzag appearance. The age of a tree can, of course, be at once counted up by enumerating the notches and adding six or seven, the number of years passed before the first year's notch. When they are forty-six years old they are worth little as produce-bearing trees. At first the size of the bared surface previous to the notching is about ten inches square; but it gets less and less, as the notches come to the higher and narrower part of the trunk, and I have seen old trees where not more than four inches square could be found. It is somewhat remarkable that the notches are almost always on the east and west sides of the tree, and very rarely on the north and south sides; also the first notch appears to be made, in by far the majority of instances, on the east side.

"As to the produce of one tree, one may expect from a good tree a regular average of five seers per night (excluding the quiescent nights). The colder and clearer the weather, the more copious and rich the produce. In the beginning of November tapping has begun. In December and January the juice flows best, beginning sometimes as early as 3 P.M., and it dwindles away as the warm days of March come. If the cultivator begins too early, or carries on too late, he will lose in quality and quantity as much as he will gain by extending the tapping season. But high prices begin in October, and there are not many who can resist the temptation of running into market with their premature produce.

"During the whole of the tapping season a good cultivator will keep his grove perfectly clean and free from jungle or even grass.

"So much then for tapping. The next process is the boiling, and this every raiyat does for himself, and usually within the limits

of the grove. Without boiling, the juice speedily ferments and becomes useless ; but once boiled down into *gur*, it may be kept for very long periods. The juice is therefore boiled at once in large pots placed on a perforated dome, beneath which strong wood-fire is kept burning, the pared leaves of the trees being used among other fuel. The juice, which was at first brilliant and limpid, becomes now a dark brown, half viscid, half solid mass, which is called *gur* (molasses), and when it is still warm, it is easily poured from the boiling pan into the earthen pots (small *gharras*) in which it is ordinarily kept.

“ As it takes from seven to ten seers of juice to produce one seer of *gur* or molasses, we can calculate the amount of *gur* which one ordinarily good tree can produce in a season. We may count four and a half months for the tapping season, or about sixty-seven tapping nights. These at 5 seers each, produce 335 seers of juice, which will give about 40 seers or 1 maund of *gur*. A bigha of grove containing 100 trees will therefore produce Rs. 200 to Rs. 225 worth of *gur* if all the trees are in good bearing.

“ It is not all sorts of pottery which will bear the continuous hard firing required for boiling down the juice and some potters have obtained a special reputation for the excellence of their wares in this respect. The whole of the region about Chaugachha and Kotchandpur is supplied principally from a village, Bagdanga, a little west of Jessore, where the clay seems to be of an unusually good quality. The southern part of the district, again, is supplied chiefly from Alaipur, a bazar near Khulna.

“ A raiyat, after boiling down his juice into *gur*, does not ordinarily do more ; it is then sold to the refiners, and by them manufactured into sugar. Near Keshabpur, however, a large number of raiyats manufacture their own sugar and sell it to the exporters only after manufacture. There are also in almost all parts of the district a class of refiners different from those who are refiners and only refiners by profession. These are the larger raiyats in the villages, many of whom combine commercial dealings with agriculture. They receive the *gur* from the raiyats in their vicinity and sometimes also purchase it in adjacent *hats*, and after manufacturing what they thus purchase, they take their sugar to some exporting mart and sell it there to the larger merchants.

“ We shall now see what the process of manufacture is. But there are several methods of refining, and two or three sorts of sugar produced. We will take them in order, and describe first the method of manufacturing ‘*dhulua* sugar—that soft, moist, non-granular, powdery sugar, used chiefly by natives and specially in the manufacture of sweet-meats.’

“ The pots of *gur* received by the refiner are broken up and the *gur* tumbled out into baskets, which hold about a maund each and are about fifteen inches deep ; the surface is beaten down so as to be pretty level and the baskets are placed over open pans. Left thus for eight days, the molasses passes through the basket, dropping

into the open pan beneath and leaving the more solid part of the *gur*, namely, the sugar, in the basket. *Gur*, in fact, is a mixture of sugar and molasses, and the object of the refining is to drive off the molasses which gives the dark colour to the *gur*.

“The eight days’ standing allows a great deal of the molasses to drop out, but not nearly enough; and to carry the process further, a certain river weed, called *Shyala*,\* which grows freely in the Kabodok especially, is placed on the baskets so as to rest on the top of the sugar. The effect of the weed is to keep up a continual moisture, and this moisture, descending through the sugar, carries the molasses with it, leaving the sugar comparatively white and free from molasses. After eight days’ exposure with *shyala* leaves, about four inches are cut off and *shyala* applied on the newly exposed surface. This and one other application will be sufficient to purify the whole mass.

“The sugar thus collected is moist, and it is therefore put out to dry in the sun, being just chopped up so as to prevent it caking. When dried it is a fair, lumpy, raw sugar, and it weighs about 30 per cent. of the original mass, the rest of the *gur* having passed off in molasses. Dishonest refiners can get more weight out of it by diminishing the exposure under *shyala* weed, so as to leave it only five or six days, instead of eight. The molasses is less perfectly driven out and the sugar therefore weighs more. Of course, it has also a deeper colour but this is in a measure remedied by pounding under a *dhenki*. There are also other dishonest means of increasing the weight, for example, the floors of the refineries are sometimes a foot or more beneath the level of the ground outside, the difference representing the amount of dust which has been carefully swept up with the sugar when it is gathered up after drying. Also, it is very easy to break the pots so that fragments of them remain among the sugar.

“The first droppings, gathered in the open pan in the manner described above, are rich in sugar, and are used, especially in the north-west, for mixing up with food. It entirely depends, therefore, upon the price offered for them for the purposes whether they are sold at once or reserved for a second process of sugar manufacture. In this second process the first droppings are first boiled and then placed under ground in large earthenware pots to cool. Unless thus boiled they would ferment, but after being boiled in this fashion they, on cooling, form into a mass somewhat like *gur* but not

---

\* This is *Vallisneria verticillata*. All kinds of aquatic weeds going by the name of *Shyala*, other weeds have been sometimes used by mistake in place of *Vallisneria verticillata*, only with partial success. *Vallisneria octandra* (*pata-shyala*) and *Ceratophyllum verticillatum* (*jhanji*), which are occasionally used for this purpose, do the bleaching only imperfectly. The subject needs to be worked up scientifically, as probably it is not merely the continuous presence of the moisture gradually washing away the glucose that is so effective in making brown-sugar white. The author has tried bleaching the *gur* by keeping over it wet sponges but failed, and he has found the *Vallisneria verticillata* possessing the bleaching property in a more marked manner than the other aquatic weeds mentioned above.



nearly so rich. After this, the previous process is again gone through, and about 10 per cent. more weight in sugar is obtained. This sugar is, however, coarser and darker in colour than the first.

“The refiner is not very honest and if he is sure of finding immediate sale, he will use a much more speedy process. Taking the cooled *gur* he will squeeze out the molasses by compressing the mass in a sack, and then, drying and breaking up the remainder, will sell it as sugar. It does not look much different from that prepared in the more elaborate fashion, but it will likely soon ferment and hence the necessity of finding an immediate purchaser.

“The remainder, after all this sugar has been squeezed out, is molasses, *chitiya gur*, as it is called. It forms a separate article of commerce.

“The sugar produced by the method just described is called *dhulua* sugar, a soft yellowish sugar. It can never be clean, because it is clear from the process used, that whatever impurity there may originally be in the *gur*, or whatever impurity may creep into the sugar during its somewhat rough process of manufacture, must, always appear in the finished article. Another objection to it is that it leads slightly to liquefaction, and cannot therefore be kept for any considerable time.

“The ‘*pucca*’ sugar is a much cleaner and more permanent article. It has also a granular structure, which the *dhulua* has not. The manufacture of it is more expensive than of the other, and the price of it when finished is about Rs. 10, whereas *dhulua* costs only about Rs. 6 per maund.

“In this process the *gur* is first cast upon flat platforms, and as much of the molasses as then flows off is collected as first droppings. The rest is collected, put into sacks and squeezed, and a great deal of the molasses is thus separated out. The sugar which remains behind is then boiled with water in large open pans, and as it boils all scum is taken off. It is then strained and boiled a second time and left to cool in flat basins. When cool it is already sugar of a rough sort and now *shyala* leaves are put over it, and it is left to drop. The result is good white sugar, and should any remain at the bottom of the vessels still unrefined, it is again treated with *shyala*.

“The first droppings, and the droppings under *shyala* leaves are collected, squeezed again in the sacks, and from the sugar left behind, a small quantity of refined sugar is prepared in exactly the same way by twice boiling. The droppings from the sacks are *chitiya gur*, and are not used for further sugar manufacture. About 30 per cent. of the original weight of the *gur* is turned out in the form of pure *pucca* sugar.

“There remains to be described the English process of refinement used in the factories of Kotchandpur and Chaugachha. In this, the raw material is mixed with a certain amount of water and boiled in open cisterns, the boiling being accomplished, not by fire, but by the introduction of steam. The lighter filth now floats to

the surface and is skimmed off, while the boiling solution is made to flow away through blanket strainers into another cistern. After this it is boiled to drive off the water. Now, if the mass were raised to boiling temperature, the result would be sugar, granular indeed in structure, but not differing in this respect from native *pucca* sugar. But if the water be driven off without raising the mass to boiling point, then we get the crisp and sparkling appearance which loaf-sugar always has. Whether there is any difference in the substances, I do not know, but so long as people prefer what *looks* pleasant and nice, sugar of this sparkling appearance will command a higher price in the market.

“The object is attained by boiling in a vacuum pan, that is to say, a large closed cistern from which a powerful pump exhausts the vapour as it rises. The lower the atmospheric pressure on the surface of any liquid, the lower the temperature at which ebullition takes place. The pump is therefore regulated so as to diminish the pressure on the surface to meet a point that the mass will boil at about 160°F. and the apparatus being kept regulated to this point, all the water is driven off by boiling by means of introduced steam, without the temperature becoming higher than 160°.

“It is out of place here to describe the mechanical devices for filling and keeping filled and employing and watching and testing the liquid within the closed cistern, or for regulating the supply of heat and the action of the pump, which is driven by steam. It is sufficient to pass at once to the end of the vacuum pan stage, which lasts eight hours, and to say, that the mass in the pan is now run off into sugar-loaf moulds, which are placed upside down, having a hole in their vertex, placed above a pot. The molasses by its own weight drops out by this hole and is caught in the earthenware pot beneath.

“The last of the molasses is washed out in the following manner. The uppermost inch of the sugar in the mould is scraped off, moistened, and put back. The moisture sinks through the mass and carries with it the molasses. This is done some three times and then the sugar having now been twelve days in the moulds, the purification is considered to be finished, and the loaves may be turned out of the moulds. If the raw material used was the *gur* as it comes from the cultivator, the result is a yellowish, sparkling loaf-sugar, but if *dhulua* sugar is the raw material used, then the loaf is of brilliantly white sugar.

“The process used at Cossipore, near Calcutta, is similar to that last described. The principal difference consists in this, that the sugar is at one stage additionally purified by being passed through animal-charcoal, and that the molasses, instead of being allowed to drop out by its own gravity from the moulds, is whirled out by the application of centrifugal force.”

*Chitiya gur* is used for mixing with tobacco, and the cleaner and sweeter molasses for preparing cheap native sweets out of fried and parched rice and pop-corn. There is considerable demand for

*chitiya gur* and molasses in India, as about 18,000 tons of molasses are annually imported into this country from Mauritius or Java.

A most interesting experiment has been undertaken by the Khandwa Sugar Manufacturing Company in the manufacture of date-sugar in the Central Provinces, and as the author of this handbook has been associated with this experiment, he is able to furnish the latest figures, which differ somewhat from those given by Mr. Westland, but the conditions of the Jessore and the Central Provinces date plantations are entirely different, and the following figures are not by any means intended to discredit those supplied by Mr. Westland, but rather to supplement them.

In the Khandwa experiments, for every circle of 5,000 trees 30 *seolis* or professional juice-collectors and ten labourers are employed, the former being paid Rs. 12 and the latter Rs. 6 per month. The tapping and *gur*-making season lasts for four months and the expense per circle of 5,000 trees, is, therefore,  $4 \times (30 \times 12 \times 10 \times 6) =$  Rs. 1,680. Extra expenses come to about Rs. 220, making the total Rs. 1,900 per circle.

The average produce of juice per tree is three seers per day for the days in which they are tapped. In the Khandwa experiment, four days of rest are allowed after two days of tapping and even then the yield of juice per tree comes to only six seers for six days (including the quiescent days). Each *seoli* takes up a circle of 120 trees, 40 going to a *mahal* or section, and the 120 trees are thus divided into three sections. After taking the *jiran* and *do-kat* juice on each *mahal*, he goes on to the next *mahal*, and so on to the third, returning to the first *mahal* after giving it rest for four days. Each tree is tapped about 40 times during the four months, and the produce of juice per tree is therefore 120 seers or 3 maunds, and the 30 *seolis* are able to gather  $30 \times 120 \times 3$  maunds of juice. As about 8 maunds of juice go to make 1 maund of *gur*, the annual yield of which per circle is  $\frac{30 \times 120 \times 3}{8} = 1,350$  maunds, the money value of *gur* is about Rs. 4,000. The net profit per circle is therefore nearly Rs. 2,000 per annum.

## CHAPTER LXII.

### SUGARS.

[Groups of sugar; Saccharometer; action of dilute acids on sugar; use of the polariscope; the copper test; beet-sugar; general principle underlying sugar manufacture.]

SUGARS may be classified under two groups,—glucoses and sucroses. Honey is a mixture of glucoses, consisting of two constituents, dextrose ( $C_6 H_{12} O_6 H_2 O$ ), which is the more solid portion and lævulose ( $C_6 H_{12} O_6$ ) which is the more liquid portion. Cane-sugar ( $C_{12} H_{22} O_{11}$ ) and maltose ( $C_{12} H_{22} O_{11}$ ) are sucroses.

Dextrose occurs also in grapes, and in many juices of plants and it is therefore called grape-sugar. It reduces an alkaline solution of cupric hydrate giving a red precipitate of cuprous oxide ( $\text{Cu}_2\text{O}$ ), while cane-sugar does not do so unless it is first heated with a dilute acid. This reaction is made use of in estimating the amount of dextrose present in liquids. All sugars are soluble in water and less so in alcohol. Lævulose resembles dextrose except in its action on polarized light. Dextrose rotates the plane of polarized light to the right hand and lævulose to the left hand. Dextrose and lævulose are not so readily crystallized as cane-sugar is, and the molasses of cane-sugar and other raw sugars contain dextrose and lævulose. These glucoses being hygroscopic substances absorb moisture from damp air, which accounts for *gur* and *dhulua* sugar running in the rainy season and good Cossipore Factory sugar remaining dry. Impurities in the form of glucoses and ash constituents prevent crystallization of cane-sugar more or less. One part of glucose prevents one part of cane-sugar from crystallizing and one part of ash prevents five parts of cane-sugar from crystallizing. Unripe cane, maize-stalks and sorghum-stalks contain less cane-sugar and more glucose. A properly ripe cane contains about 80 per cent. of water, 16 per cent. of cane-sugar, .3 per cent. of glucose, .75 per cent. of ash, and about 3 per cent. of albuminoid matter.

Baume's Saccharometer is graduated to indicate the amount of sugar in a saccharine solution, each degree on the scale representing 0.019 per cent. of sugar, so that a liquor registering  $10^\circ$  would contain .19 per cent. of sugar. Syrups when hot are about 3 degrees lighter than when cold and the saccharometer is standardized at  $84^\circ\text{F}$ . The Brix hydrometer can be used as a saccharometer, as it gives the percentage of solids in solution directly. In clarifying and in boiling sugarcane juice the use of a copper-case thermometer is essential. One registering from  $0^\circ$  to  $300^\circ\text{F}$ . is the best to use.

Dilute acids convert cane-sugar into a mixture of dextrose and lævulose. Cane-sugar rotates the plane of polarized light to the right and a mixture of equal parts of dextrose and lævulose to the left. Sugar is therefore said to be 'inverted' by dilute acids. Sugarcane juice is naturally somewhat acid, and hence in the boiling process some cane-sugar is inverted into glucose. The only dilute acid which does not invert the sugar liquid is phosphoric acid; hence this acid is used along with milk of lime in clarifying the liquid. The addition of slaked quicklime for neutralizing juice before boiling, is of the highest importance. But just sufficient lime should be added to neutralize the acid or else the colour of the sugar produced will be too dark.

Maltose is produced naturally in germinating barley. Germinating barley dried and digested with water at about  $60^\circ\text{C}$ . parts with its malt-sugar which can be obtained from the solution by boiling it down.

The difference of action of polarized light on different kinds of sugar is a principle utilized in factories for testing the purity of sugar or sugarcane juice, with the help of an instrument called polariscope. It consists of two prisms of transparent calcite (Iceland spar) enclosed in a tube, between which the saccharine solution is introduced. Light passing through the outer prism, the saccharine solution and the inner prism, traverses a layer of transparent quartz so adjusted that the rotation caused by the sugar-solution can be detected and measured. The rotatory power of cane-sugar is  $73.8^\circ$  to the right, and it may be found out by observing a column of saccharine solution, 1 decimetre in depth, containing 1 gramme of pure cane-sugar in every cubic centimetre of fluid. To get the rotation of any sample from this observed rotation, divide the former by the depth of the column of fluid multiplied by the weight of the sugar in each cubic centimetre of liquid. Thus, if a solution of 0.25 gram of sugar in each cubic centimetre of fluid has an observed rotation of  $25^\circ$  in a column 2 decimetres in depth, the rotatory power of the sample is  $\frac{25}{2 \times 0.25} = 50^\circ$ . The percentage of cane-sugar in the sample would thus be  $(73.8 : 50 :: 100 : x)$   $\frac{100 \times 50 \times 10}{738} = 6.77$ . If no invert-sugar is present, the proportion of sugar present in the juice or solution can be found by multiplying the rotation of the solution as observed by the polariscope by 100 and dividing the product by 73.8.

The presence of invert-sugar is detected by the copper test. Cane-sugar does not give the characteristic red precipitate of cuprous oxide ( $\text{Cu}_2\text{O}$ ) from alkaline solution of cupric tartrate, while glucose does. To estimate the proportion of glucose present, a standard solution is used. This is Fehling's solution. It consists of  $90\frac{1}{2}$  grains of sulphate of copper, 364 grains of neutral tartrate of potash, 4 fluid ounces of caustic soda of specific gravity 1.12 and water to make up 6 ounces. In using this standard solution it is brought to the boiling point and a known weight and volume of solution of glucose dropped into it from a burette until the copper has been just reduced which is known by the blue colour being destroyed. The precipitate is then filtered, dried and weighed, the difference between its weight and that of the sugar used in the solution gives the percentage of cane-sugar. The quantity of sugar lost in reducing the copper being glucose, the residue is sucrose. Fehling found that one equivalent (180 parts) of glucose decomposed 10 equivalents (1246.8 parts) of sulphate of copper.

Sugar is made not only from date-palm juice, sugarcane and beet. It is also obtained from maize-stalks, stalks of sorghum, saccharatum, cocoanut and toddy-palm juices, and other plants. In Aramerum the maple-tree is largely tapped for a sugar-yielding juice. Coal tar, from which so many fine dyes and other articles of economic value are obtained, is the source of a highly sweet substance called saccharine. One tabloid of saccharine scarcely

so large as a two-anna piece, will sweeten a cup of tea. But this substance has no feeding value like genuine sugars. Milk is also a source of sugar. After cream and cheese have been extracted out of fresh milk, the whey from the cheese-vat is forced into a large boiler, whence after a time the liquid is run into an evaporating pan, where the boiling is continued until a thick syrup is formed. This syrup is left standing for a time and again boiled when the sugar forms. The sugar is pressed and the molasses rejected, and then packed in barrels for the refinery.

Beet-sugar is largely manufactured in Germany and Austria, and it is competing very successfully with cane-sugar. Good roots of beet yield on an average one-eighth of their weight of sugar, but one-sixth has been also obtained of late years. The proportion of sugar is materially increased by phosphatic manures and by selection only of *middle-sized roots* for seeding. Middle-sized roots which are white, are alone grown for crushing for sugar. In 1876 the average produce of sugar from an acre of beet (*i.e.*, from 10 tons of roots) was estimated at 2,000 lbs., while in 1896 the average rose to 3,000 lbs. per acre and the tendency is towards further amelioration. It should be noted, however, that 3,000 or 4,000 lbs. of sugar per acre is considered a poor yield for sugarcane, and 8,000 lbs. or even more are often obtained. Though chemists have not been able to find any difference between cane-sugar and beet-sugar, manufacturers do not consider them identical. For the condensed milk trade beet-sugar has been found altogether unsuitable.

The Superintendent of the Saharanpur Botanical Gardens has made an interesting experiment on the cultivation and manufacture of beet-sugar. He came to the conclusion that the white sugar-beet can be easily introduced as a cold weather crop in India. The yield per acre was 9½ tons of roots, 6 tons of green leaves, 4½ tons of juice, and 13 cwts. of *gur*, of which about half the quantity may be put down as pure cane-sugar. Mr. Proudlock, late of the Ootacamund Botanical Garden, also reports favourably of sugar-beet growing.

With regard to the manufacture of sugar by a scientific process, the following general summary may be remembered :—

(1) The first object after the juice has been obtained in the fresh state either from beet, sugarcane, maple, or palm is to remove the albuminoid substance, which is favourable to the growth of the microbes which turn sugar acid. Acidity 'inverts' cane-sugar and prevents proper crystallization. The ash or non-saccharine substances also prevent crystallization. Hence the great importance of clarifying before boiling. The temperature of the juice at clarifying should be between, 25° and 145°. In any case it should not be allowed to go above 160°F.

(2) The clarifying is done by adding to the hot cane-juice just enough of slaked lime or some other alkali, by stirring, which would neutralize the juice which is naturally acid. The albuminoid

matter combining with lime sinks. For clarifying, about half a tola of slaked lime per *ghara* of juice will be found ample. Thus clarified and neutralized, the juice should be filtered through double flannel bags and then boiled, the impurities floating as scum on the boiling mass, being taken off. When thick, the brown sugar is put in casks or earthen pots in which holes are afterwards made to get rid of the molasses.

(3) To get rid of the molasses more quickly and thoroughly it is advisable to use a sugar-turbine. A hand sugar-turbine of centrifugal machine is sold by Messrs. Mylne and Fox of Behea, for Rs. 200.\* When the molasses have run out, brown crystals are left behind. These are mixed with warm water into a syrup, lime is added to it, and the mixture is poured into bags made of thick woollen cloth and left to drip through into a vessel below. The liquid though clean is still coloured, and it is made colourless by passing it through a bed of bone-charcoal. This colourless syrup is then put in large copper pans and boiled. When thick enough it is poured into moulds after which we get loaf-sugar. The moulds are placed with their small pointed ends downwards. Here there are some small holes. Part of the syrup which does not harden flows out into a vessel underneath. This is called 'golden syrup.'

Evaporation in a vacuum apparatus, which results in more sparkling crystals, and the separation of molasses by a centrifugal apparatus, are the two specialities of the factory system as distinguished from the cottage system of making sugar, but the Indian cottage system of making raw sugar may be improved. If the preliminary neutralizing and clarifying of the sugarcane juice is very carefully done, and aluminium vessels or earthen *handies* used, the second filtering through bone-charcoal will not be found necessary. Any excess of lime tends to make the sugar brownish grey in colour. Finally, we may add, that for Indian use, Mr. Hadi's method seems to be particularly adapted.

## CHAPTER LXIII.

### INDIGO.

[Varieties ; Introduction of the Java Natal variety ; Climate and soil suitable ; Manures ; The crisis ; Different systems of cultivation ; Manufacture. Oxidising process ; Indigo tests ; Synthetic indigo likely to replace natural indigo.]

**Varieties.**—The variety of indigo grown in Bengal (*i.e.*, *Indigofera sumatrana*, ordinarily known as *Indigofera tinctoria* is not the richest in India, and the Madras variety *Indigofera anil* is still poorer. The variety richest in the dye-stuff is the *Indigofera*

---

\* For large factories, the Western Centrifugals obtainable of the American Tool and Machine Co., 109, Beach Street, Boston, Mass., are recommended.

*arrecta* of Java and Natal. The *Indigofera arrecta* has been introduced with success in Bihar. A dry climate, such as that of the United Provinces and soil naturally rich in lime, should be chosen at least for seed-farms for indigo. With the Java-Natal indigo, harvesting and *Mahai* (or manufacture) can go on all the year round.

**Manure.**—Indigo, like all leguminous crops, grows best on soils rich in lime. Hence the superior yield of some Bihar districts. Potash and phosphates in the soil are also helpful. The application of manures containing phosphates, lime and potash in a concentrated form is being thought of seriously by indigo planters, since the crisis in the trade has been brought about by the increased employment of the synthetic indigo. Mr. Hancock, the Agricultural Chemist employed by the Bihar planters for some years, reported an increase of 63 per cent. in one case and of 140 per cent. in another, by the application to such manures.

**The Crisis.**—The crisis in the indigo trade has been brought about in various ways:—(1) The quarrel between indigo planters and raiyats on the one hand, and zemindars on the other. (2) The extension of indigo cultivation in the United Provinces, the Punjab (specially in the canal-irrigated tracts of these provinces) and in Madras, and the consequent competition which reduced the price to the lowest level. (3) The passing of the industry into Indian hands almost everywhere except in Tirhut, which has resulted in inferiority of produce. (4) The manufacture of the dye by a synthetic process in Germany. With regard to the unwillingness of cultivators to grow indigo, it should be mentioned that the growing of this crop instead of impoverishing their land actually makes it better fitted for the growing of cereals, and if an amicable arrangement can be come to with cultivators by which they can be made to grow indigo willingly on one-fourth or one-sixth of their land in rotation it would be of mutual advantage to the planter and the cultivator. It should be also remembered that indigo refuse is one of the best fertilizers there is. Many factories burn the refuse for feeding engines, which is a great mistake. Some fast-growing tree, such as the Casuarina, should be grown for fuel, and the indigo refuse utilized for manure. The progress of the synthetic dye has been so rapid, that it is not likely that the indigo-growing industry will survive very long, though by the introduction of the Java-Natal variety and superior methods of oxidation introduced in many factories, the evil may be put off for a time.

**Cultivation.**—In alluvial soils and in land annually renovated with silt, indigo cultivation is very inexpensive. Simple cultivation after the water has gone down followed by broadcast sowing, is all that is required. No irrigation is done in such tracts. In Patna, Gaya, Shahabad and parts of Chota Nagpur, indigo is



grown by irrigation, as also in the United Provinces and the Punjab. In Tirhut, Saran and Champaran, *i.e.*, in North Bihar, a very careful system of cultivation is practised, which includes digging the land deep immediately after harvest. The seed is drilled with a seed drill, next season, on land well prepared by ploughing and rolling with a wooden roller, and the fields are hoed and irrigated when necessary. High class cultivation is practised on elevated lands in some parts of Bengal also, *e.g.*, in Jessore and Nadia. Pruning or feeding the crops for a day by sheep and goats is also practised in some localities. The best indigo is produced in highlands under a careful system of cultivation. The spring-sown crop yields the best dye, but as cultivators are eager at this time to sow *aus* paddy which is directly more remunerative, it is not always convenient to get a large tract sown in spring. So far as our experiments have gone at Sibpur, we find it is immaterial whether *aus* paddy is sown in April or in May, or in June. In fact, April sowing of indigo is far more important than April sowing of *aus* paddy, as the latter is risky.

When *Falguni* sowing is done on highlands (*i.e.*, in February or March) the land must be thoroughly prepared by manuring with *nil-siti*, deep ploughing, rolling and ploughing, and rolling again. Sowing is done by a drill after which the land is again rolled. In three or four days the seed germinates. One or two weedings are then given until the plants are sufficiently high. The *Falguni* indigo is grown where there is facility for canal irrigation. In dry soil sowing goes on in July to September, and the crop is cut in September or October. The second year's crop from early sowings and late sown indigo crop are called *Khunti*. October sowing (*chhitani*) is done on *char* lands after the water has subsided and when the land is quite soft, without any preparation, but later on in October, sowing is done in higher land after ploughing and laddering when there is still sufficient moisture in the soil. October and April are the two usual seasons for sowing indigo. With indigo sown in October is usually grown some oilseed which yields the raiyat an additional Rs. 6 or Rs. 7 per acre, and October sowing of indigo is, therefore, not so unpopular with the raiyat as the April sowing. Ten to fifteen seers of seed are required per acre. Thirty to forty bundles (a bundle weighing about 300 lbs.) is the produce per acre and the yield of dye about 12 lbs. per acre. In Lower Bengal the average yield is 10 to 12 lbs. per acre and in Bihar 20 lbs. per acre. Indigo is ripe for cutting when the flowers are just appearing, *i.e.*, about June or July, if sowing is done in February to April. The arrangement for manufacturing being completed, cutting begins. The lowest lying fields are chosen first. The crop is cut with sickles and tied into bundles, and as the crop is bought at so many bundles (say 4 or 5) per rupee, when it is cultivated by raiyats and sold to the factory, a chain of a definite measure is used in each factory. But different factories use chains of different lengths.

**Manufacture.**—The bundles of plants are put in fresh in the steeping vat, water is poured upon them, and they are pressed by means of bamboo rods and heavy beams of timber. The bundles remain in this condition for one night. There are two sets of vats. The second set is at a lower level than these steeping vats, and when steeping has been completed in the first set, the yellowish liquid containing the dye is drawn off from it into the second set. Here, twice the number of men employed in pressing the bundles is employed inside the vats in stirring up the liquid with bamboos to oxygenate it. When the liquid has changed from a yellowish colour to indigo colour the stirring is completed. From these stirring vats the liquid is run off along a channel into a trough or well, whence it is pumped up into the first drying house, where it is subjected to boiling. From here the thickened liquid is discharged on a stout cloth spread on a platform of bamboo laths. The water percolating out is pumped up again and again on the mass of soft dye until the water percolates out, not indigo coloured but of a dark red tint. If it takes too long alum water or *palas* gum is used, when the indigo is readily deposited. The cloth is then folded over and pressed. The press is tightened every now and again for five or six hours and afterwards gradually and gently loosened, and the cake, which is about  $42 \times 24\frac{1}{2} \times 3\frac{1}{2}$  inches in dimension, exposed. This cake is then marked off into 3 or  $3\frac{1}{2}$ -inch square blocks, and the slab on which it rests removed to another room where the cutting and removal of the cakes from the slab are accomplished, the cakes being removed to the drying or cake-house, which is a well-ventilated room protected from dry and hot winds. The cakes are arranged in bamboo shelves and turned from side to side that every side may get equally dry. The cakes are removed when quite dry to a sweating room, where walls of cakes are made and covered with blankets and dry bran, and the doors closed, so that little air may find access into the room. In about a fortnight the sweating process is completed when air is let in slowly and the walls of cakes uncovered by degrees, the blankets being removed in four to five days. The process of sweating improves the brilliancy of the dye, and it gives a white skin to the cakes which is highly appreciated by buyers. The whole process of drying from the time the pressing of the fecula or pulp takes place, requires about three months. The cakes are brushed when ready for packing and packed into cases of well-seasoned wood. Improvements in the manufacture of indigo have been lately brought about by Mr. Christopher Rawson and by Mr. B. Coventry, who, by proper method of oxidizing, have obtained an increased yield of 25 per cent. or more. With the help of Mr. Rawson's blower for oxidizing the liquid as it comes from the steeping vat 25 to 30 per cent. more of colouring matter has, in some cases, been obtained. With the ordinary appliances, Bihar factories obtain about 10 seers of indigo (60 per cent. purity) out of

every 100 maunds of green plant, and with the blower  $12\frac{1}{2}$  seers are sometimes obtained. The indigotin is contained in the leaf, and the weight of leaf on plants may be as much as 60 per cent., or as little as 10 per cent. The leaf of the *Indigofera samatrana* of Bihar yields about 55 per cent. of indigotin, which is equivalent to 36 seers of indigo out of 100 maunds of leaf. Taking an average good plant to contain 40 per cent. of leaf, 100 maunds of green plant would yield 14.7 seers of indigo (60 per cent. purity). As  $12\frac{1}{2}$  seers may now be obtained with the help of the blower, it may be inferred that it is possible by proper fermentation or otherwise to obtain another two per cent.

**Pure Indigo Tests.**—Whether a fabric has been dyed with pure indigo or with some inferior dye, can be judged by the following tests: (1) Put two or three drops of ordinary commercial nitric acid on some portion of the fabric. A yellow spot with a green rim quickly appears if the dye is pure indigo. (2) Make a mixture of one part sulphuric acid, and nine parts of water, and in it boil quickly for ten minutes a piece of the cloth to be tested, say  $1\frac{1}{2}$  inches square. Care must be taken always to pour the acid gently into the water and not the water into the acid. If the cloth has been dyed in pure indigo, the solution will remain colourless. (3) Dissolve about 1 oz. of common washing soda in half a pint of water and gently boil in it for 15 minutes a  $1\frac{1}{2}$  inches square piece of cloth. If the dye used is pure indigo the liquid will remain colourless.

The *artificial indigo* of commerce, manufactured by several large factories in Germany, is almost pure indigotin, containing no indigo red, and no indigo brown, which is a disadvantage, as these substances have some beneficial effects in dyeing. But artificial indigo is likely to supplant natural indigo in the long run, when the defects of the artificial product will have been supplied by artificial means. Woollen fabrics dyed with natural indigo may be distinguished from those dyed with artificial indigo by holding the two fabrics over steaming water. The one dyed with vegetable indigo will emit an agreeable odour, while the chemical indigo will give out a tarry smell. For silk, the natural indigo still produces better results than the synthetic product, but we cannot hope that this advantage will be maintained for ever.

## CHAPTER LXIV.

## TOBACCO.

[Soil and climate suitable ; Differences in quality : Proximity to sea unsuitable for cigarette tobacco ; Chemical composition ; Inference as to manures useful ; Rotation ; Seed-bed ; Preparation of land ; After-treatment ; Harvesting ; Drying and fermenting ; Different methods of cultivation and curing in vogue in Rangpur, Jalpaiguri Nadia, Tirhut and Petlad ; Seeding ; Outturn ; Injuries ; Suggestion for improvement ; Arrangements made at Pusa.]

**Soil and climate.**—A light soil or sandy loam, well drained, containing an average amount of organic matter and rich in mineral matters is considered to be best suited for tobacco cultivation. Grown on clay soils, the leaf becomes too coarse and inferior in quality, but clay soils usually give heavier yields. Sandy loams, rich in organic matter, produce a better sort of tobacco of the kind fit for making cigars. The principal tobacco-growing districts of Bengal, in their order of importance, are, Rangpur, Cooch Behar, Jalpaiguri, Purnea, Darbhanga, Mymensingh, Nadia, Muzaffarpur, Jessore, Manbhum, Murshidabad, Dinajpur, Chittagong, Dacca, Tippera, Bhagalpur, Pabna, Monghyr, and Cuttack. The Chittagong Hill Tracts produce the best tobacco in Bengal. This is generally used for making cigars by the Burmese. There are three varieties : (1) Khao Doung, (2) Mri Kheoung, and (3) Rigre Kheoung. The excellence of these varieties of tobacco is said to be due to the speciality of the soil rather than to any peculiar mode of cultivation or of curing. The leaves are cured in the way in vogue in Rangpur and Jalpaiguri. The Chittagong tobacco sells for Rs. 20 or more per maund, while the Rangpur tobacco sells from Rs. 6 to Rs. 12 per maund. The tobacco of other districts enumerated above is sold at Rs. 3 to Rs. 7 per maund. Ignorance of the method of cultivation and of curing causes in many places inferiority in the quality of leaves, but the difference in flavour is no doubt also due to difference in the kind of tobacco grown, to influences of the soils, and to climate. The best cigar-making tobacco cannot be grown too close to the sea, as chlorides are injurious for such tobaccos, *i.e.*, they interfere with the burning quality of the leaf.

**Chemical Composition.**—Tobacco requires particularly good soil and heavy manuring, as it is richer in nitrogen and in mineral constituents than almost any other crop. The composition of the leaves varies very much in both nitrogenous and ash constituents according to the richness of the soil or the amount of soluble plant food contained in it. The amount of nitrates in leaves may be as much as 10 per cent. of the dry matter. The ash of Indian tobaccos varies between 16 and 28 per cent., the greater part of which consists of carbonate of lime. The soluble portion of the ash chiefly consists of potash salts, the proportion varying from five to thirty-five per cent.

The following table gives the chemical composition of a sample of Virginian tobacco :—

|                                 |    |    |       |    |
|---------------------------------|----|----|-------|----|
| Moisture                        | .. | .. | 9.44  | %  |
| Nicotin                         | .. | .. | 4.52  | .. |
| Ammonia                         | .. | .. | .53   | .. |
| Nitric acid                     | .. | .. | .83   | .. |
| Malic acid                      | .. | .. | 12.05 | .. |
| Citric acid                     | .. | .. | 2.81  | .. |
| Oxalic acid                     | .. | .. | 3.18  | .. |
| Acetic acid                     | .. | .. | .55   | .. |
| Tannic acid                     | .. | .. | 1.80  | .. |
| Petic acid                      | .. | .. | 7.18  | .. |
| Pectose bodies and gums         | .. | .. | 3.61  | .. |
| Albuminoids                     | .. | .. | 11.92 | .. |
| Total Nitrogen                  | .. | .. | 2.75  | .. |
| Amid Nitrogen                   | .. | .. | .61   | .. |
| Other insoluble organic matters | .. | .. | 6.87  | .. |
| Cellulose                       | .. | .. | 10.22 | .. |
| Oils, fats and chlorophyll      | .. | .. | 5.90  | .. |
| Resins                          | .. | .. | 4.51  | .. |
| Starch                          | .. | .. | .64   | .. |
| Total pure ash                  | .. | .. | 13.64 | .. |
| Silica and sand                 | .. | .. | 3.78  | .. |
| Phosphoric acid                 | .. | .. | .38   | .. |
| Sulphuric acid                  | .. | .. | .56   | .. |
| Chlorine                        | .. | .. | .74   | .. |
| Lime                            | .. | .. | 3.94  | .. |
| Magnesia                        | .. | .. | 1.04  | .. |
| Oxide of iron and alumina       | .. | .. | .46   | .. |
| Potash                          | .. | .. | 2.60  | .. |
| Soda                            | .. | .. | .13   | .. |

Potash should occur chiefly as carbonate (or ordinary wood ash) in the soil, and the richness of a soil for tobacco is chiefly due to the abundant presence of nitrogen, potash and phosphoric acid as nitrates, carbonates, sulphates and phosphates. From this it will appear that the most appropriate manures for the tobacco crop are ashes (or crude potassium carbonate), saltpetre, gypsum and superphosphate. But as manuring is expensive, soils naturally rich in nitrogenous and ash constituents, that is, very fertile soils, should be chosen for growing this crop.

**Rotation.**—Tobacco is sometimes grown after jute or maize has been harvested but very often it forms the only crop of the year. Properly manured, it can be grown for three or four years successively on the same ground, and it can be grown nearly all the year round.

**Seed-bed.**—The soil of the seed-bed is dug up with a spade and manured with rotten cow-dung and ashes and then raised about six inches. When the ground has been well pulverised and levelled, seed is drilled thin, so that the seedling may have about one inch of space around it. After sowing, the seed is lightly covered up with earth. The seed-bed is kept covered with mats until germination takes place. It is necessary also to keep the seedlings protected

from rain and heat of the sun. They may require to be watered at intervals of two or three days. Seed is generally sown in the first week of September or earlier in Bihar and Chota Nagpur. In dry laterite soil it is best to do the sowing early, *i.e.*, about the second or third week of August. Half an ounce ( $1\frac{1}{6}$  tola) of seed is to be sown to produce plants required for one acre; but loss invariably occurs owing to patches of seedlings growing too thick. It is therefore advisable to grow seedlings from one ounce of seed for one acre of land. Sometimes ants do considerable damage to seed and seedlings, when ashes sprinkled round and over the seed-bed prove efficacious. Loosening the soil of the seed-bed between the lines of seedlings is important.

**Preparation of land.**—The soil for tobacco-planting should be prepared during the months of September and October. Eight to ten ploughings are necessary. Deep cultivation and thorough pulverisation of the soil are most important. The soil should be liberally manured with well-rotted cow-dung and ashes. It is then to be levelled with a light harrow. It is needless to say that even poor soil can be made to produce a good crop by proper tillage and heavy manuring. Soils destitute of potash, unmanured soils, or soils manured with flesh, bones, calcium chloride, magnesium chloride, or potassium chloride, produce a bad burning tobacco which is unsuitable for making cigars. The use of cowdung also should be avoided in raising tobacco for the manufacture of cigars. Potassium carbonate, saltpetre, potassium sulphate, and calcium sulphate (gypsum) are the best manures for tobacco intended for cigars. They give to the leaves a sweet flavour and burning quality. Gypsum is excellent as a top-dressing and its use is particularly recommended to Indian cultivators. Crops manured with it suffer less from the effects of drought and require less irrigation. Gypsum is a bye-product in the manufacture of aerated waters and can be obtained very cheap from these factories at four to eight annas per maund, but it should be used with an equal quantity of lime mixed with it, as the bye-product is liable to be acid. The mineral manures are used generally from  $2\frac{1}{2}$  to  $4\frac{1}{2}$  maunds per acre. Ordinary household ashes also are an excellent manure for tobacco. They contain a large amount of potash and lime, and are particularly recommended for clay and humus soils.

**Transplanting.**—When the seedlings are about three inches high in the nursery, that is, after they have shown three or four leaves, which takes place within six weeks from sowing time, they are fit for transplantation. The transplantation begins in the beginning of *Aswin* (the third week of September), and extends as late as the end of *Kartik* (middle of November). Early planting is preferable, especially for dry climates. The seedlings should be planted in the evening, three feet apart from one another. Smaller varieties, as *Hingli*, *Motihari*, etc., may be conveniently

planted two feet apart. The transplanted young seedlings are to be carefully watered for the first few days until they strike root. Irrigation may be afterwards necessary at intervals of about ten to twenty days according to the nature of the soil. In Rangpur and Jalpaiguri a hand-plough is repeatedly dragged by a man alternately along and across the tobacco fields, which serves the purpose of hoeing and stirring the soil. This is done until the flower buds are seen. In places where artificial irrigation is required, regular hoeing is wanted once after each irrigation or twice a month.

**After-treatment.**—A few days before the plants run to flower, their buds and lower leaves should be nipped off, and they should be so pruned that only eight leaves, and on no account more than ten, may be left to each plant from the top. In Jalpaiguri finely powdered earth is used to stop bleeding or overflowing of sap from the broken parts immediately after pruning. This mode should be followed in other districts. Plants reserved for seeding should not be topped in this way, but left to flower and seed. The plants always bring forth shoots by the side of the stalks of leaves pruned, and care should be taken to prune off the shoots every now and again until the leaves are mature. The longer these buds and shoots are kept the more injury is done to the leaves required to be gathered.

**Harvesting.**—When the leaves feel thick and gummy and begin to turn yellow with brown spots, they are considered mature and they should be cut off. Tobacco should not be cut over-ripe. Harvesting of a plot should not be done at once: the mature plants are to be gathered first. The best time for harvesting is morning, as soon as the dew is off the plants. They should lie for some time in the sun, say for two hours, to make them sufficiently wilted, so that they can be handled without breaking. Care should be taken not to let them become too much sun-burnt. It is better to cut whole plants (close to the roots) than gather the leaves singly. Harvesting should be delayed for two or three days if there be heavy rainfall, which washes away the gummy matter of the leaves.

**Drying and fermenting.**—Immediately after the plants are conveyed to the house, they should be hung up on strings beneath the roof of a well-ventilated house, six inches apart. Cow-sheds are commonly used by the raiyats for this purpose, but this gives a bad flavour to the tobacco. The plants should remain hanging for more than two months, or until they are quite dry. When very hot or strong winds blow, the windows and doors of the house should be closed. In very dry weather, the floor of the shed should be occasionally sprinkled with water, in order to keep the air of the room sufficiently moist. In June, when the rains commence again, the plants are taken down, stripped and handled. Best, medium

and worst qualities should be separated at the time of stripping. Sixteen to twenty leaves are tied up into one bundle. These are put into large heaps, three to four feet square by five to six feet high, and well pressed down with the hands. The leaves are transferred from one place to another at intervals of about a week or so; fresh heaps being made, top leaves going to the bottom and bottom leaves coming to the top. This transference also involves examination of the leaves. Care should be taken to prevent excessive heating, 90°F. being the maximum limit. At the end of the rains the leaves are considered to be fully cured and quite ready for sale. The heap may be broken up earlier, if so desired.

**Methods of curing in vogue in different parts of India.**—The modes of curing differ in the different districts; and it would be well to cite here the systems of curing in Rangpur, Jalpaiguri, Nadia, Tirhut and Petlad, which are some of the typical seats of tobacco cultivation.

**Mode of curing in Rangpur and Jalpaiguri.**—The methods of curing followed in Rangpur and Jalpaiguri are almost the same. The leaves of mature plants are cut off singly in the morning, and are left in the sun for all day long. In the evening small bundles of four leaves are suspended along the roof of the house—generally a cow shed. After two months, *i.e.*, about the middle of June, they are taken down. Eight small bundles are then tied up into a larger bundle. Leaves are not sorted according to their quality, though the tobacco-growers are aware that the topmost leaves are the best. The bundles of leaves are then put into a large heap. The bundles are taken out and dusted and the heaps re-made at intervals of eight or ten days, until the tobacco is wanted for sale. It is best to keep on the heap till about the close of the rainy season. Tobacco thus kept is said to bring higher prices.

**Mode of curing in Nadia.**—“When cut, the stems with leaves on them are allowed to remain spread out in the sun for two hours. They are then cut into pieces, each of which contains a pair of leaves and portion of the stem. These pieces are then arranged on the ground in layers of nine to ten inches thick, and are allowed to remain in the sun for two days. Rain, of course, at such a time is most destructive. Tobacco in this half-dried state is taken home by cultivators, who string the sections together, and suspend them on rows of strings in the longest apartment of their premises, usually the cow-shed. The leaves after being thus suspended for about a month are thoroughly cured. They are then taken down on a damp or foggy day when they are a little soft, and made into bundles of about 1½ maunds weight each, the strips of leaves being cut into lengths of about a yard, and folded over and laid one on another. The above description relates to the Hingli tobacco of Ranaghat; the inferior sorts appear to be merely made



up into bundles and subjected to the alternate action of sun's rays by day and of the dews at night."\*

**Method of curing in Tirhut.**—"Plants are allowed to be on the ground as cut, for a day or two; they are then carried to some grassy spot and laid out to catch the sun during the day, and the dew at night, being turned daily. After this has gone on for eight or ten days, every third or fourth day the plants are stacked together till they get heated, when they are again spread out to cool. If at this time the dew is thought not sufficient to cool the plant, at evening time a little water is scattered over the leaves as they lie; this goes on for twenty days or more. The plants are then brought into cover and stacked; they are changed every third or fourth day, the top going to the bottom, and so on. It is important now to prevent them getting over-heated: if the leaves show a tendency to get crisp, the leaves are covered with plantain leaves or damp grass, over which is put a blanket to make the heap sweat. The leaves are then separated by *khurpi* or *huswa* from the stem. They are then tied five or six together with strips of date leaves and piled together. These piles are again watched carefully till it is evident that the leaves will not heat any more. They are then tied up in bundles of four maunds each, wrapped round with a straw, and are then fit for the market: if not immediately sold, they are stowed away in some dry place. If the leaves are not of a good colour, the cultivator may, before opening them for sale, get a little good tobacco, boil it and sprinkle the juice over them after the last process of drying; but this is more a trick of the trade than a method of curing which being really nothing more than careful alternative of heat and moisture, no extraneous matter is introduced."†

**Methods of cultivation and curing in Petlad.**—The tobacco cultivation of Petlad in the Baroda State is perhaps the most famous in Western India and a description of this may be of interest. The variety grown is the Havana tobacco introduced here about a hundred years ago. For 1 bigha (100 cubits  $\times$  100 cubits)  $\frac{1}{2}$  lb. of seed is generally sown in the seed-bed, though  $\frac{1}{4}$  lb. is sufficient. A reserve of seedlings is kept to allow for any contingencies. Sowing is done in July. If there is no rain at the time, every third day the seed-bed is watered. Too much rain is injurious for seedlings. The seedlings are transplanted when they have five or six leaves each, *i.e.*, when about 4 inches high. The transplanting is done in August (in *Maghá nakshatra*) in cloudy or showery weather,  $1\frac{1}{2}$  ft. apart in well-ploughed-up and manured soil. Four or five ploughings are given in May and 30 cart-loads (per local bigha) of dung. Then the land is brought to a perfectly level state by the use of the levelling board. After transplanting, interculture with bullock-hoes

\* *Vide* Collector of Nadia's Report, 1874.

† *Vide* Collector of Tirhut's Report, 1874.

is resorted to when one inch of the surface soil is dry, after the rains are over. When there is rainfall again another bullock-hoeing is given. From October or November irrigation commences, which goes on twice every month up to February. Picking of tips and side shoots begins in December, when plants have fifteen or sixteen leaves each, at intervals of ten days, each plant being thus picked four or five times. The cutting of leaves, or harvesting, begins in March. For five days they are left in the field, after which, early in the morning when there is still dew on them, they are removed in bundles of forty or fifty leaves. If the leaves are too dry and there is no dew on them, water is sprinkled on the leaves before removal. One hundred bundles of forty to fifty leaves each are put in each stack, and the bundles are daily transferred for thirty days, from top and bottom to middle and from middle to outside. After this for another month, or half a month, *i.e.*, until they are sold, the position of the bundles is changed once in three days. In each stack there should be put leaves only of one day's cutting. The system here described applies only to the curing of *chilim* tobacco or snuff-tobacco. For *biri* or cigarette tobacco, or tobacco used for chewing raw, the cut leaves are left on the whole field for fifteen days, after which, on a misty day, they are removed. If there is no mist, water must be sprinkled before removal. The whole of the leaves are stacked together and their position changed only once in 15 to 20 days. After two or three transfers, the tobacco is sold off. The yield obtained is 32 to 40 maunds per local bigha, which sells for Rs. 5 to Rs. 8 per maund, a Baroda maund being about half a maund of standard weight, *i.e.*, 41 lbs.

**Seeding.**—The best plants are set aside for seeding. They are not topped like others, but the side shoots and suckers are removed from the stems, only the heads or tops of the plants being preserved for seed. The heads are tied to sticks to keep them straight. As soon as the seed is ripe the heads of plants are cut off and hung in a dry and safe place. After a few days the seed is rubbed out of the pods by hand, and stored. The seed should be preserved from damp and insects, and it is therefore usually hung up in the cook-room. The vitality of the seed can be tested by scattering some on a piece of hot iron. If a sharp spattering sound is given out, the seed may be considered to be sound.

**Out-turn.**—A well-grown crop is expected to yield from 20 to 24 maunds of cured leaves per acre, the money value of which may be estimated at Rs. 100 to Rs. 120., Rs. 5 being the average price per maund of country-cured tobacco.

**Injuries.**—The chief enemy of the tobacco crop is a kind of Noctuid caterpillar which eats away the leaves at night and takes shelter in the soil by day. This caterpillar or cutworm causes serious damage to the young plants. It should be carefully looked

for and killed when any injury from this source is noticed. There is an aphid also causing curling of leaves which does great damage to this crop. Hailstorms often destroy the crop over large areas of the country.

**Suggestion for improvement.**—As native *chilim* tobacco is unfortunately going out and cigarettes taking its place, the method of curing must be altered. For cigarette-making leaves not fully mature should be cut, and the fermenting in heaps done in such a light manner that the colour may remain yellow and in parts green. Small-sized leaves with golden colour make the best cigarette tobacco. The ordinary native tobacco is too much fermented and is too dark and brittle. The following paragraphs are taken from the *Englishman* newspaper :—“It would be well worth considering the possibility of growing the famous Yenidge and Dubec tobacco so much in demand for cigarettes and for which such high prices are paid. This is grown extensively in the Bulgarian and other principalities, as well as in Turkey Proper. All the so-called Egyptian cigarettes are made from tobacco grown outside of Egypt, better known as Turkish tobacco. The best cigarettes are made in Egypt and not in Turkey itself, and this is ascribed to the dry equable climate of Egypt preventing the deterioration that ensues when such climatic conditions are not assured. We have in Aden the same conditions, a rainless region, and on a small scale cigarette-making has for some time been carried on there which, with certain conditions assured, might rapidly expand, specially if such tobacco could be supplied from India.

**European method of curing.**—“When the leaves of the tobacco plant are mature and ready for harvest, they are gathered and first laid on the ground to wilt, that is, to wither and lose their brittleness. This done, they are collected into bundles and packed, top upwards, into moderate size heaps to sweat. Matting is placed over the heaps and a gradual rise of temperature begins. The increase in temperature is due to certain processes which are taking place within the leaves, whereby, as the leaves die, their more complex contents become broken down into simpler ones, with an evolution of heat and water. The water thus given off is in vapour form, but it condenses again on the cooler matting covering, and it is the presence of this water which gives rise to the idea of the heaps ‘sweating.’ Care and attention is needed at this time to prevent over-heating, for did the temperature rise unduly, there would be darkening of the leaves and injurious drying. When the ‘sweating’ is completed, the leaves are dried, either slowly by simple exposure to currents of air, or rapidly by artificial heat. Mouldiness and consequent rotting must be guarded against, and then, if all the conditions are favourable, in six or eight weeks the leaves will have turned a bright warm brown colour, though tobacco at this stage lacks aroma and flavour. The chief result of this process has been to effect a further alteration in the constituents

of the tissues of the leaves. After it is completed, moist air is again brought into play to soften the leaves and render them pliant, and it is not till then that they are ready for the process of fermentation.

Fermentation has always been looked upon as a very important stage in the preparation of tobacco: but if bacteriologists are right, even greater stress must be laid upon it, for it is the key-stone of the whole and of paramount importance. As a preliminary to it, the brown leaves are sorted and made up into hands, or small bundles, containing, perhaps, from six to ten leaves a piece. All these separate bundles are collected and piled up into great heaps or solid stacks—a stack containing sometimes as much as fifty tons of tobacco. Directly the stacks are completed, fermentation begins, encouraged by the warmth and moisture within, and now, too, begins the production of aroma and flavour accompanied by a considerable rise in temperature. But heating is carefully checked before it has gone very far by a continuous turning of the stack inside out and ‘side into middle,’ no temperature higher than 90 degrees Fahr. being allowed.”

## CHAPTER LXV.

### PAN OR BETEL LEAF (PIPER BETEL).

[Profitableness of the crop; Varieties; Midnapur, the district where the best *pan*s are grown; Soil; General principles of cultivation; Setting up a *pan* garden; Subsidiary crops; Repair; Diseases; Picking of leaves; Calculation of cost; Outturn.]

*Varieties.*—The *pan* crop is probably the most important garden crop in India and is one of the most profitable of all crops, and as the knowledge of the cultivation of this crop is almost confined to the *baruis*, and is considered a secret by ordinary cultivators, a few notes on the method adopted by the *baruis* in Bengal may be of interest. The three main varieties are *Deshi*, *Sanchi*, and *Mitha*, but there are some special sub-varieties, such as *Nuntia-Bantul*, *Ujani* (Backergunge), *Maghai*, *Karpurkath*, which are specially appreciated by the connoisseur. The finest *pan* is grown at Bantul half-way between Ulubaria and Midnapur and in the Contai subdivision of the Midnapur District.

*Soil.*—High land above inundation level is necessary, as stagnant water is most injurious to this crop. Black friable clay loam resembling tank earth, containing a large proportion of organic matter, is the soil ordinarily chosen, but the best *pan*s are grown at Bantul on light loam slightly reddish in colour. The soil should be rather moist though high, and some of the best *pan* gardens of Backergunge actually get about six inches of water at high tides during the rainy season. But when the flood is higher the damage done is very serious.

Cultivation in the ordinary sense is not required for *pan*, hence the proverb *Bina chashe pan*, i.e., no cultivation for *pan*. Being a perennial creeper grown in moist soils with plenty of manure, under shade, and the planting being done in the rainy season, watering after planting being done when necessary, it naturally requires no irrigation except in dry regions. A garden when once established will go on yielding crop after crop for ten to thirty years.

*Preparation.*--After selecting the site for the *baroj* or garden, shrubs and trees growing on it are uprooted, or burnt down, and a trench is dug round it, the earth dug out being spread on the land chosen to raise it a few inches above the surrounding land. At Bantul they believe in spading the soil to a depth of eighteen inches, pulverizing the soil very fine, and levelling it, before putting on the roof. The frail roofing and fencing have the object of securing shade, evenness of temperature and security from high winds, which are essential conditions for the successful cultivation of this crop. Rows of bamboo or other substantial posts are planted, about seven feet remaining above ground. Over these are placed *dhaincha* or jute stalks and sometimes a light thatch of *ulu*-grass is also put above the *dhaincha* or jute stalks. The *baroj* is fenced all round with the same materials. Each row of cuttings is planted between two lines of uprights at intervals of six inches between the cuttings. The cuttings are taken from plants two years or more old. They are cut into lengths of twelve to eighteen inches containing five or six joints each, of which two are buried in the earth, and the portions left above ground are made to recline on the surface. These are then covered with date leaves and watered if necessary, every morning and evening until they strike root and put forth buds. The planting time extends from May to November. Planting cuttings in nurseries and then transplanting are also practised. As the vines grow, one or two jute or *dhaincha* sticks are stuck into the ground close to each other, the upper ends reaching the roof. The vines are tied to these supports with *ulu* straw or *dhaincha* fibre. When the plants reach the roof they are bent down and when sufficiently long a lump of earth is put on the stem which is thus secured to the ground, and the bud end bent upwards and tied to another support. This process is repeated, and there are usually three bending downwards in the year. Every time a plant is trained in this way two or three mature leaves are cut away from where the bending downwards and upwards takes place. In putting earth along the base of the creepers from the two sides the land gets divided into ridges and furrows, the plants growing on ridges, while the walks alongside them are in furrows. Dried and pulverized pond mud, dried and powdered cow-dung and powdered oil-cake, are used each time earthing is done. Castor-cake is said to be injurious to *pan* plants, and mustard-cake alone is used in Bengal. Brick-dust is also used as a manure. During

the dry months watering has to be done constantly, but stagnant water in *barojas* should be avoided at all seasons.

Gourds and pumpkins are usually planted round *barojas* to give additional shelter and profit. The roofs and fences have to be changed every third year.

This is the method in vogue in Bengal: that adopted in the drier regions of India is very different, and an account of this latter by Mr. R. S. Hioremath will be found in the *Agricultural Journal of India* (1908).

Fungus and insect pests and snails do great damage in *pan* plantations. Fumigation and hand-picking of insects and snails can alone be suggested. Sulphur or chlorine fumigation can be done in the case of fungus pests, but to keep off moths, etc., cowdung cake smoke is sufficient.

When planting is done in July, in Bengal, plucking commences in October and when planting is done in October, plucking commences in May. After plucking has once commenced, two pluckings are made every month. Two to four leaves are received each time from each plant and in the rains four to six leaves. All the leaves from an old stem are cut away after a new bent has taken root. One acre of land yields about 80 lakh *pan*-leaves per annum, besides inferior leaves from side shoots which are, as a rule, nipped off, except those kept for making cuttings. For five years the plants are in full bearing, after which there is a tendency for the yield to fall off. The leaves, after being brought home in baskets, are sorted and counted by the female members and arranged in bundles of *puns* or hundreds.

*Cost per acre---*

|  | Rs.   | A. | P. |
|--|-------|----|----|
| <i>1st year---</i>   |       |    |    |
| Purchase of 500 bamboo posts and wooden (Jiwol) posts, 7 cubits in length, for the support of roof and for fence .. .. | 40    | 0  | 0  |
| Purchase of cane or cocoonut fibre rope for tying .. ..  | 7     | 0  | 0  |
| Bamboo slips (long strips) .. ..   | 50    | 0  | 0  |
| <i>Dhaincha</i> stalks .. ..   | 25    | 0  | 0  |
| <i>Ulu</i> for thatching .. ..   | 15    | 0  | 0  |
| Purchase of cuttings at Rs. 2-8 per 1,000 .. ..  | 50    | 0  | 0  |
| 12 maunds of mustard-cake .. ..  | 15    | 0  | 0  |
| Baskets .. ..  | 1     | 0  | 0  |
| <i>Dhenki</i> for crushing oil-cake .. ..  | 3     | 0  | 0  |
| Cost of cutting channels and spreading earth .. ..   | 5     | 0  | 0  |
| Ploughing and pulverising soil .. ..   | 6     | 0  | 0  |
| Coolies for planting, thatching, roofing and fencing .. ..   | 36    | 0  | 0  |
| Coolies for plucking leaves, earthing and manuring .. ..   | 288   | 0  | 0  |
| Rent .. ..   | 10    | 0  | 0  |
| <i>2nd year---</i>   |       |    |    |
| Purchase of bamboos, betel-nut posts and <i>dhaincha</i> stalks .. ..  | 100   | 0  | 0  |
| Cane or coir-rope .. ..  | 4     | 0  | 0  |
| 36 maunds of mustard-cake .. ..  | 45    | 0  | 0  |
| <i>Ulu</i> .. ..   | 20    | 0  | 0  |
| Wages of the permanent labourers for plucking leaves, earthing and manuring .. ..                                      | 288   | 0  | 0  |
| Rent .. ..   | 10    | 0  | 0  |
| Carried over ..  | 1,018 | 0  | 0  |

|   |    | Rs. | A.    | P.  |
|---|----|-----|-------|-----|
| Brought forward                             |    | ..  | 1,018 | 0 0 |
| <i>3rd year—</i>                            |    |     |       |     |
| Purchase of 150 bamboo posts, 7 cubits long | .. | ..  | 6     | 0 0 |
| Slips of bamboo and betel-nut trees         | .. | ..  | 50    | 0 0 |
| Cane or rope                                | .. | ..  | 3     | 0 0 |
| <i>Ulu</i>                                  | .. | ..  | 3     | 0 0 |
| 36 maunds of mustard-cake                   | .. | ..  | 45    | 0 0 |
| Wages of the permanent labourers            | .. | ..  | 288   | 0 0 |
| Rent  | .. | ..  | 10    | 0 0 |
| Total of three years                        |    | ..  | 1,123 | 0 0 |

Every fifth year the expense is increased as the thorough overhauling of the *baroj* is required. The total expenditure in ten years is about Rs. 4,600, and the average per annum about Rs. 460.

*Out-turn.*—Taking 3,000 leaves per rupee as the average price of *pan*, the out-turn at 80 lakh leaves per annum may be estimated at about Rs. 2,500. Allowing half this amount for damages due to insect and fungus pests and accidents, the gross income may be safely put down at Rs. 1,200 or Rs. 1,300 per annum.

## CHAPTER LXVI.

### BETEL-NUT (ARECA CATECHU).

[Where principally grown; The *mandar* grove; Seedlings; Planting; Gathering of nuts; Magnitude of the industry; The betel-nut plague.]

THIS is grown as a regular crop in the districts of Backergunge, Noakhali and Tippera. The seedlings and young plants are grown in these districts under a papilionaceous tree called *mandar* (*Erythrina Indica*). It enriches the soil and gives the seedlings and young trees the necessary protection from high winds and scorching rays of the sun. The plantation of *mandar* is made in this way: Branches about 6 ft. long are planted in February or in April (not March), in rows twelve to fifteen feet apart each way. After two or three years, on high lands, and four to six years in low lands, the plantation is ready for the betel-nut seedling.

The betel-nuts are sown in October or November, the seeds being deposited four to five inches apart. The seed-nurseries are either close to the homestead in shady places, or if conveniently situated, they are made in the *mandar* groves themselves. The transplanting is usually done after two years, sometimes three or four years. In high lands the transplanting is done in July and in low lands in February or April. In the first transplanting, the betel-nut seedlings are planted equi-distant from the *mandar* trees, i.e., twelve to fifteen feet apart. But another transplanting takes place when the first trees have come into bearing. Before this is done the *mandar* trees are cut down or only a fringe left around the circumference of the grove. The betel-nut trees in a

fully planted grove are about six to seven feet apart each way. A certain amount of irregular planting goes on every year as vacancies occur, and in many gardens plants, big and small, can be seen every two or three feet apart.

The regular flowering season is February and the plucking season October and November. The flowers forming in January will ripen fruit in October and those forming in March will fruit in December and January. The fruiting begins in the sixth or seventh year, but in crowded plantations not usually before the tenth year. The trees put out in the plantation, when the first plants are in bearing, do not fruit for twenty years after planting. Old betel-nut lands replanted with betel-nut trees after the usual preparation of planting *mandar*, etc., do not begin to bear for twenty years after replanting. A plantation is in full bearing after thirty years. The fruiting life of a tree may be put down at 30 to 60 years and the total life 60 to 100 years. Occasional top dressing with tank earth or other earth and hoeing or clearing of jungle are all the operations necessary after the plantation has been once established. According as the soil is clayey or sandy, an average of eight or fifteen maunds of betel-nuts per *kani* (5 bighas 4 cottas), a crop worth about Rs. 100 is obtained per annum, without much trouble. The crops of large gardens are sold by auction, and the owners have not even the trouble of plucking the nuts. Plucking has to be done with the help of expert labourers who can jump from one tree to another without getting down and climbing again.

The magnitude of the betel-nut industry of Backergunge and Noakhali may be inferred from the fact that from these two districts 30 to 40 lakhs of rupees worth of betel-nuts are exported annually to Calcutta.

The betel-nut crop is subject to a severe fungoid plague which has been the subject of recent investigation. Nothing definite is as yet known regarding the nature of the disease and its remedy. It seemed at one time to threaten the very existence of the betel-nut tree in Bengal, but the disease spent itself, and it is now seen only in an endemic form.

## CHAPTER LXVII.

### CAMPHOR, TEJPATA, AND CINNAMON.

CAMPHOR (*Cinnamomum Camphora*).—The healthy manner in which two rows of these trees are growing at the Sibpur Botanical Garden leads one to expect that there may be a future for the camphor-extracting industry in Bengal.

The camphor tree is found in China, Japan and some of the adjacent islands, including Formosa and the Loochoo islands. It grows wild on hill-sides and well-drained valleys where the



rainfall is abundant in summer. It is an ever-green tree, which is not able very well to stand frost, belonging to the laurel tribe, to which also belong cinnamon and *tejpátá* trees. It attains a height of 60 ft. and more, and the trunk attains a diameter of twenty to forty inches. The leaves are broadly lanceolate and acuminate at both base and apex. The tree has been successfully introduced into Madagascar, South America, Egypt, Italy and France. The soil best adapted for growing this tree is sandy or loamy soil which is not inclined to be wet. Manured properly, it grows rapidly and attains a height of 30 ft. in ten years. The berries of the tree are eaten by chickens and other fowls, and the wood of the tree affords a valuable timber for ornamental works. Irrigation is needed to keep the seedlings and young trees alive in places where the rainfall during the summer months does not exceed fifty inches. It is easily propagated from seed, also from cuttings. The seeds should be collected in October and November, dried and kept packed up in dry coarse sand until sowing time in May or June. The soil of the seed-bed should be of the usual character, *i.e.*, sandy loam mixed up with about one-third leaf-mould. The seed-bed should be kept covered up with mats in the usual way, and it should not be allowed to get too dry. The soil-temperature should not be over 75°F. at the time of germination, though the external temperature may be as high as 85°F. The conditions favourable for the propagation of camphor trees can be secured in some places of Northern Bengal, in Assam, and in the lower hills generally throughout Northern India and in Mysore (where some trees are growing in a healthy manner). The seedlings will grow at a higher temperature than 85°, but the plants in that case will be lacking in vigour. The seedlings may be grown in pots for one to two years until they are ready for transplanting to fields or hill-sides. They are ready for transplanting when they have attained a height of 20 to 40 inches. They should be planted 20 ft. apart, and after 5 years another lot of seedlings may be planted in between the rows, so that when the plantation begins to be used for the distillation of camphor after 10 years, one lot of plants may replace an older lot. Trees may be cut down when they are 10, 12, 15 or 20 years old, according to their growth and the thickness of the plantation. If space can be allowed for a tree to grow uninterruptedly for 20 years, it is best to use it after this period; but younger trees may be lopped if the growth is thick. The largest proportion of camphor being contained in the older and larger roots and diminishing proportion in the trunk, branches and leaves, it is necessary finally to dig out the entire tree to get the maximum yield of camphor. Even leaves and twigs, the distillation of which is neglected in China and Japan, yield for every 80 lbs. about 1 lb. of crude camphor.

The trees are felled with the axe and the larger roots duly cut. They are then cut into chips, and the fresh chips put in a conical wooden trough, 40 inches deep and 20 inches in diameter

at the broader base. The bottom of the trough is perforated and fitted on to an iron pan of water set on a masonry furnace. The trough has a tight-fitting but movable cover, which is removed for emptying the trough of chips and putting in a fresh quantity. The trough is surrounded by a layer of earth six inches thick to keep the temperature inside it as uniform as possible. A tube, usually made of a bamboo, extends from the top of the trough to a condenser, which consists of one wooden trough being placed on another, the lower one containing water, and the upper one, which is placed in an inverted position, as a sort of cover to the lower one usually containing clean rice straw on which the camphor crystallizes. The lower trough is larger than the upper trough, so that when the former is two-thirds full of water, the edges of the latter are just below water. A continuous flow of water is kept up from the upper part of the covering trough, the excess running out from a hole at the top part of the side of the lower trough. The camphor oil floats on the water inside the lower trough, and the camphor crystallizes in the rice straw with which the upper trough is filled or floats in the water at the lower trough along with the oil. After the stream has carried away the essential oil with it, it must not come in contact with metal of any kind, so the lid of the trough in which the chips are put, the tube leading to the condenser, and the whole of the condenser must be made of wood or other material but never of metal. One tub full of chips requires twelve hours distilling, 20 to 40 lbs. of chips yielding about 1 lb. of crude camphor.

The distillation of refined camphor out of the crude Japanese or Chinese camphor takes place in Europe. The European methods of refining are too delicate and complicated for description in a handbook of agriculture.

*Tejpátá* (*Cinnamomum tamala* and *Cinnamomum obtusifolium*).—Though a native of the Himalayas, growing at an altitude of 3,000 to 7,000 ft., this plant grows very well at Sibpur, in shady localities, and the tree is worth growing in moist and well-shaded places as the use of *tejpátá* as a spice is almost universal in India. A couple of small trees supply all the *tejpátá* needed for one family. The tree should be propagated from seed imported from Sylhet. Seedlings should be grown in seed-beds, and in two or three years transplanted into fields 10 ft. apart. The leaves can be plucked after the fifth year and the tree goes on yielding for fifty or a hundred years. But as shed leaves are just as aromatic, if not more so than the green leaves, stripping of green leaves which weakens the trees, is not necessary.

The true *Cinnamon* tree from the inner bark of the twigs of which the valuable spice is obtained, is the *Cinnamomum Zeylanicum*. This also grows at Sibpur. The bark of the twigs and roots of the Indian varieties may be scraped and dried and used instead of Ceylon cinnamon, which, of course, is the richest in aromatic properties. The oil obtained by distillation from

cinnamon leaves and roots of all kinds is almost identical with clove-cil, consisting chiefly of eugenol or eugenic acid. The roots of *Cinnamomum Zeylanicum*, also of *Cinnamomum tamala* and *Cinnamomum obtusifolium*, yield some camphor, though the true camphor tree (*Cinnamomum camphora*) is different.

## CHAPTER LXVIII.

### OTHER SPICES.

[Round pepper; *Jirá*; *Juan*; *Rándhuni*; *Eláchi*.]

BLACK or Round Pepper or *gol-marich* (*Piper nigrum*).—Like *pipul* (*Piper longum*) *gol-marich* grows as a creeper and the habits of the two vines are very similar. As *pipul* is grown in many parts of Lower Bengal under the shade of mango, jack and betel-nut trees, the growing of *gol-marich* under similar conditions may be attempted also in low-lying moist districts of Bengal. It grows in Assam, in Mysore, in Malabar, in Burmah, in China and in the Straits Settlements, and the attempt to grow it in the deltaic districts of Bengal is therefore likely to succeed.

The propagation of the *gol-marich* and *pipul* vines takes place, as in the case of *pan*, by means of mature branches or suckers. The branches, shoots or suckers are layered, *i.e.*, bent down into the ground, and when they take root they are severed from the parent vine and planted out in shade, and trailed on to trees. This is done at the beginning of the rainy season. The base of every vine is kept scrupulously clean and well manured with cow-dung cake which acts also as a mulch. Three or four years after planting the vines begin to bear in the cold weather.

The berries are brought down from the climbing vines with the help of a ladder. Black-pepper berries are boiled and dried in the sun before they are sent to the market. No preparation is necessary for the long pepper. Mr. Basu, Assistant Director of Agriculture, Assam, estimates the average yield from each vine of round pepper at one seer, valued at eight annas.

*Jirá* (*Cuminum cyminum*).—Though this spice is in daily use, like round pepper, in every household, its cultivation is unknown in Bengal. The *Jirá* seed of the bazar does not germinate, but as the plant is grown in the Punjab and Afghanistan, attempt may be made to obtain fresh seed and sow it in November or December in sandy loam soil, *viz.*, such as is ordinarily preferred for growing anise, coriander, *juan* and wild celery (*Rándhuni*). The crop has been successfully cultivated in Baroda, where after preparation of the land and irrigation, seed is sown in December.

*Rándhuni, etc.*—The wild celery of Bengal needs no such careful tillage or attention as the European celery does. It occupies the field longer than coriander, anise, *juan* and other garden herbs; that is, while the latter ripen in March, the former is not ready

before July. Five seers to half a maund of seed per acre is used, according to the size of the seed, more being required in the case of coriander and anise, than in the case of *juan* and *rándhuni*. After manuring and cultivation the seed is broad-casted. A hand-weeding, accompanied by thinning, follows after the plants are about six inches high. No further notice is taken of the plants until harvest time, when the plants are cut, and when thoroughly dry, the seed is separated out by beating and winnowing. Five to fifteen maunds of seed are obtained per acre, the latter figure applying to coriander and anise which are heavier yielders than *juan* (*Carum copticum*) and *rándhuni*. *Sulpa* (*Fumaria parviflora*) is a semi-wild spice which is eaten also as a pot-herb. Like the other garden herbs mentioned, this also is occasionally sown, but it is oftener found coming up spontaneously along with the other spices, seeds of which usually contain a mixture of *sulpa* seed.

*Eláchi*.—There are two kinds of *eláchis* or cardamoms in common use as spice,—the *Bara-eláchi* or the greater cardamom (*Amomum subulatum*), which is grown in the lower valleys of Bhotan and Sikkim, and the *Chhota-eláchi*, or the lesser cardamom (*Elettaria cardamomum*), which is grown in moist soils in Western and Southern India. The plants are not unlike ginger plants, and they are perennial. The rhizomes go on growing from year to year and new plants come up from them. The older the rhizome is, the larger the number of flowering and fruiting stems sent out. The fruit of the lesser cardamom is bleached with soap-nut (*ritha*) water and then starched. The larger cardamom has been introduced with success in the district of Bogra.

Propagation may take place either by means of bits of rhizomes, or from seed. Highly manured seed-beds and fields are needed. Protection from sun is needed by the plants, and from sun and rain by the seed and seedlings. The soil of the cardamom field should be moist all the year round, but not water-logged. In the valleys of Sikkim and Bhotan, beds or fields are made alongside mountain streams, whence water is taken along narrow channels alongside of which the cardamom plants are grown on ridges. This arrangement secures constant moisture and freedom from water-logging. The shade of betel-nut gardens, easy of irrigation, might be utilized for growing *eláchis*. The seed may be sown on raised seed-beds in October, or the rhizomes planted in June or September on long and flat ridges through the middle of which water can be made to flow down in a slow current throughout the dry season, keeping the ridges alongside constantly moist but never water-logged.

## CHAPTER LXIX.

### OPIUM (PAPAYER SOMNIFERUM).

[Soil ; Manures ; Rotation ; Seasons for cultivation ; Tillage ; Sowing ; Irrigation ; Thinning ; Weeding ; Harvesting ; After-treatment ; Cost ; Manufacture ; Trash ; Seed and Oil.]

*Soil.*—Heavy loam or sandy loam near a village site, rich in saltpetre, is preferred for this crop. The land should be close to a well, the water of which is known to be impregnated with nitre.

*Manures.*—Nitrogenous manures, such as well-rotted cowdung (150 to 200 maunds per acre) and crude saltpetre (40 seers) are in general use for this crop. Cowdung cake (20 maunds), ashes (4 maunds), oil-cake (6 maunds), or lime (160 seers) per acre, are also used for top-dressing.

*Rotation.*—It usually follows maize or millet, the preparation commencing immediately after maize or millet harvest.

*Season.*—In the hills the opium season is from February to June and in the plains from October to March.

*Tillage.*—The land should be cultivated as often as possible and brought to a fine tilth before sowing.

*Sowing.*—The seed is sown mixed up with dry earth in February or October, as the case may be, usually broadcast, at the rate of 3 lbs. per acre. Camphor-water steep should be used for this (as for all small and delicate seeds) before sowing as a preventive against blights and for hastening germination.

*Irrigation.*—As soon as the seed begins to germinate, *i.e.*, in about a week after sowing, the field is divided by ridges into rectangular compartments, 8 ft.  $\times$  4 ft., the alternate ridges being made broader, as along them water is carried down into the fields. Watering should be done as soon as germination has taken place and re-sowing where germination has failed. Irrigation is carried on at regular intervals until the crop matures.

*Thinning.*—When the plants are two or three inches high they are thinned out. The thinning out of sickly plants is repeated, until healthy plants are left seven to eight inches apart.

*Weeding.*—This takes place along with thinning.

*Flowering.*—Seventy-five to eighty days after germination the plants flower. The petals (four in number) are carefully removed when fully expanded and matured, *i.e.*, about the third day after the flower opens. These “flower leaves” are employed in the formation of the outer casing of the opium cakes. In another eight or ten days the capsules are sufficiently developed for incision. From January to the middle of March and sometimes till later, extraction of the juice goes on in the plains.

*After-treatment.*—After the poppy is off the soil, the land is allowed to lie fallow till the rainy weather crops are sown.

*Cost of cultivation per acre :—*

|   | Rs. | A. | P. |
|---|-----|----|----|
| Eight ploughings .. .. .                                  | 6   | 0  | 0  |
| Clod-crushing .. .. .                                     | 0   | 4  | 0  |
| Seed .. .. .  | 0   | 2  | 0  |
| Sowing .. .. .  | 0   | 3  | 0  |
| Making water-beds .. .. .                                 | 0   | 3  | 0  |
| Watering six times .. .. .                                | 9   | 8  | 0  |
| Four weedings with thinning .. .. .                       | 8   | 0  | 0  |
| Harvesting (8 coolies at 2 as. a day for 15 days) .. .. . | 15  | 0  | 0  |
| Manure .. .. .  | 4   | 0  | 0  |
| Rent .. .. .  | 10  | 0  | 0  |
| TOTAL .. .. .   | 48  | 4  | 0  |

*Products.*—The products and by-products of the poppy are (1) Opium, or the inspissated sap of the unripe capsules. (2) *Pasewa* i.e., the moisture and soluble ingredients which drain from the opium. (3) Poppy petals, already spoken of. (4) “Trash” or powder prepared from the dried stems and leaves. (5) Poppy heads or capsules. (6) Seed and oil.

*Opium.*—The capsules are lanced in the afternoon by the cultivator and the members of his family. Three small lancet-shaped pieces of iron are bound together with cotton, about  $\frac{1}{2}$ th of an inch alone protruding, so that no discretion may be left to the operator as to the depth of the wound to be inflicted. The incision is made from the top of the stalk to the summit of the pod. Each capsule is lanced three or four times and sometimes as many as eight or ten times before all the milk is drawn out of it. The drug is collected early in the following morning into small trowel-shaped scoops of thin iron. The opium is transferred to a metal or earthen vessel, and it is taken to the cultivator’s house for further manipulation. The *pasewa* drains off and is kept in a separate vessel, and the opium is turned over by hand from time to time at intervals of not more than a week. When 25 to 50 lbs. have been collected, it is tied up in double bags of sheeting cloth. One healthy plant may yield as much as 75 grains of opium with five to eight scarifications, and an acre 24 to 50 lbs. An acre will yield 200 to 600 rupees worth of opium, the cultivator getting Rs. 2-8 per lb.

*Pasewa.*—This is the dark coffee-coloured fluid which collects at the bottom of the vessels in which the freshly-collected juice of the capsules is placed by the cultivators when it is brought home. The shallow vessels are filled to such a degree that the *pasewa* can drain off and be collected and sent in separately for weighment. It consists of the most soluble of the principles of opium dissolved in dew or in moisture. It contains meconic acid, resin, morphia, and narcotine. *Pasewa* is not present in opium collected during strong westerly winds or in the absence of dew.

*Leaves.*—The mature petals after being collected are spread in a handful at a time over an earthen plate placed over a sowing

fire. They are covered with a moist cloth above, which is pressed, until the steam from the cloth, acting upon the resinous matter contained in the petals, cause them to adhere together. The thin cake of petals thus formed is turned over in the earthen plate, and the process of pressing and consolidation repeated on the reverse side. These thin sheets pasted together with *lewa* or inferior opium and *pasewa*, form the shell or outer casing of the opium exported to China.

*Trash*.—The pounded stems and leaves of the poppy plant when dry at the end of the season are used for packing the cakes.

In the Government Factories the opium brought in by cultivators is examined according to consistence, colour, texture and aroma, classified, mixed up, moulded into cakes and packed. The constituents of an average cake exported to China are:—

|                |    |    |    |       |      |        |
|----------------|----|----|----|-------|------|--------|
| Standard opium | .. | .. | .. | 1 sr. | 7 50 | chtks. |
| Lewa           | .. | .. | .. | ..    | 3 75 | ..     |
| Leaves         | .. | .. | .. | ..    | 5 43 | ..     |
| Poppy trash    | .. | .. | .. | ..    | 0 50 | ..     |

One man turns out about seventy cakes a day. The cakes require much attention and constant turning or else they get mildewed. The mildew is removed by rubbing in dry poppy trash. Weak places are also strengthened by extra leaves. By October the cakes are dry to the touch and fairly solid when they are packed in chests furnished with a double tier of wooden partitions, each tier holding twenty cakes. Each case contains 120 catties (160 lbs.). This is the Chinese opium. What is intended for internal consumption is made in this way:—It is hardened by exposure to the direct rays of the sun till it contains only ten-per cent. of moisture. It is then moulded into square bricks weighing one seer each, which are wrapped in oiled Nepal paper and packed in boxes furnished with compartments for their reception. This opium has not the powerful aroma of the 'cake' drug meant for China, but it is more concentrated and more easily packed.

*Seed and oil*.—After extraction of opium from poppy capsules, the ripe seed loses its bitter and narcotic principles, and it is then a wholesome article of diet. Poppy-seed is largely consumed cooked as an article of food. Even after the extraction of oil, the residue or oil-cake is eaten by poor people. Poppy-seed-cake is richer in phosphates than other cakes. The oil is pressed out when the seed is fresh, with an ordinary *ghani*, and it is clarified simply by exposure in shallow vessels, to the sun. Poppy-oil is used in Europe for making candles, soap, paint and artists' colours, also for cleaning delicate machinery. The average produce of seed per acre is three maunds, and the yield of oil, when the seed is fresh, is thirteen seers per maund. One and-a-half seer of seed is sown per acre. The seed sown in Malwa is imported from Persia.

## CHAPTER LXX.

### TEA (*CAMELLIA THEA*).

[Natural habitat and history; Varieties; Seed and seed-gardens; Cultivation; Picking; Withering; Rolling; Firing; Fermenting; Cost; Chemistry; Black and Green teas; Tea-seed.]

THE *natural habitat* of the tea plant is the chain of hills which passes through Tippera; Lushai, Chin, Manipur, Naga, Patkai and Kamti, whence it has spontaneously distributed itself by natural means to the adjacent valleys and plains, east and west, altering in size owing to the changed climate and soil of the plains. The tea plant was not originally introduced into India from China as is generally supposed. The natural habitat of the tea plant being the hills of Assam, the suggestion has been made to use Assam hill-seed from wild trees or propagating tea bushes in the Darjeeling hills. Naturally seed collected from tea plants in plains or seed-gardens does not thrive at high elevations, and even seed gathered from wild tea plants growing in the plains has often given a poor result. Plains seed should be used for plains and hill seed for hill and the indigenous varieties preferred. When seed from the indigenous stock is used it should be sown in seed-beds in shade, as naturally the tea plant grows in thick jungles. There should be exchange of seed from one region to another.

Drs. Watt and Mann regard the Manipur, the Assam indigenous and the Naga races of tea as truly indigenous Indian races, the rest being regarded by them as derived from the China race, either as culture-variations or hybrids. The China race has no tendency to grow into tall trees like the Manipur, Assam and Naga varieties. The leaves of the Lushai or 'Cachar indigenous' race are the largest of all, some specimens being 12 to 14 inches long and 6 to 7½ inches wide. The Naga type of leaf is narrower and smaller, 6 to 9 inches in length by 2 to 3½ inches in width. The Manipur or Burma type of leaf is slightly broader and leathery and coarser in texture. The 'Assam indigenous' has slightly smaller leaves, 6 to 7¾ inches long, while the typical China tea is 1 to 2½ inches long and less than ½ inch in width. Between the true China and the Assam varieties there are many accidental hybrids. The popular variety of tea known as "Assam hybrid" is not a true hybrid, the China and the Assam tea plants which were used for cross-fertilising being only different varieties of *Camellia Thea*. The so-called hybrid teas flush earlier, are not so affected by deficient rainfall, though they are more subject to the mosquito blight. Whether the production of a real hybrid between *Camellia Thea* and some other hitherto non-tea-producing wild *Camellia* will produce a stronger race of a tea, capable of resisting blights better, is a question which has not been taken up yet. That one *jat* of tea bushes is naturally healthier than another, is the common



experience of planters, and the question of true hybridisation of the tea plants may be pregnant with important consequences.

But what the planter needs most at the present crisis through which the tea-making industry is passing, is not the discovery of a disease-resisting *jat*, but the renovation of the soil. The two factors to the problem are : (1) exhaustion of soil, and (2) growth of special parasites, both fungoid and animal, which are encouraged by the constant presence of a suitable host-plant. The exhaustion of soil can be best met by the application of suitable manures and by deep hoeing once a year or oftener, supplemented by several light hoeings during the season. The manures especially applicable to a crop of which the leaves are used, should be particularly rich in potash and nitrogen, also lime. A practice of growing, *mati-kalai* (*Phaseolus mungo*) or *Dhaincha* (*Sesbania aculeata*) between tea plants has sprung up of late years, and its effect is said to be excellent on the tea bushes. Castor-cake is an excellent manure. Rape or mustard-cake may also be applied for renovating the soil. The soil should be kept stirred deep and well, once during the dormant period, *viz.*, December to February, after which, application of rape-cake or other manure may follow between the rows of plants, and then when any pests are noticed, spraying of the bushes with a mixture of sulphate of copper and lime (1 : 10 with 200 parts of water), then dusting with soot and alum, may be resorted to. The flushing of leaf coming after such cultivation and manuring and application of insecticides and fungicides, should be healthy and free from blights of all sorts. Picking of spotted and crumpled up leaves during the dormant period, and burning them, should be also practised.

The seed should never be gathered from gardens where leaf is picked, but from special seed gardens or from wild plants. It should be kept in almost dry earth throughout winter and sown in March in seed-beds. When a year old, the seedlings are planted out from four to five feet apart according to circumstances. On no account should two races of tea be planted on the same plot for the purpose of "blending." For the first two years no plucking is done, but the plants are kept pruned in the cold weather. The pruning of young tea is a difficult matter, and for details regarding it reference must be made to the special authorities quoted later. The first plucking of leaves takes place in the third year, after which the plucking goes on many times in the year as long as the bushes are alive. The first picking is usually done in April. This makes almost as good tea as that made out of October-November picking. The picking should be done carefully, so as not to bruise the leaves, nor injure tender shoots. The monsoon pickings go to make the coarsest tea. About 2,000 plants go to an acre, and the yield from a mature plantation may vary from 200 to 1,000 lbs. according to conditions. The average in India is 450 to 500 lbs. The bushes go on yielding the full quantity for twenty to thirty years at least.

*Withering.*—The leaves are exposed to air in the shade for about eighteen to twenty hours after plucking in specially constructed houses, after which they have become limp and flabby and capable of being rolled. The changes which take place during this operation are profound. The essential oil increases rapidly, as also the oxidising enzyme which acts upon the tannin at a later stage of the process. If the leaves are bruised or injured, they do not wither properly and are little good. In sound leaf, the commencement of fermentative change can be observed at the end of the broken stem, where the constituents of the sap become oxidised and gradually pass through stages of colour from coppery and dark-brown to black. The amount of moisture which should be allowed to evaporate varies considerably, according to the *jat* of leaf, the time of year, and the weather, but about 33 per cent. yields the best results. The object is to make the leaves fit for rolling, as wilted leaves take and keep a good twist without breaking. The colour during the oxidation process becomes uneven if the withering is allowed to go too far. If the atmosphere is very moist, it may be necessary to employ artificial heat and a forced draft in the withering process, but the temperature should never exceed 100°F., and the heat should be gradually reduced to 85°F. or less, when the leaf is nearly ready. The leaves gathered on a wet day should be allowed to get a little over-withered that the weaker sap may be concentrated to the standard proportion, and they should be also subjected to a hard and prolonged rolling to break all the cells (charged with more than the usual proportion of moisture) and distribute the juices all over the leaves. Leaves gathered in fine weather require less withering and rolling, the sap being more concentrated. When properly withered, the leaves give out a fresh and pleasant aroma, different from the vegetable smell of badly withered leaf. When the atmosphere is saturated with moisture, natural withering even in very hot weather does not take place readily, and artificial arrangements for withering are always desirable, as then the conditions as regards hygroscopicity and temperature and time can be regulated to exactness. Temperatures higher than 100°F. can be employed for a short time if the leaves are wet, but when the external moisture has disappeared the temperature should be reduced to 90°F. and retained at 90°F. until the operation is concluded. The leaves in the baskets should never be pressed down, but remain loose, and they must be brought to the withering room in as fresh a condition as possible.

*Rolling, etc.*—The object of rolling the leaves is to distribute the juices contained inside the cells over the surface of the leaves by breaking the cells up. The juices thus brought to the surface are easily obtained in the tea infusion. In the process of rolling a great deal of oxygen is also absorbed, and the tannin assumes a dark colour and becomes partly insoluble and partly it combines with the albuminoids of the leaf forming an insoluble leather-like

substance. The rolling machine should be situated in the coolest part of the factory. After rolling and re-rolling, the leaves should be passed through a *revolving sieve* to break up any lumps and immediately afterwards placed in the *fermenting room*. The fermentation room should be well removed from the engine room and it should have an even temperature which is secured by a double roof. There should be a drain in the middle of the fermenting room that the room may be washed and cleaned daily after the day's operation is over. In cool weather the rolled mass of tea leaf is kept six inches or eight inches thick, and in hot weather two to four inches thick and turned every half hour to prevent overheating. About 80°F. is the best temperature, and when the surrounding atmosphere is 90° or 95°F. and rather dry, the atmosphere should be cooled and moistened by hanging wet cloths in the room. Properly treated the leaves should be of a bright green colour after the rolling operation, and of a reddish tint half an hour later. This change continues until the younger leaves and stems are a bright coppery colour, while the older and less perfectly rolled leaves are partly reddish and partly green. Under normal conditions fermentation goes on for two to four hours, after which the leaf is re-rolled and dried, in special machines, in a current of hot air at a temperature of 200° to 270°F. A more even colour is obtained by sorting the leaf and placing the different grades in separate heaps to ferment after the rolling operation, whereby the older leaf can remain for a longer period without injury to the other. Should the leaf have been over-withered and the sap reduced to too great a degree of concentration, the colour obtained in the fermentation will be dull and dark instead of bright coppery; this can be partially remedied by moistening the leaf with clean water, either during the first rolling, or when the leaf is put to ferment, by which means the concentrated sap is better diffused over the leaves.

In all cases the leaf and the atmosphere of the fermenting room must be kept damp by sprinkling with cold water, and it is advisable to protect the leaf from draughts of dry air. If this is not done, the surface of the heaps will assume a blackened appearance, owing to the leaf drying up, and the too rapid oxidation of the tannin and colouring matter. A perfectly moist draught of air would probably not be of any harm. Direct rays of the sun in the fermentation room must be avoided. Experiments have shown that a certain moist condition of the atmosphere and of the leaf itself, is necessary to obtain the desired colour, and also that the best results as regards flavour, pungency, etc., are obtained when the temperature of the leaf does not rise spontaneously above 82° to 84°F. If the leaf is placed on a cement floor, where the heat is partially absorbed as it is developed, it can be thicker than when placed on boards or cloth raised above the floor; and as a general rule, the cooler the day the thicker can the leaf be placed to obtain the necessary colour in a uniform time.

The *firing* usually takes place in two or three stages. The temperature employed for the first firing averages about 270°F., but during the second firing, when the leaf is partly dried, although the temperature employed in the machine is not so high as in the first instance, the leaf itself attains within a few degrees the temperature of the machine, since evaporation is not great. The temperature towards the end, *i.e.*, when the leaf has once become dry and crisp, should be reduced to somewhat below 212°F., say 180° to 200°F., and the draught employed should not be very great, so that the moisture will not be driven away rapidly. If the firing operation is hurried too much, the tea loses in aroma. By ten minutes' firing in a "Victoria" at 260° to 280°F., the oxidized tea loses fifty per cent. of moisture. If the "Sirocco" is afterwards employed, as is usually done, the remainder of the moisture is evaporated at a slower rate.

When the leaf has been fired and oxidized, it is ready for packing, which is done with lead in well-seasoned wooden boxes.

*Cost—*

|   |    |        |     |       |
|---|----|--------|-----|-------|
| Manufacturing charges                   | .. | Rs. 12 | per | acre. |
| Establishment, including field labour   | .. | .. 65  | "   | "     |
| Manuring                                | .. | .. 18  | "   | "     |
|   |    |        |     |       |
|   |    | .. 95  | "   | "     |
| Profit of Rs. 5 per maund on six maunds | .. | .. 30  | "   | "     |
|   |    |        |     |       |
| Total cost                              | .. | .. 125 | "   | "     |

If Rs. 125 are realized per acre, and six maunds obtained as the outturn per acre, tea can be worked with profit.

The principal pests of tea plantations are the so-called Mosquito blight and the Red Spider. Against the former, pruning and hoeing and burning have been found useful, also spraying of Kerosene emulsion, and against the latter dusting of sulphur. For a full account of tea-blight, students are referred to the work on the subject by Drs. Watt and Mann.

The *chemical changes* that take place during manufacture of tea are numerous; one of the most important being an increase in the amount of essential oil, to which the flavour of tea is so largely due. A certain amount of volatile fatty acids is also developed from the splitting up of a portion of the albuminoid matter in the leaf, and the sap develops an acid reaction. Some of these on isolation have a sweet nutty flavour and aroma, to which the peculiar smell of properly oxidized leaf is due. If the process of oxidation is prolonged for many hours, the acidity of the sap rapidly increases and the leaf becomes sour and rancid, acids similar to those in rancid butter being developed. These can be got rid of, up to a certain extent, by firing, by exposing the leaf to a high temperature for a lengthened period, but only at the expense of the volatile oil which is dissipated with them. The astringency due to tannin is also greatly reduced during

this process of oxidation, the tannin being partly oxidized into an insoluble brown substance known as Phlobaphene and partly combining with some of the albuminoid matter, and which gives the leaves a tough, leathery and elastic character easily noticeable on handling. The albuminoid matter of the leaf is also partly coagulated by the acidity developed during the fermentation.

The following is an analysis of fresh tea leaf, by Bamber :—

|                           |    |    |    |    |        |
|---------------------------|----|----|----|----|--------|
| Essential oil             | .. | .. | .. | .. | 05%    |
| Fixed oil                 | .. | .. | .. | .. | 50     |
| Them                      | .. | .. | .. | .. | 4.10   |
| Volatile alkaloid         | .. | .. | .. | .. | Trace. |
| Tannin                    | .. | .. | .. | .. | 18.15  |
| Boheic acid               | .. | .. | .. | .. | 2.34   |
| Galic acid                | .. | .. | .. | .. | .83    |
| Legumin                   | .. | .. | .. | .. | 21.00  |
| Albumin and Globulin      | .. | .. | .. | .. | 1.00   |
| Waxes and Gums            | .. | .. | .. | .. | 2.88   |
| Pectin, Pectoses, etc.    | .. | .. | .. | .. | 12.60  |
| Amides                    | .. | .. | .. | .. | Trace. |
| Cellulose, fibre, etc.    | .. | .. | .. | .. | 21.20  |
| Phlobaphene, resins, etc. | .. | .. | .. | .. | 7.85   |
| Mineral matter            | .. | .. | .. | .. | 4.60   |

100

The seed of tea-bushes contains over 20 per cent. of fixed oil, which may be used either as lamp-oil or for soap-making. The oil-cake is less than half the value of castor-cake so far as nitrogen is concerned, and of very little value so far as phosphates are concerned. The cake being poisonous is useless as cattle-fool. The decoction of the cake may possibly be found useful as an insecticide.

The growing and manufacture of tea is a very technical process, and the reader is recommended to consult Bald's treatise on Indian Tea (Thacker, Spink and Co.), or the various publications by Mann, mostly issued by the Indian Tea Association, Calcutta.

## CHAPTER LXXI.

### COFFEE (COFFEA ARABICA).

[Situations suitable for the crop ; Varieties ; Planting ; Seed ; Pruning ; Harvesting ; Manufacture ; Fermentation ; Drying ; Peeling or Milling ; Widdowing and Airing ; Packing ; Prices ; Machinery.]

THIS crop requires a hilly, well drained, rich, ferruginous clay soil, *e.g.*, forest land, particularly rich in Nitrogen. Coffee prefers altitudes varying from 1,000 to 5,000 ft. The temperature best suited for this crop is 60° to 80°F. It grows best in a humid climate, *i.e.*, where there is some rain every month, but the total rainfall should not exceed 150 inches per annum. Frost is fatal to coffee plants. Heavy clouds and strong winds are also objectionable. In hot and dry places also, coffee has been grown successfully in shade. The Arabian coffee can stand drought better

than the Liberian coffee, which is preferred for moist localities. Though the cultivation of coffee is at present practically confined to Ceylon and the Lower slopes of the Nilghiris, the experiment of growing coffee elsewhere is worth repeating. In Ranchi, Mourbhanj, Chittagong, Darjeeling and parts of Burmah and Bombay, the coffee plant has been grown successfully, and in some Calcutta gardens also berries have been seen on coffee plants growing in shade. One experiment conducted in Chittagong gave nine maunds of berries per acre. In most of these places, however, the cultivation can only be considered a curiosity.

*Planting.*—Having selected a suitable site, the jungles should be cleared and burnt, belts of trees giving protection from high winds being left. The roads are then to be laid out and the coffee-house furnished with a good water-supply. Then a spot should be selected for a nursery which should be well-drained soil (situated on a slope of a hill), but close to water, that irrigation may be easily done when required. The soil should be rich and retentive of moisture, *i.e.*, full of humus matter. After spading and ploughing to a depth of about twenty inches, exterminating all the weeds, manuring the soil with about 200 maunds of farm yard manure per acre and raising the beds six inches above the surrounding soil, seeds should be sown six to nine inches apart, and two inches deep, and only one inch apart from one another along the furrows or lines. The lines should then be covered lightly and mats or palm branches thrown over the seed-beds. Watering should be done early in the morning or after sunset.

A bushel of seed will give 10,000 plants, sufficient for covering ten acres. When the plants have two to four leaves they should be carefully transplanted, in damp cloudy weather, from the seed-bed to the nursery and placed nine to twelve inches apart. The grounds of the plantation are "lined out" for the reception of the plants. A rope is furnished with bits of scarlet rag at the distance fixed upon, between the plants which is usually seven feet. It is stretched across the plot and stakes are inserted at each rag. The rope is then moved forward a stage at a time, gauged by measuring rods 7 ft. long. Or, a base-line is laid down straight up and down the slope, and a cross-line set off exactly at right angles. On this line stakes are driven into the ground at the distance determined upon for the position of the plants. To each stake a rope is fixed and stretched parallel with the base-line and as straight as possible. Small stakes are provided along these lines. A rope held across them at succeeding stages of equal width is guided by measuring poles 7 ft. long, and the small stakes are put in where the moveable rope crosses the fixed ones. Each stake indicating the site for a plant. The sowing and transplanting are done in the rainy season. The seedlings are planted out when a year old, and sometimes when two years old, in their permanent places in the plantation. Seven feet each way is the usual distance apart at which they are planted, about 1,000 plants going

to the acre. Holes are first made where the stakes are planted and then the seedlings removed, a ball of earth being taken up with each seedling, the planting done as soon as possible and the earth made quite firm after planting. Weeding is afterwards done as occasion requires. Staking with canes has also to be done for supporting the plants against heavy winds. Filling in blanks when any seedlings die or get sickly has also to be provided for and carried out. A fast growing small tree is usually grown alongside the seedlings to give them shade. Maize is a very good crop to grow, but it is rather an exhausting crop, and an upright leguminous crop, such as *araha*r, or *jainti* (*Sesbania cegyptiaca*), should be preferred, as these would go to enrich the soil. Trenching and manuring have also to be organised, the former as a means of draining. Weeds are put in these trenches as a source of manure. The trenches open into catch-drains, whence water runs off into drainage channels. Manuring with lime, oil-cake, cowdung, etc. is also done, as coffee is an exhausting crop. Forking or spading once a year to a depth of twelve to eighteen inches is also essential in the dry season.

After another twelve or eighteen months, when the plants are 3 to 5ft. in height, topping is done, *i.e.*, nipping off the central bud to check further growth in height. Topped in this way, the berries are more easily gathered and the yield is also heavier. Pruning is also done in such a manner that the plants may remain 5 ft. high and develop horizontally primary branches at intervals of about 6 inches throughout the height of the stem; and to form along these boughs a constant supply of secondary fruit-bearing twigs. All ascending and cross-wise branches or twigs are at once removed, so as to force the plant into the type of horizontal spreading branches which has the advantage of exposing to sun and light a large surface from which the crop can with ease be removed. All secondary fruiting twigs are pruned off after each crop is removed. Pruning should be finished each time before the next season's flower buds begin to form. The lateral or primary boughs should not be allowed to grow more than 2½ feet otherwise they will droop and exclude the light from those below. All broken, diseased and dead branches should be cut off.

The blossoms appear in March of the second or the third year and they go on appearing every year after. About October begins collection of the crop and preparation of berries. The collection of ripe fruits goes on from October to January. The bright blood-red fruits (*i.e.*, ripe fruits) are collected, but deep red or cherry coloured fruits which are not quite mature should be also collected at the same time to save labour.

**Manufacture.**—The manufacture of the 'berry' from the 'cherry,' as the ripe fruit is called, is accomplished in the following stages: (1) Pulping, (2) Fermenting, (3) Drying, (4) Peeling, milling or hulling, and (5) Winnowing and sizing.

(1) *Pulping*.—The pulp surrounding the beans is removed by a machine, called the Disc-pulper or Cylinder-pulper, when the cherries are still fresh. The Disc-pulper consists of rotating discs, the surfaces of which are covered with sheet copper roughened by having projections punched forward. It pulps 20 to 25 bushels of cherries per hour worked by three labourers. A double pulper of this type has two such discs and is furnished with a feeding roller and it pulps 40 bushels per hour worked by four to six coolies, or double this amount, worked by steam. The discs work against smooth iron beds so adjusted that the complete cherry cannot pass between them without getting torn upwards against the beds, and the projections on the discs tear off the pulp, allowing the beans to drop into one receiver and the fragmentary pulp to be carried into another. The Cylinder-pulper, in construction, is not unlike the cotton-gin which drags the lint forward and lets the seeds drop behind. A stream of water flows into the pulper all the time it is working. By means of sieves the cleaned beans are separated from partially pulped cherries, the latter being made to pass once more through the pulper. The stream of water with the stones is carried down from the loft by a tube which dips to the bottom of a basin known as the *hopper*.

*Fermenting*.—The stones are then fermented to remove from them the saccharine matter adhering to them, which renders it difficult to dry the beans. The stones are carried into tanks which are placed higher than the drying platforms on which the fermented beans are finally spread out. There are usually four fermenting tanks, two in which fermentation actually takes place and two in which the beans are afterwards washed. One of each is used for the produce of one day's pulping. All the stones pulped in one day are allowed to remain in the receiving cistern until fermentation has set in, *i.e.*, for 12 to 18 hours, according to the temperature. The stones are then run into the washing cistern and the receiving cistern made available for another day's produce.

*Drying*.—The washed beans are then carried to the drying floors or platforms where they are exposed to the influences of the sun and atmosphere. The floor is asphalted or simply made of concrete, or the ground is hardened and covered with a coir matting. The last method has the advantage of admitting of the surplus matting being thrown over the beans in the event of an occasional shower, but shed-accommodation, where the beans may be rapidly removed when rain comes on, is essential. During drying, the beans have to be constantly raked or stirred with coolies' feet. Too rapid drying, cracking of the beans, and disproportioned drying through careless raking are to be avoided.

*Peeling or Milling*.—The outer skin or 'parchment' of the beans is now removed. This is usually done by machinery in Europe instead of in the plantation. The beans are dried in the sun or artificially heated before they are put into the peeling machines.



*Winnowing and Sizing.*—The peeled coffee as it comes from the mill is subjected to fanning which drives off the parchment and skin, leaving the clean coffee behind. Then the coffee seeds are separated by mechanical means into different sizes that roasting afterwards may be uniform.

*Packing.*—The beans are put in cases, the timber of which will not spoil the aroma of the coffee.

Coffee, like tea and poppy or any other crop which is grown constantly in the same locality, is subject to many diseases caused by fungi and insects. Exhaustion of soil and heavy manuring are also talked of in connection with coffee cultivation, which is failing in some localities, especially in Ceylon.

In a well-cultivated estate an expenditure of Rs. 80 per acre is incurred on superintendence and field-labour, inclusive of peeling and freight, and an additional Rs. 50 per acre on manures and their application. In some coffee estates a total expenditure of only Rs. 80 per acre is incurred, but the result obtained is proportionately poorer. As half the area is manured annually, the total annual expenditure comes to about Rs. 110 per acre in a well-kept garden, and the annual average outturn coming to  $2\frac{1}{2}$  to 3 cwts., the crop sold at 60s. per cwt. leaves a small margin of profit, while at 40s. per cwt. coffee-growing does not pay at all. But in an estate where 50 rupees per acre is spent on manuring every alternate year, the average comes to 4 cwts. per acre. Growing of leguminous crops and application of bones are the manurial treatment recommended.

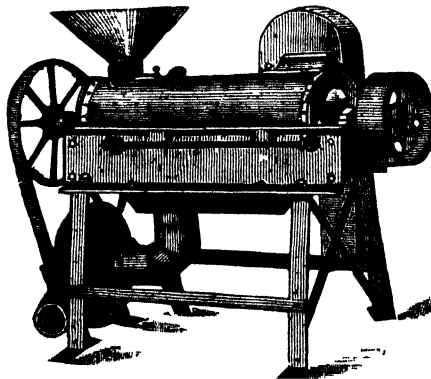

FIG 66—THE COFFEE HULLER.

The Engelberg Huller Company of New York supply all the machinery required for the manufacture of coffee. Their Coffee Huller and Separator No. 5, suitable for small plantations, separates 1,500 to 2,000 lbs. of cleaned coffee in 10 hours, separating the parchment from the coffee. The price of the machine is 200 dollars. A screen used for separating dirt, sticks, etc., before the

berries are put in the pulper is sold for 90 dollars. A hand-power pulper is sold for 100 dollars. The Coffee washer is made in two sizes, the smaller size being priced 150 dollars. Coffee graders are sold for 225 to 275 dollars each, according to size. A Coffee polisher is also made of two sizes, the smaller size being priced 250 dollars. The only advantage of using this machine is, all foreign material, dust, etc., mixed with the coffee is rejected by an exhaust-fan, keeping the coffee clean and cool and permitting a more brilliant polish. Coffee Hullers (Fig. 66) are not unlike Rice Hullers in general appearance and in their principle of construction.

## CHAPTER LXXII.

### VANILLA (*VANILLA PLANIFOLIA*).

VANILLA cultivation has been undertaken by a few European planters of Mysore, etc. Vanilla is an essence or flavouring substance obtained from the fruits of a climbing orchid found growing wild in the hot, humid forests of Central and South America, and a considerable portion of the vanilla of commerce is gathered from wild plants found growing in the forests of Mexico.

*Soil and Climate.* A rich loamy vegetable soil is the best for the vanilla. An undrained water-logged soil causes the roots to rot, and it is therefore quite unsuited to the cultivation of the orchid. The climate should be hot, and moist and sheltered situations are indispensable, but the plants must not be too much shaded, or the fruits will not ripen.

*Propagation.*—Cuttings four or five feet long are planted at the foot of trees, or other supports used for the vine to grow on, and in showery weather they soon take root.

*Cultivation.*—The fertilization of the flowers has to be done artificially, and it is necessary for the plants to be trained, so as to bring the flowers within reach of the hand. The distances at which the supports on which the vines are to climb are planted, should not be more than six feet. The holes should be filled in with rich loam mixed with sand and decayed leaves; and if the plantation be in the vicinity of the forest, the rich humus found on the surface of the ground is sufficient for filling up the holes. The soil must be heaped up, so as to prevent water-logging at the base of the cutting. The three lower leaves of the cuttings are removed, and that portion of the stem planted three or four inches below the surface. The remainder of the stem is then tied to the post or tree by a flat band of plantain fibre, or by a coconut leaflet. Round cord must not be used, as it is liable to cut into and injure the green, succulent stem of the vanilla. The ground over the buried part of the cutting is then mulched with leaves or light brush-wood; and if dry weather comes on, frequent waterings will

be necessary, until the cutting has taken root. The ground must be kept free from weeds, and, unless it be lightly shaded by growing trees, it will be advisable in dry weather to keep the roots constantly mulched.

When the vines have reached the tops of the trees or other supports, bamboos may be fixed horizontally from tree to tree or from post to post, and the vines trained along them. The trees must be kept down low, so that the vines do not get out of reach, and the branches must be judiciously lopped, in order to prevent too much shade. No animal or artificial manures should be used, but rotten leaves and vegetable soil may be applied to the roots after each crop is gathered.

*Fertilization of the Flowers.*--The plants will commence to flower in the second year after planting, and full crops may be expected in the fourth year. In the Sibpur Botanical Garden the vanilla creepers are in flower in March and April and artificial fertilization is regularly practised, though in the wild state, in America, fertilization no doubt takes place through the agency of insects or small birds. The parts of the flower are so arranged that self-pollination is impossible, and therefore it must be effected by some foreign agency. If the flower of the vanilla orchid be examined carefully, it will be seen that the outer floral envelope consists of three sepals, and the inner one consists of three petals. The lowest of the petals is very different from the others; it is called the labellum or lip, and it envelops the column or continuation of the axis of the plant on which are set the curious anther and stigma. This continuation is called the column. At the top of the column is a hood which covers up the anther and pollen masses, and below this is the viscid stigmatic surface, protected and hidden by a projecting lip sometimes called the lamellune. Thus we see that the pollen is shut in by the hood and the stigma is shut in by the lamellune, so that two obstacles prevent self-pollination. The object of artificial fertilization is to remove these obstacles, and to permit the pollen masses to approach the stigma. This is easily effected—firstly, by detaching the hood, which is accomplished easily by touching it lightly with a piece of sharpened wood; secondly, by slipping the lamellune under the anther; and thirdly, by ensuring contact of the pollen and stigma by gentle pressure between the fore-finger and thumb. The operation is performed in a few seconds after a little practice, and it may be facilitated by holding the column between the thumb and middle finger of the left hand, whilst it is supported at the back by the fore-finger; the right hand is then free to use the fertilising instrument, which should be rather blunt and flattened at the end. A tooth broken from an old comb and fixed into a piece of thin bamboo a few inches in length may be used.

If the fertilising operation proves successful, the flower will gradually wither, whilst the pod will grow rapidly. If unsuccessful, the flower will fall off before the second day, and the ovary will

remain undeveloped, turn yellow, shrivel up, and drop off the stalk. The flowers come out in March in clusters of from 10 to 12, but not more than half a dozen of the clusters should be fertilised and in this way fine large pods will be secured. Fertilization should commence at 9 or 10 o'clock in the morning, for if it be done too late, pollination may be incomplete, or fail altogether. The fruit goes on growing for a month, but it will take at least five months longer to ripen sufficiently for harvesting.

*Harvesting.*—The pods are to be gathered when they begin to turn yellow at their ends, or when they produce a crackling sensation on being pressed lightly between the fingers. Each pod should be gathered separately by being bent to one side, when it will come off the stem. It is very important to gather the pods at the right time, for, if they be too ripe, they will split open in curing, and if too green, they are dried with difficulty, and they will have little or no perfume.

*Curing.*—After the beans are gathered, they are plunged for half a minute in hot, almost boiling water. They are then put on mats to drain them dry, and afterwards they are spread out on blankets and exposed to the sun. Every evening they are rolled up in the blankets and shut up in light boxes to ferment. The sunning process is continued for a week, or until the pods become brown and pliable, when they are squeezed between the fingers to straighten them, and so cause the seeds and oily substance inside to be evenly distributed. Should any of the pods split, they should be closed up and bound round rightly with silk thread or narrow tape. As they dry and shrivel, the thread should be unwound, and the pods tied up again. When the pods are brown, the drying process should be finished in shade, which may take many weeks.

*Packing.*—The dried beans are to be sorted according to their length, the long thin ones being the most valuable. Beans of the same length are to be tied in bundles of 25 or 50, the ligatures usually being applied close to each end of the bundle. The latter are then packed in closely fitting tin boxes, which are enclosed in rough wooden cases.

The Vanilla plants flower very irregularly, and in consequence, all the pods are not in fit condition to be gathered at one time, and care is required at the first gatherings not to touch pods which are unripe; if gathered too early, the pods or beans will mostly shrivel during the process of drying, and lean shrivelled beans do not realise so good a price in the markets. At the same time the pods must not be left on the plants after they have ripened, or the valves will open, sometimes nearly an inch, and split beans are of inferior value. 7 to 33 shillings per pound are obtained in the London market according to the size and quality of the beans.

## CHAPTER LXXIII.

### PAPAYA (*CARICA PAPAYA*).

As a heavy yielding fruit and vegetable crop the papaya has hardly its equal, and it deserves to be cultivated as a regular crop. The fruit grows plentifully during the monsoon, but it goes on yielding all the year round. The best papayas are grown in Ceylon and Sylhet.

The seeds should be dried in the sun, and after being kept a week, sown in a box or under cover in rich but light soil. The soil should consist of sand and two-year-old manure. When the plants are a few inches high they should be transplanted to a nursery, and when two or three feet high they should be planted out in fields, in holes in which plenty of manure and a few pieces of bones should be put. The trees should be planted in the open and not in shade. The planting should be done 10 ft. apart. When six feet high the central bud should be nipped off and growth of side branches encouraged. The size and quantity of fruits are both enhanced by this operation. Male trees often contain hermaphrodite flowers which go to form fruits. From large sized fruits from male trees (which are best known by their pendulous flowering branches) seed should be taken, as then the tendency will be for both male and female trees to yield fruits.

Apart from the great value of the papaya as a drought resisting crop yielding a highly nourishing vegetable (when the fruits are green) and ripe fruit, the crop is of great value as the source of Papain or Papayotin. The filtered juice of the papaya gives some of the reactions of pepsin, but it is different from pepsin, as it acts more energetically in neutral or alkaline substances than in the presence of acids. It curdles milk like pepsin. It dissolves twenty-eight times its weight of coagulated albumen. It also to some extent digests fibrin (the principal albuminoid of meat),—some say two hundred times its weight—as well as white of eggs. No action, however, takes place when there is much acid. It is for this reason papaya acts so readily in softening fresh meat, if the milk of the fruit is added to the meat a few minutes before cooking. It is not such a ready alimentary digestive in the presence of gastric juice which is highly acid. Papain is present more or less in all parts of the plant, but chiefly in young fruits.

In preparing Papain, the juice should be obtained from unripe fruits. Moisture spoils the ferment and great heat destroys its activity. The juice should therefore be dried as soon as possible at a low temperature. The fresh but dried juice should be mixed with twice its volume of rectified spirit, and the mixture allowed to stand for a few hours. The insoluble matter should then be filtered off. The residue should be dried in the ordinary atmospheric temperature, powdered and kept in well stoppered bottles.

In the presence of alkali, Papain is not only a valuable aid to digestion, but it is also a solvent of the gum of tusser and other cocoons which are reeled with difficulty. The use of Papain as an aid to the reeling of tusser cocoons is recommended for trial.

## CHAPTER LXXIV.

### CASSAVA AS FAMINE FOOD.

[Drought-resisting crops; Objections to famine-foods; Cassava, where used; Advantages of introducing the crop on high lands; Varieties; An experiment; Tapioca meal or Brazilian arrowroot; Tapioca; Cassava flour; Yeddi cultivation, Nipping of buds for keeping the bushes low; Seasons for planting and lifting; Dishes made of Cassava; Liable to the attack of rats; Other root-crops for famine times.]

DURING the series of famines in India from 1896 to 1901, persons who went about in rural places could not have failed to notice how certain crops fared better than others, how certain crops did not suffer at all from the drought, and how poor people took to living very largely on foods which they had formerly looked upon as mere accessories to their dietary. It was noticed, for instance, that where rice, wheat and barley had failed completely, *arabar*, *kalai*, gram, maize and some of the common millets did fairly well, and yams, sweet potatoes, vegetables, such as *palvals*, *sajna*, country figs and mash-melons and sweet melons did remarkably well. During the famine of 1897 these articles of food were largely used as a substitute for rice. Throughout June, 1897, many day-labourers ate only mash-melons in the day-time and a little rice at night. A pice worth of melons or *palvals* gave them a full day's meal at a time when two annas worth of rice was required to appease a man's hunger. It is singular that the prices of such articles as milk, fish, etc., did not increase, and that food far more nourishing than rice, consisting of *palval*, *kalai*, *dumbur*, fish and sour milk was to be had at a smaller cost than rice. The famine, indeed, had the effect of educating people how not to depend on rice alone for sustenance and teaching agriculturists the value of having several strings to their bow, *i.e.*, of growing not rice alone, but also maize, millets, *bhadai*, *kalai*, *arabar*, *ól*, and other crops ordinarily less paying than rice, but which do not require the same amount of water for their successful growth, and which do not fail when there is a monsoon of short duration.

The food-stuffs mentioned above labour under one or other of the four disadvantages. First, they either yield too little produce, or secondly, they are too indigestible, or thirdly, they are too coarse or insipid, or, fourthly, they do not keep long. The Cassava (called *Simul-alu* in Eastern Bengal and *Sakar-kanda* in Midnapur), stands drought at least as well as any of those crops, it grows equally well in the open or in shade, it yields a nourishing and palatable food, which can be utilized either in the fresh state,

or by extracting out of it a flour which keeps much better than wheat-flour, it yields a much larger quantity of dry food per acre than probably any other crop, and it can be grown with little trouble, on high lands, in the plains of Bengal.

The roots of the Cassava are sold boiled in the streets of Madras, and they taste very nice. In Darjeeling, Bancoorah, Midnapur and in Eastern Bengal and Assam it is eaten cooked into currie. Fresh roots do not keep long; in the case of potatoes they rot away, and in the case of Cassava roots, they become like bits of wood from which it is not easy extracting the farina. Cassava flour is easily manufactured from the fresh roots, and as such, the produce of this crop keeps long, and it can be utilized for food agreeable to Indian taste.

One great advantage of growing the Cassava plant as a protection against famine, lies in the fact that the roots need not be dug up annually. If a cultivator has a hedge of Cassava all round his fields, he can lift the roots only when his ordinary crops fail. In the interval he need not take any notice of them. Properly grown, after a few months the tuft of leaves of each tree gets beyond the reach of cattle. The roots go on increasing in number and in size, and they need not be utilized until a year of partial or total failure of the ordinary crops comes round. It should be mentioned, however, that Cassava is not a suitable hedge plant, as cattle are very fond of its leaves. It should be also noted that the root-development goes on far more freely when the plants are kept down to a height of two to three feet only, by the nipping of terminal buds from time to time.

The most economical way of utilizing the roots is to lift them once in ten to twelve months and to treat them as an annual crop. The deposition of starch falls off after the first year, that is, does not go on quite so rapidly in old trees as in one-year-old plants. In introducing the crop among cultivators, however, it is best to tell them to grow it along hedges and odd corners of their homesteads, that there may be no interference with their ordinary agricultural pursuits. In dealing with cultivators it is often necessary "by indirection to find direction out", to introduce improvements tentatively and slowly. Poverty makes them suspicious, and if you were to tell them to set apart some considerable portion of their land which they now use for growing rice, or *kalai*, or jute, for the Cassava plants, they will jump to the conclusion that you have some ulterior motive of your own to serve and you are merely using them as a cat's-paw.

It should be noted that there are two varieties of Cassava, both used in America for extracting tapioca, though one of them, *viz.*, the *Manihot Utilissima*, is poisonous. The *Manihot Aipi* or the sweet Cassava, the roots of which can be eaten raw, is the safest variety to grow. There is a considerable proportion of prussic acid in the bitter Cassava, which, however, is dissipated by the action of heat in the process of manufacture of tapioca.

The sweet Cassava, variously called *Himel-alu* (or *Simul-alu*), from the resemblance of the leaves of this plant to those of the silk-cotton or *Simul*, *gach-alu* (or tree potatoes), *rutu-alu* (or bread potatoes) and *Sakar-kanda* (or sugar-root) was first introduced into Western India from America, probably by the Portuguese. In the Bombay Presidency it is not utilized for food, but in Southern India, in Cuttack, in Burma and in Assam and in some parts of Bengal also, the roots are eaten either raw or boiled, or curried. The art of making flour out of the roots is not practised anywhere in India. As a garden-plant or an ornamental hedge-plant, Cassava is met with in many parts of India. One can taste the root and find out for oneself whether a particular plant is sweet Cassava or bitter Cassava, before taking cuttings out of it.

We will now describe the process adopted at the Sibpur Farm in the manufacture of tapioca-meal, and Cassava flour, out of the roots dug out of nine Cassava plants, all one year old. The leaves of these nine plants and the root barks were given to cattle, who ate them with relish, and all stems and branches were used for making cuttings. So no portion of the plants was wasted. If you do not want to use all the stems for making cuttings, you can at least use them for fuel. A plantation of Cassava would thus give food, fodder, and fuel. Now to the manufacture of the flour. The following method was adopted:—The crude roots were dug out and cleaned superficially of adhering earth and root-scabs, by washing them, and they were then left soaked in water for six to eight hours. This soaking in water rendered decortication quite easy. The roots were taken out one by one from the trough in which they were soaking, a slit made with a knife in the bark, which was then easily peeled out. The core of the root was then made into slices and put in a trough of filtered water. The slices were left soaking in the filtered water for an hour and then pulped with a *dhenki*. The pulp was tied in a cloth and put under a heavy weight. A cheese-press was used for this purpose. The object of putting the cut slices in water and the pulp under weight is to get the little trace of prussic acid which occurs even in sweet Cassava, out. The slight trace of acrid substance in the sweet Cassava produces no disagreeable effect even when the roots are eaten raw, but its presence can be slightly tasted, and it is much pleasanter to get this slightly disagreeable taste out of the pulp, before flour is made out of it.

If it is desired to make tapioca-meal or tapioca, as well as Cassava flour, out of the pulp, the pulp is put in a cloth and kept stirred, half-dipped in a trough or *gamla* of filtered water. This helps the farina to go downward, settle at the bottom of the trough and also more of the acrid substance to be washed out of the pulp. After stirring the pulp in the cloth for an hour in one trough, it is to be stirred for a few minutes in another trough of filtered water and then the excess water squeezed out, and the pulp tied in the cloth is to be passed once more through the press and then



spread out thin, exposed to the sun to allow of its getting dry the same day, if possible. If the crude roots are left in the wash-tank over night, say, from 9 P.M. to 5 A.M., and the decorticating and slicing got over by 8 A.M., the sliced roots left in the soaking tub from 8 to 9 A.M., the pulping got over by 10 A.M., and extraction of the farina by midday, all the afternoon will be available for the pressed pulp to get dry. As the manufacturing should be done at the driest season of the year, viz., February to April, there should be no difficulty in getting the pulp thoroughly dry and ready for grinding by 5 or 6 P.M. At Sibpur, the grinding was done with an ordinary hand stone-mill and the flour was afterwards separated out with an ordinary hand-sieve. The resulting flour was beautifully white and sweet and it kept sweet for more than a year.

The farina or starch which settles down at the bottom of the troughs is collected quite easily by pouring out the water from them. The starch occurring in a compact and heavy mass does not flow out. The starch is allowed to settle again, and the water then poured off with the water. A fresh quantity of filtered water being poured out, the starch is exposed to the sun and collected in a dry state. The moist starch of some troughs may be converted into tapioca-meal or Brazilian arrowroot by drying in the sun, as above, and of others into tapioca. The tapioca-meal which is sold as "Brazilian arrowroot" in London, can be used as a substitute for ordinary arrowroot or cornflour.

The moist starch is simply exposed to the sun and made into tapioca-meal. But to convert it into tapioca it is put into a brass or aluminium pan in the moist state and heated over a slow fire with constant stirring with a brass *khunti*. As soon as the meal assumes the granular appearance of tapioca, it should be taken down from the fire and left to dry more perfectly in the sun.

These were the actual quantities obtained at Sibpur out of nine Cassava plants:—220 lbs. of crude roots, 149½ lbs. of pressed but moist pulp, 33¾ lbs. of Cassava flour, 5½ lbs. of tapioca-meal, and 6¾ lbs. of tapioca, or a total quantity 45½ lbs. of dry food, also 107 lbs. of leaves which were eaten with avidity by cattle, and 937 cuttings.

Planted five feet apart, an acre would hold about 1,700 plants. If the Sibpur experience is repeated on a large scale, we ought to get over 450 maunds of crude roots and over 210 maunds of green fodder per acre. When it is recollected how difficult it is to get green fodder in some parts of India during the driest months, the produce of 240 maunds of green fodder for cattle, which is a mere bye-product, seems sufficiently inviting. If the value of the fodder alone is estimated at two annas a maund, we have an out-turn of Rs. 30 per acre. Then there is another bye-product in the shape of cuttings of fuel, which would be 175 to 200 maunds per acre, which represents another Rs. 50.

The price of tapioca is six annas a seer in Calcutta. Putting the whole produce of Cassava flour, tapioca-meal, and tapioca at

the lowest value of, say, two annas a seer, *i.e.*, Rs. 5 a maund, we may, on the basis of the Sibpur experiment, expect a gross produce of Rs. 500 per acre from the flour and meal. In practice, nothing like this would probably be obtained on a large scale, but in any case the crop should be very profitable in Lower Bengal.

Working on a large scale, the produce of flour will come, perhaps to 50 maunds per acre instead of 100 maunds. The account of produce of Cassava flour given in Dr. Watt's Dictionary is rather conflicting but as this is the only authority we could lay hold on, we would quote a passage here from his Dictionary :— "The produce has been estimated in Ceylon at 10 tons of green roots per acre. This weighs one-fourth when dried, and if the dried roots gave half their weight of flour it would amount to 2,800 lbs." This means 34 maunds per acre, which, of course, is three times as much as one gets out of an acre of wheat. \*

Though Cassava can be planted at any season, and harvested at any season, which is a great advantage looking at the question from the point of view of famine prevention only, the best season for harvesting, and consequently of replanting of cuttings, is February and March. There is now one point which must strike one very forcibly, *viz.*, that Cassava which may yield 50 maunds of flour and meal per acre besides leaves, etc., must be an exhausting crop, and the produce must fall off very much after the first year. If no manure is used, the produce is bound to fall off. But if one were to expect a crop of Rs. 300 per acre, one ought to spend Rs. 20 or Rs. 30 per acre after the first year on manures. A handful of ashes is the only manure that need be used while planting the cuttings, but twenty cart-loads of farmyard manure should be added per acre and worked into the soil six weeks later. The planting should be done horizontally, three inches deep.

When one is working on a large scale one cannot depend on knives for slicing roots, and quirns for grinding the dried pulp into flour. But cultivators need not work on a large scale. They can grow the plants in small patches and utilize the roots either for eating them fresh, or converting them into flour by such simple processes as we have described. If a capitalist is to launch out on an extensive scale, he must use machinery for slicing, pulping, pressing and grinding. If one were to grow Cassava on a moderate scale, say, on five or ten acres of land, one must use such simple machinery as a turnip-slicer, a turnip-pulper, a cheese-press and a small grinding mill to cope with the work of harvesting. The cultivator will need nothing that he cannot easily procure in his own village, or even in his own cottage; *gamlas*, and *dao* and *dhenki*, and a couple of big stones, are all the special appliances required.

---

\* For later information, see Booth Tucker in the "Agricultural Journal of India."

The next question one would be interested in is, how to make use of the produce when one has got it. Tapioca-pudding is used as a nourishing food by Europeans, but this would not probably be relished by Indians. But tapioca-meal can be used in place of arrowroot. It is more nourishing than arrowroot. Cassava flour is still better as an article of food suited to Indian taste as it can be utilized in making various articles of food which we are ordinarily in the habit of eating. Out of Cassava flour may be made *chapatis*, *puris*, *malpoas*, *halua*, puddings, and biscuits. It does not make very first-class *chapatis*, *puris*, and biscuits, but it makes excellent *malpoas*, and *halua*, and Cassava-pudding tastes nicer than tapioca-pudding. The *chapatis* are very palatable, but they are a little too elastic, though quite soft. For making dough, hot water should be used; otherwise Cassava flour and wheat flour are used exactly in the same way. In making *halua* out of Cassava flour the syrup has to be made first over a fire, with sugar and water. When the syrup is somewhat sticky, a proportionate quantity of Cassava flour mixed up with water is put in. The flour should be mixed up with the syrup by prompt stirring. When the colour of the flour changes, a little ghee and almonds and pistachio nuts are to be added and the mixture kept stirred for another few minutes. The *halua* thus made keeps long and it tastes very much like Muscat *halua*. In making 100 tolas of *halua* 13 tolas of Cassava flour mixed with 40 tolas of water should be used. The syrup is made with 40 tolas of sugar and 20 tolas of water. Ten tolas of ghee and an anna's worth of almonds and pistachio nuts are used for giving the *halua* a rich taste. It is a cheap and delicious sweetmeat. Frozen with ice it is further improved. In making biscuits, three-fourths Cassava flour and one-fourth wheat flour should be used.

The Cassava roots could thus be variously used, and the poorest and the most epicurean can make use of them either in their fresh state or manufactured into flour. The well developed roots weigh 2 to 5 lbs. each, and they can be eaten either raw or cooked (*i.e.*, either boiled, or fried in chips or curried). As a drought-resisting crop, as a heavy yielder, as a nourishing food stuff which is easily manufactured, we do not know anything which comes up to Cassava.

The roots tasting quite nice when raw, are very liable to the attack of rats. Some arrangement must be made for poisoning rats if the crop is to be secured undamaged and undiminished.

Of other drought-resisting root-crops, may be mentioned the *ôl*, yams and a bulbous vine grown at Kalimpong called *Ishkosh*. The *ôl* of Bolepur, Santragachi and Geonokhali are famous. Of yams may be mentioned an African yam which is grown at the Sibpur Farm and which is almost as good as potatoes. The elephant's foot yam of Malabar is also famous. The leaves of *Ishkosh* are eaten by cattle, while the edible roots sometimes weigh one to two maunds from under each vine.

## CHAPTER LXXV.

### ARROWROOT.

THE arrowroot is extracted from the bulbs of various plants : - (1) The common Bermuda arrowroot is obtained from *Maranta arundinacea*. This is the common arrowroot which we have seen growing at Alipur and in some Jail gardens. The plant grows 2 to 3 ft. in height ; the flowers and the tubers are white. (2) The Brazilian arrowroot extracted from cassava roots which we have already described. (3) There is another variety of arrowroot grown chiefly in Queensland from a *Canna*, the flowers of which are beautiful bright scarlet, not unlike Indian shot flower. The plants of *Canna edulis* grow 8 to 9 ft. in height and from a single stool 15 to 20 stalks come up, each stalk bearing a big bulb. Sixty to eighty pounds of bulb are often extracted from a single stool. The starch or arrowroot extracted from this plant is known as *tous-les-mois*. Rich alluvial jungle land or river or creek banks suit this plant best. It is also grown in open countries on rich deep soils. It prefers a more sandy soil than the ordinary arrowroot, *Maranta arundinacea*. The bulbs are sold in Queensland for £2 10s. per ton and the arrowroot extracted from it sells at about 9d. a lb. Ordinary arrowroot prefers shade, and the bulbs of this are planted about a foot apart in the lines and 1½ ft. from line to line. In growing *Canna edulis*, burn the jungle, make holes 6 or 7 ft. apart in rows and 4½ ft. from each other in the lines. If a plough can be used, ploughing and pulverising and trenching six inches deep and planting 4½ ft. apart of single bulbs, should be done, the rows being made 7 ft. to 8 ft. apart. As the land gets poorer by cropping, the rows should be made closer, but never closer than 6 ft. apart, the hilling or earthing once is all the subsequent operation needed. The roots are dug up from December to February, *i.e.*, nine months after planting, the planting being done in March or April. Ordinary arrowroot does better planted in May or June.

A good test for ascertaining when the ordinary arrowroot bulbs are ready for harvest is to observe at the outer leaf of the bulb a triangular slit pointing downwards ; if the slit is white the bulb is still immature ; as soon as it turns purple it is ready for harvest. It can be left for two seasons as sugarcane is sometimes left.

Each day's digging must be operated on the same day. Every day of exposure to sun and weather has an injurious effect upon the colour of the manufactured starch. Twelve to forty tons of *tous-les-mois* bulbs per acre are obtained if the plants are 5 ft. by 6 ft. apart. 15 to 30 cwts. of starch per acre is the average produce. Up to 4 tons have been obtained. The price of arrowroot in the London market varies, but an average may be taken as £15 per ton. If machinery is used 10 to 30 cwts. of arrowroot can be extracted per day. For a mill capable of turning out 30

cwts. of arrowroot per day, the following appliances are necessary: one root-washing tank, one elevator, one grater or grinding mill, rotary sieves, shaker sieves, one chute, one agitator, one centrifugal pump for draining water from vats. Tables and calico for drying the roots are raised to the highest part of the building. The cost of erecting an arrowroot mill is about Rs. 18,000, plus Rs. 3,000 for a drying and storing shed.

## CHAPTER LXXVI.

### BAMBOO, GREWIA, MAT-GRASS AND RUISA-GRASS.

*Bamboo*.—Alluvial loam and clay are the best soils for the growth of the thicker kinds of bamboo, and gritty soils for the thinner mountain varieties. There are various classes of bamboo, the four commonest ones growing in Bengal being the *Bhálki-báns*, the *Ber-báns*, the *Kántá-báns*, and the *Táltá-báns*, the *Bhálki-báns* being the strongest, longest and thickest of the four. The two bamboos grown commonly in Bihar are the *Cháp* bamboo which is hard and solid and the *Kágji* bamboo which is soft and hollow, though thicker. For making mats, baskets, etc., the *Táltá-báns* and the *Kágji* bamboo are the best. The *Kántá-báns* is also very strong and long, but it is full of spinney branches, and it is very inconvenient cutting out of clumps and stripping. On the whole, the *Bhálki* and the *Táltá-báns* are the best to cultivate. Forty or fifty years after sowing (if seed is used) bamboo trees seed and die. The bamboos propagated from root-cuttings and stems, seed at the same time as older bamboos from seed, and where seedling takes place in a particular variety of bamboo, all the clumps of that variety in a particular locality die off simultaneously. The seed (which is eaten like rice) should be collected at this season and carefully sown in prepared seed-beds and transplanted to renovate the stock. Naturally many of the seed take root in forest-lands and produce a fresh growth of bamboos. Bamboos are ordinary propagated from stocks or culms dug out with roots. Bamboos that break when young and bend down on the ground and throw out roots, are the best to choose for propagation. Bamboos may be artificially bent down on the ground while in the clump, say in September, and the following June it will be found they have sent down roots into the ground and become fit for making cuttings. They may be then cut into sections, carefully uprooted and transplanted in June. In moist localities the planting of bamboos should take place in May, and in dry regions of Chhota Nagpur and South Bihar in July. Planting twenty feet apart is advisable. The holes made in the field two or three months beforehand should be filled with rotten dung, before the cuttings are planted. In the first year in the dry season, *i.e.*, from November to June, occasional watering will be required, but afterwards only an

application of silt one year, and of ashes the next, in April or May. From the fifth year the ripe culms can be cut, two or three being cut out of every clump in the fifth year, and the number gradually increasing to eight or ten every year. November to February is the proper season for cutting the bamboo. A clump of bamboo will go on yielding for 40 or 50 years (unless seeding takes place in the meantime in bamboos grown from cuttings), if the clumps are kept manured as described above. An acre of bamboo may yield Rs. 100 in the fifth year and Rs. 200 per annum after the tenth year. A clump may yield up to 20 bamboos per annum, and the average after ten years may be put down at ten. In Burma more solid bamboos than even the *Bhálki-báns* are obtainable. Young shoots of bamboo are eaten as a delicate vegetable. In Orissa and the Central Provinces the wood of *Grewia vestita* (*Dhámin* or *Kulita*) is used as a substitute for bamboo for making *bangis*. The toughness and elasticity of this wood is remarkable and its propagation is recommended also. For making bows, shafts of carriages and other similar purposes, the wood of *Grewia vestita* is likely to prove most useful.

*Mat-grass.*—This is one of the most paying crops grown in Bengal, chiefly in the districts of Midnapur, Burdwan and in some of the districts of E. Bengal and Assam. In Midnapur it has taken the place of mulberry in the Sabong *thana*, the soil on which this crop is grown being the same sort of soil on which mulberry does best, *viz.*, clay-loam above inundation level. If the silkworm crop is a success, then only an acre of mulberry yields a return of about Rs. 300, and the cost of mulberry cultivation is rather high. The cultivation of mat-grass costs about Rs. 45 per acre, but the gross outturn comes to about Rs. 300, and the return is certain. The root-cuttings are planted in May and June. Preparation of land commences in the previous November when the land is dug up with a spade, and weeds carefully picked out. As soon as there is good rain in May or June, the land should be ploughed up and levelled with the ladder, and the trenches should be made six inches deep and one foot apart. The root-cuttings are planted along these trenches nine inches apart in regular lines and in planting the trenches are levelled up. In July and August two weedings are needed. In October and November the flower-stalks appear and attain a height of about four feet when they are sold off as a standing crop to mat-weavers. After the stalks have been cut away, the land is manured with silt from the bed of tanks or *nullahs*. In February or March the silt is heaped up on the sides of the land, and when dry and aerified sufficiently it is spread out in April, after giving the land a superficial scraping with *kodalís*.

When the flower-stalks are cut from November onwards, they are left on the land for three or four days, the flower heads are then rejected, and the stalks are each split longitudinally into two or four parts with a knife. The pith of thick stalks is scooped out

and rejected also. For making high class fine mats, the split pieces are put in water and afterwards further split.

If the scraping of the land and putting on of silt is continued annually, the crop will continue to yield the same profit for ten to fifteen years.

*Ruisa-grass.* *Andropogon schœnanthus*, known as *Agyá ghus* or *Gandha-bená* in Bengal and as *Ruisa-grass* in Southern and Central India, is of various kinds, all aromatic, but some so beautifully aromatic that the oil extracted from the seed-heads is exported to Constantinople where it is said to form the basis for the manufacture of *attar* of roses. The best *Ruisa* grasses are known as *Motia* and *Sophia*, *Motia* being the best. It is collected from jungles in Khandesh, Baroda, Malabar and Hyderabad, and the oil is distilled from the seed, 1,000 seed-heads being put into the retort at a time, the retort being an iron vessel with a wooden lid, whence the essential oil is distilled out into a bottle. An experiment conducted with 373 lbs. of the grass yielded 1 lb. 5½ oz. of oil. In Western India the oil is sold locally for Rs. 10 a pound. It is considered a medicine for rheumatism, but it is chiefly extracted for export. It is a grass well worth cultivating, and experiments have been recently undertaken in Bengal. The grass is eaten by cattle also, and it imparts a fragrance to the meat and milk of cattle living on this grass.

## CHAPTER LXXVII.

### ORANGES.

THE four principal localities in which oranges are largely and regularly cultivated in plantations, are Sylhet, Sikkin, Delhi and Nagpur. Orange cultivation has been also successfully undertaken in the Bamra State, in the district of Sambalpur, where in some hills oranges are found wild. We get five different varieties of oranges from the five localities, the differences being, no doubt, due to difference in climatic conditions. A moderate degree of cold during a fairly prolonged period, say from November to April, is needed for the proper growth of the trees and the proper formation of fruits. We have known of persons taking the trouble of importing along with orange seedlings from Sylhet as much soil as practicable to give the seedlings, as they thought, a good start in the soil of Calcutta. But it is the climate and not the soil that makes the difference. A plantation of orange trees should be protected from any strong breeze, specially strong sea breezes. Screens of living forest are the best. The soil should be well drained and above inundation level and fairly rich, that is, richer than soils chosen for growing timber trees. If chemical analysis is possible, it should be ascertained if the soil chosen is particularly rich in lime and phosphates. Nepal cultivators

put bones of animals in the hollow where an orange tree is transplanted. If the soil is not particularly rich in phosphates, this method should be followed. The holes where orange seedlings are transplanted should be made pretty wide, say 5 or 6 ft. in diameter, though they need not be made deep as the roots of the orange tree do not penetrate very deep into the soil, but have a tendency to spread laterally. Rotten manure should be put in the holes in addition to whole bones. The planting should be done fifteen to twenty feet apart, in regular lines. Seedlings do better ultimately than grafts, though the latter bear fruits earlier. Mature full grown and early fruits from the topmost branches should be gathered for seed. Only those pips should be chosen which are round and large, flat and shrivelled seeds being rejected. The seed should be sown in drills three inches deep. The seed-bed should be protected with mats, in the usual way, from sun and rain. The seedlings should be left for two years in the seed-bed before they are transplanted. Transplanting should be done at the dormant period of the plants, *i.e.*, when only old leaves abound on the seedlings and when growth is not going on vigorously. Injury to roots, specially the tap-root, should be avoided as much as possible, in lifting the seedlings. Water-logging at the base, after transplanting, must be avoided, or else the seedlings will sicken and die. As there is always some injury to roots at the time of transplanting, some of the branches and most of the leaves should be cut off at the time of planting. October and November are better months for transplanting than June and July. In the former case, however, irrigation or watering will be needed until next May or June. The other operations that help growth of the plants are hoeing and mulching (straw or litter being applied). Mulching protects the plants from the effect of excessive heat and drought, and also prevents caking of the soil. The mulch should be applied after the hoeing, and watering should be done over the mulch.

We have no very superior varieties of orange in India. The seedless orange of California is the best variety to grow. Seedless oranges are found in Sylhet also and in Japan. These must be propagated by budding or grafting. The importation of this variety and its acclimatization by budding or grafting on the wild orange of the country, are desirable. The net profits from an acre of seedless oranges in California often come up to 250 to 300 dollars (about Rs. 800) per acre, and there is no reason why some Indian planters should not make a new departure in this direction.



## CHAPTER LXXVIII.

### INDIA-RUBBER AND GUTTA-PERCHA.

[Profitableness of the rubber growing industry; Experiments all over India; Principal sources; Difference between rubber and gutta-percha; Solubility in carbon-bisulphide; Para rubber; Ceara rubber; Ule-tree rubber; India rubber; Coagulation with alum water, Method of propagation of each variety.]

THE output and consumption of India-rubber are annually increasing by leaps and bounds, and Rs. 200 to 250 per maund may be usually expected as the price of the product, and the annual production per acre about two maunds. Experiments are going on briskly all over India and Ceylon, and in Ceylon and Mysore very large tracts of land have been put down under rubber. The principal sources of India-rubber are Africa, Central and South America, Ceylon, Assam and Burma. Rubber is the hardened latex of several families of tropical plants, and any plant which exudes large quantities of white latex on the leaves or stems being injured, ought to be looked upon as a possible source of rubber supply. The common *sij-manasa* (*Euphorbia nerifolia*) and other Euphorbiaceous plants yield abundant quantities of latex which can be readily converted into rubber by addition of alum water. Gutta-percha is the hardened latex from large trees belonging to one family only, *viz.*, Sapotacæ. Rubber does not soften in moderate heat like gutta-percha does. Rubber is impervious to water, most acids and gases and it retains for a long period its original elasticity and strength, while gutta-percha becomes soft and plastic in hot water, retaining any shape given to it on cooling when it becomes hard and rigid. Rubber is soluble in carbon bisulphide, and the solution is used for repairing cracks.

*Para rubber.*—The most valuable rubber is the Para rubber obtained from *Hevea brasiliensis*, a South American tree, which is thriving very well in Ceylon in low elevations. In the Straits Settlements also Para rubber is flourishing. In the Madras and Bombay Presidencies and in Northern India the tree is not growing well. In five years after planting in suitable conditions the Para rubber is fit for tapping. The tree may attain a height of 60 ft. and a girth of 6 to 8 ft. The wood is poor, soft and perishable. The seed is very oily and on this account easily gets rancid and spoilt. It was, however, despatched from Ceylon to the Kew Gardens all right, packed in canvas bags only, and it travels better, packed in moderately dry soil or cocoanut fibre. It is propagated also from cuttings and stools or green shoots. The tree grows in well-drained soils, beyond the reach of floods, although in South America it was believed at one time to grow on swamps. This is, however, a mistake. The rubber is brought down through a swampy and malarious region from high and dry localities, and merchants in the coast had a mistaken idea it

grew in swamps. The latex is alkaline, and the addition of a solution of ammonia preserves it indefinitely from spontaneous coagulation. In favourable localities 120 to 140 lbs. of Para rubber are obtained per acre per annum after the seventh year. The tapping commences sometimes on the sixth year, when each tree yields about 10 ounces. If 300 trees are planted per acre, as much as 188 lbs. can be obtained out of an acre from six-year-old trees, but 300 per acre (*i.e.*, when the trees are planted 12 ft. apart) are too many, when the trees are older, and they have to be thinned out. At 5s. a lb., the yield per acre (130 lbs.) would be about Rs. 500, and the margin of profit may come to half this amount.

*Ceara rubber* is the product of *Manihot glaziovii*, a plant which resembles the cassava, though it attains a height of over 30 ft. The experiment of growing this in Ceylon, where the rainfall was too great, failed, but in Mysore the experiment is succeeding very well, in the seventh year as much as five lbs. of rubber being obtained per tree. The rubber is a little less valuable than Para rubber. The bushes can be also grown for their roots which yield a valuable starch like the ordinary cassava. *Ceara rubber* is growing successfully at the Rajnagur Garden in Darbhanga and it is likely to do well in South Behar, Chhota Nagpur and Orissa.

*Ule tree rubber*, which is almost as good as Para rubber, is the product of *Castilloa Elastica* (belonging to the Moracææ), a Central American fast growing tree, allied to the bread-fruit tree. It is easily propagated from seed or cuttings. Seven or eight-year-old trees yield 1 to 2 lbs. of milk per annum, 25 per cent. of the milk being pure rubber, separated by centrifugal machines. This tree has been also introduced into Southern India and Ceylon, but experiments so far have not given very encouraging results. *Castilloa* milk flows more freely and does not coagulate readily, which is a great advantage when a centrifugal machine is used. No return can be expected within eight years after planting. The *Castilloa* successfully introduced into Ceylon in 1876, is the *Castilloa Markhamiana*, from Darien (Panama). They flowered in 1881. The growth since 1886 has been slight. It does well in warm, steamy, alluvial localities and does not do well in elevated tracts nor in swamps. The temperature should never fall below 60°F., the rainfall should not be below 70 inches, and it should be well distributed. It should be planted in sheltered places near streams, but where the land is well drained. The seeds should be sown in a well prepared nursery, one inch deep and eight inches apart, and lightly covered with vegetable mould. The nursery should be kept lightly shaded and watered, and in ten or twelve months, when the seedlings are two feet high, they are planted out. Cuttings from main shoots (not lateral branches) also take. Planting should be done twelve inches apart and the plants left in shade for two or three years. Weeding and watering have to be done until the plants can take care of themselves. When trees have attained a

girth of 2 ft. or 2½ ft., they can be tapped. Cuts should be 3 ft or 4 ft. apart and not 1 ft. apart as in Para rubber trees. Five ounces per tapping may be obtained, and three or four tappings per year.

India-rubber is the product of *Ficus Elastica*, *Artocarpus Chaplasha*, *Artocarpus Integrifolia*, and *Alstonia Scholaris*. The last is a large tree which grows 60 ft. high in the dry forests of Ceylon, Singapur and Penang.

In a *Ficus Elastica* plantation, 35 years old, the average yield per tree per year is 600 grammes of solid rubber. The variation in yield, however, is very great. One tree may yield 100 grammes, another 12 kilogrammes. The average yield of *Castilloa* rubber in the same plantation (the plants being eight years old) is 200 grammes of solid rubber per tree per year. But as there could be about four times as many *Castilloa* trees planted in the same area as *Ficus* trees, the difference in favour of the *Castilloa* is decidedly considerable. *Castilloa* rubber is also more valuable and it can be gathered from much younger trees.

It is from the Government Forests of *Ficus Elastica* in Assam that much of the India-rubber (not Ceylon rubber) is derived. The latex is collected during the dry months. Eight oblique cuts are made with the *daw*, sloping downwards at a little distance from one another, so that eight mud-pots can be tied round the tree one below the other. These remain on the whole day. The cuts should not be deep, as the milk is secreted just below the outer bark. A great number of incisions should not be made on each tree as they weaken and ultimately kill the tree. The incisions should be made only on the main stem, the lowest one being made four feet from the ground.

An ounce of powdered alum should be taken in a tea-cupful of water and mixed well. A few spoonfuls of this solution should be put into each vessel containing about 3 pints of the milk after straining the milk from extraneous matter. The milk will coagulate immediately, the rubber is then exposed to air on sticks and allowed to drain for a week. After a month it is ready for the market.

The price has varied from Rs. 20 to Rs. 250 per maund within the last 20 years. A full grown India-rubber tree fifty years old yields, at the very lowest, five seers of rubber each time, if very carefully tapped, and this quantity may be expected about 16 times in 16 successive years, which is a safe estimate for calculating the yield of a rubber tree. At the rate of ten trees per acre, the yield comes to 20 maunds of rubber per acre in 16 years, valued at Rs. 4,000, while an acre of timber at Rs. 10 per tree would bring only Rs. 500 or 600. It is only Government or very rich landlords who can afford to wait for 30 years before the return comes, but the propagation of India-rubber trees should be always kept in view by Managers of Government and Court of Wards estates, where immediate return need not or

be looked for. The seedlings may be grown either on mounds, or as epiphytes on other trees. The *gooti* or *gul kalam* system of propagation is also largely practised.

## CHAPTER LXXIX.

## SERICULTURE.

[Various classes of silkworms under *Attacidæ* and *Bombycidæ*; The mulberry feeding silkworms; The tusser worms; Three main classes of tusser,—the *Larya*, *Bugui* and *Daba*; The method of rearing; The reeling of tusser cocoons; The varieties of mulberry; Propagation of mulberry from seed and cuttings; cost of planting mulberry; Outturn of leaf; Tree-mulberry. Rearing of mulberry silkworms; Reeling of mulberry cocoons; The Silk fibre; Diseases of silkworms; Pebrine, Muscardine, Flacherie, Gatine, Grasserie, Court, Double-cocoons; The fly-pest; The *Dermestes vulpinus*; The *Eri* silkworm and the spinning of *Eri* cocoons.

Various classes of silkworms are reared, some indoors and some on trees in the open, which spin cocoons, out of which silk is obtained of various classes. Silkworms fall under two main groups—the *Bombycidæ* and the *Attacidæ*. The former make reelable cocoons and the latter unreelable ones, which have to be carded and combed and spun into yarn, like cotton. The mulberry feeding silkworms and the tusser silkworms of commerce all come under the *Bombycidæ*, while the *Eri* silkworms belong to the *Attacidæ*. The *Attacus Atlas* (Fig. 67), which is the largest cocoon of all, out of which come the most magnificent moths, are unreelable wild cocoons.

The mulberry feeding silkworms, which are the most profitable of all to rear, are divided into the following groups:—(1) the *Bombyx mori* (Fig. 68), or the annual silkworms reared in Europe, China, Japan,

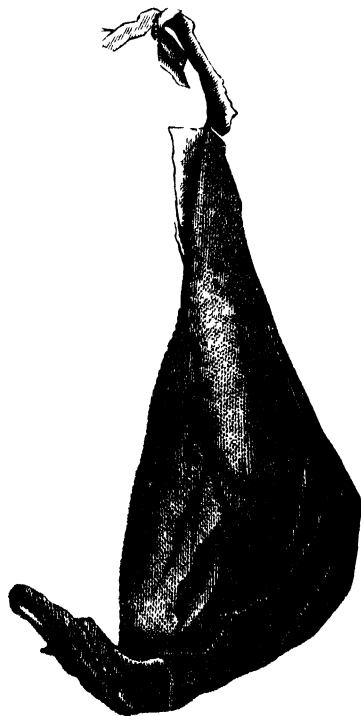

FIG. 67.—ATTACUS ATLAS COCOON.

Kashmir and some of the Western Asiatic countries; (2) the *Bombyx tector*, the *Barapalu*, the annual silkworm of Bengal, the cocoons of which are flossy and not hard like the *Bombyx mori* cocoons, and the eggs of which do not require such

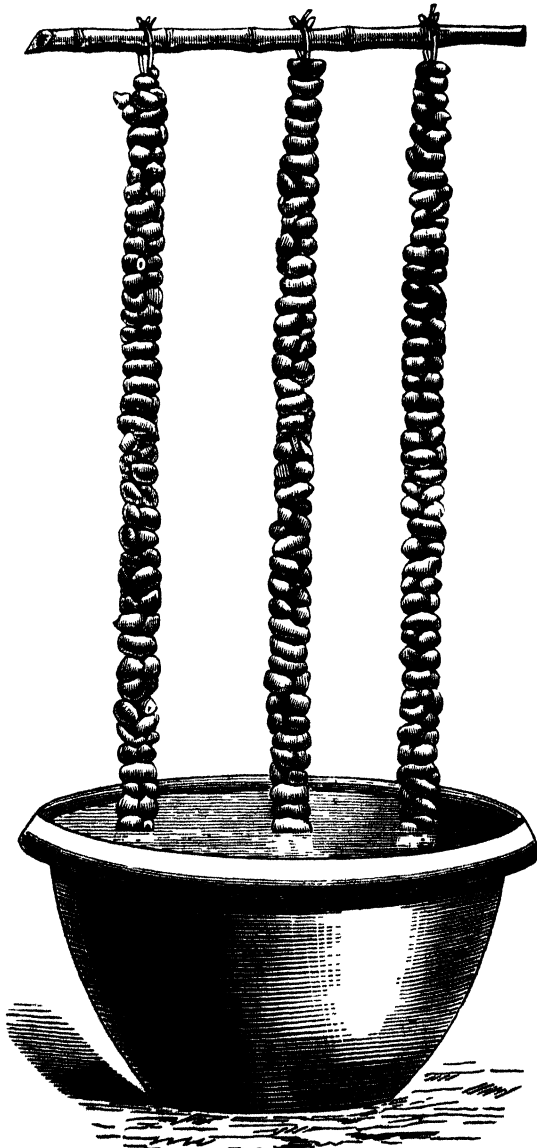

FIG. 68.—BOMBYX MORI COCOONS STRUNG UP FOR SEEDING.

(The vessel underneath is for maggots of the parasitic fly to drop in and accumulate.)

intense cold as the eggs of *Bombyx mori* for their hibernation ; (3) the *Bombyx Arracanensis* of Burmah and the *Barapát* of Assam are closely allied to the *Bombyx textor* ; (4) the *Bombyx Meridionalis* of Mysore and Kollegal, which yields seven or eight crops of cocoons in the year instead of one, the cocoons being greenish-white and almost as good as *Barapalu* cocoons ; (5) the *Bombyx Cræsi* (*Madrasi* or *Nistari*), the golden yellow cocoons, which breed eight times in the year in Bengal and which produce very fine and soft silk ; (6) the *Bombyx fortunatus* (the *Deshi* or *Chhoto-palu*), a brighter yellow cocoon of Bengal containing a larger proportion of stronger silk than the *Bombyx Cræsi* silk ; (7) the *Bombyx Sinensis* or the *China* cocoons, which are the smallest yellow cocoons of all, reared in Midnapur. There is a white variety of *Bombyx Sinensis* also reared in Midnapur, which is called the *Bulu* ; and (8) the *Theophila* cocoons found on the mulberry trees in the Himalayas are wild (Figs. 69 and 70).



FIG. 69.—WILD  
THEOPHILA HUT-  
TONI SILKWORM.

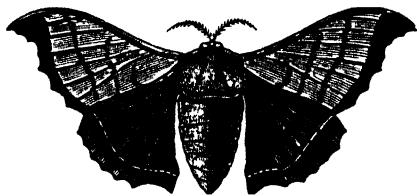

FIG. 70.—MOTH OF THEOPHILA HUTTONI.

The *tusser cocoons* are also divided into several groups, of which the *Antheria Yamamai* of Japan (Fig. 71), which yields a greenish-white silk, somewhat rougher and coarser than white *Bombyx mori* or *Bombyx textor* silk, is the best. The *Antheria Pernyi* (Fig. 72) or the China tusser, comes next. The *Antheria Assama* or *Muga* of Assam is just as good as the China tusser. The *Antheria nylitta* or the Bengal tusser proper, comes last. The tusser of China and Japan is reared on oak-trees. The *Muga* of Assam is reared on the *Sum* (*Machilus odoratissima*), the *Sualu* (*Tetranthera monopetala*), the *Mejankuri* (*Tetranthera polyantha*),

the *Champaka* (*Michelia champaka*) and other trees. The Bengal tusser is reared chiefly on the *Asan* or *Sáj* tree (*Terminalia tomentosa*), a tree which can be freely pollarded, also on *sal*, *arjuna*, *sidha*, *dharu*, *baer*, country-almond and other trees. The moths from tusser cocoons come out very irregularly, especially when the cocoons are large and strong, some coming out within three weeks of their formation, while others may not come out for two years. This accounts for tusser rearers choosing thin and small cocoons for seed, as eclosion of moths from such cocoons is more regular. An experiment conducted by the author, showed that large and hard cocoons can be used for seed, if the chrysalids are extracted from the cocoons and kept exposed or buried in saw-dust. This is one important step which can be taken in ameliorating the

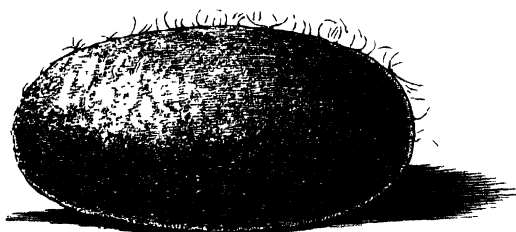

FIG. 71.—ANTHERIA YAMAMAI COCOON.

condition of the tusser silk-industry, which is going down on account of disease. The use of genuine wild cocoons for seed is another step.

There are *three main classes of Bengal tusser*, the *Narya*, the *Daba* and the *Bugui*. (1) The *Narya* (Fig. 73) is obtained out of

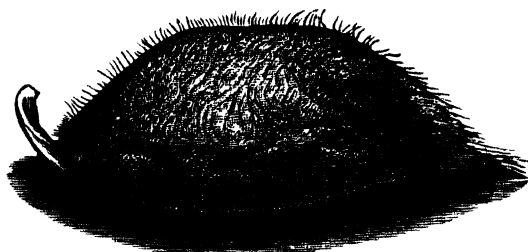

FIG. 72.—ANTHERIA PERNYI COCOON.

the small sized cocoons, generally wild, though domesticated cocoons are often fraudulently sold as wild cocoons. From the wild or domesticated *Dhuria* or summer cocoons of June are obtained, an *Ampatia* or flimsy crop of cocoons (Fig. 74) in July and August, and from this *Ampatia* crop is obtained the regular crop of the year, the *Barsati* crop, in October (Fig. 75). A *Jaddui* or cold weather crop (Fig. 76) of *Narya* is also sometimes taken; but it takes nearly three months taking a *Jaddui* crop. (2) The *Daba* is now always taken from the domesticated stock and not from

the wild stock, but it can be taken and ought to be taken from the wild stock, though, being the strongest breed of all, the domesticated *Daba* does not give such hopelessly bad results as the domesticated *Narya*. The origin of the *Daba* cocoon is probably the *Muda-Muga* cocoon (Fig. 77), *i.e.*, the large wild cocoon that does not cut in August or September of the year they are formed, but in the following June or July. In September or October such large and uncut cocoons can be picked out in *hâts* from among pierced seed-cocoons, and they ought to be looked for and reserved for seed till next June, when moths will come out of them, lay eggs as in the case of other tusser cocoons, and give an *Ampatia*



FIG. 73.—WILD LARYA  
OR NARYA COCOON  
(Dark, Small Hard, short  
and thick Peduncled).



FIG. 74.—AMPATIA LARYA  
COCOON (FLIMSY COCOON).

(Fig. 78) and a *Barsati* (Fig. 79) crop of healthy *Dabas*. Some of the largest and hardest *Barsati* cocoons can be reserved for seed till the following June, and the domesticated breed kept on until disease appears among the stock, when the wild stock must be resorted to again, in the manner already described. (3) The origin of the *Bugui* (Fig. 80) is the large-sized wild tusser cocoons (called *Bar-ra*, see Fig. 81), out of which moths cut out usually in September. It yields one crop of cocoons in November and December. Thus *Bugui* breeds once in the year, *Daba* twice, and *Narya* three times. The cocoons obtained from October to January are the best, and those from July to September are the worst. When the *Barsati* cocoons are selling from Rs. 8 or Rs. 10 a *kahan* (= 1,280 cocoons), the *Ampatia Naryas* or *Dabas* would sell for only Rs. 2 to Rs. 3 per *kahan*.



*The method of rearing* of all the three classes of cocoons is the same. The moths begin cutting out of cocoons about 4 P.M. At 9 or 10 P.M. the male moths fly away. About 3 A.M. those or other male moths come to the female moths. To facilitate the visit of the male moths, the rearer must keep his females out of doors (usually they are kept perched up on bow-like sticks) and watch them against the attack of bats, birds, lizards, etc. The moths

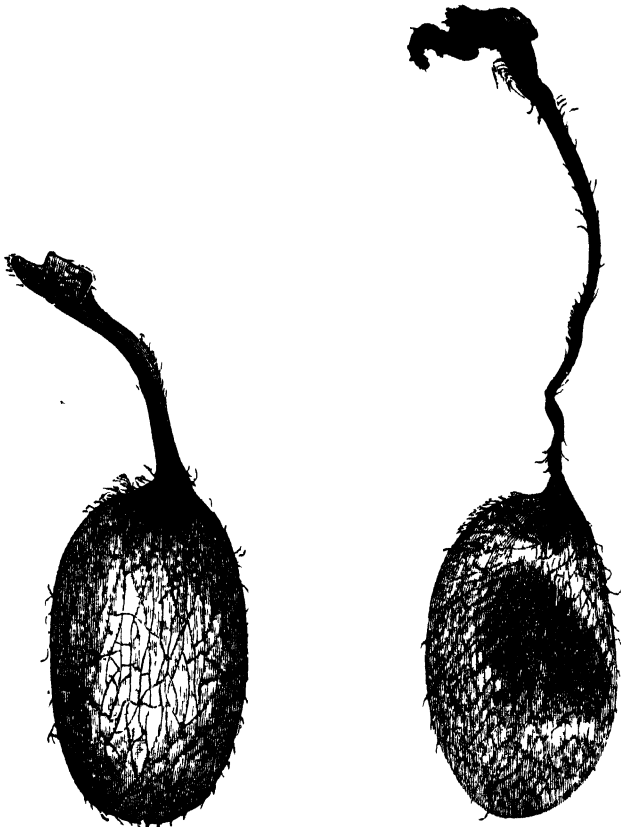

FIG. 75.—BARSATI LARYA COCOON  
(Small-sized, Hard Cocoon).

FIG. 76.—JADDUI LARYA COCOON  
(Light-coloured, Long Peduncled,  
Small-sized Cocoon).

remain paired till about 4 P.M., when they either separate themselves or are separated by the rearer, the females being kept pinned down in leaf receptacles, and the males given to domestic fowls. The eggs are collected after three days, and kept in smaller leaf receptacles, the eggs of two or three moths (about 500 eggs) being kept in each receptacle. On the ninth day the eggs hatch, and as soon as they hatch, they are put out on trees in which they are secured by pinning them on to leaves. The trunks of trees should be brushed clean of ants and other insects and afterwards



FIG. 77.—MUD-A-MUGA COCOON.

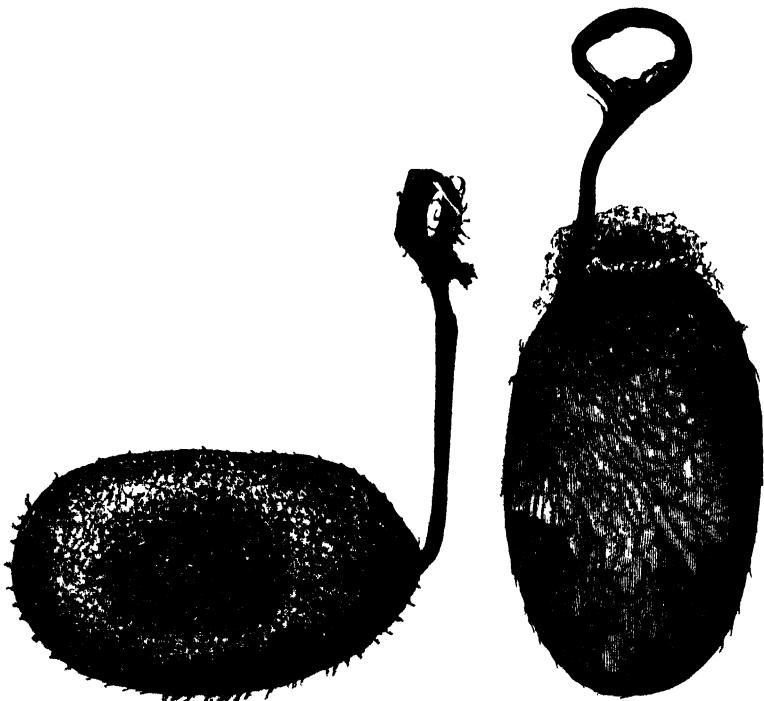

FIG. 78.—AMPATIA DABA COCOON.

FIG. 79.—BARSATI DABA COCOON.

they are each given a circle of *Bhela* oil to protect the worms from the attack of ants, etc. To each tree about half a dozen to a dozen of seed-receptacles are pinned on at different places, that the whole of the tree may get covered with the worms and not any particular part of it only. The trees have to be kept low for facility of watching the insects against ants, wasps, birds, squirrels,

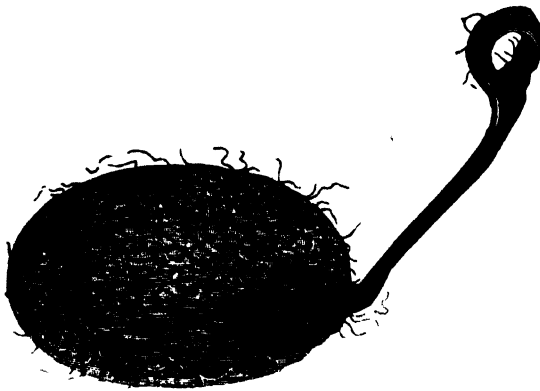

FIG. 80.—BUGUI COCOON.



FIG. 81.—BAR-RA COCOON.

warm mustard oil and kept covered with a bamboo tube when not in use) ought to be always in the hand of the rearer, that he may effectively scare away wasps and birds. A bow and pellets of mud are also of great help. In tusser rearing localities, one scarcely sees a bird, the watch kept by the rearers being so strict. When

a bug called *chányá*, a mantis, scorpions, centipedes, a large carabid beetle called *chhabundia*, and other vermin. In this matter great care is necessary. The principal epidemic from which the tusser silkworm suffers, is grasserie (Fig. 82), which is a disease which is produced

readily, both among tusser and mulberry silkworms by feeding them with leaf, thinner, *i.e.*, sappier, than leaf that the worms have been eating hitherto. As sap rises from the ground, a heavy shower of rain makes the greatest difference of consistency in the leaf in the case of short trees. No worm should be kept on branches within four or five feet from the ground, or such branches should be lopped off from the very first. For tusser rearing the annual pollarding should be so done, that all the branches may be above five feet and below ten feet from the ground, that grasserie may be avoided, while the worms may be kept under close supervision. A stick with bird-lime (peepul tree gum mixed up with

the leaf of one tree is eaten away, the branches are lopped off with the worms in them and transferred to another tree, or several trees, and this continued until the cocoons are formed. When the cocoons are all formed, they are brought down with the adhering branches of trees, carefully separated from the branches and sold off in *hâts*. When they cannot be sold so readily, they must be killed. For killing the cocoons, they are put inside a *kulsi* (earthen pot), and inside the mouth of the pot a few sticks are inserted, so that when the pot is upset with its mouth downwards, none of the cocoons may fall out. The pot is then put in this reverse condition over another in which water is boiling over a fire. In about half an hour all the cocoons are killed with the steam rising from the one pot and going in to the other. They are then dried in the sun and kept for reeling. The effect of domestication of tusser cocoons are :—(1) the cocoons tend to get smaller, (2) they get lighter and lighter in colour, (3) the silk gets finer, (4) the peduncle gets longer and longer, (5) the worms get more and more subject to disease. Domesticated cocoons are preferred by weavers, as they produce the whitest and finest cloths.

*The reeling of tusser cocoons* is done by patent processes in the European factories in Bengal, soda or potash being the chief solvent ingredient in use. A single person can reel off the silk from 250 tusser cocoons a day in European factories. The native process consists in boiling the cocoons in water to which ashes of *Assan Kenja*, or other tree or plant (such as linseed plant ashes) are added, or *saji*. For five hundred cocoons about half a seer of ashes are used, or half a *chhitak* of *saji*. A refined method would be the using of lye instead of the crude ashes. The lye may be obtained out of the ashes by repeatedly passing the water through the ashes kept over a piece of calico, until the water looks oily in appearance. The cocoons may be boiled in this lye for about an hour. All cocoons are not softened equally by the boiling, and those that do not work off easily while they are being reeled, are kept separate and boiled the next day with a fresh lot of cocoons. Large and hard cocoons require stronger alkali and longer boiling. When the cocoons have been boiled, they are kept in a pot between folds of a cloth over some ashes, and reeling commenced at once. One day's cocoons are boiled in the morning, one person being able to reel from fifty to one hundred cocoons a

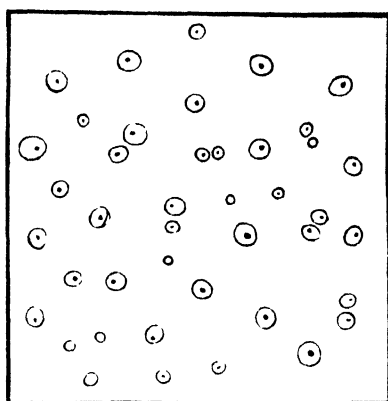

FIG. 82.—MICROSCOPIC APPEARANCE OF GRASSERIE CRYSTALS ( $\times 600$ ).

day. The reeling is done with a *latai* on the right hand, and with the left hand fibres from three to five cocoons are twisted on the thigh, while the *latai* is being wound round with the right hand. As fifty to one hundred cocoons are reeled and twisted by the same operation per day, this primitive method cannot be regarded

as a very ineffectual method of preparing the raw material for the loom. Usually the spinning of tussler cocoons is done in the weavers' families, and it is never done by the rearers. A *kahan* (= 1,280) of cocoons produces from three quarters of a seer to two seers of silk according to quality of cocoons used.

The mulberry tree grows wild all along the Himalayas from Kashmir to Assam, and the mulberry silkworm known as *Theophila*, is found abundantly on these trees. The variety of mulberry found in the Himalayas is very large. From the gigantic *Morus serrata* to the dwarf *Morus indica*, the gradation is slow. Some have soft succulent leaf, others rough, spiny leaf; some have a large and abundant supply of fruits, others drop their blossoms and are hardly ever known to fruit. Varieties with large-sized

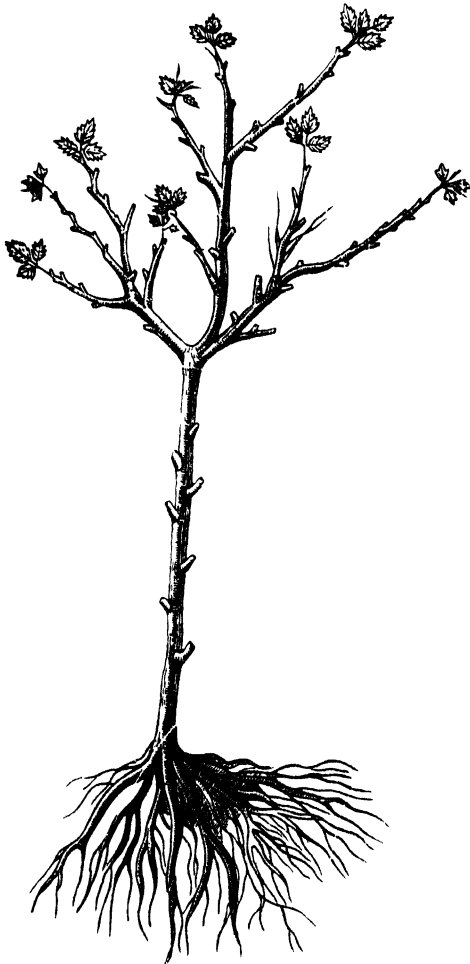

FIG. 83.—MULBERRY TREE PRUNED AND STRIPPED FOR TRANSPLANTING.

leaves set close to one another on stems, smooth and thick with gummy sap, and bearing little or no fruits, are the best to choose for silkworms. The *Morus alba*, variety *laevigata*, is one of the best varieties to choose. The mulberries in common use in

Bengal and Mysore are the *Morus alba*, varieties *indica* and *sinensis*. The former known as *Pheti* or *Sultani tunt* is the better variety of the two, the gum of the leaf being thicker. It has more planate leaves, and it requires more manuring and cultivation to keep it in condition. The *Morus sinensis* (the *Kajli* or *Chini tunt*) has thinner and sappier leaves, but it is hardier. It is quite suitable for worms up to their fourth moult, but afterwards, *i.e.*, when the worms are well out of the moult and quite strong, they should be given the stronger *Morus indica* leaf. These two varieties do not grow into very large trees, and one of the chief improvements that could be introduced into the Indian industry is the introduction of *Morus lævigata* or some other similar superior variety of mulberry, suitable not only for rearing the poor Bengal cocoons, but also the superior *Bombyx mori* cocoons. The tree system of propagation of the mulberry is also more natural and healthy. Trees when once grown up cost little keeping up, while the shrub-mulberry planted eighteen inches to two feet apart costs about Rs. 75 an acre to maintain.

*Propagation of mulberry* may be either from seed, or from cuttings, or from grafts. Trees grown from seed produce leaf which like *Morus indica* is not quite suitable for rearing worms at the last stage. *Morus lævigata*, *Morus Philippinensis*, the European *Morus alba* and other superior varieties of mulberry can be readily grown from cuttings, and propagation is done usually from cuttings only. The Japanese mulberry, however, does not grow from cuttings, and it is grafted. Though the Japanese mulberry answers to all the requirements of a first-class mulberry, it is no better than some of the best Indian mulberries, and there is no occasion to introduce the Japanese varieties in India. For growing any mulberry from seed one precaution is necessary. Before sowing the seed it should be put in camphor water in a stoppered bottle for an hour, and then sown. Germination is otherwise very partial. Mulberry seed is smaller than grains of mustard, and seed for a large tract of land can be easily sent through post from one country to another. When the seedlings are grown up, propagation may go on from cuttings, and thus the first cost of setting up a plantation saved very much. When cuttings are available, propagation should be from cuttings. When trees are sought to be propagated, there should be a nursery on high irrigable land, well dug up, manured and cultivated and protected with ditches and fences. The cuttings or seedlings should be planted in the nursery nine inches apart, and transplanted on to fields, when eight or ten feet high, at a distance of twenty feet. While transplanting, all the full-formed leaves should be nipped off and all branches within 5 feet of the ground rejected (Fig. 83). Leaf from seedling trees should not be given to worms in their last stage.

The cost of starting a mulberry plantation of the shrub-kind is about the same as starting a mulberry nursery for trees. In

the former case, the cuttings are planted about eighteen inches apart instead of nine inches apart and four or five cuttings planted at each spot instead of one. The cost of establishing a mulberry nursery, one acre in area, for the first two years, is given below :—

|   | Rs. | A. | P. |
|---|-----|----|----|
| (1) Wages of 90 men employed in digging the field with spades in the cold weather, at 3 as. .. ..     | 16  | 14 | 0  |
| (2) Ditching and fencing (by piece-work) .. ..  | 30  | 0  | 0  |
| (3) Cost of 12 ploughings, the plough-man with bullocks and ploughs being hired, at 4 as. a day .. .. | 9   | 0  | 0  |
| (4) Cost of getting 30 loads (about 30 mds.) of mulberry stalks in September, at 4 as. .. ..          | 7   | 8  | 0  |
| (5) Wages of 15 men making cuttings at 3 as. .. ..  | 2   | 13 | 0  |
| (6) Wages of 15 men making hollows in regular lines .. ..   | 2   | 13 | 0  |
| (7) Wages of 45 men planting cuttings .. ..   | 8   | 7  | 0  |
| (8) Hand-hoeing in October by piece-work .. ..  | 1   | 8  | 0  |
| (9) Cutting away the first shoots in December .. ..   | 1   | 8  | 0  |
| (10) Ploughing afterwards .. ..   | 3   | 0  | 0  |
| (11) Cost of putting tank-earth as manure in April .. ..  | 15  | 0  | 0  |
| (12) Ploughing in May .. ..   | 2   | 4  | 0  |
| (13) Irrigation (if necessary) in May .. ..   | 15  | 0  | 0  |
| (14) Weeding in July .. ..  | 3   | 0  | 0  |
| (15) Cutting away of stumps in August or September .. ..  | 1   | 8  | 0  |
| (16) Ploughing in September .. ..   | 1   | 8  | 0  |
| (17) Digging with spades after the November <i>bund</i> .. ..   | 7   | 8  | 0  |
| (18) Two years' rent .. ..  | 12  | 0  | 0  |
|   | 141 | 3  | 0  |

Expenditure in connection with items Nos. (10) to (18) has to be incurred annually, *i.e.*, about Rs. 75.

*Outturn.*—The first crop of leaf which is ready in November or December when planting is done in September, or in April when planting is done in February, is cut away, as the leaf is very thin and sappy and not very suitable for silk-rearing. The crops *bund by bund* that are obtained afterwards are :—

|  | Value.                    |
|--|---------------------------|
| 24 maunds of leaf (with stalks) in January .. .. | Rs. 24                    |
| 36 " " " " March .. ..                           | " 36                      |
| 48 " " " " June .. ..                            | " 24                      |
| 60 " " " " August .. ..                          | " 30                      |
| 45 " " " " November .. ..                        | " 90                      |
| 45 " " " " December .. ..                        | " 45                      |
| <hr/> Total 258 maunds                           | <hr/> Total value Rs. 249 |

An acre of mulberry from the third year, when it is well established, usually yields 300 maunds of leaf with stalks, which is sold as a standing crop, cocoon-rearers buying it up and cutting it away from day to day. The purchase at the above prices is usually on credit, and often the buyers, when they lose their crop of silkworms from diseases, are unable to pay the price of mulberry. The mulberry grower and the silk rearer are therefore both interested in the eradication of diseases. From 300 maunds of leaf 600 *seers* (1,200-lb.) of fresh cocoons are obtainable as the maximum result per acre. The value of this quantity of cocoons

may be as much as Rs. 600. The profitableness of sericulture when loss from disease, etc., may be kept down, can thus be easily imagined.

*Tree-mulberry.*—When rearing is done with leaf from large mulberry trees, the seedling or cuttings planted should not be touched for the first five years as the leaves go to nourish the trees. They should be protected for the first three years at least with gabions, or with a rough envelope of coarse grasses and thorns that injury from cattle may be avoided. If whole bones are put underneath the trees once in twenty years, and the soil underneath the trees annually dug up in November, the trees will always remain in condition. Two pluckings are possible annually, the



FIG. 84.—MULBERRY SILKWORMS IN VARIOUS STAGES (ONE SILKWORM BEING SHOWN WITH A PARASITIC FLY DEPOSITING NITS ON IT).

first in February or March, and the second in October or November, as some leaves must be left to nourish the trees. In the fifth year when the first picking of leaves takes place, each tree will yield about ten seers of leaf at each picking or half a maund in the year. By the tenth year, the yield will gradually increase to a maund per tree. The maximum average yield per tree, may be put down at two maunds, which result will be attained after about twenty years. But the divergence in the yield of leaf is great according to the variety grown. The quantities mentioned will be readily yielded by *Morus laevigata*, *Morus Philippinensis* and the ordinary European *Morus alba*, but not by *Morus indica* or *Morus sinensis*. Every other year the branches of the trees should be pruned off, so that the new shoots coming on with a more



vigorous growth of leaves, can be readily bent, and the picked with the help of a crook without climbing.

The rearing of mulberry silkworms (Fig. 84), and of *Endi*- or *Eri* silkworms indoors on bamboo *dalas*, proceeds on much the same method. Leaves (castor leaves in the case of the *Eri*



FIG. 85.—FECUNDATION AND OVIPOSITION OF ENDI OR ERI MOTHS.

silkworm) are put on the newly-hatched worms, cut up very fine ; the worms with the leaves separated from the eggs after three or four hours, and put separately at the lowest shelf of a *machan* (called *ghara* in the silk districts). The eggs hatching the next day are put higher up in the *machan*, and the third day's worms still higher

up, after which usually no more notice is taken of the eggs, except in the case of the *Barapalu* eggs, in which the hatching is much more tardy. The worms up to the last moult are usually fed five times a day at regular intervals. At the last stage the worms are fed three or four times a day. The worms moult or change their skin four times during this interval, *i.e.*, from hatching to spinning of cocoons. Inside the cocoons the worm moults twice, once in changing into chrysalis and the second time in changing into a moth. Inside the cocoons and as moths they eat nothing. As moths they pair and lay eggs (Fig. 85), and after a few days die off. Strong and healthy moths may live for a fortnight after laying

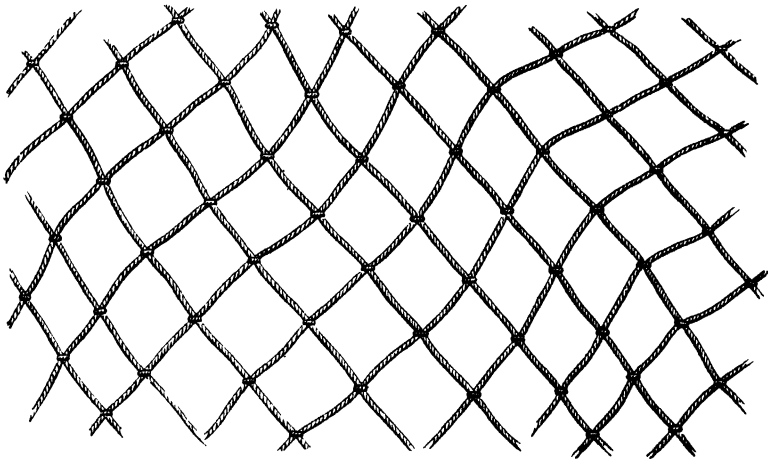

FIG. 86.—THREAD-NET FOR CLEANING AND THINNING SILKWORMS.

eggs; but a moth dying within a day or two after laying eggs may be healthy and their eggs fit for rearing. As leaves are heaped up to *dalas* by repeated feeding, cleaning becomes necessary.

Native rearers neglect cleaning at least in the early stages. But neglect in this matter and in the matter of keeping the worms thin in numbers, and the room well ventilated (though the worms themselves must always be kept away from a current of air), result in worms dying in large numbers specially at the last stage. Keeping the worms thin in numbers and clean and the room well ventilated (though in even temperature) and free from dust, is necessary from the first. Cleaning and thinning of the worms are facilitated by thread nets (Fig. 86) of meshes of about half an inch. A net is spread over the worms resting on dirty leaves, fresh leaves (cut up fine at the two early stages and whole leaves with stalks being put from the third stage) scattered over the net, and after half a minute the net may be removed to another *dala*. This has the effect of separating the worms evenly into two lots. Nets are to be used for cleaning whether the worms need thinning or

not. A *dala* of newly-hatched worms have to be divided up into three *dalas* after the first moult, into nine *dalas* after the second

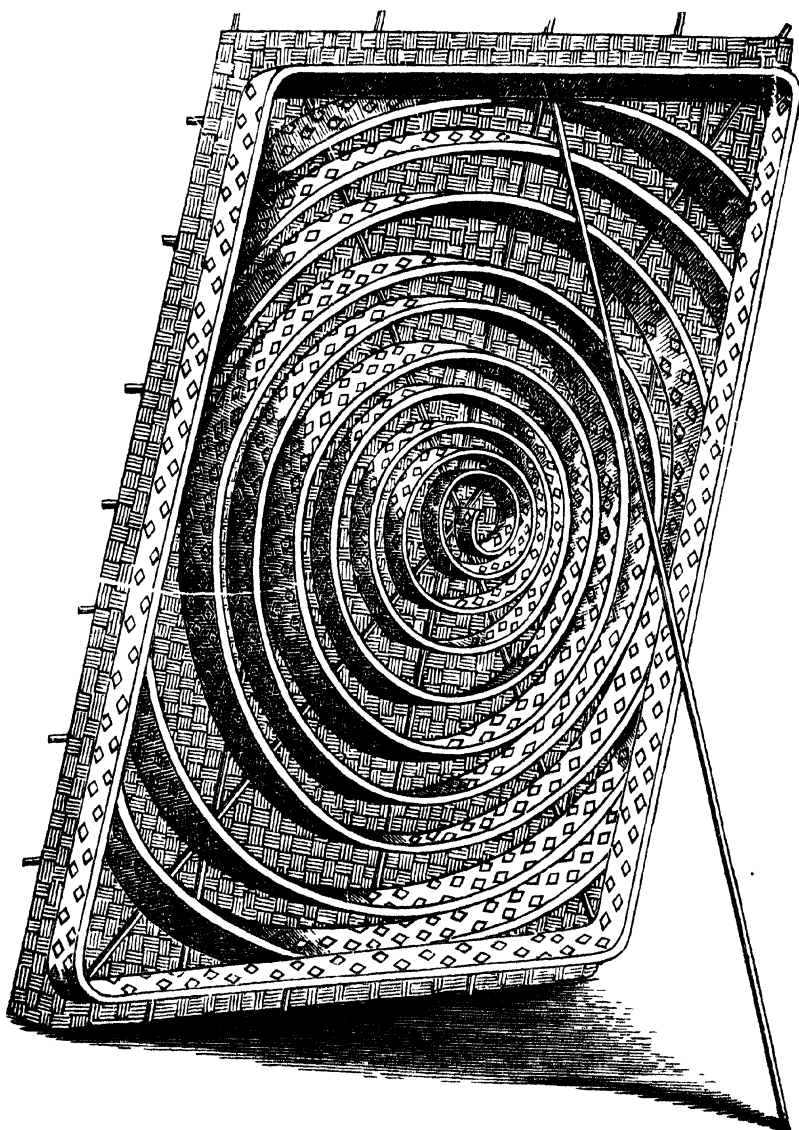

FIG. 87.—CHANDRAKI OR SPINNING SCREEN.

moult, into 27 *dalas* after the third moult, into 81 *dalas* after the fourth moult, and at the last stage the worms occupy twice as

much space (*i.e.*, 162 *dalas*) before they make cocoons. Daily the net from a *dala* with the worms and litter are to be lifted at the mid-day feed, removed on to a fresh *dala*, and the older *dala* removed outside and thoroughly cleaned. If, however, worms are found underneath the net, they must be assumed to be moulting. They should not then be disturbed, but kept on a lower shelf on a separate *nachan* where no feeding should be done for about 24 hours. The worms on the net removed to a fresh *dala* are to be given a feed and then left without food for about 24 hours. Great care is necessary at moulting periods. The point to remember is, it does more harm giving food to moulting worms than fasting them for a few hours until the worms are well out of moult, which is known by their agility and hungry look. If on blowing over the worms they move very fast, one knows they are properly out of moult. If, on the contrary, the movement they exhibit is of a dull and listless kind, they are not quite out of their sickness, and they should be still left without food. An extra feed at the time when the worms are going off to moult does not do them much harm; but feeding too early does harm. Experience is needed in this matter.

Worms in the same room should be all of the same age, as much as possible. That is why tardy worms are kept high upon *nachans*, and early ones lower down, both at hatching and at moulting times. If worms of different ages are kept in the same room, the late worms suffer more from disease. Worms when they are ready for spinning become translucent and they constantly spit out silk from their mouth. At this time in the case of Indian silkworms they are quickly picked and transferred to a spinning screen (or *Chandraki*, vide Fig. 87) where they get convenient bearings for making cocoons. In the case of the *Bombyx mori*, dry twigs are arched over the worms and ripe worms make their cocoons in these arches. In the hot weather, from hatching to spinning, only about 20 days are spent in the plains of Bengal, and in the coldest weather about 40 days. But cocoon-rearing is best done when the temperature is about 75° and fairly uniform. That is why the November *bund* or crop is the best crop and the March *bund* the next best. If large mulberry leaves are used, only these two crops would be taken. But when the shrub mulberry is used, rearing must be done at other seasons also, when, on account of too great heat, or cold, or damp, rearings are more or less unsuccessful. Two good crops of cocoons are better than eight indifferent ones (even the two good crops being subject to infection). Indeed, on account of the parasitic fly pest (Fig. 84) it is not feasible to take all the eight crops in the year, and this is why rearers take a crop and omit the next and then go for seed to some distant place, and the actual number of crops taken in a village is three or four. When the cocoons are formed, they are gathered from *chandrakis* on the third day and sold off at once, or killed in a *kalsi* as described in connection with tusser cocoons, or in a basket put over a

boiling pan of water, the basket being covered over with a blanket. When there is hot sun the rays of the sun are sufficient to kill the cocoons in two or three days.

*Reeling.*—Except in the rainy season, cocoons, however killed, must be steamed immediately before reeling. Steamed cocoons should be reeled off in three or four days. Steamed cocoons should not be spread out in the sun to get dry, but should be kept spread out indoors in *nachans* and reeled off as fast as possible. For small quantities of cocoons the steaming can be done in a basket over a pan of fire as in the case of killing, a blank space being left in the middle of the basket, so that cocoons about six inches thick may rest on all sides and the top, and the steam work its way from the bottom through the cocoons and out of the blanket. When for ten minutes the steam is coming out of the blanket, the cocoons may be considered to be properly steamed. When dealing with large quantities of cocoons special erections are necessary for steaming. In the rainy season the air is naturally steamy and it exercises the same beneficial effect on the cocoons as an artificially produced atmosphere of steam. But cocoons *spun* in the rainy weather do not unravel properly in basins and they are a source of great loss to European factories where even silk is required to be made. Steamed cocoons are reeled off in a basin of water (Fig. 88) which is kept boiled with fire or steam, and passed in two lots to a reel, which as it is wound round and round, the cocoons get worked off. As each cocoon gets worked off, its place is supplied by another, the end of which is kept ready for the purpose by the reeler, and an expert reeler can reel off as many as four *kahans* of cocoons per day when he has to make the best kind of silk, and ten *kahans* a day when he has to make native *khangru* silk.

*Silk Fibre.*—There is no fibre so long, so strong, so fine, so soft, and so smooth, as the silk fibre. When we talk about the staple of cotton fibre being long, we only mean that it is  $1\frac{1}{2}$  or  $1\frac{3}{4}$  inches in length; when we talk of jute fibre being long, we only mean that it is 12 or 13 ft. long, but the tusser cocoon has an uninterrupted fibre, 800 yards long, and some varieties of mulberry cocoons one uninterrupted fibre of 900 yards, and yet the fibre is so fine that in the case of the tusser this single fibre from a cocoon is 700 milligrammes and in the case of the mulberry silk it is 250 milligrammes in weight. So fine is the thread, that although there is no difficulty, on account of its strength to draw out the thread out of single cocoons, in practice never fewer than three cocoons in the case of the tusser and never fewer than four or five in the case of the mulberry cocoons, are used simultaneously for drawing out the thread from. It is for the finest silk-muslins or silk-gauze that thread is made by drawing out the fibre of four or five mulberry cocoons together. So strong is the fibre of mulberry cocoons that it is quite easy to draw out the fibre on to a reel without a single break, though this fibre is so fine that for

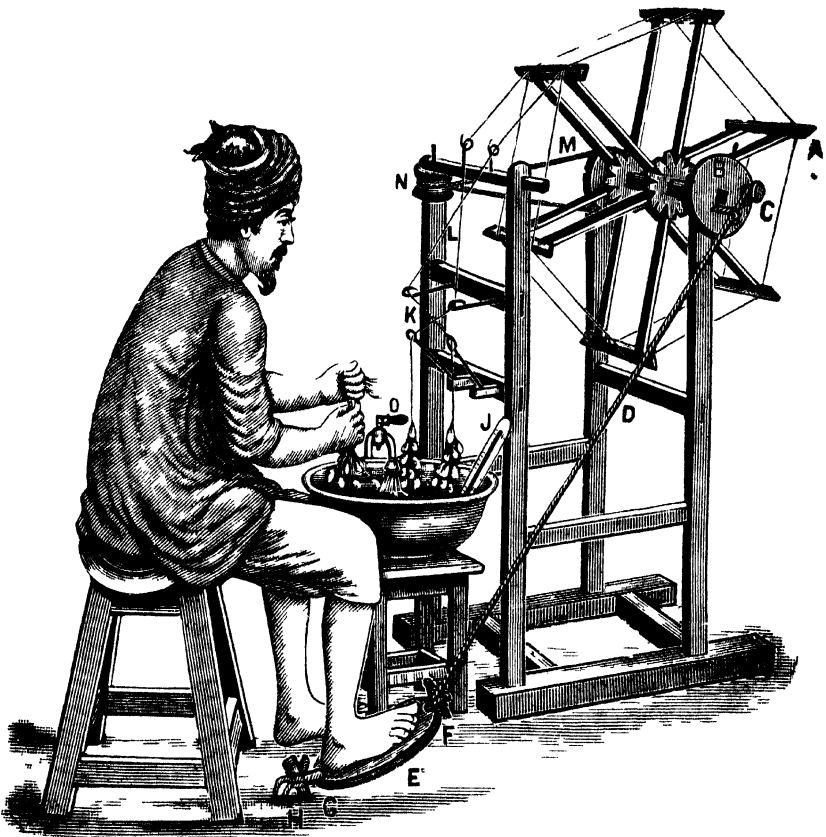

FIG. 88.—A NEW REELING MACHINE WITH PEDAL ARRANGEMENT

- A—Reel ( $2\frac{1}{2}$  feet diameter)
- B—Pulley at right hand end of the reel (weighted)
- C—Pin or screw on B
- D—String or wire
- E—Plank (pedal)
- F—Hole at one end of E for tying string or wire
- G—Hole at the other end of E for tying the pedal to a pin fixed into the ground with wire rope
- H—Pin fixed to the ground for keeping the pedal in position
- J—Thermometer for testing the temperature of water in the basin for boiling and reeling the cocoons
- K & L—Two croisures
- M—String giving motion to the eccentric
- N—Pulley on which the eccentric rests
- O—Steam cock.

practical purposes it is never used for making fabrics in these days, though perhaps in olden times the "Koan vests" of the Roman empire were woven out of such single silk fibre. And yet each single fibre of silk is made of two ultimate fibres agglutinated together with a natural gum which gives the fibre its brilliancy.

These two ultimate fibres or *baves* come out of the spinarette at the mouth of the silkworm, and are ultimately derived from two glands situated on two sides of the interior of the worm. These two glands are sometimes taken out of the body of the silkworm, put in vinegar and afterwards drawn out in the form of silkworm gut which is used for tying fishing hooks to the line. For its weight and pliancy there is no such strong substance as the silkworm gut.

But though the fibre is the strongest, finest and softest fibre of all, one silk fibre differs from another so much that one is valued at Rs. 10 a seer, while another at Rs. 30 a seer, and a country which habitually deals with a Rs. 10-per-seer fibre can ill compete with a country which habitually produces a Rs. 30-per-seer fibre. The native-made silk of India called *Khangru* or *Ghangru* silk sometimes sell at only Rs. 10 per seer, and Rs. 12 per seer may be taken as the average price of *Khangru* silk. The European filature reeled silk is much better. It sometimes sells for only Rs. 16 or Rs. 17 per seer, but its average price is about Rs. 20. Italian, French, and Japanese silks are still better and they sell for about Rs. 30 a seer.

Why is there this difference in price? Let us first see the cause of difference between European filature reeled silk and *Khangru* silk. As much as one seer a day may be reeled by a couple of men on the *Khangru* system, though the average quantity is nine chhitaks. As much as  $4\frac{1}{2}$  chhitaks per day is sometimes turned out by a pair of operatives in European filatures, but the average may be taken at  $3\frac{1}{2}$  chhitaks. This difference comes of the Europeans looking to quality and the Indians chiefly to quantity. There are three causes which combine to make the European filature reeled silk so much superior to the country *Khangru* silk:— (1) The European factories regulate the number of cocoons reeled more exactly and usually use a smaller number, five or six cocoons instead of twenty cocoons. (2) The European factories insist on a knot being put whenever there is a break. (3) The European factories cross two adjacent lots of fibre twice on themselves to effect an agglutination of fibres, while the country reelers not giving any croisure and putting no knots can reel away very fast and get larger absolute and relative produce.

Is it worth while for our country reelers to follow the European system, and produce a smaller quantity of superior fibre? Not at present, when the demand for silk at Rs. 12 a seer in India is very large and very keen. There is practically no demand for the Rs. 20 silk in the Indian market. Ask the large silk-mill-owners of Bombay what silk they want. They will tell you silk of the value of Rs. 5 or Rs. 6 per pound; and as for handloom use, they prefer, as a rule, the cheaper silk. A few *skeins* of what is called by our country weavers "Latin silk," that is, European filature reeled silk, are always used by exceptionally good weavers to meet some special demand, but it is the *Khangru* silk that they are accustomed to handle. The demand from Benares, Lahore,

Amritsar, Karachi, Nagpur and other centres of silk weaving is for the Bengal *Khangru* silk, and this demand is very great. Nearly a crore of Rupees worth of silk is exported to other Provinces of India from Bengal against fifty lakhs of Rupees worth of superior filature reeled silk exported to Europe and America. The demand for the *Khangru* silk shows an upward tendency and the demand for the superior European silk shows a downward tendency. There is therefore no hesitation in what I have recommended. Go in for quantity *for the present*, and turn out *Khangru* silk for the country.

The next question we should turn our attention to, is, why is not the European filature reeled silk as good as Italian, French or Japanese silk? In Europe there is demand mainly for high-class silks, as in India there is demand chiefly for low grade and cheap silks; and in India also as time goes on, the demand for high class silks will increase. If the mills and weavers of India can buy high class silks for Rs. 8 per lb., they will not buy low grade silks for Rs. 5 or Rs. 6 per lb. High class silks are more easily unravelled, and there is less waste in unravelling it, and though labour in India is cheap, the manufacturer finds it pays him to buy high class silk for Rs. 8 a lb. If in Europe also European filature reeled silk can be sold for Rs. 8 a lb., it will sell better, but European manufacturers do not care about using silk which gives so much trouble in unravelling. It is therefore worth while to be prepared for the European market and for the future demand of the Indian market.

What is the cause of the inferiority of the European filature reeled silk of Bengal as compared to the European and Japanese silks? This is a question which we have not answered yet. From recent experiments I have come to the conclusion that the inferiority comes neither from the inferiority of the workman nor of the machine, but it is to be attributed mainly to the inferiority of the Bengal cocoon. The Bengal cocoons are the worst in the world, and with no machine is it possible to produce out of these cocoons silk of such quality as can be produced out of the *Bombyx mori* cocoons. The reason is not far to seek. The length of the fibre on a Bengal cocoon is about 200 to 250 yards, while that on a *Bombyx mori* cocoon about 800 yards. The silk made out of *Bombyx mori* cocoons (which are the staple of Europe and Japan)

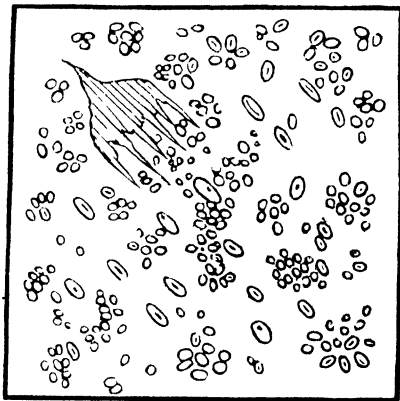

FIG. 89.—MICROSCOPIC APPEARANCE OF PERRINE ( $\times 600$ ).



must therefore contain about four times fewer joinings than the silk made out of *Bombyx Cressi* or *Bombyx fortunatus* cocoons of Bengal. The average length of fibre on a Mysore cocoon is about 300 yards, and the *Bombyx meridionalis* cocoons of Madras therefore produce a little better silk than the silk produced by the same machine in Bengal filatures out of Bengal cocoons.

How to introduce the *Bombyx mori* cocoons into India is therefore the problem before us. I have worked the *Bombyx mori* cocoons successfully for a number of years in Bengal, and they have been worked in Kashmir also. The difficulty with regard to the

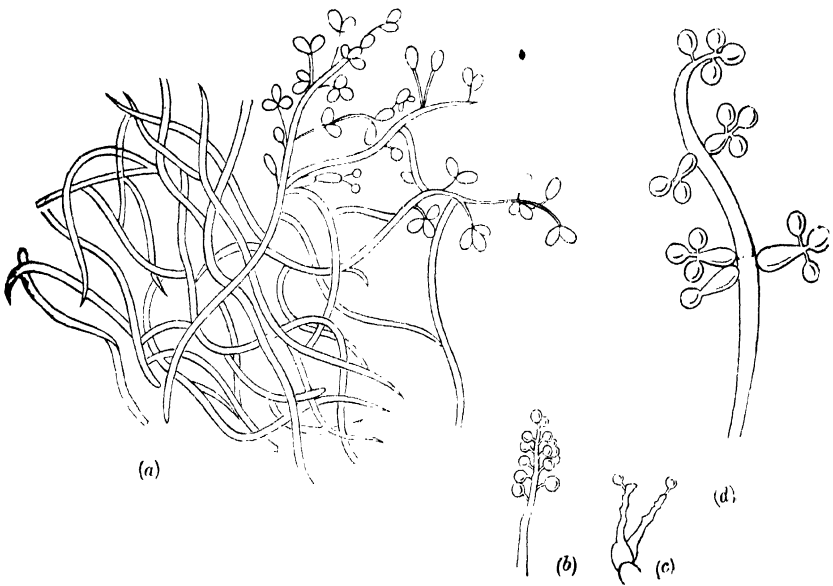

FIG. 90. MICROSCOPIC APPEARANCE OF MUSCARDINE.

- (a) Hyphæ with spores; (b) End of an old branch which is producing spores by abjunction and is thickly covered with spores, the youngest of which are terminal; (c) two sporogenous branches from which all the spores have fallen except the youngest and uppermost (enlarged 500 diameters); (d) young sporiferous hypha (enlarged 700 diameters).

rearing of this class of cocoons is in the matter of conservation of seed or eggs. The eggs require a period of intense dry cold, and they must be protected from hot winds at other times. In every part of India the *Bombyx mori* worms can be reared (and in many parts they have been reared), successfully at some time or other from February to June. But the conservation of the eggs from April to next January is possible only in a few places like Kashmir, Dalhousie, etc., where in winter the cold is severe but dry. There is another difficulty with regard to the *Bombyx mori*. The epidemic called *Pebrine* must be kept suppressed by annual examination of

the seed with a microscope. If railway communication is established between Kashmir and the rest of India, and if Kashmir established the "system of grainage" as devised by Pasteur, she can supply the rest of India with seed. This will give one good crop in the year; which will make a Rs. 30-per-seer silk. But a separate organisation of having a grainage and hibernating station at Dalhousie may be also tried.

*Diseases of silkworms.*—The greatest obstacle to sericulture is the prevalence of certain diseases among silkworms. In Bengal *Pebrine* (Fig. 89), *Muscardine* (Fig. 90), *Grasserie*, and the fly-pest (*Tricolyya bombycis*), do the greatest amount of damage; while other diseases, such as *Flacherie*, *Court*, *Gatine* and the



FIG. 91.—MICROBES OF FLACHERIE.

*Dermestes vulpinus* also do some amount of harm. In Mysore *Flacherie* (Fig. 91) does the most harm, while other diseases are scarcely known.

*Pebrine* (Bengali *kata*) is caused by a microscopic organism which, when magnified 600 diameters, looks like grains of *mung* seed. It is a slow-acting disease, taking thirty days for complete development, so that, when the seed is badly pebrinized, the worms suddenly die off at the last stage. If rearing is completed in less than thirty days, pebrinized worms spin poor cocoons. When the seed is not very badly pebrinized, some worms, *i.e.*, those produced from pebrinized eggs, die off on the thirtieth day, while others which catch the infection from the pebrinized worms die later on, or make cocoons and come out as moths, which show *pebrine* corpuscles, and then die. Some worms from eggs free from *pebrine* happen to escape infection. These spin cocoons,

come out as moths, and show no pebrine corpuscles. The eggs from these moths are safe to rear from. Each moth is made to lay eggs under a separate cover, on sheets of paper, and after at least five days each is examined under a microscope. The eggs of those moths, the blood of which show no pebrine corpuscles, are retained, the rest being burnt. The eggs selected out are then superficially purified from diseases, by a dip in a sulphate of copper bath ( $\frac{1}{2}\%$  solution), hung up, in a cool but airy place to get dry and then taken inside a rearing room, which with its rearing appliances has been already disinfected (Fig. 92) with sulphate of copper wash and sulphur fumes. The rearing from eggs thus selected and in room thus disinfected cannot fail from pebrine. Where rearing takes place once a year, disinfection of appliances is not necessary for protecting the worms against pebrine, provided the seed itself is selected. The germ of pebrine loses its vitality in seven months and local infection thus dies out before the next annual crop is taken. Natural freedom from pebrine is more



FIG. 92.—USE OF ECLAIR VAPORISER FOR DISINFECTION.

desirable than freedom secured by microscopic selection. Thus, the *Bombyx meridionalis* silkworm of Mysore is naturally free from pebrine, and microscopic selection is not necessary in rearing this variety, and this variety is giving good results in Bengal. A lot of seed selected out free from pebrine always tends again to get more and more pebrinized from 1% to 5%, from 5 to 20%, and from 20 to 50%, and so on, until in a few generations every moth again is found to be pebrinized. In this case, therefore, micros-

copic selection is needed at every generation to secure exemption from pebrine. Five per cent. of pebrine in the seed does not affect the result, but 20, 30 or 50% of pebrine left without selection, spoils the result more or less, though even with 80 or 90% of pebrine in the seed, a sort of a crop is obtained in the hot weather, the pebrine not getting time to develop so fully as to kill the worms. It only weakens the worms, so that they either make poor cocoons, or succumb to other diseases. A pebrinized lot of worms thus falls an easier victim to *Flacherie*, *Muscardinie*, *Grasserie* and *Court*, than a lot of worms which is free from pebrine. It is essential to have a number of nurseries in each silk district in Bengal, where the system of microscopic selection will be rigorously followed and the cocoons obtained from selected eggs sold for seed-purposes, or where a stock naturally free from pebrine is reared. The few nurseries that have been established by cocoon-rearers in Bengal are doing very good work.

*Muscardine* is another epidemic of the silkworm which is due to a higher fungus, quite visible to the naked eye in its fully developed form when it partakes of the nature of a white mould on the bodies of dead worms. The worms which have this mould get like sticks of lime, hence the Bengali name *Chunakati*. This epidemic is also readily controlled, by disinfection of eggs and all the appliances used, and rearing the worms in a clean manner. If through neglect of disinfection of the rearing house and the appliances, of the eggs at the commencement, muscardine does break out, it can be stopped, by cleaning the worms with nets, keeping the worms fasting for a few hours and by burning sulphur afterwards in the room, thoroughly shutting it up. The cleaning will have to be done daily after this and a little sulphur burnt after the room has been smeared with sulphate of copper solution. Many a rearing was thus saved from muscardine in connection with the experiments with which the author was entrusted for ten years.

*Flacherie* is an epidemic caused by the fermentation of mulberry leaf inside the stomach of silkworms. Such fermentation may be caused by various microbes, but the microbe which is mainly instrumental in setting up the gastric fermentation is the *Bacillus nagaterium bombycis*. The disease is known in Bengal as *Kalsira* because the dorsal vessel of the worm gets black. Putrefaction, however, sets in very rapidly and the whole worm gets black and putrid soon after death. This disease is so common in Mysore, because there the custom prevails of feeding the worms seven to nine times a day instead of three or four times. The organism may be either in the spoilt, dusty or heated mulberry leaf, or in the intestine of the silkworm. Weak worms have a greater proclivity to take the epidemic, so that a feed of the same lot of mulberry may give Flacherie to one rearing and none to another. The state of the rearing room also has a considerable effect on the disease. A stuffy, close room would give Flacherie to silkworms, while a well-ventilated room gives comparative immunity. Dust, specially dust raised at delitage, aggravates the epidemic. The remedies are: (1) disinfection of eggs, rearing house and appliances with sulphate of copper solution. (2) Feeding of the worms not more than five times during the early stages and not more than four times a day during the last stage. (3) Using of fresh unfermented leaf, without dust, without dew or other moisture, and of leaf that has not been submerged under water or otherwise got under the control of microbes in the field while growing. (4) Keeping the rearing room well-ventilated. (5) Cleaning the worms daily and yet raising no dust, by taking the trays out for dusting, and *leaping* the floor instead of sweeping it.

*Gatine* (Bengali *Salpha*) is a form of indigestion which is caused by excess of heat or excess of cold, which takes away the appetite of the worms, and though they are given leaf they do not eat, or eat only occasionally. The worms look elongated and

white. In *pebrine* also the worms look white, but they look short and not elongated. The ultimate form which gattine takes is the same as in the case of *Flacherie*. They become black and putrid. *Gatine*, however, is not so fatal, and it does not spread so rapidly as *Flacherie*; and if the worms are removed from the cold place, or if by a *punkha* or other means heat can be lessened, the worms recommence eating and the epidemic is arrested. It is best to avoid rearing in April or May, and in December and January, when the temperature cannot be easily controlled.

*Grasserie* (Bengali *Rasá*) is a disease which is not associated with any microbe. It is caused by a sudden change in the character of food from a less sappy to a more sappy condition. Worms ought to be given stronger and stronger leaf as they get older and older; but if owing to a heavy shower of rain following protracted drought, or change of field, the consistency of leaf changes into a more sappy condition, *Grasserie* at once breaks out. The remedy is to use leaf gathered from trees and eschew the use of shrub leaf as much as possible. The recommendation to grow large mulberry trees is very important for this among other reasons. In Europe and in Kashmir where leaf from trees is used, *Grasserie* is never known in the epidemic form, while in Bengal more loss takes place from *Grasserie* than from *Flacherie*. In fact, *Grasserie* is looked upon by the French peasant as an auspicious sign, as an indication of a full harvest.

*Court*, called in Bengali *Láli*, *Rangi* or *Kurkutte*, is more an abnormality than a disease. A worm affected with *Court*, turns into the chrysalis without making a cocoon or making a very flimsy one. The chrysalis turns into a moth which may lay eggs, and examined under the microscope it may not show any disease. But the reproduction from such seed gives *Court* in a more exaggerated form in the next generation, and it is, therefore, an abnormality that must be avoided. If worms are fed on *naicha* leaf, that is, on leaf from a new plantation, or from shady places, or given an insufficient supply of leaf at the last stage, this abnormality is noticed, and it seems to be hereditary.

*Double-cocoon* (Beng. *Genthe-koa*) or two worms jointly forming one cocoon, is an abnormality which is not very common in Bengal, but it is very common in Japan and China, and fairly common in Europe. The tendency is hereditary, and as double cocoons cannot be reeled, they are often fraudulently used for obtaining seed for sale. The use of such seed has resulted in breeds that show the abnormal tendency to an exaggerated degree. In Bengal, cocoons being always bought for seed, there is no fear of this abnormality assuming alarming proportions.

The *fly-pest* does very great harm to the silk crop in Bengal. The *Tricolyya bombycis* which is a tachinid fly, lays its eggs only on silkworms. The eggs hatch into maggots which penetrate into the body of the silkworms, and in time kill the silkworms either before or after they have made cocoons. If a silkworm dies after

making its cocoon, instead of a moth, a number of flies come out of the cocoon. These infest the rearing room, and it becomes impossible to rear silkworms at the next generation. That is why Bengal rears give up rearing every other generation, and every time go to some distant place for seed. With the seed-cocoons, however, a few maggots of the parasite always come into the village, and some damage is always done. The remedies are : (1) For all the villagers to seed their cocoons in the distant village where they go to buy them, and bring home only eggs. (2) Never to allow any villager to take two crops in succession but to make all to stick to the three or four regular crops. (3) If these precautions are impossible to adopt and if the fly must be dealt with, the rearing room must be built in a special manner, the windows away from the entrance being fitted up with wire

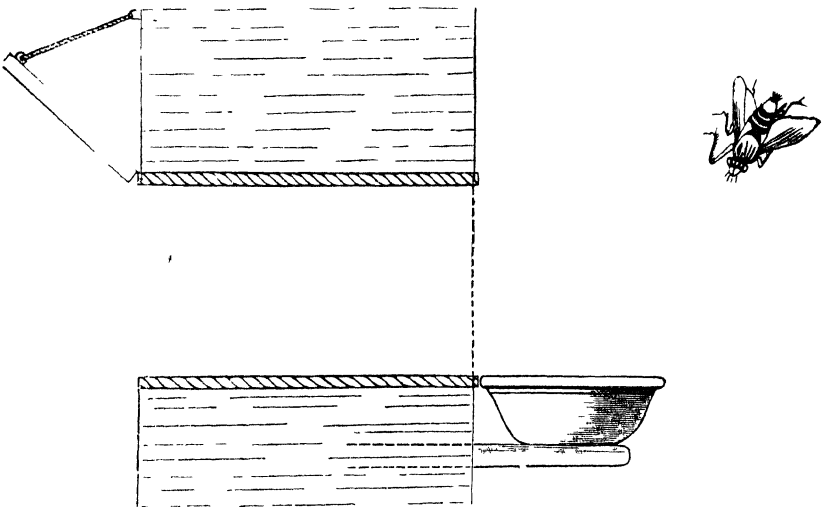

FIG. 93.—FLY TRAP.

gauze, and outside the windows vessels of water with a few drops of kerosine oil to each being kept at a height of five or six feet from the ground, while before the entrance, which should be kept shut in daytime as much as possible a cow-dung fire should be always kept, which should evolve smoke. This has the result of the parasitic fly avoiding the entrance, congregating outside the windows and rushing every now and again into the troughs of water and drowning themselves, believing them to be entrances to the rearing room. In Fig. 93 a parasitic fly is shown ready to drown itself in a trough of water outside a ventilator or fly-trap.

The *Dermestes vulpinus* is a beetle which eats up silkworms, chrysalids and moths, both in the larval and imago stages. These also come with the seed-cocoons. They also harbour in cocoon

godowns. If seeding is done outside rearing rooms, and if the rearing rooms and appliances are kept scrupulously clean, there is no fear of loss in an epidemic form from this pest. Once only has the author seen the *Dermestes* ruining the rearings in a few villages near Berhampore.

The *Eri* silkworm is reared in the same way as other Polyvoltine silkworms of Bengal. The cocoons, however, cannot be reeled, and the method of dealing with the cocoons should therefore be described. The moths should be allowed to escape from the cocoons, and the insects should not be allowed to remain in the cocoons as in reeling mulberry or tusser cocoons. The rearing and spinning, therefore, of the *Eri* silkworm involves no killing of animals, and for this reason alone *Eri* silk-rearing is popular among



FIG. 91.—SPINNING OF PIERCED COCOON.

amateurs in this country. The fibre also is strong, and *Eri* or *Endi* cloth is on this account very popular, and the rearing of the *Eri* silkworm, though less profitable than that of mulberry or tusser silkworm, is not altogether without advantages. The cocoons, after the moths have escaped from them, are boiled with ashes or better still with lye, as in the case of tusser cocoons, and when cool, well kneaded in the warm lye, and then washed by constant kneading in clean water, wrung out and dried in the sun and spun with a spindle (Fig. 94) or a wheel at leisure. *Eri* rearing and spinning must remain for years to come a cottage industry. But *Eri* cocoons are carded and combed and spun like cotton or wool in European mills, and when the industry is established, on a large scale anywhere, a *carderie* on European principles may be established.

## CHAPTER LXXX.

### LAC-CULTURE.

*Lac-culture* is another most *profitable industry*; but the price of lac has varied very much within the last twenty years. Sometimes it has been as low as Rs. 17 per maund, but in recent years the price has been much higher, as much as Rs. 210 per cwt. having been paid in some years for shell-lac, but the prices are unsteady.

*Suitable Trees.*—Lac is a resinous incrustation which grows on tender branches of *Kusumb* or *Kusum* (*Schleichera trijuga*), *Palas* (*Butea frondosa*), *Baer* (*Zizyphus jujuba*), *Ghutbaer* (*Zizyphus xylopyra*), *Peepul* (*Ficus religiosa*), *Baniam* (*Ficus indica*), *Gular* (*Ficus glomerata*), *Rahar* (*Cajanus indicus*), *Phalsa* (*Greuna asiatica*), *Babul* (*Acacia arabica*), and Crotons. It has been also seen on mango trees. There are at least two distinct species of lac-insects, one of which produces a thick incrustation and the other a thin incrustation, the former being obviously the more profitable kind to grow. In many parts of the country lac is found wild on trees, and the natural adaptability of a place for lac is best judged from the presence of the insect in the wild state. It is also desirable, about once in five years, to go back to the wild stock for seed. Exchange of seed is also recommended. If on squeezing the incrustation on a branch, a red liquid is seen to exude, it may be concluded there are living eggs on the branch, and it may be made use of for seed.

*Inoculation.*—The two proper seasons for inoculation of the seed to branches of new trees, are June and November. When trees are inoculated in June the crop is obtained in November, and when they are inoculated in November or December, the crop is obtained in June. Inoculation should take place for the first time in November as insects are liable to be washed out with heavy rain if inoculation takes place in June. June inoculation is to be preferred in places where the rainfall is light and where the cold is severe. In localities, such as the Darjeeling hills, where the rainfall is very heavy and where the cold is also severe, it is useless attempting the introduction of lac-culture. The localities most favourable for lac-culture in India are Bilaspur, Pertabgarh, Sonthal Parganas, Singhbhum and other districts of Chota Nagpur Division, Mourbhanj and the Orissa Division generally, Saran, the Central Provinces, and probably the Deccan. Sometimes one variety of insects dies off with the heat of summer where the heat is intense, when seed of another variety which is able to stand the heat should be tried. Inoculation of seed-sticks may be done by simply tying the sticks in different parts of a tree, with the interposition of a bundle of grass, or by putting the bits of sticks in mosquito net bags and hanging them in different parts of a tree. The red insects will soon be found crawling out of the



sticks and spreading over succulent branches and gradually throwing out incrustations.

One foot of seed-stick is sufficient for ten feet or more of tender branches. A bundle of seed-sticks containing fifty one-foot sticks, can be usually purchased for Re. 1 to Re. 1-8. When through heat or cold seed becomes scarce, Rs. 5 per bundle has to be paid for seed. A fortnight after inoculating a newly pruned tree, the empty sticks are to be taken down and used for the extraction of lac. If insects are seen coming out even after a fortnight, the seed-sticks should be taken down and tied to fresh trees. When all the fresh branches have got insects uniformly distributed over them, the inoculation has been done fully and properly. If the branches show no insects in many places, a full crop cannot be expected.

*Cultivation.*—For lac-culture the trees must be kept in condition and as free from ants and other insects as possible. The cultivation of the soil under the trees is of great help, and crops suitable for growing under shade, specially turmeric and ginger, should be grown by application of manure. The trees remain vigorous owing to the cultivation of the soil under them, and they produce a larger quantity of lac.

*Pruning.*—To obtain vigorous growth of branches, pruning of the trees is essential. Trees should be pruned in February, that in June it may become full of long and tender branches, when inoculation is done. For November inoculation, the pruning of trees is done in June. So pruned, the trees become full of long and tender branches in November.

*Development of the insect.*—The insects remain still after they have once spread out and they simply suck the juice of the branches. While thus engaged, the lac covers them up from all sides. As the insects develop, the incrustation round each also develops. The insects are either male or female, mostly female. Male insects have their lac-incrustation somewhat longer than the incrustation round females. The incrustations round females are almost spherical. The proportion of male to female is about as 1 to 5,000. The male insects when fully developed become winged and they fly away. The female insects continue to grow inside their cells and they get completely covered up with the incrustation which becomes thicker and thicker. In this state the female lays eggs, and makes round each egg a separate covering of lac. When the laying of eggs is finished, the female develops within its body a red liquid which is to act as milk for her young. At this stage the seed-sticks are gathered. The eggs after becoming insects eat through the substance of the mother and then spread out into the branches of trees into which they are inoculated. The seed-sticks should be kept in cool and dark rooms, and when they begin to come out, they should be exposed to the sun for a day and then attached to trees by tying or by being hung up on mosquito-net bags.

*Quality.*—*Kusumb* trees produce the best lac. *Phalsa* tree lac is also good. *Baer* and *ghut-baer* lac is only slightly inferior,

and *Palas* tree lac, which is the darkest red, is the poorest of all, though the *Palas* tree is more frequently used than any other.

*Manufacture.*—After the incrustations are scraped out of twigs, they are ground in querns, and then strained and sifted with *chalnies* and with fanning which helps to eliminate the light extraneous matter from the fine dust of lac which is heavy. The dust is then put in clean water, and by repeated change of water the lac is separated out. The water containing the lac dye is run into vats, where the dye settles. When the dust is washed in vats of clean water, it is placed in close woven cane-baskets (*dhamas*) and it is rubbed on the sides of the baskets, which helps to make the dust gradually free from the red colouring matter. The water with the red colouring matter is sometimes taken up with cotton wool, in which state the cotton wool (*áltá*) has a commercial value for domestic purposes, for dyeing feet red, etc. The washed dust after it is dried is sold as seed-lac. In the washed state the seed-lac should be golden in appearance. Resin mixed up with seed-lac goes to make shell-lac. The resin is ground and sifted, and fifteen per cent. of the weight of the seed-lac used, are added, and the mixed dust is inserted within a long cloth bag. One end of the bag is tied to a post and the other end twisted, while a fire is kept between under the bag. As the twisting over fire proceeds, the dust gets converted into a liquid form and comes out, and is gathered from the surface of the long bag, with brass plates or plantain leaf-sheaths, in the form of shell-lac. The long bag is only about 6 inches in circumference, but the length may be 15, 30 or 300 ft., according to the quantity of the dust treated. The shell-lac should be of light golden colour, not red or black. The shell-lac can be further melted in pots, and with a stick, a quantity can be taken out, and rolled on the stick until it gets somewhat solidified in which state it can be moulded in the form of a hollow cylinder, into which is inserted red-lead, yellow arsenic, bone-black, prussian blue, or some other colouring matter, for the manufacture of sealing wax. The lac, with the colouring matter, is beaten and kneaded in the soft state, until the colouring matter is evenly distributed through the lac, in which state the lac is put on a slab or marble or slate smeared over with lard, and moulded in the form of sealing wax. For one seer of shell-lac, one or two papers of Chinese red-lead are sufficient to give it a rich colour. The red-lead costs about Rs. 4-8 per seer.

*Yield.*—According to the size of a tree from ten seers to a maund of crude lac is obtained from a tree. The manufacturers buy the lac, either on twigs, or scraped from the twigs.

## CHAPTER LXXXI.

## APICULTURE.

APICULTURE is carried on in boxes as an entirely artificial industry, in Europe and in America. Even the breeding of queens is carried on as an industry. In India gathering of honey and wax is carried on as a forest industry, and no attempt at domestication is made, except in the Khasia hills and in Kashmir. As in England honey has a different flavour according to the nature of flowers that prevail in a region, so has certain Indian honey a peculiarly fine flavour and quality. The honey which is prized the highest (chiefly a medicine for ophthalmic diseases) is the lotus honey of Kashmir. The purest lotus honey is gathered from the vicinity of lakes full of lotus, and the best is gathered from little hives found on the flowers themselves. Orange honey is very rich, and thick orange honey is gathered in Sylhet and Khasia hills where orange trees abound. But large quantities of honey are gathered from forests all over the country, and apiculture or rather the gathering of honey, is a profession carried on systematically by certain castes, usually by fowlers. In the district of Murshidabad and in the State of Mourbhanj, wild honey is so plentiful that it can be bought for four annas a seer, *i.e.*, it is as cheap as sugar. This is one reason why the artificial methods of apiculture that are practised in Europe and America, which involve a great deal of trouble, are not as yet suited to this country. The varieties of bees in India are also different and various, and they have not been subjected to that study and domestication which European varieties have been. The Italian bee has not thriven in India. It ate more sugar than the honey it produced. In the winter, under the artificial system of rearing, bees had to be fed with a syrup consisting of 1 lb. of sugar, 1 oz. of common salt, and a tablespoonful of vinegar, mixed up with  $6\frac{1}{4}$  pints of water, and they had to be kept artificially warm with quilts on the hills. In summer they had to be given water to drink, which was kept close to the hive. If apiculture after this method is carried out, the honey is either taken out and sold in the comb, or the honey is extracted from the comb by a little centrifugal machine.

Among all bees the queen is the sole producer of eggs, and she may go on producing eggs for five years at the rate of 150 eggs a day. The worker bee has a short life when it is working in summer. It lives and works only for about six weeks then, though out of season the worker bee lives for six months. The wonderful fertility of the queen therefore results in a continuous supply of young workers ready to supply the place of dead insects. A "bar frame," stocked with a queen and thirty or forty thousand workers, may be bought for 30s. in England, and a queen for about 5s. The straw-hives of the Khasia hills are an approach to domestication, and they are bought and sold like European hives. In the European and American box hive, there is an artificial wax foundation

moulded in hexagonal cells which the bees make use of in forming their comb. When the combs are withdrawn from under the artificial foundations, they can be restored to their original places after the honey has been extracted with a centrifugal machine. The bees readily make use of their old comb and not needing to elaborate wax, they are able to accumulate double the quantity of honey. The wax foundations cost 3s. a lb., and a lb. of pure bees-wax is sufficient for making 75 foundations for 75 pound combs, or a smaller number of large combs.

The whole operation of managing an artificial hive is one of practice and confidence. Nervous people seldom succeed even with gloves and veil and smoking tin; but a person with good nerves and practice does not require to use any of these protections. The boxes should be kept under the shade of trees, with the passage for bees to the south, and the means for opening the combs in the opposite direction, where through a glass the operator can watch the bees and the combs. He gently opens out the frame, takes out the combs, and replaces them after extracting the honey, where the honey is not required in combs, or where the comb is required for wax, they are removed one by one for good, leaving the top parts, *i.e.*, the foundations, only for the bees to hang on. When it is remembered that the bees use up 20lbs. of honey to make 1lb. of wax, it may be readily seen, it always pays returning the combs to the hive. A hive may yield as little as 50lbs. per season or as much as 250lbs. America is the country where an average of 250 lbs. per hive has been obtained in the season. and as much as 12lbs. of honey are accumulated per day in a hive. The best English average is 120lbs. per season. The art of rearing queens and of managing hives must be learnt by practice.

## CHAPTER LXXXII.

### PROPAGATION OF TREES.

[Utility of growing trees; Trees helpful to agriculture and the agricultural population; Slow-growing Timber Trees; Trees yielding Tans, Dyes and Drugs; Trees yielding Soap; Propagation of trees suited for capitalists; The best trees to grow; How to utilize Fruits if they cannot be sold fresh; Some notable examples of profitable Fruit-culture; Gabions and their substitutes; Why some crops do not grow under shade of trees; Propagation of Seedlings, Transplantation, Grafting, layering, budding, inarching; Cuttings; Gul-kalam; Grafting Wax; Pruning; Root-pruning; Cultivation of land under trees; Watering of trees; Hybridization and Cross-fertilization.]

*Utility of growing trees.*—The propagation of trees which yield starch, oil, sugar, vegetables and fibres, is of vast importance to a country where failure of ordinary agricultural crops through drought or inundation is of frequent occurrence. Apart from their uses for food, fodder, and timber, trees are highly beneficial as breakwinds in localities where high winds are an objection. They exercise a beneficial effect on the climate and temperature, when

there are not too many of them. A moderate sized tree transpires as much as forty gallons of water per day, which goes to reduce the temperature of the atmosphere, while radiation is hindered at night by trees. Thus trees exercise the influence of equalising temperature. Trees bringing up food materials from the depth of soils and storing them in leaves which are afterwards shed, are a most valuable fertilizing agency for surface soils. Beneath the shade of trees a rich layer of humus is formed which keeps the roots cool in summer and warm in winter, besides absorbing and retaining a great quantity of water. It is in this way that trees grow luxuriantly even on the poorest soils and change the character of the soil permanently for the better. Trees also have a binding effect on the land, which without them would be liable to be washed away or denuded by rain. Trees are believed to induce a heavier rainfall. In the delta of the Nile there used to be on the average only six rainy days in the year; but since the planting of millions of eucalyptus trees there, during the last fifty years, there are now on the average forty rainy days per annum. In Algiers, Napoleon III caused millions of trees to be planted, which has doubled the number of rainy days in that country. There is an arid belt running through Australia, Africa, etc., but wherever forests cross that belt as in New South Wales and W. Australia, there is a fair rainfall. The eastern side of the Himalayas which is heavily timbered, has a large number of big rivers and it maintains an immense population. The destruction of forests in Western India where hundreds of mills have been using up wood-fuel, may have a deteriorating influence over the distribution of rainfall in those parts. The propagation of trees also results in a perennial supply of fuel and fodder of the highest value, and when a tree is cut down its place ought to be supplied by fresh planting as is done in Germany. Trees act as a barrier against epidemics, and such aromatic trees as the eucalyptus and the coniferæ are considered especially valuable for this purpose. The *casuarina* tree yielding a good fuel is a very fast-growing tree, and its propagation is recommended on poor soils. The propagation of the *babul* for fodder and timber required for agricultural purposes, is also highly recommended. Slow-growing but valuable timber-trees, such as mahogany, *tun*, *asl*, teak, *sissoo*, should not be grown in agricultural tracts, but in poor and arid tracts which are considered unsuitable for ordinary agricultural pursuits. Trees or shrubs producing tans and dyes, such as myrabolan, divi-divi (*Cæsalpina coriarea*), *Cæsalpina digyna*, *asan*, *arjun*, *cheli*, *kamela* (*Mallotus Philippinensis*), *lodh*, *annatto*, and other trees with special economic value should be grown only in special localities which are also not quite suitable for agricultural purposes, e.g., in various parts of the Chhota Nagpur Division. Trees or shrubs of *Jaypal* (*Croton Tiglium*), which yield a nut from the seed, of which the most valuable purgative medicine is obtained; trees of *kusum* (*Schleichera trijuga*), which yield lac, and from the seed of which oil which is the basis of Macassar oil

is obtained, are also very valuable trees to grow. The *ritha* or soap-nut tree (*Sapindus Mukorossi*) should be grown more largely and the soap-bark tree (*Quilloja Saponaria*) should be introduced from Chili more largely, as it has been introduced with success in Ootacamund and it is likely to do well in elevations ranging from 3,000 to 4,000 ft. For agricultural tracts, the trees that should be grown should yield fodder and food, or they should be so fast-growing that they may yield fuel in abundance and without much waiting, relieving cattle-dung for manurial purposes. Lastly, with regard to trees, it should be mentioned that they cost scarcely anything keeping up after they are once grown up, and a plantation of mangoes, cocoanut, guava, lime-trees, plantains, bamboos, date, jack, papaya and other fruit trees, though expensive and troublesome to set up, is a most valuable property for a capitalist who can afford to wait for the return. Indeed, for a capitalist it is a much safer investment taking up poor land for such a plantation than going in for ordinary agricultural pursuits.

*Best trees to grow.*—The trees which are best to grow as food-yielders are :—(1) Mangoc. Stone-kernels of the mango fruit yield a starch which is used for making bread, *i.e.*, after the kernels have been pounded and washed with hot water. (2) Jack. (3) Breadfruit tree. (4) Cashew-nuts. (5) *Bael*. (6) *Babul*. (7) *Jhand* or *Shami* (*Prosopis spicigera*), which is a moderate sized, deciduous, thorny tree, found in the arid dry zones of the Punjab, Sind, Rajputana, Gujarat, Bundelkhand and the Deccan. This tree is as valuable as carob-beans in times of scarcity. The pods, which ripen before and during the rains, contain a considerable quantity of a sweetish farinaceous substance. The pods are eaten green or dry and raw, by themselves, or boiled with salt, onions and ghee, with bread or mixed with *dahi*. The bark ground into flour and made into cakes is also edible. This tree was the means of saving thousands of lives during the Rajputana famine of 1868-69. As a food and fodder-yielding tree, there are not many that can be compared to this one. (8) *Sajna* and *naina* (which is a variety of *Sajna* which yields two crops of legumes in the year) may be also mentioned as a food-yielding tree. (9) The mulberry. (10) The bamboo. (11) The mahua. (12) The palms (toddy palm, areca-nut palm, cocoanut palm and the date palm). (13) The locust or carob-bean tree of the Mediterranean region has been successfully introduced into Gwalior, and there is no reason why this valuable fodder tree should not flourish elsewhere. (14) Plantains and dates being grown as crops in some parts of Bengal have been separately dealt with. *Kusum* (*Schleichera trinuga*) has been already mentioned. Its timber is used for making oil mills (*Kalus* or *Ghanis*).

*Preservation of fruits.*—Fruits can be variously utilized if they cannot be sold fresh. The strained juice of mangoes and jack fruits is spread out thin in the sun and preserved in the form of thin cakes. A method of preserving the juice of fresh fruit

without converting it into wine, has been described in the chapter on pineapples. Lime-juice may be bottled up fresh with the addition of powdered charcoal for an indefinite period. Rapid desiccation of fruits and vegetables by the action of a current of hot air is now largely resorted to in many countries. Fruits are also preserved by converting them into jams and jellies. Jams are made by boiling fresh and whole fruits in syrup. The sugar and water are first boiled into syrup and the fruits put in afterwards and boiled. The preparation of jelly from the pulp or the juice of fruits by the addition of sugar, has been described in the chapter on plantains. For transporting fresh fruits to great distances, various devices have been made use of with more or less success. In the Municipal Market in Calcutta the fruits that come packed up with small particles of cork come best. The broken end of the fruit may be also sealed with sealing wax and each fruit packed up separately in tissue paper and despatched. Some fruits and some varieties of certain fruits keep longer than others. Of superior Bengal mangoes the *Khatmabl Khoer* of Dumraon perhaps keeps the longest and is safer to export to Europe than any other superior mango.

*Profits of fruit culture.*—Lord Sudeley's fruit plantation in England (in connection with which Beech's Jam Factory is worked), is an example of the success which a capitalist can attain by fruit farming. No calculation can be given of initial outlay, annual expenditure and outturn, which will apply to fruit trees generally, as some trees such as plantains, palms, etc., may be planted six or seven cubits apart, while others such as mangoes or jack should be planted 25 or 30 ft. apart. But the above estimate of income of Rs. 25 per acre from a mixed orchard may be taken as a reasonable approximation. Under exceptionally favourable circumstances, however, a net profit of over Rs. 2,000 per acre may be obtained from suitable fruit trees. There is one mangoe tree in Malda, for instance, which is leased out annually for Rs. 30, paid in advance, whatever be the number of fruits finally obtained from this tree. Seventy trees grown on one acre might thus give a net income of Rs. 2,000 per annum. But one must not base his calculations on very extraordinary and exceptional circumstances, but on the average experience of the country.

*Gabions.*—For the first three or four years trees must be protected with gabions. There are various devices used for saving the expense under this item. A circle of useful thorny plants, such as agaves, is often planted round a tree. At other times a coil of rough and spiny grass (e.g. *Saccharam spontaneum* or *Kans grass*) is put round the trunk of a tree, which is made further repulsive with cow-dung paste, or castor-oil.

*Crops that grow under shade of trees.*—A question of some theoretical importance with regard to the utilization of the land underneath trees, in connection with the difficulty in growing crops under trees, is, whether the roots of trees suck up too much

moisture and leave the land underneath too dry. This belief is probably incorrect, as there is difficulty in growing only certain crops but not others. Rhea, pineapple, sida, ground-nut, coffee, sabai grass, sansiviera, carrots, *piper longum* and other piperaceæ plants, turmeric, ginger and arrowroot, can be grown well under the shade of trees even without irrigation.

*Seedlings*.—Experience is necessary for growing trees successfully from seed, as some seeds must be buried in one to three inches of soil, others scattered superficially on cultivated soil, others treated with camphor water before sowing, and others half buried in soil. The sowing should be in lines, that seedlings may be kept hoed. Transplanting should be done after one or two years or earlier. Seeds produce stronger plants than grafts, etc.

*Grafting*.—The *object* of grafting, budding, etc., is to propagate any given variety of fruit *true to kind*, or to convert unsuitable or unprofitable varieties into suitable or profitable ones. Grafting differs from budding, in that, in the latter operation, a bud only is taken, whereas in grafting a portion of the previous season's wood that is well ripened, and containing from one to four or more buds, is used. Budding can be successfully carried out only when the stock is in a state of active growth; but grafting, other than bark or rind grafting is most successfully carried out in spring, just previous to the commencement of active growth.

Grafting is applicable to fruit trees of all kinds and sizes, from nursery stock to large trees, different methods being used for different kinds and different sizes of trees.

*Grafting tools*.—The following tools should be obtained for grafting:—

1st, a strong pruning knife, having either a straight or curved blade, Saynor's knives being preferred to all others by professional gardeners.

2nd, a knife having a thin straight blade with which to prepare the scions; the knife used for budding will answer for this purpose also, if sufficiently strong.

3rd, a good pruning saw, such as the "California" or a common hand-saw, if the trees to be grafted are of a large size.

4th, a strong chisel and wooden mallet for preparing large stock.

5th, a grafting pot in which to prepare the grafting wax. An ordinary glue pot will answer.

6th, bees wax, tallow, resin and turpentine.

7th, thin calico, cotton wick, plantain fibre and moss.

All appliances should be kept clean and sharp, as the cleaner the cut the more complete is the union. Lard or vaseline should be used to keep instruments from rusting.

*Grafting wax*, which is used for all grafts above ground, is made in several ways. For root-grafting and saddle-grafting, where the earth is brought round the union (Fig. 95 B), no wax is used. In root-grafting even tying is not necessary; but in saddle-



grafting, the stock and the scion must be tied together firmly before the earth is brought round the union. One recipe consists of melting together, over a slow fire, equal parts of bee's wax, resin and tallow till dissolved and thoroughly mixed, when it is ready to apply. Another good recipe is the following:—

|            |    |    |    |                   |
|------------|----|----|----|-------------------|
| Bee's wax  | .  | .  | .. | 1 lb.             |
| Tallow     | .. | .. | .. | $\frac{1}{2}$ lb. |
| Resin      | .. | .. | .. | 1 lb.             |
| Turpentine | .. | .. | .. | 2 oz.             |

Melt the resin and tallow over a slow fire; then add the wax and when melted, mix well together. Then add the turpentine and stir well, when it is ready for use.

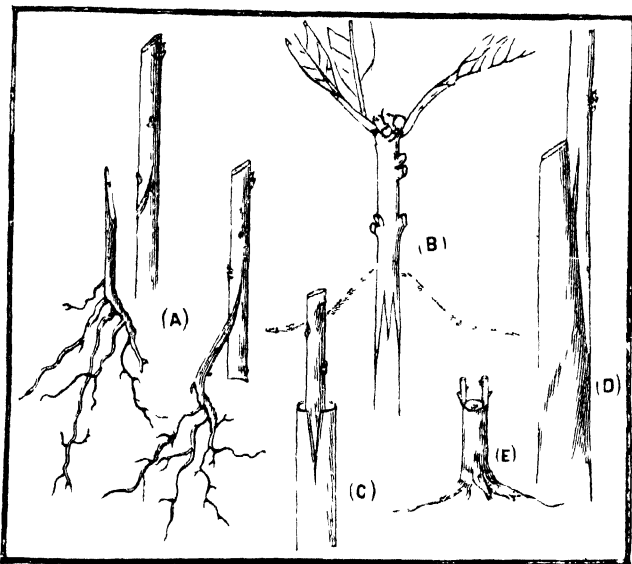

FIG. 95.—GRAFTING.

- A.—Root grafting.                      C.—Cleft or Wedge-grafting.  
 B.—Saddle-grafting                    D.—Whip or Splice-grafting.  
 E.—Crown or Rind-grafting.

Grafting wax is applied hot with a brush to the graft when tied in position, care being taken to cover the wound completely so as to exclude air. A simple and convenient way of using the wax in the case of nursery stocks, is to dip a sheet of thin calico into the boiling wax and when sufficiently cold, tearing the waxed calico into narrow strips of suitable length. The graft being placed in position the waxed tie is wound round it so as to completely cover the union; the heat of the hand being sufficient to soften the wax, so that it sticks well and is air-tight.

The *principle* underlying every method of grafting is to so unite the scion or graft with the stock as to bring the cambium

layer or wood-producing layer of each, together. When the two layers are brought together and kept together without air, they each throw out new cells which join together and form one layer of wood.

There are various modes of grafting, known variously as Bark-grafting, Cleft or Wedge-grafting (Fig. 95 C), Crown or Rind-grafting (Fig. 95 E), Saddle-grafting (Fig. 95 B), Whip, Splice, or Tongue-grafting (Fig. 95 D), the principle underlying being the same in all cases. Root-grafting (Fig. 95 A) is also practised by gardeners. A small piece of root is either grafted on to a scion of the desired variety, or the scion is grafted on the root-stock just below the ground where the stock is.

*Bark-grafting.*—The bark taken from the scion may have one or several buds on it. When one bud only is used, the operation is called *budding*; when several buds are used the operation is called *bark-grafting*, or *multiple budding*. Either old or new bark answers, but old bark does better. The length of bark taken should be twice that of the breadth (circumference in the case of bark-grafting). There should be no wood adhering to the bark.

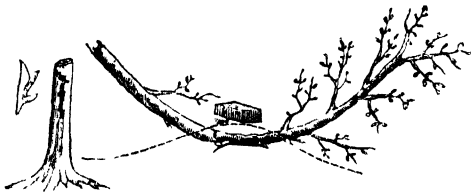

FIG. 96.—BUDDING.

FIG. 97.—LAYERING.

Having secured the bark from the scion tree, cut out a corresponding portion of bark from a branch of the same thickness on the stock and make the scion bark take the position of the bark thus cut out, then bind it with cotton, but not tightly. No clay or grafting wax need be used. Six or eight inches above this graft the stem should be ring-barked, but leaves above the ring-bark left for shade for two or three weeks, after which the branches above the ring-barking should be cut or sawn off, and all shoots appearing except those on the bark grafted on, should be rubbed out, that all the ascending sap may go to the nourishment of the buds on the bark.

*Budding* proper is a simple but delicate operation. It consists in removing a bud (Fig. 96) from one plant and making it grow on another which must be of the same family and closely related, although it may yield fruit of flowers of an inferior character. It is possible to bud an orange on a lime tree and a peach on an English plum tree, but not a rose on an orange. But very curious combinations are being now achieved by budding. A single bud is carefully removed from the tree to be propagated by inserting the budding knife about half-an-inch above the bud, and cutting slightly inwards and downwards, bringing the knife out about half-an-inch below the bud. If there is a leaf under the bud it is first to be cut off carefully. The little bit of wood that will come

along with the bud and the bark will be found in the middle of the scion immediately behind the bud. This bit of wood is carefully removed with the knife without cutting into the bud from behind. A T-shaped cut is then to be made into the stock not deeper than the bark, that is only the bark is to be slit open, and the scion introduced carefully into the longitudinal portion of the slit, the operation being helped with the insertion of the thin ivory handle of the budding knife between the bark and the cambium of the stock on both sides of the slit. When the scion has got right in, only the bud peeping out of the slit, the cut edges are to be closed over and tied with plantain tree fibre. From the beginning of the monsoon to November and December, is the proper season for budding.

*Layering.*—This is another method (Fig. 97) of propagation. If the branches to be layered can be brought down to the ground, a slit should be cut at the firmest part that can be made to touch the ground by inserting the knife at the lower side near to and beyond a bud and cutting nearly to the centre of the branch, drawing the knife towards the end of the branch about an inch or more. A small stone should be placed in the slit and the cut portion covered with sand or powdered brick. A good sized stone should then be put on the bend, so as to keep the layer steady, and water supplied as the soil gets dry. When a branch cannot be brought down to the ground, arrangement may be made for taking pots of soil to the branch and keeping the layers moist high up.

*Inarching*, or grafting by approach, is the commonest method practised in this country. It consists in bringing a second year's seedling, or a plant from cutting obtained from an easily propagated and wild or inferior plant, in a pot, properly rooted, to the tree from which the scion is to be obtained, and placing it in such a position (on a platform, or within the embrace of a bamboo split at the top, for instance), that the portion of the tree of the superior kind which it is desired to propagate, can be brought into direct contact with it. A thin slice is then taken off one side of the seedling or wild stock, about two or three inches in length, and a corresponding slice is taken off the branch of the tree that is to be used as scion, the two branches being of the same diameter. The cut surfaces being placed together, it is seen that the inner barks on both sides of the cuts join, the two being firmly tied with soft cloth. The graft is not waxed but is kept moist by water constantly dropping on to it. When union has taken place (which it does completely after several months) the scion is severed very carefully from the parent tree and the young plant is ready for removing. It is not easy to obtain successful grafts by this method.

*Propagation from cuttings* is possible in the case of some plants and trees. Well ripened branches taken from near the ground, at a joint, *i.e.*, where one branch joins another, make the best cuttings. There should be about three joints in length cut close beneath a bud

and inserted about one-third of their length in fine sandy soil or brick-dust. In the dry season, in Lower Bengal, when it is inconvenient to keep the soil watered, and when the cuttings are known to send out shoots freely, *e.g.*, in the case of sugar-cane, rhea and cassava, planting may be done horizontally three or four inches under the surface of the soil. Cuttings should be planted as fresh as possible, though some cuttings (*e.g.*, those of mulberry, cassava and sugar-cane) are known to retain their vitality for more than a month kept in a damp and shady place. Where there is uncertainty, the additional precaution of dipping the fresh cuttings in camphor water immediately before planting, should be taken.

*Ring-bark cutting.*—This is another method which is commonly employed in this country for propagating orange trees, india-rubber trees (*Ficus Elastica*), etc. Hundreds of *gootes* or *gul-kalams* may be formed on one tree without doing the tree much harm. At the commencement of the rainy season, healthy and mature stems are chosen, and a ring of bark, one to three inches in length according to the thickness of the stem chosen, cut out. The bark should be cut out immediately below a leaf-bud. A ball of clay made sufficiently plastic by working it well between the palms, is then put round the ring-barked portion, so as to completely cover it over. This ball of earth is then secured by an envelope of coir, or a piece of sacking, and the whole tied up with a piece of string. Fish manure (*i.e.*, rotten fish mixed up with earth) is largely used in place of the ball of clay. The roots will be found protruding from the ball of earth and its enveloping materials, and then the new plant may be regarded as being ready for severing and for planting out in the field. Small fruit trees must be protected by gabions, and watering must be resorted to if the rainy season does not persist. In the Darjeeling hills and in Assam, where the *gootee* or *gul-kalam* system is largely employed in propagating the orange and the india-rubber tree, the rainfall is so copious that artificial watering, while the *gootes* or *gul-kalams* are on the trees and after they are planted out, is scarcely ever found necessary.

*Pruning.*—Experience alone can decide for each class of fruit trees, whether annual pruning of branches, or pruning every alternate year, or root-pruning, best answers for encouraging the growth of fruits. In the case of mangoes, root-pruning has been found more useful than branch pruning, while in the case of *lichies* branch-pruning answers better. In the case of mulberry trees grown for leaves for silkworms, pruning of branches every alternate year has been found the most economical way of dealing with them. Root-pruning, as well as manuring and watering of trees should be done, not at the immediate base of the trees, but at the limit of the shade caused by the branches and leaves. A circular trench about two feet wide should be dug out at the proper distance from the trunk, if root-pruning and manuring are to be done. Bones or bone-meal put into this trench make a good and

lasting manure for fruit trees. All trees are benefited by the cultivation of land underneath them, and the growing of crops with manure if possible. The cultivation of land in October and November breaks the capillary action of the soil and the consequent loss of moisture from this cause. In certain dry localities trees have to be watered in the dry season to keep them in condition. But if cultivation of land underneath is resorted to, this will be found unnecessary for at least large trees. The ploughed up soil acts as a mulch to the soil underneath, helping it to retain moisture.

### CHAPTER LXXXIII.

#### AGRICULTURAL CALENDAR FOR LOWER BENGAL.

*January.*—Sugar-cane harvesting and *gur*-making. Sowing of *kulibegun* and *deshi* onion seeds. Planting of *ól* for the August to September crop. Final irrigation of potatoes, cabbages and other English vegetables. Picking of cotton bolls. Pitting of sugar-cane cuttings, or 'topping' of seed-canes. Harvesting peas and *Kalâi*. Preparation of land for sugar-cane and cucurbitaceous crops. Transplanting of *deshi* onion. Sale of English vegetables. Threshing of paddy. Arrowroot and cassava harvesting.

*February.*—Harvesting linseed, mustard, *mung* and *til*. Sugar-cane harvest and *gur*-making. Planting of sugar-cane and sowing of cucurbitaceous crop seeds (*ucche*, *jhingâ*, water-melon, mash-melon, gourd, pumpkin, etc.). Transplanting of *kulibegun*. Preparation of land for *kharif* crops. Sale of English vegetables. Picking of cotton.

*March.*—Harvesting of barley, oats, wheat, gram, *musur*, *khesari* and of other pulses. Planting and irrigating sugar-cane. Watering and manuring (chiefly sprinkling ashes on) cucurbitaceous vines. Picking of cotton. Sowing cotton seed and maize if there is a heavy shower of rain. Preparation of land for *kharif* crops.

*April.*—Watering of sugar-cane and cucurbitaceous vines. Planting of yams and *ól* for the December crop. Sowing of maize, *juar*, *Reana*, jute, and *mestâ pit* seeds, after a good shower of rain. Manuring of mulberry, plantain, bamboo and other perennial plants with tank or canal silt. Manuring *Aus* fields with cattle-dung, village sweepings, tank-silt, weeds or compost. Sale of cucurbitaceous vegetables. Preparation of land for brinjal and sowing of seed.

*May.*—Sowing of *Aus* paddy, maize, *juar*, *dhaincha*, *araha*, *Reana*, jute. Sale of cucurbitaceous vegetables. Transplanting of brinjal and cotton plants, if heavy showers of rain obtained. Earthing of maize, *juar*, and *Reana* if sowing done in March or April, or sowing of seed of these, if heavy showers not obtained in

March or April. Final preparations for *khari* crops generally. Sowing of cucumber, gourd and pumpkin seeds. Final manuring, earthing and irrigation of sugar-cane. Sowing of chillie seed in seed-bed (this may be done in June also). Sowing of *Aman* paddy in seed-bed.

*June*.—Sowing of *Aman* paddy. Sowing of seeds of trees. Transplanting of brinjals and cotton, if not done before. Planting of plantain and other trees in *Aus* paddy fields. Weeding of *Aus* paddy, *araha*r, jute and *mestá pát*. Sale of green cobs of maize. Earthing of brinjals and cotton, if sufficiently forward. Sowing of edible hibiscus, *araha*r, turmeric, ginger, *kachu*, yams, sweet potatoes, *sankalu*, *ságs* (amaranths, etc.) and ground-nut, may take place in May or in June. Gourds, pumpkins, *jhingá* and cucumber seeds may be sown in this month also. *Bhadái kalái*, *bhringi*, *kurthi*, *arhariá sim*, *popat* beans and country beans may be also sown this month. Guinea grass may be planted or the plantation extended. Transplanting of *aman* if possible.

*July*.—Transplanting of *aman* paddy. Transplanting of chillies (may be done in August and September also). Planting of trees, especially cocoanut and bamboos. Weeding of cotton, earthing of brinjals, turmeric, ginger, etc. Sale of green cobs of maize. Weeding of jute, *araha*r, etc. Tying of sugar-cane. Letting out of water from *araha*r, cotton, sugar-cane, *juar*, *Reana* jute, *khari* pulses, *ól*, yams, etc., and keeping water in *aman* paddy fields.

*August*.—Transplanting of *aman* during the first half of the month. Harvesting of *Aus* paddy, leguminous and other fodder crops generally. Sale of brinjals, *shim*, *ságs* and country vegetables. Earthing of chillies, cutting of *dhaincha*. jute, *mestá pát*. Washing of the fibres of the two latter may also commence this month. Sowing of seed of English vegetables in verandahs.

*September*.—Preparation of land for *rabi* crops under exceptional circumstances. Harvesting of maize, *Aus* paddy, and *Bhadái* pulses. Tying of sugar-cane. Country beans and peas, *Pálam ság*, *Chuká pálam*. *Kanak note ság*, radishes, pumpkin, gourd, and early cauliflower (from Patna seed), also mustard, turnip and *til* may be sown, cauliflower alone being sown in seed-bed under cover, the rest in well drained fields. *Palval* and sweet potato cuttings may be also sown. Land to be got ready for the regular English vegetables and seed-beds prepared. Transplanting of trees and seedlings (*Papaya*, plantains, etc.). Sale of jute and vegetables.

*October*.—Sowing of English vegetables generally, cabbages, cauliflower, knol-khol, artichoke (on sandy loam) Brussels sprouts, turnips, celery, lettuce, tomatoes, radishes, carrots, cnicns, French beans, peas, potatoes, sweet potatoes (*Batata edulis*) and *palvals*, to be sown. Last month's sowings to be protected from water-logging. Early cauliflower to be transplanted and protected from the sun. Brinjal and cotton fields to be dug, also sugar-cane

fields. Bulbils of agaves to be sown. Bases of plantain and other trees to be loosened and raised, and a basin for holding water made round newly transplanted trees. Preparation of land for *Rabi* sowings generally to go on vigorously during this month, as in most places in Lower Bengal preparation in September is not feasible, the rains usually continuing to the end of this month or even to the middle of October. Sowing of gram, linseed, *til*, *khesari*, *musuri*, and *mung* to be got through before the end of this month, if possible. Picking of cotton bolls may commence. Of all ordinary agricultural *rabi* crops, mustard and *kalai* should be sown first.

*November.*—Bases of trees, cotton and brinjal plants, may be loosened and cleaned during this month also. Barley, oats and pulses to be sown, and then wheat. Sowing of English vegetables and potatoes may continue. Radishes, cotton, melons, gourd cucumber and other cucurbitaceous crops, coriander, onion and pulses, including *Vigna catrang*, may be sown during this month. Hoeing of early sown plots and irrigation of potatoes, cabbages and cauliflowers may be necessary. Winter paddy may be harvested, if early. Cotton bolls and chillies to be picked. Hoeing of sugar-cane and irrigation if necessary. Harvesting of *kachu* and sweet potatoes.

*December.*—*Aman* harvest. Sale of early English vegetables. Irrigation of potatoes, cabbages, etc. Hoeing round trees and other perennial plants. Picking of cotton, and chillies. Harvesting of yams, ginger, turmeric, ground-nut, radishes and *ôl*, also sowing of *ôl* for the August-September crop. Cutting of sugar-cane may commence, if early. *Kalai* and mustard may be harvested this month. *Champa note sag* may be sown this month or in January, if irrigation available. Sale of *palval* may commence, while sale of brinjals continues.

NOTE.—The operations for *kharif* crops generally take place a month earlier in Eastern Bengal districts, and a month later in Bihar and Chhota Nagpur. In the hill districts the time for different operations varies with the elevation, and in high elevation only *rabi* crops can be grown in the *kharif* season, the sowing time being February and March and the harvesting time, August to October. In the lower hills and valleys, the Eastern Bengal system is applicable. In the Bihar, Chhota Nagpur, and Sonthal Pergana districts, the *rabi* operations take place a month earlier and in the Eastern Bengal districts a month later.

## PART IV

# MANURES.

## CHAPTER LXXXIV.

### GENERAL SUMMARY.

Purpose of manuring, Law of minimum; Physical character of soil as important as chemical; Value of leguminous crops, Effect of phosphatic, nitrogenous potash and calcareous manures; Indirect manuring, Economic use of manure; Covered pits, Use of urine.

In all attempts to apply manure for agricultural purposes it must be recognised that there are three purposes to be served. The manure may on the one hand be expected to improve the physical condition of the soil, so as to make it a more suitable and comfortable medium for the plant which it is desired to grow. In the second place, the manure applied may be expected to provide such plant-food as the plant needs, whether nitrogen, phosphoric acid, potash, lime, or other constituents of the plant substance—in an available form, and thirdly, it may make the soil a more suitable medium for the organisms which make the soil their home, and which bring the plant-food into such a form that it can be readily absorbed by the crop. In the present treatment we shall consider chiefly the manure as a source of plant food, and refer incidentally to the other purposes which it must serve. The fact that a manure ought also to serve these purposes should, however, never be forgotten in any decision as to the manure to be applied to any soil or to any crop.

Considered as a means of applying plant food, manuring is governed by what is called the 'Law of the Minimum.' Nitrogen alone will produce no crop, if phosphoric acid, potash, lime, etc., are absent. Similarly, phosphoric acid and potash alone without nitrogen, etc., will produce no crop. If by adding 8 lbs. of nitrogen, 10 lbs. of potash and 5 lbs. of phosphoric acid, one gets 14 maunds of oats, by adding 8 lbs. of nitrogen and only 5 lbs. of potash and  $2\frac{1}{2}$  lbs. of phosphoric acid, one might obtain only 7 maunds. The Law of the Minimum holds good even for moisture, light and heat: a minimum proportion of moisture, light and heat are needed for the growth of every crop. This minimum requirement of food and other conditions of growth is different for different crops; but



crops have not been so minutely studied yet as to enable one to give a tabular statement of minimum requirements for each variety of every crop. Chemical analyses may prove certain amounts of plant-food present, even in an available form, which are theoretically sufficient for obtaining the maximum yield. But even in such cases, manuring has given good results. Chemical analysis also does not take into consideration the potentiality of a soil for accumulating nitrogen, due to the growth of microbes under proper conditions of moisture, porosity, heat and presence of lime. As much as 100 lbs. of nitrogen per acre may be accumulated from the air, in this way, during the year and particularly during the preparation of soil and growth of the crop. The growing of leguminous crops in rotation is another inexpensive way in which land is enriched. Dr. H. H. Mann, the Indian tea expert, has popularized the growing of *Dhaincha* and other leguminous crops in tea gardens, with excellent results, and the same method of enriching soils is recommended to ordinary cultivators.

Notwithstanding the device of growing leguminous crops every now and again, continuous cropping without manure does result in the gradual deterioration of the soil. The cultivators of Bali and Uttarpara have noticed, for instance, that of late years, they are unable to grow pulse crops, and their mango and cocoanut trees have ceased bearing fruits. This may possibly be due to the minimum requirements of these crops for phosphates and lime being now wanting, owing not only to continuous cropping, but also to the systematic sale of bones to the local bone-mills without a particle of bones being used here for manure. In some countries every crop is grown by the application of a manure. In these, the yield of crops instead of diminishing, in course of time gradually increases. The application of *special* manures, time after time, though resulting in immediate beneficial effects, tends to impoverish the land in course of time. *General* manures, being less soluble and supplying *all* the requisite nourishment, are, therefore often, though not always, preferable.

Manures are divided into several classes :--

(1) *Phosphatic manures*, e.g., bone-meal, bone-ashes, dissolved bones, superphosphate of lime, apatite, etc. This class of manures possesses the following special properties ;—

- (a) They tend to make the fruits and roots sweeter.
- (b) They tend to increase the flowering and fruiting tendencies of plants, and also increase the absolute yield of seed and roots.
- (c) They make ripening of crops to take place earlier.
- (d) Young plants can resist the attack of insect and fungus pests better, *i.e.*, they have more vitality in them if they are grown on soil manured with phosphates.

Bone-dust can be had now of many Indian merchants in Calcutta and Bombay. Oil-cakes and ashes also contain large proportions of phosphates. Cowdung and horsedung ashes are specially rich in phosphates. The indirect method of manuring

by feeding cattle liberally with oil-cake and utilizing their excrements as manure is better, in many cases, than applying oil-cake direct as manure to the land. Once in five or six years every plot of land might well be left fallow, and on it cattle should be tethered or huddled in and given oil-cake to eat, so that their excrements, solid and liquid, may enrich the soil. Liquid manure is better than solid manure.

(2) *Nitrogenous manures*.—The principal nitrogenous manures are saltpetre, sulphate of ammonia, sodium nitrate, blood, flesh, hair, horns, hoofs and soot. The special value of this class of manures consists in their capacity for increasing the vegetative or leaf producing power of plants. Those crops that are valued for leaves only, such as cabbages, potherbs, mulberry, tobacco, *pan*, tea, are specially benefited by nitrogenous manures. For all other crops, except leguminous crops, the application of nitrogenous manures at an early period of growth after germination gives a good start. Saltpetre is specially beneficial for cereal crops. Application at the rate of one to two maunds per acre has been found to double the yield. Saltpetre should be used on fertile soils only or used in conjunction with a phosphatic manure, as it makes the constituents of soil soluble and liable to be washed away. The best result is obtained by the application of bonedust with saltpetre. Oil-cakes are general manures rich in phosphorus, nitrogen, potash, and lime. Bones containing about 23% of phosphoric acid and 3.5% of nitrogen may be regarded either as a general manure or a phosphatic manure. Being a general manure, it has no tendency to impoverish the soil by continuous use. Superphosphate of lime contains 20 or 30% or more of phosphoric acid but hardly any nitrogen. Oil-cakes contain 5 to 6% of nitrogen and 2 or 3% phosphoric acid. Urine contains a larger portion of nitrogen than dung. Solid manure also, *e.g.*, dung, contains more nitrogen than phosphoric acid, and may therefore be regarded as a nitrogenous manure, while it is also a general manure. A ton or about 27½ maunds of cowdung contains about 5 to 7 seers of nitrogen, 2 to 4 seers of phosphoric acid and 5 seers of potash. Sulphate of ammonia and nitrate of soda are quickly acting nitrogenous manures, but they leave the land comparatively poor after a crop has been raised by the application of one of them. Blood, flesh, bones, oil-cakes, solid or liquid excrements of animals, aquatic weeds and black earth dug out of old tanks, in renovating them, are the commonest general manures. Though not quick acting manures and though they may be all called nitrogenous manures, they do more permanent good to the soil, as they contain all the ingredients the plant requires and as they have no special power of dissolving the soil and rendering its constituents too readily available as plant-food. Where leaf production is sought, the application of saltpetre should be resorted to without any hesitation. It should be noted, however, that saltpetre and even oil-cakes should never be applied at the time of germination or brought

in contact with roots. They are to be mixed up with soil, or sprinkled diluted with water, ashes or earth, or applied to the soil in between rows of plants that are afterwards irrigated.

(3) *Potash manures*.—

(a) Ashes of all kinds, especially ashes derived from soft parts of plants and from seeds, as for instance, cowdung ashes.

(b) Animal excreta, vegetable moulds, rotten leaves, tank earth, indigo refuse, etc.

This class of manures is also helpful to certain vegetative functions, *i.e.*, to the production of leaves, elaboration of acid juices of fruits, deposition of starch, formation of roots and also to flowering and fruiting. A maund of cowdung containing about  $\frac{1}{6}$  seer of potash,  $\frac{1}{6}$  seer of nitrogen,  $\frac{1}{8}$  seer of phosphoric acid, if 20 maunds of cowdung are applied per *bigha*, the soil receives an addition of about 3 to 4 seers of nitrogen, 3 to 4 seers of potash and  $2\frac{1}{2}$  seers of phosphoric acid. A maund of oil-cake contains about 2 seers of nitrogen, 1 seer of phosphoric acid, and a little over  $\frac{1}{2}$  seer of potash, in other words, oil-cakes are 12 times richer than cowdung in nitrogen, 8 times in phosphorus, and 3 times richer than cowdung as a potassic manure. As potash is more or less abundantly present in every soil, the application of 1 maund of oil-cake is equivalent to that of 8 to 12 maunds of cowdung; in other words 2 to 3 maunds per *bigha* is an adequate application of oil-cake for all ordinary crops (*i.e.*, rice, jute, etc.). Crops valued for their leaves or for pods are more benefited by the application of ashes than oil-cakes. Crops valued for their pods, though benefited by potassic manures, may be actually damaged by nitrogenous manures. Saltpetre, oil-cake, solid and liquid excrements of animals are therefore often unsuitable for leguminous crops. Ashes contain as a rule 5 to 10% of potash.

(4) *Calcareous manures*.—*E.g.*, lime, shells of cockles and snails, *kankar*, gypsum, etc.

This class of manures is best suited for leguminous crops, their chief function being to make the other constituents of soils readily available. Like phosphorus and potash, lime also increases the flowering and fruiting tendencies of plants. Whenever therefore it is noticed that plants or trees are vigorous in producing leaves, but backward or reluctant in putting forth flowers and fruits, the application of lime, ashes, and bones should be at once resorted to.

(5) *Salt*.—This is scarcely of any value as a manure except for certain special crops such as cabbages, mangold, asparagus, coconut, etc. Impure salt and *Khari nimak* are better manures than pure salt, as they contain an admixture of saltpetre and sodium sulphate. Salt strengthens fibres of jute, cotton, etc. It also checks exuberant growth of leaf.

The practical advice of Lawes and Gilbert, the greatest agricultural chemists of England, should be always borne in mind in choosing special manures for special crops:—"Use phosphates

for turneps and such like root-crops, potash for leguminous plants and active nitrogen for grain."

*Indirect manuring.*—Under this head may be included the following:—

(a) Feeding of cattle with oil-cake on fallow land.

(b) Growing of leguminous crops, for pulse, for fibre or for fodder, specially *dhaincha* and *sunh* hemp which are very rich in root-nodules.

(c) Growing crops by irrigation but not too free irrigation.

(d) Cleaning of sewers, tanks, *jhils*, wells every two or three years, cleaning them of all impurities including vegetable and animal remains or growths and applying them as manure to fields.

(e) Gathering of weeds when they are in flower and pitting them as manure.

(f) Growing of trees, generally round a farm, and of large mulberry trees in particular, for sericulture and utilising the silk-worm droppings, etc., as manure.

(g) Burning weeds and jungles and then cultivating the land. This should be done only on rich forest or hill tracts. It results in the acidity of the soil being corrected, insect and other pests destroyed, weeds being easily and effectually removed, ashes from burnt weeds getting mixed up with soil and thus adding to its fertility directly, and indirectly by the manurial constituents of the soil being rendered more soluble as plant-food.

(h) Cultivation of land as long before the sowing season as possible, except in the rainy season, when land should not be left tilled without a crop.

(i) Use of certain insecticidal and fungicidal substances that have a manurial value at sowing or transplanting time. These substances are castor-cake and rape-cake dust, soot, salt, ashes and lime. Spent lime of gas works (sulphide of lime) which can be had as a bye-product from gas works, may be applied to land a month or two before sowing, and the land worked thoroughly in the meantime. It acts as a poison both for weeds and insects, but by aeration it becomes converted into sulphate of lime and acts as a manure to the crop that follows.

(j) Application of manure to a previous crop, say to the *aus* crop, for the benefit of the succeeding sugar-cane or potato crop.

*Economical manner of applying manure.*—In this matter the Chinese are the most proficient. Instead of applying the manure all over the land, they put it at the base of each plant. Applying cowdung, dried human dung, etc., in a very finely powdered condition, one derives more immediate benefit than applying these manures in a more natural condition. In Mauritius this is done for sugar-cane cultivation, a measure of powdered dung being applied over each set of cuttings. For more forcing manures, such as nitre, oil-cakes, blood, etc., manuring at the base of each plant is risky and should not be done.

*Covered pit.*—Every cultivator should have a covered pit for throwing in such refuse matter as sweepings of all kinds, weeds, hair, feathers, useless seeds and stones (like mango or lichi stones), bones, flesh, blood, shells, nails, ashes, besides dung and urine. Over this pit should be sprinkled from time to time gypsum or sulphate of iron or copper. Mixed refuse of all kinds treated with lime or gypsum is called “compost.” The addition of copper sulphate or sulphate of iron is recommended only when there is any sanitary need for it.

*Liquid manure.*—Urine gives better results when it is applied in the fresh state than when it is allowed to ferment. But being too rich it should be diluted with 10 or 20 times as much water, or applied before preparing the land for a crop. If it has to be stored for some time before use, the addition of one part of sulphate of iron to 2,000 parts of urine stored, is recommended, both for sanitary reasons, and for preventing fermentation and the conversion of urea into ammonium carbonate (which is a volatile substance).

## CHAPTER LXXXV.

### EXHAUSTION, RECUPERATION AND ABSORPTION.

[Whether soils getting gradually exhausted, or if there is a permanent minimum fertility; Natural means of recuperation; Amount of exhaustion by ordinary cropping; Recuperation of phosphates and potash; Value of manuring undoubted; Tea planters' experience; Available phosphoric acid and potash; Available lime and magnesia; These as affecting the question of utilization of phosphates; Absorptive power of soil; Chiefly with reference to phosphoric acid and potash; Double silicates, Physical absorption; Absorption without exchange of bases and with exchange of bases].

WHETHER cropping without sufficient manuring has been steadily exhausting Indian soils or not, has been usually answered, until lately, by experts in undoubted affirmative. Professor Wallace of Edinburgh University, however, says: “Temporary fertility, the qualities possessed in virtue of some accumulation of material useful to plant, may be dissipated, but when this is gone, no system of cropping can reduce the land to a lower point. The greater portion of the land in India, which is not newly broken in, annually produces its minimum yield. Where declining fertility has been recorded, it was no doubt due to loss of temporary fertility which had accumulated during a period of rest.” Professor Wallace assumes as a practical agriculturist, without any proof, that the natural fertility of soils differs, and that this can never be exhausted. We can dismiss from consideration, silica, iron, alumina, magnesia, soda, lime and even potash, as being abundantly present in every soil for thousands of crops. But the case is different with phosphoric acid and nitrogen. That soils may become poor in these constituents and may be benefited by phosphatic and nitrogenous manures are well known facts. At

the same time, it should be remembered that there are three natural methods of recuperation of nitrogen which is the most important factor in determining fertility: (1) by rainfall, (2) by the return of the produce of the soil to the soil in the form of excrements, bodies of dead animals, straw, etc., and (3) by the action of bacteria, especially in connection with the roots of leguminous crops. The total produce of food-grains in India has been estimated as eighty million tons and the total export of food-grains at 2,500,000 tons, *i.e.*, at about 3 per cent. So we may assume that 3 per cent. of this plant-food derived from the soil is absolutely lost to the country annually. There is also another loss due to burning of some of the excrements as fuel, the nitrogenous portion of plant-food being entirely dispersed by burning. What the proportion of such excrements that are burnt, is, cannot be determined. Now, one grain crop takes up per acre from the soil an average of about 15 lbs. of nitrogen and  $7\frac{1}{2}$  lbs. of phosphoric acid. The grain is only exported and not the straw. So it is only 3 per cent. of an amount less than 15 lbs. of nitrogen and  $7\frac{1}{2}$  lbs. of phosphoric acid per acre, that is lost by export, and we can add the nitrogen which is lost by burning of cowdung to this. Most likely the total loss of nitrogen per acre by cropping is less than 3 or 4 lbs. per annum, and 3 or 4 lbs. of nitrogen per annum comes down by rain alone in the form of nitric acid and ammonia. Then there is the accumulation by leguminous crops. So, Professor Wallace's opinion is probably correct, as far as nitrogen is concerned. The question of supply of phosphoric acid by conservation of bones or application of phosphatic manures, is therefore of the utmost value for maintaining what Wallace calls the permanent fertility of soils, as it is perhaps possible to exhaust the permanent fertility so far as phosphoric acid is concerned where the proportion of this constituent in the soil is only .05 or less per cent.

In the case of phosphoric acid, on the other hand, we should take into consideration silt deposit where this takes place and the settling of cosmic or meteoric dust. Permanent fertility cannot be exhausted in the case where there is annual movement of silt from higher to lower ground by the monsoon rainfall. For certain localities therefore Wallace's remark that the permanent fertility can never be exhausted, is correct. But that such minimum of fertility can be added to by manuring and more grain produced per acre, admits of no doubt. The fuller utilisation of excreta, human and animal, is of the first consideration, and then other sources of manure can also be considered.

It has been said, that chemical analysis is not a sufficient guide for judging the actual value of soils but only its potential value; in other words, that it does not give any idea of the amounts of plant-food existing in an available form, but only the total quantities of plant-food present. This is probably true in most cases, in spite of the fact that an empirical method has been described and successfully applied in certain cases by Dyer of London

to find out the quantities of phosphoric acid and potash existing in an available form for the immediate use of plants. With regard to nitrogen, however, no satisfactory method has yet been discovered of finding out the proportion of available nitrates, and other sources of nitrogen, etc., present in the soil. Indeed it is difficult to find this out with reference to any soil, as nitrates are so easily washed out. At one time there may be as much as 0·25 per cent. of available nitrates, etc., in the soil, but if the soil is left ploughed up and bare for a few days and if heavy rainfall takes place the same soil may show less than 0·05 per cent. of available nitrates. Loss by drainage may come up to as much as 80 or 100 lbs. of nitrogen per acre, but this is not what ordinarily takes place even in lands swamped with water such as the rice fields of Bengal are. The chief protection against the loss of nitrates and indeed of all soluble plant-food is the generation of vegetable and animal life, visible and microscopic, at the beginning of the rainy season. When the rainy season actually commences, fields which are not under crops, have a luxuriant growth of weeds and minute vegetation and also of animals, large and small. The animal and vegetable life growing rapidly in the soil throughout the rains, prevent to a great extent the washing away of fertility. The question of loss of nitrates and other soluble food-materials by drainage is very complicated, but the loss is not so very great in the tropics owing to the rapid propagation of vegetable and animal life of all sorts before the advent of the regular rainy season, which helps to convert soluble nitrates, etc., into comparatively insoluble protoplasmic bodies.

Availability of plant-foods depends upon four conditions—(1) on the size of soil particles; (2) on the degree of solubility of the soil in water; (3) on the readiness with which soil particles are acted upon by the carbonic acid gas which is the main active ingredient for roots being able to utilize food-substances in the soil by dissolving them out of soil particles; and (4) on the extent to which root development takes place. While the question of the available quantities of phosphoric acid and potash is of the first importance, Japanese investigators have proved that the relative proportions of lime and magnesia, and the compounds in which they are present are of great importance in retaining fertility. These investigators have proved that the proportion of lime and magnesia most favourable for the growth of cereals is as 1 : 1; for crops with more abundant foliage as 2 or 3 : 1; and for tobacco as 4 : 1. But the availability of lime and magnesia is different according to the state in which they occur. As sulphate of magnesia, magnesium is more available to plants than as pulverized and burnt magnesia, and the latter is more available than the carbonate of magnesia; but the proportion varies with the physical character of the soil and to the proportion of humus-matter present, less harm being done when there is excess of

humus matter. Lime as sulphate of lime is, on the other hand, less available to plants than as slaked lime or carbonate of lime. That is why an overdose of gypsum in manure does not hurt a crop like an overdose of slaked lime or even carbonate of lime. When liming a soil, the proportion of magnesia present in the soil should be always taken into account, and when applying phosphatic manures, the proportion of lime and magnesia present should be both taken into account. An excessive liming with carbonate of lime or addition of magnesite in a powdered state may reduce the yield of crops, but not an excess of sulphate of lime, as the availability of phosphoric acid is not prevented by gypsum, but is prevented by carbonate of lime and magnesite; except when large proportions of humus are present. This point was proved in Japan by the following sand-culture experiment. The sand used for the experiment was first treated with concentrated hydrochloric acid and washed with distilled water until every trace of the acid was removed. Two-and-a-half kilos. of this sand were used for each pot, which was manured with 1.5 grammes of bone-dust. The four pots used received the following proportion of powdered limestone, powdered magnesite and gypsum:—

|      |   |                                       |  |
|------|---|---------------------------------------|--|
| I.   | <u>CaCO<sub>3</sub>—3.6 grammes.</u>                  | <u>MgCO<sub>3</sub>—4.18 grammes.</u> |  |
| II.  | <u>CaSO<sub>4</sub>·2H<sub>2</sub>O—6.19 grammes.</u> | <u>MgCO<sub>3</sub>—4.18 grammes.</u> |  |
| III. | <u>CaCO<sub>3</sub>—3.6 grammes.</u>                  | <u>MgCO<sub>3</sub>—1.04 grammes.</u> |  |
| IV.  | <u>CaSO<sub>4</sub>·2H<sub>2</sub>O—6.19 grammes.</u> | <u>MgCO<sub>3</sub>—1.04 grammes.</u> |  |

The following substances were used as manures to enable the rice to grow:—

|   |   |                                 |
|---|---|---------------------------------|
| 0.6 NaNO <sub>3</sub>                               | } | in 100 c.c. of distilled water. |
| 0.6 (NH <sub>4</sub> ) <sub>2</sub> SO <sub>4</sub> |   |                                 |
| 0.4 K <sub>2</sub> SO <sub>4</sub>                  |   |                                 |
| 0.1 FeSO <sub>4</sub>                               |   |                                 |

Upland rice was transplanted into the pots which were kept lightly watered with distilled water. The following results were obtained from the four pots:—

|     |    |    | Average height. | Weight of grains<br>in grammes. | Total weight in<br>grammes. |
|-----|----|----|-----------------|---------------------------------|-----------------------------|
| I   | .. | .. | 30.0            | 0.00                            | 3.2                         |
| II  | .. | .. | 67.0            | 6.50                            | 21.5                        |
| III | .. | .. | 31.0            | 0.00                            | 4.8                         |
| IV  | .. | .. | 69.8            | 7.91                            | 28.0                        |

*Absorptive power of soils.*—To understand how the utilization of phosphates, potash, lime and other food-materials by plants is governed, it is necessary to get an idea of what is called the absorptive power of soils. It is not altogether a chemical process. It is both physical and chemical. Bases and salts are partly



absorbed by the soil as a whole and partly decomposed. Cut off the bottom of a large bottle and place the bottle vertically with its mouth downwards, the mouth being secured with a plug of cotton wool. Fill the bottle with clay loam slightly moistened with water. Then pour dilute ammonia water in small quantities until the liquid begins to drop from the lower end. It will be found that this liquid is little more than mere water. In this way, considerable quantities of ammonia are absorbed by clay. If you repeat the above experiment with sulphate of potash solution instead of ammonia water, the water percolating out will be found to contain only traces of sulphate of potash, but more of sulphate of lime, sulphate of magnesia and sulphate of soda. If you use sulphate of magnesia, the water percolating out will be found to contain little sulphate of magnesia, but more sulphate of soda, sulphate of lime and sulphate of potash. If you use sulphate of soda, the filtrate will contain little sulphate of soda, but more of sulphate of magnesia, sulphate of lime and sulphate of potash. If you use potassium nitrate solution, the filtrate will be found to contain little or no potassium nitrate but more of calcium nitrate, magnesium nitrate and sodium nitrate. In each of these cases the bases supplied are retained by the soil by chemical agents lurking in it, while lime, magnesia or some other base is removed with the acid radicle, if any, Ammonia water not containing an acid radicle, the water comes out pure, while in the other cases the sulphuric or nitric acid combines with the bases of the soil.

If similar experiments be tried with phosphate of potash and silicate of potash it will be found that both phosphoric acid and potash in the one case and silicic acid and potash in the other are retained by the soil. Alkaline carbonates are also absorbed by the soil without hardly any decomposition. Speaking generally, chlorides, nitrates and sulphates are decomposed, while silicates, carbonates and phosphates are absorbed without decomposition. Soil has also the power of absorbing minute quantities of chlorine, sulphuric acid, and nitric acid. In each case the absorptive power is limited, *i.e.*, after a time the filtrate or the water percolating out of the cotton wool end of the bottle will be found to contain the salt poured in without decomposition or absorption. Soils do not absorb all the bases with equal readiness. They have the greatest absorptive power for ammonia, then for potash, then for magnesia, then for soda and lastly for lime. When the material for absorption is ready at hand the maximum degree of absorption is reached within a few hours, except in the case of phosphates. When there is phosphoric acid ready for absorption, the maximum degree of absorption is reached after several days. Relatively more is absorbed out of a dilute solution, though from a strong solution absolutely a larger quantity is absorbed. The quantity of bases (and acid radicles in the case of phosphates, silicates and carbonates) absorbed, depends on various conditions; (1) the relative masses of soil and the solution; (2) temperature,—less being

absorbed at a high temperature ; and (3) the state of the combination of the substance to be absorbed. For instance, more potash is absorbed when it is given to the soil in the form of phosphate than as chloride or nitrate. The bases absorbed are only dissolved out again slightly by water, more by water containing carbon dioxide, and completely by hydrochloric acid. When a base has been absorbed, it may be partially or wholly replaced by another base, e.g., if a soil saturated with absorbed potash is given a dose of sulphate of soda solution in the above described manner, part of the potash will be removed (*i.e.*, much more than if the soil had been washed only with water) and its place taken by soda. If now the soil is washed with a solution of lime, more of the potash and part of the soda will be washed out and their place taken by lime. The absorptive power of soils is diminished by ignition and entirely destroyed by treatment with hydrochloric acid. A soil, the absorptive power of which is diminished or destroyed by either of these ways, may get back its power if it is treated with carbonate of soda or carbonate of lime. All soils have not equal absorptive power. Speaking generally, the greater the absorptive power of the soil the greater is its fertility. All good soils decompose to a certain limit salts of potash, magnesia, soda and lime in such a manner that the bases, and the phosphoric, silicic and carbonic acids, if they are present, are retained in the soil, and nitric, hydrochloric and sulphuric acids become dissolved in the form of compounds of lime, soda, magnesia, etc., taken from the soil, and then either taken up by roots of plants or washed away, or deposited in the dry weather as an incrustation or inflorescence on the surface. Though clay-loams possess the power of absorption in a very marked degree, absorptive power has been noticed even in compact rocks, such as basalt, shale, or marl zeolites.

*Soils with double silicates* have high absorptive power. The hydrated double silicates in the soil resemble zeolites, which contain lime, magnesia, potash and soda and are decomposed easily by hydrochloric acid. Some of the natural double silicates of the soil have been actually identified as zeolites, and those containing such have the high absorptive power of zeolites. An artificial preparation of silicate of alumina and soda possesses an absorptive power resembling that of clay-loams. The artificially prepared hydrated double silicate which shows the highest absorptive power, contains 46 per cent. of silica, 26 per cent. of alumina, 16 per cent. of soda and 12 per cent. of water. When this artificially prepared double silicate is treated with a lime salt, most of the soda is replaced by lime, and when it is afterwards treated with potash, lime is partly replaced by potash. In the same way, magnesia and ammonia can be made to enter into the composition of this artificial mixture which may now be called soil. That natural soils contain similar double silicates to those of this artificially prepared soil, is rendered certain by the following facts:—(1) Soils which after treatment with hydrochloric acid yield to a solution of carbonate

of soda a much larger quantity of soluble silica than before treatment with hydrochloric acid, generally have a high absorptive power. (2) Soils treated with hydrochloric acid which lose their absorptive power regain this power on addition of carbonate of soda or carbonate of lime which enables the precipitated silica to re-form hydrated silicates. (3) Hydrates of iron and aluminium have the power of absorbing small quantities of ammonia, potash, etc., when presented as hydrates, carbonates, or phosphates; but they have very little power of absorbing bases when presented in the form of chlorides, sulphates or nitrates. They have the power of fixing phosphoric acid and also absorbing small quantities of hydrochloric acid and sulphuric acid, fixing them as highly basic compounds. (4) Hydrated silicic acid has an absorptive power for free bases or carbonates. (5) Humus also has the power of absorbing bases when they are in a free state, or as carbonates or silicates. When phosphoric acid is presented in a soluble form as acid phosphate of lime (Superphosphate of lime), it first acts on the carbonate of lime in the soil to form a less acid phosphate (Dicalcium Phosphate) and afterwards neutral phosphate (Tricalcium Phosphate); possibly some phosphate of magnesia also is formed. These combining with the iron and alumina of the soil become fixed as phosphates of iron and alumina. The reactions that take place may be expressed by the following equations:-

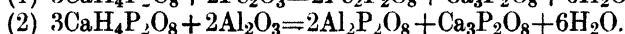
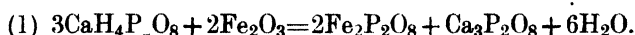

The absorption of phosphoric acid is more rapid in calcareous soils than in clays or sands. Clays and sands go on absorbing phosphoric acid for several days. One of the functions of carbonate of lime in soils is to supply lime with which acids of certain salts may combine, so as to enable the bases to be absorbed. The calcium carbonate of the soil naturally present or added as manure, helps to keep up proper equilibrium between the bases of the compound silicates.

The three kinds of absorption may be shortly illustrated thus:

(1) *Physical absorption*, e.g., when colouring organic matter is removed from buffalo-dung such as the dung of buffaloes fed on mango leaves, and absorbed by the soil,

(2) *Absorption without exchange of bases*, as in the case of hydrates, carbonates, phosphates and silicates. Hydrates of iron and aluminium and humus take an active part in this absorption

(3) *Absorption with exchange of bases*, in which the hydrated compound silicates are the active agents. For ordinary fertile soils this kind of absorption plays the most important part. Those ash constituents of plants which are most valuable and least abundant in the soil are those which are fixed in large quantities; e.g., phosphoric acid and potash. These when liberated in the soil by the action of weathering of rocks or soil particles, are immediately fixed by this absorptive power. Those saline matters

which are easily washed away, *e.g.*, chlorides, sulphates and nitrates, are (with the exception of nitrates) either required by plants in very insignificant quantities, or are abundantly present in the soil, or supplied to it without human aid.

## CHAPTER LXXXVI.

## NITROGENOUS MANURES.

[Nitrogen as nitrates of highest value ; Bacteria utilizing free nitrogen of the air and accumulating albuminoid matter in root-nodules ; Nitrites useless as plant-food ; Sewage-water for irrigation ; Nitrates in nature, as sodium, potassium and calcium nitrates ; Nitrogen in relation to bases ; Ammonium sulphate a product of gas works ; Crude gas liquor to be diluted if applied : Urea also utilised by plants ; Loss of nitrates by drainage may be more than made up by nitrification ; Conditions suitable for nitrification ; Nitrous earth ; Nitre-beds ; Manufacture of saltpetre ; Application of nitrates ; *Bhadoi* and early *Rabi* crops chiefly benefited ; Leguminous crops sometimes injured ; Compost heaps ; Antiseptics and putrefaction retard nitrification in farm-yard manure ; Calcium carbonate or gypsum to be used, not caustic lime ; Conservation of manure ; Reduction of nitrates into nitrites and free nitrogen in swamps ; Origin of nitrates in soil ; Nitrification of urine ; Export of saltpetre ; Value of nitrogen as compared to those of phosphoric and potash ; Causes of variation of composition of dung ; Nitrogen in urine—its proportion and the forms in which it occurs ; Composition of dung and urine of different animals, Litter ; Urine earth ; Box-manure ; Value of Indian cow-dung and urine about the same as of English cow-dung and urine ; Amounts of plant-food in one ton of farm-yard manure ; Practical value of cow-dung as determined by experiments ; Poudrette ; Town-sweepings ; Silt ; Vegetable refuse ; Ammonia Nitric acid ; Conditions affecting loss of nitrogen ; Albuminoids ; Green manuring ; Aquatic weeds ; Straw ; Saw-dust ; Leaves ; Seeds ; Oil-cakes ; Megass ; Refuse of sugar-refineries, silk, indigo and glue factories, particularly rich ; Coal ; Soot ; Blood ; Flesh ; Skin ; Horn ; Hair ; Feather ; Carcasses of animals ; Refuse of fish ; Guanos ; Utilization of sewage, Deodorizing processes ; Practical value of sewage and sewage grass ; Crops suitable for sewage irrigation ; Animal refuse of more value than vegetable refuse.]

*Sources of Nitrogen.*—Of the four principal manurial constituents required by plants—nitrogen, phosphorus, potassium, and calcium—nitrogen is the most important and, on the whole, it may be said, the richer a substance is in nitrogen the greater is its value as a manure. Green plants are not able to make any use of the free nitrogen of the air, but algæ, and possibly some fungi can make some use of nitrogen in this form. Minute fungi, called bacteria, having a tendency to accumulate nitrogenous organic compounds at the roots of plants, chiefly of the leguminous order, these plants derive benefit from the free nitrogen of the air through the help of these bacteria. As nitrites also, plants are not able to make use of nitrogen. The nitrates contained in irrigation water coming in contact with sewage, may become more or less reduced to nitrites, in which form the nitrogen is of no use to plants. Irrigation with sewage water is therefore not always a very effective means of applying nitrogenous manure to land. Nitrogen is absorbed by plants chiefly in the form of nitrates

and ammonia salts. Nitrates occur in nature as saltpetre ( $\text{KNO}_3$ ), Chili saltpetre ( $\text{NaNO}_3$ ) and also as saline inflorescence on walls, which is largely calcium nitrate ( $\text{Ca}(\text{NO}_3)_2$ ). Ammonium nitrate also occurs in air and in rain water. Saltpetre and Chili saltpetre or sodium nitrate are largely used for manure. Of ammonium salts the substance most largely used for manure is ammonium sulphate which is manufactured out of gas-liquor, and is therefore a bye-product of gas-works. The crude gas liquor diluted with water is also sometimes used for application on wheat and other cereal crops.

*Nitrates.*—In connection with the question of recuperation of nitrogen in the soil, the agency of bacteria is to be considered the most important. Loss by drainage is generally entirely made up by this natural recuperation. In fact, while the expenditure of nitrogen per acre by cropping is only about 15 lbs., loss by drainage under an injudicious treatment may come up to as much as 80 or 100 lbs. per acre, but bacteria have been also known to accumulate 80 or 100 lbs. of nitrogen per acre in a single season. On the one hand, a free and moist soil is helpful to this fixation of nitrogen, while on the other, such soil is also liable to loss by drainage in wet weather. A free and open soil kept moist, but at the same time protected from rain, is therefore most helpful to the fixation of nitrogen and the production of nitrates. The presence of some organic matter in the soil is also essential. The production of nitrates (which must be clearly distinguished from the fixation of nitrogen, although it is also determined by bacterial agency) is produced under conditions which naturally prevail in village sites, and old homesteads dug up and used as manure are known to give good results. But artificial nitre-beds under shade may be formed on every farm, and the earth regularly used as manure. Further refined and purified, this nitrous earth, or *lona mati*, so extensively used as manure in the United Provinces and parts of Bihar, yields the saltpetre of commerce.

*Saltpetre is manufactured* largely in Bihar and to a certain extent in several districts of the United Provinces, and the Punjab. More than two-thirds of the saltpetre exported from Calcutta comes from Tirhut, Saran and Champaran. The climate best suited for the production of nitre is where dry weather follows the rains and thus by evaporation allows the salt to effloresce on the surface. Presence of carbonate of lime in abundance is helpful to the generation of nitre, and this accounts for the district of Tirhut being so fruitful in the production of nitre, for almost half of its soil is calcareous. The manufacture in Bihar is in the hands of a caste called the *Nuniahs*, who revel in old village sites and mud walls. They make piles of loose earth after the rains are over and build mud walls round them, that the precious stuff may not be washed away. This earth is obtained by scarping off an inch or two of the bed chosen and made into conical heaps 2 to 4 ft. high. By March or April, when a large number of these heaps

have been collected, the processes of solution and filtration begin. The best temperature for nitrification is 98°F., and if this and moisture could be given artificially in presence of carbonate of lime and organic matter, nitre-beds and heaps would give the best results. *Kalsies* are placed on tripods, each *kalsi* having a hole at its bottom. A layer of straw is put at the bottom, over it ashes from indigo refuse, and then the vessel is nearly filled with the saline earth, in a loose manure. Under each *kalsi* filled with saline earth is placed an empty *kalsi* and above it one filled with water having an orifice at the bottom, in the manner in which an ordinary *kalsi* filter is arranged. A series of these stands are erected side by side, and the liquid from the bottom *kalsies* is removed from time to time and boiled until the liquor comes out so free from salt that it is not worth boiling. The liquor obtained contains two to five per cent. of saltpetre. Oval iron pans from one to two feet in diameter and six to nine inches in depth are used for boiling the liquor. The diminishing liquid is from time to time replenished by fresh supplies. The impurities that rise are carefully skimmed off. On attaining a certain degree of concentration, the liquid is set apart to cool in a shallow vessel and the impure saltpetre is copiously precipitated. This impure precipitate is scooped out from the bottom of the pan at intervals. After 30 to 36 hours of continuous labour, 8 to 16 lbs. of crude saltpetre are made; the larger pans yielding up to forty lbs. Solar heat is also used for evaporating the liquor. This crude saltpetre is recrystallised and then exported to Europe, where it is further refined. The principal impurities are chlorides of potassium and sodium. Weight for weight sodium nitrate is a richer manure than potassium nitrate, inasmuch as it contains seven per cent. more nitric acid. In the manufacture of gunpowder, however, potassium nitrate is in use, but for the manufacture of nitric acid, sodium nitrate. In India, potassium nitrate being much cheaper, it is the best nitrogenous manure to use, the potassium also being a valuable plant-food.

*Utilization of Nitrogen by plants.*—Nitrogen is absorbed by plants more readily in the form of nitrates than in any other form. In water-culture experiments nitrates are relied upon as the best source of nitrogen. Ammonia salts are less certain. Nitrates chiefly promote the growth of leaves and impart to them a rich green colour. In Peru, crude nitrate of soda is found incrusting the soil of a desert. Hence this article rather than saltpetre is chiefly used for manurial purpose in America and Europe. Scrapings from *pucca* walls or damp and dirty limestone buildings are rich in nitrate of lime which is also a good manure.

*Action of nitrates in plants.*—Nitrogen is principally assimilated as nitrates in combination with inorganic bases. The liability of nitrates getting lost by washing when there is a crop growing in the field, is not, therefore, great. The change of nitrates into amides and finally into proteids usually takes place fairly rapidly

in the plant, but the nitrogen in very immature grass or fodder is not necessarily indicative of albuminoids, and it is therefore not advisable to use fodder plants before they flower.

*Manner of application of nitrates as manure.*—Saltpetre, Chili-saltpetre or Sodium nitrate and Calcium nitrate should be applied as manure, mixed and diluted with some other substance, such as water, loam or dung, at the rate of 100 to 150 lbs. per acre. It should not be mixed with dung, as the latter contains many organisms which reduce the nitrogen in the nitrates to the free state. The application should be only as top-dressing when the plants are six to nine inches high, as germination and growing of young seedlings are not much benefited by the application. It is in showery weather that the application of nitrates proves most beneficial. It is, therefore, applicable to early *Bhadai* crops or early *Rabi* crops. Grain crops are chiefly benefited, also those which are valued for their leaves, such as pot-herbs (*sags*), cabbages, mulberry, etc. Onions, table vegetables and root-crops generally are also benefited by nitrates. Leguminous crops may be actually injured by the application.

*Nitre-bed.*—Each farmer can easily have his own covered and enclosed *nitre-bed* as a perpetual source of manure for his fields. It is important to secure a uniform temperature as near 98°F. as is possible under the climatic conditions. Below 40° or 45°F. and above 130°F. nitrification ceases. The earth should be kept loose. There should be enough of moisture, lime and organic matter in it, but not too much of the first two. Warington could not ordinarily discover nitrifying bacteria below a depth of eighteen inches and the looseness of soil in the nitre-bed need not therefore extend beyond this depth. Darkness also favours nitrification. This is one reason why manures should be kept in dark cellars and sheds. Compost heaps should be also kept under trees or sheds. Salt, coal-tar, spent lime of gas works, ferrous sulphate and disinfectents of germicides generally, retard the process of nitrification. Rapid putrefaction also hinders nitrification, and it is therefore necessary that manure heaps should remain sweet. A wet and puddly pen or cow house is not so suitable for the process of nitrification as a stall in which the dung is spread about and kept moderately warm and only occasionally moistened with urine. The lime used for nitre-beds should never be in the form of caustic lime which sets free ammonia and hinders nitrification, but in the form of carbonate. Warington has pointed out that if gypsum is mixed with strong solutions of urine so that the carbonate of ammonia is converted to sulphate and the excessive alkalinity of the liquid annulled, they could be nitrified more easily. Excessive alkalinity is inimical to the process of nitrification.

*Conditions suitable for nitrification.*—The practical lessons to be deduced from these principles are:—(1) Cattle (except, of course, dairy cattle) should be kept in stalls, when they are not

at work or in the field. Here the manure should rot and be trodden upon. (2) The urine should be removed fresh and used separately as manure mixed with ashes and water. (3) If no provision is made for removing the urine, gypsum should be freely used in the stall. (4) Slaked lime should be occasionally spread in the stall. (5) The floor of the stall should be about eighteen inches deeper than the surrounding level of the land. (6) Straw should be freely used for litter as it leaves openings for air to act on the manure. In other words, cowdung and litter may be utilized as the basis for nitre-beds.

*Reduction of nitrates.*—Nitrates are partially de-oxidized in puddly manure pits, also in swampy rice-fields, where the process of reduction occurs, resulting in the formation of marsh-gas. Even in soils rich in humus, nitrates are easily destroyed in the absence of oxygen, quickly at high temperatures and slowly at low temperatures. The nitrates are reduced and free nitrogen gas escapes.

*Origin of nitrates.*—Nitrates in soils are probably chiefly derived from oxidation of ammonium compounds by bacteria in an alkaline medium, resulting from organic matter coming in contact with lime. It is not a purely chemical process which can be represented by chemical formulæ. In the laboratory of course, nitrates could be evolved by treating nitrogen compounds with a strong oxidizing agent, *e.g.*, when caustic ammonia is boiled with potassium permanganate, or subjected to the action of peroxide of hydrogen. But in the soil the intervention of bacteria is the determining agent in the formation of nitrates; but how these bacteria work is not yet known. That they live on nitrogenized, organic matters and on ammonia compounds is known, and also that they give rise to nitrates. The presence of iron in the soil is indirectly a great help to nitrification, as iron in the form of hydrate acts as a carrier of oxygen from upper to lower layers of soil, by cultivation.

*Urine* does not nitrify unless it has been diluted with water and mixed up with a great deal of earth. Very dilute solutions of carbonate of potash, carbonate of soda and carbonate of ammonia favour nitrification, but if the solutions contain more than two or three parts per thousand of the salt they check the action of the ferment. If chloroform, carbon bisulphide or any other strong antiseptic is passed through soil, nitrification is arrested, owing to the death of the organisms; continual drying of soils at 100°C. also prevents nitrification. When urine of animals is allowed to ferment, in considerable quantities, an undue proportion of ammonium carbonate is evolved and nitrification is checked. The popular belief that urine is injurious to land and that it burns up plants is therefore correct, though diluted it is such a valuable manure. In recommending the use of urine to cultivators the necessary caution should be always given. The nitrifying bacteria find a fit soil in well-rotted manure only when it is not too wet.



More than three-fourths of the value of dung depends upon the nitrogen it contains.

*Trade in saltpetre.*—The quantity of saltpetre annually exported from India is nearly 600,000 maunds valued at over 40 lakhs of rupees. Most of this goes to Great Britain and the United States of America for the manufacture of gunpowder. It is more satisfactory to use this manure in a comparatively pure form (say, containing not more than five or six per cent. of impurities which costs in Calcutta about Rs. 6 per maund), than crude saltpetre which may contain 30 to 50 per cent. of foreign matter.

*Relative values of nitrogen, phosphoric acid, and potash.*—Notwithstanding the potentiality of soil for accumulating nitrates under specially favourable circumstances, the application of manures to soils has for its chief object the addition of nitrogen in an available form. In estimating the value of manures in a practical manner, ammonia, phosphoric acid and potash may be valued at 6*as.*, 3*as.*, and 2*as.* a lb., respectively. Ammonia is valued in England even at 8*d.* a lb. Indian soils being particularly poor in nitrogen and nitrogen being the most valuable plant-food, the proportions of nitrogen in various substances that are or can be used to enrich the soil, should be carefully studied.

*Farm-yard manure.*—The most easily available manure which is used for bringing nitrogen directly and indirectly into the soil is farm-yard manure. It consists of solid and liquid excrements of all farm animals and litter. It varies very much in composition. The conditions that determine the variation of composition are—(1) age of the animal producing it; (2) condition of the animal, whether lean or fat; (3) the species of the animal; (4) food of the animal; (5) temperature; (6) accommodation generally; (7) quantity and kind of litter used, and (8) management during accumulation and its after-treatment.

*Loss in digestion.*—During the passage of food through the alimentary canal of an animal, nearly the whole of the nitrogen and the mineral matter are got back either in the solid or the liquid excrements. This is the case chiefly with adult and fattening animals. In the case of young animals and milking cows, the nitrogen excreted is much less. A little more than half the quantity of nitrogen taken in as food is given off in urine, which shows what a valuable nitrogenous manure urine is. The remaining half (or less) is partly voided with the solid excrement and partly stored up in the body of the animal.

Adult animals void a larger amount of nutritive matter than growing animals or animals in milk. The latter use up a good deal of phosphates, nitrogen and mineral salts required for the formation of bones, blood, and muscles, or milk. Pregnant animals and lean animals also absorb a good deal of nutriment, and their excrements are poorer than those of fat animals. Animals poorly

fed (only on straw and ripe grass) yield poor manure. Animals fed on carrots, oats, pulses, chaff, bran, fresh green herbage and specially oil-cake. yield richer manure.

*Quantity of excrements voided by cattle.*—The average amount of dung voided by cattle in Bengal may be put down at about 50 maunds and the average amount of urine at 10 maunds per annum. The actual averages obtained at Sibpur in 1894 were 46 maunds of dung and 11 maunds of urine, and in 1896, 76 maunds of dung and 5½ maunds of urine. The European average for urine is much larger in proportion as would be expected, viz., one-third or more of the weight of dung.

*Composition of excrements of animals.*—The following table compiled from Johnston and Cameron's Elements of Agricultural Chemistry and Geology, gives an idea of the composition of dung and urine of the various classes of farm animals in 1,000 parts :—

|                    | Cow.  |        | HORSE. |        | SHEEP. |        | Dung. | Urine. |
|--------------------|-------|--------|--------|--------|--------|--------|-------|--------|
|                    | Dung. | Urine. | Dung.  | Urine. | Dung.  | Urine. |       |        |
| Water .. ..        | 860   | 915    | 750    | 900    | 640    | 950    | 760   | 976    |
| Nitrogen .. ..     | 3·6   | ·9     | ·6     | 1·1    | ·6     | ·8     | ·7    | ·3     |
| Phosphoric acid .. | ·3    | ..     | ·4     | ..     | ·5     | ..     | ·5    | 1·2    |
| Potash and Soda .. | 2·2   | 1·0    | 3·5    | 1·4    | ·3     | ·8     | 6·5   | ·2     |

Pig's urine and human urine are very similar in composition, especially in the high percentage of phosphoric acid. The excrements of sheep are the most concentrated, then of the horse, then of the ox, and last of all of pigs and of men. Cow-dung contains the largest proportion of water and is poorest in nitrogen of all the dungs. Horse-dung is drier and richer, sheep's dung is the richest. Bird's dung and insect droppings are still richer in nitrogen, potash, and phosphoric acid. In order of value, insect droppings come first, then bird's dung and bat's dung, then sheep's dung and goat's dung, then horse's dung, pig's dung and human dung, and last of all dung of oxen and buffaloes. The principal differences in composition between dung and urine, besides the difference in the proportion of water, are :—(1) Urine is richer in nitrogen (except in the case of pig-urine) and in alkaline salts (potash and soda), while dung is richer in the earthy salts (lime and magnesia), and phosphates. (2) Silica

is abundantly present in dung of animals chiefly because they eat a lot of earth with their food. Human excrements, like excrements of other animals, differ very much according to the food eaten.

*Gain by evaporation.*—As the watery portion of urine and dung evaporates, urine gets richer and richer in nitrogen than dung, over 90 per cent. of urine being water, while dung contains 70 to 75 per cent. of moisture. In allowing urine to get evaporated and concentrated, fermentation must be kept in check by adopting a quick method of evaporation, or by using an antiseptic substance.

*Litter.*—Buck-wheat straw used as litter adds to the value of the manure, and so does the straw of leguminous crops. The manurial value of cereal straws used as litter mainly depends on the proportion of nitrogen they contain. Dried ferns, rushes, and young leaves of all kinds used as litter have a special value as litter, as they contain a very high proportion of potash. The return of the straw in some form or other to the land is very essential as straw contains 5 per cent. of nitrogen, 1 per cent. of potash and 3 per cent. of phosphoric acid, and as an acre of land yields about 2,000 lbs. of rice straw per annum, the restoration of the straw is a great matter, considering that the total quantity of nitrogen, phosphoric-acid and potash taken out by a crop of rice (grain and straw) is about 10 lbs., 5 lbs., and 5 lbs., respectively. Practically no bedding material or litter is used in India for the comfort of cattle.

*Use of dry earth.*—In the Cawnpore Experimental Farm a system of scattering dry earth on the floor of the cattle stall, of removing it daily and drying it in the sun and using it again for matting on the floor, has been introduced. This, no doubt, cures the *urine-earth* gets gradually more and more concentrated in nitrogen until as much as 1 per cent. of nitrogen is accumulated when the earth is used as a nitrogenous manure. But the extreme alkalinity of the earth and the exposure to sunlight both go against nitrification. Nitrification, however, proceeds after this *urine-earth* has been used as manure. The use of dried leaves, or straw, or megass (*i.e.*, crushed sugar-cane) for litter is advisable, also the feeding of cattle in covered stalls, the floor of which should be about eighteen inches below the level of the surrounding ground. The accumulation of dung and urine and litter may go on until the manure reaches the level of the ground, when it can be removed to the pit or applied to fields. Gypsum should be scattered on the manure every now and again, if this system is adopted, to prevent formation of carbonate of ammonia. Gypsum is also a mild antiseptic. The system of converting urine into *urine-earth* by drying it in the sun may be also adopted.

*Box-manure.*—The stall-fed manure which gives such good results in England has been found to give good results in the Nagpur Experimental Farm also, and this system therefore is to be recommended. Indian cattle-dung and urine (specially the latter) are

not poorer than English cattle-dung and urine, as the following results of analyses given by Dr. Voelcker will show :—

|                                 | CATTLE DUNG.     |                   | CATTLE URINE. |         |
|---------------------------------|------------------|-------------------|---------------|---------|
|                                 | English farm yd. | Indian dung-cake. | English.      | Indian. |
| Moisture ..                     | 66·17%           | 7·22%             | 91·50%        | 90·62%  |
| *Non-volatile organic matter .. | 28·24 „          | 65·32 „           | 7·00 „        | 7·64 „  |
| †Mineral matter (ash) ..        | 5·59 „           | 27·46 „           | 1·50 „        | 1·74 „  |
|                                 | 100·00           | 100·00            | 100·00        | 100·00  |
| *Containing Nitrogen ..         | ·65%             | 1·48%             | ·90%          | 1·16%   |
| †Containing—                    |                  |                   |               |         |
| Lime ..                         | 1·35 „           | 1·96 „            |               | ·08 „   |
| Magnesia ..                     | ·15 „            |                   |               | ·57 „   |
| Potash ..                       | ·67 „            | ·63 „             |               | ·64 „   |
| Soda ..                         | ·08 „            | trace             |               | ·02 „   |
| Phosphoric acid ..              | ·31 „            | ·54 „             |               | ·02 „   |

*Different character of dung-manure.*—In one ton of farmyard manure there are 9 to 15 lbs. of nitrogen, 4 to 10 lbs. of phosphoric acid and 5 to 13 lbs. of potash. Manure made in boxes contains twice as much nitrogen (18 to 30 lbs. per ton). Rotten dung is more soluble and is a better manure than fresh dung, but it contains little free ammonia which is combined with vegetable acids. During fermentation, dung loses water, carbon dioxide, marsh gas (methane), hydrogen and nitrogen which are evolved in the process, and thus it becomes more concentrated. About one-third of the ammonia is lost even if it is not allowed to wash away. Dung, which is not pitted but kept spread out, loses two-thirds of its nitrogen. Voelcker gave it as his opinion that on the whole it was better to use dung and urine fresh on fallow land and use the land for cropping four or five months afterwards. In manure pits the maximum value of dung is reached in a temperate climate in about four months, and it is a mistake to suppose that the older the manure the better it is. Three-years old dung may contain a very small quantity of nitrogen remaining.

*Practical results.*—Experiments conducted in the different Government farms in India have led to the conclusion that the application of about six tons of cow-dung per acre results in an increased outturn of 300 to 400 lbs. of wheat (Cawnpore and Dumraon). The figures for Nagpur give an increase of 200 to 300 lbs. In the case of maize the average increase at Cawnpore has been 400 to 500 lbs. per acre.

*Poudrette*, or night-soil-manure pitted with ashes and town refuse, naturally varies very much in composition. The poudrette formed in deep municipal trenches gives rise to an offensive smell, and the Meagher system of utilising night-soil by depositing

it on beds and covering these with three inches of soil is less offensive, as the decomposition in the latter case, especially in the dry weather, is very rapid. The poudrette made by drying only, on the continent of Europe, contains about 25 per cent. of moisture, 3 per cent. of nitrogen, 3 per cent. of phosphoric acid and  $1\frac{1}{2}$  per cent. of potash. Mixed with sulphate of lime, earth, etc., the poudrette is less valuable, containing only 2 per cent. of nitrogen or less. The poudrette made at Poona was found to contain about 1 per cent. of nitrogen and  $\frac{1}{4}$  to  $1\frac{1}{2}$  per cent. of phosphoric acid. The poudrette made at Cawnpore was found to contain '4 to '7 per cent. of nitrogen. The increased outturn from poudrette at Cawnpore from the application of six tons per acre has been 500 to 1,000 lbs. of maize and 400 to 600 lbs. of wheat per acre in excess of the unmanured plots. Weight for weight, poudrette has been found a better manure than cow-dung. At the Allahabad Grass Farm, the amount of night-soil applied per acre (on the Meagher system) is 168 tons per acre once in 10 years. The weight of green grass obtained at this farm varies from 10 to 30 tons per acre per annum, which is equivalent to from three to ten tons of hay. A more extended use of night-soil and urine for manure is highly desirable. It is in this respect that the Chinese system of agriculture is in advance of the Indian. *Town sweepings* are less valuable as manure, as they contain about '3 or '4 per cent. of nitrogen, but as they have no offensive odour, they should be readily used for manure. At Poona such sweepings are used for sugar-cane and at Allahabad for grass land with very satisfactory results. The sullage water of town drains, which is usually run into the nearest river, is also a valuable manure. Mr. Wyer, a Collector of Meerut, utilized his small farm for the purpose of illustrating its value to cultivators. Two irrigations with it doubled the outturn of cotton, maize, juar, and oats over that obtained with well water. There is, indeed, a large supply of manure in cities and mofussil towns which is usually allowed to go to waste. Conservancy arrangements may be made a source of profit if municipalities are properly conducted, and under proper management the utilization of sewage and sweepings for agriculture would secure a better sanitary improvement than any other mode of disposing of the materials.

*Silt.*—The value of river, canal and tank *silt* as manure is still more difficult to ascertain than the value of dung, urine or town refuse. Silt is a very important source of plant-food and recuperation of land. In Eastern Bengal, large tracts of country depend on silt only for manure. The results of analyses made by Dr. Leather with the Upper Eastern Jumna Canal silt show that the silt deposit during the monsoon period is more than sufficient for the rice crop (32 lbs. of nitrogen and 41 lbs. of phosphoric acid per acre having been accounted for from this source), while during the cold weather when the canal water is clear, the amounts of nitrogen and phosphoric acid supplied by silt deposit are very insignificant (only  $\frac{1}{2}$  a lb. of nitrogen and 1 lb. of phosphoric acid

per acre). All silts, however, are not valuable. Sandy silt may be deposited on good soil and cause damage to the soil.

*Humus* or vegetable refuse in soil is of little direct use to plants. Some experimenters have even suggested that humus is poisonous to plants; but the balance of evidence shows that indirectly it is a valuable source of plant-food, and to the lower forms of vegetable life it is a direct source of food. Ammonia and nitrates, which are the principal forms in which nitrogen is taken up by plants, are present only in very minute proportions, the greater proportion of nitrogen remaining in the soil in a non-mineralised and non-available form. Peat contains from one to four per cent., usually about two per cent. of nitrogen. The usual proportion of nitrogen in soils is from .01 to .5 per cent., when a soil contains more than .5 per cent. of nitrogen it should be considered very rich in this important constituent. Humus boiled with alkalies, gives off nitrogen in the form of ammonia. The nitrogen in humus exists in various unavailable combinations, and it is only slowly rendered available by the action of alkalies, by fermentation. Part of the nitrogen is lost as free nitrogen in course of fermentation, but the greater portion enters into organic combinations which are more or less insoluble and difficult to decompose, and, without decomposition, they are probably useless to plants. Nitrates are undoubtedly the most valuable of all plant-foods and these are slowly formed out of the ammonium humate, ulmate, etc., formed by the decomposition of humus.

*Urea*.—Ammonia, urea, uric acid, hippuric acid and guanin (which occur in urine) are also easily decomposed giving ammonia and ultimately nitrates, and so are very valuable sources of nitrogenous plant-food.

*Ammonia*.—The soil under ordinary circumstances absorbs and condenses minute quantities of ammonia from the atmosphere, but the ammonia of the soil is also being continually diffused into the air. If a soil contains a good deal of ammonia and is in a moist state, it is rich in plant-food, but on drying such soil readily parts with its ammonia. On moistening this soil again and drying it, more ammonia is given out and so on. The constituents of soil which have the greatest attraction for ammonia are clay, ferric hydrate and aluminum hydrate. With acids of the humus group and with compound silicates, ammonia forms compounds which are very sparingly soluble. Ammonia escapes in the air probably as carbonate of ammonia. If sulphate of lime and carbonate of ammonia are mixed together, the mixture smells strongly of ammonia, but if the mixture be thoroughly moistened with water, the odour of ammonia is no longer perceived, ammonium sulphate and carbonate of lime being formed. If the mixture is dried, carbonate of ammonia is again given off and sulphate of lime is formed. The latter is, therefore, called a fixer of ammonia, but it is only in the damp state that it is a fixer. Potassium chloride, kainit, clay and peat are also fixers of ammonia. Of these, gypsum

may be used in dung-heaps and stables, but kainit is the best substance to use, then peat, then clay, and then gypsum. It is difficult to estimate the amount of ammonia in soil and manure. It is being continually changed into nitric acid and part of it also is constantly being dispersed into air. If a quantity of soil is boiled with caustic-alkali, not only is the ammonia actually present obtained in the distillate, but also an additional quantity liberated from the organic matter present. If magnesia is used instead of potash, much smaller quantities of ammonia are obtained. The actual proportion of ammonia in soil is only about .0005 per cent. There is a constant interchange of ammonia between water, air and soil, and the sea appears to act as the final reservoir for much of the ammonia washed away by drainage and percolation. But the sea also gives off ammonia to air, more in the hot weather than in the cold. The air of hot countries and of towns contains a larger proportion of ammonia than of temperate climates and of the country respectively. The subsoil contains less ammonia than the surface soil, and there is no ammonia below a depth of about six feet.

*Nitric acid* is formed in the air by electricity and in some cases by the action of ozone, and then brought down by rain and dew, and other meteoric waters, nearly always combined with ammonia as ammonium nitrate. Priestley first noticed the formation of nitric acid in the atmosphere and Liebig found it in rain water. Nitrates and nitrites are formed in the soil also and in manure heaps, and their formation and removal by plants and drainage are questions of very great importance to agricultural science. Some chemists are of opinion that nitrates are formed from the free nitrogen of air by the intervention of soil only, but there is no certain proof of this; but that they are formed by the intervention of bacteria and also by that of algæ has been proved. Nitrates are very soluble and they are washed away out of soils chiefly in combination with lime as calcium nitrate. Soils containing much ferric hydrate ( $\text{Fe}_2\text{O}_3 \cdot 3\text{H}_2\text{O}$ ) are better able to retain nitrates as basic ferric nitrate. Soils containing much organic matter to which air has not free access have their nitric acid reduced to ammonia partly to free nitrogen, and nitrous oxide. In the last two forms nitrogen is useless to vegetation. This is one reason why humus soils should be kept well cultivated whether there are crops on them or not. When a soil is in good condition as much as 80 lbs. of nitrogen may be converted into nitrates per acre per annum to a depth of twenty-seven inches, the largest quantity being formed in the top nine inches. The ratio has been found in England between the first nine inches, the next nine inches and the third nine inches to be 100 : 60 : 30. Crop residues being easily nitrifiable those crops which leave behind a large quantity of organic matter go to improve soils irrespective of any consideration as regards root-nodules, etc. Again, old nitrogenous organic matter in the soil nitrifies much more slowly than recent organic matters.

Restoring the straw of a newly grown crop is therefore very advantageous in forming nitrates.

Ammonia and nitric acid are both *absorbed by plants* by the roots. The darkness of colour of leaves is intensified with ammonia which also stimulates the growth of leaves and stems at the expense of flowers and fruits. Three to ten pounds of ammonia are found deposited by rain-water per acre per annum. Nitric and also nitrous acid are also present in rain-water, dew, fog, snow and other meteoric waters. But ozone and hydrogen peroxide convert the nitrous acid into nitric acid. From three to seven pounds of nitric acid (including the converted nitrous acid) have been found deposited per acre per annum. The total amount of combined nitrogen useful for plant life, deposited per acre per annum as ammonia, nitric acid, organic dust, etc., has been found to be on the average  $4\frac{1}{2}$  lbs. at the Rothamsted Experimental Farm in England. Continental calculations give over 10 lbs.

*Loss by drainage.*—The amount of nitrogen *washed out* from soil varies (1) according to the severity of rainfall; (2) according to the texture of soil and the nature of cultivation; (3) according to the slope; (4) according to the absorptive power and chemical composition of the soil; and (5) according to the nature of the crop growing on the soil, or whether there is any crop or not. One inch of rain-water passing out in drainage and containing only ten parts of nitrogen in one million parts of water would take away  $2\frac{1}{4}$  lbs. of nitrogen per acre valued at 1s. 6d. in England (*i.e.*, 8d. per lb.).

*Green manuring, i.e.*, ploughing in of fresh vegetable manure, not only supplies nitrifiable plant-food, but also mineral matters; and it alters the physical character of the soil, tending to make light soils heavier and heavy soils lighter. By decomposition of vegetable and animal manures (the latter decomposing more readily than the former) carbon dioxide is evolved, which indirectly helps the growth of crops by making soil particles soluble. The easiest way of supplying organic matter to soil as manure is to grow some rapidly growing and tall leguminous crop in the rainy season and to plough it in when it is in flower. This not only draws up valuable materials from the subsoil to the surface soil, but also adds to the stock of nitrates in the soil which are not washed away so readily by rain as when the land is bare or contains some short or thinly growing crop. Of all Bengal plants suitable for green manuring *dhaincha* (*Sesbania aculeata*) is, in many circumstances, the best. It is the most fast-growing and rank-growing leguminous crop in North East India, and as it grows twelve to fourteen feet high in six months (June to September), it is an excellent crop to cut and plough in at the end of August in preparation for October or November sowings. The Sibpur Farm experiments with potatoes and sugarcane have given most unmistakable evidence regarding the high value of *dhaincha* as a green-manure for these crops. It should be



remembered that the first stage of putrefaction with excess of moisture gives rise to the evolution of some  $H_2S$  gas, which is poisonous to plants. Aeration by constant cultivation from the end of August to the end of October or middle of November converts the sulphides into sulphates which are valuable as plant-food. Destruction of weeds and luxuriant plants growing by the edges of fields when they are in flower (*i.e.*, before seeding) and using them as manure, serves also the purpose of destroying a natural harbour of pests and parasites. Other crops used in other countries for green manuring are, mustard, turnips, rape, tares, lucerne, lupin, spurry, and clover. Residues of many crops and shed leaves after harvest may be considered as a kind of green-manure. In roots and stubbles, usually half of the quantity harvested is left, but in the case of leguminous crops, the residues are of equal value to the crop harvested, from a chemical or manurial point of view. Root crops (potatoes, cabbages, etc.), leave very little residue behind and are therefore more exhausting than other crops. Barley leaving little residue should be considered an exhausting crop for the surface soil. Lucerne, a perennial leguminous fodder crop, leaves as much as four tons of crop residue in the top ten inches of soil and it may therefore be regarded as a very useful crop for fertilizing soils. The residue of four tons of vegetable matter contains over 100 lbs. of nitrogen.

*Aquatic weeds.*—Of other easily available nitrogenous manures may be mentioned sea-weeds and *aquatic weeds* generally which may be applied at the rate of ten to twenty tons per acre. In fresh state they contain 70 to 80 per cent. of water and 10 to 14 per cent. of ash which includes sand. The true ash is only 3 or 4 per cent. The nitrogen varies from .15 to .5 per cent., usually about a quarter per cent. They are not so valuable as farmyard manure, containing only half the proportion of nitrogen. The value of sea-weeds, etc., is, however, greatly enhanced by the presence of shells and animals and animal remains, which raise the percentage of phosphoric acid and nitrogen. Where weeds are available in large and inexhaustible quantities, it is advisable to use them as fuel and then carefully collect the ashes for manure.

*Straw* is another readily available manure. The value depending on the proportion of nitrogen and of ash. Straws of cereals rarely contain more than .4 per cent. of nitrogen and 4 per cent. of ash. Straws of leguminous crops, however, often contain as much as two per cent. of nitrogen. Straws are more valuable as cattle food than as manures, except barley straw, which has a tendency to produce colic. Perfectly ripe straw is not so wholesome as fodder nor so valuable as manure. When too ripe, leguminous straws are poorer in nitrogen than cereal straws. Perfectly ripe straw gains in nutritive value as fodder by being stacked.

*Saw-dust* is a poor manure especially if there is much resinous matter in the wood. The saw-dust from gas-works absorbing a large proportion of ammonium sulphate is a good manure.

Sawdust improves the mechanical texture of soils, and it should be utilized wherever available.

*Leaves* of trees either ploughed in or first used as litter and then applied to fields as manure are a fairly good fertilizer. Their composition varies, but usually leaf-mould contains .5 to .1 per cent. of nitrogen, .1 to .3 per cent. of potash, and .1 to .4 of phosphoric acid. Sedges, rushes, and ferns are richer in potash. Peat is sometimes used to fertilize soils, as it is fairly rich in nitrogen and often very rich in ash constituents (5 to 20 per cent.), especially in phosphoric acid. Peat may be used in cow-houses and stables as it absorbs liquid manures well. Coconut fibre has scarcely any manurial value. When fresh, it contains only .06 per cent. of nitrogen and when dry .2 per cent. Tannery refuse also, decomposing very slowly, is a poor manure. It should be burnt and the ash used as manure. Of all vegetable manures, oil-cakes are richest in nitrogen. Rape-cake, earth-nut-cake, cotton-cake, linseed-cake and coconut-cake should be first used as cattle-food and the excrements applied as manure. Oil-cakes getting mouldy or rancid, and such oil-cakes as mustard-cake, neem-seed-cake, castor-cake and mahua-cake, should not be used as cattle-food, but as general manures, in preference to dung.

*Seeds* of all plants are richer in manurial constituents than flowers, and flowers richer than leaves, and leaves richer than stems. Rape-cake used alone for turnips and potatoes encourage too luxuriant growth of leaves. It should be used along with phosphates. Two cwt. of oil-cake is a substitute for one ton of farmyard manure and the two manures may be used mixed together. Oil-cake is more effective in moist soil and in wet weather than in dry soil and in dry weather. Rape-cake, neem-seed-cake and castor-cake are specially valuable, as they prevent the attack of some insects. Rape-cake contains  $3\frac{1}{2}$  to 5 per cent. of nitrogen,  $1\frac{1}{2}$  to  $3\frac{1}{2}$  per cent. of phosphoric acid, and two-thirds of this latter quantity of potash, the total ash being  $4\frac{1}{2}$  to  $7\frac{1}{2}$  per cent. Castor oil-cake, European mustard-cake and mahua-cake are poisonous to cattle.

*Sugar refuse*.—Sugar-cane refuse (called "megass") is a fairly good manure as it contains .5 per cent. of nitrogen. Refuse from sugar-refineries, *i.e.*, bone-charcoal containing albuminoid and other impurities, is a very good manure, especially if it is used powdered first in closets and the night-soil mixed up with this powdered charcoal used as manure. The utilisation of bone-charcoal refuse of sugar-refineries in a powdered state by municipalities and its subsequent use for cropping in trenching-grounds would be a great agricultural and sanitary improvement in places where such bone-charcoal is available.

*Coal* contains one per cent. of nitrogen which occurs in a form too inert to be of much manurial use. In process of distillation in gas works, however, about one-third of this is converted into ammonia, some into cyanogen, some into organic bases such as

aniline, a considerable portion being left in the coke, and a little is given off as free nitrogen. With the addition of sulphuric acid the ammoniacal liquor is evaporated and the residue is sulphate of ammonia. This crude ammonium sulphate of gas-works contains ammonium chloride and ammonium thio-cyanate. This last named constituent is poisonous to plants and the crude ammonium sulphate is, therefore, re-crystallised and purified before it is sold. The ammonium sulphate of commerce contains 24 to 25 per cent. of ammonia. When pure sulphate of ammonia contains 25.5 per cent. of ammonia. The ammoniacal liquor of gas works contains about 2½ per cent. of ammonia, *i.e.*, about four ounces of ammonia per gallon. Each ton of coal distilled produces 10 gallons of liquor. Besides ammonia, this liquor contains ammonium chloride, ammonium carbonate, ammonium sulphide, ammonium sulphate, cyanogen compounds, hydrocarbons, and organic bases. If gas-liquor is used for irrigating crops it must be diluted with four or five times its weight of water.

If *Ammonium Sulphate* is purchased for manure, it should be seen that it is fairly pure, *i.e.*, containing ninety-five or ninety-six per cent. of pure ammonium sulphate. The purity can be judged by the following tests:— (1) If a small quantity is heated, it should leave no residue; (2) it should be dry; and (3) it should be crystalline in appearance. It is an excellent manure for lands naturally rich in phosphates and it is profitably applied to cereals and grasses. It does not act quite so quickly as sodium or potassium nitrate. Like sodium and potassium nitrates, Ammonium Sulphate should not usually be applied to leguminous crops. For sugar-cane, it is a favorite manure.

*Sodium nitrate*, imported from Chili and hence called Chili Saltpetre, contains 15 to 16 per cent. of nitrogen. Three parts of ammonium sulphate are equal to four parts of sodium nitrate as far as nitrogen is concerned. Sodium nitrate contains more nitrogen than potassium nitrate. It gives larger increase of crops than either potassium nitrate or ammonium sulphate and it is an excellent top-dressing for cereals and grasses, but it and the sulphate of ammonia should not be used too freely without phosphatic and potassic manures. When cereals show a tendency to run too much to straw, common salt should be applied mixed up with nitrate of soda. One cwt. per acre is the usual dose both for ammonium sulphate and sodium nitrate. In England the values of ammonium sulphate and sodium nitrate are about the same, *i.e.*, £11 per ton, which is rather more than Rs. 5 per maund. We cannot expect to get either of these articles for less than Rs. 7 per maund in this country, and as potassium nitrate is on the whole a better manure, this is generally more economical for this country. The conversion of each municipal trenching-ground into a regular nitre-bed where crude saltpetre for agricultural use may be systematically manufactured for sale to cultivators, would afford a great sanitary and agricultural object-lesson to village unions and

other rural and local bodies, and the subject is earnestly put forth for the consideration of students of Indian agriculture.

*Other common nitrogenous manures.*—Of other easily available nitrogenous manures may be mentioned *blood*, which contains 3·7 per cent. nitrogen when fresh, and from five to fifteen per cent. in the state of “dried blood,” as blood is dried usually with the addition of gypsum and sulphuric acid. Blood contains twenty-three per cent. of dry matter, *i.e.*, almost as much as flesh, which contains twenty-five per cent. of dry matter and four per cent. of nitrogen. *Flesh* after boiling and drying contains 12 per cent. of water, 9 to 9½ per cent. of nitrogen and 4 per cent. of phosphates. Boiling is done to get rid of the fat. *Skins, hair, horn, and feathers* contain in their natural state 4 to 8 per cent. of nitrogen and in the dry condition about 15 per cent. Woollen rags and refuse called ‘shoddy’ are also a good manure containing 5 to 9 per cent. of nitrogen equivalent to 6 to 10½ per cent. of ammonia. Cotton and jute refuse are, however, almost useless as manure. Leather though it contains as much as 5½ to 6 per cent. of nitrogen is also useless as a manure, as the process of tanning renders the nitrogen of no value. Refuses from glue and tallow-making factories, rum and spirit factories, indigo, sugar and silk factories, are also valuable manures. All animals, as fish, frogs, snails, etc., are valuable as manure when available in large quantities. When dry, they contain 5 to 7 per cent. of nitrogen and 12 to 18 per cent. of phosphoric acid. Refuse of fishes, etc., contain about 5 per cent. of nitrogen and 5 to 30 per cent. of phosphates, and is called “fish-guano.” *Soot* is top-dressed as an insecticidal manure chiefly on cereals. Its manurial value depends on the proportion of ammonia it contains, which varies from 1 to 4 per cent., the average being about 2 per cent. Soot consists mainly of finely divided carbon with from 16 to 40 per cent. of mineral matters.

*Guano* is another nitrogenous manure which was largely used in England and America, but which we are not likely ever to make use of, as the supply has now almost entirely failed. It is applied at the rate of 2 to 3 cwts. per acre (=50 to 60 lbs. of ammonia and 100 lbs. of phosphoric acid). Two classes of guanos are distinguished. Of these, the nitrogenous guanos obtained from the dry regions of Peru, contain as much as 12 per cent. of nitrogen and 12 per cent. of phosphoric acid, and the phosphatic guano 9 per cent. of nitrogen, 32·5 per cent. of phosphoric acid, and 3 to 4 of potash. Being very variable in composition it is usually purchased on analysis. Bird’s dung and bat’s dung containing more moisture (about 25 per cent. are, weight for weight, less valuable. But dried, they are of equal value to guano (1½ to 10 per cent. ammonia and 6 to 30 per cent. phosphates). Birds living on fish yield richer manure than birds living on grains, etc.

While on this subject of nitrogenous manures, we may once more revert to the question of *utilization of sewage* and study the

methods that have been devised for making town-sewage inoffensive and less objectionable for use as manure. We have already recommended the use of dry earth, powdered charcoal and trenching with the addition of lime and the employment of the Meagher system. Green vitriol ( $\text{FeSO}_4 \cdot 7 \text{H}_2\text{O}$ ), alum and lime are in use in Europe for rendering human excreta inoffensive. In the case of urine, calcium and magnesium phosphates are used. Attempts to purify sewage by precipitation and filtration in India cannot be said to have passed the experimental stage.

Another process applied is, that of cultivating deodorising bacteria in tanks protected from sunlight through which the sewage is made to run. In going out of the covered passage which is strewn with kankar, the filtrate is perceived to be without odour, and fit for application to gardens as manure. This, the septic tank system, has been adopted largely in India.

In England it has been estimated that for every head of population 40 to 60 tons of sewage is formed per annum. This is not absolutely wasted as the fish and sea-weeds are nourished by it. These 40 to 60 tons consist mainly of water, solid and liquid excrements forming only a small proportion of the sewage. This quantity contains only about 10 lbs. of nitrogen calculated as ammonia. The conclusion drawn from experiments conducted in sewage-farms in England is, that by the use of 5,000 tons of sewage per acre 30 tons of grass may be expected, and the value of sewage has been calculated at  $\frac{1}{2}d.$  to  $1d.$  per ton. Leguminous plants are killed out in a pasture manured with sewage water. Weight for weight unsewaged grass is better fodder than sewage grass, but for equal weights of dry matter the sewaged grass which contains more nitrogen has a better nutritive value. Milk increases in quantity but is reduced in quality with sewaged grass, but cows kept on sewaged grass, if they are given some oil-cake every day thrive beautifully and give good quantities of rich milk. From 5,000 tons of sewage applied judiciously to 1 acre, about 75 maunds of milk may be expected per annum, as 30 tons of green grass would keep three cows for one year, each cow being allowed 30 seers of green grass and one seer of oil-cake per day and the average yield per cow (if a select class is kept) may be taken at 5 seers per day for 200 days per annum. The rent of the land being calculated at Rs. 10 and the value of the oil-cake (3 srs.  $\times$  365 days) at Rs. 60, and the cost of irrigation with sewage at Rs. 144 (2 men employed for pumping out the sewage with a *don* and distributing the same and also tending the cattle), the total expense may be put down at Rs. 214. The value of 75 maunds of milk at 12 srs. to the rupee comes to Rs. 250. This calculation gives some practical idea of the small value per ton of sewage and the difficulty of utilising it in places where a large capital would be required to make use of sewage, or where milk does not command a ready sale, or where land is dear. But it also shows that in favourable localities grass farms can be made to yield

large profits by the use of sewage, and the Government grass farm at Allahabad is a case in point.

Cabbages, mangolds and strawberries have been also grown successfully with sewage. Light soil, resting on sandy or gravelly subsoil is the best for sewage irrigation. Sewage water should never be sprayed or sprinkled over a crop, but always applied to the land put up in ridges, along furrows. It should not be used at the last stage of the growth of a crop.

## CHAPTER LXXXVII.

### PHOSPHATIC MANURES.

[Phosphatic minerals; Trichinopoly nodules; Bones; Boiled bones; Anima charcoal; Slag; Christmas Island phosphate; Tests for phosphates; Available phosphates; Grinding of bones without mill; Superphosphate—its manufacture; Composition of superphosphates; How valued; Why manufacture of superphosphate of no great importance for India; Estimation of monocalcium and dicalcium phosphates, Dr Dyer's method.]

*Mineral Phosphates.*—Phosphates occur in soils and rocks chiefly in the form of tri-calcium phosphate, mixed with various impurities. If it is mixed or combined with calcium chloride or fluoride it is termed *apatite*, and a very interesting find of this mineral was made some years ago in the Koderma forest, Hazaribagh,—and the mineral was put on the market at Rs. 2 per maund uncrushed or Rs. 3 in the crushed condition. It contained 61 per cent. of tri-calcium phosphate. Tri-calcium phosphate more frequently occurs mixed with calcium carbonate and silicates of iron and aluminium, and in this form it is termed rock phosphate. Large deposits of rock phosphate do not appear to occur in India, though considerable quantities are found near Trichinopoly. These are, however, of low grade, and are little use for manurial purposes. The Christmas Island phosphate is the richest found near India, containing, as it does, between 80 and 85 per cent. of tri-calcium phosphate. It has been suggested many times that this should be imported and used in India,—but no action has been taken in the matter.

*Bones*, bone-dust, bone-shavings and ivory-shavings are also very rich in phosphates. They contain from 45 to 55 per cent. of phosphates chiefly as tri-calcium phosphate, and partly also in the form of magnesium phosphate. Bones containing also  $3\frac{1}{2}$  to  $4\frac{1}{2}$  per cent. of nitrogen, 3 per cent. of calcium carbonate, and 4 per cent. of other ash (including silica), may be regarded in the light of a general manure.

*Boiled bones* (whole or dust) are richer in phosphates (45 to 60 per cent.), calcium carbonate (3 to 9 per cent.), and alkaline salts including silica ( $4\frac{1}{2}$  to 13 per cent.) than fresh bones, but they are poorer in nitrogen ( $1\frac{1}{2}$  to 3 per cent.). Steamed bone-meal is used for the manufacture of bone-superphosphate.

*Animal charcoal* is still richer in phosphates (64 to 87 per cent.) but poorer in the other substances. Bone-ash contains as much as 77 to 88 per cent. of phosphates and 4 to 6 per cent. of calcium carbonate, but it contains no nitrogen.

The *basic slag* produced in the manufacture of steel by the basic Bessemer process is another important source of phosphatic manure, sometimes containing the equivalent of as much as 78 per cent. of tri-calcium phosphate.

The *detection of phosphoric acid* in rocks and minerals is of considerable importance. It can be done by finely pulverising a tolerably large sample of the substance, digesting it in nitric acid, filtering off the solution and treating it with ammonium molybdate. If phosphoric acid be present, a yellow precipitate will follow, and the precipitation which usually takes place very slowly, may be accelerated by frequent stirring with a glass rod.

When a substance contains more than three per cent. of phosphoric acid, its presence may be detected in a dark room by the flame test. A little of the mineral, or substance to be tested, is powdered and made into a stiff paste with water. Then a heated loop of platinum wire is to be dipped into this paste and returned to the flame of the spirit lamp (or blow-pipe). If phosphates are present, a characteristic dull green flame will be given out, which in a dark room cannot be mistaken. A more certain reaction is obtained if the mineral has been previously treated with hydrochloric acid.

*Export of Bones.*—Phosphatic manures are of very great importance as though the available phosphates in Indian soils are probably not deficient, and though there is no immediate possibility of Indian soils getting barren for want of phosphates, yet the total amount of phosphates in Indian soils is relatively so small and the denudation of phosphates by the export of bones, grains and oil-seeds, is so persistent, that the question of supplying phosphates to soils by way of fertilizers must sooner or later assume the most serious importance.

*Bones for fruit trees.*—The most readily available source of soil fertilization so far as phosphates are concerned, is bone. The effect of bones used in large pieces is slow, but they should be applied in this state, when fruit trees are planted. It is curious that the Nepalese have the custom of putting a number of bones in each pit made for planting fruit trees and they say this makes the fruit sweeter for all time. It is a right notion, and if this custom of stowing away bones under fruit trees had been widely followed, bones would not have lain neglected and been carried away from India to other countries for purposes of manure to anything like the present extent.

Of the phosphates in bones, two per cent. occurs as magnesium phosphate and the remainder as calcium phosphate. Bones are steamed or boiled for making glue and gelatine. The greater part of the organic matter is removed in this process. Steamed and

boiled bones, though richer in phosphates contain less nitrogen ; but on the whole, they are preferred for manure. Burnt bone or animal-charcoal is used in sugar-refineries. The refuse animal-charcoal of sugar-refineries is a superior general manure. Bone-dust, bone-shavings and bone and ivory turning are of equal manurial value. Five to six maunds of finely powdered bones per acre is a good fertilizer for grass lands. Bone-meal can be obtained from Messrs. Graham & Co. and Messrs. Mackillican & Co. of Calcutta.

*Crushing without mill.*—Bones, in country places, where crushing mills are not available, may be reduced to powder by means of caustic lye (solution made out of ashes), quicklime or freshly calcined wood ashes. A simple plan is to pack the bones layer by layer, with freshly calcined wood ashes, in a barrel, and keep the mixture moistened for some months. Casks or old packing cases may be kept in constant use for this purpose on a farm, and bones and ashes may be put layer after layer as they are collected.

A quicker method is to boil the bones in an iron or copper boiler with strong caustic lye. The proportion of bones and lye to be used is roughly fifteen parts by weight of bones to five parts by weight of caustic soda or seven parts by weight of caustic potash dissolved in fifteen parts by weight of water. The boiling should be done for two or three hours. But even without boiling the bones would become disintegrated, being simply kept in the caustic liquor for about a week.

Another method of softening bones is by mixing them in heaps with quicklime and loam. A layer of loam four inches deep is first spread, and on this is put a layer of bones six inches deep and above this a layer of quicklime three inches deep. The layers of loam, bones and quicklime are repeated until the heap reaches a convenient height, when it is covered all over with a thick layer of earth. Holes are then bored in the heap from the top and water poured down them to slake the lime. The mass will become hot and remain so for two or three months, after which, the bones will become friable, and the whole heap may then be mixed up and spread as manure on land.

Another method of bringing bones into a fine state of division without the help of a mill is to mix them with half or a third of their weight of clay or earth, saturating the mixture with urine, placing it in a pit and covering the pit up with two or three inches of earth. In two or three weeks the bones get disintegrated and the addition of urine makes them a better general manure. Fermented bones act more readily in the soil, and they are more valuable than bone-meal for light soil.

*Superphosphate.*—In Europe the rapidity of the action of bones in soil is increased by treatment with sulphuric acid, by which tri-calcium phosphate is rendered soluble being converted into monocalcium phosphate. Bones, bone-ash and mineral



phosphates powdered and treated with sulphuric acid go to form the manure known as 'superphosphate' or superphosphate of lime. The same process may be used for converting mineral phosphates of all kinds into superphosphate.

More than half a million tons of superphosphate are made annually in England alone for manurial purposes. The reaction that takes place may be expressed by the formula  $\text{Ca}_3\text{P}_2\text{O}_8 + 2\text{H}_2\text{SO}_4 = \text{CaH}_4\text{P}_2\text{O}_8 + 2\text{CaSO}_4$ . The sulphuric acid first decomposes the calcium carbonate present. Manufacturers therefore do not like the presence of much calcium carbonate in the minerals used.

The sulphuric acid used in the manufacture of superphosphate is 'chamber acid,' which is the cheapest kind of commercial sulphuric acid. Chamber acid contains about 69 per cent. of  $\text{H}_2\text{SO}_4$ . 100 parts of pure tri-calcium phosphate require 91 parts of chamber acid to act on it, while 100 parts of calcium carbonate require as much as 140 parts: 100 parts of oxide of iron require 262 parts and 100 parts of alumina require as much as 405 parts of chamber acid. The freer therefore the mineral is from calcium carbonate, oxide of iron and alumina the better it is.

Superphosphate is *manufactured* in the following way:—The raw steamed bones or mineral phosphates are finely powdered with a powerful mill. This powder is placed in a closed vessel or chamber which is called a mixer, the necessary quantity of sulphuric acid being dripped into the chamber by slow degrees from a tank above it. The gases given off pass out through a long tube where they gradually condense. As some of the gases are dangerous to health, this condensing of the gases or vapours passing out is very necessary. The gas given off is chiefly carbon dioxide, but hydrofluoric acid, silicon fluoride and iodine vapour are also given off. As the acid is gradually let into the powdered mineral, a strong shaft provided with rakes keeps the powder continually agitated. When the proportional quantity of acid has been used up and the mixing completed, the contents of the chamber (which is usually  $\frac{1}{2}$  a ton to 1 ton) is allowed to fall into a brick or stone-ware chamber known as the 'den,' which, when full, is closed. The mass is allowed to remain there until its temperature is reduced, the rise of temperature being due to the mixing of the phosphates with the acid.

The contents of the 'den' are afterwards dug out and passed through a 'disintegrator,' which renders the manure into a powdery condition, in which state it is sold. The question of using superphosphate in this country is beyond the pale of practical agriculture, if sulphuric acid has to be purchased from abroad. But a sulphuric acid manufactory can profitably make superphosphate as well, if a market for this manure can be created, in any part of the country. Superphosphate manufacturing has been actually commenced in one of the islands of the Malay Archipelago, where phosphatic deposits of great purity have been discovered.

Superphosphate, sulphate of ammonia, and other concentrated manures are already manufactured by Messrs. Waldie & Co. of Calcutta; and also by Messrs. T. Stanes & Co., of Coimbatore.

Superphosphate is usually mixed with blood, soot and refuse, vegetable and animal matter of all kinds, or with nitrate of soda or sulphate of ammonia to convert it into a general manure. The composition of superphosphate varies very much according to the mineral used in its manufacture. Ordinarily superphosphate contains 25 to 28 per cent. of soluble phosphates, but it is possible to have a product with as much as 45 per cent. of soluble phosphates calculated as tri-calcium phosphate. The soluble phosphate of the manufacturer is, on the English system, always expressed in the terms of tri-calcium phosphate which has been rendered soluble. 20 per cent. of soluble phosphates mean 20 per cent. of tri-calcium phosphate made soluble which is actually 15 per cent. of monocalcic phosphate ( $\text{CaH}_4\text{P}_2\text{O}_8$ ).

Superphosphate is also sold at so much "per unit," unit meaning 1 per cent. of "soluble phosphate" per ton. The insoluble phosphates are not valued in purchasing mineral superphosphate after analysis, but in purchasing bone superphosphate the insoluble phosphates are also valued.

The following table gives the percentage compositions of the principal varieties of superphosphate :—

|                                      | Bone super-phosphate | Super-phosphate from bone-ash. | Mineral super-phosphate. | Concentrated super phosphate |
|--------------------------------------|----------------------|--------------------------------|--------------------------|------------------------------|
| Moisture .. ..                       | 8 %                  | 6 %                            | 15 %                     | 13 %                         |
| Organic matter and combined water .. | 21 "                 | 5 "                            | 12 "                     | 6 "                          |
| Mono-calcium phosphate (soluble) ..  | 15 "                 | 26 "                           | 18 "                     | 30.1 "                       |
| Tri-calcium phosphate ..             | [20 "]               | [34.5 "]                       | [28.3 "]                 | [40 "]                       |
| Insoluble phosphate ..               | 15 "                 | 5 "                            | 6 "                      | 2 "                          |
| Calcium sulphate ..                  | 36 "                 | 54 "                           | 42 "                     | 44 "                         |
| Alkaline salts, etc. ..              | 1.9 "                | 1 "                            | .5 "                     | .4 "                         |
| Silica .. ..                         | 3 "                  | 3 "                            | 6.5 "                    | 4.5 "                        |
| Ammonia .. ..                        | 2.5 "                | .3 "                           | <i>Nil</i>               | <i>Nil</i>                   |
|                                      | to 3 "               |                                |                          |                              |

When soluble phosphates cost 3s. per unit (i.e., for 1 per cent. per ton), a ton of superphosphate containing 40 per cent. of soluble phosphate (tri-calcium phosphate made soluble) would be valued at  $40 \times 3s. = \text{£}6$ .

Superphosphate kept for a long time is reduced in its solubility in water by five per cent. or more of the total phosphates. This reduction takes place chiefly in superphosphates containing alumina and oxide of iron. The ferric and aluminic phosphates and the

tri-calcium phosphates formed are insoluble in water. Dicalcium phosphate ( $\text{Ca}_3\text{P}_2\text{O}_8 \times \text{CaH}_4\text{P}_2\text{O}_8 = 2\text{Ca H}_4\text{P}_2\text{O}_8$ ) is not altogether insoluble in water. In the precipitated phosphates of glue manufactures, gelatine works, the phosphates occur as dicalcium phosphate. This form of phosphate occurs in some guanos also. It is more soluble in water charged with carbon dioxide and in saline solutions. Dicalcium phosphate therefore is found to be of equal manurial value with monocalcium phosphates in certain soils. In sandy soils and soils containing little lime, dicalcium phosphate (called also 'reduced' or 'retrograde' phosphate) gives a better result than monocalcium phosphate, and even tri-calcium phosphate in a finely divided state is sometimes found to give a better result in such soils than the soluble monocalcium phosphate. The reason for this is, that when soluble phosphate comes in contact with soil, the phosphate is immediately precipitated (but not in sandy soils or in soils deficient in lime) in a gelatinous form, in which state it is extremely soluble, though not easily washed out, and it gets diffused through the soil very easily and quickly. It gets gradually reduced and converted into dicalcium phosphate, afterwards into tri-calcium phosphate and eventually into phosphates of iron and aluminum. But in sandy soils and those containing little lime, the gelatinous precipitation does not take place at once, and soluble phosphates are apt to get washed away before complete precipitation takes place. In such soils therefore it is best to apply phosphates in a less soluble form. Soils poor in lime treated with superphosphate may get too acid, and lose in absorptive power and capacity for nitrification. Five maunds of superphosphate per acre is the best quantity to use for root-crops and two to three maunds for cereals. A crop of 150 maunds of potatoes takes up only about 10 lbs. of phosphoric acid while 5 maunds of bone-dust adds about 90 lbs. of phosphoric acid to the soil.

*Effect of phosphatic manures.*—Phosphatic manures hasten the development of young plants, make them so healthy that they resist the attack of insect pests which thrive better on weakly plants. They also hasten maturity, increase the flowering and fruiting tendencies of plants, and assist in the elaboration of sugar and starch.

*Available phosphates.*—According to Dr. Dyer of London, there should be at least 300 to 400 lbs. of available phosphoric acid per acre within a depth of nine inches, *i.e.*, .01 per cent. of phosphoric acid soluble in a 1 per cent. solution of citric acid. Most Indian soils have more than this. Total phosphoric acid may be determined by the use of strong hydrochloric acid which dissolves the whole of lime and phosphoric acid, though only a portion of the potash. A soil containing 700 or 800 lbs. of available phosphoric acid per acre within the first nine inches would probably show 2,700 to 3,000 lbs. of total phosphoric acid. Of the 700 lbs. of available phosphoric acid a crop of 1,000 lbs. of wheat or rice per acre removes from the soil only 7 lbs. of phosphoric

acid in either case. The straw in each case removes another 3 lbs. of phosphoric acid which is returned to the soil in one form or another. In the case of paddy 3 lbs. per acre go to the husk, 4 lbs. to the rice, and 3 lbs. to the straw, the total quantity being the same as in the case of wheat, though the outgoings, if the husk and the straw are returned to the soil are less in the case of paddy. The gain of phosphoric acid by silt-deposition and irrigation is a good deal more than the outgoings and it is only where no silt-deposit or irrigation takes place that the question of recouplement of phosphoric acid in Indian soils need be considered. So far, phosphatic manures have given no decisive results in some experimental farms of India, and the value of manures should be principally judged from the proportion of nitrogen they contain. Well-water used for irrigation purposes is much richer both in phosphoric acid and nitrogen than rain or canal-water. Rain-water contains no phosphoric acid and only four parts of nitrogen in ten million parts. Clear canal-water usually contains only two parts of nitrogen and ten parts of phosphoric acid in ten million parts, and muddy canal-water, four parts of nitrogen and twenty parts of phosphoric acid in ten million parts, while well-water may contain one hundred and fifty parts of nitrogen and one hundred parts of phosphoric acid in ten million parts.

## CHAPTER LXXXVIII.

### POTASH MANURES.

[Felspars, chiefly orthoclase, and mica; Zeolites; Admixture of lime and felspar; Other potassic minerals; Test for potash; Kainit; Ashes; Sugar-refuse; Adaptability of potash manures to root-crops and pulses; Silt; Irrigation-water; Saltpetre; Urine,—specially of poorly fed cattle; Ashes should be sprinkled over compost; Reclamation of saline soils; Potash in different parts of plants; Physiological actions of potash; Dr. Dyer's method of estimation of available potash; Available nitrogen; Percentage composition of principal manures; Manurial substances removed by different crops.]

*Mineral potash.*—Potash occurs in nature in felspars and mica, which enter into the composition of every soil. The pink coloured orthoclase felspar which is so common in Indian granites, is the richest in potash. In felspars, potash is contained in a more soluble form than in mica, and its solubility is enhanced by admixture with lime. Zeolites also contain potash and being more soluble than ordinary felspar (which they resemble in composition) are good fertilisers, and they are abundantly present in some soils. Potassium sulphate ( $K_2SO_4$ ), potassium chloride or sylvine (KCl), potassium nitrate, and kainit also occur in nature.

In Europe, potash manures are used chiefly in the form of kainit which is obtained from Prussia, where it occurs as a natural

deposit at Stassfurt. The composition of kainit is represented by the formula  $K_2SO_4 \cdot MgSO_4 \cdot MgCl_2 \cdot 6H_2O$ . Common salt often occurs in kainit as impurity. Ordinary kainit contains 13 to 15 per cent. of potash and calcined kainit 17 to 18 per cent. Concentrated potash salts are made out of this. Other sources of potash manure are the mother-liquor from sea water after the extraction of common salt, and vegetable ashes.

*Organic potash.*—The commonest potash manure is ashes of all kinds. Liquors obtained by distillation of beet and extraction of sugar from beet or sugar-cane, are rich in potash. Crude *gur* contains a great deal of potassium nitrate and the refuse of sugar factories is therefore rich in potash. Wood-ashes contain five to seven per cent. of potash : straw-ashes less. Wool and hair are particularly rich in potash. Ashes obtained from all tender and green parts of plants are, as a rule, rich in potash, *e.g.*, ashes of sun-flower stalks, of plantain and other tender leaves, of maize-stalks, of sugar-cane refuse, of tobacco leaves and midribs, etc. All such ashes or substances should be carefully stored in the manure-pit. Potash manures are particularly helpful to the growth of leguminous crops, leafy crops, root-crops, *e.g.*, *yams*, *ôl*, *kachu*, potatoes, gram, groundnuts, cabbages, etc. Silt, especially fine dark coloured silt, brings so much potash in an available state that no potash-manure need be applied to any land which is occasionally renovated with silt. Irrigation water also brings a certain amount of potash, as it contains about ten to twenty parts of potash in a million parts. Rain-water, of course, contains no potash. Potassium nitrate and cattle urine are the best potash manures ordinarily available. The urine of poorly fed cattle is richer in potash than the urine of well fed cattle, because the former feed principally on grass and straw, which contains a large proportion of potash than better food materials.

*Compost.*—In making compost it is better to use ashes than lime and salt. The object of adding alkaline substance to the manure is to hasten its decomposition. As potash is in itself a more valuable food-substance than lime or soda, ashes containing some potash in addition to lime and soda are to be preferred. The power of potash to make the nitrogen of the soil available for plants, is also well known, and the application of potash manures is therefore of great indirect value. Ashes also increase the capillarity of the soil, and Lorain observed that the ground where log-heaps had been burned was moister than the surrounding soil. Indeed excess of alkali is often outwardly recognizable by the puddy character of clay which is difficult to drain. Hilgard says, "soils impregnated with alkaline carbonates may generally be recognised by their extreme compactness and refractoriness under tillage, and by the fact that they are apt to form 'low spots' in the general surface of non-alkaline land, *i.e.*, places where turbid clay water, dark with dissolved humus will lie for weeks after the higher land appears dry."

The potash in the soil occurs chiefly in the form of hydrated double silicates or hydrated double humates of potash and alumina. Had it not been for the double silicates, the potash in the soil would have been washed out and carried into the sea. It is because soda is less readily retained than potash by these double silicates, that the sea-water is charged chiefly with sodium chloride washed out from soils instead of potassium chloride. Sodium chloride is dissolved out from the soil and carried away to the sea by the water of percolation more freely than any other salt. This fact makes it so easy to reclaim saline soils like those of the Sunderbans. In the decomposition and disintegration of rocks, soda salts are most readily parted with and washed away into the sea, potash being more or less retained by the soil by absorptive action at the expense of soda salts, which are the first to be washed away. In the natural condition, for instance, a piece of basalt may contain  $1\frac{1}{2}$  per cent. of potash and  $7\frac{1}{2}$  per cent. of soda, but the same basalt after decomposition as soil may show equal proportions of potash and soda.

Potash does not accumulate so much in fruits and seeds as in straw and leaves which are returned to the soil in one form or another. In a well managed farm, therefore, whence grain and animals only are sold, potassic manures will not be found of much use. But that certain crops, such as root-crops, especially beet, potatoes and tobacco are benefited by potash manure, is a matter of universal experience. It is only where the crops sold are of a soft kind, such as fodder crops, beet, mangold, carrots, cabbages, turnips, onions, potatoes, tobacco, or where straw is systematically sold, that the need of potash manures becomes felt in course of time, and these are best applied in the form of ashes. Sun-flower stalks, pea and bean stalks and maize and *juar* stalks being particularly rich in potash, these should not be neglected but carefully put in manure heaps in their bulky state or converted into ashes, and the ashes applied to land mixed up with dung and other vegetable manure as compost. Seventeen to twenty pounds of potash can be obtained from 1,000 lbs. of dry sun-flower, pea bean, *juar* or maize stalks.

Potash accumulates more in the extremities of plants, *i.e.*, green leaves and twigs, than elsewhere. 1,000 lbs. of wood contains only from half a pound to one and a half pounds of potash. Ordinary cereal straw, though rich in potash, contains it chiefly in the form of silicate of potash which is not readily soluble in water. The ashes of ordinary cereal straws are therefore not such good potash manures as ashes of maize stalks, sun-flower stalks and leguminous crop straws. Tobacco stems divested of leaves are extremely rich in potash. The desiccated stalks contain about 5 per cent. of potash, 0.7 per cent. of phosphoric acid and 3.5 per cent. of nitrogen, of which a small quantity is in the form of nitrate. The refuse tobacco stalks and midribs are therefore a high class fertilizer and may be looked upon as a special potash

manure and also as a general manure. Ashes from cotton-seed husk are also a first class potash manure. They contain 18 to 30 per cent. of potash in a very soluble condition, also 5 to 10 per cent. of phosphoric acid of which  $1\frac{1}{2}$  to 2 per cent. is soluble in water. Lime-kiln ashes contain only 2 per cent. of potash and less than 1 per cent. of phosphoric acid. Brick-kiln ashes contain only  $1\frac{1}{2}$  per cent. of potash. These and ordinary wood-ashes are therefore not nearly so valuable as ashes derived from burning twigs, leaves and green or soft parts of plants, or from cattle-dung. In applying ashes as manure to crops, this very important difference must be borne in mind. The greater alkalinity is desirable, not from a mere manurial point of view, but from the fact that it is the alkalinity which enables the ashes to rot weeds and to ferment peat. It should be noted that the Stassfurt salts of potash, so largely used in Europe as potash manure, are inferior to ordinary wood-ashes for manurial purposes, and there is little occasion for us in India to look for kainit, and other Stassfurt salts. The explanation seems to be that the sulphate and chloride of potash of Stassfurt are devoid of the alkaline quality of carbonate of potash which is the effective agent in ashes obtained from wood, branches, leaves, etc. But merely as a manure or plant-food. nitrate of potash is the best potash manure to use. For potatoes, tobacco, and beet, nitrate of potash is now largely used in Europe and America, and we should all the more readily use it both as a nitrogenous and as a potash manure, as it is a cheap manure for the price at which it can be had in India.

*Physiological action of potash.*—Potash plays certain very important parts in vegetable physiology and these may be mentioned here :—

(1) It has been found to be a means of enabling starch to move from one part of the plant to another. This is one reason why potash manures are found particularly adapted for *yams*, *ôl*, potatoes and other root-crops which are valued for their starch. The potash manure helps the freer circulation of starch from leaves to roots.

(2) Potash manures are helpful to fruit formation, especially formation of fruits containing sour juices, *viz.*, fruits containing citric, malic, tartaric or oxalic acid. In most cases these acids are found combined with potash. Jails in Bengal are required to grow lime trees. At Berhampore jail there were hundreds of lime trees that had never borne fruits, although they were several years old. The jailor was advised to apply ashes and bones. As there was objection on the part of the jailor to the using of bones, ashes and mustard-cake were applied, after the plants were dug up all round. The result was a luxuriant growth of fruit at the next season. Phosphates have the power of intensifying flowering and fruiting tendencies of plants. Hence the advice of applying bones also. A mango tree in Malda that had never fruited was dug all round and bones put into the ditch and the

ditch covered up. The result was the fruiting of the tree the next year.

(3) It has been noticed that tobacco leaves charged with potash salts or vegetable acids burn readily, and in a manner quite different from leaves containing an excess of chlorides. Hence potash salts (not in the form of chlorides but in that of nitrates and sulphates) have been found very appropriate manures for cigar-making tobacco. The presence of much carbonate of potash in tobacco ash is an indication that considerable quantities of organic compounds or nitrate of potash are confined in the leaves. When subjected to heat, the organic potash salts swell up, so that the charcoal is left in a spongy, easily combustible condition such as we see when a good cigar is burning, the ultimate product of combustion being carbonate of potash.

*Estimation of available phosphoric acid and potash.*—Soils are ordinarily analysed for the estimation of the total nitrogen, phosphoric acid, potash and lime, there are in them. For the estimation of available phosphoric acid and potash, a fairly satisfactory method has been devised by Dr. Dyer of London. A weight of air-dried soil corresponding to 200 grammes of completely dry soil is taken, and treated in a Winchester quart bottle with two litres of distilled water, in which 20 grammes of pure citric acid had been dissolved (*i.e.*, with 2 litres of 1 per cent. solution of citric acid). The soil is left in the solution for a week, during which time it is frequently agitated. At the end of this time the solution is filtered, and a portion of solution corresponding to 50 grammes of soil is taken for the determination of dissolved potash and a like quantity for the determination of dissolved phosphoric acid. The filtrates are evaporated and ignited in platinum crucibles, and the potash and the phosphoric acid in the residue determined in the ordinary way.

From a series of experiments Dr. Dyer has concluded that a soil containing less than .01 per cent. of available phosphoric acid is in need of soluble phosphatic manures, and a soil containing less than .005 per cent. of potash is similarly in need of soluble potash.

*Available Nitrates.*—It is not of much practical use determining the available nitrates present in the soil, as they vary from day to day specially in the rainy season. It would be of greater importance to determine the nitrate-producing power of the soil, but this is not a purely chemical question, but a chemico-physico-biological one, and analysis can be of little help in such a question. Yet the determination of the total nitrogen is of some use as giving some indication of the permanent value of the soil. It may be assumed, however, that all except virgin soils are benefited by the application of soluble nitrogenous manures. Paddy fields at the foot of a hill, or at a lower elevation than a forest, and fields where there is an annual deposit of food-supplying silt, need no manuring.



The percentage of nitrogen (N), and phosphoric acid ( $P_2 O_5$ ) and potash ( $K_2O$ ) in different manures can be judged from the following tables :—

|   | N                    | $P_2O_5$                                  | $K_2O$          |
|---|----------------------|---|-----------------|
| (1) Ammonium Sulphate                                 | 20%                  | Nil                                       | Nil             |
| (2) Sodium Nitrate ..                                 | 15½ „                | Nil                                       | Nil             |
| (3) Potassium Nitrate                                 |                      |   |                 |
| (Crude) ..  | 2 to 13 „            | Nil                                       | 7 to 40%        |
| (Pure) ..   | 14 „                 |   | 39 0 „          |
| (4) Street Sweepings {                                | 0 to .5 „ }          |   |                 |
| (5) Fresh Cattle dung {                               | say .25 „ }          |   | .25%            |
| (ordinary cultivators') ..                            | 27 „(Lime .28%)      | .18 „                                     | .30 „           |
| (6) Well fed cattle dung..                            | .35 „                | .14 „                                     | .18 „           |
| (7) Rotten & partly dried farmyard manure ..          | .9 „                 | .17 „                                     |                 |
| (8) Cattle urine ..                                   | .56 „                | .02 „                                     | 1.13 „          |
| (9) Horse dung ..                                     | .45 „                | .32 „                                     | .35 „           |
| (10) Do do. with urine and litter, rotten hand dry .. | 1.45 „               | .21 „                                     | .52 „           |
| (11) Horse urine ..                                   | 1.50 „               | .01 „                                     | 1.60 „          |
| (12) Poudrette (Poona) ..                             | .9 „                 | .1 „                                      | .2 „            |
| (13) Poudrette (Cawnpur)                              | .6 „                 | .5 „                                      |                 |
| (14) Sheep dung ..                                    | .7 „                 | .5 „                                      |                 |
| (15) Sheep urine ..                                   | 1.30 „               | .02 „                                     | 2.50 „          |
| (16) Fish manure ..                                   | 6.8 „                | 6.0 „                                     | .7 „            |
| (17) Droppings of domestic fowls ..                   | .55 „                | .54 „                                     | .95 „           |
| (18) Bones ..   | 3.4 „ (Lime .28%)    | .21 „                                     | Trace.          |
| (19) Dissolved bones ..                               | 2.4 „                |   | Trace.          |
| (20) Castor-cake (Bengal) {                           | 6 to 8 „ average 7 „ |   |                 |
| (21) <i>Til</i> cake ..                               | 4.7 „                | 3 to 20 (soluble)%<br>20 to 3 (insoluble) | 2.6%<br>9 „     |
| (22) <i>Mohua</i> cake ..                             | 2.5 „                | (average 2.9)                             | 1.9 %<br>.93 „  |
| (23) Safflower cake ..                                | 5.8 „                |   | 1.9 „           |
| (24) Earthnut cake ..                                 | 7.6 „                |   | .9 „            |
| (25) Coconut cake ..                                  | 4.5 „                |   | 1.5 „           |
| (26) Poppy cake ..                                    | 7 „                  |   | 3 „             |
| (27) Decorticated cotton cake ..                      | 6 to 7 „             |   | 3 to 4 „        |
| (28) Rape cake ..                                     | 5½ „                 |   | 2 to 3 „        |
| (29) Linseed cake ..                                  | 4½ to 5 „            |   | 1½ to 3 „       |
| (30) <i>Kankar</i> ..                                 | Nil                  | (Lime 50 to 80%)                          | Trace           |
| (31) Silkworm droppings ..                            | 1.44%                |   | .25 %<br>.11 %  |
| (32) Powdered dry chrysalid, (Filature refuse)        | 7.47 „               |   | .98 „<br>.45 „  |
| (33) Bamboo leaves ..                                 | .66 „                |   | .01 „<br>.35 „  |
| (34) Paddy straw ..                                   | .63 „                |   | .11 „<br>.85 „  |
| (35) Wheat straw ..                                   | .48 „                |   | .22 „<br>.63 „  |
| (36) Barley straw ..                                  | .64 „                |   | .69 „<br>1.07 „ |
| (37) Maize straw ..                                   | .48 „                |   | .38 „<br>1.64 „ |
| (38) Fresh grass ..                                   | .54 „                |   | .15 „<br>.46 „  |
| (39) <i>Nil siri</i> (Indigo refuse)                  | .63 „                |   | .92 „<br>.47 „  |
| (40) Dung cake—( <i>Ghuntia</i> )                     | 1.48 „               |   | .54 „<br>.65 „  |
| (41) Dry and rotton tank weeds ..                     | 1.64 „               |   | .42 „<br>1.77 „ |

The amounts of Phosphoric acid, Nitrogen and Potash removed from one acre by various crops (bumper crops) are shown below.

| Crops.                              | Grain.                  | Straw, etc.                  | Chaff.        | P <sub>2</sub> O <sub>5</sub> | N    | K    |
|-------------------------------------|-------------------------|------------------------------|---------------|-------------------------------|------|------|
|                                     |                         |                              |               | lbs.                          | lbs. | lbs. |
| Rice ..                             | 2,676 lbs.              | 2,677 lbs.                   | ..            | 16.3                          | 26.2 | 28.1 |
| Wheat ..                            | 35 bushels=2,100 lbs.   | 2,700 ,, ..                  | 300 lbs.      | 24                            | 59   | 31   |
| Barley ..                           | 40 bushels=1,920 ,,     | 2,300 ,, ..                  | 390 ,,        | 21                            | 46   | 38   |
| Oats ..                             | 60 bushels=2,400 ,,     | 2,900 ,, ..                  | 275 ,,        | 22                            | 55   | 62   |
| Maize ..                            | 50 bushels=2,800 ,,     | 4,100 ,, ..                  | 950 ,,        | 31                            | 67   | 80   |
| B u c k -<br>wheat.                 | 30 bushels=1,800 ,,     | 2,200 ,, ..                  | (cobs),<br>.. | 30                            | 35   | 9    |
| Potato ..                           | 200 bushels—5 tons..    | 1,450 ,, ..<br>(haulms)      | ..            | 21                            | 46   | 74   |
| Beet ..                             | 15½ tons ..             | 3 tons ..                    | ..            | 32                            | 69   | 143  |
| M a n g e l<br>wurzel.              | 22 tons ..              | 6 tons ..                    | ..            | 46                            | 150  | 264  |
| Grass ..                            | ..                      | 2½ tons (dry hay)            | ..            | 23                            | 83   | 85   |
| G r e e n<br>m a i z e<br>(fodder). | ..                      | 11½ tons ..                  | ..            | 46                            | 85   | 164  |
| Lucerne..                           | ..                      | 8 tons (=2 tons<br>dry hay)  | ..            | 26                            | 113  | 71   |
| Green sor-<br>ghum.                 | ..                      | 15 tons ..                   | ..            | 24                            | 121  | 153  |
| Sugar-cane                          | ..                      | 20 tons ..                   | ..            | 15                            | 153  | 44   |
| Cotton ..                           | 750 lbs. (seeds) ..     | 250 lbs. (lint) ..           | ..            | 9                             | 26   | 10   |
| Tobacco ..                          | 1,600 ,, (leaves) ..    | 1,300 ,, (stems,<br>etc.) .. | ..            | 23                            | 89   | 103  |
| Cabbage..                           | 31 tons (heads only).   | ..                           | ..            | 88                            | 150  | 360  |
| Onions ..                           | 1½ tons ..              | ..                           | ..            | 37                            | 72   | 72   |
| Oranges..                           | 20,000 lbs. (fruits) .. | ..                           | ..            | 16                            | 24   | 103  |

## CHAPTER LXXXIX.

## CALCAREOUS MANURES.

Mineral sources ; Occurrence in India ; Effects of this manure ; Dangers of using it ; Application ; Marling ; Silicate of Calcium ; Lime in farmyard manure ; Solubility greater in water charged with carbon dioxide ; Unslaked lime ; Magnesia and soda ; Occurrence of manurial constituents in irrigation waters.]

*Mineral Sources.*—Marble, chalk, dolomite and *bankar* (or *ghuting*) are the commonest minerals containing lime. Limestone rocks are rarely pure calcium carbonate (CaCO<sub>3</sub>). They usually have some magnesium carbonate (MgCO<sub>3</sub>), and also clay, silica, iron and organic substances, combined with them. When a limestone contains more than twenty-three per cent. of magnesium carbonate it is called dolomite. When it contains fossil remains of animals, it has a certain proportion of calcium phosphate combined with it. It occasionally occurs in a pure crystalline state, as calcite or calcspar. As stalactite and stalagmite it is found deposited by springs. Marble and chalk are also nearly pure calcium carbonate. Limestones contain fossils more often than dolomites, and they are more easily scratched, and they effervesce more readily with hydrochloric acid. Limestones are found in all geological formations, as crystalline limestones and marbles in old formations, as chalk in the

middle age of the geological era, and as *kankar* or limestone nodules in alluvial regions. Limestone rocks are often associated with gypsum, the former undergoing a local conversion in contact with decomposing iron pyrites ( $\text{FeS}_2$ ). Where gypsum occurs, rock-salt may also occur.

Marble, dolomite and *kankar* occur in almost all the districts of the Madras Presidency, in the Khasia and Jaintia hills in Assam; in the Sambalpur, Raipur, Jubbulpore, Nagpur and Wardha districts of the Central Provinces; in Kathiawar in the Bombay Presidency; and in Baroda, Hyderabad, Mysore, and Burma. Kathiawar marble is used even in Calcutta for building purposes. The best limestones are found in the north of Jubbulpore and in the Vindhyan range. The Makrana marble quarries of Rajputana are very famous.

The production of marble in the Sonthal Parganas is about 7,000 tons per annum; in Monghyr, about 28,000 tons; in Mozufferpore, about 13,000 tons. Cuttack, Balasore and Manbhumi also produce some. Singhbhum, Ranchi and a few other western districts also contain limestone rocks. In Mozufferpore there are some *kankar* quarries also, the annual outturn of which is about 13,000 tons. In Monghyr the annual outturn of *kankar* is estimated at 28,000 tons and in Manbhumi at 40,000 tons. *Kankar* lime is also produced largely in Cuttack, Balasore, Birbhum, Burdwan, Midnapur and Murshidabad.

Lime as a mere plant-food is not of much consequence, as every soil contains far more lime than can be used up by thousands of crops. As plant-food, shells and limestones rich in animal remains and containing calcium phosphate and nitrogen are the best manures to use. In the district of Pertabgarh in Oudh, the cultivators use an argillaceous *kankar* as manure. As plant-food this is a better substance to use than pure lime.

If a soil to the depth of 1 ft. weighs 3,250,000 lbs. per acre and if it contains only 1 per cent. of lime, it will have as much as 3,250 lbs. of this constituent. But a crop of 1,200 lbs. of wheat and 2,000 lbs. of straw contains only 6 or 7 lbs. of lime, and of 600 lbs. of peas and 1,200 lbs. of pea straw only 28 and 29 lbs. respectively. The farmyard manure returned to the soil, if properly rotten, may contain as much as 2 per cent. of lime, *i.e.*, if only one ton of rotten manure is applied per acre it would add 40 lbs. of lime to the soil, which is more than sufficient for the requirements of one single crop. 100 lbs. of bone meal contains about 27 lbs. of lime, and 100 lbs. of crude gypsum refuse of soda-water factories, as much as 30 lbs.,—quantities sufficient for supplying lime to almost any crop.

*Action of lime.*—It is not, however, by way of direct supply of food to plants that liming proves of benefit to the soil. Liming alters the texture of the soil either for good or for evil. In some soils it acts as a mortar and renders it hard, especially if slaked lime is applied as a thick, smooth paste on soil in hard condition.

In other soils, *e.g.*, in peat, constant liming may interfere with capillary action by making the soil too open. Ordinarily, however, a soil rich in lime maintains a better capillary action, and liming improves the texture of soils by making them more porous. Lime exerts another kind of physical action which may be called flocculation, finer particles being converted into coarser ones. Schløesing discovered that two parts of lime in the form of chloride, nitrate or sulphate of calcium, immediately caused flocculation in 10,000 parts of a turbid liquor that contained a good deal of clay, that flocculation was perceptible when the proportion was reduced to 1 in 10,000, but that half this quantity of lime had no effect on the liquor in question even in the course of six weeks. Another experiment may be tried to bring out the nature of the influence exerted by lime on plastic soils. Let a quantity of tough clay soil be worked into a plastic mass with water and let a portion be then dried, the result will be a mass of stony hardness. To another portion of the paste add half per cent. of caustic lime and a diminution of plasticity will be obvious at once even when the mass is wet. On drying this mass will fall into crumbs at a mere touch. By liming, clay soils are made warmer, mellow, and of better tilth. This lightening effect lasts for years and is never entirely lost.

Another effect of lime is to set free for the use of crops, potash, ammonia and magnesia from hydrated double silicates. Experiments have shown that gypsum does this better than lime.

Lime in a caustic condition has a highly beneficial effect on peaty and boggy soils (*i. e.*, soils rich in humus) and on compost heaps. It hastens putrefactive processes and reduces vegetable substances into 'mould.'

When green-manuring is done, say, with *dhaincha* in August, liming is advisable to hasten decay before the next crop, potatoes or sugar-cane, is sown.

Lime in the form of carbonate promotes the formation of nitrates in the soil. Slaked and hot lime destroy insects, and other vermin and also fungus pests. Liming of seed grain for preventing rust and smut is practised by European and American farmers. When any crop shows any fungoid disease lime should be scattered over it.

Poor sandy soils are also benefited by liming if it is done before the application of farmyard manure, inasmuch as it cements their particles together as mortar, making them stiffer and charging them with hydrous silicates and thus adding to their absorptive power. An admixture of carbonate of lime with soil increases its power to absorb and fix potash, soda, ammonia, etc., from their solutions.

Liming corrects the acidity of sour land by neutralizing any excess of free humic acid.

Liming reduces the proportion of rushes and sedges and encourages the growth of good grasses and leguminous weeds in pasture lands.

But on poor soils liming should not be done without very great care. In fact, lime sets free such an amount of plant-food, that it gives an immediate good return at the expense of the permanent fertility of the soil. There is a proverb which says, "Lime enriches the father but beggars the son." It is better to use ashes, bone-dust, apatite or gypsum when it is intended to supply lime to the soil.

Seeds and young plants should not be brought in close contact with lime, as the caustic action burns up seedlings. Grass can be actually killed by watering it with lime water.

The action of lime in decomposing orthoclase felspar has been already mentioned in connection with potash manures. Soils containing fragments of felspathic stone therefore are benefited by the application of lime.

Liming of the soil makes the crop earlier. Phosphates have a similar effect of hastening maturity of crops.

One or two tons per acre once in every seven years is the best method of applying lime on lands suitable for liming. Lime has a tendency to sink gradually into soil; hence the necessity of repeating the application from time to time. Generally speaking, calcareous regions are particularly fertile specially for pulse crops. Clay-soil rich in lime is fertile for most crops.

Soils are sometimes *marled*, *i.e.*, given a dose of clay containing 5 to 50 or even 80 per cent. of lime. The application of marl to sandy soils alters their texture for good. But marl must be found on the spot if it is to be economically applied. 70,000 or 80,000 lbs. per acre every 10 or 12 years is the rate at which marl is applied.

Lime exists in most soils in sufficient proportion, the important part occurring in the form of calcium carbonate. The presence of calcium carbonate in proportions of over one per cent. can be detected by the addition of any dilute acid which results in effervescence. Calcium silicate is much more insoluble. Farm-yard manure contains calcium chiefly in the soluble forms of sulphate and carbonate, but calcium silicate also occurs in minute proportions. Lime, slaked lime and gypsum are readily soluble in water; but *ghuting* and limestones ( $\text{CaCO}_3$ ) are also soluble in water charged with carbon dioxide. Rain water contains no lime, but well-water and muddy canal or tank water usually contains much and clear canal and tank water, somewhat less.

Unslaked lime ( $\text{CaO}$ ) hastens the decomposition of organic matter, kills grubs and spores of fungi and decomposes double silicates, setting free the bases, potash, etc. In poor soils, the setting free of bases is not desirable, and, on the whole, slaked lime is to be preferred to hot lime, even when it is used as an insecticide and fungicide. Lime renders clays lighter and sands less dry. The presence of lime in soil is also useful for storing up phosphoric acid in seeds where it occurs as calcium or other phosphates. It also neutralizes acids generally and precipitates oxalic acid in

particular as oxalate of lime, which exercises useful functions in leaves and stems.

Rain water contains about four parts of nitrogen in every ten million parts, but no other manurial constituent of importance. Clear canal water contains in ten million parts about two parts of nitrogen, 10 parts of phosphoric acid, 100 parts of potash, 900 parts of lime, 700 parts of magnesia and 200 parts of soda; while in a muddy state the proportions in ten million parts might be above, as follows—

|                 |    |    |    |    |    |              |
|-----------------|----|----|----|----|----|--------------|
| Nitrogen        | .. | .. | .. | .. | .. | 4 parts.     |
| Phosphoric acid | .. | .. | .. | .. | .. | 20 parts.    |
| Potash          | .. | .. | .. | .. | .. | 200 parts.   |
| Lime            | .. | .. | .. | .. | .. | 1,100 parts. |
| Magnesia        | .. | .. | .. | .. | .. | 1,000 parts. |
| Soda            | .. | .. | .. | .. | .. | 220 parts.   |

Well-water which is known to be helpful to vegetation, usually contains a good deal of lime, *i.e.*, about 1,000 parts in 10 million parts. The result of an actual analysis of a sample of well-water is given below: -

|                 |    |    |                                |
|-----------------|----|----|--------------------------------|
| Nitrogen        | .. | .. | 150 parts in 10 million parts. |
| Phosphoric acid | .. | .. | 100 " " "                      |
| Potash          | .. | .. | 100 " " "                      |
| Lime            | .. | .. | 1,000 " " "                    |
| Magnesia        | .. | .. | 1,000 " " "                    |
| Soda            | .. | .. | 3,000 " " "                    |

Well and canal water which are known to be harmful to vegetation, contain a larger excess of magnesia and soda. Canal water rarely contains such excess, but well-water often does. Hence the unsuitability of some well-waters for irrigation and the belief current among Bengal cultivators of the general unsuitability of well-water for irrigation.

## CHAPTER XC.

### GYPSUM AND SALT.

[Occurrence of gypsum; Effect of gypsum on *usar* soil; Other effects of gypsum; Application; Crops particularly benefited by gypsum; Sources of salt; Crops particularly benefited by salt; Disintegrating effect of lime and salt; Objections to salt as manure; Germicidal effect on wheat rust, etc.; Mechanical action; Application unnecessary within fifty miles of the sea-coast; Caution against free use of lime and salt.]

*Gypsum* occurs in the natural state in the following localities; at Trichinopoly, Nellore and Chingleput in Madras; in the latter two places as crystals of Selenite; in Cutch and the Kirtha range of Sind in Bombay; near Nagore in the Jodhpur State in Rajputana; at Bijawar and Baraundha in Central India; at Bannu and Kohat and the Salt Range in the Punjab; and in Kumaun and Garhwal in the United Provinces. Burnt gypsum is used as a cement. It is a valuable manure chiefly for leguminous plants, though it is

not used in India. The Salt Range in the Punjab is overlaid by a deposit of gypsum fifteen to twenty feet thick, enough for supplying the needs of the whole world. The refuse from aerated water manufactories is artificial gypsum. It should be used mixed up with lime as it is liable to contain an excess of acid. Calcined gypsum is plaster of paris which is used for making models and casts.

The effect of gypsum on *Usar* soil is very characteristic. If a good soil be mixed with a considerable volume of water and the muddy liquid be then poured over a filter, the water extract will come through rapidly. This, however, is not the case with *Usar* soil. An aqueous extract of *Usar* soil takes several hours or even days to pass through. The effect of small quantities of gypsum and some other salts, added to the muddy mixture of *Usar* soil and water, is the curdling together of the soil particles, and the rendering of the soil more permeable. The sodium carbonate, which is the most harmful substance present in *Usar* soil, is also replaced by sodium sulphate, which is less harmful.

Gypsum also exerts a powerful action in setting free potash which has been absorbed and fixed by the earth, that is to say, by double silicates in the earth. The lime of the gypsum is fixed in the soil, while a corresponding quantity of potash goes into solution.

Gypsum sets free magnesia and ammonia in the same manner as potash, for the use of the crop.

Gypsum scattered on moist places in cow-houses and stables does excellent service by checking the fermentation of urine and by absorbing some of the odours which arise from it. The ammonium sulphate produced by the addition of gypsum is a more non-volatile substance than the ammonium carbonate which is evolved from putrefying urine. The reaction is expressed by the following formula :—

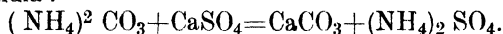

The use of gypsum as a manure was known to the Greeks and Romans. It is largely used in Europe and America for manuring potatoes and clover. It is very desirable to extend the use of this substance for manure in India especially for clay-soils. It benefits *arabhar*, gram and other pulse crops, tobacco, rhea and potatoes. It should not be used annually, but once in three or four years on the same soil at the rate of five to ten maunds per acre. It is a more useful manure than lime, the sulphur of calcium sulphate being also an essential constituent of plant-food.

*Salt*.—The chief native sources of common salt in India are, (1) the salt lakes and pits of Rajputana; (2) the salt mines of the Salt Range of the Punjab, and (3) the sea and the estuaries.

The evaporation salt of Rajputana is derived from the Sambhar Lake, the Didwana Lake and the Pachbadra Pits. The Sambhar Lake is the most important of these three. It is situated on the borders of the Jaipur and Jodhpur States. It is a shallow

sheet of water 20 miles long and 2 to 7 miles wide and only 1 to 4 ft. deep when full. The salt obtained is very pure and is largely used in the United Provinces, Rajputana and the Central Provinces. The working season is between November and May. The lake is leased by Government from the Jaipur and Jodhpur States for Rs. 7,00,000, with, in addition, a royalty of 40 per cent. of the price of salt sold in excess of 63,135 tons, which adds the payment of about another two lakhs of rupees. There are three kinds of salt produced at Sambhar: (1) *K'yar*-salt, which is produced in permanently walled compartments within the lake whence soft earth is carefully removed and which are kept supplied with brine. (2) Pan-salt, which is produced in shallow basins along the shores which are kept supplied with brine with hand-pumps or swing baskets. (3) Lake-salt, which is formed spontaneously in the bed of the lake as the water evaporates.

The Pachbadra salt is procured from pits dug within what might be described as a former river-bed 6 miles in length by 2½ miles in width.

The rock-salt of Northern India is excavated chiefly from the salt mines of the Salt Range which extend for 152 miles from the Jhelam to the Indus. There are also salt mines in Kohat (trans-Indus) and the Himalayan salt mines of the Mandi State. The salt from these mines is obtained by pick and blast in the usual way with all mining operations. The supply is practically inexhaustible, and the annual output is entirely dependent on demand. The salt is of very pure quality, and it is a good substitute for Liverpool salt. The Mayo Mines of the Salt Range produce about 75,000 tons per annum. Salt in the mineral state is found near Dwarka also, in the Baroda State.

Over a tract of country fifteen square miles in extent south-west of Delhi, salt is obtained from brine wells. This is known as Sultanpur Salt, which is somewhat bitter owing to the admixture of sodium sulphate. A poorer kind still is made at Sankaransar, fifty miles north of Bikanir. This is used for curing hides, for feeding cattle, and it is also eaten by the poorer classes. In Orissa there is a little salt manufactured under the Madras Salt Department. The sea-salt is manufactured chiefly in the Thana District of Bombay. The site chosen is usually on the shore of a creek or estuary, below the level of high tides and fully exposed to the influence of the prevailing winds. It is first surrounded by high embankments, the enclosed space being about 250 by 80 feet. The space so enclosed is then divided by other walls into three sections, the outer reservoir, the inner reservoir and the pan-area. The space devoted to pans is carefully levelled and a floor of clay repeatedly puddled until it becomes water-tight. The pans are formed by small clay partitions two feet broad which run the whole length and breadth of the pan-area, crossing each other at right angles and thus forming a number of rectangular crystallising beds. The levels are so arranged that the water flows from the first reservoir into the



second and from the second into the pans, being gradually concentrated as it flows from one basin to another. The water from the sea is admitted through a sluice and is thus exposed to evaporation till it forms brine. With this brine the pans are charged to a depth of an inch and a half, and within a few hours, in favourable weather, especially on shallow pans, a layer of crystals is formed, generally about one-quarter of an inch in thickness. The salt is then raked on to ridges and left to dry and the pans are re-charged. Salt is manufactured near the town of Madras also.

The total production of salt in India is about one million tons per annum. Less than half this quantity is imported chiefly from Great Britain, Germany and Arabia.

As an article of food for man and beast, the value of salt is well known. As a manure, at the rate of 2 cwts. per acre, salt has been found useful for the following plants:—Cabbages, cauliflowers, beet, mangold, tomatoes, celery, horse-radish, onions, asparagus, cocconut, date-palm, cashew-nuts, radishes, arums, mangoes and bread-fruit tree. In reclaimed lands in the Sunderbans and elsewhere where the excess of sea-salt is too much for the healthy growth of ordinary crops, those just mentioned may be successfully grown provided adequate provision is made for keeping out water from the field during the growth of the crops. Paddy seedlings grown on high land comparatively free from salt can be successfully transplanted and grown on lands containing an excess of salt. In certain soils, cereals, tobacco and cotton are considerably benefited by salt. Salt should not be applied when seed is germinating, as young plants and germinating seed are injured by the application. It may be ploughed in long before sowing or mixed with soil after the plants have grown a bit. It should not be used as a top-dressing. The inferior kinds of salt are better for manurial purposes. Neither sodium nor chlorine is essential for plant life, and salt containing sulphate of soda is therefore of more value as a manure. Impure salt often contains also sodium carbonate, sodium nitrate, potassium nitrate and other substances which are also useful as manure. Sodium chloride itself has however an indirect manurial action on the soil, especially on soil rich in lime. As gypsum replaces potash, magnesia and ammonia in the hydrous double silicates, so also common salt replaces lime first and then magnesia, potash and phosphoric acid. Wolff grew a quantity of buckwheat upon a field one half of which was manured heavily with common salt, while the other half was left unmanured. On analysing the ashes of the buckwheat straw, he found that the portion of the crop which had received the salt contained less soda but more potash, than the other. An application of common salt to the land might thus exert a decided fertilizing action, by merely replacing lime and potash in the surface layers of the soil and sending them down to where the roots of the crop are. The disintegrating effect of lime and salt on rocks and soil particles

is of great importance in the formation of soils and the growth of vegetation.

Salt is injurious to leguminous crops generally. To cereal crops it often does good, especially when there is any tendency for a crop running to straw and producing a small proportion of grain. It toughens the straw of cereals. Chloride of magnesium and chloride of potassium have the same effect of reducing the tendency of a crop running to straw. Tobacco grown with salt as manure produces tougher and more flexible leaves. Hemp produces a larger amount of better fibre with salt used as manure. Potatoes have a tendency to become waxy when salt is used as manure.

For cotton, salt is a very useful manure on soils fairly rich in lime. It makes cotton bear longer in the season, and stand drought better. It increases the quantity and improves the quality of lint.

As a germicide salt is a very useful manure for lands subject to rust and other fungoid diseases. 300 lbs. of salt and 200 lbs. of gypsum used per acre is an excellent preventive against rust. Salt kills leeches, snails and other vermin.

Carbonate of soda which is formed by the addition of salt to soils rich in lime can dissolve to an appreciable extent phosphate of iron. This is another indirect fertilising effect of the use of salt, on soils rich in lime.

The mechanical action of salt, like most other saline substances, in producing a good tilth in clay soils, should also be taken into account. Granules of clay are flocculated or held together with salt even when it occurs in a minute proportion, and the soil is rendered more permeable to water and friable.

Air carries with it to long distances sprays from the sea and with rain we get more or less salt washed down into the soil. This is one source of salt in soils. As a general rule, the use of salt as a fertiliser is unnecessary, specially when the land is situated within one hundred and fifty miles of the sea-coast, and crops which are specially benefited by salt manure need not be manured with salt within fifty miles of the sea-coast.

The application of lime, gypsum and salt as manure, if done at all, should be done with care. It is rich soils only that can afford to part with large quantities of plant-food that are made available at once by such application. Where a soil is poor in potash and phosphoric acid, the application of lime, gypsum and salt should only be done with great hesitation. Clay-soils rich in organic-matter are particularly benefited by the application both mechanically and chemically, provided they are not already rich in salt also.

## PART V. METHODS OF ANALYSIS.

### CHAPTER XCI. GENERAL REMARKS.

THE sciences mainly helpful to agriculture are Geology, Mechanics, Botany, Chemistry, Veterinary Science, Zoology and Bacteriology. It is not expected that an agriculturist or scientific farmer should be an expert in all these sciences. In treating the subject of agriculture in a systematic manner it is impossible to ignore the geological, mechanical, botanical, zoological, physiological, bacteriological, or chemical aspects of various questions with which the agriculturist has to do, and in the preceding parts of this book facts culled from these sciences which are intimately related with agriculture, have been freely made use of in explaining the reasons and principles underlying those questions. We have already dealt with the chemical aspect of soils, crops, manures etc., and in this part, therefore, we will deal only with the methods that an educated farmer may follow for himself, without going to a chemist, in analysing soils, manures and food-stuffs.

The main purpose of a knowledge of agricultural chemistry on the part of the agriculturist, is to enable him to analyse soils, crops, manures, purchased food-stuffs, milk, and industrial products, such as indigo, tea, sugar, dyes and tans. In fact, the agricultural chemist is not expected to do even so much. There are specialists employed for the analysis of indigo, tea, sugar, dyes, etc., and all that an agricultural chemist is ordinarily expected to do is to analyse, with accuracy, soils, manures and food-stuffs. A chemist who cannot do this much, but who has a great deal of general acquaintance of the different branches of chemistry, is of no use as an agricultural chemist. Chemistry is a vast subject, and it is necessary to specialise one's work if one is to produce sound and reliable results. Accuracy of manipulation, purity of the chemicals used, and a systematised arrangement helpful for getting over a large quantity of work, are the essential conditions of success in analytical work. The student of agricultural chemistry should begin quantitative work at once. This disciplines him to methods of accuracy. One year of preparatory work

in quantitative analysis will enable the students to produce accurate results in the second year. He should aim from the very first to do the work in the manner required for a *commercial analysis*. In analysing soils, for instance, he should aim only at getting the proportions of soluble matter, sand and other insoluble matters, nitrogen, phosphoric acid, potash and lime. In analysing a sample of nitrate of potash, however, the proportions of sand, sodium sulphate, calcium sulphate and sodium chloride should be ascertained, as these are impurities commonly present, and which may have been actually used by way of adulteration. In fact, adulteration is so universally practised in countries where manures are largely purchased, that it is never considered safe to purchase manure without analysis, and the time of the agricultural chemist in those countries is largely occupied, therefore, in analysing manures. In analysing crops, the agricultural chemist should also bear in mind the object, which is in most cases the ascertaining of their nourishing value. Another object of analysing a crop is to ascertain the proper manurial substances needed for its growth. The analysis of the tobacco leaf, for instance, leaves no doubt that the manurial ingredients required by this crop are chiefly nitrogen, lime, sulphur, and potash and one naturally arrives at the conclusion that saltpetre and gypsum would materially benefit this crop.

The agricultural chemist should be well acquainted with the aims, needs and difficulties of the farmer, that his analyses may not be aimless, but directed to the elucidation of only those points that would be of help to the farmer. In other words, an agricultural chemist must be an agriculturist who has specialised as an agricultural chemist.

The farmer also should have a general acquaintance of the chemical or rather the manurial value of the substances he sells out of his farm and those he buys for the farm. His aim should be to sell off only such articles as have little manurial value, such as, rice, maize, oil (not oil-cake), fibres, India-rubber, sugar, and butter, and he should buy such food-stuffs only as are particularly rich in the manurial constituents which he needs. Linseed-cake would fatten his animals quicker, but it is sometimes better that he should purchase cotton-cake, as the latter brings in far more fertility to his soil.

The apparatus and chemicals required by an agricultural chemist for all the analytical work he is likely to be called on to do can be procured for about £200. Messrs. Baird and Tatlock of 14, Cross Street, Hatton Garden, London, E. C., are among the best English firms to go to for these. For purity of chemicals, however, the firms of Kahlbaum of Berlin and E. Merck of Darmstadt are the most famous.

## CHAPTER XCII.

### THE STANDARD ACID AND ALKALI.

THE strength of the dilute sulphuric acid to be used for the estimation of nitrogen should be determined once for all and noted on the jars or bottles. This is done in the following way:—

Twenty cubic centimetres of the sulphuric acid should be taken by means of a pipette into a clean beaker; then another 20 c.c. into another beaker; and a third quantity of 20 c.c. in a third beaker. Ten times as much distilled water should be added to each, *i.e.*, about 200 c.c. A few drops of dilute hydrochloric acid should then be added to each. The contents of the beakers are then successively boiled, and when boiling just commences, a solution of barium chloride in a boiling state should be gradually added, and the contents of the beaker stirred with a glass rod, until all precipitation ceases. The liquid is to be kept near the boiling point for some time, and then covered up and left in a sand-bath.

The liquid should then be brought to the boiling point and filtered the next day through Swedish filter-paper; the precipitate on the paper being washed several times with hot water, also the residue of the precipitate in the beaker. When all the precipitate has been transferred into the filter, the funnel with the precipitate is to be covered up with a piece of paper and left on the water-oven to dry. One precaution should be always taken before transferring the contents of a beaker into a filter, *etc.*: the edge of the beaker should be greased and a glass rod should be used while pouring the contents of the beaker into the filter. The filter-paper should be moistened with water blown out from a wash-bottle before the liquid is poured on to it.

Next day, the precipitate is to be carefully scraped out into a weighed crucible, the filter-paper burnt white, rolled up in a platinum wire coil, and the ash added to the precipitate. The crucible is to be placed on a piece of black glazed paper, while the precipitate and the paper ash are being put into it. The crucible is then to be placed on a Bunsen flame or spirit lamp and the substance thoroughly ignited. The crucible should then be left inside a desiccator for over ten minutes and then weighed. The precipitate in the three beakers is treated exactly in the same way, the estimation of the strength of the sulphuric acid being made in triplicate to ensure accuracy.

The addition of barium chloride in the presence of hydrochloric acid results in the whole of the sulphuric acid in the beaker being converted into barium sulphate; barium sulphate is nearly insoluble in water, but in dilute acid it is altogether insoluble. Hence the addition of a few drops of hydrochloric acid.

The weight of the barium sulphate being ascertained, the weight of pure sulphuric acid can be easily deduced.

Suppose the weight of the crucible + precipitate + ash of the filter-paper = 31.921 grammes, and the weight of the crucible alone = 29.336 grammes, the weight of the barium sulphate, precipitate and ash of paper = 2.585. A deduction of .002 is usually made on account of the ash of the paper; but this point may be separately determined by actual weighing of the ash from a piece of filter-paper of the size and quality used. The remainder, 2.583 grammes, is the weight of the precipitate. The weight of the precipitate of all the three beakers being thus ascertained, the average of the three weights is taken. If the weights come to 2.583, 2.584 and 2.6 grammes respectively, the average is a

$$\frac{2.583 + 2.584 + 2.6}{3} = 2.589 \text{ grammes.}$$

Now  $\text{BaSO}_4 : \text{H}_2\text{SO}_4 :: 2.589 : x$   
*i.e.*,  $173 + 32.06 + 4 \times 16 : 2 + 32.06 + 4 \times 16 :: 2.589 : x$   
 $(=233.06) \qquad \qquad \qquad (=98.06)$   
 $\therefore x = \frac{98.06 \times 2.589}{233.06} = \frac{253.87743}{233.06} = 1.089 \text{ grammes in } 20 \text{ c.c.}$

*The standard Sodium Hydrate.*—The alkaline solution that has to be used for the determination of nitrogen in all analyses should be made of such a strength that 100 c.c. of it should be exactly neutralised by 20 c.c. of the standard sulphuric acid, the strength of which has been just determined. This is done in the following way:—

A pipetteful of  $\text{H}_2\text{SO}_4$  *i.e.*, 20 c.c., is taken in a white porcelain basin. It is diluted with about 200 c.c. of distilled water and coloured with methyl orange. A buretteful of the alkaline solution is then taken, and it is found, say, that the whole of the 50 c.c. of the alkaline solution in the burette is taken up without neutralising the acid. Another buretteful is then taken and now, say, only 2.44 c.c., *i.e.*, 52.4 c.c. altogether, is required to neutralise the acid (when the colour just turns pink). The whole of the alkali in the bottle is then transferred to another bottle, and say, 1,100 c.c. measured back into the former bottle. Now, as 52.4 of the alkaline solution requires 47.6 of water to make it into 100 c.c., how much water must be added to the 1,100 c.c. to make it of the proper strength?

$$52.4 : 1100 :: 47.8 : x$$

$$\therefore x = 999.237.$$

So 999.2 c.c. of water has to be added to the solution in the bottle; and the burette filled with the new solution, and the process of neutralising the 20 c.c. of  $\text{H}_2\text{SO}_4$  coloured with methyl orange, repeated. After two or three trials the exact strength can be attained.

Now, we have seen that one pipette of sulphuric acid contains 1.089 grammes of pure sulphuric acid. But one pipette of this acid is neutralised by 100 c.c. of the standardized alkali.

∴ 1 c.c. of the alkali represents  $\frac{1.089}{100} = .01089$  of  $H_2SO_4$ . But one molecule of sulphuric acid neutralises two molecules of ammonia ( $NH_3$ ) i.e.,  $2 + 3206 + 4 \times 61 = 98.06$  parts by weight of sulphuric acid is equivalent to  $(14 + 3) \times 2 = 34$  parts by weight of ammonia and  $2 \times 14 = 28$  parts by weight of nitrogen.

∴ .01089 grammes by weight of  $H_2SO_4$ , or 1 c.c. of alkali represents  $\frac{.01089 \times 34}{98.06}$  grammes of  $NH_3$

and  $\frac{.01089 \times 28}{98.06}$  grammes of N.

∴ Every 1 c.c. of alkali used represents .00377586 grammes of ammonia and .00310952 grammes of nitrogen.

## CHAPTER XCIII.

### ANALYSIS OF SOIL.

IN analysing a sample of soil, for all ordinary agricultural purposes, the following constituents alone are quantitatively determined :—

(1) Moisture, (2) Organic matter, (3) Matters soluble in water, (4) Nitrogen, (5) Potassium, (6) Phosphorus Pentoxide, and (7) Lime.

The sample should be taken from different parts of the field mixed up well, and must be thoroughly representative. It should be finely divided, spread out to dry in shade, before it is bottled up or used for analysis. A steel box nine inches deep and six inches square is hammered down and then dug out for getting representative samples of the top soil. In Bengal for ordinary crops, a steel box  $6'' \times 6'' + 6''$  would answer.

(1) *Moisture*.—Three grammes of the soil should be weighed out in a watch glass, and left in a water-oven over-night. It is weighed next day when cool in the desiccator, and weighed again, after having been again left in the water-oven for a few hours, and then cooled in the desiccator. The weight should then be found to remain constant. The loss of weight is due to moisture in the three grammes of the soil.

(2) *Organic matter*.—Ten grammes of the soil should be weighed out in a platinum dish, and gradually heated to a low redness. The heat is maintained till all blackness disappears. It is then left to cool in the desiccator, and afterwards weighed. The loss of weight is due to organic matter and combined water as also to the moisture in ten grammes of the soil.

(3) *Matters soluble in water*.—Ten grammes more of the soil should be weighed out, placed in a flask, 200 c.c. of distilled water added, and the whole boiled for a quarter of an hour with occasional shaking. The mixture is then kept aside for about 10 minutes, and the supernatant liquid decanted off into a beaker. The

process of boiling with another 200 c.c. of water is repeated, and the second portion of the supernatant liquid is decanted off in the same way as before. This is repeated a third and a fourth time. The combined portions of the decanted liquid are passed through a double Swedish paper filter. If the filtrate is still turbid, it should be boiled, and passed through the filter again. This may have to be done a third time before the filtrate comes out clear. The filtrate is then transferred and carefully washed out into a small weighed beaker, left on the steamer to dry, the beaker being gradually filled up while on the steamer, and when apparently dry, it is left inside the water-oven, to get completely dry. Next day, it is cooled in the desiccator, and weighed. The increase in weight is due to the soluble matter in ten grammes of the soil.

(4) *Nitrogen*.—Kjeldahl's process should be followed in the estimation of nitrogen in soils and other substances. In fact, the process is very easy after the apparatus is once set up, and it gives very accurate results. It is adapted for liquid as well as for solid substances. The substance is first heated with strong sulphuric acid (20 c.c. of sulphuric acid being used for three grammes of soil), the object being to convert all the nitrogen in the soil into ammonium sulphate. To raise the temperature of the mixture and to make the dark liquid clear, ten grammes of dry powdered potassium sulphate are added. The heating is continued for two hours after this. By this time the conversion of the nitrogen in the organic substances of the soil into ammonium sulphate is complete. Next, an excess of sodium hydrate solution is added to the digestion-flask, and the flask connected with a steamer on the one hand, by means of a bent tube, and on the other by means of another bent tube with a vertical Liebig condenser. The lower end of the condenser dips into a flask containing 20 c.c. of the standard sulphuric acid. The boiling of the alkaline solution in the digestion-flask is done by means of a current of steam passing from the steamer through the alkaline solution (with the soil digesting in it), which ultimately gets condensed and drops into the sulphuric acid flask carrying all the ammonia with it. After passing steam in this way for half an hour, the ammonia all comes out of the soil, and then by titrating the sulphuric acid excess, the proportion of nitrogen in the soil can be inferred as before.

(5) *Potash*.—Ten grammes more of the soil is weighed out in a platinum dish, gently ignited for a few minutes just to carbonize the organic compounds. When cold, it is transferred to a beaker, 50 c.c. of strong hydrochloric acid and 100 c.c. of water added, the beaker covered up, taken to and left for an hour in the sand-bath. The cover is then taken off, and the beaker left in the sand-bath over-night. Next day a few drops of strong hydrochloric acid should be added and the mixture kept standing for a quarter of an hour. A little water is then added, and the whole warmed. The processes of drying and boiling are repeated. The siliceous matter will be probably slightly reddish in tinge. This is filtered



out, washed, dried, ignited and weighed. Lime, phosphates and potash, besides other things, *e.g.*, alumina, oxide of iron, etc., are dissolved in the filtrate and washings. These are precipitated with a slight excess of ammonia, and left uncovered for an hour or two to get rid of the ammonia. Aluminium hydrate is soluble in ammonia solution. Therefore the excess of ammonia should be got rid of by leaving the beaker uncovered in the sand-bath for a little while. The abundant reddish brown jelly-like precipitate contains all the phosphorus pentoxide with oxide of iron alumina, etc.; and the filtrate, the potash and the lime. The precipitate on the filter-paper is thoroughly washed with hot water.

(6) *Lime*.—The filtrate and washings are boiled, and treated with ammonium oxalate as long as a precipitate is produced. The whole is filtered and washed, till the washing shows no trace of potassium, tested with a platinum wire on the flame. The residue is left in the water-oven to dry, to be afterwards ignited gently and weighed as calcium carbonate. The proportion of lime may be inferred from that of calcium carbonate found out. The filtrate and washings are left uncovered in the sand-bath to dry. The dry residue is transferred to a clean porcelain basin, and gently ignited in it. The fragments adhering to the sides of the beaker are washed out into the porcelain basin when it is cool after the ignition. This is left on the steamer to dry. When dry, it is ignited again, in the same way, gently to drive off all ammonium-salts. Pure water is then added to the basin when cool, to dissolve the potassium and sodium chlorides and the solution filtered. The clear filtrate and washings are treated with hydrochloric acid in slight excess, transferred to the porcelain basin, one-third of a test-tubeful of platinum tetrachloride solution added, and the whole left on the steamer to dry. The moist residue is washed out into a porcelain crucible with 80% alcohol. It should of course, be washed on a filter first until the filtrate comes out colourless. The crucible is left on the steamer to dry, and afterwards in the water-oven. When cool, it is weighed being potassium platinum chloride.

(7) *Phosphorus-Pentoxide*.—The jelly-like precipitate obtained with ammonia and already mentioned is transferred into a beaker with the help of the wash-bottle. Some nitric acid is poured on to the filter to dissolve the adhering precipitate. The filtrate is collected in the same beaker containing the precipitate. The filter-paper is once more filled with nitric acid when it is empty. A test-tube and a half of an acidified solution of ammonium molybdate is then added. The mixture is left uncovered in the sand-bath, to get concentrated. The bright yellow precipitate is collected on a filter-paper. The filtrate is treated with a little more of ammonium molybdate to see if any more yellow precipitate would form. The precipitate on the filter is washed with ammonium nitrate. It is then treated on the filter with just enough of dilute ammonia solution to dissolve the precipitate. A few drops of citric acid should be added to the filtrate and some magnesia

mixture. It should be then left covered up in a cold place for twelve hours. The precipitate is collected on a filter-paper, and washed with ammonia water. The precipitate is dried, ignited, first gently, then before the blow-pipe, cooled, and weighed.

The determination of *available phosphoric acid and potash* has been already described in Chapter LXXXVIII.

The following weights, etc., were actually obtained in an analysis of a sample of soil :—

#### Moisture—

|                                       |       |        |          |          |
|---------------------------------------|-------|--------|----------|----------|
| Watch-glasses and clip and raw soil   | ..    | ..     | —27·3707 | grammes. |
| Watch-glasses and clip                | ..    | ..     | —24·3707 | ..       |
| Watch-glasses and clip and dried soil | ..    | ..     | —27·2960 | ..       |
| ∴ Moisture in 3 grammes               | ..    | ..     | ·0747    | ..       |
| ∴ In 1 gramme—                        | ·0249 | gramme | ..       | —2·49%   |

#### Loss on ignition—

|                    |       |        |    |         |
|--------------------|-------|--------|----|---------|
| Crucible and soil  | ..    | ..     | .. | —39·328 |
| Crucible alone     | ..    | ..     | .. | —29·328 |
| After ignition     | ..    | ..     | .. | —38·596 |
| ∴ Loss on ignition | ..    | ..     | .. | — ·732  |
| ∴ In 1 gramme—     | ·0732 | gramme | .. | — 7·32% |

#### Silicates and other insoluble matter—

|                                   |    |    |    |          |
|-----------------------------------|----|----|----|----------|
| Crucible and insoluble residue    | .. | .. | .. | —37·724  |
| Crucible alone                    | .. | .. | .. | —29·328  |
| ∴ Insoluble residue in 10 grammes | .. | .. | .. | —8·396   |
| Deducting ·002 for paper ash      | .. | .. | .. | —8·394   |
|                                   |    |    |    | — 83·94% |

#### Soluble Salts—

|                             |    |    |    |          |
|-----------------------------|----|----|----|----------|
| Beaker and soluble salts    | .. | .. | .. | —20·3080 |
| Beaker alone                | .. | .. | .. | —20·2465 |
| Soluble salts in 10 grammes | .. | .. | .. | — ·0615  |
|                             |    |    |    | — ·615%  |

#### Nitrogen—

|  |        |
|--|--------|
| 50—47·2—97·2 c.c. of the standard solution of NaHO were required to neutralize 20 c.c. of the standard H <sub>2</sub> SO <sub>4</sub> solution at the titration. |        |
| ∴ 2·8 c.c. of the NaHO was replaced by NH <sub>3</sub> from the soil.  |        |
| But 1 c.c. of the alkali represents ·0051095 grammes of N.   |        |
| ∴ 2·8 c.c. represents ·0087066 grammes of N. in 5 grammes.   |        |
|  | — 174% |

#### Lime—

|  |    |    |    |         |
|--|----|----|----|---------|
| Crucible and Ca CO <sub>3</sub> ppt. and paper ash | .. | .. | .. | —29·433 |
| Crucible alone                                     | .. | .. | .. | —29·327 |
|  |    |    |    | ·106    |
| Deducting ·002 for filter-paper ash                | .. | .. | .. | ·002    |
| CaCO <sub>3</sub> in 10 grammes                    | .. | .. | .. | — ·104  |
|  |    |    |    | — 1·04% |

#### Phosphates—

|  |    |    |    |               |
|--|----|----|----|---------------|
| Crucible and Mg <sub>2</sub> P <sub>2</sub> O <sub>7</sub> and paper ash | .. | .. | .. | —29·392       |
| Crucible and paper ash   | .. | .. | .. | —29·329       |
| Mg <sub>2</sub> P <sub>2</sub> O <sub>7</sub> ppt.                       | .. | .. | .. | — ·063        |
| In 1 gramme  | .. | .. | .. | — ·0063— ·63% |

*Potash*—

Crucible and ppt. ( $K_2PtCl_6$ ) .. — 12·7645  
 Crucible alone .. .. — 12·6370  
 $\therefore$  the ppt in 10 grammes .. — ·1275  
 $\therefore$  In 1 gramme .. .. — ·01275 — 1·28%  
 $K_2PtCl_6 : K_2O :: 1·28 : K_2O$  in 100 parts of the sample.  
 485·5 : 94 :: 1·28 :  $x$ , or  $K_2O$  in 100 parts of the sample—25%

- (1) *Moisture* being .. .. — 2·49%  
 The percentage of dry matter .. — 97·51  
 But loss on ignition .. .. — 7·32%  
 of which moisture .. .. 2·49%

(2)  $\therefore$  *Organic matter, etc.*—4·83 in 97·51% of dry matter.  
 $\therefore$  In 100 of dry matter the amount of org. matter, etc.—  
 97·51 : 100 :: 4·83 :  $x$

$$\therefore x = \frac{483 \times 100}{97 \cdot 51} = 4 \cdot 95\%$$

- (3) *SiO<sub>2</sub>, Silicates, etc.*—83·94 in 97·51 of dry soil.  
 $\therefore$  In 100 of dry soil the amount of Silicates, etc.—  
 97·51 : 100 :: 83·94 :  $x$

$$\therefore x = \frac{83 \cdot 94 \times 100}{97 \cdot 51} = 86 \cdot 08\%$$

- (4) *CaCO<sub>3</sub>*— 1·04% in wet soil, i.e., 97·51 of dry.  
 97·51 : 100 :: 1·04 :  $x$

$$\therefore x = \frac{1 \cdot 04 \times 100}{97 \cdot 51} = 1 \cdot 07\%$$

- (5) *K<sub>2</sub>O*— 25% in the wet sample—  
 97·51 : 100 :: 25 :  $x$

$$\therefore x = \frac{25 \times 100}{97 \cdot 51} = 26\%$$

- (6) *P<sub>2</sub>O<sub>5</sub>*— $Mg_2P_2O_7$  from 10 parts of the wet sample ·63  
 $\therefore$  222 : 142 :: ·63 : amount of  $P_2O_5$  in the wet sample.

$$\therefore P_2O_5 \text{ in the wet sample} = \frac{\cdot 63 \times 142}{222} = \cdot 403$$

$\therefore$   $P_2O_5$  in the dry soil—  
 97·51 : 100 :: 403 :  $x$

$$\therefore x = \frac{403 \times 100}{97 \cdot 51} = 41\%$$

- (7) *Nitrogen* in the wet sample—174%  
 $\therefore$  In the dry soil.

97·51 : 100 :: 174 :  $x$

$$\therefore x = \frac{174 \times 100}{97 \cdot 51} = 178\%$$

or calculated as  $NH_3$

$N : NH_3 :: 178 : NH_3$  in the sample  
 14 : 17 :: 178 :  $x$   $\therefore x = 23\%$

- (8) *Soluble salts*—In the wet sample ·615%  
 $\therefore$  In the dry soil—

97·51 : 100 :: ·615 :  $x$

$$\therefore x = \frac{\cdot 615 \times 100}{97 \cdot 51} = 63\%$$

The following, therefore, is the result of the analysis of the sample of soil :—

|                            |     |    |    |         |
|----------------------------|-----|----|----|---------|
| Moisture                   | ..  | .. | .. | 2.49%   |
| Organic matter, etc. .:*   | ..  | .. | .. | 4.95 „  |
| Sand, etc.                 | ..  | .. | .. | 86.08 „ |
| Calcium carbonate†         | ..  | .. | .. | 1.07 „  |
| Potash                     | ..  | .. | .. | .26 „   |
| Phosphoric anhydride       | ..  | .. | .. | .41 „   |
| Undetermined               | ..  | .. | .. | 4.47 „  |
|                            |     |    |    | 100.00  |
| Soluble salts              | 63% |    |    |         |
| * Containing Nitrogen      | ..  | .. | .. | .18%    |
| † Calculated as Lime (CaO) | ..  | .. | .. | .60 „   |

## CHAPTER XCIV.

### ANALYSIS OF BONE-MEAL.

To analyse a sample of bone-meal, the following method is to be adopted for determining severally the following constituents, *viz.*, moisture, organic matter, sand, phosphates, calcium, carbonate, and ammonia or nitrogen.

(1) *Moisture*.—Three grammes of the powdered bone-meal should be weighed out in a watch-glass. This should be left in a water-oven. The loss of weight (when the weighing is found to remain constant next day), is due to moisture.

(2) *Organic matter*.—One gramme of the bone-meal should be weighed out in a platinum crucible. This is ignited in low heat. When all the black particles disappear, and the residue in the crucible appears white, it is put aside in the desiccator, and when cool, weighed. The loss of weight is due to the joint loss of moisture and organic matter in one gramme of the meal, but the amount of moisture has been already determined. The remainder should be calculated as due to organic matter.

(3) *Sand*.—The residue in the crucible should then be emptied into a beaker, the crucible being also washed out with hydrochloric acid. A little more hydrochloric acid is then added to the substance in the beaker; and the beaker left in the sand-bath for that day. Next day, the contents of the beaker are filtered through ordinary filter-paper; the sand on the filter-paper is washed a few times, dried in the water-oven, ignited in the crucible and weighed, when cool. The increase of weight of the crucible gives the weight of sand in a gramme of bone-meal.

(4) *Phosphates*.—The filtrate and washings from the sand are then diluted to about 300 c.c.; ammonium hydrate is gradually added; the liquid being stirred with a glass rod. When the precipitate settles, it is filtered through ordinary filter-paper and washed on the filter several times with ammonia water. The precipitate is then rinsed out into a beaker, the filter-paper being

afterwards thoroughly washed with a little dilute hydrochloric acid, the acid being allowed to collect in the same beaker containing the precipitate. This acid redissolves the precipitate. The redissolving is necessary to free the phosphates from lime still further. It is again diluted to about 300 c.c., ammonium hydrate is again added in the same way and the precipitate again collected in the same way, on the filter-paper. It is dried in the water-oven collected in the crucible, the filter-paper being burnt white and added to the crucible. It is ignited, put inside the desiccator and when cool, weighed. This gives the weight of a portion of the phosphates in 1 gramme of bone-meal. But as calcium phosphate is not quite insoluble in water, all the filtrates and washings are collected together in one beaker, and concentrated by boiling to about 150 c.c. A little acid is added to dissolve the calcium carbonate deposited. It is again boiled to drive away the carbon dioxide and when cool, ammonium hydrate is added gradually, and when the phosphates are deposited, they are collected on a filter-paper, washed thoroughly, dried in the water-oven, ignited in a crucible, the filter-paper being burnt white and added. When cool, it is weighed, and the weight obtained gives the additional quantity of phosphates in the one gramme of bone-meal.

(5) *Calcium Carbonate*.—The filtrate from the phosphates is boiled with ammonium oxalate. The precipitate is collected on Swedish filter-paper, dried in the water-oven, gently ignited to convert the calcium oxalate into calcium carbonate. The paper ash is also added. Weighed in a porcelain crucible of known weight, the increase of weight should be calculated as being due to the weight of calcium carbonate in one gramme of bone-meal.

(6) *Nitrogen*.—This is determined by the Kjeldahl method previously described.

The following figures obtained in the course of an analysis of a sample of bone-meal will illustrate how the analysis is actually worked out:—

*Moisture and organic matter—*

|                                       |    |                  |
|---------------------------------------|----|------------------|
| Weight of crucible + raw bone-meal    | .. | 30.336 grammes.  |
| Weight of crucible alone              | .. | —29.336 "        |
| <hr/>                                 |    |                  |
| ∴ Weight of raw bone-meal taken       | .. | — 1 gramme.      |
| Weight of crucible + raw bone-meal    | .. | —30.336 grammes. |
| Weight of crucible + ignited residue  | .. | —29.958 "        |
| <hr/>                                 |    |                  |
| ∴ Weight of organic matter + moisture | .. | — .377 grammes.  |
| Weight of glass + clip + raw bone     | .. | —28.428          |
| Weight of glass + clip alone          | .. | —25.428          |
| <hr/>                                 |    |                  |
| ∴ Weight of raw bone taken            | .. | —3 grammes.      |
| Weight of glass + clip + raw bone     | .. | —28.428          |
| Weight of glass + clip + dry bone     | .. | —28.110          |
| <hr/>                                 |    |                  |

*Moisture and organic matter*—contd.

|   |    |    |   |                    |
|---|----|----|---|--------------------|
| ∴ Weight of <i>moisture</i> lost            | .. | .. | — | ·318 in 3 grammes. |
| ∴ in 1 gramme the loss is                   | .. | .. | — | ·106 grammes (I).  |
| ∴ the weight of <i>organic matter</i> alone | .. | .. | — | ·377—·106          |
|   |    |    | — | ·271 grammes (II). |

*Sand*—

|                           |    |    |   |        |
|---------------------------|----|----|---|--------|
| Weight of crucible + sand | .. | .. | — | 29·396 |
| Weight of crucible alone  | .. | .. | — | 29·335 |

|                               |    |            |    |       |
|-------------------------------|----|------------|----|-------|
|                               |    |            |    | ————— |
|                               |    | Difference | .. | —     |
| Deducting weight of paper ash | .. | ..         | —  | ·060  |
|                               |    |            |    | ————— |

|                       |    |    |    |   |                     |
|-----------------------|----|----|----|---|---------------------|
| Weight of <i>sand</i> | .. | .. | .. | — | ·058 grammes (III). |
|-----------------------|----|----|----|---|---------------------|

*Phosphates*—

|                                 |    |    |   |        |
|---------------------------------|----|----|---|--------|
| Weight of phosphates + crucible | .. | .. | — | 29·694 |
| Weight of crucible alone        | .. | .. | — | 29·335 |

|                               |    |            |    |       |
|-------------------------------|----|------------|----|-------|
|                               |    |            |    | ————— |
|                               |    | Difference | .. | —     |
| Deducting weight of paper ash | .. | ..         | —  | ·002  |
|                               |    |            |    | ————— |

|  |    |    |   |               |
|--|----|----|---|---------------|
| Weight of phosphates                               | .. | .. | — | ·357 grammes. |
| Weight of crucible + 2nd precipitate of phosphates | .. | .. | — | 29·396        |
| Weight of crucible alone                           | .. | .. | — | 29·335        |

|                               |    |            |    |       |
|-------------------------------|----|------------|----|-------|
|                               |    |            |    | ————— |
|                               |    | Difference | .. | —     |
| Deducting weight of paper ash | .. | ..         | —  | ·002  |
|                               |    |            |    | ————— |

|   |    |    |   |                     |
|---|----|----|---|---------------------|
| Weight of the 2nd precipitate                         | .. | .. | — | ·058                |
| Total weight of the <i>two phosphate precipitates</i> | .. | .. | — | ·357                |
|   |    |    | + | ·058                |
|   |    |    |   | —————               |
|   |    |    |   | =.416 grammes (IV). |

*Calcium Carbonate*—

|  |    |    |   |                |
|--|----|----|---|----------------|
| Weight of crucible + CaCO <sub>3</sub> precipitate | .. | .. | — | 29·47 grammes. |
| Weight of crucible alone                           | .. | .. | — | 29·335 „       |

|                     |    |            |    |       |
|---------------------|----|------------|----|-------|
|                     |    |            |    | ————— |
|                     |    | Difference | .. | —     |
| Deducting paper ash | .. | ..         | —  | ·002  |
|                     |    |            |    | ————— |

|  |    |    |    |   |                   |
|--|----|----|----|---|-------------------|
| Weight of <i>Calcium Carbonate</i> in 1 gramme | .. | .. | .. | — | ·133 grammes (V). |
|--|----|----|----|---|-------------------|

*Nitrogen.*—The H<sub>2</sub> SO<sub>4</sub> bulb took exactly 91 c.c. of NaHO solution. ∴ the NH<sub>3</sub> in 1 gramme is equivalent to 9 c.c. of alkali, which is equivalent to 9 × ·0031095 = ·0279855 grammes of N = ·03398 grammes of NH<sub>3</sub> = 3·4 per cent.

The percentage composition of the sample of bone-meal is therefore :—

|                                   |    |    |    |       |
|-----------------------------------|----|----|----|-------|
| (I) Moisture                      | .. | .. | .. | 10.62 |
| (II) Organic matter*              | .. | .. | .. | 27.15 |
| (III) Sand                        | .. | .. | .. | 5.85  |
| (IV) Phosphates                   | .. | .. | .. | 41.60 |
| (V) Calcium carbonate             | .. | .. | .. | 13.27 |
| (VI) Saline matter (undetermined) | .. | .. | .. | 1.50  |
|                                   |    |    |    | 100.0 |

\* Containing 3.4% of  $\text{NH}_3$ .

## CHAPTER XCV.

### ANALYSIS OF SUPERPHOSPHATE.

IN analysing a sample of Superphosphate of lime, the following points should be determined :—

(1) Moisture ; (2) Loss on ignition ; (3) Sand ; (4) Lime ; (5) Soluble Phosphate or Monocalcic Phosphate ( $\text{Ca}_4\text{P}_2\text{O}_8$ ) ; (6) Insoluble Phosphate or Tricalcic Phosphate ( $\text{CaH}_3\text{P}_2\text{O}_8$ ).

The sample taken should be well ground and bluish grey in colour.

(1) *Moisture*.—Three grammes of the sample are weighed out on a watch-glass ; and left in the water-oven over-night. Next morning it is covered up and secured with the cover-glass and the clip, put inside the desiccator, and when cool, weighed. It is left in the oven for another hour and treated in the same way ; until the weight is found to be exactly the same as before. The loss of weight is due to the escape of moisture from the three grammes of the superphosphate.

(2) *Loss on Ignition*.—One gramme of the sample is weighed out in a crucible of known weight, very slowly ignited at a low red heat, for about a quarter of an hour, until the colour of the whole mass becomes much lighter. It is then laid aside in the desiccator, and afterwards, when quite cool, weighed. The loss of weight is due to the escape of moisture, organic and other readily volatile matter.

(3) *Sand*.—The residue in the crucible of the one gramme just ignited is emptied into a clean beaker, every particle in the crucible being carefully washed out with hydrochloric acid. A little more hydrochloric acid is added, altogether about 50 c.c. and the beaker left uncovered in the sand-bath. When the contents of the beaker become dry, it is taken out, and strong hydrochloric acid, enough to moisten the contents of the beaker, added. After a quarter of an hour, about 200 c.c. of water are added and the beaker left covered in the sand-bath over-night. The siliceous residue in the beaker is filtered out, thoroughly washed, and left over-night in the water-oven to dry. Next morning the siliceous

matter is transferred to a platinum crucible, the paper burnt white, the crucible ignited, left for about half an hour to cool in the desiccator, and finally weighed. The increase of weight of the crucible is due to the siliceous matter present in the one gramme of superphosphate.

(4) *Lime*.—The filtrate and washings from the siliceous matter in one gramme of superphosphate are treated with a few drops of dilute ammonia, with constant stirring, until a permanent opalescence is just produced. A few drops of acetic acid are then added which in a moment clear the solution. Ammonium oxalate is then added, with constant stirring, until it ceases to produce any more precipitation and the solution boiled. The beaker is then left covered up in the sand-bath for some time for the calcium oxalate to collect at the bottom. The calcium oxalate precipitate is collected on a filter-paper, and the filtrate containing all the phosphates collected under the filter on a clean beaker. The precipitate is thoroughly washed with hot water, dried in the water-oven, and next day collected in a weighed platinum crucible, the white ash of the filter-paper being also put into it. The crucible is ignited at a low temperature, for about a quarter of an hour, to convert the calcium oxalate into calcium carbonate, but not into calcium oxide. It is cooled in the desiccator, and weighed. The increase of weight of the crucible is due to the calcium carbonate equivalent to the lime present in one gramme of the superphosphate, the usual allowance for the paper ash being made.

(5) *Total Phosphates*.—The filtrate and washings, from the lime precipitate, are concentrated to about 60 c.c. by boiling them in a beaker. When cool, about one gramme of citric acid is added, and then to avoid diluting the contents of the beaker, about fifty cubic centimetres of very strong ammonium hydrate are added, until the liquid becomes strongly ammoniacal. Usually no precipitate follows. If a precipitate immediately follows, it would indicate the presence either of lime, iron, or alumina. The next step, *viz.*, the addition of magnesium chloride solution, should be made when the liquid is quite cool, in the beaker. Half a test tubeful of the "Magnesia Mixture" is added, and the beaker left covered in a cool place. Next day (*i.e.*, at least twelve hours afterwards), the crystalline precipitate in the beaker is collected on a filter-paper, washed with rather strong ammonia water, dried in the water-oven, and collected in the usual way in a weighed crucible. The filter-paper is ignited white, and added to the precipitate. The crucible is then ignited, first on the Bunsen flame and afterwards before the blow-pipe flame for five minutes. It is left in the desiccator to cool, and afterwards weighed. The increase of weight of the crucible is due to the magnesium pyrophosphate formed in combination with the total phosphoric acid in one gramme of superphosphate.

(6) *Insoluble Phosphate*.—Five grammes of the well-mixed sample of superphosphate are weighed out on a watch-glass. Half



a litre or 500 c.c. of distilled water is measured out into the wash-bottle, previously completely emptied. This water is used for the process of mixing up the superphosphate with water. The mixing is done in the following way :—The five grammes of superphosphate are transferred, with the help of a feather finally, into a clean and dry mortar. The outside of the lip of the mortar is rubbed with a little grease to ensure the running out of all the water from the mortar to the green bottle. The superphosphate is then rubbed smooth with the pestle, a little water being added to it from the wash-bottle. Great care should be taken that none of the water in the wash-bottle might be wasted or spilt outside the mortar. The mixture is then left undisturbed for a few minutes, and the supernatant liquid is drained off carefully from the mortar along a clean and dry glass rod into a clean and dry stoppered bottle. As a further security against loss of water, a funnel is placed on the bottle, and the water drained down on the funnel. The operation of rubbing the superphosphate and a further quantity of water is continued, several times, and each time the supernatant liquid is drained off into the bottle, until the residue in the mortar appears quite siliceous. The mortar is then cleaned out perfectly with the remaining quantity of water in the wash-bottle, and the contents of the mortar wholly transferred to the bottle. The bottle is then stoppered, and shaken every now and again for three hours together. It is then left to settle for over twelve hours. 100 c.c. are then filtered through into a clean measured cylinder. This 100 c.c. containing the soluble phosphate in one gramme of superphosphate are transferred into a beaker; and the calcium carbonate and the magnesium phosphate are separated out in exactly the same way as in the case of the total lime and phosphate in one gramme as already described. Only in this case the calcium oxalate precipitate, after being thoroughly washed, is thrown away, and the filtrate treated with magnesia mixture as previously described.

The following calculations refer to an actual analysis of a sample of super :—

(1) *Moisture*—

|                                      |    |    |    |                |
|--------------------------------------|----|----|----|----------------|
| Watch-glass and clip and raw "super" | .. | .. | .. | —28·4287       |
| (3 grammes) .. ..                    | .. | .. | .. | —27·9350       |
| Watch-glass × clip × dry super       | .. | .. | .. | —————          |
| Moisture in 3 grammes                | .. | .. | .. | —·4937         |
| ∴ Moisture in 1 gram                 | .. | .. | .. | —·1645         |
|                                      |    |    |    | <u>—16·46%</u> |

(2) *Loss on ignition*—

|                                       |    |    |    |                |
|---------------------------------------|----|----|----|----------------|
| Crucible + lid + raw "super" (1 grm.) | .. | .. | .. | —30·3280       |
| Crucible .. lid .. ignited super      | .. | .. | .. | —30·0375       |
|                                       |    |    |    | —————          |
|                                       |    |    |    | ·2905          |
|                                       |    |    |    | <u>—29·05%</u> |

(3) *Sand*—

|                          |    |    |         |
|--------------------------|----|----|---------|
| Crucible + lid + sand    | .. | .. | 29·3955 |
| Crucible .. lid .. alone | .. | .. | 29·3290 |
|                          |    |    | <hr/>   |
|                          |    |    | ·0665   |
| Less paper ash           | .. |    | ·0020   |
|                          |    |    | <hr/>   |
|                          |    |    | ·0645   |
|                          |    |    | — 6·45% |

(4) *Total Lime (Calcium Carbonate)*—

|                                      |    |    |         |
|--------------------------------------|----|----|---------|
| Crucible + precipitate and paper ash | .. | —  | 29·7662 |
| Crucible alone                       | .. | .. | 29·3280 |
|                                      |    |    | <hr/>   |
|                                      |    |    | ·4382   |
| Less paper ash                       | .. |    | ·0020   |
|                                      |    |    | <hr/>   |
|                                      |    |    | ·4362   |
|                                      |    |    | —43·63% |

(5) *Total phosphates*—

|                                    |    |    |             |
|------------------------------------|----|----|-------------|
| Crucible + Magnesium pyrophosphate | .. | —  | 29·545      |
| Crucible alone                     | .. | .. | 29·328      |
|                                    |    |    | <hr/>       |
|                                    |    |    | ·217        |
| Deduct paper ash                   | .. | .. | ·002        |
|                                    |    |    | <hr/>       |
|                                    |    |    | ·215 —21·5% |

(6) *Precipitated phosphates in the soluble portion*—

|                                    |    |    |          |
|------------------------------------|----|----|----------|
| Crucible + Magnesium pyrophosphate | .. | —  | 29·520   |
| Crucible alone                     | .. | .. | 29·328   |
|                                    |    |    | <hr/>    |
|                                    |    |    | ·192     |
| Deduct ash                         | .. | .. | ·002     |
|                                    |    |    | <hr/>    |
|                                    |    |    | ·19 —19% |

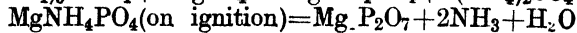
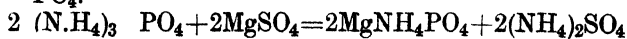
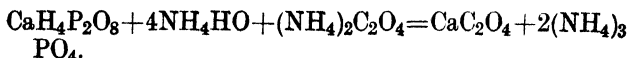
(7) To calculate the *Monocalcium phosphate*—

$\text{Mg}_2\text{P}_2\text{O}_7 : \text{CaH}_4\text{P}_2\text{O}_8 :: 190 : \text{percentage of CaH}_4\text{P}_2\text{O}_8$   
in the soluble portion.

i.e., 222 : 234 :: 19 : percentage of monocalcium phosphate present.

∴ The percentage of monocalcium phosphate in 1 gramme of superphosphate =  $\frac{19 \times 234}{222} = 20·03\%$

(8) To calculate the *Tricalcium phosphate*—

The total  $\text{Mg}_2\text{P}_2\text{O}_7$  came partly from the mono and partly from the Tricalcium phosphate.

∴ Taking 19 from 21·5, 2·5% is left as the amount from the Tricalcium phosphate.

Now,  $\text{Ca}_3\text{P}_2\text{O}_8 + 3(\text{NH}_4)_2\text{C}_2\text{O}_4 = 3\text{CaC}_2\text{O}_4 + 2(\text{NH}_4)_3\text{PO}_4$   
 $2(\text{NH}_4)_3\text{PO}_4 + 2\text{MgSO}_4 = 2\text{NH}_4\text{MgPO}_4 + 2(\text{NH}_4)_2\text{SO}_4$   
 $2\text{NH}_4\text{MgPO}_4$  (on ignition)  $= \text{Mg}_2\text{P}_2\text{O}_7 + 2\text{NH}_3 + \text{H}_2\text{O}$   
 $\text{Mg}_2\text{P}_2\text{O}_7 : \text{Ca}_3\text{P}_2\text{O}_8 :: 2.5 : \text{percentage of } \text{Ca}_3\text{P}_2\text{O}_8$   
 (=222) (=310) in 1 gramme of super.

$$\therefore \text{Ca}_3\text{P}_2\text{O}_8 \text{ present} = \frac{2.5 \times 310}{222} = 3.49\%$$

(9) "Organic matter."—

The total loss on ignition (*i.e.*, 29.05%) is made up partly of water going off at 100°C, partly of the water that monocalcium phosphate loses on ignition and the rest is the water of crystallization of sulphate of lime which cannot be calculated, together with the real organic matter.

Now,  $\text{CaH}_4\text{P}_2\text{O}_8$  (on ignition)  $= \text{CaP}_2\text{O}_6 + 2\text{H}_2\text{O}$  (=36)  
 (=234)

$\text{CaH}_4\text{P}_2\text{O}_8 : 2\text{H}_2\text{O} :: \text{CaH}_4\text{P}_2\text{O}_8 \text{ present} : \% \text{ of } \text{H}_2\text{O} \text{ lost}$   
 by the monocalcic phosphate present on ignition.

$\therefore \text{H}_2\text{O}$  lost by the monocalcium phosphate on ignition

$$= \frac{20.03 \times 36}{234} = 3.08\%$$

But the loss of  $\text{H}_2\text{O}$  at 100°C = 16.46%

$\therefore$  Taking away 16.46 + 3.08, or 19.54%, from the total loss on ignition,

*i.e.*, 29.05%, we get 9.51% as the proportion of "organic matter, etc.," present in the superphosphate.

The percentage composition of the sample of superphosphate of lime analysed was:—

|                                    |   |  |
|------------------------------------|---|--|
| Moisture                           | — | 16.46%                                   |
| "Organic matter, etc."             | — | 9.51 "                                   |
| Sand                               | — | 6.45 "                                   |
| $\text{CaH}_4\text{P}_2\text{O}_8$ | — | 20.03 " (=26.6% of "soluble phosphate"). |
| $\text{Ca}_3\text{P}_2\text{O}_8$  | — | 3.49 "                                   |
| $\text{CaSO}_4$                    | — | 43.10 "                                  |
| Alkalies, etc.                     | — | .96 "                                    |
|                                    |   | 100.00                                   |

## CHAPTER XCVI.

### ANALYSIS OF NITRATE OF SODA AND SALTPETRE.

IN analysing a sample of nitrate of soda, or of nitrate of potash, the method employed is to find out the impurities and to estimate the amount of pure nitrate of soda, or potash by difference. These impurities are generally—(1) *Moisture*, (2) *Sand and other insoluble matter*, (3) *Sodium chloride*, (4) *Sodium and Calcium sulphate*.

Thirty-five grammes of a sample of sodium nitrate or potassium nitrate should be weighed out, and put in a clean beaker, and dissolved in about 300 c.c. of distilled water. A filter-paper is at the same time put inside a tube and left in the water-oven to dry. Next day, the tube is stoppered and put aside to cool, weighed after an hour, and weighed again after two or three hours, and when the weight is constant, the filter-paper is brought out of the tube, fitted into a funnel, wetted, and the solution of the nitrate to be analysed passed through into a clean beaker. The residue on the filter-paper is thoroughly washed, covered up with a clean piece of paper, and the funnel left in the water-oven to dry. Next day the filter-paper is taken out with the insoluble residue on it, put inside the tube again, left in the water-oven, after an hour taken out, stoppered, and weighed. It is weighed again after a few more hours until the weight is found to remain constant. The difference of weight gives the amount of insoluble matter in thirty-five grammes of the nitrate analysed. This is therefore—the *total insoluble matter, including sand*. The filter-paper is ignited white, and put in a weighed platinum crucible. The increase of weight is due to sand and other siliceous matter alone, the usual allowance being made for the filter-paper ash.

(2) The *moisture* is determined in the usual way. Three grammes are weighed out in a watch-glass, left in the water-oven, weighed next day, and weighed again, both times when cool, until the weight is constant. The loss of weight is due to the amount of moisture in the three grammes of the sample of the nitrate.

(3) *Sodium Chloride*.—The filtrate containing the remainder of the 35 grammes, after the insoluble matter has been separated, is made exactly into half a litre or 500 c.c. Of this, 100 c.c. should be sucked out containing seven grammes of the nitrate analysed, by means of a large pipette, and placed on a clean porcelain basin. This is treated with two drops of potassium chromate which is used as an indicator. The standard solution of silver nitrate is taken in a burette. When the surface of the solution inside the burette stands exactly at zero, it is gradually poured into the nitrate solution. The mixture on the basin is kept continually stirred. Potassium chromate gives a reddish brown precipitate with silver nitrate with the formation of silver chromate. But this is not permanent, as the chlorine present as sodium chloride as an impurity in the nitrate solution is immediately attacked by silver chromate to form silver chloride. When sufficient of the silver nitrate solution has been used, all the chlorine gets just used up. This is indicated by the formation of a slightly permanent reddish brown colour due to silver chromate.

(4) *Lime* is determined in the usual way: 100 c.c. of the remainder of the nitrate solution is sucked up with a pipette, placed in a clean beaker, heated nearly to boiling, ammonium oxalate and ammonia are added in excess until all precipitation ceases, and the liquid smells strongly ammoniacal. It is left

covered up over-night in the sand-bath, then filtered, washed, dried, gently ignited, and weighed in the usual way. The weight of calcium carbonate determined is due to the amount of calcium sulphate present in seven grammes of the sample of the nitrate (*i.e.*, 100 c.c. of the solution).

(5) *Sulphates*.—100 c.c. of the original 500 c.c. of the nitrate solution should be taken and made into 300 c.c. with distilled water, boiled, and precipitated with barium chloride, after addition of a few drops of hydrochloric acid. The precipitate is allowed to settle in the sand-bath. It is next day filtered, dried, ignited and weighed in the usual way, and the amount of barium sulphate determined, taken in connection with the amount of lime previously determined, gives the amount of calcium sulphate present as impurity.

*The Standard Silver Nitrate Solution*.—For estimation of chlorine in substances analysed, it is necessary to have a standard solution of silver nitrate always ready. The decinormal solution is in general use. It is made by dissolving 16·97 grammes of pure silver nitrate in 1000 c.c. of distilled water. The solution must be neutral. Now the molecular weight of silver nitrate is 169·7, and as the solution made contains 16·97 grammes of the salt, it contains  $\frac{1}{10}$ th of the molecular weight of silver nitrate in grammes per litre. 1 c.c. of this solution therefore represents 10000 of the molecular weight of chlorine, or of sodium chloride, *i.e.*, ·00355 grammes of chlorine, or ·00585 grammes of sodium chloride.

The solution in which the chlorine or sodium chloride has to be determined must either be neutral, or slightly alkaline with a fixed alkali, or slightly acidulated with acetic acid. The potassium chromate used for titration must be also neutral and free from chlorides.

The following calculations refer to an actual analysis of a sample of sodium nitrate :—

|                                     |    |                |
|-------------------------------------|----|----------------|
| Porcelain crucible + sodium nitrate | .. | —60·65 grammes |
| Porcelain crucible alone            | .. | —25·65     ,,  |
|                                     |    | 35 grammes.    |

(1) *Moisture*—

|                                      |    |          |
|--------------------------------------|----|----------|
| Watch-glass + clip + nitrate of soda | .. | —27·3725 |
| Watch-glass + clip + dry salt        | .. | —27·2245 |

∴ Moisture in 3 grammes .. .. .148  
 Moisture in 1 gramme .. .. .04933—49·3 per cent.

(2) *Insoluble matter*—

|   |    |         |
|---|----|---------|
| Glass tube + stopper + paper + insoluble matter | —  | 13·180  |
| Tube + stopper + paper                          | .. | —13·832 |

Insoluble matter in 35 grammes .. .. .048  
 ∴ Insoluble matter in 1 gramme .. .. —00137—·14 per cent

*After ignition.*—

|                              |    |    |    |                |
|------------------------------|----|----|----|----------------|
| Crucible + ash               | .. | .. | .. | —29·3620       |
| Crucible alone               | .. | .. | .. | —29·3315       |
|                              |    |    |    | ·0305          |
| ∴ Insoluble siliceous matter | .. | .. | .. | —·09 per cent. |

(3) *Sulphates.*—

|  |    |    |    |                |
|--|----|----|----|----------------|
| Crucible + barium sulphate + paper ash | .. | .. | .. | —29·3650       |
| Crucible alone                         | .. | .. | .. | —29·3315       |
|  |    |    |    | ·0335          |
| Less paper ash                         | .. | .. | .. | —·0020         |
|  |    |    |    | ·0315          |
| Barium sulphate in 7 grammes           | .. | .. | .. | —·0315         |
| ∴ Barium Sulphate                      | .. | .. | .. | —·45 per cent. |

(4) *Lime.*—

|                                      |    |    |    |               |
|--------------------------------------|----|----|----|---------------|
| Crucible + calcium carbonate + paper | .. | .. | .. | —29·3425      |
| Crucible alone                       | .. | .. | .. | —29·3305      |
|                                      |    |    |    | ·0120         |
| Less paper ash                       | .. | .. | .. | —·002         |
|                                      |    |    |    | ·01           |
| ∴ Calcium carbonate                  | .. | .. | .. | ·14 per cent. |
| Equal to calcium sulphate            | .. | .. | .. | ·19 per cent. |

(5) *Chloride.*—

|  |                        |
|--|------------------------|
| 76.3 c.c. of silver nitrate solution were required for 7 grammes           |                        |
| ∴ 10.9 c.c. for 1 gramme   |                        |
| But 1 c.c. Ag NO <sup>3</sup> (standard)—·00589 grammes of sodium chloride |                        |
| ∴ The amount of sodium chloride present                                    |                        |
|  | —·00585 + 10.9         |
|  | —·06376—6·38 per cent. |

The percentage composition of the sample of nitrate of soda analysed is, therefore :—

|                        |    |   |       |           |
|------------------------|----|---|-------|-----------|
| (1) Moisture           | .. | — | 4·93  | per cent. |
| * (2) Insoluble matter | .. | — | ·14   | "         |
| (3) Calcium sulphate   | .. | — | ·19   | "         |
| (4) Sodium sulphate    | .. | — | ·07   | "         |
| (5) Sodium chloride    | .. | — | 6·38  | "         |
| (6) Sodium nitrate]    | .. | — | 88·29 | "         |
|                        |    |   | 100·0 |           |

\* Containing sand—·09%.

## CHAPTER XCVII.

## ANALYSIS OF OIL-CAKE.

FOR FODDER.—In analysing a sample of oil-cake for fodder, the proximate constituents to be determined are six in number :—(1) Moisture ; (2) Ash ; (3) Fibre ; (4) Oil ; (5) Albuminoid matter ; and (6) Soluble organic matter.

(1) *Moisture.*—To determine the amount of moisture present in the sample, three grammes of the powdered cake should be measured

out on a watch-glass and left in the water-oven to dry. After a few hours it is weighed again. After another hour it is weighed a third time, and when it is found to remain constant in weight since the last weighing, the difference from the original weight is calculated as being due to loss of moisture in three grammes. At the two last weighings the usual precautions of cooling the substance inside the desiccator, covering it up with another watch-glass and fastening them together by means of the clip, should be taken.

(2) *Ash* or mineral matter. Two grammes of the cake should be weighed out in the platinum crucible, already cleaned, ignited and cooled in the desiccator. The cake is ignited on the Bunsen flame. When rendered quite white, *i.e.*, after about half an hour, it is set aside in the desiccator to cool. When cool, it is weighed, and the difference between this weight and the weight of the crucible alone is due to the ash ingredients in the two grammes.

(3) *Fibre*, or indigestible and insoluble organic matter.—Three grammes of the sample should be weighed out in a beaker. Two scratches should be made on the side of the beaker, one at 150 c.c. and the other at 200 c.c., 150 c.c. of distilled water should be added to the cake, and the beaker placed on the wire gauze over the flame. The whole is brought to boiling with continual stirring to prevent burning. At this stage 50 c.c. of sulphuric acid solution containing five per cent. of pure sulphuric acid are added to the mixture; and the boiling continued exactly for half an hour after that. The normal value of 200 c.c. is maintained throughout by the addition of hot water at intervals during the half hour. The residue from this acid-digestion is collected over a filter on a piece of linen cloth. It is washed several times with hot water while on the cloth and then when it ceases to turn litmus paper red, it is transferred to a beaker. 150 c.c. of water are added again, and the mixture brought again to boiling, and at this stage 50 c.c. of a five per cent. solution of caustic potash are added. The mixture should be boiled exactly for half an hour again. It is again filtered through linen, washed, and transferred to a weighed crucible. The crucible is left on the steam-bath over-night and in the morning transferred to the water-oven. When perfectly dry it is weighed, the increase of weight being due to the insoluble fibrous matter contained in three grammes. From this is subtracted the weight of the ash which is determined by igniting the fibrous matter in the crucible, cooling it in the desiccator and weighing it again.

(4) *Oil*.—Two grammes of the finely powdered cake are folded up in a piece of filter-paper, and inserted in a tube between plugs of carded cotton-wool; above the upper cotton plug is placed a loosely coiled brass spiral. It is then placed in a Soxhlet fat extractor, the lower end of the extractor attached to a wide mouthed flask containing ether by a cork, and the upper end to a long inserted condenser. The ether is then kept boiling for three hours





The percentage composition of the sample of oil-cake analysed was, therefore :—

|                                     |        |
|-------------------------------------|--------|
| (1) Moisture .. .. .                | 10.24  |
| (2) Ash .. .. .                     | 6.91   |
| (3) Fibre .. .. .                   | 6.46   |
| (4) Oil .. .. .                     | 11.85  |
| (5) Albuminoids .. .. .             | 40.74  |
| (6) Soluble organic matters .. .. . | 23.78  |
|                                     | 100.00 |

*Starch and sugar.*—While analysing a sample of *linseed* cake for fodder, it should be noted if there is any starch or sugar in the cake, which are indicative of adulteration. Two grammes of cake may be taken in a small beaker, 100 c.c. of water added, the mixture boiled for five minutes, and then allowed to cool. One portion is to be decanted off (not filtered), when quite cold, into a porcelain basin and tincture of iodine added drop by drop. If any blue colour is noticed while stirring, the presence of starch is to be inferred.

*Analysis of oil-cake for manure.*—If an oil-cake is used both as a fodder and manure, besides moisture, ash, fibre, oil, and albuminoids, which are found out in analysing oil-cake which is used as fodder alone, the amounts of sand, lime, phosphoric acid and potash, present in the ash, should be determined. If, as in the case of castor-cake and *mahua*-cake, the substance is not required for fodder but for manure alone, it is unnecessary to find out the proportions of oil, fibre and albuminoids in the sample, but it is very necessary to find out the proportions of lime, phosphoric acid and potash besides nitrogen, and foreign substances such as sand.

After determining the percentage of ash in the usual way, the ash is dissolved in half a litre of distilled water; each 100 c.c. representing three grammes of cake in the example given below, fifteen grammes of cake being ignited for obtaining the ash for analysis.

200 c.c. of the solution (representing six grammes of the cake) should then be taken. Ferric chloride is then added and ammonia to take down the jelly-like precipitate. The precipitate is washed with ammonia water. The precipitate is collected in a beaker, and dissolved in nitric acid; ammonium molybdate is added, the phosphoric acid precipitated and estimated as in the case of analysis of soil.

The filtrate and washings are concentrated by boiling, and ammonium oxalate added to precipitate the lime as calcium oxalate.

The filtrate and washings from the last are taken to dry in a sand-bath, ignited on a porcelain basin, and treated as in the case of soil in estimating potash.

The following example shows how an analysis of a sample of oil-cake for manure is worked out:—

(1) *For moisture.*—

|                             |    |    |               |
|-----------------------------|----|----|---------------|
| Watch-glasses+clip+raw cake | .. | .. | —25·743       |
| Watch-glasses+clip          | .. | .. | —24·743       |
| Watch-glasses+clip+dry cake | .. | .. | —25·659       |
| ∴ Moisture in 1 gramme      | .. | .. | ·0835 = 8·35% |

(2) *Organic matter, &c.*—

|                                       |    |    |                 |
|---------------------------------------|----|----|-----------------|
| Crucible+ignited cake (1 gramme)      | .. | .. | —30·3280        |
| Crucible alone                        | .. | .. | —29·4785        |
| ∴ Loss on ignition                    | .. | .. | —·8495 = 84·95% |
| Deducting 8·35 per cent. for moisture | .. | .. | —76·60          |

(3) *Sand, &c.*—

|                              |    |    |               |
|------------------------------|----|----|---------------|
| Crucible+sand, &c.           | .. | .. | —30·390       |
| Crucible alone               | .. | .. | —29·327       |
| ∴ Sand, &c., in 15 grammes   | .. | .. | —1·063        |
| Deducting ·002 for paper ash | .. | .. | —1·061        |
| ∴ In 1 gramme                | .. | .. | ·0707 = 7·07% |

(4) Nitrogen calculated as *Ammonia.*—

|   |    |    |             |
|---|----|----|-------------|
| Watch-glass—cake  | .. | .. | —6·7855     |
| Watch-glass alone   | .. | .. | —6·1866     |
| ∴ The quantity taken  | .. | .. | —·5989 grm. |
| 50 + 39½ c.c. = 89½ c.c. of the standard caustic soda solution was required to neutralize the sulphuric acid taken. |    |    |             |

∴ 100—89½ = 10½ c.c. of standard caustic soda was replaced by ammonia coming from the ·5989 grammes of the cake.

But 1 c.c. of the alkali represents ·0037716 grammes of ammonia.

∴ 10½ c.c. represents ·0396018 grammes of ammonia in ·5989 grammes of the cake.

∴ In 1 gramme of the cake, the ammonia would be ·066 grammes = 6·61% = 4·43% of albuminoids.

(5) *Calcium carbonate.*—

|  |    |    |               |
|--|----|----|---------------|
| Crucible+CaCO <sub>3</sub> from 200 c.c.—paper ash | .. | .. | —29·402       |
| Crucible alone                                     | .. | .. | —29·326       |
| ∴ CaCO <sub>3</sub> —paper ash                     | .. | .. | —·076         |
| Deducting ·002 for paper ash                       | .. | .. | —·074         |
| CaCO <sub>3</sub> in 6 grammes                     | .. | .. | —·074         |
| ∴ In 1 gramme                                      | .. | .. | ·0123 = 1·23% |

(6) *Phosphoric acid.*—

|   |    |    |                |
|---|----|----|----------------|
| Crucible—Mg <sub>2</sub> P <sub>2</sub> O <sub>7</sub> —paper ash   | .. | .. | —29·4675       |
| Crucible alone  | .. | .. | —29·3255       |
| ∴ Mg <sub>2</sub> P <sub>2</sub> O <sub>7</sub> from 6 grammes  | .. | .. | —142           |
| Deducting ·002 for ash  | .. | .. | —14            |
| ∴ Mg <sub>2</sub> P <sub>2</sub> O <sub>7</sub> in 1 gramme   | .. | .. | —0·233 = 2·33% |
| Mg <sub>2</sub> P <sub>2</sub> O <sub>7</sub> : P <sub>2</sub> O <sub>5</sub> :: 2·33 : P O <sub>5</sub> in cake. |    |    |                |
| ∴ P <sub>2</sub> O <sub>5</sub> in the sample   | .. | .. | = 1·49%        |

7) *Potash.*—

|  |    |    |                 |
|--|----|----|-----------------|
| Crucible+ppt.  | .. | .. | —26·015         |
| Crucible alone   | .. | .. | —25·6575        |
| ∴ K <sub>2</sub> Cl. Pt Cl <sub>2</sub> K in 6 grammes   | .. | .. | —·3575          |
| ∴ In 1 gramme  | .. | .. | —0·0596 = 5·96% |
| PtCl <sub>4</sub> K <sub>2</sub> Cl : K <sub>2</sub> O :: 5·96 : amount of K <sub>2</sub> O present. |    |    |                 |
| ∴ amount of K <sub>2</sub> O present   | .. | .. | = 1·15%         |

The following therefore are the results of the analysis of the sample of the oil-cake for manure :—

|                       |    |    |    |    |                 |
|-----------------------|----|----|----|----|-----------------|
| Moisture              | .. | .. | .. | .. | —8·35 per cent. |
| * Organic matter, etc | .. | .. | .. | .. | —76·60 ”        |
| † Ash                 | .. | .. | .. | .. | —15·05 ”        |
|                       |    |    |    |    | 100·00          |

\* Containing 34·43% of nitrogenous matter calculated as albuminoids.

† Containing—

|                 |    |    |    |    |                  |
|-----------------|----|----|----|----|------------------|
| Silicates, etc. | .. | .. | .. | .. | — 70·7 per cent. |
| Lime            | .. | .. | .. | .. | — ·69 ”          |
| Phosphoric acid | .. | .. | .. | .. | — 1·49 ”         |
| Potash          | .. | .. | .. | .. | — 1·15 ”         |

## CHAPTER XCVIII.

### ANALYSIS OF SILAGE, GRASS, ETC.

IN analysing leaves, hay, silage and roots, some difference has to be made in the estimation of albuminoids from the method recommended for oil-cake for fodder, though the moisture, oil, fibre and ash are determined as in the case of oil-cakes. Leaves, etc., contain nitrates, amides and amines, which have little or no feeding value. True albuminoids should be separated from other nitrogen-compounds and the nitrogen in these alone estimated by one of the two processes described in connection with the analysis of soil. The separation of true albuminoids is done in the following way :—

Orthophosphoric acid is put on the lid of a platinum crucible and gently heated on a triangle over a Bunsen flame. Spurting is avoided by moving about the Bunsen flame. When it becomes quite glassy, orthophosphoric acid changes into metaphosphoric acid. In this state it is put inside a beaker along with the lid of the crucible and a little distilled water to dissolve the metaphosphoric acid. Two grammes of silage, hay, or any other food-stuff of this class that is analysed, are put in a beaker, moistened with a warm phenol solution (4' ), and a few drops of the metaphosphoric acid solution are added. After a quarter of an hour 100 c.c. of the same phenol solution in a boiling state are added, the mixture stirred, and then left to cool. The whole is then transferred to a filter, the washing being done with the help of a wash-bottle containing the same phenol solution in a cold state. The albuminoids getting coagulated by the phenol solution remain on the filter, while the non-albuminoid nitrogenous compounds pass off with the filtrate. The contents of the filter are then dried and the nitrogen therein estimated by Kjeldahl's method as already described.

The following figures refer to an actual analysis of a sample of silage :—

*Moisture.*—

|                                  |                           |
|----------------------------------|---------------------------|
| Crucible + powdered silage .. .. | —30·860                   |
| Crucible alone .. ..             | —29·327                   |
|                                  | 533 grammes taken.        |
| Crucible—dry silage .. ..        | —30·755                   |
| ∴ Loss in 1·533 grammes .. ..    | —105—6·84%                |
| Dry silage taken .. ..           | —1·533—105—1·428 grammes. |

*Fibre.*—

|   |                  |
|---|------------------|
| Glass + stopper + silage .. ..            | —37·446          |
| Glass + stopper .. ..                     | —34·446          |
|   | 3 grammes taken. |
| Wt. of porcelain crucible + d fibre .. .. | —12·0995         |
| Wt. of porcelain crucible alone .. ..     | —10·9665         |
|   | —1·1330          |
|   | —37·76%          |

*Ash.*—

|   |                     |
|---|---------------------|
| Crucible—dry silage .. ..                 | —30·7550            |
| Crucible—ignited residue .. ..            | —29·4445            |
|   | 1·3105 org. matter. |
| Crucible alone .. ..                      | —29·3270            |
| ∴ 1175—ash in 1·428 grammes of dry silage | —8·22%              |

*Oil.*—

|                                |                  |
|--------------------------------|------------------|
| Glass + stopper + silage .. .. | —37·446          |
| Glass + stopper .. ..          | —34·446          |
|                                | 3 grammes taken. |
| Flask + oil .. ..              | —31·708          |
| Flask alone .. ..              | —31·922          |
|                                | —2·86%           |

*Albuminoids.*—

|   |                  |
|---|------------------|
| Wt. of glass + stopper + silage .. ..   | —36·446          |
| Glass + stopper .. ..   | —34·446          |
|   | 2 grammes taken. |
| 50—43·5 = 93·5 c.c. of standard NaHO solution taken up for neutralising 20 c.c. of standard sulphuric acid. |                  |
| 6·5 c.c. of alkali represents.  |                  |
| 6·5 × 1908 grammes of albuminoids—1279 gr. in 2 gr.   |                  |
| ∴ In 1 gramme ·064 grammes = 6·4%   |                  |

The percentage composition of the sample of silage was therefore :—

|                                  |         |
|----------------------------------|---------|
| Moisture .. ..                   | 6·84%   |
| Fibre .. ..                      | 37·76 „ |
| Ash (including sand) .. ..       | 8·29 „  |
| Oil .. ..                        | 2·82 „  |
| Albuminoids .. ..                | 6·40 „  |
| Soluble carbohydrates, &c. .. .. | 37·92 „ |

100 00

## CHAPTER XCIX.

### WATER ANALYSIS.

THE farmer should be careful about the quality of the water he uses for irrigation or drinking purposes. The presence of nitrates is helpful for vegetation, but that of nitrates and of chlorine indicates sewage contamination, and nitrites are also injurious to crops.

Distillation is the only means of getting chemically pure water. Even rain-water, which is the purest of all natural waters, contains traces of chlorides, ammonium nitrate and other solid bodies. For obtaining eight gallons of distilled water ten gallons of ordinary water should be used. This should be distilled from a copper still connected with a block tin worm. The first half gallon of distilled water is to be rejected and the next eight gallons kept.

In testing the purity or adaptability of water, the following points should be noted:—(1) Total Hardness; (2) Permanent Hardness; (3) Chlorine; (4) Nitrates and Nitrites; (5) Free Ammonia; (6) Albuminoid Ammonia; and (7) Total Residue after distillation. The points which a farmer should specially note are the chlorine, nitrates and nitrites.

(1) *Total hardness* represents the whole amount of lime and other salts which render water hard. Clarke's soap-test is applied for determining total hardness; 50 c.c. of water are taken in a stoppered bottle of about 200 c.c. capacity. A burette is filled with the standard soap solution, and 1 c.c. added each time and the bottle shaken. When a lather remains permanently for five minutes further addition of the solution should be stopped and the number of c.c. of the solution used read off. Then from the "Table of Hardness" the proportion of Carbonate of Lime in 100,000 parts of water determined.

(2) *Permanent hardness* indicates the amount of calcium and magnesium salts in a state other than carbonate. The calcium and magnesium carbonates are held in solution in water by the carbon dioxide dissolved in the water. On boiling, this gas passes off and the carbonates are precipitated, while all other salts remain unaffected. A high degree of permanent hardness may indicate sewage contamination, showing the presence of sulphates and chlorides, both of which might be derived from sewage matter. Moreover, it is impossible to render such water potable by boiling. In estimating permanent hardness, the soap-test is applied after boiling the water, and the result noted as "permanent hardness."

(3) *Chlorine*, as chlorides, may also indicate sewage contamination, though nearness to the sea also accounts for some of the chlorine in water. 70 c.c. of the water to be tested are placed in a beaker over a sheet of white paper and brought

under a burette charged with the standard solution of silver nitrate. Two drops of the solution of potassium chromate are then added, and the silver solution carefully run in with constant stirring, until the solution in the beaker just changes from yellow to red. This indicates that all the chlorides have been precipitated as silver chloride. The red coloured silver chromate will not form until all the chlorides have been removed, but whenever this is attained, the least excess of silver solution causes the red chromate to be produced. Each cubic centimetre of silver solution will indicate .00355 grammes of chlorine per litre. The silver nitrate and potassium chromate solutions must be both perfectly neutral.

(4) *Nitrates and Nitrites*.—The sample of water is treated with sodium hydrate and a piece of sheet-aluminium dropped in. The nitrates and nitrites are reduced to ammonia in contact with the nascent hydrogen produced and then Nessler's test applied. As nitrates are beneficial to plant life and nitrites injurious and indicative of sewage contamination, it is important to ascertain qualitatively if there are any nitrates and nitrites in the water used for irrigation and for drinking purposes. Water containing nitrates, coming in contact with sewage, the nitrates become reduced to nitrites. For nitrites the metaphenylenediamine hydrochloride test is the best. This reagent is dissolved in sulphuric acid, and a drop of it added to water supposed to be contaminated by sewage. If a yellow colour is gradually formed, the presence of nitrites is to be inferred.

For ascertaining the presence of nitrates, an equal volume of strong sulphuric acid should be added to a volume of the water tested, and then a few drops of indigo sulphate solution. The solution should be heated, and if nitrates are present, it will be seen that the indigo solution is decolorized.

(5) The free ammonia in water is determined by Nessler's test.

(6) *Albuminoid ammonia* is due to nitrogenous organic bodies in the water. After the free ammonia has been estimated, by distillation with sodium carbonate, the residue remaining in the retort is heated with a strongly alkaline solution of potassium permanganate, sufficient being added to make the solution up to about 500 c.c. The nitrogenous matters undergo a limited oxidation and nitrogen is obtained as ammonia. Then Nessler's test is applied to the distilled liquor which is collected in portions of 50 c.c. The alkaline solution of potassium permanganate is prepared by dissolving 4 grammes of potassium permanganate and 100 grammes of potassium hydrate in 550 c.c. of distilled water.

(7) *Total residue* is what remains behind after a sample of water has been evaporated.

## PART VI. CATTLE.

### CHAPTER C.

#### BUFFALOES.

[Division of cattle ; The wild buffalo ; The domesticated buffalo ; the advantage of keeping buffaloes for draught and milk purposes ; Feeding of buffaloes, Points of a milking and a working buffalo ; Breeding ; Period for work ; Determination of age ; Dis ases of buffaloes.]

THE sub-family Bovinæ belonging to the tribe Ruminants is divided into three main groups : (1) the Bisontine to which belongs the yak of Central Asia ; (2) the Taurine or oxen proper, subdivided again into (a) the *Zebus* (*Bos Indicus*) or humped oxen of India, (b) the *Taurus* (*Bos Longifrons*), the humpless cylindrical horned cattle of Europe, and (c) the *Gavæus*, humpless, somewhat flattened horned cattle of India and South-Eastern Asia ; and (3) the Bubaline comprising the wild and the domesticated buffaloes. These are the animals ordinarily known as cattle.

*Wild buffaloes.* - The milk of the buffalo being much richer in butter than the milk of cows, buffaloes should be considered as very valuable farm animals. In dry heat buffaloes are not so useful for draught purposes as oxen, but on the whole they are superior cart and plough animals. Buffaloes are found in the wild state in the Himalayan Terai from Oudh to Bhutan and in the plains of Bengal as far west as Tirhut, but chiefly along the Brahmaputra, and in the Sundarbans. They also inhabit the table-lands of Central India as far south as the Godavery, also Ceylon, Burma and the Malay Peninsula. They live in the margins of forests rather than in the interior, and they never ascend the mountains but adhere to the swampy portions of the localities they inhabit. The wild buffalo is somewhat larger and plumper than the domesticated buffalo. In the wild state they are very powerful, but they are not savage nor unapproachable except where they are much hunted. They come to heat in autumn, gestate for ten months and produce their young in the hot weather. They usually live in herds.

*The domesticated buffalo* is also semi-aquatic in its habits. The female buffaloes breed first when they are three years old and then once in every two or three years only and produce about six calves in all. Occasionally they calve annually. They continue

to give six to twelve seers of milk per day for about two years after parturition. During the third year when they are in calf the yield of milk falls off until they cease giving milk altogether about two months before calving.

Buffaloes are *coarse feeders* subsisting on stable litter and even horse-dung and coarse grass, but buffaloes in milk should be given in the cold season (from November to March) two or three seers of oil-cake mixed with ten seers of *bhusa*, straw, etc., in the form of *sani* or *jab* in addition to grazing. In the hot weather they should be given green fodder finely chopped up with the *sani* unless there is plenty of pasturage. In the rainy season they should get at the time of milking both in the morning and in the evening four seers of dry food consisting of wheat-bran and oil-cake, or barley, gram and wheat. Dry buffaloes and working buffaloes are left entirely on grazing.

The points of a good milking buffalo are : (1) Hind-quarters heavier than the fore-quarters ; (2) Skin, thin, smooth and shining ; (3) Hair, fine ; (4) Abdomen and udder, large ; (5) Fine boned legs.

The points of a good working buffalo are : (1) Well-set, muscular, barrel-shaped form heavier looking in front than behind ; (2) Rough and bony quarters indicating strength ; (3) Straight, strong-boned legs.

Buffaloes being slow in coming to heat, various devices are resorted to to bring them to heat. Flowers and leaves of *til*, about two ounces in weight, or anthers of *Kua* flowers (*Pandanus fasciculatus*) given internally, are said to produce the effect. One buffalo bull is sufficient for a herd of one hundred buffalo cows.

Male buffaloes are put to work at the age of three, and they work efficiently for about nine years afterwards.

The age of female buffaloes is determined by the number of rings on a horn. Each ring represents one year of age after the third year ; that is, the age of an animal is the same as the number of rings on the horn *plus* three. The age of male buffaloes is usually determined by an examination of the teeth. They shed their first pair of temporary teeth when two years of age and they get all their permanent teeth when five years old, one pair being shed and replaced each year after the second year.

The chief diseases or complaints of buffaloes are the same as those of oxen, *viz.*, anthrax quarter-ill, hove, foot-and-mouth disease, worms in the stomach and yoke-gall. Worms in the stomach being more common among buffaloes than oxen, will be alone treated of here. This disease can be recognised by the offensive smell of the dung, constant diarrhoea, loss of condition, and occasional escape of worms with faeces. The following vermifuge and purgative medicine has been found beneficial :—

|                |    |    |    |    |      |
|----------------|----|----|----|----|------|
| Common salt    | .. | .. | .. | .. | ½lb. |
| Fresh turmeric | .. | .. | .. | .. | ½lb. |
| Garlic         | .. | .. | .. | .. | ½lb. |
| Old treacle    | .. | .. | .. | .. | 1lb  |



This mixture is divided into two doses, one being given in the morning and the other in the evening, and its administration should be repeated for three or four days, if necessary. While under treatment the animal should be given little water and made to live on dry *bhusa* as much as possible.

## CHAPTER CI.

### OXEN.

[Three classes of oxen to be kept distinct; The Bankipore cross-bred cattle; Montgomery, Meerut, Hansi and Darbhanga cross-bred cows; The Nellore and Gir cows; The Nagpur bullock; The Jersey and Kerry valuable for crossing with cows; Bullocks should not be from cross-bred animals, but from local breeds; The heavy Mysore and Hissar breeds and Gujrat breeds best for draught purposes; For Bengal the little Hariana and Kosi breeds best; Points of a good cow and bullock; Breeding; Gestation; Pregnancy; Food of cows, calves and bullocks at different stages; Changes of food; Relative value of food-stuffs; Relation of food to weight; Housing; Age; Castration; Dehorning.]

THERE are three types of bovine cattle,—(a) draught animals, (b) milkers, and (c) beef-producers. Draught animals may also be good milkers or beef-producers, and it is possible to have milking and beef-producing qualities combined, as in the case of the Jersey cattle. But it is more satisfactory to keep the three types quite distinct and choose the best of each type for breeding purposes, the rest being sold by the breeder or used after castration. This system of breeding only from one type tends to exaggerate the quality sought, which is either power of work and endurance, or quality and quantity of milk, or quality and quantity of beef. The Bankipore cross-bred cattle established by Mr. Talyer about the time of the Mutiny from the local breed crossed with English bulls, is a superior milker, yielding from eight to twenty seers of milk *per diem*. A number of these may be made the basis for the milking strain. Other superior milking breeds are the Montgomery and the Meerut breeds; the Hansi; and a cross-bred race established in the Darbhanga Raj State by crossing good country cows with a Jersey bull. For power of muscle and bones and of action, the trotting bullocks of Nagpur come first, and a number of animals of this class may be made the basis of the draught-strain. In Rajputana also there are very fine trotting bulls. There are no Indian cattle which produce the tasty beef which is obtained from the Highland Kyo, or the Dexter Kerry, and to establish both beef and milk producing strains, it is best to import bulls of the Kerry and the Jersey breeds from England and rear them free from contamination with native cows, on some hill station. The Jersey breed is specially mentioned as it comes from a fairly warm locality, is not very large in size, and is an excellent milking breed. The Ayrshire and Shorthorn breeds, though

heavier milkers, are not so suited for crossing with the smaller sized Bengal cattle, nor are they so adapted for the Indian climate as the Jersey cattle. Of the South Indian breeds, may be mentioned the Mysore cattle as a superior draught animal and the Nellore cattle as a superior milk-producing cattle. But they are large sized animals and heavy feeders and are not therefore recommended in the same way as the Bankipore cross-bred cattle and the Nagpur cattle as the basis of improvement for Bengal. The Kathiawar or Gir cattle are good both for draught and milk purposes, and they are not so large as Mysore or Nellore cattle, and may form the basis of selection for both types in Western India. His Highness the Gaekwar of Baroda has brought to the notice of the English public the excellence of this breed. The hill cattle are generally small in size, with undeveloped humps, but, as a rule, powerful. These and the Burmese cattle are the worst milkers. Of North Indian cattle, the Hissar, Mewat and Gujrat breeds are the best for draught purposes, and the Hariana and Kosi breeds the best for milk. Mr. S. M. Hadi, Assistant Director of Agriculture of the United Provinces, recommends the use of Kosi bulls for improving both draught and milking breeds. Kosi cows are small-sized animals, but they yield as much as seven or eight seers of milk per day. Some of the best milking cattle of Calcutta belong to this breed. Hundreds of cattle find their way annually from the Kosi fair to Calcutta. The excellent commissariat animals of Calcutta belong to the Hissar breed. Of Bengal cattle, the Sitamari breed alone may be mentioned as worth keeping up.

*Cross-breeding* with the Jersey has proved very beneficial for obtaining good milkers, but, as a rule, cross-breeding with foreign cattle should be deprecated, as the native breeds are hardier and less subject to disease than cross-bred animals. As cows are carefully housed and treated, a certain amount of delicacy of constitution may not be much harm, but for draught animals, which must necessarily get rough treatment, delicacy of constitution is most undesirable. Draught animals should not be crossed with European cattle for another reason: the hump of the bullock is of great service in ploughing and in carting, and as European cattle are without humps, the cross-bred animals are either with or without humps, or with ill-developed humps. We can leave beef-producing out of consideration altogether in a book on Indian agriculture.

*Points.*—Of all pure-bred Indian cattle of Northern India which are easily available for breeding purposes for the other two types of animals, the Kosi is the best to select for Bengal. It is a native of Mathura in the United Provinces. A good Kosi cow should be characterized by the following marks, which should characterize more or less all milch cows:—It should have a heavy dew-lap; a prominent forehead; *badami* (almond-shaped) eyes; fine, glossy and polished hair; the hairy part of the tail should be

bushy, tapery, and touching the ground; the belly, large but well proportioned to the size of the animal; the horns, elegant and well proportioned; the udder large, and front teats larger than the hind ones, and all four well apart from one another. The milk veins should be well developed and tortuous. The temper of a cow should be docile, and the animal should be slow and lazy rather than sprightly. A bad tempered cow should be assumed to be a poor milker. Though a good milker is usually a good tempered animal, it should be also borne in mind that the better the cow the more likely she is to be of a nervous temperament and the more she is apt to be affected by a change in handling, milking or surroundings. If the new milker lacks experience, the result usually is a permanent shrinkage of the milk yield and early drying off of the cow. Heifers with their first calf should be milked for ten or eleven months in the year, so that the habit of giving milk almost to the very end of the period of gestation may be established. If it is necessary to introduce a stranger, let him begin milking and let the older attendant finish off. This should be continued for two or three days before the older attendant is allowed to be replaced altogether by the stranger. Black and white are the best colours for these cows. The skin of Indian cattle, whatever the colour of the hair may be, is usually black. A cow should be thin at its neck and slight at fore-quarters and heavy and deep behind. The figure given here is of a Meerut cow belonging to Babu Bholanath Chatterjee of Bhowanipur, Calcutta, in which the points of a good cow can be prominently noticed.



FIG 98.—AN IDEAL INDIAN COW (MEERUT BREEDS).

A good Kosi bullock has the following characteristic marks, most of which should characterize more or less all bullocks:—The hoofs should be dark, round and compact, *i.e.*, the toes not too far separated from each other. The eyes should be dark and

prominent not unlike the eyes of a deer. The forehead should be prominent. The muscles on the top of the neck should be well developed, giving a greater width to the upper surface and forming a channel when the neck is bent down. Animals which show a thin upper neck and no channel should be considered weak. The chest should be broad, the tail thin and the sheath not too prominent. Grey is the best colour for bullocks as it denotes strength. If a bullock is white, its hump should be black. A bullock should be well proportioned, heavier, in fact, at the neck and fore-quarter than behind. Both cows and bullocks should be good eaters.

*Breeding.*—Cattle should not be allowed full liberty in breeding. Bulls should be prevented from breeding for the first three years of their life, and heifers for the first two years and a half. Calves should be given plenty to eat if they are to turn out good breeding animals. Neglecting calves is a great mistake. Some cows calve annually and some once in two years, and occasionally once in three years. Those that calve once a year should have the bull put to them two months after calving. Those calving once in two years should have the bull eight months after calving. If a cow after giving birth to its first calf does not show a desire for the bull by coming to heat within four months after calving, it should be taken as one which will not calve every year. Those calving annually give the normal quantity of milk for the first four months and those calving once in two years for the first eight months. After this period the quantity of milk decreases gradually, but the quality improves until shortly before they go dry when the milk becomes somewhat saline in taste. A cow which gives such milk is called *khero* (i.e., saline). The *Ek-barsī* (or one-year cow) goes dry in eight months and the *Do-barsī* (or two-year cow) in twelve to fourteen months after calving. There are some cows, however, which give milk for a longer period. The milking period depends chiefly on the breed, also on feeding and milking.

The *period of gestation* of a cow is 283 to 300 days, of a buffalo 315 to 350 days, of sheep or goat 148 to 156 days and of a sow 120 to 127 days. A cow goes on calving from the third to the twentieth year of her age. Cows come to heat once in three weeks until they get pregnant.

To ascertain whether a cow is pregnant or not, it is milked separately and a drop of the milk is taken out of the pail with a bit of straw and dropped in a glass of clean water. If the drop of milk sinks to the bottom, without much dispersion, the cow is pregnant; if it disperses readily in the water, the cow is not pregnant. Our *Gowalas* usually judge pregnancy by the following sign: if the animal habitually stands with its tail removed on one side from the vulva, it is pregnant; if it habitually rests its tail on the vulva, it is not pregnant. Bellowing or absence of bellowing, jumping or walking quietly, and the tri-weekly oestral sign, are other indications.

The following food produces the effect of exciting the desire of the cow for the bull: a daily ration of *Juar* fodder with two to four lbs. of boiled cotton seed. This food given for three or four weeks produces the effect. A heifer which refuses to take the bull may be converted into a *Kamdhenu* (or virgin milker) if she is milked regularly. At first she will yield very little milk, but if the milking is persisted in, she gives considerable quantities, *i.e.*, two to three seers a day, and the milking can be done at any time of the day.

Cows in calf which have got dry are usually given no special food, but simply left to graze and drink what water they can get. But some nourishing food and plenty of good drinking-water should always be provided for cows in calf, though fattening a cow in calf is highly undesirable. Half a seer of oil-cake, or cotton-seed mixed up with a basketful of *bhusa* (*i.e.*, straw, etc.) or fodder grass or leaves, *e.g.*, *baer* (*Zizyphus juiuba*) leaves should be given as *sani* every night, in addition to grazing. A few days before delivery, they should be given half a seer of boiled barley mixed with 1 *pow* (5 to 6 ounces) of *gur* and half a *pow* of mustard or linseed oil and half a *chittack* (one ounce) of common salt every day. This mixture is a mild laxative but strengthening food, and it is also beneficial in helping on the flow of milk. After delivery liquid food should be avoided as much as possible for four or five days and the cow kept on such dry food as wheat-straw, wheat-bran, *gur*, fenugreek, ginger, and oil. After four or five days the colostrum gives place to the flow of true milk. The colostrum has an aperient property, and it is useful in relieving the calf of the mœconium or accumulated foetal dung. After the period of colostrum has passed, the cow should get for a month 1 seer of boiled wheat (or mixed rice and *kalai*) mixed with 1 *pow* of *gur* and the milk left by the calf which is drawn, besides grazing *ad lib.* This mixture is very helpful in inducing the flow of milk. The first three weeks' milk inducing diarrhœa among children, is usually rejected, *i.e.*, given to calves and cows, or pigs, or utilized for making butter. For the first three weeks after calving, a cow is called *kechute* (or green). There is usually a new accession to the flow of milk about the twenty-first day after calving. If at this time or soon afterwards, the cow is sold to a new owner or removed from one place to another, there is a serious interruption in the flow. This should therefore be regarded as the critical period as far as the yield of milk is concerned, and very careful feeding and treatment must be resorted to, and on no account should the attendant be changed at this period. If it is necessary to sell or remove the animal, this should be done before the twentieth day after calving, or three or four months after calving.

The following foods are helpful in enhancing the quantity and quality of milk:—

(1) Two seers of boiled *mash kalai*, 1 seer of crushed *juar* and 5 seers of *ghol* (buttermilk or churned curd) made into a gruel, in addition to grazing.

(2) Husked *dal* of gram well steeped in water, in addition to grazing.

(3) *Cyamopsis psoraloides* (*juar*) cut green before the formation of seed, in addition to ordinary grazing.

(4) Grazing early in the morning, *i.e.*, from 2 A.M. when there is plenty of dew on the grass, in addition to ordinary grazing.

(5) Dried leaves or green twigs of wild plum (*baer*) chopped up into small bits given with cotton seed, in addition to ordinary grazing.

(6) *Kanta-notea*, bael fruit and *mash kalai* boiled together in water given in addition to grazing.

(7) Silage and bran (say 20 lbs. + 4 lbs.)

(8) For a large-sized cow yielding 12 to 15 seers of milk a day, a very economical mixture is for each feed, 5 seers of chaff, 1 seer of molasses and 24 seers of water, given twice a day. The following mixture is also very good: 1 seer of oil-cake soaked in hot water, with 5 seers of chaff and a handful of salt, twice a day.

A liberal supply of *good drinking-water* is necessary if a good flow of milk is desired. Cows do not drink the same quantity of water at all seasons. If they are given watery or sloppy food, they require less water. A middle-sized cow should be provided with 10 gallons of water per day, though she may not drink it all. One part of dry food to four of water is the proportion in England, but they require more water in India.

The flow of milk is also enhanced by rubbing the udder with castor-oil after each milking, supplemented, of course, by proper feeding. Quick milking also excites the milk-glands more than slow milking, and an expert milker who can do the work quickly can always get more milk out of a cow than a slow milker.

Milking four times a day instead of twice increases the quantity of the milk, but the quality is somewhat inferior. It is always desirable, however, to milk cattle thoroughly and not to spare any milk for calves. Thorough milking not only gives one the last strippings which are richer, but it tends to increase the flow of milk and enlarge the size of the mammary glands. The septum of the mammary glands is along the median line and milking should be done first at one side and then at the other and not, as is sometimes done, at the front teats first and hind teats afterwards.

The *calves* are allowed for one month to suck as much milk as they can while they learn to pick up a few blades of grass. But after a month restriction should be put on the calf and it should be hand-fed with a mixture of *ghol* and barley, or with wheat-meal and linseed-meal, and allowed to pick up grass and other fodder plants. They should be kept as much apart from their dams as possible. Hand-feeding should be practised when the calf is only a week old, *i.e.*, immediately after the colostrum period. In three months the calf learns to live on grass chiefly, getting a little *bhusa* and oil-cake in the form of *sani* in the evening,

say two seers a day, up to the age of six months, after which, if there is good pasture, no special feeding is required.

*Working bullocks* should get, as *sani*, straw and *bhusa* ( $\frac{1}{2}$  a maund to 30 seers per day, according to size), and  $\frac{1}{2}$  a seer to 1 seer of oil-cake or  $1\frac{1}{2}$  to 2 seers of cotton seed per day; but if there is plenty of herbage, 5 to 10 seers of straw and 1 seer of oil-cake or cotton seed are sufficient.

*Sudden changes* of food are injurious for all classes of animals. Boiled food, linseed and carrots are recommended for debilitated animals.

*Relative value of food-stuffs*.—One hundred pounds of good hay (8th) are equal to—

- (1st) 28 lbs. of beans.
- (2nd) 37 lbs. of peas.
- (3rd) 43 lbs. of linseed cake.
- (4th)  $44\frac{1}{2}$  lbs. of wheat.
- (5th) 59 lbs. of oats.
- (6th) 62 lbs. of maize.
- (7th) 90 lbs. of lucerne.
- (9th) 317 lbs. of oat-straw.
- (10th) 350 lbs. of potatoes.
- (11th) 360 lbs. of guinea-grass.
- (12th) 370 lbs. of carrots.
- (13th) 370 lbs. of mangolds.
- (14th) 469 lbs. of turnips.
- (15th) 670 lbs. of beet.

*Preparation*.—Crushing of gram, etc.; boiling in the case of *Urd* (*Phaseolus mungo*) and *Kulthi* (*Dolichos uniflorus*); parching of barley and wheat, and grinding of maize, bean, etc., are the preparations necessary. Bran should form part of the food of all animals, but used in large quantities, it has a tendency to produce calculi. For cattle, straw should be cut long and not short, as in done for horses.

*Relation of food to weight*.—The amount of food required by a cow or bullock depends very largely on its size. A cow weighing only 300 lbs. as our Bengal cows often do, should not be given the same quantity of food as a cow weighing 1,500 lbs. or 1,700 lbs. like some of the Dutch cows. The world's champion cow of the present time is the Holstein cow, Rosa Bonheur V, an animal actually weighing 1,750 lbs. and eating daily 174 lbs. of food (of which 52.34 lbs. is dry matter), consisting of 114 lbs. of silage, 12 lbs. of maize meal, 9 lbs. oat-meal, 3 lbs. of bran, 9 lbs. of oil-cake, and 27 lbs. of roots. She actually gave during a show-test, 106.75 lbs. of milk in one day, and 726.25 lbs. in one week. Although we can never expect a Bengal cow to weigh over 21 maunds, eat over 2 maunds of food every day, and give 50 seers of milk a day, yet we can judge from this case what the proportions should be in the case of a first class cow receiving first class treatment. The

proportion of food in the case of a cow in full milk should be  $\frac{1}{10}$ th of its weight, of which the dry matter should be a little less than  $\frac{1}{3}$ rd, and it should give  $\frac{1}{20}$ th of its weight in milk when in full milk. In a warm climate the proportion of dry matter may be  $\frac{1}{4}$ th or less.

*Housing.*—Bullocks, cows and calves should be all kept indoors during the cold and wet seasons, in a well ventilated house, but protected from draughts. The other points to be considered in housing cattle are :—(1) 500 to 700 cub. ft. of space should be allowed for each adult animal according to size and a minimum floor space of 60 sqr. ft. should be allowed. (2) There should be sufficient light and ventilation without draught,—the openings being high up. (3) An impervious floor. (4) Plentiful supply of pure water not only for drinking but also for flushing, the daily allowance being 10 gallons per head. (5) A proper wide and shallow drain (3 in. deep) along the middle of the cow-house, the cattle standing back to back on the two sides of the drain. (6) The manure pit should be at a sufficient distance from the cow-house—60 to 100 ft. away, if possible. The criterion for judging the sanitary state of a cow-house or bullock-shed is *sweetness*. If it smells sweet, the sanitary arrangement is all right ; if it smells offensive, it is not all right.

*Bulls* are not given any special food, but they usually live on the fat of the land by sheer force, being surrounded by a halo of religious sanctity. They need not get any better food than bullocks, and they should be kept with bullocks and given light work, and allowed to breed when required after they are three years old. They should be allowed to breed only up to the sixth year of their age.

*Age.*—The age of cattle is determined by looking at their teeth. They have eight incisor teeth all placed at the lower jaw, there being no teeth on the upper jaw, which is provided with a “dental pad.” Up to the age of two and a half they are milk-teeth. Between the age of two and a half and three the middle pair falls off and is replaced by a permanent pair. Between the age of three and three and a half or at most four, the second pair is replaced, and in the beginning of the fifth year the third pair is replaced. The fourth pair is replaced similarly towards the end of the fifth year, when all the permanent teeth are complete. After this there is no definite means of determining age from teeth. The wearing of the teeth gives some indication of age, but after the sixth year age must be determined by looking at the rings on the horns. This is not a very satisfactory method either. In the case of a cow, each ring is taken to denote one calving.

*Castration.*—Castration should be performed in winter on animals about two and a half years old. If they are castrated early, the operation is easier, but the animal is said to lose all spirit and courage and becomes very feminine, while its neck becomes thin which is very objectionable for draught purposes. Castration by crushing or hammering with a wooden mallet without



opening the scrotum is usually practised in this country. This method is, however, not always successful, and it is better to open the scrotum and remove the testicles completely with a knife or better still with Kendall's Emasculator which grinds the spermatic cord and blood vessels, instead of cutting them. It is said that daily application of salt to the testicles of calves, inducing mothers to lick the part hard, results in gradual loss of genital functions. This, however, needs confirmation by repeated experiments. Boiled ghee and carbolic acid (20 : 1) should be rubbed daily at the wound after an animal has been castrated.

*Docility.* Good treatment and constant handling by persons from early age, are the best means of making animals docile. Castration is practised to bring about docility. As an important accessory to rational methods of securing docility of cattle, may be also mentioned dehorning.

*Dehorning.* When the horns are just budding in the calf, the hair should be clipped from the skin all round and the little horn moistened with water to which a few drops of ammonia have been added to dissolve the secretion of the skin, that the potash subsequently applied may adhere to the surface of the horn. The skin is not to be moistened except on the horn where the potash is to be applied. A stick of caustic potash is then held and one end of it dipped in water until it is slightly softened. It is then rubbed on the horn. The operation is to be repeated five to eight times until the surface of the horn becomes a little sensitive. Only a scale will be formed, but no inflammation or suppuration of the part, if the operation is carefully performed. There are hornless or "polled" breeds of cattle which, if otherwise useful, may be selected for breeding.

*Summary.*—In rearing cattle, specially for dairy purposes, three things should be constantly kept in mind : *viz.*, Breed, Feed and Trouble. By breed is meant undoubted pedigree, *i.e.*, both the sire and the dam should be known for two or three generations past to have been of the desired type. In arranging for the feed of cattle, paddocks with shady trees are a necessity. *Juar, kurti*, millets, *khesari* and other cheap grains, bran, oil-cakes and groundnut plants are the principal food-stuffs, besides straw, that should be the main vehicle to be depended upon. The oil-cake should be bought, but the other things, should be grown, if possible, on the premises. Good water is of first consideration.

Under the head of trouble, comes changing of litter or bedding, keeping the house clean, avoiding all ailments by watching the progress of the cattle day by day. If they go off their feed or cease to ruminant, disease should be inferred. Negligent milking and neglect of sanitary conditions generally, in the dairy, may result not only in diseases of animals, but the diseases may be communicated to human beings. Tuberculosis, scarlatina, typhoid fever, diphtheria, cholera, and other diseases in the human subject have been traced to infected milk. Scrupulous cleanliness in every

detail is needed, especially in dairy management. One man should be employed for looking after and milking only eight to ten cows. Mismanagement must take place if one man has to look after a large number of dairy cows.

## CHAPTER CII.

### GOAT-KEEPING.

GOATS will eat almost anything and no todder crops need be grown for them if there is enough of jungle land at one's disposal. It is easy to maintain ten or twelve goats on the pasture which is required for one cow. Jungle or hill land is best cleaned by having two or three goats per acre maintained on it. They should be kept within a barbed wire hurdle fence, four feet high, to keep them from doing mischief to plantations. They can be kept day and night out, except in the rainy season, when shelter should be provided. Goat's milk being richer than cow's milk and being more easily digested by invalids and children, goat-farming should not be despised as an accessory to dairy-farming. Cow's milk contains about 4 per cent. of fat, 4 per cent. of casein and 4 per cent. of milk-sugar; while goat's milk,  $7\frac{1}{4}$  per cent. of fat, 5 per cent. of casein and 5 per cent. of sugar, and about 4 per cent. less water, Cream cheeses from goat's milk are excellent. A goat may be bought for a rupee in some mofussil places, and the skin (weighing say, 4 lbs.) afterwards can be sold for a rupee or even more. All milking goats should be given some gram or pulse to eat, say  $\frac{1}{2}$  a lb. to 1 lb. daily, besides coarse herbage. Angoras are the most famous milking goats, and their wool is almost as soft as silk. The fleece of each Angora goat (about 3 pounds per annum) would bring enough of income to pay for the keep of the animal. But they do not thrive in the plains of India. For the plains, the *Jumna-pari* goat of Bihar is as good as any.

## CHAPTER CIII.

### CALCULATION OF WEIGHT OF LIVESTOCK.

ASCERTAIN the girth in inches at the back of the shoulders, and the length in inches from the square of the buttock to a point even with the point of the shoulder blades. Multiply the girth by the length and divide the product by 144, which gives the measure in superficial feet. Then multiply the superficial feet by the number of pounds per foot for cattle of different girths, the product of which will be the number of pounds of beef, veal, pork, or mutton, in the four quarters of the animal.

For cattle of a girth of from 5 to 7 feet, 23 lbs. may be calculated for each superficial foot, and for a girth of from 7 to 9 ft.,

31 lbs. to the superficial foot. For sheep, goats and calves, of a girth of from 3 to 5 feet, the yield should be taken to be 16 lbs. per-sqr. ft., and of a girth of less than 3 feet, 11 lbs. to the square foot. When an animal is but half fattened, a deduction of 14 in every 280 lbs. or 1 stone in 20 stones should be made; but if the animal is very fat, 1 stone for every 20 should be added.

Suppose it is desired to ascertain the weight of the meat of an ox whose girth is 6 feet 4 inches and length 5 feet 3 inches

$$76 \text{ inches} \times 63 \text{ inches} = 4,788 \text{ square inches.}$$

$$4,788 \div 144 = 33.25 \text{ square feet.}$$

Multiply this by 23 and you get 764.75 lbs. or 54½ stone as the weight of meat. The deduction or addition, as the case may be, should then be made, if the animal is too lean or too fat.

## CHAPTER CIV.

### POULTRY-KEEPING.

THOUGH this subject cannot be included under agriculture proper, farmers should keep poultry for hurdling in in their fields, as they are excellent scratchers of ploughed-up land from which they pick up grubs of injurious and other insects. A few short notes on poultry-keeping will not, therefore, be out of place.

(1) Keep one variety only of fowls or ducks. For fowls the real Chittagong is the best for Bengal, as foreign varieties do not stand the climate well. The full grown Chittagong fowls weigh on the average 8 *seers* and the eggs 1½ to 2 ozs. each, if the fowls are kept in a healthy manner. Aylesbury ducks and Muscovies or Musk ducks do well in Bengal, and either of these varieties may be selected. Their average weight is also about 8 *seers*.

(2) A breed that produces the largest number of eggs is not necessarily the best. The eggs of such a breed are small, and a very small proportion of them hatch out. Some hens would lay as many as 200 eggs in the year, while others would lay only 30 or 40. Hens that lay only about 10 eggs before becoming 'broody' and breed only three times in the year, generally incubate and hatch into life every chicken out of their eggs. These are the best hens for breeding and for use as foster-mothers.

(3) Incubation and bringing up eggs artificially can be done in patent Incubators and Foster-mothers. Tamlin's Nonpareil Incubator, for 200 eggs size, costs £7-5, and Tamlin's Nonpareil Foster-mother, 100 chick size, costs £3-12 (W. Tamlin, Richmond, Surrey, England).

(4) Poultry-keeping can never be entrusted to servants. Personal attention of the owner or a member of his family is essential.

(5) The fowl-house where hens roost and lay eggs must be perfectly weather-proof and yet well ventilated. It must be

cleaned out daily and ashes (and occasionally lime) spread on it afterwards. If a wooden house is specially constructed, the construction of too large a house where a great many fowls may be kept, should be avoided. It is best to keep half a dozen birds (say five hens and one cock) in each house or coop 5 feet square and sloping from 6 to 8 feet in height. There should be a perch 18 inches from the ground and 4 inches in diameter for all the six birds to roost on. A pole of *garan* wood answers very well. This should be placed in the front part of the house, that the hens may lay eggs on nests of straw at the back of the house. There should be a large-sized window in each house.

(6) The yard in front of the fowl-house should be covered in the rainy season, as wet is most injurious to fowls. At other seasons a covered run is not needed and it is good to let the fowls go about in the open as much as possible, and scratch the loose earth of the yard and pick up and swallow bits of grit or bones, which is their natural habit. As the yard gets polluted in time with the dung of the fowls, it is necessary to clean it from time to time, say once a week, and sprinkle ashes over it, and a layer of dry earth 2 inches deep twice a year.

(7) A shed open in front should be provided for the sitting hens.

(8) The whole, *i.e.*, the roosting and laying houses, the covered and open runs and the shed for sitting hens should be fenced in to a height of 6 feet with wire netting of 2-inch mesh.

(9) The *points* of a good bird are: (1) it should be young, *i.e.*, it should show smooth and not rough and horny shanks; (2) it should be of a good size; (3) it should be plump and sprightly looking; (4) the legs should be short; (5) the breasts should be full. Village-stock prove healthier than town-stock and on no account should Calcutta Municipal Market birds be chosen as the basis of a breeding stock.

(10) The stock should be always kept young, and all birds more than two years old should be used up or sold.

(11) No fixed scale of feeding can be recommended. If hurdling in of poultry by rotation in fallow land and ploughed up land be systematically practised, very little feeding will be needed. But the rule to be observed in feeding fowls is to give them as much paddy, buck-wheat, oats, or barley, as they will *eagerly* eat, but no more, so that very soon after the feeding is over, no grains should be seen on the ground, and yet there should be no eagerness noticeable on the part of the fowls to have more grain. Birds kept enclosed in fowl-houses and yards should have three meals a day; others, one or two according to the circumstances. Very healthy village fowls pick up all their food themselves and they are not fed. The morning feed should be of a soft nature, such as rice-dust (*kunra*) and water, or cooked rice and *dal*, and the evening meal should consist only of dry grain. A seasoning of salt and pepper to the morning meal of

*mash-kalav*, or rice and *dal*, keeps the fowls in very good condition. The rejections from the kitchen or the table make excellent morning feed for fowls. The best grain to use for the evening meal is buck-wheat, which has the effect of stimulating the egg-laying power of hens and ducks. There should be plenty of grass in the yard where birds have their run, as they are benefited by liberal grazing. But if the supply of grass is scanty, the fowls and ducks must be supplied with green food, such as cabbage or carrot leaves, etc.

(12) Fowls must never be left without a constant supply of good drinking water which they may drink at their pleasure. When any epidemic such as fowl-cholera (*Guti*) is raging, the vessel of water should have a few grains of powdered sulphate of iron mixed with it, enough to give a very slight metallic taste to the water. This is an excellent way of preventing the disease.

(13) The eggs should be collected from each fowl-house twice a day.

(14) Not counting the chickens that are hatched out of eggs, each fowl-house with five hens in it should produce 500 eggs per annum. If these can be sold for 100 annas or Rs. 6-4, the birds should pay for their keeping. But if they have to be fed altogether with purchased food, three times a day, it does not pay keeping fowls, unless one goes in for breeding high class fowls, which should be the aim of the owner from the very first.

(15) Eggs should be brooded in as fresh a state as possible; but they can be collected and kept for a week before they are put to brooding, without any harm occurring. Eggs which are very stale, *i.e.*, set more than a week after they are laid, even when they do hatch, produce sickly-birds.

(16) Shallow *gamlas*, or open earthenware vessels, make very good brooding nests. Three such *gamlas* are sufficient for three brooding hens kept in a five feet square shed with a small yard in front, situated in a damp place. Coolness of shed and dampness of atmosphere are helpful to the chickens hatching out more easily; but draughts and rain must be avoided. Over the *gamlas* should be put some ashes, then some fresh cut damp grass and on the top a layer of straw cut up in length of about 2 inches. 10 to 12 fowl's eggs and 6 to 8 duck's eggs, are quite sufficient for each hen.

(17) Brooding hens must be fed once a day, and it may be necessary to lift them up by their wings and bring them down from their *gamlas* to the food and water supplied to them. Should any eggs be found broken by some accident, they must be removed, fresh straw put on, and any eggs found soiled must be cleaned with salt water, and dried immediately afterwards and replaced in the nest. The breast of the hen should be also cleaned, if it is found soiled in any way, before she is allowed to go back to her *gamla*.

(18) In the brooding shed there must be a heap of sand and ashes where the hens may have their daily dust-bath which keeps them free from lice. Half an hour should be quite enough for the feeding, recreation and dust-bath, after which the hen must be encouraged to go back to her nest, which she usually does with alacrity. But one or even two hours' absence of the hen from her nest does not interfere with the hatching of the eggs.

(19) Chickens come out after twenty-one days' incubation. For a whole day after hatching they require no food, and as some eggs are a few hours later than others in hatching, it is best to let the mother come out with all her chicks before any attempt is made to feed them.

(20) The best food for newly hatched chickens is hard-boiled yolk of eggs mixed up with stale bread moistened with milk. This may be given with some barley and water for the hen, that the hen and the chickens may eat together. The hen with the newly hatched chickens should be kept in a separate coop. A big basket with open lattice work which is ordinarily used in this country answers very well, as it can be placed on grass and moved about from time to time. After the first day or two, ground oats or buck-wheat, also some finely minced meat, should be given to the chickens, while the hen may be given the same food in a coarser state. Hourly feeding of chickens is necessary for one week, after which the feeding should be done less often; but the secret of success in poultry-keeping consists in feeding the chickens often and with fresh food. Potatoes mashed with bran and finely chopped up green grass is a very good food for chickens after the first week. They must have a supply of good water also. After four months, the best birds being reserved for breeding, the rest should be sold or converted for table use. More substantial pens or coops should be provided for chickens when they are a month old.

*Preserving eggs.* Eggs can be preserved in a fresh state for eating in a solution of Silicate of Soda (called also water-glass). One volume of the semi-fluid silicate should be mixed up with twenty volumes of water and the fresh eggs pickled in this solution will last several months. Before cooking a puncture is to be made in each egg to avoid spurting and bursting. To preserve 600 eggs, 6 lbs. of water-glass dissolved in 8 gallons of water are sufficient. The exact procedure to be followed is this:—Each time 25 to 30 fresh and uncracked eggs are taken, placed in a sieve and dripped with warm melted lard. The eggs are then removed from the sieve and when the coating of lard has cooled they are submerged in the above solution of water-glass.

Another method of preserving eggs has been also successfully followed. Eggs are placed for five minutes in a 20 per cent. solution of sulphate of iron to which is added  $1\frac{1}{2}$  per cent. of tannin soluble in water. The eggs are then rinsed in water, dried and kept as ordinary eggs are kept.

## CHAPTER CV.

### DISEASES OF CATTLE.

[First-aid; Anthrax; Inoculation; Preparation of Serum; Foot-and-Mouth Disease; Hoven; Quarter-ill; Pleuro-Pneumonia; Cyst disease; Impaction of rumen; Red Water or bloody urine; Diarrhœa; Mammitis; Abortion; Warts; Yoke galls and sores; Aphthæ]

THE commonest diseases of cattle in India are Anthrax, Quarter-ill, Foot-and-Mouth Disease, Pleuro-Pneumonia, Hoven, Constipation or Impaction of the rumen, Dyspepsia, Debility, Catarrh, Jaundice, Worm in the Eye, Red Water, Aphthæ, and Abortion. Worms in the stomach has been already dealt with. (See page 477.) In connection with this subject the reader should study the chapter on Agricultural Bacteriology in Part VII of this book. Of the cattle diseases mentioned, the first four are due to pathogenic organisms, and certain general ideas regarding the manner in which such diseases spread and are arrested both in animals and in plants should enable the reader to apply remedies intelligently in particular cases.

All that the agriculturist is expected to do is to render *first aid* in the case of serious ailments, and treat all ordinary ailments of cattle. For special diseases special remedies have been found beneficial, and some of these are given below.

*Anthrax (guti).*—Preventive inoculation should be resorted to, if possible. When disease has appeared, careful treatment does good in some cases. When the purging and passing of blood and mucus continues for more than twenty-four hours, the following mixture is said to give beneficial results:—

|                |    |    |    |    |                        |
|----------------|----|----|----|----|------------------------|
| Camphor        | .. | .. | .. | .. | $\frac{3}{4}$ tolah.   |
| Saltpetre      | .. | .. | .. | .. | $\frac{3}{4}$ "        |
| Dhatura seeds  | .. | .. | .. | .. | $\frac{1}{2}$ kanchha. |
| Chiretta       | .. | .. | .. | .. | $\frac{3}{4}$ tolah.   |
| Country Spirit | .. | .. | .. | .. | 2 chittacks.           |

When diarrhœa has gone on for much longer than 24 hours,  $\frac{3}{4}$  tolah of gallnuts, finely powdered, should be added to the above mixture.

The diet should consist of rice and *kalai* gruel well boiled and of thick consistency, to which should be added some *gur* and salt. Water should be given at the first stage of the disease when there is costiveness, heat and discharge of mucus from mouth and nostrils, but when diarrhœa sets in, the animal should not be allowed to drink any water. No straw or other fibrous food should be given. If the animal lives for eight or nine days and gets little pustules on the body, it generally recovers.

*Small-pox proper* in cattle is not known as *guti*, but as *Besherá*. It occurs as pustules on the teats and udder. It is a harmless disease. Some inconvenience is felt at the time of milking but that is all. Application of carbolic oil (1: 40) or butter is all that is required by way of treatment.

*Rinderpest Inoculation.*—According to Koch, immunity from rinderpest is conferred on cattle after a subcutaneous injection of 10 c.c. of bile taken from the gall-bladder of an animal which has succumbed to a virulent attack of rinderpest. This immunity sets in on the 10th day at the latest and is of such an extent that even four weeks afterwards 40 c.c. of rinderpest blood could be injected without any injurious result. By mixing virulent rinderpest blood-serum with rinderpest bile Koch got the important result of being able to immunize animals with 5 c. c. of bile mixed with 5 c.c. of the blood-serum. An admixture of rinderpest blood with rinderpest bile, even increases the immunizing qualities of the latter. Blood serum itself has a little immunizing property, but this immunity lasts only for a short period. For protective inoculation on a large scale, a mixture of an immunized animal's blood-serum and virulent rinderpest blood was found by Koch to be of great value. To prepare this serum, the blood is taken from the jugular vein and conveyed into an air-tight bottle and allowed to remain for twenty-four hours in a place kept as cool as possible and not disturbed. The fibrin and serum will be then found to have separated.

The following paragraphs on the "Serum simultaneous method" of inoculation are taken from a report of Dr. Lingard, Imperial Bacteriologist, dated 5th January, 1901:—"Serum Simultaneous method.—This method, which has been very widely adopted in South Africa with most encouraging results, consists in injecting a small dose of protective serum on one side of the animal's body and at the same time a small dose of virulent rinderpest blood on the opposite side. A mild form of the disease is produced in 90 per cent. of the animals, with a loss of only one-half per cent. and with the production of a permanent immunity, while the other 10 per cent. are also protected for some months even though they fail to react to the inoculation. In this connection I would point out that when a totally unprotected animal is subcutaneously inoculated with the most virulent blood, it shows no symptoms of disease previous to the 3rd, 4th or 5th day following inoculation and then only does the temperature begin to rise. It is not until at least three days later, viz., the 6th, 7th to 8th day, that any symptoms of rinderpest become manifest. Therefore in practical field-inoculations it has to be first ascertained whether the disease is already incubating in the animals about to be inoculated, as in such cases the simultaneous method of inoculation should not be employed, but serum alone injected in large quantities should diarrhoea not yet have supervened. If this latter symptom should have already made its appearance, nothing can save the affected animal.

"*Experiments in the Laboratory.*—The experiments carried out with the above-mentioned method in this laboratory prove that the animals which show temperature reactions with fairly marked symptoms are immune for upwards of one year, and there



is no reason to doubt that it will last for a much longer time, if not for the life of the animals. On the other hand, the animal, showing no temperature reaction or symptoms of the disease, partly due to the large doses of serum used, may wear off their immunity earlier than those which reacted to the simultaneous method, and this difficulty can be got over by re-inoculating those animals which have not reacted within a week or ten days of the simultaneous injection, with a second dose of from 1 to 10 c.c. of virulent blood.

“*Results in field inoculations.*—The inoculations carried out by the serum manufactured at this laboratory in Bareilly, Aligarh Bulandshahr, and Dehra districts gave eminently successful results and Mr. Holmes in his report from Madras states:—‘Out of 339 bullocks inoculated, nine died, but these deaths were attributed to old age and debilitated conditions, and to the fact that the animals were suffering from rinderpest previous to inoculation.’ I do not consider that any of the deaths occurred as a direct result of inoculation. I think it is safe to say that, as a result of these inoculations, rinderpest was at once checked and a heavy loss averted among the cattle.

“By referring to Table C. of the Assistant to the Inspector-General, Civil Veterinary Department’s Annual Report for the year 1899-1900, we find that out of 1,730 animals inoculated by the above method, only three died after inoculation.

“*Hill cattle.*—There is a great difference in the dose of serum required for the inoculation of *hill cattle*, as compared with that which is safe in plain animals. Notwithstanding that the serum simultaneous method by itself has not been found to be reliable in this particular breed, yet on re-inoculating these animals with from 1 to 10 c.c. of virulent blood during the seven or eight days following the injection by the simultaneous method, protection has been brought about and an active immunity conferred.

“*Serum alone.*—The use of serum alone causes no reactionary fever and it affords immediate full immunity and is very useful in the case of dairy animals and pregnant cows, where it is desirable that the milk supply should not be interfered with, and no cases of abortion take place. The temporary immunity given by injecting with serum alone is sufficient to protect the animals throughout an outbreak. The experiments carried out at Mukhtesar proved that the animals injected with 10, 20, 50, 100, and 150 c. c. per 600 lbs. body weight, were found immune on the 43rd, 76th, 103rd and 164th days, respectively, after serum injections, and in each case when tested by the introduction of virulent blood subcutaneously, only a slight temperature reaction followed, clearly showing that the animals submitted to the above test were perfectly protected and would remain so for a much longer period than those stated above.”

*Foot-and-mouth disease (khura).*—Keep the parts clean and repeat disinfecting applications. One part of carbolic acid mixed

with forty parts of cocoanut or other oil is the best thing to apply to the sores of the feet. In the absence of carbolic acid, camphor (1 ounce) mixed with a pint of oil may be used. Solution of alum (10 grains to an ounce of water) is the best thing to use for washing the mouth. Bran-mash, rice gruel and salt are the best food substances to use.

*Hoven.*—Starved cattle suddenly pasturing on luxuriant herbage, get hoven, hoven or tympanites. Puncturing the rumen is the handiest remedy and it gives instant relief. Murshidabad *gowalas* actually practise puncturing of the rumen in hoven. If an eight-inch trocar and canula are available, it is of course much better to use these than a knife. The puncture should be made in the left side at a point equally distant from the point of the hip and the last rib. The canula is left until all the gas has escaped. Linseed oil with a few drops of carbolic acid or oil of turpentine mixed with it may be given afterwards. Rubbing the stomach and dashing cold water on it and walking the animal constantly are also beneficial if the owner does not venture on puncturing the stomach.

*Quarter-ill or galaphula.* When a case of this deadly disease occurs in a herd, the pasture must be changed at once. The disease runs a very short course, proving generally fatal within twenty-four hours. Blistering of the neck is practised by *gowalas*, but it does not seem to do any good. Preventive inoculation is effective, but it has not been introduced as yet into India. Horses are more subject to it than cattle. This disease is usually mistaken for anthrax, in this country. Setoning the lower part of the tongue with a coarse needle and letting out some blood from the congested veins is practised most successfully in this country at the early stage of this disease (when it is known as *Simla* or *Siuli*) when salivation, groaning and disinclination for all food is first noticed. The blood poisoning evidently takes place at the root of the tongue first and afterwards spreads to the glands of the neck and the whole system.

*Pleuro-Pneumonia.*—Contagious Pleuro-Pneumonia, so dreaded in Europe and so fatal, is supposed to occur in the Punjab and Sind. Slaughtering the affected animals and segregating those free from disease are the only remedies that are in use.

*Cyst disease.*—Cyst disease caused by the immature *Tænia achinococcus*, a worm which in its mature condition is harboured by dogs, is pretty common, affecting the liver, lungs and spleen of cattle. Tape-worm in man is caused by this parasite. Exclusion of dogs from the cattle-shed, together with clean food and drink, are the preventive measures that can best be adopted.

*Impaction of the Rumen.*—This is usually caused by the animal eating greedily too much of a palatable but dry food, e.g., grain or bran, and when it gets very little water to drink. A strong dose of purgative medicine and a stiff dose of country

spirit in warm water should be given. The belly should be hand-rubbed and the animal made to walk. The animal should be given as much tepid water or gruel as it will swallow.

*Red Water or Bloody Urine.*—This usually occurs after parturition. Poor and coarse food is supposed to cause this disease. It is ushered in by diarrhœa, but constipation sets in afterwards when the urine becomes claret coloured and the animal evinces pain in voiding it. The urine is also offensive in odour. The animal becomes weak and debilitated. Death may take place in from five to twenty-five days. Purgative medicine, rice gruel, soft green grass, country spirit, pure air and clean surroundings prove beneficial.

*Diarrhœa.*—Calves often suffer from diarrhœa. Lime water, country spirit and catechu are beneficial. Powdered chalk and cinnamon are highly beneficial both in dysentery and in diarrhœa to bigger animals, as also to calves. Cattle and goats suffering from diarrhœa should, where possible, be kept on green bamboo leaves only. Bean meal is also a lincing food.

*Mammitis* caused by cold, injury to teats, over-distention of udder, or early weaning of the calf, is to be treated by fomentation, gently drawing out of milk and gently rubbing the udder, after each fomentation, with salad oil or cocoanut oil. A purgative medicine (linseed oil or sulphate of magnesia) also helps. Bran should always form part of the food. If an abscess forms, lancing and poulticing will be necessary.

*Abortion.*—Abortion is due either to disease, or to external injury, or to predisposition to abortion. Abortion is contagious in some cases. The animal should be segregated from other animals in calf, and kept in perfect rest, the loins and haunches being covered with cloth dipped in cold water and wrung out. Hot drinks should not be given, but the animal kept on light and green food.

*Yoke-galls and sores.*—When fresh, use brine, and give the animals rest from work. If after five or six days' application no benefit is derived, use the following ointment:—

*Sapheda* (crude carbonate of lead of the *bazaar*)  $\frac{1}{2}$  lb. boiled with  $\frac{1}{2}$  lb. of cocoanut oil and well mixed together by stirring. When boiling, remove from the fire, and add  $\frac{1}{2}$  ounce of turpentine oil. Keep the ointment corked up in a bottle and apply daily until the sore is healed. Another mixture which has been found highly beneficial is hog's-lard with powdered turmeric, unboiled turmeric being used.

*Aphæ (chhráu).*—Sores on the tongue and lips may be treated with honey and borax. Powdered round pepper and salt may be also rubbed on the tongue, as deep as possible, when an animal goes off feed from this cause and begins to salivate. Another remedy successfully applied by *gowalas* is letting the affected animal lick a basket rubbed over with a mixture of turmeric and salt.

## CHAPTER CVI.

### THE THEORY OF HEALTH IN RELATION TO FOODS AND FODDERS.

THE food or fodder of an animal should contain all the constituents in their proper proportions for the building up of animal tissues. Animal tissues again are all built or formed out of blood, and blood is therefore the life or vital fluid, which it should be the object of food to keep in proper condition. Blood is not a formed, but it is the ultimate formative, tissue of all animals including man. It is a highly complex fluid and it is greatly influenced by surrounding conditions. It circulates through a perfectly germ-proof channel and unless there are sores on the skin or in the alimentary canal which serve as open doors of access of pathogenic germs, it is not so susceptible to get diseased as one might think, looking only to the fact of the highly nourishing properties of the fluid for those germs which surround us even in the healthiest climates.

Blood consists of fluids and solids which should be kept at a definite proportion if health is to be maintained. Some departure from this proportion is constantly occurring and must occur; but a persistent and excessive departure from this proportion is the predisposing cause of most diseases, whether they are due to pathogenic organisms or not. Even anthrax and anthracoid diseases need a certain vitiated character of the blood as their predisposing cause, as every animal does not run the same risk of attack, and when attacked, the same risk of falling a victim to them.

The proportion of water in blood should vary from 800 to 900 parts in 1,000 parts. If the water is less in proportion, the blood owing to its thickness is sluggish in its flow. A certain state of fluidity is also necessary to keep those salts, *e.g.*, phosphates of lime and magnesia, in a soluble condition, which are required to be absorbed and assimilated into the system. Besides water, food supplies to the blood all the materials by which the fatty tissues of the body are nourished and by which also materials for respiration and production of heat are supplied.

The solid portion of blood consists of white corpuscles (leucocytes) and red blood corpuscles. White blood corpuscles are larger, irregular in shape, endowed with amoeboid movements while the red corpuscles are smaller and devoid of the power of movement. The white blood corpuscles have a special connection with health. They attack any foreign substances, such as bacteria, that may invade the blood and destroy them by digesting them and ejecting the undigested residue into the blood. Wherever a wound occurs, the white corpuscles rush up, preserve the tissue from the attack of injurious organisms, break up and remove the accumulated red corpuscles and gradually help to fill up the breach. The red corpuscles have also an important function to perform,

as it is by their means that oxygen is conveyed to the various tissues, there assisting to burn up the excess of hydro-carbons and carbo-hydrates, thus simultaneously keeping up animal heat and getting rid to a large extent of useless substances. The actual agent which conveys the oxygen is hæmoglobin to which also the red colour of the corpuscles is due. As hæmoglobin contains iron, an adequate supply of iron with the food is therefore necessary to keep the blood in health. Where there is deficiency of iron in the food, the blood becomes venous or dark in character and loses its bright scarlet appearance.

The serum or fluid portion of the blood contains two substances called respectively fibrinogen and fibrinoplastin. When blood is taken from the body, it coagulates, the coagulation being due to a ferment acting on fibrinogen and fibrinoplastin, which convert them from a fluid to a solid state.

*Water in food.*—An excess of water in the food results in the colouring matter of the red corpuscles being partly washed out and the white corpuscles also getting weakened. The turgidity of the capillaries resulting from excessive absorption of water, leads to their walls getting weakened and their vitality lowered. Serum escapes from the capillaries, which are so weakened, into the tissues and cavities of the body. Anæmia and dropsy may follow a protracted course of feeding with an excess of succulent food. Repletion and congestion of important organs are frequently caused by an excessive draught of water, specially when the system is in too heated a condition. Giving of water to horses and other animals after work when by perspiration the blood has become thick, is the right plan, but when the heating of the system is excessive and circulation very rapid, a draught of water often results in congestion of the lungs or of some other organ. A middle course, therefore, is advisable, *i. e.*, in too heated a condition an animal must be allowed to cool down a little by gentle walking or by wiping, before water is given to it; but if the work has not been of a violent but of a light character, giving of water immediately after work relieves the blood of excessive thickening and consequent sluggishness, while it does no harm.

*Proteids in food.*—Proteids should also be given in certain definite proportions to different animals. They are necessary for the formation of muscles, and blood-serum is the vehicle by which the proteids of food find their way into the various tissues. Febrile diseases result in excessive using up or combustion of proteids. Hence the need of foods rich in proteid matter, such as milk, soup, carrots, grass, bran-mashes and linseed and other, gruels, during and after febrile attacks. An excess of proteids on the other hand, produces congestion which results in local inflammation, and susceptibility to pathogenic diseases as the bacteria find a suitable nutrient soil in blood containing an excess of proteids.

*Fat and carbohydrates in food.*—Fat is also burnt up largely in wasting diseases, and as fat is necessary in the respiratory process for the production of heat and animal vitality, its repair by means of proper carbonaceous food, is necessary. All the muscular tissues are more or less associated with fat which makes them pliant, and joint-oil is necessary to prevent concussion between bony surfaces. Where fat is present, the combustion of muscular tissue does not take place to the same extent as in its absence. Hence the presence of fat saves the muscular tissues from oxidation or burning. On the other hand, an excess of carbonaceous or fatty food, results in debility and interference with the vital activity of the cells of the body, and comparative stagnation of the circulatory system. If such food is persisted in, infiltration of fat takes place inside the tissues of important organs, and finally fatty degeneration or actual conversion of these tissues into lumps of fat.

*Salts in food.*—What has been said about a due proportion being observed in the various constituents of food, such as water proteids, and carbonaceous food, holds equally true as regards, the various salts required for the building up of the animal tissues. Sodium chloride (common salt), for instance, is absolutely necessary for the preservation of health. It is needed for the formation of blood, of gastric juice and of bile, and for the digestion of albumen. The salt taste of perspiration and tears is a proof of its presence in the blood. A salt lick should be provided in every cow-house and stable. But excess of common salt is very injurious to the animal system, producing various skin diseases. Dogs fed on highly salted food are particularly subject to eczema ; and scurvy in man is, in part, due to the same cause.

Similarly, a certain amount of *potash* is needed by the animal, and the favourite food of farm-animals, *viz.*, grass and other green herbs, is rich in potash. Deficiency of potash means impaired tissue nutrition.

Phosphates are absolutely necessary for the formation of bones and teeth, and if they are not supplied with food in sufficient quantities, bone-softening or rickets follow, and a tendency to fracture of bones. The teeth also develop slowly and they tend to decay. Decayed teeth are very common among animals reared on poor pastures. Nerve and brain substances also require a supply of phosphorus for their proper nutriment.

Iron compounds which are necessary to keep the blood and the liver in a healthy condition, when ingested in excess, give rise to hyperæmia, a condition which is opposite to that of anæmia. Inflammations may result from hyperæmia, as from excess of proteids in the blood.

Carbon dioxide gas renders the blood dark and displaces oxygen. But as oxygen is easily replaced when it is again supplied, it has no permanent ill-effect on the blood. But carbon monoxide, while it heightens the colour of blood into bright red,

brings about such a change in the condition of the iron as effectually to prevent re-oxidation. Hence the poisoning effect of carbon monoxide gas and the blood-stained urine we sometimes see passed by animals which have been exposed to the influence of this gas in burning stables and cowsheds.

To illustrate the effect of certain substances on urine it may be sufficient to cite the following additional examples :--(1) If one puts his feet into a solution of potash or soda, these salts can be detected in a short time in the urine. (2) If turpentine is rubbed into the skin, it is detected in the urine in a very short time by the odour of the sweet scented violet which it imparts to that fluid. (3) Diabetes in horse and sheep has been noticed as being connected with the use of mouldy bad foods, of hay and grass, burnt in the stack, or of hay grown with an excessive quantity of nitrate of soda.

The class of diseases produced by food containing too much moisture, such as *bil*-grass, etc., are those in which lowered vitality and debility with dropsies occur, such as, water-braxy, shell sickness, and trembles. Low temperature and exposure to cold winds and rain aggravate these diseases. Moisture within moisture without, moisture above, below and around, must, dilute and impoverish the blood and macerate and soften the tissues, disintegrate the cell elements and render them incapable of performing the functions of organic life, and affect the blood cells and the walls of the blood-vessels injuriously. Hence the necessity of giving plenty of straw and other dry and also nourishing food in the rains and in the early part of the cold weather.

Foods too rich in carbohydrates and fat produce liver disorders and diarrhoea. The blood becomes overladen with their products from imperfect oxidation, congestion being the result.

Foods too rich in proteids produce extravasation of blood into the tissues resulting in inflammations and red-braxy. Milk containing a large amount of proteid matter is a suitable food for young animals, but when it is excessively poor or excessively rich, calves and other young animals suffer from different forms of disease. In the artificial rearing of calves, skim-milk mixed with lime-water is occasionally found a more suitable nourishment than the rich milk as it comes from cow's udder.

Innutritious food results (1) in indigestion, as animals require a larger quantity of it to get the requisite amount of nourishment or, in other words, a quantity which taxes the strength of the digestive organs; (2) in debility for want of sufficient nutrition.

Dirty foods, such as grass full of sand, etc., are injurious, as the sand or dirt has the tendency to collect in the various pouches in the digestive canal, producing irritation, inflammation, ulceration and colic. Horses, particularly, often become seriously ill, and even die as the result of eating dirty food.

Decomposing, mouldy, and decayed foods are the most injurious of all, as they are liable to cause septic inflammation of

the stomach and bowels, and produce diarrhœa and even blood poisoning. Moulds, that is fungi, sometimes cause abortion. Impure water is the most fruitful cause of diarrhœa and dysentery.

## CHAPTER CVII.

### UTILITY OF GROWING FODDER CROPS.

It is often said, there is no practical advantage in growing fodder crops, that the raiyat will never take to them, and that it is only the cattle of experimental farms and those belonging to some dairy farmers or *gouâlâs* which are fed on fodder crops, the majority of the cattle of the country living on the herbage they can pick up and the straw harvested with the grain crops. That the majority of the cattle of Bengal at least look very miserable is admitted, but it is said they are hardy and efficient. There is no doubt the native cattle stand the climate better than foreign cattle which degenerate very rapidly when imported into the climate of Bengal. They are the first to succumb when there is any epidemic about and are, in general, more subject to disease. But this is due to the indigenous cattle being thoroughly acclimatized and not to their being lean or half-starved. Even in Bengal some cattle are better than others, and the better class, which are generally owned by substantial carters, who feed them fairly well, work much better than the leaner sorts. The improvement of draught cattle, not only in appearance but also in physique, must be effected not by going in for importing new breeds, but by feeding the existing acclimatized breeds better than they are at present fed. A man who owns five acres of land must have a pair of oxen to work it. At the rate of half a maund of fresh grass per day, the two animals require an annual supply of 365 maunds of fodder. This quantity of ordinary grass is the produce of about four acres of land, but a raiyat who owns a holding of five acres cannot set apart four acres for the feed of his cattle. The remaining one acre will not support himself and his family. Nor has he now the same facilities for pasturing his cattle on waste land and forest land which he had at one time when there was far less land under cultivation. True, he has the straw, both cereal and leguminous, from his five acres to feed his bullocks, and the scanty herbage of his fields after a crop has been harvested and until a new crop is put in. But from five acres of land the quantity of straw and herbage at the dry season, obtainable, is only about 150 maunds. When the full quantity needed is 365 maunds, 150 maunds must necessarily keep the animals only half-fed or still worse. No wonder, the raiyat's cattle are so miserable. Where waste lands and forest lands are abundant, the question of growing fodder crops may be of no importance, but for most parts of Bengal the question is most important. 365 maunds of fodder can be grown on one acre of land by proper cultivation and proper choice of staples. There



are certain fodder crops, such as guinea-grass, that will grow both in the *kharif* and *rabi* seasons; others are perennial (such as *Panicum muticum* and lucerne.) Leguminous fodder crops are more nourishing than cereal straw or grasses; and a portion of the fodder, say one-fourth, should be of a leguminous kind, so that the proper albuminoid ratio (1 : 12 or 1 : 13) may be secured without the addition of oil-cakes. Of course, for enriching fields the purchase of oil-cakes is always advisable, as the dung is richer when the cattle are fed on oil-cakes. But for the purpose of feeding cattle alone the purchase of oil-cakes is not necessary, if three parts of the fodder used consist of gramineous kinds and one part of leguminous kinds.

It may be said, - why not do away with cattle altogether, if to feed a yoke of oxen on natural pasture, the cultivator must set apart four acres of land, when the average holding of a cultivator is only five acres? It is just possible theoretically for "every rood of land to maintain its man." *i.e.*, for one acre of and to maintain a family of four or five members, also for a man, with the help of his wife and one or two fairly grown-up children, to cultivate one acre of land with such hand-tools as spade, hand-hoe, etc. But it is only by dint of hard and steady labour, distributed over the whole year, that a man can, with hand-labour only, get sufficient food for himself and his family out of one acre of land. A family of four or five members may be regarded as consisting of  $2\frac{1}{2}$  adult units each requiring six maunds of food grains for sustenance, or 15 maunds in all. An acre of land produces ordinarily about 15 to 20 maunds of grain, - partly cereals and partly pulses. At times, it so happens, that cultivators are compelled, owing to the wholesale death of cattle caused by famine or rinderpest, to have recourse to spade cultivation. They are then able, by dint of hard labour, distributed throughout the year, to cultivate only about one acre per family and just keep themselves alive. But it so happens in this country (Bengal) that each family has an average quantity of five to six acres of land, and it is possible, with lighter labour (with the assistance of cattle) for the family to earn a good deal more than a bare living. By the help of fodder crops one can not only grow crops for home consumption and sale, but also keep his cattle in good condition, in which case they can render more efficient help to his cultivation than they could otherwise do. The importance of growing fodder crops on one-fifth or one-sixth of his holding, should be impressed upon each cultivator through educational and other means.

## CHAPTER CVIII.

### FODDER CROPS.

GROWING of fodder crops is not unknown among Indian dairy men, but there is no arrangement anywhere for growing:

fodder all the year round, and cultivators generally leave their cattle to pick up what they can get. There are few plants that would not be eaten by cattle. Where grass is scarce they are fed on the leaves of *bur*, *peepul*, *baer*, *figs*, *pakur*, *mango*, *jack*, *sajna*, *bael*, *simul* and other trees. In times of great scarcity even date-palm leaves are given chopped up to cattle. Ordinarily, cattle would not eat *neem* and *sorguja* leaves, but they have been seen to eat even these when they can get nothing else. But because they will eat almost any kind of plant it is not to be supposed that all plants afford an equally nourishing fodder, or that no special arrangement is necessary for growing food for cattle. Plants that yield specially nourishing fodder will be now described. In Bengal there are some crops grown for fodder. When there is little pasturage available, dairymen give their milch cows country peas, leaves and pods of *babul* trees, pods of the *sirisha* tree (*Mimosa sirissa*), *bhringi* (*Phaseolus aconitifolius*), and *Sorghum vulgare* (*gama*). To stimulate the flow of milk *gowálás* give their cattle a food made by boiling together slices of unripe *bael* fruits, *mash-kalai* and *kanta-notia* (*Amaranthus spinosus*). *Gowálás* are also aware of the fact that cows yield more milk if they get to eat *simul* flower (*Bombax heptaphylla*), or seed and plants of cotton. It is also well known in this country that skins and rinds of sweet fruits, e.g., mangoes, jack, etc., the water strained out after boiling rice, rice-dust (*khud*), husk and bran (*bhusa*), also *mahua* flower (*Bassia latifolia*), *gur* and common salt, are stimulating food for cattle. So special arrangements for feeding cattle are not unknown in this country.

Introduction of new fodder crops is however desirable. The value of sun-flower as a fodder has been already referred to. Field beans form a principal staple of English agriculture, as they yield a most nourishing food for animals. The dwarf shrub of field-beans produces an abundance of pods. Bean-meal is a favourite food for horses, cattle and sheep. It is more strengthening than wheat and barley and yet it does not cause diarrhœa. In fact, in diarrhœa bean-meal is freely used as a binding food. On p. 484 we have placed beans first in the list in considering the relative value of food-stuffs. If field-beans are not grown, we can at least grow popat-beans and cow-peas more largely. In some parts of Bengal, field-beans, though as exotic, used to be grown as a crop in former years, and there is no reason why its cultivation should not be revived. In the district of Murshidabad field-bean plants are met with in the wild state in nearly every old garden. Gardeners of Murshidabad call the plants *baklá*, and they remember the days when this crop used to be grown for the Commissariat Department, when soldiers were stationed in that district.

A sweet root, called the *mangold* or mangel-wurzel, which is much larger in size than beet but allied to it, is used extensively as a fodder crop in England. Larger varieties of turnip, carrot,

cabbages are also used as fodder. Salt is used as a stimulating manure for these crops. In the Sunderbans and other parts of the country where the soil contains an excess of salt, waste land can be profitably utilized in growing these crops for rearing live-stock in a systematic manner.

*Reana luxurians* or *Euchlana luxurians* (buffalo-grass) is a huge kind of grass eagerly eaten by cattle of all kinds. It grows taller than sorghum and it tillers much better, but it must be grown on rich soil, and there must be facility for irrigation if it is to be successfully cultivated all the year round. Nine or ten months after sowing, the plants come to maturity and run to seed. It should be cut as fodder before seeding, *i.e.*, when it is still tender. Grown on rich soil and constantly irrigated, each clump will send out 80 to 90 shoots, 10 to 12 cubits high, capable of being cut seven to eight times in the year, each cutting yielding from 50 to 60 maunds of green food per acre. It grows most luxuriantly at the Sibpur Farm, at least as well as *juar*, and cattle eat the stalks of *Reana* with greater relish than they do those of *juar*. Sown in May, one heavy crop of fodder can be had in September without irrigation.

Besides *Sorghum* and *Reana*, may be mentioned an other rank-growing annual grass, which is actually grown along with *aman* paddy in some districts of Bengal, where it is known as *Erá-kati* (*Ischæmum rugosum*).

Of rank-growing grasses, which are either perennial, or practically perennial, *i.e.*, which once grown occupy the soil always as a weed, may be mentioned the following which are liked by cattle: Guinea-grass (*Panicum jumentorum*), *Para* grass or *Latá* grass (*Panicum muticum*) and *Sorghum halipense*. *Latá* grass grows equally well on dry land and in shallow water.

*Guinea-grass*.—The special excellence of this grass consists in its being perennial. The stumps can be removed with the roots and planted elsewhere, and the plantation thus indefinitely extended. For this crop, however, rich soil and facility for irrigation are essential. The land should be also well drained, that water may not lodge in it even in the rainy season. If the plants are grown from seed, the land should be prepared when the rainy season is not quite over; but if they are grown from root-cuttings, the lands should be cultivated in March or April, soon after the winter crop has been harvested, irrigation being done, if necessary, to soften the soil for convenience of cultivation. After ploughing, the land should be cleaned of weeds and straw by passing the ladder or harrow over it. Before June the land should be got thoroughly clean and ready by seven or eight ploughings followed by as many ladderings or harrowings. Manure should then be spread over the land and ploughed in, and as soon as the rains have commenced, the planting of stumps should begin. If the plants are grown from seed, a seed-bed is necessary. Holes should be made in the seed-bed and two seeds put in each hole in

regular lines and the bed again levelled up. Two days after sowing, the beds should be watered and the watering should be continued every third day until the plants come up. After the plants have appeared, watering should be done every second day except when there is rain. When the plants are about nine inches high, they should be transplanted, leaf stalks being cut off. The field to which they are removed should be got ready in the meantime, ridges being put up three feet apart and the planting done on the ridges. If the stumps are planted, the planting should always be done on ridges three feet apart. If seven or eight stalks with roots are planted in each spot, they will form a fine big clump. The stalks of the stumps planted should stick out seven or eight inches above ground. The clumps occupy a wider and wider area as time goes on and as the plants get cut away. In extending the plantation, some of the shoots can be taken up with roots and the roots planted, or after the shoots have been all cut away, the stumps can be dug up, leaving a quarter at each spot. Unless the stumps are thinned out either in one or in the other way, the shoots become hard and less palatable to horses and cattle. After every second cutting the land should be manured with 100 to 150 maunds of farmyard manure or tank earth or *jhil* earth *per bigha* per annum. Solid and liquid excrements of horses, men, sheep and goats have been found the best manure for guinea grass. After transplanting the seedlings or root-cuttings on to fields, watering should be done daily, unless there is rain, until the plants are well established. Afterwards in the dry season irrigation should be continued once a month. In the rainy season, of course, no irrigation is required. After the shoots are cut off, the land should be dug up at intervals between the plants, the weeds collected and destroyed, and manure spread over and ploughed in and the ridges formed again. The shoots should be cut off before they run to seed, that they may be gathered quite tender. If seed is wanted, the shoots should be allowed to mature, but clumps that are constantly cut, produce weak seeds that do not germinate. Any seed stalks showing smut should not be touched but burnt off with fire. The guinea-grass is not known to suffer from any other malady.

*Lucerne* (*Medicago sativa*).—The leguminous crop that is called lucerne or alfalfa is also perennial. In its own home it will stand on the same field for ten or twelve years running, if it is not allowed to seed and if it is properly attended to. In many parts of India, however, there has often been great difficulty in maintaining a stand of plant for so long. It is a most nutritious fodder for horses; cattle should not be given too much lucerne, as it produces diarrhoea. The stomach of the horse, being comparatively of a small capacity, requires more nutritious food than that of cattle. Lucerne, therefore, is a most appropriate fodder for horses though not for cattle. This crop should be grown near

large towns where good class horses are maintained. There is another special advantage in growing this crop. The roots of this crop penetrate several yards deep into the soil. It does not, therefore, suffer from drought when it has been once established, while it yields heavy cuttings five or six times in the year where facilities exist for irrigation. Fairly heavy soil, rich in lime and well drained, and a dry climate, should be chosen for this crop. Lime and tank earth have been found very good manures for this crop.

*Cultivation of Lucerne.*—In April or May, after the first shower of rain, the land should be given one ploughing. At the end of the rainy season about one hundred maunds of tank earth should be spread per *bigha*, and the land ploughed and harrowed four or five times. After the cultivation is finished, three or four maunds of lime per acre or six maunds of bone-dust should be sprinkled over the land. Trenches should then be made, so as to form ridges about two feet apart, unless the land is hilly with a natural slope. The seed should be sown on the top of the ridges. Little holes may be made with a sickle and seed put in them and the earth battered down. Thus sown, four seers of seed will be found sufficient per acre. If the plants do not come up within ten days after sowing, and if the soil appears to be too dry, one or two waterings may be required before the plants come up. The plants being grown on the ridges or on hillsides, rain is not able to spoil them, and the trenches between the rows of plants can be utilized both for irrigating and for hoeing the land. After each cutting, the plough should be passed through the trenches and weeds cleared in this way. After every two or three cuttings manure should be applied in the trenches; in other words, if thirty maunds of rotten farmyard manure are applied at one season and at another a maund of bone-meal or two maunds of castor-cake or rape-cake per *bigha*, five to six cuttings of plants may be had from the land during one year, and an average crop of 50 maunds per acre can be obtained at each cutting, or 300 maunds of green food in all, during the year. With special facility for irrigation one can obtain 600 or 700 maunds of green stuff per acre. Europeans are quite familiar with the value of lucerne as a fodder for horses, and there should be no difficulty in disposing of the crop in large towns, say, at Re. 1 per maund. The fodder is specially valued for race-horses. If plants are not cut, they run to seed after a year, *i.e.*, at the next cold season, and the plants wither away afterwards. Plants reserved for seed should not be cut but left untouched in a corner of a field. These should not be irrigated so often as the plants used for fodder. Plants required for seed should not be more than three years old. Anytime within the first three years, any of the plants can be set apart for seeding. The seed is usually sold at about Rs. 3 per seer. A plant which is allowed to seed, whether it be in the first year, or afterwards, dies immediately afterwards.

Lucerne in flower has the following average composition :—

|                          |       |
|--------------------------|-------|
| Water .. .. .            | 74    |
| Albuminoids .. .. .      | 4.5   |
| Crude fibre .. .. .      | 9.5   |
| Carbohydrates .. .. .    | 9.4   |
| Ash .. .. .              | 2     |
| Albuminoid ratio .. .. . | 1 : 2 |

*Khari sugar-cane* cut up small is an excellent fodder for cattle. The cactus of the *Opuntia (Phaninanasa)* class, divested of thorns by burning and given chopped up to cattle, and the leaves and tops of cassava, are also eaten by cattle.

Of annual and rank-growing leguminous fodder crops, *Barbati* or cow-pea (*Vigna catieng*) and *Arharia Sim (Cyamopsis Psoralioides)*, called *kurti* in Oudh, occupy the first place. Ground-nuts may be grown as a fodder crop on heavy land, as they grow in such soils like a weed for ever after being once sown, and they are thus practically a perennial leguminous crop.

*Albizzu procera* or the rain-tree of Bengal, being a very fast-growing tree, and doing well in the plains of Bengal, might be largely grown for fuel. The fruits of this tree are very sweet, cattle are very fond of eating them. They are probably as good for fodder as the carob-beans of the Mediterranean regions. *Prosopis spicigera* and mulberry have been also mentioned as valuable fodder-yielding trees.

## CHAPTER CIX.

### SILOS.

SILOS are built either above ground or below ground or partly above or partly below, or on a slope. They are either old buildings modified or unmodified, or they are new ones specially constructed. A fourteen-inch brick or concrete wall carefully lined with cement is all that is required. The internal coating of cement should be as smooth as possible. If an old room be converted into a silo, the doorway requires special arrangements for closing up before filling, and for opening before commencing to use the silage. This is sometimes done by brick-work and sometimes by a double door of wood with saw-dust in the intervening space. The cost of silos should not exceed Rs. 10 per ton of capacity, a cubic foot of silage weighing 45 or 50 lbs. Fifty cubic feet should hold a ton. Stack-silos are also common. A stack 30 ft. long by 15 ft. wide (16 ft. at the base) and 14 ft. high would weigh about 100 tons. A pit at the side of a hill is the most convenient situation for a silo, as it can be filled from the top and the fodder can be taken out from the bottom.

As the greatest amount of mouldiness occurs just behind the doorway, or just beneath the covering boards, great care is

necessary in the construction of a silo. Small silos are better than large ones, as the filling each time should be done within a day or two. The best size is 10 ft.  $\times$  10 ft.  $\times$  5 ft.

The best materials to pit are green maize stalks, *araha* plants in flower, *juar*, *Sorghum saccharatum*, buck-wheat, barley straw and coarse grasses. The materials should be filled chopped up, if possible. For a 10 ft. square silo, 4 or 5 cwt. of material should be put in, and 1 lb. of salt sprinkled over the mass for every cwt. of material used, and the whole well trodden down, especially at the sides and corners. This process is repeated until the whole of the pit is filled up. An extra quantity of salt should be sprinkled at the top, and the whole of the pit covered with boards or *darma*-mats, earth being used for weighing the boards at 100 lbs. per square foot. A 10 ft.  $\times$  10 ft.  $\times$  10 ft. pit will hold about 5 tons of materials as the first filling. As the boards will gradually sink, crevices in the earth must be carefully filled up. After a week or ten days the silo should be opened again and filled in the manner already described, and closed again. The opening and filling may be repeated four or six times, *i.e.*, so long as there is considerable sinking. Properly filled, a pit 10 ft.  $\times$  10 ft.  $\times$  10 ft. will hold 10 tons of silage, which is equivalent to 2 or 3 tons of dry hay. If necessary, the silage can be used six weeks after the filling has been completed, when fermentation will cease. But it will remain good for at least two years. In England, 10 tons of green fodder produce 9½ tons of silage or 3 tons of dry hay. In India, the loss of weight in silage-making has generally come to a great deal more. In 1892-93, at Allahabad, 33.652 maunds of grass made 21.781 maunds of silage, which means a loss of 35 per cent.

If a thermometer is available, it should be seen that the top 3 or 4 ft. of the materials attain the temperature of about 125°F. before the second filling is done. The maximum temperature (160° F.) is reached in about six weeks, after which the normal temperature is attained in a few days. A silo should not be opened until it has reached the ordinary temperature. About 5 per cent. of the silage is wasted at the sides and the top or at the door when there is a door, on account of mouldiness; and more, if air is not properly excluded. To make 60 lbs. of silage in India, 90 or 100 lbs. of green fodder are required.

Heavy pressure and trampling and quick filling are no longer considered essential for getting the best results in the making of silage. The mass may be allowed to settle of itself. When filling, the mass should be made level and well pressed into the corners. It should be tight at the sides. Even a wooden cover over the top is not needed. A simple covering of cut straw answers. A wooden silo above ground is far better than any stone or brick building under or above ground. Stacking of silage is not recommended for this country. The waste from decay in stack-silage is great.

Silage is specially valuable for milch-cattle. It increases the flow of milk, makes the milk richer and supplies food at a time of the year when fodder is scarce, the excess production of the rainy season being utilized for silage. That the fibre is rendered more digestible by ensilage is the point which is of great importance in considering the value of silage as food as compared to hay.

Large-sized cattle require nearly thirty seers of hay or its equivalent in silage per day and smaller-sized cattle twenty seers or less; but the silage-fed cattle will milk better than hay-fed ones, the milk being richer in cream and the butter sweeter and richer in colour. The cost of feeding cattle with silage is less than half that of feeding them with hay or with straw-chaff and bran of oil-cake. An acre of green fodder, say, guinea grass, may weigh 10 tons. This will make three tons of dry hay, but seven tons of silage. The three tons of dry hay will keep 168 head of cattle for a day, or one cow for 168 days at 40 lbs. a day, while the 7 tons of silage will keep 392 head of cattle for a day, or one cow for 392 days.

Pit-silage is more sour than stack-silage, but cattle will eat either. The acidity is due to acetic, lactic and other acids which are generated when the temperature rises to 80 or 100° F. During the making of silage the proteids are partly converted into acids, which causes a loss of food value, and the proteid ratio of silage being less, some nitrogenous food, such as bran or oil-cake, should be used with silage. Silage is also a mild laxative food which ordinarily does no harm; but when diarrhœa sets in, bean-meal should be given along with silage or hay and straw partly substituted for silage. Generally speaking, 10 to 15 seers of silage along with other food should be given per diem to a cow.

The results of some experiments on silage and hay are thus summed up by Dr. Leather:—

“The grass used weighed 34,442 lbs.; the hay 11,152 lbs.; the loss 20,290 lbs. or 67·62 per cent. Of this 64·57 per cent. was water. The remainder was almost entirely due to the loss of a part of the digestible fibre, woody fibre, and carbohydrates present in the grass. The amount of these, together in the fresh grass, was 8,668 lbs., and in the hay 7,670 lbs.; the loss was therefore 998 lbs. or 11·5 per cent. Of the albuminoids present in the grass there was no loss, and a considerable proportion of the insoluble albuminoids became soluble; of the total Nitrogen originally present there was slight loss—the grass contained 160 lbs., whilst the hay contained 150 lbs. During the process of hay-making, therefore, the loss of food material is but very slight, and what is lost consists principally of carbonaceous principles.”

With regard to some English silage Dr. Leather says:—“The digestible fibre, the woody fibre and the carbohydrates in the grass weighed together 8,213 lbs.; those in the silage 6,989 lbs., and the loss 1,224 lbs. Some acetic and lactic acids were formed,



amounting together to 215 lbs. Allowing these to have the same value as the carbohydrates, the net loss of carbonaceous food was 1,009 lbs. or 12·3 per 100 parts of carbonaceous principles. Of the total nitrogen in the grass employed there was no loss; 151 lbs. Nitrogen was found in the grass and 155 lbs. Nitrogen in the silage. There was, however, a loss of albuminoids, a portion of these being converted into non-albuminoid substance. The albuminoids in the grass amounted to 780 lbs., in the silage to only 449 lbs.

“Of the quality of the silage, it will be sufficient to say that the silage was employed in a comparative feeding experiment on bullocks; one lot of beasts being fed on cotton seed-cake, maize and silage, the other on cotton seed-cake, maize and hay, the result of which was to show the feeding value of silage to be slightly superior to that of hay.

“It is economical to store the early grass as silage in those districts which are too wet to admit of hay-making, and ensilage is therefore a process by which fodder may be stored for many months, and it may be regarded as a means of providing for scarcity of fodder in dry years.”

Pasturing or giving green grass to cattle and horses is the best. Next to that should be preferred giving of silage to cattle, but as horses require more concentrated food richer in albuminoids, hay is better for horses than silage. Milch-cattle thrive better on silage than on hay, although they require their food to have a higher proteid ratio than horses. They must, however, get some bran or oil-cake along with the silage, as bulkier food is required by ruminants than by horses.

*The Allahabad Grass Farm.*—As a Government farm which is worked with profit, it will be interesting to give a few details of this farm taken from the report of 1890-91, *i.e.*, the year immediately preceding the establishment of the dairy farm and cattle and pig breeding in connection with it. The year was rather droughty, and the average yield of grass was only 126 maunds, per acre as compared to 155 maunds per acre obtained in 1889-90. The extent of the farm was 2,590 acres. The rent paid was high, *i.e.*, Rs. 16,999-6-5, *i.e.*, over Rs. 6 per acre. The total yield of green grass came to 325,821 maunds. 250 acres were cropped with sorghum, oats, barley, wheat and gram, which yielded 15,984 maunds of grain.

Of the green grass obtained, 153,102 maunds were issued in the green state, 120,739 maunds were made into hay, 55,749 maunds of hay being obtained, while 51,981 maunds were siloed, 34,723 maunds of silage being obtained from 35 silos.

The loss by dryage and mouldiness in the case of silage varied from 16·12 per cent. to 52·62 per cent., the average coming to 28 per cent.

Rs. 8,886-10-6 was the amount spent during the year on manuring, while the total expenditure came to Rs. 79,797-10-8.

The produce was not sold but supplied to the Commissariat Department, and an estimate only of its value can be given.

|                          |    |              |           |       |              |
|--------------------------|----|--------------|-----------|-------|--------------|
| (1) <i>Green grass</i>   | .. | 153,102 mds. | @ 3 as.   | a md. | = Rs. 28,705 |
| (2) <i>Hay</i>           | .. | 51,749       | " " 8 "   | " "   | = " 23,874   |
| (3) <i>Silage</i>        | .. | 34,732       | " " 8 "   | " "   | = " 17,361   |
| (4) <i>Grain</i>         | .. | 15,984       | " " 1 Re. | " "   | = " 15,984   |
|                          |    |              |           |       | Rs. 87,924   |
| Total gross outturn      |    |              |           |       | Rs. 87,924   |
| Deduct Total Expenditure |    |              |           |       | .. " 79,797  |
|                          |    |              |           |       | Rs. 8,127    |
| Net saving to Govt.      |    |              |           |       | .. Rs. 8,127 |

## CHAPTER CX.

### PROTEID RATIO.

DIFFERENT animals have different power of digestion, and even the same animal digests different proportions of food-constituents under different circumstances.

The digestible carbohydrates are usually all assumed to have the same heat-producing power, but as a matter of fact they differ in this respect in their action in different animals, ruminants making better use of them than other animals. Different animals require foods of different 'proteid ratios' to sustain them in proper health. By *proteid ratio* is meant the ratio of the digestible proteids to the digestible carbohydrates, plus 2.3 times the digestible fat or oil. But as the proportions of proteids and carbonaceous food-constituents digested are different under different circumstances, the term 'proteid ratio' is more commonly applied simply to the ratio between the proteid and the carbonaceous food-constituents, the latter including fat which is multiplied by 2.3 and then added to the carbohydrate food-constituents. The difference between the *true proteid ratio* and the proteid ratio as ordinarily understood is not very great, and for the purpose of ascertaining the value of a food under ordinary circumstances, the digestibility of its different constituents may be left out of account.

The different constituents of all crops are not equally digestible and all crops are not equally digestible in all conditions and stages of growth. Fodder crops deteriorate towards maturity and they are wanting in nourishment when too young. In the case of *Juar*, the highest nutritive and manurial value is immediately before flowering, but potatoes and mangolds improve with maturity, starch and sugar being formed more freely at the latest stage of their growth. High manuring, in many crops but not in all, increases not only the bulk of a crop, but also the relative

proportions of water, ash and nitrogen, but there is a smaller proportion of carbohydrates in highly manured crops.

In hay, straw, green-fodder and root-crops, the nitrogen present is not a very safe guide to the amount of proteids. The fat in these substances also contains a good proportion of indigestible wax, and some portions of the carbohydrates also have no feeding value. Weight for weight these constituents in grains are better digested than in toddlers.

No experiments have been conducted on Indian animals to test the digestibility of the constituents of the various food-stuffs, and we must at present rely on European and American experience in the matter.

Digestibility has been found affected by the following circumstances:—(1) Kind of animal, whether ruminant or not; (2) quality of food; (3) mixture adopted; (4) age of the plant used for fodder; (5) the state in which the food is given, in the rough, or properly washed, or cooked, or dried as hay; and (6) health.

Digestibility is not usually affected by the following circumstances:—(1) age of the animal; (2) quantity given (*i.e.*, by starving an animal a higher proportion of the small quantity given is not digested); (3) labour (*i.e.*, bullocks at rest and at work digest the same proportions of the different constituents).

The addition of the following substances to food helps digestion:—

(1) Highly nitrogenous food, such as bran, oil-cake, wheat, bean-meal, etc.

(2) Oil, at the rate of  $\frac{1}{2}$  lb. per day per 1,000 lbs. of live weight.

(3) Starchy or sugary foods, *e.g.*, potatoes, mangolds, provided the proteid ratio of the whole food does not fall below 1:8. The addition of starch or sugar ordinarily reduces the digestibility of food, but when the proteid ratio is increased by the addition of oil-cake, bean-meal, etc., then the digestibility of the food is increased by the addition of sugar or starch.

(4) Salt.

(5) Agreeable flavour is also helpful to digestion, hence the advisability of mixing materials with such a flavour.

The proper proportion of water is of great value in helping digestion. In the case of cattle the best proportion of water to dry food has been found in European countries to be as 4:1, and in the case of sheep as 2:1; but in the Indian climate a higher proportion of water is probably necessary.

Grains, potatoes, and root-crops generally are nearly completely digested. The higher the proportion of nitrogenous matter contained in hay or straw the greater is its digestibility. Of 100 parts of fat, proteids, carbohydrates and fibres, in various food-stuffs, the proportions digested are given below, though the figures must be understood in connection with the reservation that different animals have different power of digesting different

constituents of food in different mixtures, and the figures therefore give only a general idea—

|                               | Fat. | Proteids. | Carbo-<br>hydrate. | Fibre.         |
|-------------------------------|------|-----------|--------------------|----------------|
| Cereal grains .. ..           | 85%  | 75%       | 85%                | Very variable. |
| Pulse grains .. ..            | 80 " | 85 "      | 90 "               | 60%            |
| Cereal straw .. ..            | —    | 20 "      | 45 "               | 55 "           |
| Pulse straw (not too ripe) .. | —    | 45 "      | 60 "               | 40 "           |
| Hay .. ..                     | —    | 50 "      | 60 "               | 50 "           |
| Oil-cake .. ..                | 90 " | 80 "      | 50 to 80           | Very variable. |
| Potatoes .. ..                | 90 " | 72 "      | 93 "               |                |

Let us now find out the proteid ratio or nutritive relation of Bengal gram (*Cicer arietinum*). Its average composition is—

|                             |    |    |       |  |
|-----------------------------|----|----|-------|--|
| Moisture .. ..              | .. | .. | 10.6% | (the nutritive value of which is to be neglected). |
| Oil .. ..                   | .. | .. | 4.4%  | (which is equivalent to 4.4 × 2.3 of starch).      |
| Proteids .. ..              | .. | .. | 17.1% |  |
| Other Nitrogenous matter .. | .. | .. | 1.5%  |  |
| Carbohydrates .. ..         | .. | .. | 57%   | (which may be reckoned as equal to starch).        |
| Woody fibre .. ..           | .. | .. | 6.3%  |  |
| Mineral matter .. ..        | .. | .. | 2.7%  | (the nutrient value of which is to be neglected).  |

From the table of digestibility given above we conclude that—

80 per cent. of the fat which has been reduced to carbohydrates as 4.4 × 2.3 is digestible, also, that 90 per cent. of the carbohydrates the proportion of which is 57 per cent. is digestible, also, that 60 per cent. of the fibre (6.3 per cent.), and 90 per cent. of the other nitrogenous matter (1.5 per cent.) which is equal in value to starch, are digestible. We also conclude, that 85 per cent. of the albuminoids, the proportion of which is 17.1, is digestible. Now the proportion between the digestible albuminoids and the digestible portions of the food reckoned as starch is the true albuminoid ratio of gram. In working the proportion out we have the following result:—

$$\frac{17.1 \times 85}{\frac{(57 \times 90)}{14.535} + \frac{(1.5 \times 90)}{14.535} + \frac{(6.3 \times 60)}{14.535} + \frac{(4.4 \times 2.3 \times 80)}{14.535}} = 1 : 4.4$$

$$513 + 1.35 + 3.78 + 8.096 = 64.526$$

The food of a working bullock should have a proteid ratio of 1:13; of a horse 1:11; and of a cow in milk 1:7½. Cow's milk which is highly nutritious food has the proteid ratio of 1:5 and of goat's milk 1:4½. Food of young and growing animals should, therefore, have the proteid ratio of 1:5.

In mixing different foods for farm animals the proteid ratio suitable for each should be borne in mind as much as possible that

economy in feeding may be attended with the best of results. If the proteid ratio is too high it is waste of good food, if it is too low the food is too poor as a flesh-former.

The following table of proteid ratio gives an idea of the value of different foods for animals:—

### PROTEID RATIO.

|                                | (Nominal) | (True)     | Digestible proteids. |
|--------------------------------|-----------|------------|----------------------|
| Indian wheat grain .. ..       | 1 : 9·4   | (1 : 12)   | 7%                   |
| „ wheat bran .. ..             | 1 : 7·3   | (1 : 4·2)  | 7 „                  |
| „ wheat straw .. ..            | 1 : 25    | (1 : 20·4) | ·6 „                 |
| „ barley grain .. ..           | 1 : 11    | (1 : 7·6)  | 6 „                  |
| „ oat grain .. ..              | 1 : 13    | (1 : 5·5)  | 3·5 „                |
| Rice grain .. ..               | 1 : 20    |            | 5 „                  |
| Rice husk .. ..                | 1 : 18    |            | 2·4 „                |
| Rice straw .. ..               | 1 : 43    |            | ·4 „                 |
| Juar grain .. ..               | 1 : 10    |            | 6·6 „                |
| Juar straw .. ..               | 1 : 34    |            | ·5 „                 |
| Hay .. ..                      | 1 : 23    |            | 2 „                  |
| Linseed cake .. ..             | 1 : 2·3   |            | 26 „                 |
| Earth-nut cake .. ..           | 1 : ·8    |            | 36 „                 |
| Til cake .. ..                 | 1 : 1·7   |            | 72 „                 |
| Decorticated cotton-cake .. .. | 1 : 1·5   |            | 38 „                 |
| Indian cotton seed-cake .. ..  | 1 : 4     |            | 13 „                 |
| Peas .. ..                     | 1 : 2·7   | (1 : 2·9)  | 16 „                 |
| Bengal gram .. ..              | 1 : 4·4   |            | 14 „                 |
| Mangolds .. ..                 | 1 : 31    | (1 : 8)    | 1·2 „                |
| Potatoes .. ..                 | 1 : 18    | (1 : 10·6) | 2·1 „                |
| Maize .. ..                    | 1 : 9     |            | ·8 „                 |

Let us now see what the proteid ratio of a mixed ration consisting of 17 lbs. of hay and 6 lbs. of gram, is. We can find from the table of composition of hay, as we found in the case of gram, that it contains in every 100 lbs. 2 lbs. of digestible proteids and 46 lbs. of digestible carbonaceous food. Therefore 17 lbs. of hay contains 34 lbs. of digestible proteids and 7·82 lbs. of digestible carbonaceous food or foods, calculated as starch. We also know that 100 lbs. of gram contains 14 lbs. of digestible proteids and 61·6 lbs. (14×4·4) of carbonaceous food calculated as starch. 6 lbs. of gram would thus contain 84 lbs. of digestible proteids and 3·69 lbs. of starch. In the mixed ration therefore there is 1·18 lbs. of digestible proteids and 11·51 lbs. of starch. The albuminoid ratio of the mixed food is thus 1 : 11·51 or nearly 1 : 10. The food is thus a little too rich for horses and bullocks, though not rich enough for a cow in milk nor for young growing animals.

In mixing foods the ash constituents cannot altogether be left out of account. Maize and rice, for instance, being extremely poor in lime are unsuitable for young and growing animals. Straw and hay are particularly poor in phosphoric acid, and as bran and oil-cake are particularly rich in this constituent one of these substances should be given to young and growing animals and animals in milk along with hay or straw. So the scientific farmer should look not only to the proteid ratio, but also to the mineral requisites

of food he chooses for his various livestock, and he should consider such other circumstances as cleanliness, flavour, etc., which are valuable aids to digestion.

For calculating the *total nutriment* contained in a food-stuff, the proportions of fibre, ash, and moisture contained in it are ignored, though, as we have just said, they are not without value. The values of proteids and of carbohydrates are assumed to be equal. The fat contained in the food-stuff is calculated as being 2·3 times as valuable as either the carbohydrates or the albuminoids. To ascertain, for instance, the nutrient value, relative to other fodders similarly calculated, of paddy-straw, which contains 40·65 per cent. of carbohydrates, 1·78 per cent. of albuminoids and 2·19 per cent. of fat, one has simply to add together, 40·65, 1·78 and  $(2·19 \times 2·3)$  the result coming to 47·467.

Although chemical analysis gives no exact idea as to the digestible and other practical value of fodders, yet the following table will be found of some use in determining the merits of fodders :—

| Fodder.           | Moisture. | Ash.  | Fibre. | Fat.  | Carbohy-<br>drates. | Proteids. | Proteid ratio. | Relative nu-<br>tritive value. |
|-------------------|-----------|-------|--------|-------|---------------------|-----------|----------------|--------------------------------|
|                   | p. c.     | p. c. | p. c.  | p. c. | p. c.               | p. c.     |                |                                |
| Paddy straw ..    | 8·12      | 16·87 | 30·02  | 2·19  | 40·65               | 1·78      | 1 : 43         | 47·4                           |
| Wheat straw ..    | 8·78      | 4·16  | 44·99  | 1·29  | 37·33               | 3·45      | 1 : 25         | 43·7                           |
| Oat straw ..      | 8·74      | 4·81  | 41·52  | 2·22  | 38·89               | 3·82      | 1 : 23·5       | 47·8                           |
| Sorghum straw ..  | 8·06      | 7·08  | 30·93  | 3·14  | 48·91               | 1·61      | 1 : 54         | 56·4                           |
| Marua straw ..    | 9·88      | 12·10 | 28·22  | 2·37  | 44·88               | 2·19      | 1 : 36         | 52·7                           |
| Barley straw ..   | 15·20     | 4·26  | 66·54  | 1·36  | 8·21                | 4·43      | 1 : 17         | 15·7                           |
| Maize straw ..    | 9·57      | 5·23  | 29·97  | 1·10  | 49·17               | 5·02      | 1 : 16         | 56·7                           |
| Green Lucerne ..  | 74·00     | 2·00  | 9·50   | 1·00  | 9·40                | 4·50      | 1 : 2·5        | 16·2                           |
| Dry Lucerne ..    | Nil       | 9·40  | 26·20  | 3·40  | 43·90               | 17·10     | 1 : 2·5        | 68·8                           |
| Average cereal .. | 11·62     | 2·00  | 3·00   | 3·00  | 71·26               | 9·12      | 1 : 12         | 87·3                           |
| Average pulse ..  | 10·00     | 3·00  | 7·14   | 3·50  | 51·30               | 25·06     | 1 : 3·5        | 84·4                           |

## CHAPTER CXI.

## MANURIAL VALUE OF FOOD-STUFFS.

*Relation of food to growth and excrements.*—Generally speaking, an animal requires, as sustenance diet, four lbs. of food to every 100 lbs. of live weight and the relation between dry food and water should be about 1 : 4. Ruminants require larger quantities of coarse food, and animals with small stomachs, such as the horse require smaller quantities. Four to eight per cent. of the food

consumed is retained in the body and the rest is voided. One part of the nitrogenous food is voided in fæces and two parts in urine. A growing animal increases about 1 lb. in weight for every 8 lbs. of food consumed above the sustenance diet. The proportion of increase of weight in pigs is larger, *i.e.*, they increase 1 lb. in weight by consuming only 4 to 5 lbs. of food above the mere sustenance diet. Sustenance diet is what will keep an animal from starving or decreasing in weight. The increase in weight is due chiefly to the accumulation of water and fat and mineral matters. The proportion of development between proteids, water and fat, while an animal is fattening is as 1 : 3 : 7.

Cattle-foods vary very much in their manure value. The manurial value of food-stuffs depends almost entirely on the proportions of nitrogen, phosphoric acid and potash they contain. From these must be deducted the proportions of these constituents utilized by the animals in the building up of their bodies. Except in the case of growing animals, pregnant animals and of milch cattle, the proportions of manurial substances lost to the land by the utilization of food-substances as food first, are insignificant. In the case of nitrogen alone, Lawes and Gilbert deduced 10 to 15 per cent. of loss, as there is more wasted of nitrogen than of phosphoric acid and potash; though it was also recognised that in the case of highly nitrogenous food-substances, like oil-cake, bean-meal, etc., the manurial value of the dung is specially great. As cattle-food, linseed-cake is the best of all foods, that is, more fattening than other food-stuffs, but the manurial value of decorticated cotton-cake is much greater, as the proportions of nitrogen, phosphoric acid, and potash contained in decorticated cotton-cake are much greater than in linseed-cake. It is, therefore, from the chemical composition of food-stuffs in these three constituents that we are to infer their manurial value, making a slight deduction in the case of phosphoric acid and potash and 10 to 15 per cent. deduction in the case of nitrogen. If the farmer considers the manurial value of such food-stuffs as oil-cakes or leguminous seeds, he would not grudge giving a liberal allowance of these to his cattle, as by so doing he would not only have his animals, but his land also in good condition.

All the organic manures act slowly on the land, *i.e.*, even after a crop is taken it is assumed that half the dung applied to the land still remains unexhausted, and after two years, a third is still unexhausted. If annually cattle are hurdled on a piece of land and given oil-cake, or gram, to eat, while so hurdled, the land will get richer and richer, and the accumulated fertility of eight or ten years will bring it to a high condition, after which careful cropping and manuring may help to keep the land always in this condition.

The following figures will give an idea of the manurial value of some of the principal food-stuffs likely to be purchased :—

|  | Bran.      | Linseed-cake. | Decorticated cotton-cake. | Rape-cake.  | Peas.      |
|--|------------|---------------|---------------------------|-------------|------------|
| Nitrogen in 1 ton of food ..                   | 56.00 lbs. | 106.40 lbs.   | 147.84 lbs.               | 109.76 lbs. | 80.64 lbs. |
| Nitrogen in the manure from the food ..        | 52.84 ..   | 101.66 ..     | 143.46 ..                 | 106.92 ..   | 76.58 ..   |
| Phosphoric acid in 1 ton of food ..            | 80.64 ..   | 44.80 ..      | 69.44 ..                  | 56.00 ..    | 19.04 ..   |
| Phosphoric acid in the manure from the food .. | 78.50 ..   | 41.59 ..      | 66.48 ..                  | 54.07 ..    | 16.29 ..   |
| Potash in 1 ton of food ..                     | 32.48 ..   | 31.36 ..      | 44.80 ..                  | 33.60 ..    | 21.50 ..   |
| Potash in the manure from the food ..          | 32.21 ..   | 30.95 ..      | 44.42 ..                  | 33.35 ..    | 21.15 ..   |

## CHAPTER CXII.

## MILK.

MILK is an emulsion of fats and proteids in a solution consisting of lactose (milk-sugar,) some soluble proteids and a little mineral matter. The composition of the principal dairy produce are given below :-

|                              | Buffalo milk. | Cow's milk. | Goat's milk. | English cow's milk. | Butter.   | Separated milk. | Buffalo milk cheese. | English cheese from cow milk. |
|------------------------------|---------------|-------------|--------------|---------------------|-----------|-----------------|----------------------|-------------------------------|
| Water ..                     | 81 to 86      | 85 to 88    | 86           | 87                  | 7 to 20   | 91              | 15                   | 30 to 40                      |
| Fat ..                       | 4.6 to 9.2    | 3.0 to 6.2  | 4.7 to 5.5   | 3.8                 | 70 to 89  | .2 to 2         | 50                   | 25 to 30                      |
| Casein and other proteids .. | 3.5 to 4      | 2.5 to 3.5  | 3.4          | 4                   | } .2 to 2 | 3               | 30                   |                               |
| Sugar                        | 5             | 5           | 8.9          | 4.6                 |           | 5               | 5                    | 25 to 30                      |
| Mineral matter               | .8            | .7          | .6 to .9     | .7                  | .1        | .7 to .9        |                      |                               |
| Nitrogen                     | .6            | .48         | .54          | .64                 | Trace.    | ..              | 4.75                 | ..                            |
| Phosphoric acid              | ..            | ..          | ..           | .19                 | ..        | ..              | ..                   | ..                            |
| Potash                       | ..            | ..          | ..           | .12                 | ..        | ..              | ..                   | ..                            |
| Lime ..                      | ..            | ..          | ..           | .18                 | ..        | ..              | ..                   | ..                            |
| Sp. Gr. at 25°C ..           | 1.030         | 1.030       | ..           | 1.031               | ..        | 1.036           | ..                   | ..                            |
| Dry matter                   | ..            | ..          | ..           | 16%                 | ..        | ..              | ..                   | ..                            |



The composition of milk differs very much according to the food and the yield. The larger quantity given by a particular cow beyond a certain point, the poorer it is in fat. Watery food also results in poor milk. The last strippings from the udder are the richest in fat. The average composition of milk out of a herd of twenty cattle is fairly uniform.

Milk is not a homogeneous substance. The butter-fat which has the specific gravity of .91 being suspended in a solution of sugar (lactose) and proteids the specific gravity of which is 1.03, is not evenly distributed through the whole quantity of milk. One sample of milk from the same cow therefore differs from another sample, and a representative sample from a particular cow is difficult to get, though the mixed milk of a large dairy is fairly even in composition.

Buffalo butter, having a higher melting point than cow's butter, can be easily distinguished from the latter. *Ghee* contains less water and casein than butter, and it has a slightly higher melting point and specific gravity. Butter-fat consists chiefly of the glycerin salts of palmitic and oleic acids. The glycerides of stearic, myristic, lauric, capric, capryllic, caproic and butyric acids, are also present in small quantities. The glycerides of oleic, capric, capryllic, caproic and butyric acids are fluid at ordinary temperatures, the remaining glycerides being solid. In summer the proportion of fluid fats is greater than in winter. Food also has a great effect on the fats of butter. Rape-cake, cotton-cake, oats, and wheat-bran produce harder butter, while linseed-cake, peas, and barley produce soft butter.

When butter or ghee becomes rancid, the glycerine compounds are decomposed and the acids set free. The butyric, caproic, capryllic and capric acids having a strong smell, produce the characteristic smell of rancid butter and ghee. Since these acids are also slightly soluble in water and more so in milk, the disagreeable smell of rancid butter can be got rid of by several washings with water, or better with milk. Lard and vegetable oils are deficient in these volatile acids, and this fact helps the detection of adulteration of butter and ghee.

The proteids of milk consists of casein and albumin. The former is separated out by rennet but not the latter, while the latter is separated out by boiling. In *shar* we have butter and albumin, while in cheese we have butter and casein. In colostrum albumin greatly preponderates, so that it coagulates on boiling. In ordinary cow's milk, one-ninth of the proteids is albumin and eight-ninths are casein.

The *souring of milk* is caused by several microbes or bacteria. If these bacteria can be excluded by sterilization and preservation in air-tight vessels, the milk can be kept sweet for an indefinite period. There is a future for the sterilized milk trade in India. The bacteria act on the lactose of the milk converting it into lactic acid. This acid acts on the casein and precipitates it, which

causes the curdling of the milk. Rennet which is also a ferment acts on the casein at a moderately high temperature and precipitates the coagulated casein, but its curdling action is entirely different from that produced in the souring of milk, and in its case no similar acid is produced. The addition of rennet, however, turns the milk sour, other acids being generated. Any acid except carbonic acid, will coagulate milk, *i.e.*, cause the casein and the fat entangled in it to precipitate.

There is more than one rapid process in use for *determination of the richness of milk*. The lactometer test is largely useless, as skimming the butter increases the specific gravity of milk and an addition of water lowers this specific gravity. A dishonest dealer with the help of a lactometer can easily remove the fat by the rapid centrifugal process and then by addition of water bring up the specific gravity to 1.031 or 1.030.

The idea in all the newer rapid methods (*e.g.*, Babcock's method) is to dissolve the casein by a strong acid, say, sulphuric acid of sp. gr. 1.82. When their action goes on, there is a great rise in temperature, the fat liquefies, and when submitted to centrifugal force, it all comes to the surface and is measured in the graduated neck of the test bottle. The fault in this system lies in the fact that owing to the great rise in temperature due to a strong acid being mixed with the milk, some of the fat, with milk-sugar, gets charred to a black substance which consequently interferes with the obtaining of accurate results.

*Gerber's method* overcomes this difficulty by the addition of amyl alcohol, and it is at present considered the best and quickest volumetric test for milk-fat.

The first stage in the process is sampling of the milk by tilting it from pail to pail until the cream is well distributed throughout the whole. The sampling should be done when the milk is still warm from the cow.

A number of pipettes are then got ready. *i.e.*, 10 c.c. pipettes for acid, 11 c.c. pipettes for milk, and 1 c.c. pipette for amyl alcohol; also test bottles fitted with rubber corks and chemicals for the test.

The sulphuric acid used should be of the specific gravity 1.82; a little more or less does not matter.

First of all, 10 c.c. of the sulphuric acid are taken in a pipette. Then the test bottle is inverted in a stand and the acid is run into it. The drop or two of acid remaining in the tip of the pipette is not to be blown in. Next is put in 1 c.c. of amyl alcohol (on the top of the acid), which will slightly discolour when coming in contact with the acid. The greatest possible care must be observed in measuring the amyl alcohol, as an extra drop or two affects the result most remarkably.

Next, the milk is to be let in from the pipette drop by drop. Having put in the measured proportions of all the ingredients, the test bottles are corked and well shaken and then they are

put on the rotary machine. The test bottles are now submitted to centrifugal force in the machine for three minutes after which they may be taken out.

The fat will be noticed to have collected on the top of the liquid, that is, if the operations have been properly performed, and it is generally of a palish yellow colour. To read off the percentage, the fat must be brought on the graduated scale on the neck of the bottle. This is done by pushing in the India-rubber cork. The bottom of the layer of fat is to be got even with one of the long graduations, or where one sees one of the numbers, and then it is a simple matter to read off the percentage. Each space between the numbers represents one per cent. which is subdivided into 10 small divisions, each equal to  $\cdot 1$  per cent. So that if we have three large divisions and five small ones, this would represent 3·5 per cent. of fat, which is the composition of good milk. In reading, it is necessary that the bottom of the fat should be exactly on one of the large marks, and in reading off the decimal percentage read up to the bottom of the meniscus, which is always present at the top of the fat.

The ash or mineral matter in the milk generally settles at the bottom of the test bottle near the cork in the form of a greyish white powder.

The test bottle is to be cleaned out with hot water immediately after use, and if any fat is left in the neck, it should be removed with a fine brush, or else it will affect the accuracy of the next test.

The test of butter in milk is no criterion by which one could judge *fraudulent adulteration*. One sample of milk may be so rich that it contains  $7\frac{1}{2}$  per cent. of butter and another may contain only  $1\frac{1}{2}$  per cent. It is very hard to say whether a sample of milk has been watered, or the cow producing the milk has been fed injudiciously. Ordinary good cow's milk should give 9 to 10 per cent. of cream and about  $3\frac{1}{2}$  per cent. of butter-fat. One good Indian cow giving 5 or 6 seers of milk per day should produce annually 100 lbs. of butter or 250 lbs. of cheese. An average English dairy cow produces twice as much. One pound of cheese is obtained from about ten pounds of whole milk or fifteen pounds of skim-milk. The produce of cheese is a more reliable test of the purity of milk than the produce of butter.

## CHAPTER CXIII.

### CREAM AND BUTTER.

CREAM consists mainly of the fat-globules of milk which are separated when the milk is in the fresh state. In the hot weather, even with a centrifugal cream separator, it is not easy separating cream from milk, except with the help of ice. In the cold weather,

early in the morning or at night, this separation can be effected very easily. Cream is also separated from fresh milk by setting the milk, in the cold weather, in shallow pans. The milk after being strained through clean cloth is placed in the evening in shallow pans about four inches deep in a clean ventilated house, and in the morning with a scoop containing fine holes the cream resting on the top is cut out. If a second skimming is done, the creams of the two skimmings should be mixed up with a wooden stirrer. If a cream-separating machine is used, the separation can be effected in the morning or at night in a few minutes. Whether the separation is effected by the use of shallow pans or by a centrifugal cream-separator, the fat-globules separated out will be found to be still mixed up with the casein and sugar of the milk; the cream obtained is thus not butter. It is not even butter diluted with a little milk, as fermentation plays a part in the formation of what we generally call butter. Although the fat-globules from fresh cream can be churned out into a very tasty butter it is not proper butter that will keep for any length of time.

There are various kinds of centrifugal machines (Fig. 99) in use; the principle of all being the same: the heavier liquid is thrown out through a hole into a vessel and the column of fat-globules collecting in the middle, gradually works its way through a separate hole and a separate spout into a separate vessel. For this country, steam-power separators are not well adapted, nor very expensive hand separators either, which cost Rs. 300 to Rs. 500. The 'Lilliput' separator which is only eighteen inches high seems best suited for the needs of our

dairymen (*gowalas*), some of whom may be induced to invest Rs. 100 on this machine if the benefit of obtaining a larger quantity of cleaner butter from fresh milk throughout the cold months can be pointed out to them. In one hour a maund of milk may be treated with this machine, the average yield obtained being about four seers of cream per maund of milk.

The English *method of making butter* out of cream is not suitable under ordinary conditions in the climate of Bengal, as the proper temperature for churnings is 55°F., going gradually up to 62° or 64°F. Though sweet cream got by means of a centrifugal separator makes the best butter, we must depend in this country on making of butter from curd or sour-milk, or from *shar* which is practically the Devonshire method of making butter. The *making of cheese* is also not suited to the climate of Lower Bengal. The temperature at which the milk should be curdled by the addition of rennet is of great importance. 74° to 84°F. is

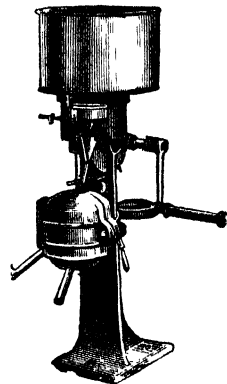

FIG. 99.—THE CREAM-SEPARATOR.

the suitable temperature, the lower temperature (74° to 80°F.) for thin cheeses and the higher (80° to 84°F.) for thick. For the subsequent ripening of cheese a fairly uniform temperature of 70°F. is also needed. It is difficult to secure these conditions in the plains.

The *appliances necessary* for a small dairy of 25 cows, yielding an average quantity of 50 seers of milk daily, are a Lilliput separator, a ten-gallon churn (Fig. 100), two pails for milking

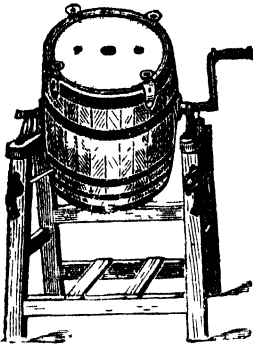

FIG. 100.—THE BUTTER CHURN.

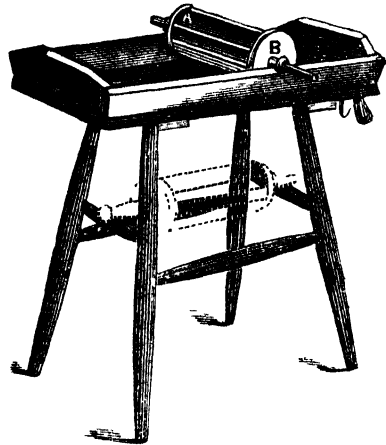

FIG. 101.—THE BUTTER-WORKER.

a hair-sieve for passing the milk into the receptacle of the separator, two glazed earthenware cream-crocks, each holding 10 seers of cream, two wooden stirrers, a butter tub, two wooden platters, a butter-worker (Fig. 101), butter prints, a marble-slab and butter scales. All the utensils should be washed with boiling water and kept scrupulously clean. The cream should be kept in the cream-crock, and the fresh skim-milk may be either converted into cheese, or given to animals, or sold as inferior milk. After each separation of cream an addition may be made to the same cream-crock, but at each addition the stirrer should be used for mixing up the different lots of cream, and the churning may take place on the second or third day. The cream-crock should be placed in a cool place. The churning should be done early in the morning at a temperature of about 60°F. The churn is only half filled with cream. During the first few minutes the ventilator of the churn should be opened out. The churning should continue for about three-quarters of an hour, at a uniform rate of about forty strokes per minute. When the butter has come, a difference of sound is noticed. Then the *butter-milk* is withdrawn from the churn, the flowing out of granules of butter being avoided by the use of the hair-sieve. Any granules accumulating in the sieve are to be returned to the churn. Then the churn is to

be half filled with cold water, and after a few turns of the churn the water is to be withdrawn in the same way as the buttermilk. The washing is to be repeated until the water comes out clean. Then the butter is to be taken out, but it should not be touched with the hand. Either the hair-sieve or the two wooden patters are to be used. When the butter has been removed from the churn, it is dealt with by the worker which is a corrugated cylinder which kneads and rolls the butter against a table. The kneading may be also done with wooden hands, well washed with salt-water, in a tub. Salt is added now to remove the water more effectually and also to enhance the keeping quality of the butter. About three ounces of salt should be used for every two seers of butter. The mass is then made up into half pound rolls or prints.

Further information on butter-making will be found in the next part of the book, in the chapter devoted to dairy bacteriology.

## CHAPTER CXIV.

### CHEESE-MAKING.

*Cream-Cheese.*—Take one gallon of fresh cream in a glazed earthenware vessel, heat or cool it to a temperature of 68° to 70°F. If the cream has been obtained by a separator, allow it to stand for four to six hours to ripen. Add fifteen to twenty drops of Hansen's rennet diluted with a little water. Stir this in for ten minutes, afterwards covering the vessel, and allow it to stand for twenty-four hours undisturbed in a temperature of 60°F. It will be now found to have coagulated, and then it should be turned into a cloth and hung inside a vessel to drain in a circulating atmosphere of about 60°F. The cloth should be a coarse material which should be thick enough to retain the curd while allowing the whey to drain out. The draining should continue for eighteen to twenty hours, and during this time the cream should be scraped two or three times from the sides of the cloth to facilitate the separation of moisture. After this it should be turned into a fresh cloth and placed under a weight of from eight to twelve lbs. until dry enough for moulding, *i.e.*, for a period of from eight to ten hours. Before moulding salt should be added at the rate of 1½ oz. to 2 ozs., to the quantity.

*Ordinary Cheese.*—Strain the fresh milk through a thick piece of cloth into a vat. Raise the temperature of the vat very gradually by letting in steam into the jacket of the vat, while slowly stirring the milk with a stirrer, until the temperature reaches 85°F. Cheese-making, therefore, should not be attempted in very hot weather, when it does not need any heating to arrive

at the temperature of 85°F. If the cheese has to be coloured, add the colour at this stage, say, 1 oz. of anatto-fluid for every ten maunds of milk used. The colouring fluid is to be mixed up with a quantity of the milk in the vat and the mixture put in so as to get a uniform distribution of colour. Then add, gradually by stirring, one seer of rennet mixed up with water to the 10 maunds of warm milk in the vat. Sufficient rennet is to be used to show some coagulation in less than a quarter of an hour. The room should be shut off from draughts of air at this time. In about half an hour the curd will solidify, and then with two curd cutting compound knives, cleaned, sharpened, and washed with boiling water, the curd is to be cut clean, first with the horizontal knife lengthwise and then with the vertical knife vertically, until little cubical masses of curd are formed in the whey. Continue to stir these cubical masses while the temperature is slowly increased to 98° or 100°F., two degrees being raised every five minutes. When this temperature is reached, gradually draw off the whey, and continue stirring briskly, and taking off the whey. Then spread the curd over a cloth to run out all the whey, and afterwards pass the curd through a grinding mill. Then mix salt evenly at the rate of 1 lb. for every five maunds of milk used. Then weigh out the salted curd into the hoops or moulds fitted with cheese-cloth. The cloth should be taken out from hot water, rinsed before putting it on the hoop and letting curd into it. The temperature of the room at the time the hoops of cheese are put under press should be about 80°F. The pressure should be slow and repeated at intervals of an hour. Then the cheese is taken out of the mould, the cheese-cloth sewn on, and after smearing the surface with hot water, pressure is applied again. The next day it is taken out and left on a shelf to ripen for two or three months.

*Rennet* should be made out of caives not more than a week old. The fourth stomach is cut out, turned inside out, wiped dry, turned back and blown out in the form of a bladder. It should be kept hung up for two weeks in a cool and dark room. Then it is cut up into stripes about  $\frac{1}{4}$  inch wide and put in a stone jar containing one seer of water which has been previously boiled and cooled. Sufficient salt is to be added to supersaturate the water. Occasionally stir and rub the strips of the stomach against the water and the sides of the jar. In three or four days the rennet will be ready. 1 seer of this rennet is sufficient for curdling 10 maunds of milk in less than an hour. Strict cleanliness is necessary at every stage.

Mr. Subba Rao, late of the Madras Agricultural Department, has been successful in making cheese, without the addition of rennet, by adding to the milk the juice of *Epicarpurus orientalis*. The milky juice of the petiole stalks of thirty-two leaves of this tree was used for four pounds of milk. In this connection it may be mentioned that Bengal *gowlás* use the juice of *sheorá*

(*Trophis aspera*) for getting quick curdling of milk. Experiments in cheese-making by the addition of a vegetable ferment, conducted under proper conditions of temperature. etc., are likely to lead to important results.

We may conclude this chapter by giving a few extracts from Mr. B. C. Basu's Report to the Indian Dairy Commission, dated 19th February, 1890.

"As the principles which underlie the separation of cream by centrifugal force, are not generally known in this country, the following description of the 'Baby' and the 'Windsor' may not be out of place. The principal part of the 'Baby' separator is the cylinder, made of the best Swedish steel, placed inside an iron-frame. This cylinder is spun like a top at the rate of 6,000 revolutions per minute by 40 revolutions of the handle, this high speed being attained through the medium of a system of axles and toothed wheels. The milk which flows into the cylinder from a can placed above it is thus made to revolve at an enormous speed, and is at once separated into cream and skim-milk in accordance with the law of dynamics that bodies revolving in a circle fly, or, if restrained, tend to fly away from the centre; and that of two bodies thus revolving, the heavier flies further from the centre than the lighter. Thus, if we put a number of leaden and wooden balls into a cup and give a rotating motion to the latter, the leaden balls will stick close to the inside of the cup, and the wooden ones will collect on the inside of the leaden balls. Now of skim-milk and cream which are the two component parts into which milk naturally separates, the former is considerably heavier than the latter. Thus when milk is made to revolve rapidly, the skim-milk being heavier flies further from the centre than the cream, and as both are restrained by the sides of the cylinder, they form two distinct layers inside the cylinder, one within the other."

The milk being thus separated, the skim-milk, which forms the outside layer, is pushed up a narrow tube opening on the inner circumference of the cylinder, into a tin-ring fitted into the top of the cylinder, and from this ring through a spout into a bucket below, and the cream which forms the inner column escapes through a notch at the top of the cylinder into a second tin-ring, and from this through a spout into the cream bucket. The flow of the milk into the cylinder is regulated by a float which is placed in a circular tin dish which intervenes between the milk and the cylinder.

"The 'Windsor' is in principle the same as the 'Baby,' from which it differs only in one or two details. These are (1) that the revolving cylinder in the 'Windsor' is horizontally placed, while in the 'Baby' it is vertical and (2) that the high speed of the cylinder in the 'Windsor' is communicated by the handle through two friction rollers, on which the axle of the cylinder rests.



“All the modern cream separators are based on the principle of separation by means of centrifugal force, as described above. They may be of any desired capacity. The larger ones have to be driven by steam-power, and can separate as many as 150 gallons of milk per hour while the ‘Baby’ has a capacity of 12 gallons and the ‘Windsor’ of 35 gallons per hour.

“The ‘Victoria’ churn shown is an end over end churn, and unlike most churns, has no beaters inside. The absence of beaters inside is said to be an advantage, as it allows the churn to be easily washed and cleaned. It may be remarked here that in all dairy operations, cleanliness of utensils is a matter of the utmost importance.

“Mr. Howman gave a series of demonstrations at the Metcalfe Hall. The chief among these are briefly described in the following paragraphs :—

“The first demonstration was intended to be a competitive trial between the English method of butter-making and the native. For this purpose a native dairyman carrying on a large milk trade at Kidderpore was induced to enter the field with Mr. Howman. The proceedings opened by making over 136½ lbs. of milk of the same quality to each of the two parties. Mr. R. Blechynden, Secretary to the Agri-Horticultural Society of India, Mr. Irving of the firm of Messrs. T. E. Thomson and Company of Calcutta, and Mr. B. C. Basu, Assistant to the Director of Agriculture, Bengal, superintended the proceedings. Mr. Howman passed his portion of the milk through the ‘Windsor’ separator, and the cream was put aside in a safe place to make it ‘ripen’ and get ready for churning butter on the next day. The native dairyman heated his milk and set it to curdle into *dahi* in earthen pots which were also put aside for the night. On the next day at 12 o’clock several other gentlemen, among whom were Mr. Finucane, Director of Agriculture, Bengal, Dr. Greenhill, Mr. Tremearne, Managing Director of the Great Eastern Hotel, and the Superintendent of the Sailors’ Home, came to see the competitive trial. Mr. Keventer placed the cream made on the previous evening into the ‘Victoria’ churn, and in less than half an hour the churning was complete, and the butter pressed and made. Against this four *gowalas* were put to work to churn the *dahi* and get out the butter in the native way. Although no attempt was made to arrive at a comparative idea of the time occupied by each process, the gentlemen who watched the proceedings came to be of opinion that the mere process of butter-making, as followed by native dairymen, would take full thrice the time as the English process of butter-making from cream. The native dairymen present at the trial seemed to be much interested in the new method, and were compelled to own that, apart from other advantages, the English method of butter-making had a decided advantage over their own in respect of the saving of labour. On weighing the two lots of butter, the superiority of the English

method became at once apparent,\* its outturn being 6 lbs. 6 ozs., against 4 lbs. 13 ozs. by the native method. The native butter also looked thinner and appeared to contain a larger percentage of water in it than the machine-turned butter. To ascertain this point, it was proposed to carry the trial further by converting the butter from either process into ghee, but during the boiling an accident occurred which put an end to the proceedings so far as the native butter was concerned. The butter from the machine gave 4 lbs. 4 ozs. of ghee (67 per cent. on the butter), and a residue of only 1 oz. 12 drs. of curd and skimmings.

"As regards the quality of the two lots of butter, Mr. Howman claimed superiority for his own; but on this point the gentlemen present were not unanimous in giving any decided opinion.

"The second demonstration was with buffalo milk. It was also intended to be a competitive trial, but the cream which Mr. Howman separated was not kept for butter-making but distributed in small quantities to several European gentlemen, all of whom pronounced the cream to be of very good quality. The native dairyman made butter out of his lot of buffalo milk and obtained  $1\frac{1}{2}$  lbs. of butter from  $22\frac{1}{2}$  lbs. of milk, which is 1 lb. of butter to 15 lbs. of milk. This shows the very rich quality of buffalo's milk as compared with the cow's."

## CHAPTER CXV.

### BACON AND HAM CURING.

FARMERS in Europe and America usually practice the art of ham and bacon curing. The principle consists in adding preserving substances to the meat and allowing time for these to saturate the tissues. This inhibits the growth of bacteria, and renders it possible to keep the meat for an indefinite period.

The carcass of the animal is rolled inside a vat filled with water at 180°F. until the hair comes away easily in the hand. Then it is put on a table and the hair removed by scrapers, after which it is hung up above a singeing furnace in which it is singed about a quarter of a minute. Then the carcass is lowered into a cold bath for a second, taken up again, and the burnt surface scraped off with hand scrapers. The intestines and offal are then removed and sorted, and the carcass after being again cleansed, is split down the back, the vertebral column removed, and the two sides including the vertebral column, the head, the feet, and the kidney fat, are weighed. This is called the dead weight of the animal. The dead-weight of an animal weighing sixteen stone is about twelve stone; from this is deducted 2 lbs.

---

\* It should be noted here that the native dairymen would have got a larger yield if they churned the *dahi* early in the morning (as they always do) instead of in the afternoon.

for evaporation, etc., and the price is fixed on the net weight. Then the head and feet are completely severed, the kidney, fat and vertebral column removed, and the sides are disconnected and allowed to cool, hung up for six to twelve hours, according to the time of the year. They are then placed in a refrigerator for twelve hours until the meat registers a temperature of 40°F. The refrigerator must be 38°F. for the meat to be cooled down to 40°F. The blade bones are then removed and the sides trimmed and taken to the cellar where they are laid on a bench and pumped at various points at a uniform pressure of 40 lbs. per square inch with a pickle made of salt, 50 parts, granulated saltpetre 5, dry antiseptic, *i.e.*, cane-sugar (in winter only) 5 parts. To these substances 20 gallons of water are added and stirred till all the material is dissolved. The strength determined by the salinometer should be 95°. If it indicates less, add more salt until it indicates 95°. The sides are wiped with a portion of the pickle used for pumping and are then laid on the cellar floor. A mixture of equal quantities of saltpetre and dry antiseptic is then sprinkled over the whole of the inside or cut surfaces, with a sieve. Salt finely ground is then sprinkled over the same surface, and the sides are now permitted to lie in that condition for seven or eight days when it will be cured and may then be washed and baled for transport, or the sides may be washed and dried as "pale dried bacon," or they may be smoked and sold as smoked bacon. If wanted in the pale dried state, the sides are hung up in a ventilated drying room heated to a temperature of 80° F. with a steam pipe, and kept there until quite dry. Smoked bacon is produced by hanging the sides in a smoke store for about three days where it is exposed to the smoke and fumes given off by smouldering hard wood sawdust. The smoke store must be well ventilated.

A simpler method is to make a pickle consisting of 5 lbs. of common salt,  $\frac{1}{2}$  lb. of saltpetre and 2 gallons of cold water, to which  $\frac{1}{2}$  lb. of sugar may be added. Into this pickle the whole or cut up carcass is kept dipped for three days at a fairly uniform temperature of 50°F., and then dry salting is done for nine days or in the case of big animals up to twelve days.

The most important points in the curing of bacon and ham are (1) cleanliness of all the operations, (2) uniformity of temperature of the cellar, and (3) evenness of density of the pickle used.

*Ham-curing.*—If the carcass is cut up into sides or smaller pieces and cured, it is called ham. Ham-curing is easier than bacon-curing, though the principle is the same. After the sides have been chilled, they are cut up into large pieces which are flung into the pickling used in the preparation of bacon. They are allowed to remain there until the next morning when they are taken out and pressed so that the blood may be entirely squeezed out from the sinews. They are then laid alternately between

layers of salt. Pumping may be done at a low pressure with an antiseptic pickle. The same mixture of antiseptic and saltpetre is sprinkled over the cut surface and the whole is covered with salt. After three days the hams are pressed again so as to squeeze out blood remaining in the sinews. They are then laid down and covered with fine salt and left in this position for fifteen days if pieces weigh about 15 lbs. They require a day for every pound weight to cure, but left for a week at least even if the weight is less than 7 lbs. Then the pieces are dried and stored.

Here is another recipe for curing ham or sides of bacon :— Pour four gallons of boiling water to  $\frac{1}{2}$  a bushel of salt and  $\frac{1}{4}$  lb of saltpetre. Stir till the mixture dissolves. When cold, add 1 lb. of treacle. Put the sides in this brine and keep it under with heavy stones. Turn it every two days and let it remain in pickle for ten days or a fortnight according to thickness. Large hams require one month to five weeks curing. Then simply rub each piece well with dry salt. Place piece upon piece on charcoal. Leave them in this way for six weeks. Then rub a little more salt and hang up. For hams use treacle or sugar and some saltpetre with the salt and rub well; for bacon salt alone does. Drip occasionally with their own brine. After six or eight weeks take up to dry and when dry put up in bags to keep out vermin.

For curing *mutton hams* the following recipe has been found very reliable :—

|                   |    |    |    |                      |
|-------------------|----|----|----|----------------------|
| Water             | .. | .. | .. | 1 gallon             |
| Black horse-salt] | .. | .. | .. | 3 lbs.               |
| Saltpetre         | .. | .. | .. | $\frac{1}{2}$ lb.    |
| Gur               | .. | .. | .. | 1 $\frac{1}{2}$ lbs. |
| Mixed spices      | .. | .. | .. | 1 ounce              |
| Juniper berries   | .. | .. | .. | 1 "                  |
| Pearl ash..       | .. | .. | .. | $\frac{1}{4}$ "      |

The hams should remain in this pickle for three weeks, being slightly agitated daily, after which they can be smoked.

## CHAPTER CXVI.

### CURING SHEEP AND OTHER SKINS.

If the skin is dry, soak it in water until it is quite soft. Scrape off any fat that is present, placing the skin on a scraping board and using a scraping knife with two handles for the purpose. Then wash the skin well in warm soap and water; wring out, but do not rinse. Then leave the skin for two days in the following mixture. To five gallons of soft water add  $3\frac{1}{2}$  lbs. of common salt and stir the mixture well until the salt dissolves completely. Then add  $1\frac{1}{2}$  lbs. of commercial sulphuric acid and stir again. This mixture will cause the hand to smart, but do no harm. Put

the skin in this mixture, then rinse it in cold water, wring out as dry as possible, and then hang it in shade to dry. During drying, the skin should be rubbed between the knuckles as when washing clothes, pulled, stretched in every way and scraped. Any hard parts may be reduced with pumice stone, though scraping with a knife also answers. As a finish, dust a little whitening over the skin and rub this all over with pumice stone. During stretching and scraping, the wool should be combed out and not left unkempt till the skin has dried.

Curing may also be done with a mixture of alum, eggs, flour and sugar laid thick over the fleshy portion of the skin after the preliminary scraping and washing. This is how soft kid-skins are made

## PART VII. INSECT AND FUNGUS PESTS.

### CHAPTER CXVII.

#### GENERAL REMEDIES AGAINST PESTS AND PARASITES.

APPLIANCES.—In America the dust of dry *Pyrethrum* leaves and various patent powders are largely used against all insect-pests. A hand-duster (Fig. 102), or one of the patent bellows, of which there are several on the market may be used for dusting all sorts of insecticides or fungicides. In Fig. 103 three different

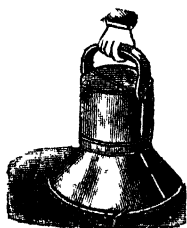

FIG. 102.—NORTON'S PLANT DUSTER.

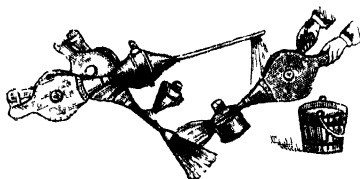

FIG. 103.—WOODASON'S BELLOWS FOR POWDER AND FLUID.

forms of bellows are illustrated: one for spraying, another for vaporizing, and the third for dusting insecticides or fungicides.

For spraying kerosene emulsion or Bordeaux mixture, one of the many forms of knapsack pumps (Fig. 104), may be used. Fig. 105 represents the general manner in which these and other spraying machines are used. The Eclair Vaporizer represented in Fig. 104 is provided with a handle which the man distributing the liquid keeps working. Air and the liquid are forced out of the same orifice by this action, and the result is the distribution of the liquid in extremely fine particles over a large space. Each time about 30 lbs. of liquid can be charged, and three such charges will be enough for sprinkling a solution over a whole acre of land

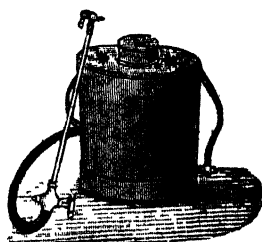

FIG. 104.—THE ECLAIR VAPORIZER.

in the course of a few hours. The vaporizer should be thoroughly cleaned and dried after it has been used, and before it is put away. Very large spraying machines and vaporizers mounted on carts and intended for spraying orchards and large plantations, are constructed, but these will hardly be found suitable for the needs of Indian cultivators. The best knapsack sprayers now obtainable in India are the 'Success' sold by Messrs. Macdougall Bros., of Bombay, and the 'Sparamotor' obtainable from Messrs. Williamson, Magor and Co., of Calcutta.

An appliance which is very useful for singeing insects on trees and shrubs, is the asbestos torch (Fig. 106). The asbestos ball is saturated with kerosene oil and lighted, and the lighted torch passed over infested branches and leaves.

The following general directions should be borne in mind in storing grain :—(a) The buildings used should be close. (b) The bin used should be tight-fitting, allowing access neither of air, nor of light, nor yet of weevils and moths. (c) The granary and its surroundings should be kept clean. (d) Refuse grains should be destroyed and not left about. (e) Grain should be dried thoroughly before it is stored. (f) Storing can be done between thick layers of well-dried *neem* leaves, or in tarred vats lined completely with dry straw. (g) Naphthalene powder, half a teaspoonful for every 10 cubic feet of space once every 15 or 10 days, or 1 ounce to every 100 bushels of grain, also keeps out insects. (h) Carbon-bisulphide, however, is the best substance to use for protecting grains stored in godowns. The gas of carbon-bisulphide, being heavy, sinks and the liquid can be thrust into the grain-store from the top. The use of a *Quarantine bin* is recommended by Mr. L. O. Howard, of the United States Department of Agriculture. Into this, all seeds and grains are put in bags as they come in, and are disinfected by carbon-bisulphide, before they are stowed away. The quantity of carbon-bisulphide used being  $1\frac{1}{2}$  lbs. for every ton of seed or grain (i) Hymenopterous insects belonging to the order Chalcididæ prey upon and destroy insects injurious to grains, and their presence in godowns should be encouraged. (g) Salted sacks, i.e., sacks dipped in a ten per cent. solution of common salt, and afterwards



FIG. 105.—MANNER OF USING SPRAYING MACHINES.

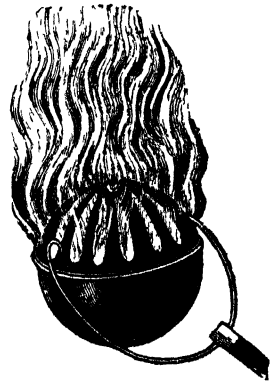

FIG. 106 — ASBESTOS TORCH.

dried, have been found very useful in keeping out weevils from grains stored in them. (*h*) For small quantities of vegetable and other seeds that may be easily stored in bottles, a drop or two of mercury shaken up with the grains in the bottles, are found most useful in keeping out insects. Mercury should not be used for storing grains meant for food and not for seed. Carbon-bisulphide can be had of Messrs. D. Waldie & Co., of Calcutta, for twelve annas a pound in quantities of 10 lbs. or more.

For *boriug insects* and other pests which can be reached only by smoke or gases, hydrocyanic acid gas may be used by means of a pair of patent vaporizing bellows. This gas is generated, by using 1 ounce of potassium cyanide with 1 ounce of sulphuric acid and 3 ounces of water placed in the glazed receiver of the bellows. The gas generated by the above quantities will be sufficient for one hundred and fifty cubic feet of space. Sometimes tents are erected over valuable shrubs and small trees, and the insects spoiling them destroyed by means of the gas generated inside the tent. Hydrocyanic gas being very dangerous, this experiment should not be readily undertaken by Indian agriculturists. Smoke from ignited *mahua* seeds oil-cake at the first appearance of an insect-pest has sometimes been found efficacious. One and a half maunds of this cake per acre burnt windward of a blighted plot seem, in certain cases, to have been quite sufficient.

For *scale-insects*, *resin-wash* is particularly useful. It is made by boiling together for three hours in a covered vessel 5 lbs. of caustic soda, 15 lbs. of resin, and sufficient water. Then the mixture is diluted with water by gradually bringing it up to 100 gallons. It is then to be strained through canvas, and when quite cool applied with an Eclair Vaporizer.

As an *insecticidal paint* for the trunk and main branches of trees that are spoilt by insects (mainly scale-insects), the following is recommended :—Boil 2 lbs. of sulphur and 1 lb. of stone-lime in two gallons of water for one and a half hours. Then add 3 lbs. more of stone-lime and boil for another half an hour. Make up with boiling water to 2 gallons and add enough fine flour or fine clay to the mixture to make it like thin paint.

When *animals* are troubled with ecto-parasites, such as ticks, lice, fleas, itch-mites, etc., they are dipped in a reservoir containing an insecticidal solution. The following mixture may be used as a *cattle dip* :—

1½ lbs. of white arsenic  
 3 lbs of soda.  
 3 lbs. of soap.  
 100 gallons of water.

Kerosene emulsion, *i.e.*, kerosene oil, shaken up with an equal proportion of boiling soap solution, or with buttermilk (*ghol*) and diluted with 100 times as much water, may be also rubbed into the skin of animals suffering from ecto-parasites. Kerosene emulsion is a very potent remedy against all soft-bodied insects.



*Fungicides.*—*Bordeaux mixture* is the standard fungicide, but as it combines well with arsenical poisons, and as a combined spray of Bordeaux mixture with an arsenical poison, such as Paris Green, acts both as an insecticide and as a fungicide. 1 lb. of one of the arsenical poisons should be mixed up finely powdered with 160 gallons of Bordeaux mixture. The Bordeaux mixture is prepared by adding to 40 gallons of water, 6 lbs. of powdered sulphate of copper, and 4 lbs. of unslaked lime previously mixed to a paste with water. If there is an excess of sulphate of copper it is apt to injure the foliage. To see if the mixture has been properly made or not, the clean blade of a knife is to be dipped into it for a minute. If the knife is untarnished, the mixture is all right, but if the knife is stained a coppery colour, more milk of lime should be added.

As an all-round combined fungicide and insecticide, may be also mentioned the *sulphur, lime and salt wash*. Take 40 lbs. of unslaked lime, 20 lbs. of sulphur, 15 lbs. of salt, and 50 gallons of water. Boil the sulphur with the water and 10 lbs. of lime for not less than one and a half hours, or until the sulphur is thoroughly dissolved, in a strong iron (not a thin copper) boiler when the mixture will be a light amber colour. The remaining 30 lbs. of lime is to be slaked with hot water, and when thoroughly slaked but still boiling, 15 lbs. of salt are to be added. When this is dissolved, the whole should be added to the lime and sulphur in the boiler, and the combined substances boiled for half an hour longer, when water, to make the whole up to 50 gallons, should be added. Then straining should be done through a wire sieve and the mixture should be well stirred before use. After using this mixture, the spraying machine must be thoroughly washed with hot water.

Another standard fungicidal solution is the *Eau Celeste*. This is made by mixing 1 lb. of sulphate of copper with 2 gallons of hot water. When cool, 1½ pints of commercial ammonia (strength 22° Baumé) are to be added. The solution is to be kept tightly corked, and when it is required for use, it should be diluted with 20 gallons of water. The Eclair Vaporizer may be used in spraying both the *Eau Celeste* and the Bordeaux mixture.

Insect-pests generally have many *natural enemies*, such as dragon-flies, ichneumon-flies, lady-birds, spiders, ants, bats, frogs, lizards, and certain birds, such as starlings, king-crows, domestic fowls, thrushes, shrikes, drongos, rollers, wood-peckers, tit-mice, jays, lap-wings, nut-hatchers, bee-eaters and plovers. Crows are very destructive to unripe grains of maize though they eat grubs also. Of all birds mentioned, starlings (*shdlik*) are the best friend of the farmer. As a rule, birds that are good to eat (such as pigeons, doves, bagaries and sparrows) or have very fine and attractive plumage (such as linnets and parrots), are destructive of grain. As these are constantly hunted by man,

they are naturally kept down. Sparrows and linnets (*babui*) perhaps do the greatest amount of damage.

*Lighting fires* at night or hanging up lanterns in plantations with troughs of water (to which a little kerosene oil may be added) underneath, is a good means of attracting and destroying some kinds of insects.

*Umbelliferous spices* (*sulpa*, coriander, etc.), repel insects, and these may be grown here and there in the midst of and around crops that are particularly subject to the attack of insects, such as cabbages, cauliflowers, brinjals, etc., but this method has not generally proved very satisfactory.

*Ichneumon flies* are largely attracted by flowers of *araha*r and country *sim* (*Dolichos lablab*). These may be grown round a plantation of sugar-cane, as ichneumon flies are known to destroy sugar-cane borers.

Free irrigation is a great preventive against cut-worms, white ants, crickets and grasshoppers. They come out of their holes and hop away as soon as a field is thoroughly irrigated. Thorough preparation of land and hurdling in of fowls (scratchers) in ploughed up fields before sowing are also good preventives.

## CHAPTER CXVIII.

### AGRICULTURAL ZOOLOGY.

BEFORE introducing the reader to the principal insects-pests that cause damage to agricultural crops, it is desirable that a bird's-eye view of the different orders of animals should be given, in a systematic manner, which may enable him to distinguish insects from among the various groups of animals that are popularly known as worms and vermin. The zoological scheme shown on p. 534 has been drawn up with special reference to insects.

A short description of each of the above groups of animals mainly bringing out the meaning of the various terms used in the above scheme will be of some use in getting an idea of the classification of the animal kingdom given in the scheme.

*Protozoa*.—The characteristic features of this class of animals are, they are simply little masses of protoplasm, without definite organs or a definite body cavity. They have no nervous, digestive or circulatory systems. The protoplasm is not surrounded by a cell-wall as in the case of vegetable cells, and the protozoa are therefore able to throw out pseudopods, i.e., prolongations of the protoplasmic mass of which their body is composed, when they notice any food substance before them. Thus they possess volition which characterizes even the lowest member of the animal kingdom. Looked at under the microscope, these lowest animals present at least three common characteristics: (1) they are nucleated masses of protoplasm; (2) besides the nucleus they have a contractile vesicle, a sort of rudimentary heart; (3) the masses

of protoplasm are full of granules. The Gregarinidæ and Rhizopoda are reproduced by fission at the nucleus. Foraminifera are encased in shells of calcium carbonate,—a particle of chalk being a mass of such shells. Radiolaria are encased in shells of silica. They have a distinct mouth. Infusoria also have a distinct mouth, but no stomach. They multiply not only by fission but also by conjugation and gemmation. Infusoria grow abundantly in rotting animal matter in presence of water. They are either ciliated or flagellated.

SCHEME NO. 1.  
ANIMAL KINGDOM.

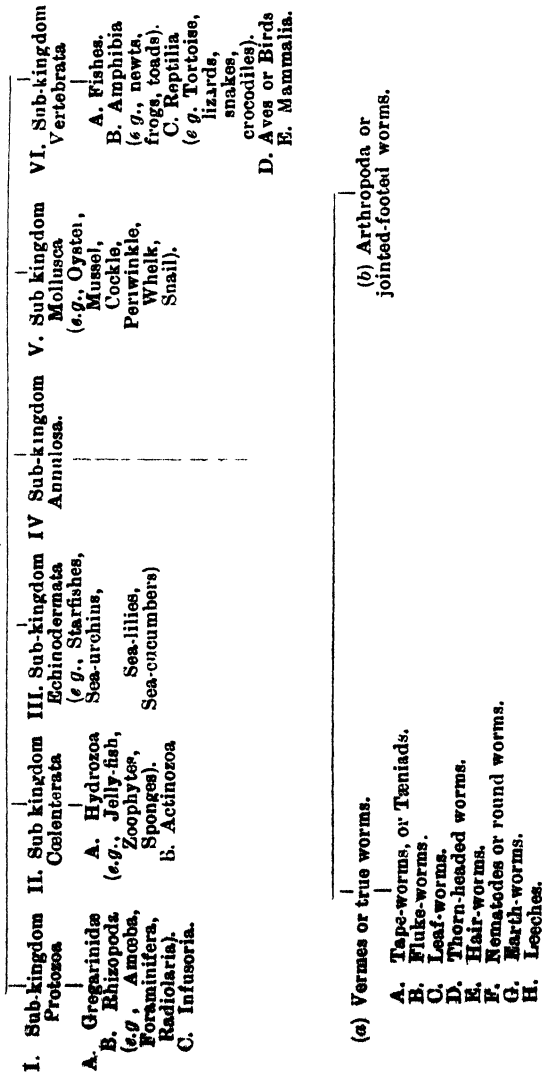

## SUB-KINGDOM IV (b).

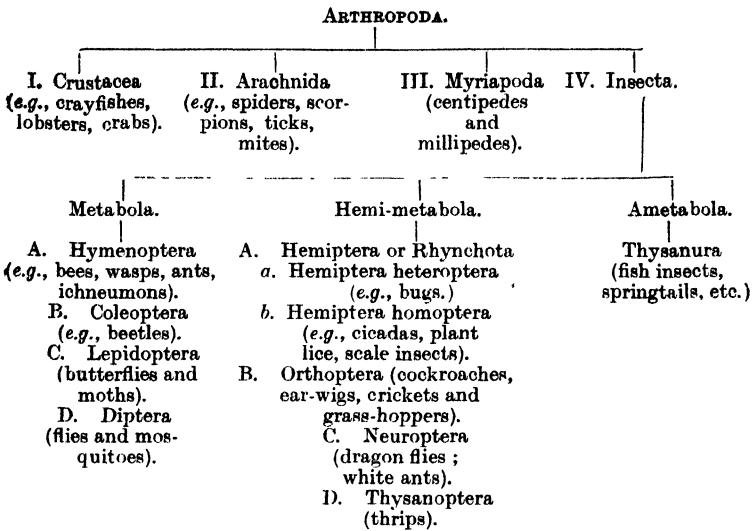

*Cœlenterata*.—These have both mouth and a body cavity ; but no nervous system, no circulatory organ, no blood. They often have distinct stinging organs. Reproduction takes place both sexually and by segmentation. They usually live in colonies (e.g., sponges and corals). They are sometimes polymorphic in character, *i.e.*, possessing more than one form, and the same form repeats itself at regular succession by a process which is known as alternation of generations.

*Echinodermata*.—In this group the body cavity is distinct from the alimentary canal. The body cavity is circulatory, belonging to the water-vascular system of circulation. There is a distinct radiate nervous system. The body is bilaterally symmetrical. Examples are star-fishes and sea-urchins.

*Annulosa*.—The bodies of these animals are in segments. They are never radiate, but more or less worm-like. Locomotor organs which are bilaterally symmetrical are present in the arthropoda, but not in true worms (*Vermes*). Reproduction of worms is either hermaphrodite, or conjugal, or parthenogenetic, or by simple gemmation. They have no true blood, a water-vascular system being present. They have a ventral nervous system which is not radiate as in the case of *Echinodermata*. Many of the true worms are parasitic. Domestic animals and birds often suffer from tape-worms. These throw out a chain of segments (proglottids), finishing up with a head which is provided with hooks and four cup-shaped suckers attached to the stomach or intestines of the host. This may be as long as 90 ft. Each proglottis has both male and female eggs, so that if one of these is

swallowed by an animal, it is enough for the reproduction of the parasite. The adult form usually occurs in the dog and only a cystic form in man, or sheep, or ox, and the superstition common among Hindus and Mahomedans that a dog is an unclean animal is a very useful superstition inasmuch as it helps to reduce the possibility of tape-worm in man. In the nematodes or round worms the male and female are separate and the body is unsegmented. Like tape-worms they are provided also with spines and suckers at the anterior end.

*Oligochaeta* or earth-worms have segmented bodies, the number of segments being one hundred or more, and they have four rows of false feet or pads. They have no suckers to their mouth, but the alimentary canal is divided into distinct portions, such as pharynx, œsophagus, proventriculus, gizzard, intestine and anus. The blood vessels are two in number and united in heart-like sacs, but it is not true blood that flows through these vessels, though it is a corpusculated fluid. The nervous system consists of a set of two ganglia above the œsophagus and two below. There are two pairs of testes.

*Hirudines* or leeches have a double chain of ganglia united by longitudinal cords and forming a collar round the gullet. The mouth of a leech is triradiate, *i.e.*, it has three jaws. In some species the jaws are provided with teeth. There are two suckers, one at the anterior end and the other at the posterior end. The stomach is provided with lateral sacs. There are nine pairs of testes, one vas deferens and a protrusible penis. The female organ is inconspicuous, but the females have two distinct ovaries and an oviduct.

*Arthropoda* including the lobster class, spider class, centipede class and insect class of animals, have a definite series of rings, the integument being hard and often chitinous. The rings dispose themselves into two distinct sections, the head and the thorax going to form one section, called the cephalothorax, and the abdomen another section. The appendages are bilateral. The blood is true blood, but there are no red corpuscles. The heart is situated longitudinally on the back. There is a double chain of ganglia at the ventral side, the foremost pair of ganglia being above the gullet and they may be assumed to correspond with the brain of higher animals. Metamorphosis takes place by ecdysis or moulting.

*Crustacea*.—This class of arthropoda have more than eight feet, some of which are abdominal. The respiration is aquatic either by means of gills or by the whole surface of the body. There are twenty pairs of antennæ.

*Arachnida* are characterized by having eight feet. The respiration is aerial, by means of tracheæ or of pulmonary chambers. The head and thorax are amalgamated. There are no antennæ and no abdominal legs, all the eight legs proceeding from the cephalothorax.

*Myriapoda* have a larger number of feet than even the Crustacea. The head is quite distinct, the thorax and the abdomen being amalgamated into one uniform chain of rings. There is a pair of antennæ. Respiration is by means of tracheæ ending in distinct spiracles.

*Insecta*.—This order will be more fully described in the next Chapter.

*Mollusca*.—These are soft-bodied animals, usually provided with a covering shell. The body is without any distinct segmentation. The nervous system consists either of a single ganglion or scattered pairs of ganglia. Heart and breathing organ are sometimes absent. The Mollusca are classified under two divisions, *viz.*, Molluscoidea and Mollusca proper. The Molluscoidea have their heart either entirely absent or quite rudimentary. The nervous system consists of one ganglion or a pair of ganglia. Brachiopoda, the bodies of which are enclosed in a bivalve shell, and Polygoa are examples of this division. The Mollusca proper have a well-developed heart with two chambers. This division consists of univalve and bivalve animals. To the former belong the Cephalopoda (*e.g.*, ammonites) and Gastropoda (*e.g.*, whelks). To the latter belong Lamellibranchæ (*e.g.*, oysters and mussels).

*Vertebrata*.—These are characterized by the possession of an internal skeleton definitely segmented. The nervous centres are dorsal and shut off from the general body-cavity. The limbs are away from the nervous centres and never more than four. In most cases the adult has a vertebral column.

*Pisces*.—Fishes are characterized by possessing a gill; their heart consists of only one auricle and one ventricle: their blood is cold, and the only limbs they have are fins.

*Amphibia*.—Frogs, toads and water-lizards or newts breathe first by gills and afterwards by lungs or by both lungs and gills. The skull has two condyles; the heart has two auricles but one ventricle; their limbs are never fins.

*Reptilia*.—These include the tortoise, vipers, lizards, and crocodiles, also the extinct saurians, such as Pterodactyle, Ichthiosaurus, etc. Respiration is never by gills: the blood is cold; the skull has only one condyle; the integumentary covering consists either of scales or plates, but never of feathers.

*Aves*.—Birds have their lungs connected with air-sacs; the heart is four-chambered as in the higher vertebrata; the blood is very warm which facilitates brooding; their bodies are covered with feathers; the forelimbs are modified in the form of wings; the skull has only one condyle. Birds are classified as:—(a) Runners (*e.g.*, ostrich); (b) Swimmers (*e.g.*, ducks, penguins, gulls, petrels); (c) Waders (*e.g.*, cranes, herons, egrets, snipes, curlews, plovers); (d) Scratchers (*e.g.*, fowl, pigeon, pheasant, grouse); (e) Climbers (*e.g.*, parrot, cuckoo, wood-pecker); (f) Perchers (*e.g.*, crows, finches, linnets, larks, thrushes, swallows,

kingfishers); and (g) Birds of prey, (*e.g.*, owls, hawks, eagles, kites, vultures).

*Mammalia*.—The lungs are without air-sacs; the bodies are covered with hair or wool; the skull has two condyles; the animals have mammary glands. *Mammalia* are classified under two heads, *viz.*, Non-placental (*e.g.*, Kangaroos), and Placental. Of Placental animals the following groups may be mentioned:—

- (a) Cetacea (*e.g.*, whale and dolphin);
- (b) Ungulata (*e.g.*, horse, ass and hog);
- (c) Ruminantia (*e.g.*, oxen, deer, sheep and goats);
- (d) Pachydermata (elephant and rhinoceros);
- (e) Carnivora (*e.g.*, seal, walrus, jackal, dog, bear, wolf, fox, tiger);
- (f) Rodentia (*e.g.*, hare, rabbit, porcupine, beaver, rat, mouse, and squirrel);
- (g) Insectivora (*e.g.*, mole and hedgehog);
- (h) Edentata (*e.g.*, ant-eater);
- (i) Cheiroptera (*e.g.*, bat);
- (j) Primates (*e.g.*, monkey and man).

## CHAPTER CXIX.

### INSECTS.\*

THE *Insecta* are characterized by the possession of six legs on the thorax. The head, thorax and abdomen are distinguishable. There is one pair of antennæ. The thorax is distinguishable into three distinct segments, called respectively the prothorax, the meso-thorax and the meta-thorax, and as there is the sternal and the dorsal or notal side to each segment, the wings are distinguished as meso-notary or meta-notary, as the case may be. The heart as in spiders, consists of eight chambers, and there are two opposite currents distinguishable. The spiracles are on the abdominal segments only.

*Hymenoptera*.—These have a long proboscis, *i.e.*, a sucking or lapping organ; the ovipositor of the female is usually a stinging organ as well. There are four wings with few veins. The wings are apparently naked but frequently clothed with short, scattered bristles. The larvæ are generally footless; pupæ inactive. There are some species of *Hymenoptera* which remain without wings in one or both sexes. Neuter ants are wingless, and even the male and female ants get wings for a little while only. There is one class of *Hymenoptera*, the ovipositors of which instead of being adapted as stinging organs, are specially adapted as boring instruments. The *Tenthredinidæ* or saw-flies come under this

---

\* For excellent accounts of Indian insects the works of H. M. Lefroy (*Indian Insect Pests, and Indian Insect Life*) published by Thacker, Spink & Co., Calcutta should be consulted.

class. No injurious insects belonging to this family have been noticed in India, though the turnip saw-fly, the corn saw-fly, the gooseberry saw-fly, are common pests in Europe. Of the stinging class, parasites belonging to the three families Formicidæ (ants), Ichneumonidæ (blue-bottles) and Chalcididæ, are fairly common in India. Ants, bees and wasps, living in communities and exhibiting wonderful intelligence, are very interesting insects to study; but they can be hardly regarded in the light of parasites. Ants do more good than harm in eating up grubs of parasites, and specially in capturing and destroying aphides and tunnel-making grubs. Ants do occasionally spoil a crop of potatoes by burrowing holes in them and eating up the starch. They are also found attacking seedlings which are usually rich in glucose, e.g., seedlings of brinjals and cabbages. Ichneumon flies which are like slender and small wasps in appearance, have very prominent ovipositors. They are usually helpful to agriculture being parasitic on a number of caterpillars. One of these, *Pimpla punctator*, is a long-bodied yellow and black wasp-like insect with a very prominent trifurcated hairy ovipositor. *Pteromalus oryzae* (Fig. 107 a), is a minute copper-green ichneumon which may be seen in rice godowns, and which is believed to be parasitic upon wheat and rice weevils. The largest number of Indian Hymenoptera helpful to agriculture belong to the family Chalcididæ. Their ovipositor is prominent; they have wings with very few veins; their habits, as a rule, are parasitic. *Cotesia flavipes* (Fig. 107 b), is a minute chalcid fly which is parasitic upon the

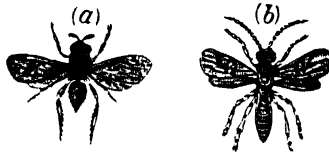

FIG. 107.—HYMENOPTERA.

(a) *Pteromalus oryzae*. (b) *Cotesia flavipes*.  
(Both magnified.)

sugarcane, sorghum and brinjal borer (*Chilo simplex*). It is very effective in keeping this destructive borer in check. The other chalcid insects collected and described in India are nearly all parasitic on the pests of tea or coffee plants.

*Coleoptera* (beetles).—The beetles are four-winged insects, the first pair of wings being horny or leathery wholly or partly covering the membranous hind-wings when closed, and meeting down the back in a straight suture. The larvæ are either with or without legs; the pupæ are inactive. Occasionally beetles are wingless (e.g., glow-worms) or with elytra soldered together. Weevils have branched antennæ.

Nearly half the insects known are beetles. The larvæ of most beetles live on vegetation, and they are very destructive



as a rule. Some are carnivorous, such as *Dermestes*, living on animal matter or on flesh. Others feed on dung and other refuse matters; others again such as the larvæ of cockchafer live on roots of plants; and some live in long galleries in the solid wood of trees, feeding on the substance of the wood.

Of carnivorous beetles may be mentioned the following:— (1) *Cicindela sexpunctata* (Fig. 108a) called in Bengali *Dhāmsā-pokā* which is a tiger-beetle. *Cicindela* devours both the 'rice hispa' and the 'rice sapper' two of the principal pests of this crop. The head of this insect is large, eyes very large and prominent; mandibles large and sharply pointed and armed with several prominent teeth. The elytra (or forewings) are spotted and long. The insect is about half an inch in length. (2) *Calosma orientale* is a ground-beetle (*Carbidae*), active and black, about the size of a small cockroach; it feeds on other insects, and has been reported as very useful in the Punjab in destroying young locusts. (3) *Trogosita mauritanica* is a small brown beetle which feeds on some of the smaller moths which are granary pests. But in its larval stage the *Trogosita* does some injury to stored wheat. (4) *Dermestes vulpinus* (Fig. 108b), called in Bengali *Kān-kutur*, the larva being called *Shorē-pokā*, is a dark coloured beetle, about  $\frac{1}{4}$  in. length with hairy larvæ, which preys on silk-worms and spoils cocoons by feeding on the chrysalids. (5) Lady-birds (*Coccinellidæ*) called in Bengali *Padma-kiṭ*, are hemispherical beetles often brilliantly coloured, which are helpful in devouring scale-insects (*Coccidæ*), plant-lice (*Aphidæ*) and other insects. There is one member of this family of beetles, however, viz., *Epilachna vigintiocto-punctata* (Fig. 108c) which deloliate pumpkin vines and brinjal plants. Of *Scarabidæ* or dung-beetles, the *Catharseus sabæus* (*gubrē-pokā*) may be mentioned here.

Of warehouse beetles, may be mentioned the following:— (1) *Silvanus surinamensis* belonging to the family *Cucujidæ*, is a little brown beetle, with active white grubs, which has been found destroying stored sorghum seed and biscuits. It is also to be seen in date fruits bought in the Calcutta bazaars. (2) *Aethriostoma undulata*, belonging to the family *Dermestidæ*, is also a little brown beetle with white hairy grubs, which are said to be destructive to wheat stored in godowns. (3) *Rhizopertha pusilla*, belonging to the family *Ptinidæ*, a minute brown beetle, commonly found in warehouses, attacking wheat, sorghum seed and biscuits. (4) *Calandra oryzae*, *Chèlè-pokā*, belonging to the weevil (*Curculionidæ*) family, is the most destructive of all warehouse pests. It is a very small dark brown beetle with a long snout and jointed antennæ. The larvæ live inside the grains of rice, wheat, maize sorghum, etc. (5) *Bruchus chinensis*, belonging to the family *Bruchidæ* is a small brown beetle which is very destructive to stored gram, *arahaṛ* and other pulses. The larvæ are little white grubs which live in the pulse seeds. (6) *Bruchus emarginatus* is a large grey weevil which destroys stored peas,

Of boring and tunnelling beetles may be mentioned the following:—(1) *Oryctes rhinoceros* belonging to the family *Dynastina* (Goliath beetle or *mál-poká*) is a very large black beetle with a protuberance on the upper part of its head something like the protuberance on the head of a rhinoceros, which damages coconut trees by cutting large holes in them through the young leaf shoots. (2) *Rhynchophorus signaticollis*, or (*Chinre-kota*) and (3) *Sphærophorus planipennis* are two weevils which also bore into the trunks of coconut and date palms. (4) The flattened legless larvæ of various species of beetles belonging to the family *Buprestidæ*, tunnel into timber and stems of various plants. (5) Bamboo *ghun* (*Dinoderus sp.*) and other *ghun* insects are also minute beetles belonging to the family *Ptinidæ*. *Dinoderus minutans* is the commonest perforator of ripe sugarcane. (6) The mango fruit weevil, *Cryptorhynchus mangifera* (Fig. 66 d) is also a tunneller.\* (7) *Platydaactylus scæspinus*, belonging to the family *Scolytidæ*, is a small brown beetle, which tunnels into the stalks of paddy plants. (8) The *Xyloborus perforans* or *Berupoka* of sugar-cane is a boring beetle. (9) The sweet-potato weevil (*Cylas formicarius*) may be also mentioned among this class.

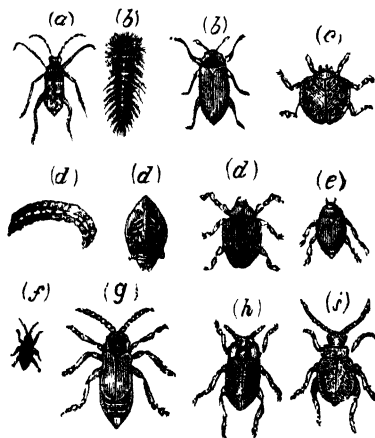

FIG. 108.—COLEOPTERA.

- |                                      |                                     |
|--------------------------------------|-------------------------------------|
| (a) <i>Cincindela Sexpunctata.</i>   | (f) <i>Hispa senescens.</i>         |
| (b) <i>Dermestes Vulpinus.</i>       | (g) <i>Aulacophora abdominalis.</i> |
| (c) <i>Epilachna 28-punctata.</i>    | (h) <i>Opabrum depressum.</i>       |
| (d) <i>Cryptorhynchus mangiferu.</i> | (i) <i>Chaetocnemis basalis.</i>    |
| (e) <i>Melonthini.</i>               |                                     |

Of beetles destructive to roots and leaves may be mentioned the cockchafers or *horá-poká* (*Melolonthini*). The curved fleshy grubs may be seen destroying the roots of plants and the black or brown imagoes may be seen at night feeding on leaves from

\* An interesting account of this insect is given in Lefrov's "Indian Insect Pests," Calcutta, 1906.

March to June. There are two species of this group found in the neighbourhood of Calcutta, called respectively, *Agogonia Blanchardi* and *Schizonycha fuscescens* (Fig. 108 e). The former is black, the latter brown. The larvæ live for about four years in the ground, during the whole of which time they live on the fine roots of plants. Where there are large tracts of uncultivated land, the grubs can thrive unmolested and the beetles can destroy cultivated crops in the neighbourhood. But though cockchafer do a great amount of damage in Russia and Southern Europe, as well as in Upper India, to agricultural crops, in Lower Bengal they have so far principally been noticed as a very destructive garden pest, defoliating every rose-bush and other plants in the hot weather. By proper cultivation, the pest can be kept off from plantations, but if they come from uncultivated tracts in the neighbourhood of a plantation, it is very difficult to deal with them. Cockchafer larvæ have been reported from Chittagong as destroying paddy and maize crops and it cannot be said that there is no danger from this source in localities where uncultivated tracts abound. The fungus (*Botrytis tenella*) which causes one of the diseases of silkworms known as muscardine, or *chunar-kete*, is said to be destructive to the larvæ of *Melolonthini* also. Silk worms affected with this disease may be dried in the shade, powdered and the powder may be applied to roots and leaves of rose and other bushes attacked by cockchafers.

Of beetles which destroy crops proper, very few have been noticed, besides the Chrysomelid beetles, *Hispa ænescens* (Fig. 108f), and *Aulacophora abdominalis* (Fig. 108 g), which will be separately dealt with in the next chapter. A large-sized Cantharid-beetle (*hanch-poká*), *Mylabris pustulata*, is destructive to the flowers of gourd, groundnut, *araha*r and some other leguminous plants. A Chrysomelid beetle (*Haltica nigrofusca*) is said to attack the leaves of garden vegetables in the Himalayas. It has been also noticed defoliating indigo plants in Rungpur. Besides *Hispa ænescens* there is (Fig. 108 i) another of the Chrysomelidæ (*Chalcocnemis basalis*), which is said to destroy paddy seedlings. A little flat beetle (*Opatrum depressum*) belonging to the family *Tenebrionidæ* attacks linseed and wheat plants (Fig. 108 h).

*Lepidoptera*.—These include butterflies and moths. The four wings of the mature insect are covered with scales. The mouth parts are often developed to an extraordinary degree forming a long-coiled proboscis or tube with which the insect sucks up honey from plants. The larvæ as well as the mature insects are often brilliantly coloured. The larvæ eat up a great quantity of green vegetable matter. The distinction between butterflies and moths is only justified as a matter of convenience.

True butterflies have their antennæ terminating in a club and they generally fly about in day-time. Of these the following may be mentioned as of agricultural interest:—(1) *Virachola*

*isocrates*, a graceful purplish butterfly, the larvæ of which bore into the fruits of guava, pomegranate, loquat, etc. (2) *Mancipium nepalensis*, or *Mancipium rapæ* (Fig. 109 a), a white butterfly, the larvæ of which have been known to attack gram, linseed, sugar-cane. This may be looked upon as an Indian form of the destructive English butterfly, *Pieris* or *Mancipium brassicæ*. (3) *Papilio erithomous* is a large swallow-tailed butterfly, the caterpillars of which defoliate orange and lemon trees, in different parts of India.

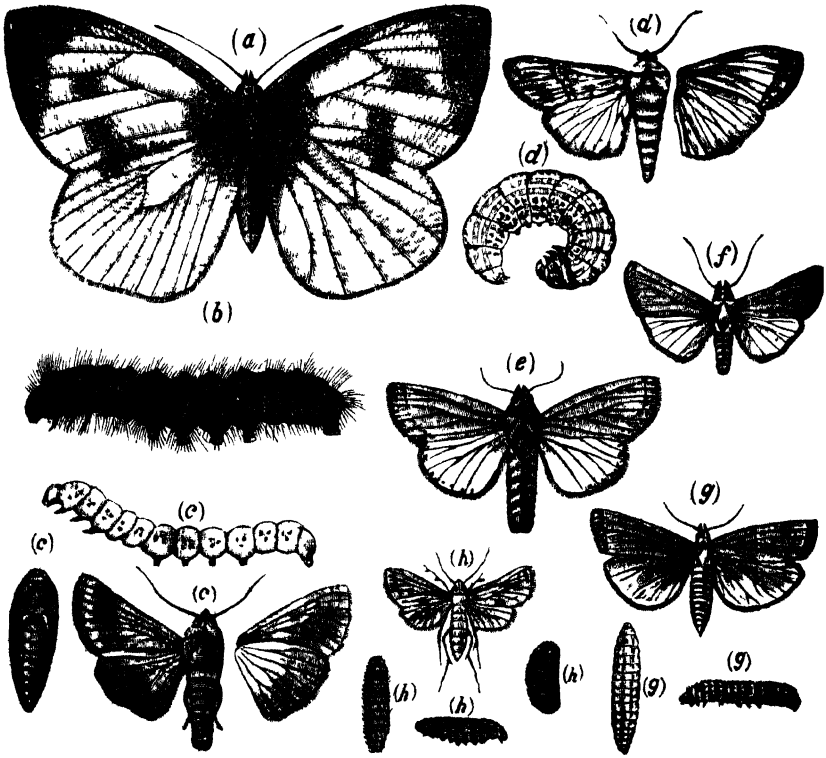

FIG 109.—LEPIDOPTERA.

- |  |  |
|--|--|
| (a) <i>Mancipium Nepalensis</i> .                      | (e) <i>Leucania loreyi</i> .                             |
| (b) <i>Alope ricini</i> .                              | (f) <i>Laphygma exigua</i> .                             |
| (c) <i>Heliothes armigera</i> (larva, pupa and imago). | (g) <i>Chilo simplex</i> (larva, pupa and imago).        |
| (d) <i>Agrotis suffusa</i> (larva and imago).          | (h) <i>Lencinodes orbonalis</i> (larvæ, pupæ and imago). |

Most of the lepidoptera of agricultural interest belong to the moths. The following may be mentioned as of special importance :—(1) The *Spilosoma* (*suán poká* or *dhua*) defoliates jute, sunn-hemp, sesamum, castor-oil and other crops. Other

hairy caterpillars like the *Spilosoma* have been known to defoliate mango trees, tea, coffee, paddy, *rabi* crops generally, and rape in particular. The *Alope ricini* (Fig. 109 b) may be mentioned as a common Indian defoliating caterpillar. (2) The *Noctues*, which are thick-bodied moths with thread-like antennæ, are very destructive in the larval stage. The larvæ, usually known as cut worms or surface caterpillars, are smooth caterpillars with four pairs of pro-legs and one pair of anal claspers, and they usually do their work of destruction at night, living in day-time hidden in the earth. The following *Noctues* moths are of special agricultural interest:—(a) *Achæa melicerte*, a greyish moth, with dark-brown hind-wings, marked with greyish white streaks. The caterpillars defoliate brinjals, paddy, sugarcane, *ajanus indicus*, castor-oil plant, etc. (b) *Heliothes armigera* called variously *leda-poká*, *kajsa*, *lurka*, is a small greyish moth, with dusky-brown hind-wings (Fig. 109 c). The caterpillars are known to be destructive to paddy, hemp (*Cannabis sativa*), poppy, *khesari*, *Dolichos lablab* and other pulses, and *rabi* crops generally, and to immature bolls of cotton. (c) *Leucania extranea* and other *Leucanidæ* the caterpillars of which are destructive to young paddy plants, oats and peas. *Leucania loreyi* (Fig. 109 e) has been found very destructive to paddy plants. (d) *Laphygma exigua* (Fig. 109 f) attacks lentil plants. (e) *Agrotis suffusa* (Fig. 109 d) and (*Ochrapleura flammatra* both attack opium plants in the same way. (3) Geometres or loopers are long, slender, smooth caterpillars which hump up the middle of the body into a loop in progressing. Their moths are slender-built creatures with large wings and comb-like antennæ. Some of these are known to be destructive to tea and coffee bushes. (4) *Chilo simplex* is the 'moth-borer' of sugarcane. (5) *Paraponyx oryzalis*, the caterpillars of which are aquatic in their habits and attack paddy plants. (6) The *Majra-poká* (*Chilo Oryzællus*) tunnels into the green stalks of paddy and wheat. (7) *Sphenarches caffer* is a minute plume moth, the caterpillars of which tunnel into the pods of *popat* bean (*Dolichos lablab* in Nagpur. (8) *Gelechia gossypiella* is the caterpillar of a minute moth which tunnels into cotton bolls. (9) *Gelechia cerealella* is the caterpillar of a minute moth which is destructive to stored maize. (10) *Tinea pellionella* is the caterpillar of the common clothes moth, and is a minute creature that protects itself in a case. It is very destructive to woollen materials. Other Tineid caterpillars attack paddy, spinning the grains together into a web. (12) Pyralid moths may be also mentioned as injurious to stored meal (hence called meal-worms) also the leaves and flowers of mustard. These minute moths have long wings which are not folded up in repose. The antennæ and legs are long and slender, abdomen long and pointed, extending considerably beyond the hind-wings. The commonest example is the *Lincinodes orbonalis* (Fig. 109 h) which spoils brinjal fruits by tunnelling holes in them.

*Diptera*.—The insects of this order have only two wings with few veins, not clothed with scales or hair. The hind-wings are replaced by rudimentary *halteres* or poisers. The mouth is furnished with a proboscis. The female is stingless, but the last joint is often prolonged into a beak-like process which helps it in making holes for the deposition of eggs. The larvæ are footless maggots; the pupæ inactive. Nearly all the dipterous larvæ live in fluid or in semi-fluid substances (e.g., putrid meat) and even the imagoes (e.g., ordinary house flies) have the power of living under water for an hour or more. The spiracles are situated close to the anus or posterior extremity of the body and they push up this end of the body occasionally to get fresh air. The slender wriggling larvæ we see in dirty water are chiefly the larvæ of mosquitos.



FIG. 110.—DIPTERA (MOSQUITO).

The principal families of dipterous insects are: (1) *Pulicidæ* or fleas (*pishu*); (2) *Muscidæ* or flesh and house flies; (3) *Cestridæ* or bot-flies; (4) *Hippoboscidæ* or sheep ticks; (5) *Tabanidæ* or horse-flies; (6) *Culicidæ* or mosquitos; (7) *Chironomidæ* or gnats; (8) *Cecidomyiidæ* or gall-midges; (9) *Tipulidæ* or crane-flies also called Daddy-longlegs; (10) *Syrphidæ* or aphis-eaters.

Of the *Muscidæ* insects may be mentioned (1) *Dacus ferrugineus*, the grubs of which are found in ripe mangoes, and (2) *Carpomyia parctalina* which is very destructive to gourds, melons, cucumbers, etc.

Of *Cecidomyiidæ* may be mentioned *Cecidomyia oryzae*, a minute fly which attacks paddy, chiefly *aus* paddy.

*Bot-flies* do a great deal of damage to ox-hides. They live in the larval state either in stomachs of animals, or in tumours under their skin, or in their nose and frontal sinuses. The class of the bot-flies called *Hypoderma* or Warbles spoil the hides of oxen. Tanners can doctor up the holes made by the bot-flies, but hides with such minute holes are classed as second class hides. Rubbing with kerosene when cattle are troubled with these flies is the best treatment.

Fleas (*pishu*) which are parasitic on domestic fowls, dogs, cats, etc., pass their larval stage in dust, and they must be looked upon as a sign of general uncleanness of the house and the animals affected. The *Pulicidæ* or fleas are without wings. Their bite produces blisters in man, but they do not thrive on human skin. The best prevention of fleas for domestic fowls is the dust bath. If the dust consists partly of ashes and lime, fleas get little chance.

We may just mention here the *Tachinid* parasites, *Trycolyga bombycis* and *Masicera grandis* which 'blow' the silkworm and the tusser silkworm respectively.

*Hemiptera* (*Rhynchota*).—The *Hemiptera* or true bugs are divided into two groups, the *Heteroptera* and the *Homoptera*.

(1) The Heteroptera have their fore-wings horny and the hind-wings (as also the tips of the fore-wings, as a rule), membranous; they are usually provided with a scutellum or shield-like protection on the back, the antennæ are long, four or five jointed; the head is generally free. This group includes the plant-bugs and the parasitic bugs (e.g., *Cimex lectularius*, the ordinary bed and chair bug, or *chhar-poka*). (2) The Homoptera have their head completely fixed to the thorax. The antennæ are short; the wings when present are membranous. This group includes the True Lice (e.g., the hair-lice, *Pediculus capitis*, or *ukun*), the Aphides or plant-lice, and the Coccidæ (bark-lice or scale insects).

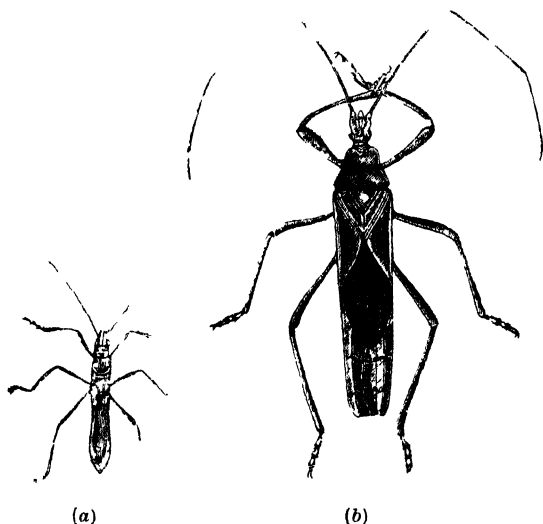

FIG. 111.—HEMIPTERA HETEROPTERA (BUGS)

(a) *Leptocorisa acuta*.

(b) *Lohita grandis*.

Of the heteropterous insects may be mentioned (1) *Apinis concinna*, a pentatomid bug which attacks *rabi* crops and vegetables. It has a prominent beak, oval body, and large mesothorax. The scutellum or shield is very large, covering nearly the whole of the wings and abdomen. (2) *Leptocorisa acuta* (Fig. 111 a), the rice-sapper (*Gandhi* or *Bhoma*) has a small triangular scutellum, long and slender body, and is yellowish brown in colour. (3) *Dysdercus cingulatus*, which has a very short scutellum, is a conspicuous red-coloured insect, about the size of a wasp. It attacks cotton, bottle-gourds, musk melon, cabbages, etc. (4) *Oxycarenus lugubris* (very like the chinch-bug of America, *Blissus leucopterus*), is a small, black, fly-like insect with a short scutellum, which commonly attacks cotton plants and cotton bolls. (5) *Lohita grandis* (Fig. 111 b) which attacks cotton plants (known as *kapasi-poká* in Nadia) is also a slender insect with hard wings and short scutellum. (6) Another bug (*Physopelta schlaubuschii*),

known as *kuti-poká* in Nadia, attacks rice plants. (7) The so-called 'mosquito blight' (*Helopeltis theivora*) of tea is also a bug. (8) *Blissus gibbus* is a bug which spoils the sugarcane leaf and growing canes by feeding on the sap or juice.

Of homopterous insects may be mentioned the following:—

1) *Aphis brassicæ*, the *jáb-poká* of mustard, etc., and other aphides. Aphides secrete a sweet honey-like substance for which they are much sought after by other insects. The fully sexual forms have large wings, but they are mainly propagated sexually. Some live on leaves, others suck the juice of green stems and leaves, others again live on roots. They are green, or brown, or black, in colour. *Phylloxera vastatrix* is the vine aphis which attacks both roots and leaves and produces little galls also. The tea-aphis (*Ceylonia theæcola*) is a blackish insect which sucks up the juice of young tea leaves and causes their edges to curl up (Fig. 112 a). (2) The *Psyllidæ*, the larvæ of which are covered by a cottony secretion, are small leaping bugs. Like aphides they subsist on the sap of plants, and exude a sweet secretion. Some species produce galls. *Psylla isitis*, which is extensively destructive to indigo in Bengal, is a gall-forming *Psyllid*. The *Psylla cistellata* is a small black fly-like insect which attacks young shoots of mango and makes them abortive.

(3) The Cicads are unable to leap, and they are larger than aphides or psyllids and sometimes very large. The males are provided with conspicuous drum-like appendages to their abdomen. They are black, green, or yellowish in colour, and the wings are either transparent or marked with a row of

moderate sized black spots on the veins. The larvæ and pupæ resemble the imago in general appearance except that the wings are undeveloped. Some large-sized cicads keep up a perpetual chirping in the silence of forests. Although cicads are commonly to be seen feeding on the sap of plants in India, none of them have been described as injurious to crops. (4) The *Coccidæ* or scale-insects are often very injurious to cultivated plants and specially to trees and perennials. The males have two wings. The females are wingless and scale-like in appearance. *Eriochiton cajani* attacks ararah. *Aspidiotus destructor* is destructive to cocconut palms. *Chionaspis aspidistræ* is injurious to the areca nut palm. *Dactylopius Bromelli* causes the curling disease of mulberry bushes, locally known in the silk districts of Bengal as

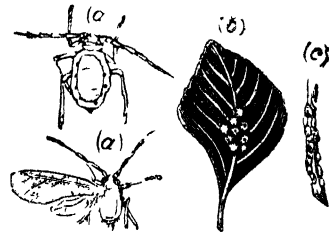

FIG. 112.—APHIDES AND SCALE-INSECTS.

- (a) *Ceylonia theæcola*, winged and unwinged.  
 (b) *Icerya Egyptiacum*.  
 (c) *Aspidiotus flavescens*.



*Tukrd.* *Icerya Ægyptiacum* (Fig. 112 b) caused wholesale destruction of trees in Egypt some years ago, and this insect has been seen on different trees in Calcutta and in Madras. *Aspidiotus flavescens* (Fig. 112 c) occasionally attacks tea-bushes, as do, in fact, a multitude of scale-insects.

*Orthoptera*.—The insects of this order, to which locusts, grasshoppers and crickets belong, have four wings, the anterior ones being narrower than the posterior ones which are usually folded up, and they are leathery rather than horny in their texture. The larvæ and pupæ are both active. The eggs are generally enclosed in a case. The hind legs are usually fashioned for leaping. The commonest example of this order will be found in the *Periplaneta orientalis*, the ordinary cockroach, belonging to the family *Blattidæ*. (2) To the family *Phasmidæ* belong the stick-insects and leaf-insects, with long slender bodies and legs, some of which are wingless. Some insects of this family are very destructive to cocoanut trees in the South Sea Islands, and when alarmed, they squirt out a highly acrid fluid, which causes blindness if it reaches the eyes. (3) *Mantidæ*, of which the well-known preying mantis is the best known, are not agricultural pests. They devour insects and are helpful to agriculture. They also have slender stick-like bodies. They deposit their eggs in spongy ball-shaped nests. (4) Next come the *Acrididæ* or short horned grasshoppers to which belong the following Indian varieties of migratory and invading locusts:—*Acridium peregrinum*, *Acridium succinctum*, *Acridium melanocorne*, *Acridium æruginosum*, *Caloptenus erubescens*, *Caloptenus caliginosus*, *Cyrtacanthacris ranacea*, *Oxyd furcifer*, *Pachytylus cinerescens*. To the *Acrididæ* belong also non-migratory locusts and grasshoppers of which many are destructive to crops. *Crotogonus sp.*, a small thick-set, brown grasshopper, is destructive to young crops of all kinds as soon as they appear above ground, such as indigo, *kalai*, *barbati*, opium, wheat, barley, linseed, rape-seed, *til*, *b ajra*, *arahar*, castor, etc. *Catantops axillaris* (*Kat-pharing*), and *Euprepocnemis bramina* attack young paddy plants. *Edalus marmoratus* and *Pæcilocera hieroglyphica* defoliate sugarcane. The most destructive of all the grasshoppers is the *Hieroglyphus furcifer* which attacks paddy and maize plants. (4) Then come the *Gryllidæ*, or the crickets (*Ui-chingri*, *usrang*, *jhingun*), the



FIG. 112.—*LIOGRYLLUS BIMACULATUS*.

abdomens of which are furnished with long ovipositors. An enormous mole-cricket (*Schizodactylus monstrosus*) is injurious to young tobacco and other crops growing on high land in Bihar, where it is known as *Bherwa*. *Gryllotalpa sp.* is a cricket which is said to injure opium plants by cutting them off when they are considerably advanced in growth. *Acheta sp.* is also said to

injure young opium. *Liogryllus bimaculatus* (Fig. 113) spoils young potato, cabbage and other *rabi* crops. (5) The long-horned grasshoppers (*Locustidæ*), which, however, do not include the common locusts and grasshoppers, are somewhat rare.

*Neuroptera*.—In this order of insects the four wings are of similar texture and with numerous veins. The wings are sometimes hairy. The dragon-flies (*jhinji-poka*, or *jhinji-pharing*) are the commonest example of this order. They can be seen in Lower Bengal in the month of October specially in large numbers, chasing their insect prey wherever they fly, and they are to be looked upon as one of the best friends the farmer has. Their larvæ live in water, and the larvæ of the few species that do live on plants feed on aphides, etc. The white-ant is the other commonest example of this order, but they are exactly of the opposite character, from a cultivator's point of view, to dragon-flies, and they have been dealt with in a separate chapter.

*Thysanoptera*.—Only the Thrips belong to this order. The wings are long, narrow, straight, equal and veinless. These minute insects either fly or hop very vigorously. Many flowers are attacked by thrips which with their biting mouth keep chewing the delicate leaves and pollen grains. The female is apterous, *i.e.*, without wings. The males are scarce, and propagation probably takes place by parthenogenesis. The males are different in appearance altogether from females. A minute black winged thrips has been noticed spoiling the turmeric crop in Madras. Another thrips has been reported as injuring the poppy in Behar where the insect is called *lhi* or *lehi*, while another injures seriously tea grown at high elevations in Darjeeling.

*Thysanura*.—These are wingless, mandibulate insects, with long, many-jointed antennæ, abdomen composed of ten segments, which do not undergo metamorphosis. Not being parasitic on plants they have no interest for students of agriculture, though they are most curious animals. They are covered with scales or hair. They have two or three long caudal appendages. The "Silver-fish" or "Fish-insects" (*Lepisma*), which are so destructive to books, are the commonest example of this order.

In the succeeding chapters we will give more detailed description of the commonest agricultural pests and treat each subject from the farmer's point of view.

## CHAPTER CXX.

### LOCUST (*ACRIDIDUM PEREGRINUM*, *ACRIDIDUM SUCCINCTUM*, ETC.).

THERE are two important types of Indian locust—that found in *Rajputana* (*Acridium peregrinum*) and that occurring in the *Deccan* (*Acridium succinctum*). The *Rajputana* locust usually breeds twice in the year, while the *Deccan* locust only once. The

breeding grounds of the Rajputana locust are the sand-hills of Rajputana, Sind, the Punjab, Jeypore and Ajmere. The chief homes of the Deccan locust are the Western Ghats. They are also found to breed in the Konkan and the adjoining part of the Deccan. From these two centres both varieties of locusts migrate to all parts of India and sometimes even to Bengal. The *Acridium succinctum* prefers the invasion of moister tracts, while the *Acridium peregrinum* chooses drier climates. Besides these two migratory locusts there are others, and some varieties of stationary locusts are found in Bengal and other provinces of India. These also do some little amount of damage.

The life-history of the Bombay locust has been very completely worked out by Mr. Lefroy, the Entomologist to the Government of India. From his description, it appears that the flying locust emerges from the grass lands, in which it has come to maturity, in September, October, or November, and enters the crops. In ordinary years, it is then observed for the first time. During the night, it usually remains motionless in the plants or on trees not feeding, and apparently numb with cold. If the nights are warm, it is active all the time, and hops away on being disturbed. During October and early November, it flies during the night, migrating from place to place. As the sun rises, the locust becomes active and commences to feed. At midday, it is flying aimlessly about in the air, feeding on the crops, and when disturbed, settling overhead. The practice of cultivators at this time is to go into the fields and beat tins to frighten the locusts, but, as a rule, this has no good effect, unless the whole field be driven by a large force of men in the early morning or evening.

From November to March the winged locust is torpid at night, and can then be killed in large numbers. With the first fall of rain the coupling period begins, and the locusts may at this time be caught by hand during the day, for they are sluggish and move little. The females lay the eggs in a hole in the ground, a hole which they take an hour and a half to make, while the actual deposition of eggs is complete in half an hour. These are never laid in dry soil, always in that more or less damp, and usually in land fairly free from jungle. They seem to prefer an uncultivated surface, and a soil not too clayey. Many were found in the embankments of low-lying fields. More still were placed on grass land.

Within five or six weeks of the laying of the eggs, the hoppers or young locusts come out. They live in the grass lands and feed upon grass and other vegetation. Their life occupies some six weeks, during which time they are unable to fly and can only leap. They are active almost from the moment they hatch, and commence feeding within an hour. In this stage, when very abundant they can be brushed in huge numbers into bags dragged over the surface of the ground and so destroyed.

About October and November the locusts become mature, acquire their wings, and begin to collect together in swarms and migrate. In Bombay, this migration takes them to the highland of the Western Ghats. During the cold weather they remain in these districts, and about the second half of March or the beginning of April, the outward movement from the ghat region commences, to the North-East, East, and South-East especially. About the end of May the swarms break up, and the locusts are scattered singly over enormous areas of country. A little later on the first fall of rain, reproduction commences as already described.

The whole history of the Bombay locusts during the year is stated by Mr. Lefroy to be as follows:—

|  |    |                                |
|--|----|--------------------------------|
| Winged locusts emerged and entered crops | .. | October 1st to 20th.           |
| “ “ migrated                             | .. | October 20th to November 30th. |
| “ “ remained in forests                  | .. | December 1st to March 20th.    |
| “ “ migrated                             | .. | March 20th to May 20th.        |
| “ “ scattered                            | .. | May 20th to June 10th.         |
| “ “ reproduced and died                  | .. | June 10th to August 10th.      |

There are several points in this life-history, at which it is possible to attack the insect. We have already indicated one, namely, the young ‘hopper’ stage before wings are acquired and when the hoppers can be brushed up off the ground into bags, attached to bamboo frames to keep the mouths open, which are dragged over the ground. In addition to this, it is often well worth while to give rewards to children or even to men in a locality, say of  $\frac{1}{4}$  to  $\frac{1}{2}$  anna, per seer for locusts collected during the cold weather or during the coupling season. Insecticides have only been effective when mixed with food, and then have only been applied on a small scale. The spreading of fodder dipped in a mixture of 1lb. lead arsenate, 5 lbs. *jaggery* and 100 gallons of water, seems to have been effective in killing the locusts, and not to have been injurious to cattle or large animals. The egg masses, in the ground, can be found and collected for payment of rewards, as described above, at the proper season.

Locusts at various stages have quite a number of enemies. Crows, monkeys, squirrels are all very fond of them. The larvæ of certain flies (large maggots) live in the abdomen and feed upon the tissues. A large red mite (*Trombidium grandissimum*) lives on the lower wings. The eggs are attacked by at least three distinct organisms. The first is a beetle grub which eats the eggs. The second is a worm which is found in great numbers in the egg clusters. The third is an icheneumon (*Scelis indicus*) which lays one egg in each locust egg.

We have hitherto spoken of the Bombay locust. The North-West or true migratory locust is *Acridium peregrinum*. In recent years it has done much damage, and is liable to visit any part of Central or Northern India. Others are *Acridium viruginosum*, common over Central and Southern India. These are probably

never gregarious, and have no special periods for reproduction. *Acridium melanocorne* is a large solitary grasshopper occurring over most parts of India, and there are quite a number of others well known in their own districts.

It may be mentioned here that Mahommedans catch locusts for food, and even preserve them for this purpose, as they regard them in the light of a holy food from Mecca. Desiccated locusts might be tinned and exported to Europe, where they are prized as food for insectivorous cage-birds and also for game-birds.

## CHAPTER CXXI.

### GRASSHOPPERS AND CRICKETS.

THE paddy grasshopper (*Hieroglyphus furcifer*).—This acrid insect (called *Pharing* and *Jhutka*) does very extensive damage to the paddy crop and also to young maize and *jura*. It attains full size when the paddy crop is nearly ripe for cutting and when cracks in paddy fields are numerous. The females can be seen laying eggs in the cracks in masses of forty or fifty about the end of November or beginning of December; five or six of such masses are deposited in different crevices by a single female. Throughout the dry season nothing more is noticed of the pest, and hidden in the crevices a certain proportion of the eggs hatch at the beginning of the rainy season. Where cold weather cultivation is practised, or where very heavy showers of rain occur in April or May keeping paddy fields submerged under water for some days before the hatching of the eggs commences, very few get the chance of hatching. When the grasshoppers are small in July and August, they hop about in the water of the paddy fields and live on the young paddy plants, hardly noticed by cultivators. They begin to be seen in September, but it is only when the plants are in ear in October and November, that the cultivators begin to recognize that the grasshoppers are doing mischief. They are non-migratory. In one instance the author noticed whole fields of paddy on one side of a road in the district of Midnapore, ruined by these grasshoppers, while on the other side of the road scarcely any damage could be noticed, and while on one side myriads of grasshoppers were hopping about and flying, on the other side there were only stray ones.

Besides locusts and *Hieroglyphus furcifer*, there are several other grasshoppers and crickets which are injurious to crops. Often several species of grasshoppers attack a crop all at once. The main difference between a cricket (*Gryllidæ*) and a grasshopper is that the cricket is furnished with a long ovipositor, while the grasshopper has only a rudimentary ovipositor. A cricket which spoils indigo plants by biting through the roots, is locally called *Bherwa* in Bihar. It has been identified as *Schizodactylus mansuetorans*. There are other crickets injurious to potato crops, to

young *juar* plants, to tea seedlings, to cotton, cabbage and other seedlings. In 1893 serious damage to jute and rice crops was reported from Comilla as caused by a cricket, which turned out to be the very common form, *Brachytrypes achatinus*.

The only suggestion that can be offered regarding remedial measures when crickets and grasshoppers are found very destructive to an ordinary agricultural crop, is to try the bags described for locust in the previous chapter. They are likely to prove efficacious in many cases. "Hopperdozers" have proved efficacious in similar cases in America. A Hopperdozer is a long and shallow trough mounted on wheels and containing water and kerosene oil, or a quantity of tar only, and dragged or driven along an infested field. The grasshoppers jump up and get drowned in the kerosene and water, or get entangled and killed in the tar. The least touch of kerosene oil kills insects. To avoid spilling, the trough should have partitions of tin. The trough itself may be made of tin, say, 9 ft. long, 1 ft. wide, 2 inches deep in front and 1 ft. behind. This trough may be mounted on a wooden frame having two wheels at the two ends. Two men may drag it along with ropes attached to the two ends of the wooden frame. A canvas screen or apron may be added to the hinder part of the trough, which will further help in bringing the grasshoppers into the trough or kill them by contact with the kerosene with which the canvas is saturated.

## CHAPTER CXXII.

### GRANARY PESTS.

**THE grain weevil (*Calandra oryzeæ*).**—This insect does a good deal of damage to stored rice, wheat, barley, maize, *juar*, etc., three to four seers per maund being often eaten up by the weevil in the course of a year.

Each female lays about 150 eggs, generally one egg being laid on one grain of cereal. She cuts a minute crevice on the grain, lays the egg in it, covers up the crevice with dust, etc., and then goes on to lay other eggs. Throughout the cold weather and hot weather this goes on, the weevils having come out during the preceding rainy season from grains stored in the same godown or vessel and remaining hidden all this time in cracks and crannies of the godown or the vessel. The egg is almost too minute to be seen with the naked eye. It hatches and the grub goes on burrowing inside the grain and eating into its substance, leaving a minute aperture behind it, to enable it to breathe. In a few weeks the grub changes into a pupa, and for a while remains dormant until it becomes a full formed weevil when it bites its way out of the grain. The breeding goes on all the year round and only quicker in the rains when the grains are softer and more readily eaten through by the grubs. Every egg laid before the rainy season commences

gets the chance of becoming a weevil; so although we may find a few weevils in the cold and the hot weather, we find the godown swarming with them towards the end of the rainy season. The time taken for the egg to develop into the perfect insect is about two months, though the time required for development depends on the temperature.

The godown or the vat where the grain is stored must be thoroughly cleaned, white-washed or tarred in the dry season, and then the grain stored and kept well covered up. The surroundings of the godown should be also clean, for the weevils crawl out of old stray and rejected grain and attack the new grain stored in the godown. The grain should be spread out very thin in the hot sun, if weevils are subsequently noticed in it: but under ordinary circumstances weevils can be only kept down by cleanliness and care, but not altogether prevented. In *jalas* tarred inside and out and kept hermetically sealed up in the dry season after storing the grain, there is almost no fear of loss from weevils. But carbon bisulphide gives the most absolute protection. In shops and godowns where such arrangements are not feasible, a mixture of lime and crude carbonate of lead (*Sapheda*) is used, but the use of this mixture should be deprecated.

Paddy is seldom attacked by this weevil, and hard wheats are not so subject to its attack as soft wheats. The weevils are not able to penetrate a thick layer of chopped straw or of dry *neem* leaves. Hence, bags of grain stored in open vats first cleaned and tarred inside, and covered up simply with chopped straw or dry *neem* leaves, are found almost entirely free from weevils. At Demerara the people are accustomed to attract ants into rice godowns with sugar, and then the ants attack the weevils.

The plan adopted in this country for protecting cobs of maize kept for seed, is to hang them up in bunches at the end of bamboos and keep them exposed to light and air and smoke inside ordinary dwelling houses. Indeed, the weevils are more destructive in town godowns than in villages, where sweeping and *leping* are practised daily, making quiet inroads of pests somewhat more difficult.

The weevils themselves are attacked in the granaries by certain Hymenopterous parasites belonging to the order Chalcididæ. Three such insects destroying the weevils have been noticed.

The vernacular names of the granary weevils are *chele poká* and *hena poká*.

*The Grain moth (Tinea granella).*—Another granary pest which may be seen in old stores of rice, and somewhat resembling the tiny moth spoiling clothes and furniture, is the wolf moth (*Tinea granella*). The larvæ of this moth collect grains of rice around them into lumps and eat them through into shells. In the chrysalis stage the insect remains hidden in cracks and crannies of the godown. The remedies applicable are similar to those recommended in the case of the weevil.

A minute grain moth attacks stored rice, maize and wheat alike. It has been identified as *Gelechia cerealella*.

*Other granary pests.*—Stored grain and leguminous seeds specially are particularly subject to the attack of a brown weevil *Bruchus chinensis* called in Bengali *ghora poká*.

## CHAPTER CXXIII.

### PADDY PESTS.

**THE RICE-BUG** (*Leptocorisa acuta*).—This insect belonging to the order Rhynchota and section Heteroptera is known to be very destructive to the paddy crop all over India while the crop is still green. It is greenish brown in colour, and nearly an inch in length with slender body, long legs and jointed antennæ, and of very offensive smell, from which it derives the name *Gandhi*. It settles on the rice plants in large numbers and sucks up the juice when the ear-heads are just coming up. It often destroys half the crop of a whole locality or district. The mode of parasitism has not been studied; but it seems the winged insect lays eggs on stems, and sucks the juice of the plants from outside, while the larvæ hatching out of the eggs actually are inside the stems of the plants and further help in the work of destruction. The pupæ probably hibernate in the soil, and when, owing to early approach of the rainy season, a long preparation of land is not possible, the majority of these pupæ get the chance of transformation into imagoes and continue breeding, as soon as the rice plants are up on which the oviposition is effected. In any case, there is hardly a rice field where a few rice-bugs may not be observed if search is made for the insect, and if for two or three seasons they get a chance of rapid multiplication due to imperfect cultivation and short exposure of turned up soil to the attack of birds, ants, etc., the attack becomes epidemic in character.

The remedy obviously suggested is a preventive one, *i.e.*, ploughing up of rice fields in the cold weather and stirring up their soil from time to time till the sowing season. If the soil is too hard immediately after the rice harvest, the first shower of rain after the harvest should be taken advantage of in ploughing up the stubble.

*The Rice Hispa* (*Hispa ænescens*). We had at the Sibpur Experimental Farm swarms of this black beetle in the rice transplanting season of 1899, *i.e.*, at the same time when several districts reported damage from this pest. It belongs to the family Chrysomelidæ, of the order Coleoptera. It does damage both in the larval and imago stages, and it pupates on the young leaves. The insects feed on the greener cellular portions of leaves, and the white fibrous blades remain exposed which give a withered appearance to whole fields. But the plants being quite young at the time, they recover their vitality and the injury done is not so



great as it appears at first. The full development of the beetles from eggs takes place within a fortnight to three weeks. But a second generation is not known to succeed during the same season, and it is not known how the beetles appear in such swarms and disappear. Probably the large swarm which appears at the time of transplanting is the second generation from hispas which have bred in waste lands and jungle and come from there to attack the plants after they are transplanted. Closer observation can alone completely clear up the life-history of the pest. Their sudden appearance and disappearance are at present looked upon by cultivators in the light of a mystery. Several remedies were tried at Sibpur. Dusting of ashes mixed with lime and arsenic, of soot, of turmeric powder, blowing Carbon-bisulphide and Cyanide of Potassium vapour, spraying tobacco decoction, kerosene emulsion and a solution of asafœtida and aloes, were tried in different plots with no marked effect at the time of application. But the beetles disappeared the next day. Another swarm, however, appeared in a few days and they were similarly treated. At this second attack were noticed large numbers of tiger beetles *Cincidela serpunctata* feeding on the hispa, and probably they were of greater help than the insecticidal applications. The prevention of the pest was successfully carried out at the same time by dipping each bunch of seedlings immediately before transplanting in a solution of asafœtida. Probably the stink kept the insects off, though some of the plots already attacked were also treated with asafœtida solution with no immediate result.

In the vernacular the hispa is variously known as *Morchè poká*, *Sukho poká*, *Senko poká*, *Pamari poká*, *Paruli poká*.\*

*The Rice-Midge (Cecidomyia oryzae).*—Serious injury to the paddy crop done by this dipterous pest was first reported in October 1880 in Monghyr, and since then it has been recognized as a pretty common and very destructive pest of the *aus* paddy crop, specially in the Bihar districts, where it is known as *mechhia*. The Hessian fly of Europe and America, *Cecidomyia destructor*, which feeds upon the sap of green stalks of wheat, and the wheat-midge (*Cecidomyia tritici*) which renders wheat plants abortive by devouring the pollen grains, are two allied species. The rice-midge is known to devour pollen grains in the same way as the wheat-midge. The maggots which are probably deposited on the ears of rice in the living stage are at first semi-transparent, but they get darker with age, and, when full-grown, resemble linseed imbedded in the substance of the ear-head. The destruction caused by the wheat-midge and the Hessian fly is so considerable that it would be wise to guard against the rice-midge.

*The 'Pattanai' butterfly (Suastus gremius).*—Occasionally green paddy plants are attacked by the larvæ of a butterfly belong-

---

\* A chrysomelid beetle *Phædo brassicae* is known to attack the mustard crop and another *Liptispa pygmaea* to attack young sugarcane plants.

ing to the family Hesperiidæ. The butterfly (Fig. 114) from one extremity of the wing to the other, when fully expanded, is about 1½ inches and it is of a glossy brown colour on the upper side of the wings, with pale yellow spots at the fore-wings. The larvæ when full-grown are about an inch in length, cylindrical and tapering at both ends, light green in colour, with a deep green line extending down the middle of the back from one extremity to the other. The spiracles are black. On a sunny day the caterpillars remain hidden in

shelters of leaves which they construct for themselves with silken threads somewhat in the style of leaf-rolling insects. Continuous heavy rains wash them down and they are killed in this way. This insect seems to be recognized as a very destructive pest of the rice-plant by the cultivators of Balasore, and though it has not done serious damage elsewhere hitherto, it is just as well to pick and kill the caterpillars when they are noticed in rice fields, and to depend on the hibernating pupæ being killed by constant and long-continued stirring of the soil before sowing, as recommended in the case of the *Leptocorisa acuta*.

The pale yellowish-green pupæ are formed in the rolls of leaves made by the caterpillars, but they probably also crawl down and hibernate in the soil. The butterfly lays eggs singly on the upper side of leaves early in the season when the rice-plants are quite young. The larvæ are known to live not only on paddy leaves but also on tender leaves of the date-palm.

*Leucania extranea*, *Leucania loreyi* and other cut-worms do considerable injury sometimes to young paddy plants; but, as has been suggested for other paddy pests of the field, these would do little damage if long-continued preparation were systematically practised by the cultivators.

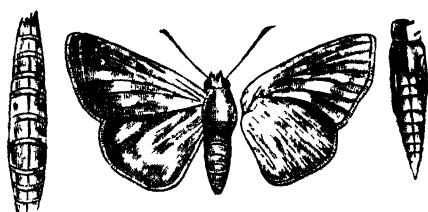

FIG. 114.—*SUASTUS GREMSIUS* (LARVA, IMAGO AND PUPA.)

## CHAPTER CXXIV.

### CUT-WORMS (NOCTUIDS).

THE Noctuid larvæ known as *katree poká*, *kájrá*, *kumwah*, *ledá-poká*, or *chorá-poká*, remain hidden in the earth in the day-time and the moths fly only at night, or in the dusk. Some species venture out in day-time, cut tender pieces of stems and take them down into their burrows for consumption, or remain hidden in leaves and stems on a bright day. They attack young plants of rice, wheat, poppy, *khesari*, cabbage, turnip, mustard, linseed, tomato, tobacco, cotton, indigo, and potatoes, and perhaps

other plants, and they destroy far more seedlings than they can possibly consume. Potato and poppy plants remain subject to the attack of the pest to the last, as their stems are always very tender and the damage done to these crops by cut-worms is often very considerable. The pupal stage is passed altogether underground, and thorough preparation for a long period seems therefore to be the best preventive. From November to February when the moths are to be commonly seen in the evening, the eggs are laid on leaves in small batches, often two or three layers deep and then lightly covered with the down of the parent moth's abdomen. Probably there is a second generation in the rainy season. The larvæ are more active when they first come out, progressing like looper caterpillars, but soon become fat and in appearance somewhat like stumpy silkworms. It is at this stage of its life that the insect is most voracious and wantonly destructive. Each caterpillar has been known to cut down fifty to a hundred plants of potatoes and poppy in one night. The pupation goes on in the soil three to eight inches under the surface, and the moth emerges in about a month. Kerosene emulsion syringed under each plant was tried successfully some years ago in the jail garden of Khulna against *Agrotis suffusa*. At the jail garden of Berhampore also this insect proved most destructive to the potato crop until the method of sowing seed of potatoes along with a mixture consisting of rape-cake, ashes, salt, lime and a little white arsenic was resorted to. No loss has taken place since then from this cause, and the use of this insecticidal manure is recommended as a preventive.

Besides *Agrotis suffusa*, there are many other Noctuid moths which are destructive to vegetables, poppy, etc. One of these is the *Heliothis armigera* called *Kujrain* in Monghyr and boll-worm in America. Young bolls of cotton are eaten into by these caterpillars and they also feed on maize, poppy, tomatoes, peas, beans and *khesari* and other pulses in the cold weather, and also in the rainy season. Rain seems to favour their growth and even in the cold weather after a heavy shower of rain they carry on their work of destruction with renewed vigour. There are three generations of these insects in the year. The caterpillar feeds on the lower surface of poppy leaves also on seeds and on the seed-pods or opium capsules. A full-grown caterpillar is over  $1\frac{1}{2}$  inch in length. It pupates in the earth. A single female moth of the boll-worm is able to lay as many as five hundred eggs, laid at dusk, chiefly on cotton plants. The larvæ live chiefly on leaves, but later on they bore into buds and bolls. Sometimes after devouring the contents of one boll, the larvæ will come out and attack another boll. The holes made by the caterpillars attract the chrysomelid beetle, *Aulacophora abdominalis*, which continues the destruction of the bolls. It is the third generation from January that is usually found parasitic on the cotton plants in about July and August.

The common cabbage moth (*Mamestra brassicæ*) is also a Noctuid. It is a brown moth with transverse black markings on the fore-wings, the centre of which is marked with white.

The *Achæa melicerte* (called *Phulguna* in Orissa), which feeds on the leaves of the castor-oil plant and the *arabar* plant, the *Plucia nigrisigna* which attacks the gram, the *Leucania extranea* (called *Ledapoka* in Eastern Bengal), which attacks paddy and pea, the *Leucania loreyi* which destroys paddy plants are also all Noctuids. *Leucania fragelis* is another Noctuid which attacks young wheat and millet plants. *Prodenia littoralis* caterpillars, also belonging to the Noctuids, did a great deal of damage to mulberry plantations in the district of Murshidabad, a few years ago, and a serious attack on tea is likewise on record. They are also known to attack potato and tobacco plants. Jute is subject to the attack of another Noctuid.

The Noctuid parasite that does most harm during the hot weather is *Agrotis segetis*. It is most destructive to the indigo crop. The moths lay eggs at night on young indigo plants in March or April. In a week the eggs hatch and the larvæ keep on eating the leaves for three weeks until they pupate, when they go down deep in the soil. The pupal stage lasts for more than a month, and a second and a more formidable crop of caterpillars sometimes occurs and does far more damage in the indigo districts in July, than the first crop in May.

Spraying is not likely to prove a practical remedy for Noctuids. Long and thorough preparation of the soil, and the use of an insecticidal and manurial mixture along with seed consisting of arsenic, lime, ashes, soot, etc., is likely to prove more efficacious. Some tachinid, chalcid and ichneumon flies are parasitic on Noctuid larvæ in the same way as tachinid flies are parasitic on silk-worms.\* Crows and starlings are also very fond of ferreting out and devouring the larvæ and pupæ of cut-worms. In cloudy and rainy weather when the caterpillars come to the surface, they are readily devoured by birds. The same is the case after irrigation, and thorough irrigation is a very good remedy against this pest. In poppy fields hand-picking of the grubs may be practised. Dusting the plants in the evening with a mixture of quicklime and ashes and the method of catching the Noctuid moths in lantern traps and also in basins containing a mixture of molasses and vinegar have been successfully tried.

## CHAPTER CXXV.

### THE SUGARCANE BORER (CHILO SIMPLEX).

THE larvæ of this moth bore into the stalks of sugarcane, maize, *juar*, and probably also the *kashia* grass (*Saccharum*

\* *Vide Handbook of Sericulture by the author (p. 112, etc.).*

*spontanæum*). A brinjal stalk borer is also a *Chilo*. The borer attacking the sugarcane, often results in putrefaction, so that the whole stalk becomes worthless. Often the borer is followed by a fungus in the work of destruction, and the wholesale loss occurring in some districts to soft varieties of sugarcane is caused jointly by the borer and the fungus, the latter in fact doing far more harm than the borer in giving rise to an epidemic. It is curious the borer and the fungus have also gone hand-in-hand in the destruction of sugarcane plantations wrought in Barbadoes, in Jamaica, in Mauritius, in British Guiana and in the United States. The pest first shows itself by the drying of the middle of the cane and the cane rotting away afterwards, and thus the disease is known in Bengal both as *Majera* and *Dhasha*. The former name should, however, be confined to the damage caused by the borer alone, the name of the borer insect being *Majera-poká*. The name *Dhasha* may be similarly properly confined to the damage caused by the agency of the *Trichosphaeria* fungus as the same name is applied to other fungoid diseases. Hard-rinded canes, which are comparatively free from the attack of the borer, are also comparatively free from the attack of the fungus.

The parent moth lays her eggs upon the leaves of the young cane near the axils, and the young borer, hatching in the course of a few days, penetrates the stalk at or near the joint, and commences to tunnel through the soft pith. The growth of the larva is very rapid, and the full size is reached in a month. The full grown larva is about an inch long, rather slender, nearly cylindrical, and cream white in colour, usually speckled with black spots, with a yellow head and black mandibles. On attaining its full size, it bores a hole on the side of the cane for its future exit and then goes back into its tunnel and pupates. The slender brown pupa is about three-quarters of an inch long. In a few days the pupa becomes a moth, and comes out of the hole already made in its larval stage. The moth is light greyish brown in colour and a little more than an inch from wing to wing when the wings are expanded. The hind wings of the male are silvery white. There are several broods in the course of the same season, and the larvæ are plentifully ensconced in the tops of cuttings sown, or the portions of the cane rejected and left neglected in fields. The hibernation takes place in winter in the larval and pupal stages, and the moths come out again in April or May.

The methods of keeping down the pest suggested by the above description are: (1) collecting all refuse leaves, tops, etc., and burning them in a heap, and (2) pickling the tops or cuttings sown with an aqueous and poisonous mixture consisting of soot, lime, ashes and arsenic made up into a thin mixture, and leaving the canes dipped in it for a few hours before planting. If sulphate of copper solution instead of plain water is used as a simultaneous preventive against *Trichosphaeria* fungus, the seed-canes should be kept dipped in the mixture only for a minute.

Thorough cultivation of soil is useful; also burning of the sod, after the harvesting of canes, the stumps and leaves being set fire to. Even after the firing, the ratoons will come up if it is intended to keep the canes a second year.

Certain special methods are said to have been effective in keeping down the sugar cane borer. These are:—(a) Collecting all leaves on which the eggs of the borer are seen and burning them. The eggs are brownish in colour and are deposited in groups of about twenty, and children can be taught to recognize them and afterwards employed in picking them from plantations. (b) Cutting out and burning all shoots or stems that appear withered or wanting in life. Children may be taught to do this also, and they may be employed in plantations for this purpose. (c) Keeping lighted lanterns hanging in sugarcane plantations at night with shallow vessels of water and kerosene under them. By adopting this last device, one can get rid of Noctuid moths and other insects in large quantities. In the month of *Kartik* (October and November) a custom prevails in this country of hanging up lights in the open at night. It may not be very difficult to induce cultivators to adopt the modified custom of hanging up lights in their fields with vessels of water underneath, during the month of *Kartik*, as it is during this month, as also in June and July, that moths, etc., lay eggs and do the greatest amount of damage to crops, though the damage is most noticed later on in the season.

## CHAPTER CXXVI.

### WHITE-ANTS (TERMES TAPROBANES) AND OTHER ANTS.

THE *white-ants* (Neuroptera) are well-known social insects which make tunnels and galleries in homesteads and fields, and thus do a great deal of mischief. They destroy most of the ordinary timbers except teak. They sometimes attack roots of living plants and trees, such as sugarcane plants and mango-trees, gradually working their way upwards. The males and females are furnished with four large wings of equal size, but the workers or neuters have no wings. Their bodies are oblong and depressed. The queen will lay 80,000 eggs in a day for a long time, and the enormous growth a colony may undergo in a short time may thus be imagined. As in the case of ordinary ants, the white-ants leave their nest for their "marriage flight" at the beginning or end of the rainy season, lose their wings, and a surviving pair after losing their wings have been said to be led into the nest by the neuters (though this is not certain) when the abdomen of the female becomes enormously distended with eggs, *i.e.*, two or three inches in length and more than half an inch in thickness (Fig. 115 *a*). She goes on laying about sixty eggs per minute. The larvæ from these eggs perform the greater part of the work of the nest, in making tunnels and galleries. The pupæ differ from larvæ in possessing rudiments

of wings. The "soldier" white-ants are distinguished by their larger head and powerful mandibles. They are probably neuters.

When white-ants attack the roots of ordinary agricultural crops such as sugarcane, rice, jute, *araha*r and vegetables, a heavy shower of rain or thorough irrigation proves the best remedy. When, however, they attack the roots of trees it is difficult to get rid of them. Vigorously growing trees, however, are seldom attacked by white-ants. Liberal application of castor-cake is the best remedy against this pest, as the insects dislike castor-cake, and the vigour imparted to the plants affords perhaps a further remedy.

Dr. Watt recommends the use of the "Gondal mixture," first prepared by the Thakore Saheb of Gondal and used by him as a white-ant destroyer. It is a mixture of Dekamali (*Gardenia lucida*) gum, asafœtida, bazaar aloes and castor-cake. (See "The Pests and Blights of the Tea Plant" by G. Watt and H. H. Mann, 1903, p. 313.)

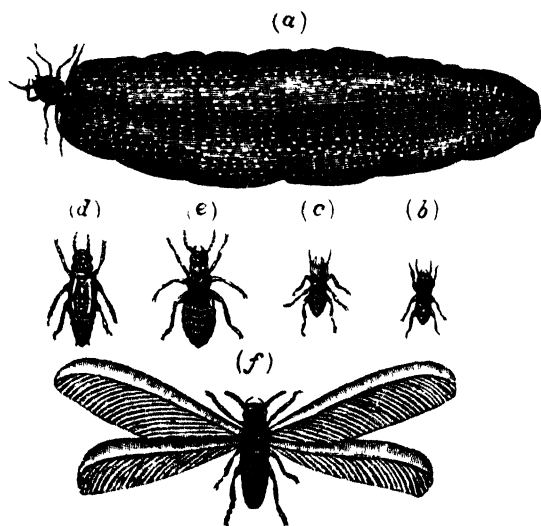

FIG. 115.— The WHITE ANT.

- |  |                     |
|--|---------------------|
| (a) Queen white-ant ready to deposit eggs. | (c) Soldier neuter. |
| (b) Working neuter.                        | (d) Male pupa.      |
| (f) Winged white-ant                       | (e) Female pupa.    |

*Ordinary ants (the Formicidæ—order Hymenoptera).*—Against ordinary ants, of which there are several species, the following remedies have been found useful:—(1) Attracting them with cocoanut kernels mixed up with sugar and then destroying them by drowning or otherwise from time to time. (2) Attracting them with a sponge dipped in a strong solution of sugar, and drowning them in hot water. (3) Strings dipped in corrosive sublimate

solution (1 : 2,000) may be laid along corners of godowns whence ants make their approach or the solution may be brushed on to the whole floor. (4) Agave fibre mats are said to be a protection against both white-ants and common ants. (5) Turmeric powder is very efficacious against red ants. (6) Of patent preparations reported favourably may be mentioned the "Atlas Preservative A." Messrs. Crowder and Company of Calcutta are the local agents for sale of this preparation. It cannot be applied to a living crop in the ground as it destroys the plant.

Ordinary ants (*Formicidæ*) belong to a different order altogether from white-ants, the former coming under Hymenoptera and the latter under Neuroptera. There are several common and injurious members of the Formicidæ, e.g., the *Formica saccharivora* (*Gondo-pimpra*), the *Formica fuliginosa* (the common jet black ant); and the *Camponotus sericeus* (the ordinary big black ant). The *Camponotus smaragdinus* (*Kat-pimpra*), a greenish and large-sized ant which lives on trees and makes large-sized nests of live leaves connected by a white web, belongs to the sub-family Formicidæ, while the ordinary red house-ant (*Diplorhoptrum molestum*) belongs to the sub-family Myrmicinæ, which are armed with a sting. The Formicidæ, though stingless, often bite very sharply (e.g., *Kat-pimpra*).

## CHAPTER CXXVII.

### THE MANGO WEEVIL (*CRYPTORHYNCHUS MANGIFERA*).

THIS weevil (Fig. 108*d, d*), which is very much larger in size (about  $\frac{1}{4}$  of an inch being its length) than the granary weevil, belongs to the family Curculionidæ of the order Coleoptera. It can be cut open from many ripe mangoes, specially those hailing from Eastern Bengal, where it occurs very plentifully. The weevils are black when they newly come out of a fruit, but on drying they assume a rusty-brown colour. The larvæ are white, fat, with fleshy tubercles instead of legs. As both larvæ and pupæ as well as imagoes can be got out from the same mango, the pupal stage cannot last long. The hibernation through the autumn and winter months takes place in the imago stage when the insects usually lie concealed in the bark of the tree. Then they are noticed in May, June and July flying about. Whether these are the last season's weevils or fresh weevils from early fruits is not known. It is not known exactly whether the oviposition takes place on flowers or young fruits or on stems or barks. No hole or pustule of any kind is noticed on the surface of affected fruits.

The remedies suggested are :- (1) Cultivation of land under mango-trees and growing turmeric, or ginger, or some such



aromatic plant that will grow well in shade. (2) Letting poultry in after cultivation but before sowing of seed. (3) Allowing servants and others habitually to cook under the affected trees. (4) Carefully removing and destroying all stray fruits, stones, rind and refuse of mango-trees generally. (5) Keeping crevices and holes in the trunk of the mango-trees plastered over or otherwise obliterated. In Europe trunks of valuable trees are painted or tarred to protect them from insect pests. It is probable the weevils hibernate in the crevices of the trunk, and the effect of painting the trunks on a large scale may be watched in some Eastern Bengal districts.

The larva of a dipterous insect (*Dacus ferrugineus*) spoils late ripening mangoes in certain localities. The Malda mangoes growing in the Katgola garden in Murshidabad are annually spoilt by these maggots. The remedies recommended for this pest are the same as for the weevil. Probably the oviposition in the case of the weevil takes place when the trees are bearing small fruits and in the case of the maggot, just before the fruits ripen. Spraying with kerosene emulsion or asafoetida water, for the purpose of producing a stink in the vicinity of trees one wishes to protect from the flies, is a treatment that may be suggested in the case of the maggot. The spraying should be done when the fruits are still green but properly developed.

## CHAPTER CXXVIII.

### THE INDIAN GOLDEN-APPLE-BEETLE.

(*Aulacophora abdominalis*.)

THIS is a Coleopterous insect belonging to the family Chrysomelidæ. It destroys various Indian crops and in its turn it is usually destroyed by a coccinellid beetle known as *Palceopeda sex-maculata*. We have noticed both these insects in the Sibpur Farm on cotton, gourd, melon, and cucumber plants. Watermelons, *jhingas* and *palval* creepers growing in the same field are hardly attacked. In the Saharanpur Botanical Garden it was found to be generally destructive to all Cucurbitaceous plants. It is said to attack the floating water-nut plants (*Trapa bispinosa*) also. The beetle is a little under half an inch in length, brilliant reddish yellow in colour, the wings are yellow and do not entirely cover the abdomen. The legs are reddish yellow. The under-surface is partly yellow and partly black. Heavy dusting with ashes is the remedy ordinarily adopted.

## CHAPTER CXXIX.

### PLANT-LICE AND SCALE-INSECTS (APHIDES AND COCCIDÆ).

THESE hemipterous insects are very destructive. Plant-lice (aphides) are more destructive to agricultural crops than scale-insects. The commonest aphid of Bengal is the *jáb-poká* (*Aphis brassicæ*) of the mustard crop. Aphides are also known to attack potatoes, cabbages, cauliflowers, tobacco, *asahar*, turnip, radish, etc. An aphid which produced curling and twisting of leaves of the tobacco plants grown at the Sibpur Farm in 1892-93 was identified as *Siphonophora scabiosa*. The coccinellid beetles (lady birds) that preyed upon these were identified as *Chilomenes sex-maculata*. Another aphid which causes injury to the mustard and rape crops was identified by the authorities of the Indian Museum as *Rhopalosiphum dianthi*. The females which are generally wingless are viviparous, their abdomen being transparent; the yellow young embryos may be seen through the green skin of the abdomen. The colour of the insect, however, is not always green, but it is sometimes red, brown, yellow, or black. The pupæ and the larvæ can hardly be distinguished. The wing-cases of the pupæ are tipped with brown and the points of the antennæ are also brown. The larvæ are the most voracious. Males are very rare, and for a number of generations their help is not required for fertilization. The asexual larvæ usually develop into wingless females. The fully mature sexual forms have prominent wings, but they also are propagated asexually. The blackish tea-aphid has been already spoken of.

The belief that blights, that is, the appearance of aphides and coccidæ insects, are due to fog or east wind, is common not only in this country but also in England, but it is a mere superstitious belief. The extraordinary multiplication of the aphides gives one the idea that they appear all of a sudden, and their apparent sudden appearance is accounted for in some fanciful way. Suppose one little aphid produced from an egg deposited last autumn should appear in spring on a bean creeper when it is just budding. She gives birth, say, to ten young aphides each of which is a female. In a few days these ten females without any connection with a male will each produce another ten agamogenetic females. If the weather is fine and the aphides are not tracked by ants or other insects, and if the beanstalk continues flourishing, this agamogenetic propagation will go on every four or five days for about twelve generations, the rate of increase being, say, ten in every case. If a calculation is made, it will be found that in less than two months from one aphid one billion may be produced, and if the rate of increase be one hundred instead of ten, the number comes to something enormous. The last generations are partly male and partly female, the intermediate generations being wingless and imperfect

females. The male and female pair and lay eggs in the autumn or in the cold weather and from these eggs come males and females of the following spring.

*The Scale-insects.*—The Aleurodes which invade rose bushes, orange trees, sugarcane plants; the *Icerya* which spoil various fruit trees, etc.; the *Dactylopius*, one species of which causes the disease known as *tukra* to mulberry trees, and other coccid insects are preyed upon in their turn by lady-birds (Coccinellidæ) beetles. But the latter are unable to cope with the insects when they become too numerous, when kerosene emulsion and other special remedies already described may be tried with success.

Scale-insects do considerable damage to fruit trees and other perennials, but they do not do such damage to ordinary agricultural crops as the other hemipterous insects (aphides) we have just described. There are several scale-insects, on the other hand, which manufacture some important economic products. Cochineal and lac are produced respectively by *Coccus cacti* and *Coccus lacca*. Manna is the gummy secretion of the tamarisk tree which is punctured by *Coccus manniparus*. The white wax of commerce is produced by *Eriocerus pela*, a Chinese scale-insect. There is an Indian scale-insect also (*Ceroplastes ceriferus*) which yields a white wax. The females of scale-insects are always wingless, and they are scale-like. The male is provided with two wings, but, as in aphides, their presence is not always necessary for the formation of the embryo.

Coccinellid beetles are very useful in devouring scale-insects and aphides. It should be remembered, however, that they are not invariably friends to the cultivator. The larvæ of *Epilachna dodeca-stigma* and others of the same genus attack the leaves of brinjal plants and sometimes do a great deal of damage.

For aphides and scale-insects the kerosene emulsion treatment generally proves most efficacious. One part of kerosene oil to eighty or one hundred part of water should be used. The oil should be mixed up with equal quantity of fresh-milk or butter-milk (*ghol*) and thoroughly worked up with a syringe or shaken up in a bottle to emulsify the oil, before it is mixed up with water and applied with a spray-pump.

## CHAPTER CXXX.

### INSECTS INJURIOUS TO INDIAN CROPS.

#### *Paddy.*

1. COCKCHAFFER LARVÆ (Melolonthini, order Coleoptera).
2. *Lasioderma testaceum*, or the cheroot weevil (Ptinidæ, order Coleoptera).
3. *Calandra oryzae* (Curculionidæ, order Coleoptera).
4. *Platyedactylus sexspinosus* (Scolytidæ, order Coleoptera).

5. *Hispa aenescens* (Chrysomelidæ, order Coleoptera).
6. *Aulacophora abdominalis* (Chrysomelidæ, order Coleoptera).
7. *Chætocnemis basalis* (Chrysomelidæ, order Coleoptera).
8. *Suastus gremius* (Hesperidæ, or skippers, Lepidoptera).
9. *Limacodid* caterpillars (Nettle-grub-defoliator, Lepidoptera).
10. *Achaea melicerte* (Noctues, Lepidoptera).
11. *Heliothis armigera* (Noctues, Lepidoptera).
12. *Leucania extrania* (Noctues, Lepidoptera).
13. *Do. loreyi* (Do. Do.)
14. *Paraponyx oryzalis* (Hydrocampidæ, Micro-lepidoptera).
15. *Chilo oryzællus* (Crambidæ, Micro-lepidoptera).
16. *Cecidomyia oryzæ* (Cecidomyidæ, Diptera).
17. *Leptocorisa acuta* (Rhynchota, Hemiptera).
18. *Physopelta schlaubuschii* (Rhynchota, Do.)
19. *Catantops axillaris* (Acrididæ, Orthoptera)
20. *Hieroglyphus furcifer* (Acrididæ, Do.)
21. *Euprepocnemis bramma* (Acrididæ, Do.)

-----

*Wheat.*

1. *Trogosita mauritanica* (Trogositidæ, Coleoptera).
2. *Arthriostoma undulata* (Dermestidæ, Do. )
3. *Rhizopertha pusilla* (Ptinidæ, Do. )
4. *Opatrum depressum* (Tenebrionidæ, Do. )
5. *Calandra Oryzæ* (Curculionidæ, Do. )
6. *Agrotis suffusa* (Noctues, Lepidoptera).
7. *Chilo oryzællus* (Crambidæ, Do.)
8. *Crotogonus sp.* (Acrididæ, Orthoptera).

-----

*Barley.*

1. *Agrotis suffusa.*
  2. *Crotogonus sp.*
- 

*Oats.*

1. *Leucania extrania.*
  2. *Agrotis suffusa.*
- 

*Juar.*

1. *Silvanus surinamensis* (Cucujidæ, Coleoptera).
2. *Rhizopertha pusilla* (Ptinidæ, Do. )
3. *Epicauta rouxi* (Cantharidæ, Do. )
4. *Epicauta tenuicollis* (Cantharidæ, Do. )

*Maize.*

1. *Chilo Simplex* (Crambidæ, Lepidoptera).
2. *Gelechia cerealella* (Plutellidæ, Microlepidoptera)
3. *Hieroglyphus furcifer*.

*Panicum miliare.*

1. *Euprepocnemis bramina*.

*Bajra.*

1. *Crotogonus* sp.

*Sugarcane.*

1. *Xyleborus perforans*, *beru poká* (Scolytidæ, Coleoptera).
2. *Mancipium nepalensis* (Pierinæ, Lepidoptera).
3. *Achæa melicerte* (Noctues, Lepidoptera).
4. *Scirpophaga auriflua* (Microlepidoptera, Lepidoptera).
5. *Chilo simplex*, *majera-poká*.
6. *Dragana pansalis* (Deltoides, Lepidoptera).
7. *Ædalus marmoratus* (Acrididæ, Orthoptera).
8. *Pæcilocera hieroglyphica* (Acrididæ, Do.)
9. *Termes taprobanes* (Termitidæ, Neuroptera).
10. *Dorylus orientalis*, driver ant (Formicidæ, Hymenoptera).
11. *Blissus gibbus* (Chinch-bug, Hemiptera).
12. *Ripersia sacchari* (Scale-insect, Do.)

*Gram.*

1. *Aulacophora abdominalis*.
2. *Mancipium nepalensis*.
3. *Parasa* sp. (Limacodidæ, Lepidoptera).
4. *Agrotis suffusa*.
5. *Plusia nigrisigna* (Plusidæ, Noctues, Lepidoptera).

*Arahar.*

1. *Bruchus Chinensis* (Bruchidæ, Coleoptera).
2. *Achæa melicerte*.
3. *Eriochiton cajani* (Coccidæ, Hemiptera).

*Brinjal.*

1. *Epilachna viginti-octo-punctata*.
2. *Achæa melicerte*.
3. *Chilo* sp.
4. *Lencinodes orbonalis* (Microlepidoptera).

*Cucurbitaceous crops generally.*

1. *Aulacophora abdominalis*.
2. *Epilachma viginti-octo-punctata*.
3. *Carpomyia parctalina* (Muscidæ, Diptera).

-----  
*Jute.*

1. *Spilosoma sp.* (Arctiidæ, Lepidoptera).
2. Noctuids.

-----  
*Cotton.*

1. *Sphonoptera gossypii* (Buprestidæ, Coleoptera).
2. *Aulacophora abdominalis*.
3. *Heliothis armigera*.
4. *Dipressaria gossypiella* (Plutellidæ, Microlepidoptera).
5. *Dysdercus cingulatus* (Rhynchota, Hemiptera).
6. *Oxycarenus liguibris* (Do. Do.)
7. *Lohita grandis* (Do. Do.)

-----  
*Mustard.*

1. *Agrotis suffusa* and other Noctuids.
2. *Aphis brassicæ* (Aphidæ, Hemiptera).

-----  
*Linseed.*

1. *Opatrum depressum*.
2. *Mancipium nepalensis*.
3. *Agrotis suffusa*.
4. *Crotogonus sp.*

-----  
*Indigo.*

1. *Haltica nigrofusca* (Chrysomelidæ, Coleoptera).
2. *Agrotis segetum*.
3. *Psylla isitis* (Psyllidæ, Hemiptera).
4. *Crotogonus sp.*

-----  
*Rabi crops generally.*

1. *Heliothis armigera*.
2. *Apinis concinna* (Rhynchota, Hemiptera).
3. *Fulgoridæ* (Lantern flies, Do.)

-----  
*Kharif crops generally.*

1. *Epacromia dorsalis* (Acrididæ, Orthoptera).
2. *Heteropternis sp.* ( Do. Do.)

*Standing crops generally.*

|     |                                |                        |              |
|-----|--------------------------------|------------------------|--------------|
| 1.  | <i>Aloa lactinea</i>           | (Arctidæ,              | Lepidoptera) |
| 2.  | <i>Spilosoma sp.</i>           | (Arctiidæ,             | Do. )        |
| 3.  | <i>Spaliria minor</i>          | (Lasiocampidæ,         | Do. )        |
| 4.  | <i>Heliothis armigera</i>      | Do.                    | Do. )        |
| 5.  | <i>Agrotis segetum</i>         | (Noctuidæ,             | Do. )        |
| 6.  | <i>Agrotis suffusa.</i>        | (Do.                   | Do. )        |
| 7.  | <i>Acridium peregrinum</i>     | (Acrididæ Orthoptera). |              |
| 8.  | <i>Acridium succintum</i>      | ( Do.                  | Do. )        |
| 9.  | <i>Acridium melanocorne</i>    | ( Do.                  | Do. )        |
| 10. | <i>Acridium æruginosum</i>     | ( Do.                  | Do. )        |
| 11. | <i>Caloptenus erubescens</i>   | ( Do.                  | Do. )        |
| 12. | <i>Caloptenus caliginosus</i>  | ( Do.                  | Do. )        |
| 13. | <i>Cyrtacanthacris ranaea</i>  | ( Do.                  | Do. )        |
| 14. | <i>Oxya turcifera</i>          | ( Do.                  | Do. )        |
| 15. | <i>Oxya velox</i>              | ( Do.                  | Do. )        |
| 16. | <i>Pachytylus cinerascens</i>  | ( Do.                  | Do. )        |
| 17. | <i>Crotogonus sp.</i>          |                        |              |
| 18. | <i>Pœcilocera picta</i>        | ( Do.                  | Do. )        |
| 19. | <i>Hieroglyphus furcifer</i>   |                        |              |
| 20. | <i>Tryxalis turrita</i>        | ( Do.                  | Do. )        |
| 21. | <i>Atractomorpha crenulata</i> | ( Do.                  | Do. )        |
| 22. | <i>Mecopoda sp</i>             | ( Do.                  | Do. )        |
| 23. | <i>Euprocne mis bramina</i>    | ( Do.                  | Do. )        |

## CHAPTER CXXXI.

## ZYMOTIC DISEASES AND REMEDIES FOR THEM.

WHEN an agricultural crop or herd of animals dies out in abundance without any apparent cause the loss may be supposed to be due to some microscopic organism. Potato-rot, wheat-rust, cattle-plague, animals dying suddenly after a swelling in the neck are examples of loss due to micro-organisms. When one notices any crops or animals dying from some mysterious cause, one should take some fluid out of a recently dead plant or animal from an organ that appears to have undergone special decay. If the diseased organ or tissue is too dry to yield any fluid, it should be macerated with a little clean water and the fluid thus made taken on to a glass slide. The fluid should be spread out thin on a cover-glass and mounted in the usual way. The specimens may then be examined leisurely for identification of the epidemic. For certain epidemics protective inoculation has been found beneficial in other countries, as for instance, (1) for anthrax, (2) for fowl-cholera (3) for *charbon symptomatique* (called also quarter-ill, black quarter, braxy of sheep and gloss-anthrax—the disease of horses and cattle called *Galá phúla*), and (4) rabies. Protective

inoculation for animals can be carried on in this country also if the plagues are identified.

For another class of zymotic diseases another form of remedy has been applied with success. The method of combating these diseases consists in the destruction of the organisms producing the disease. No exact information is in all cases available as to the origin and growth of these parasites; in other words, we cannot trace in every case of epidemic the origin of the germs associated with it at their first occurrence and how they are afterwards conveyed into the bodies of animals and plants through the vehicles of wind, water, leaves, grasses, mosquitoes, flies, etc. That every case of decaying fruits, flowers, leaves, and specially animal matter and excreta is associated with numerous microscopic organisms, can be easily seen under the microscope. That germs occurring in putrefying matter are in some cases productive of disease has been also established without doubt. We can see for ourselves that if we allow vegetable matters, excreta, dead animals, etc., to rot in considerable quantities near human habitations, fatal diseases break out among men. It has also been proved that most, if not all, epidemics are associated with certain microbes. The connection between epidemics among animals and plants and the putrefaction of vegetable and animal substances is in fact very close. It is not certain, however, in every case of epidemic where exactly the germs originated and became converted into pathogenic germs. The main principle on which the prevention of epidemics, both among plants and animals, is based, consists in the removal of organic matter attacked by the germs from the neighbourhood of the plants or animals.

Some general rules for prevention of epidemics are given below : -

(a) As soon as a contagious disease is noticed, cleaning of jungles, re-excavation of tanks, cleaning of sewers and disturbance of putrid matter generally, should be stopped. One should be always careful about cleaning sewers, jungles, tanks, etc., beforehand. But when a disease takes an epidemic character, the attempt to remove nuisance often causes the spread of the disease all the faster. When an epidemic has broken out, it should be considered that the germs have become mixed up with the water that is drunk, and the disturbance of filth at this stage is likely to cause a greater admixture of such germs with water. Instead of disturbing these possible sources of infection it is best to treat them with germicidal substances, such as permanganate of potash or Condy's fluid.

(b) If in a herd of cattle one is found attacked with a zymotic or infectious disease, the affected animal should *not* be removed elsewhere, but only the healthy animals. It is a great mistake to suppose that there is any safety in removing the diseased animal to a place which is untainted with the germs of the disease, though unfortunately this is the *method of segregation* usually followed in this country.



(c) When removing the healthy animals, their bodies should be washed with a  $\frac{1}{4}\%$  solution of sulphate of copper and they should be made to swallow a little of ferrous sulphate with ginger and treacle ( $\frac{1}{2}$  ounce of the sulphate being given to an ox).

(d) When an epidemic breaks out in potato, wheat or any other agricultural crop, the crop should not be removed after harvest, but some arrangement should be made to store it in the field in which the plants have grown.

(e) Seeds of all kinds should be pickled before sowing. For delicate seeds steeping in camphor water is recommended for two hours, and for ordinary agricultural seeds, such as wheat, paddy, sorghum, potatoes, the sulphate of copper dip is the best. Immediately after the dip, the seed should be got dry with lime and ashes which have also germicidal properties, and then sown. There is very little chance of a crop suffering from a fungoid disease which can be caused by the seed if the latter has been pickled in this way before sowing, and the sowing is done in a field in or near which this particular disease has not been noticed for about two years.

(f) Animals and plants enjoy some amount of immunity from epidemics if they are kept in a vigorous condition. For vegetables, water and manure, and for animals, oil-cakes, pulses, wheat-bran, salt, fenugreek and sugar are invigorating and stimulating foods. A vigorous constitution is, generally speaking, unsuitable for the growth of parasites. It has been noticed that even wheat-rust, which is favoured by a damp, *i.e.*, un-aerified condition of the soil, is corrected after a good shower of rain where the crop had showed not only rust but also need for water.

A list of germicides, including the proportion which usually suffices to kill the germs or prevent their growth, is given below. The same proportion is not applicable in the case of every germ, and it is safest to use a stronger solution in every case. Some of these have been experimented with only in the case of cholera bacillus. Others have not been experimented with on any pathogenic germ, but only on the ferment of sugar-water or of wine (*Bacillus aceti*) or some such harmless germs. So the following table will only give a rough idea as to the proportion in which different germicides should be used.

Sugar has the effect of preventing the growth of *Bacillus anthracis*. The use of sugar or molasses should therefore be freely resorted to in the treatment of anthrax and in feeding of animals when this epidemic is raging. Salt also has germicidal properties and the use of salt which is in vogue in Bengal in the treatment of anthrax (*gobasanta*) is to be considered quite rational.

|   |    |    |    |              |
|---|----|----|----|--------------|
| Iodide of mercury                           | .. | .. | .. | 1 to 200,000 |
| Bichloride of mercury (corrosive sublimate) | .. | .. | .. | 1 to 100,000 |
| Nitrate of Silver                           | .. | .. | .. | 1 to 50,000  |
| Hydrogen peroxide                           | .. | .. | .. | 1 to 8,000   |
| Iodine                                      | .. | .. | .. | 1 to 6,000   |

[Koch has ascertained that 1 to 100 of iodine is required to kill the germs of cholera.]

|                                |      |       |
|--------------------------------|------|-------|
| Sulphate of Quinine .. .. .    | 1 to | 5,000 |
| Iodoform .. .. .               | 1 to | 5,000 |
| Naphthalene .. .. .            | 1 to | 4,000 |
| Sulphate of copper .. .. .     | 1 to | 2,500 |
| Mustard oil (English) .. .. .  | 1 to | 2,000 |
| Salicylic acid .. .. .         | 1 to | 2,000 |
| Cinnamon oil .. .. .           | 1 to | 2,000 |
| Permanganate of potash .. .. . | 1 to | 1,000 |
| Eucalyptus oil .. .. .         | 1 to | 600   |
| Hydrochloric acid .. .. .      | 1 to | 500   |
| Borax .. .. .                  | 1 to | 350   |
| Camphor .. .. .                | 1 to | 300   |
| Arsenic .. .. .                | 1 to | 250   |
| Chloride of zinc .. .. .       | 1 to | 250   |
| Lactic acid .. .. .            | 1 to | 125   |
| Carbonate of sodium .. .. .    | 1 to | 100   |
| Alcohol .. .. .                | 1 to | 10    |

## CHAPTER CXXXII.

### AGRICULTURAL BACTERIOLOGY.

PROFESSOR HANKIN, of the Agra Bacteriological Laboratory, reported a few years ago that the water of the Ganges and the Jumna contained nearly a thousand microbes to the cubic centimetre, that is, in about a quarter of a teaspoonful. In European bacteriological laboratories they usually find one to two hundred thousand microbes per cubic centimeter of water. Even ordinary good drinking water usually contains about one hundred microbes to the cubic centimetre. As is the water, so is the air and the earth teeming with microbes. Generally speaking, they are harmless; but occasionally the air, or the water, or milk, or even the earth, teems with germs which are capable of producing epidemics. A cubic yard of country air contains from fifty to three hundred and fifty germs, while a cubic yard of city air contains over two thousand germs, and the air inside a house contains over five thousand germs per cubic yard, specially where there is carpet or mat used in the rooms. An ounce of street dust may contain over thirty million living germs. The superficial layers of soil also teem with bacteria. There may be hundreds of thousands in a single grain of superficial soil, but at a depth of ten to twenty feet there are no microbes. On the top of high mountains and in mid-ocean the air is free from microbes, and spring water is also nearly free. During the changes called respectively fermentation and putrefaction microbes multiply enormously, and in this sense, these processes may be called the usual source of microbes. When juices of fruits are fermented for making wine, when cooked or uncooked meat or vegetables get spoilt, when milk gets sour, when curd of milk is ready for churning, when cheese is getting ripe, special microbes multiply enormously. These are either useful

or harmless microbes. During the processes of disease, which may, in many senses, be classed as fermentation, there is, however, a similar multiplication of disease organisms which are afterwards disseminated.

**Enzymes.**—All the effects which microbes are able to produce are not, however, the results of their direct action. During their growth, and in fact, during life of any kind, there are a group of soluble ferments produced which carry on part of the work of the microbes or other living organisms long after the life is destroyed. For instance, they are able to render soluble many foods which would otherwise be too insoluble to be of any use. Absorption of food substances in the alimentary canal of animals takes place after decomposition effected by such soluble or unorganized ferments which are termed enzymes. Enzymes are insoluble in alcohol, but soluble in water, and they must be in solution to be able to do their work of decomposing food substances. In the saliva, for instance, there is an enzyme which dissolves starch converting it into sugar. In seeds also there is an enzyme, called diastase, which is capable of converting starch into sugar. There is another enzyme called pepsin, in the stomachs of higher animals, which has the power of dissolving meat in the presence of an acid. In the intestine there is an enzyme which is able to dissolve meat in the presence of an alkali. Enzymes do not diminish or increase in amount (like microbes) in doing their work. They do their work best in the presence of moisture at a temperature of about 98°F. Heating to the boiling point destroys their power. In these two respects they resemble microbes, but must nevertheless be carefully distinguished from the latter.

**Microbes** or ordinary ferments are living organisms which are capable of growing and multiplying. They also cause fermentation. With a high power microscope they can be actually seen. Enzymes themselves are often the product of microbes.

**Fermentation.** Fermentations are of many kinds, of which the following are examples :—(I) Fermentation proper, *e.g.* (a) Vinous or saccharine fermentation caused by the yeast fungus and certain moulds resulting in the production of alcohol; (b) Acetic fermentation caused by a microbe known as *Mycoderma aceti* acting on alcoholic solutions; (c) Lactic fermentation caused by another microbe known as *Bacillus lactis* acting on the sugar of milk; (d) Butyric fermentation caused by still another microbe known as the *Bacterium butyricum* acting on lactic acid. (II) Putrefaction or growth of saprophytic germs on dead waste plants or animals. This is usually accompanied by the production of mal-odorous gases containing sulphur, phosphorus, etc. and also of highly poisonous substances known as ptomaines. (III) Pathogenic fermentation is caused by disease-producing germs living in the tissues of plants and animals. During their life they produce toxins or poisonous substances which are highly deleterious to the life of the plant or the animal. It is not by

the blocking up of capillaries caused by an abundant growth of *Bacillus anthracis*, but by the production of a poisonous substance by the bacilli, that an animal dies so suddenly when it is attacked by anthrax. (IV) Fermentation caused by unorganized ferments which must be distinguished from the above three classes of true fermentation caused by microbes.

*Anti-toxin treatment.*—The fever which accompanies most diseases due to pathogenic microbes is the result of a fermentation (caused by a toxin or poison secreted by the microbes of the disease). In defending itself against this poison the animal is often able to prepare a body specially capable of neutralizing this toxin, hence called an *anti-toxin*, and if it can be prepared, a specific against the disease. In two diseases, *viz.*, diphtheria and glanders, the '*anti-toxin treatment*' has proved most valuable. Dr. Roux's Diphtheria Serum is prepared by first cultivating the microbe of diphtheria in meat broth for some weeks. The liquid portion is then filtered off from the bacilli and the clear liquid is injected under the skin of a horse. Minute doses are used at first and cause the production of a certain amount of anti-toxin in the blood, and so the animal is able to stand larger doses of the virus or toxin of diphtheria. By gradually increasing the dose of toxin the amount of anti-toxin present in the blood becomes larger and larger and can be increased to almost any extent. The blood serum of a horse thus containing large amounts of anti-toxin is now regularly and successfully used as a remedy for diphtheria in Europe. The substance called *mallein*, which is used for diagnosing and sometimes also for curing glanders, is a fluid similarly prepared. Glanders is communicable not only from horse to horse but also to human beings, dogs, goats, donkeys and mules. It is a disease caused by a bacillus (*Bacillus mallei*), which appears in the form of an obstinate running cold, or in which the skin of the face and neck of the horse is affected by streaky sores (*farcy*.) The bacillus can be collected from inside these sores and cultivated in broth at the temperature of 98°F. for 30 days. The culture is afterwards sterilized at the boiling temperature for one hour. Then the dead bacilli are separated out from the liquid portion and the liquid portion (which is called *mallein*) is used for diagnosing the disease in suspicious cases (when an injection causes temporary fever). Once cured, even a strong dose of *mallein* does not cause fever in the animal, into which the fluid is injected. For diagnostic purposes the use of another toxin is also of some interest to agriculturists. Professor Koch discovered that tuberculin, *i.e.*, the serum separated out in a somewhat similar manner from a culture of *Bacillus tuberculosis*, when injected in small doses into cattle afflicted with tuberculosis, produces fever, while a similar dose injected into an animal which is not so suffering, produces no reaction. This is thus a good means of detecting tuberculosis in cattle, and is now in regular use.

Microbes are usually classified simply according to the appearance and form of the organism, as seen under the microscope. The simplest form of the microbe is the coccus or spherical form, and those which retain this form to the last are known as *Micrococci*. Micrococci, however, become slightly elongated and then dumb-bell shaped and then divide themselves each into two. But the general appearance of a cluster of micrococci is that of minute little spheres. If the general appearance of a cluster of microscopic fungi indicates elongation, *i. e.* if most of the microbes in the cluster instead of being spherical are spindle-shaped, or like short rods, in appearance, then they are called *Bacteria*. If the general appearance of a group of microbes is that of bits of thread or cylindrical rods of different lengths, these are classed as *Bacilli*. These may be straight, bent or curved, fine or fairly plump, of the same thickness throughout, or beaded, or knot-like in appearance. When the bacilli are serpentine (*i. e.*, made up of small S's), they are to be recognized as *Vibrios*; and when they are cork-screw shaped they are called either *Spirilla* or *Spirochæta*. The common bacillus of cholera is to be classed as a spirillum, generally representing part of one turn only.

Besides these simple forms, *viz.*, micrococcus, bacterium, and bacillus (with its variations of vibrio, spirillum, and spirochæta), there are complex forms under each group. Where the micrococci usually occur in pairs, they are called diplococci. The microbe of fowl-cholera (*gutr*) is a diplococcus. When micrococci occur in chains they are called *streptococci*. When they occur in groups of four, they are called tetrads or tetra-cocci. Where they occur in the form of cubes or square clusters, they are called *sarcinæ*. Where they occur in irregular masses, they are called *staphylococci*; and where they occur in large uninterrupted masses in the form of slime or scum, these masses are called zoogloæ. Bacteria also occur singly or in pairs. *Bacterium termo*, the ordinary germ of putrefaction, usually occurs as a double spindle provided with hair-like appendages termed flagellæ.

The unit of measurement of bacteria is  $\frac{1}{1000}$ th of a millimeter, which is equal to  $\frac{1}{25000}$ th of an inch, and this length is represented by the letter  $\mu$ . The length of bacteria usually varies from 2 to  $10\mu$ , and the breadth from  $\frac{1}{10}\mu$  to  $2\mu$ . The *Bacillus anthracis* rods are about  $1\mu$  in diameter. Yeast cells are about  $10\mu$  in length. With the help of micrometers, measuring of bacteria is done at the same time as microscopic observation. The dimensions of a microbe may be also judged by comparison with those of certain microbes, whose dimensions are known to the observer.

*Reproduction.*—Yeast cells multiply by budding, whereas microbes proper multiply by fission, and for this reason the groups of microbes, *viz.*, micrococci, bacteria and bacilli, are generally termed Schizomycetes. Besides reproduction by gemmation or budding, which takes place in the case of yeast, and reproduction by fission, which takes place in the case of Schizomycetes, there

is another method of reproduction, *viz.*, by the formation of spores in the interior of the organisms. Yeast fungi usually have four spores formed in each. Bacilli and spirilla often have several spores in each. Micrococci do not form spores. Some bacilli, *e.g.*, anthrax bacilli, require free access of air and a temperature of between 70° F. to 105° F. for free formation of spores.

Some germs, *e.g.*, the germs of putrefaction, are not parasitic on living animals or plant. They flourish best at the temperature of 75° to 85° F., while parasitic microbes generally grow best with a temperature of 98° to 104° F., *i.e.*, the temperature of the animal body. Most microbes stop growing below a temperature of 48° F., and a few are destroyed by freezing, though the majority of microbes only remain quiescent at low temperatures and do not actually lose their vitality. Under repeated thawings and freezings they succumb more quickly. But spores of anthrax survive even this treatment.

Microbes can stand dry heat better than moist heat, and if it is intended to destroy microbes by the use of hot water, or by heating milk or other liquids which are likely to contain microbes, it is necessary to bring up the temperature to 150° F. Some microbes which live in the soil can resist the temperature of even 165° F., and others must be subjected to a heat of 250° F., for ten minutes before they are killed. In the ordinary boiling temperature of water it requires six hours to kill some of the spores of putrefactive germs. Exposures to heat, not sufficient to kill disease-producing germs, may, however, attenuate their virulence. This fact is of great economic importance, as it is possible that the heat of the sun makes most of the germs which would otherwise produce epidemics more or less harmless. The action of sunlight, independent of any heating action, specially in the presence of air, in destroying microbes, is also recognized, but light is only effective in presence of air. The ray of the sun that have most effect in destroying microbes are the ultra-violet rays, while the red rays and those nearest to them have little or no effect. Electric light has hardly any potency in this matter of destroying microbes. Sunshine, which is not sufficiently great to kill a microbe, is yet able to reduce its virulence.

Besides heat, air, and sunlight, there are other potent agents for killing or restraining the growth of microbes. Agents which actually kill microbes are called *germicides*, *e.g.*, corrosive sublimate, quicklime, iron and copper sulphates, chlorine gas and carbolic acid. Agents which only restrain the development of microbes without killing them are called *antiseptics*, *e.g.*, salt, sugar, oil, and small quantities of sulphate of iron, etc. Germicidal substances used in a very dilute form act like antiseptics. *Disinfectants* is the common name given to germicides and antiseptics. Spores resist the power of disinfectants longer than vegetative forms. Products of germs (toxins, etc.) are generally antagonistic to the growth of germs.

*Decay of food substances* may be prevented in various ways, and this is one of the most important applications of bacteriology in the field of agriculture and its allied arts:—

(1) *By desiccation.* This deprives substances of moisture which is necessary for the growth of microbes. Desiccation actually kills some microbes, e.g., the cholera microbe. Milk, meat and fruits may be rapidly desiccated and preserved in air-tight tins. The desiccation of fruits and vegetables is done by many methods, but probably the “Gnom” Evaporators (Waas patent), which are sold at various prices ranging from 30 shillings to £30 by Messrs. L. Lumley & Co., of America Square, Minories, London, E. C., are the best for India. They consist of a series of trays placed one above another in a vertical frame. Underneath is a hot air stove from which a current of hot air, of a temperature of 120° to 180° F., passes up through the series of trays. The process of drying commences at the lowest of the series of trays where the heat is the greatest. By a lever arrangement, the whole series of trays may be lifted up admitting a tray at the bottom. Successive trays are thus added at the bottom and the upper trays removed. Before the fruits or vegetables are put in, they are peeled, cored, or sliced, as necessary. Carrots and beans, for instance, are sliced, and most fruits are peeled, and vegetables, as a rule, sliced and steamed for a few minutes before they are desiccated. One hundred pounds of fruits or vegetables are reduced to 10 to 30 lbs., according to the variety treated.

(2) *By freezing* which must be continuous, as freezing does not kill the microbes, but only suspends their action so long as the freezing lasts. Meat, fruits, etc., can be transported from one country to another in freezing chambers.

(3) *By addition of harmless antiseptics*, such as sugar, oil salt, smoke, etc. Smoked and salted fish, bacon, preserved fruits jams and jellies, are examples of this. The preservation of lime-juice with powdered charcoal is another example under this head. The addition of 64 grains of borax to every quarter of milk can be practised without harm, but it prevents curdling only for about 24 hours.

(4) *Addition of minute quantities of strong germicides*, which being poisonous and injurious to human health, should not be encouraged. The use of alum for purifying and preserving drinking water, of bicarbonate of soda for preserving milk, etc., are examples of this.

(5) *Use of vinegar and spirits of wine* for pickling and preserving medicinal substances may be mentioned in this connection.

(6) *Curries, etc.*, are now largely preserved in tins in the cooked condition always ready for use. After the cooking has been done, the article to be tinned is put in the tins which have been already washed with boiling water or steam and fumed with sulphur fumes. The tins with their contents are heated twice more (the soldered tins, being put in boiling water each time) at

intervals of 12 hours before they are finally stored. The first cooking causes those microbes already in the vegetative condition to be destroyed. Those present in the form of spores germinate afterwards, and get killed at the second heating.

(7) *Sterilizing of milk* is an adaptation of the same principle. As milk is altered in character by boiling, and as even boiling temperature continued for an hour or two may not kill all germs, it is very difficult to preserve milk in an unthickened condition. The method employed by Tyndall is tedious. It consists in heating the milk on eight consecutive days, for two hours each day, at a temperature of 65°C., and keeping the milk in the intervening periods at the temperature most suitable for the growth of bacteria, viz., the temperature of 40°C. The value of the milk is not affected by this treatment and it continues to remain fresh.

(8) The *condensed milk* prepared by sterilizing in vacuum pans without the addition of sugar has proved the best substitute for fresh milk. The gravity of this thickened milk at 15°C. is 1.1, and its composition is:—Water, 66.2 per cent.; fat, 8.4 per cent.; nitrogenous matter, 10.9 per cent.; milk-sugar 12.3 per cent.; ash 2.2 per cent., while that of ordinary fresh milk the composition is—

|                            |       |
|----------------------------|-------|
| Water .. .. .              | 87.5  |
| Fat .. .. .                | 3.6   |
| Nitrogenous matter .. .. . | 3.3   |
| Milk-sugar .. .. .         | 4.9   |
| Ash .. .. .                | .7    |
|                            | 100.0 |

The keeping quality of the sterilized condensed milk is proved by storing it in a temperature of nearly 40°C. for a few weeks, after which, if the top or the bottom of the vessel distends, it is inferred that gases due to putrefaction have generated inside the vessel, and any vessel showing such distention is rejected.

(9) *Pasteurized milk*.—By pasteurizing is meant destroying *vegetative microbes* by continuous heating for a quarter of an hour at a temperature of 75°C., and then rapidly cooling. This operation makes milk practically safe for use, as the microbes of tuberculosis, typhus and cholera have no persistent spores capable of resisting great heat, and the milk keeps longer, say for 24 hours, after it has been pasteurized. Pasteurized milk is only temporarily sterilized milk. The safest thing to use, however, is perfectly sterilized milk or sterilized condensed milk.

## CHAPTER CXXXIII.

### DAIRY BACTERIOLOGY.

HAVING given a general notion regarding the utility of a knowledge of bacteriology, we will now go on with the consideration of certain special microbes with which agriculturists are



concerned. Ordinary fresh milk may contain as many as fifty million microbes per pint without looking or tasting any the worse for it. But if the cows and the cowhouse are kept scrupulously clean and if the person milking washes his hands and the pail properly, there are much fewer microbes. The milk as it leaves the udder is almost free from microbes in a healthy cow.

The *Bacillus lactis* converts milk-sugar into lactic acid. As this ferment is the agent for curdling milk into *dahi*, and as *dahi*s are apt to get more or less improperly curdled, the conditions required for the most perfect curdling of *dahi* should be understood. The *sánjo*, *i.e.*, the seed or culture, should be made of skim-milk and not rich milk, as it is not desirable to associate the butyric ferments with the lactic. The skim-milk should be taken in the fresh state, heated to about 75°C. to pasteurize it, *i.e.*, to temporarily kill all the germs, and then, after adding a little watery portion of any *dahi*, the pasteurized and inoculated skim-milk should be left in a cool place, *i.e.*, at a temperature of about 16°C. This can be used afterwards as souring agent for making good *dahi* or for souring cream before churning it into butter. We often find *dahi* of a slimy character. This is due to a micrococcus attacking the milk-sugar in large numbers and replacing or resisting the action of the lactic bacilli. This micrococcus multiplying becomes a zooglœa, and the slime is a zooglœa slime. There are other characteristics we notice in *dahi*, the most noticeable of which are coloured patches on the surface of pots of bazaar *dahi*. The blue patches are due to *Bacillus cyanogenus*, the yellow patches to several bacilli, and the blood-red patches to *Micrococcus prodigiosus*. There is a *Sarcina* which produces rose and another which produces brown-red colour, and one of the lactic acid bacteria while coagulating milk like *Bacillus acidi lactis* imparts to it a blood-red colour if light be excluded. These *chromogenic* microbes which are fairly common in milk are not known to produce disease, though the blood-red colouration produces a superstitious horror which induces owners of valuable cows to part with them at once, as they do not know that the cause of the blood-red colouration was not present in the cow at all, but in impurities with which the milk came subsequently in contact. Redness of milk, due to the mixture of blood from inflamed udder, is a different thing altogether, where the redness is visible at the time of milking.

There is not one bacillus only but many, which curdle milk and cause milk-sugar to split up into lactic acid and carbon-dioxide gas. The curdling itself could be caused by any acid, as in the preparation of *chháná* out of boiled milk, and also by certain enzymes, *e.g.*, rennet, and the milk of *sheorá*. As none of these microbes are known to develop spores, they do not require very much heat to kill them. A temperature of 158°F. is sufficient to destroy them all except the *Bacillus lactis* of Hueppe, which produces the most uniform *dahi* not readily liquefying. The method of heating may hence be used for obtaining first class

*dahi* and first class butter, such as are ordinarily obtained by *gowálás* in some of the Bengal districts.

When *dahi* is kept too long, a visible mould develops on the crust. This is the *Oidium lactis*, which is a higher fungus consisting of hyphæ and spores. Sliminess and stringiness of *dahi* are caused by various fungi, many of which have been studied.

*Cheese*.—Besides the lactic ferments there are the cheese or casein ferments which break down the casein of milk. These ferments being mostly spore-forming ferments are difficult to kill in the milk, and these account for the difficulty in sterilizing milk. The commonest of these is the *Tyrothrix tenuis* of Duclaux. It can stand a temperature of 239° to 248° F. Cultivated in milk at a temperature of 98½°F., it is capable of curdling milk, the curd at first formed being redissolved afterwards by the action of the same bacillus. The decompositions effected by this bacillus result in the production of peptone, leucin, tyrosin, ammonia, butyric acid, etc. Other bacteria also play a part in casein fermentation, and probably still others in the ripening of cheese. It has been noticed that cheese does not ripen properly if the milk is pasteurized, or if boiled or sterilized milk is used before the addition of rennet. Such milk loses most of the bacteria, some of which are helpful in the ripening of cheese. But the bacteria helpful in the ripening of cheeses have not been isolated, and no improvement in the ripening of cheese, due to the addition of pure cultures of specific bacteria, has been as yet effected. Besides it is doubtful whether there are any specific bacteria which help in the ripening of cheeses, or whether the lactic and the curd forming bacteria are not principally concerned in the ripening also.

*Butter*.—Though some of the curd-forming bacilli form butyric acid, one of the characteristic constituents of butter, it is not to be supposed that the latter is a product of fermentation. Butter can be made from fresh milk as well as from sour, *i.e.*, fermented milk. Butter made from sour milk or sour cream keeps better and by souring, a larger proportion of butter is obtained. Butyric acid, no doubt, is obtained as a residue from the breaking down of milk-sugar which is effected by various lactic ferments ( $C_6H_{12}O_6 = C_4H_8O_2 + 2CO_2 + H_4$ ). The presence of butyric acid can be detected in all ripened cheeses. As the fat globules of milk come together more readily if the casein of the cream is previously precipitated by fermentation, such fermentation plays a part in most of the ordinary processes of manufacture of butter. If butter is made from cream, milk should be used in as fresh a state as possible, and if no centrifugal separator is employed, the milk should set in shallow pans, fermentation being prevented by rendering the milk as cold as possible by rapidly passing the fresh milk through a refrigerator, that the milk may be set at a temperature of 12 to 15°C. (say, 55°F.). If fermentation sets in, coagulation takes place, which offers

resistance to fat globules rising readily to the surface. After the fat globules have come to the surface, the top portion of the milk is skimmed off. This, containing all the fat globules, is called the cream, and, from this, butter should be made after fermentation or fresh milk can be fermented and butter made from the fermented sour milk or *dahi*. In this climate it is difficult to secure the proper temperature for setting of cream, and it is better therefore to obtain butter from *dahi* or from clotted cream (*shar*) as is the general practice of the country. The latter method is practised in Devonshire also, where the milk is set in deep tinned vessels, or pans of iron or of brass, and after twelve hours' standing without disturbance, a fire is lit and the milk heated till the first steam is seen in bubbles on the surface of the milk, after which the vessels are allowed to stand undisturbed and cool until the milk is quite cool, and then (say after ten or twelve hours) the cream is skimmed off. The cream so obtained is left to ferment before butter is churned out of it, which is usually done by flapping it with the hand in a tub for about ten minutes only. This modified plan of making butter out of *shar* may be introduced in this country. Churning should be done early in the morning. But if the temperature at this time be below 64°F., sprinkling of warm water, while churning *dahi* or *shar*, helps to bring the fat globules together faster. All the fermentation and other processes applied in the manufacture of butter help only to bring the fat globules already existing in the milk together in 'as pure a state as possible, divested of all sugar and casein. If the quantity and the keeping quality are of no consideration, the sweetest butter can be obtained out of the freshest milk, by separating the cream out of it and churning the cream in the fresh state. The milk also can be churned directly to yield some butter, though a less quantity still is obtained by this means.

## CHAPTER CXXXIV.

### SOIL BACTERIOLOGY.

It has been known that land left without crop increases in fertility in spite of loss of soluble matter by drainage. It has been further observed that poor soils which yield very poor returns of cereals, turnips, and beet are yet capable of yielding good returns of leguminous crops; and further, that land which has become deteriorated by heavy cropping is recuperated by growing clover, *araha*, or some other leguminous crop on it. This recuperation of exhausted land is due to the presence of a large number of microbes. The power of microbes, and, in a few cases of fungi to make use of the free nitrogen of the air has been demonstrated by various observers, notably by Hellriegel and

Wilfarth, in Germany. The multiplication of the microbes in the root-nodules of leguminous plants has been chiefly studied. It is now also known that microbes of root-nodules are not the only ones capable of utilizing and fixing the nitrogen of the air, and probably bacteria have a wide influence in feeding plants with nitrogen. Some nitrogen is, in fact, accumulated in the soil by very many microbes and fungi, whether they live on roots or not. Berthelot's experiments went to show that 75 to 100 lbs. and in some cases over 900 lbs. of nitrogen per acre was accumulated by bacteria, independently of any leguminous plant, and that humus rather hindered than helped accumulation of nitrogen from this source. Fixation of nitrogen in the soil goes on by day and by night, but more actively in daytime, and at high temperatures (50 to 104° F.). Free access of air, and moisture from 12 to 15 per cent. in the soil, are also helpful. Though nitrogen fixing bacteria accumulate largely in the roots of leguminous plants, soils in which leguminous crops have recently grown are not those in which such fixation is most active. Thus there is a limit to the accumulation of nitrogen by the growth of leguminous crops, and it is not possible to go on increasing the fertility of soils by taking one leguminous crop after another. Rotation therefore is necessary, if the organism which bring about the desired fixation of nitrogen from the atmosphere is to be utilized to the best advantage.

Though the uppermost layers of soils teem with microbes there are scarcely any microbes below a depth of three feet from the surface. Among those found in the surface layer there are none more valuable from an agricultural point of view than the group which convert the complex organic matter added as manure into the nitrates required for the nutrition of the plants. The process by which this is carried out is called nitrification. Nitrification goes on more freely at the surface, and so when these organisms are used specially for making nitrates, the beds are made only with the superficial layers of soil and not with soil dug out from a deep pit. It is not certain if the nitrification, which results in the formation of saltpetre, is the result chiefly of the action of one microbe or the joint result of that of several microbes, though the latter is the most probable, especially since the complete and convincing investigations of Winogradsky were made. One of the principal microbes in the earlier part of the process, which has a wide influence in decomposing decayed vegetable matter by destroying the cellulose of vegetable cells, is the *Bacillus amylobacter* discovered by Van Tieghem. It is a drum-stick shaped anaerobic microbe, and has been stated to be active in the retting of jute. Possibly the nutrition of ruminant animals, which are able to digest a large proportion of cellulose, is also partly due to this microbe. It seems also to be one of the active agents in the production of butyric acid in cheese, hay, silage, etc. The commonest microbe of putrefying vegetable matter, and hence

one of the most important agents in changing the organic matter in the soil, is the *Bacterium Termo*. It can be always obtained by rotting some pulse in water; while rotting hay shows *Bacillus subtilis* more abundantly. *Bacillus subtilis*, *Bacterium termo*, *Bacterium amylobacter* and *Micrococcus ureæ* are the commonest of all microbes and are present everywhere, and are all very important in the changes occurring in the soil.

These microbes, however, are only the agents commencing the conversion of organic matter into the nitrates required by plants. Their activity is followed by that of others, which ultimately bring all the nitrogen of the materials in to the form of salts of ammonia. These salts of ammonia are then acted upon by a special nitrifying organism, which produces nitrites of potash or lime. These latter are finally converted by still another microbe into the nitrates required for plant-food.

After the discovery of the organisms in the roots of leguminous plants causing the fixation of nitrogen it was imagined that the addition of a culture of these microbes would increase the crop of such leguminous crops on any soil; a material called "nitragin" was, in fact, put on the market. It consisted of a jelly, on which there has been sown minute organisms derived from the nodules found in the roots of leguminous plants, such as *arahaar*, *dhaincha*, *sunu*, ground-nut, etc., and was sold in little bottles containing an ounce or two of jelly, on the surface of which a white mould-looking substance has been grown. It was claimed by the manufacturers that this small speck of white fungus, if mixed with about half a gallon of water, and the water sprinkled carefully over about a hundredweight of earth, and thoroughly mixed with it, was capable of inoculating half an acre of land when spread over it as a top-dressing, and that land so inoculated would in most cases produce a much larger crop of clover, peas, beans, or other leguminous plants, than uninoculated land.

The root-nodules of leguminous plants were first discovered by the famous anatomist, Malpighi, about the year 1660. For two centuries no further notice was taken of them until a Russian botanist, Woronin, made a careful microscopic study of them. He described the root-nodules in 1866, and noticed that at a certain stage of their development, they were filled with a slimy matter containing myriads of tiny little bright corpuscles capable of motion and resembling bacteria, and he thought they were allied to the slime fungi which caused the finger and toe in turnips. De Vries, in 1877, discovered that they were absorbers of nitrogen, as he found they were full of albumen during the whole life of the plant until about the time of the ripening of the seed in the host plant, in which is stored the albumen for the use of the future generation.

Following on this, Beyerinck then discovered that the growth of the nodules was due to a real Bacterium, and he grew it in a nutrient medium outside the plant, taking his seed from a variety

of leguminous plants. He gave the Bacterium the name of *Bacillus radicumicola*.

Hellriegel first discovered that the nodules enabled leguminous plants to make use of the free nitrogen of the air by converting it into living organic proteid matter in their bodies. Experiments made in almost all parts of Europe confirmed this point one for all.

The manufacture of nitragin, of which I have already spoken, was the result of the experiments conducted by Nobbe at Tharand, in Germany, in growing pure cultures of *Bacillus radicumicola* in gelatine, to which was added, when liquefied, a decoction of the plant on which the organism under investigation is accustomed to feed. Nobbe found that the best results in the way of inoculation were attained when the micro-organisms were got from a soil growing plants of the same kind as those he was experimenting with, so that, in order to give vigour to a clover crop, the soil should be inoculated with micro-organisms obtained by cultivation from the nodules of the clover plant, and so on. Thus the *Bacillus radicumicola* of Beyerinck, though it was recognized by Nobbe as the one original organism present in all soils, is powerfully affected in its nature by the nature of the leguminous plant it grows on. Accordingly, in preparing material for inoculation, cultures made from the nodules of the various species of leguminous plants are kept distinct, so that they may be used for application to crops of the same species only. As an actual practical process, the method of soil inoculation by Nobbe's method has proved a failure. Except in the case of a few sandy or moorland soils which have not previously borne a leguminous crop there has been little benefit from using the inoculating material. It was thought in 1904 that the reason for this had been found by Moore, in Washington, who stated that the cause of failure was the weakening of the microbes through culture in such artificial media as had been employed. He prepared his culture in media containing no organic matter and only a trace of nitrogen, but so far the cultures he has sent out have been as great a failure in India as the former ones. We are by no means near an understanding of the question even yet.

Such beneficial or useful bacteria as have been described are by no means the only organisms present in the soil. And recent investigation by Russell and others indicate not only that there are many undesirable bacteria also present—but also that there exist other larger organisms, chiefly protozoa, which actually destroy large numbers of the beneficial bacteria which may be present. This explains the improvement in a soil which results from partial sterilisation, whether by heat or by antiseptics, as this partial sterilisation destroys the more sensitive protozoa, and allows the useful bacteria thus to develop more freely.

## CHAPTER CXXXV.

### VACCINES AND THEIR PREPARATION.

ONE of the most important results of the study of bacteriology applied to agriculture has been the methods devised for protecting farm animals by vaccination against several of the most virulent of the diseases to which they are subject. The first of these, in which the possibility of such vaccination was proved, was anthrax, or *guti* or *go-basania*, as it is called in Bengal, and the demonstration was due to Pasteur in Paris. Numberless modifications in the method of preparing the vaccine has since taken place, but the idea remains the same throughout.

The principle on which the preparation of these vaccines depends is really that of accustoming the animal to weak non-virulent cultures of the disease microbe, so that when a more virulent form is introduced into the system it is able to resist an infection which would otherwise cause it to succumb. Pathogenic or disease producing organisms, subjected to certain conditions, either diminish or augment in their virulence. The virus of swine plague, for instance, inoculated in pigeons, increases in virulence in each successive generation of its passage through pigeons. If, however, the virus is passed through successive generations in the bodies of rabbits, it becomes gradually attenuated in virulence, and after the tenth generation the virus taken from the rabbit may be used to inoculate pigs to protect them against swine plague.

The actual methods now employed in the preparation of anthrax vaccines are three, the first being used by Chauveau, the second by Arloing, and the third Pasteur's own method. In the first, the virulent virus is taken from a recently dead animal with an ordinary sterilized pipette in the usual manner. This is sown in a sterilized flask on broth, and the culture of the bacilli is allowed to go on in the flask by leaving it for twenty hours in a chamber regulated to a temperature of 42°C. When this period of time has elapsed, the vaccine (still virulent) is sucked into sterilized tubes, sealed at one end and having a cotton-wool plug at the other. The second end is broken off, the tube passed through a flame four or five times with a twisting motion of the wrist, dipped into the flask, and a portion of the vaccine drawn in by sucking through the other end. When a sufficient quantity has been drawn in, the end is again sealed. The cotton-wool end is also sealed beyond the cotton-wool, so as to obtain a sealed glass tube containing virulent vaccine. Several of these tubes are taken at the same time and placed on a rack. This rack is plunged in a vessel containing water kept by a similar automatic arrangement as has been already described at a uniform temperature of 48°C. for three hours. At the expiration of this period of time, the vaccine in the tubes is sufficiently attenuated for application in the usual manner to animals. This is the simplest and the quickest way of preparing an anthrax vaccine.

The second method applied by M. Arloing in preparing anthrax vaccine may be described as follows :—

Virulent *Bacillus anthracis* is obtained from an animal dying of anthrax in the usual way, and cultivated in broth in a sterilized flask. This flask is put inside an iron receiver, which is fitted to a force pump, and oxygen, prepared in the ordinary way and kept in an air-tight India-rubber bag, is forced with this pump into the receiver. When the manometer on the receiver indicates from 2 to  $2\frac{1}{2}$ , i.e., when the pressure inside is 2 to  $2\frac{1}{2}$  atmospheres the screws are turned, and the charged receiver is put inside a chamber kept for 14 to 20 days at a uniform temperature of  $36^{\circ}\text{C}$ . After the expiration of this time the attenuation of the vaccine is complete in the flask. But as only a small quantity is contained in the flask, it is sown in a large sterilized flask containing broth to increase the quantity. The flask is taken out of the oxygen vessel and its contents transferred to the large flask containing a large quantity of broth. When, after a few days, the contents of the larger flask appears quite turbid, the cultivation of the bacilli is finished, and the vaccine can be used for inoculating animals to protect them from anthrax, two drops for sheep and four drops for cattle. This method of attenuation is exactly opposite to that of Pasteur in this respect, that in Pasteur's method spore formation is suppressed, whereas in Arloing's methods spore formation goes on profusely inside the oxygen vessel.

*Pasteur's method of preparing anthrax vaccine* consists simply of keeping the virulent vaccine for twenty days at a uniform temperature of  $42^{\circ}$  to  $43^{\circ}\text{C}$ . in the preparation of the weaker vaccine used in the first instance; and at the same temperature for twelve days in the preparation of the stronger vaccine used after the first or weaker vaccine has been employed.

To prepare these vaccines by any of the three methods is an extremely delicate process, and demands not only an exceedingly well-equipped laboratory, but also a high bacteriological training. It is therefore useless here to give the method in greater detail than has already been done, for I have already indicated the principles on which the methods depend. Even in the hands of the most skilled workers, and with all the precautions that can be thought of, vaccination may fail in certain cases, and this cannot be accounted for. The processes are so many and the opportunities of making mistakes present themselves so often at each stage that it can be easily understood how difficult it is to explain how some failures occur.

When disease does not exist in a flock, *but only in this case*, it is preferable to vaccinate the dams when they are not pregnant, or only in the first stage of their pregnancy, otherwise abortion may occur. It is necessary to vaccinate lambs as soon as spontaneous disease is feared. Cows fall off in milk when they are vaccinated, and it is good to vaccinate them when they are dry. The milk from cows recently vaccinated must be boiled before it



is drunk. If the malady does not exist during the suckling period it is best to wait until the weaning. Sheep are vaccinated in the inner part of the thigh, the first vaccine on the right thigh, and the second on the left: oxen and horses behind the shoulder sometimes before, lest the collar should press on the place of inoculation. It is well to shave off the hair of the part before inoculating, lest the orifice of the syringe should be blocked up with a hair and prevent inoculation. When a vaccine tube has been uncorked once, it must not be used a second time; what remains over after the first series of operations must be rejected, and not reserved for another place or occasion.

We may now turn from anthrax to a disease which has been often confused with it, known as *gala-phula* in Bengal, and as 'charbon symptomatique' in France.

The characters that distinguish anthrax from 'charbon symptomatique' are—

(1) Anthrax is fatal to almost all animals known. Charbon virus, if inoculated into rabbits, or dogs, does not have any effect. White mice may or may not die of charbon when inoculated with the virus. The animals most susceptible to charbon are cattle. Cows and oxen die more frequently of charbon than of anthrax, from which about half the number recover. Sheep and guinea-pigs are also susceptible animals, that is, invariably die when inoculated with the virus, whether of charbon or of anthrax. The subject has not yet been sufficiently investigated to enable one to say whether man is more subject to one than to the other. Limping before death is an invariable symptom in charbon.

(2) Œdema takes place at the point of inoculation in both anthrax and charbon. When an incision is made of the œdematous part, the appearance which presents itself in the case of anthrax is moist, bright and gelatinous, and light red. In the case of charbon, however, the œdematous part on incision presents a dull dark red, almost black, appearance. The œdematous part in the case of anthrax also is redder than in the natural state; but the difference in colour in the two diseases is most characteristic.

(3) Both charbon and anthrax are virulent for susceptible animals; but charbon is quicker in its effect, death taking place within twenty-four hours; whereas, in the case of anthrax, oftener after thirty-six hours, and usually if the animal lingers for more than a week, recovery takes place. Two guinea-pigs inoculated at the same time by M. Arloing, with the object of demonstrating the difference between the two diseases, were found two days afterwards, one dead and the other (*viz.*, that inoculated with anthrax virus) still alive.

(4) The disease in the one case is caused by a non-motile bacillus, *viz.*, in the case of anthrax, and in the other, *i.e.*, in the case of charbon, by a bacterium, which is a shorter organism, which never forms chains as bacilli do.

(5) The organisms of disease are found in the case of anthrax all over the body, more or less in every tissue, but more particularly in the spleen, the heart, and the liver. In the case of charbon they are found only in the œdematous part, and they are invariably localised.

(6) Swelling of the glands of the neck is invariably present in the case of charbon when it arises spontaneously, and only sometimes in the case of anthrax. So neck swelling must not be regarded as a necessarily peculiar diagnostic symptom in the case of charbon.

(7) A crepitating sound of the œdematous part is always present in the case of charbon, never in the case of anthrax.

(8) Spores are formed in the charbon organism (named by M. Arloing, *Bacterium Chauveau*) in the body of the animal even when it is still alive. In the case of anthrax, the spore formation of *Bacillus anthracis* goes on *only outside* the body of the animal when the bacilli come in contact with the free oxygen of the atmosphere.

(9) *Bacillus anthracis* is a longer but narrower organism than *Bacterium Chauveau*. In artificial culture *Bacillus anthracis* appears as long filaments; whereas, under similar conditions, *Bacterium Chauveau* appears even shorter than in its natural state, the reason being that this bacterium is an anærobic organism, incapable of full development in contact with free oxygen of the air.

(10) *Bacterium Chauveau* is rounded at the ends, *Bacillus anthracis*, straight; *Bacterium Chauveau* in decaying becomes more inflated; but in a dry state, narrower (as in the vaccine).

(11) *Bacterium Chauveau* is never found in chains of three or more, like *Bacillus anthracis*. The usual mode of vegetation is by spore formation, sometimes, however, section takes place, but never in a series of more than two.

(12) An animal dying of anthrax is almost invariably found bleeding from the anus and nostrils. An animal dying of charbon has never this symptom.

The black colour of muscles in charbon is caused by the extravasation of blood into the muscular tissues, caused by the solvent action of the diastase of the *Bacterium Chauveau* dissolving the muscular cells and allowing blood to flow into them. Greater oxygenation goes on, the hæmoglobin of the blood losing more oxygen than in the natural state, and the carbon dioxide gas produced helping the further development of the anærobic bacteria. The light red arterial blood becomes exaggeratedly veinous and dark in consequence of this action.

A vaccine for charbon has been prepared by Arloing, and has proved very effective, and is now in regular use in France.

We may turn now to consider *rabies*, or hydrophobia, in connection with which the highest development of the principle of vaccination has taken place. If the virus of *rabies* be passed

through the bodies of rabbits, it is found that it rapidly augments in virulence. A rabbit inoculated with the virus of rabies from a mad dog dies in eighteen to twenty days. A second rabbit inoculated with the virus taken from the dead rabbit will take less time to die, and so on, until the thirtieth rabbit inoculated with the virus of the twenty-ninth rabbit takes only six days to die. Here, however, the maximum of virulence is reached, the 32nd, 33rd, etc., do not die any quicker than the thirtieth rabbit, but they all take, after the latter, six days to die. At this stage the standard virulent virus used by Pasteur in the preparation of the vaccine is reached, as the strength of the virulence is now constant.

In preparing the vaccine the dead rabbit is dissected, its spinal marrow taken out, and hung inside a glass jar containing potash at the bottom, the jar being placed in a room regulated at a constant temperature of 20°C. The spinal cord thus gets drier and drier, the potash preventing putrefaction, and in drying up it gets more and more attenuated. But even after seven days of desiccation it is capable of killing rabbits. On the 8th day it is harmless for rabbits, and probably much more so for men. But to be more careful, the first vaccination applied to man is made with the spinal cord desiccated for 12 days; the second vaccination with what has been desiccated for 11 days; the third with what has been desiccated for 10 days; the fourth with what has been desiccated for 9 days; the fifth for 8 days; the sixth with what has been desiccated for 7 days (capable of killing rabbits unprotected by previous inoculation with weaker vaccine); the seventh (still stronger) with what has been desiccated for 6 days; the eighth for 5 days; the ninth for 4 days; the tenth and the last vaccination with the vaccine prepared from spinal marrow which has remained only for 3 days in the glass jar. Pasteur stopped here. He never vaccinated men with the vaccine which is quite virulent. But he believed men vaccinated 10 times with the graduated vaccines could be inoculated with perfect safety with the virulent vaccines, that is, those made with two and one days' desiccated spinal marrow, and with undesiccated marrow freshly taken out of the dead rabbit or the dead dog. The desiccated spinal cords are mixed up severally with water in glasses before syringing the vaccines to men. The inoculation is done with a Pravaz syringe, under the abdominal cuticle in the case of the human subject, and into the brain of lower animals for experimental purposes.

It may be that Pasteur's method of inoculation for rabies, both as a curative and also as a protective measure, will be in future adopted not only in human pathology, but in the pathology of our domestic animals also, which are no less subject to rabies than men.

*Pathological explanation uncertain.*—Why this method of treatment for infectious diseases (*i.e.*, those caused by lower organisms) should prove efficacious is difficult to say. But analogy goes to show that it is a most natural method. A person may

accustom himself to taking gradually larger and larger doses of arsenic until he can take such a quantity without serious harm as would certainly kill one not so accustomed. So with alcoholic poison, opium, and perhaps all poisons. It is like a person accustoming himself to lifting heavier and heavier weights, touching hot substances or performing acrobatic feats. There is an almost unlimited degree of tendency in animal organisms to adapt themselves to the circumstances to which they are subjected if they are gradually subjected to them. This tendency is shared alike by the muscles, the nerves, the viscera, and, in fact, by all living portions of the body. But exactly in what way custom is a protection against susceptibility no one can say. It may be that the particular tissues undergo a chemical alteration in this process of accustoming, and the chemically altered tissues are no longer acted upon injuriously by the otherwise poisonous or deleterious conditions. Inoculation for infectious diseases is a kind of accustoming. It is done in the case of rabies at several stages; in the case of charbon at two; in the case of anthrax, according to Pasteur's method, also at two, and according to Chauveau's methods only at one stage. When the tissues come in contact with the vaccines, some chemical alteration probably goes on not sufficient to cause death, but producing œdema or fever, or some slight disease. But the animals getting over this slight disease evidently acquire a new constitution, in which the tissues become invincible to the attack of the virulent virus also.

## CHAPTER CXXXVI.

## THE HIGHER FUNGI.

THE commonest of these fungi, which show distinctive mycelia and spores, are known by the name of moulds. The *green mould* in cheese, bread, etc., is caused by the *Penicillium glaucum*. The *blue mould* is caused by a fungus termed *Aspergillus*, and the *white mould* by another termed a *Mucor*. The *Oidium* of *dahi* spoken of before is also a common fungus.

Instead of giving a systematic classification of the higher fungi, we will get at once to the description of the principal disease-producing fungi which will give some idea of the life-history of these plants. Mushrooms are also included among these higher fungi, and a description of the cultivation of edible mushrooms will follow in the next chapter.

*Potato-rot* (*Phytophthora infestans*).—This disease, well recognized by the peculiar stinking smell of the tubers, as also of the plants affected with it, is caused by a fungus known as *Phytophthora infestans*. Dark patches appear on leaves first, then a white bloom both on upper and under surfaces, but chiefly on the under surface of the leaves; the stems are then attacked, and finally the

tubers. The disease sometimes makes very rapid progress specially in wet weather. Fortunately for us, as the potato-crop grows at the dry season, the potato-rot has never been so serious in the plains of Bengal as it otherwise would have been, but nevertheless it does an enormous amount of damage in Assam, Bengal, the Eastern Himalayas and the Nilgiris where the general conditions are more or less humid. An average temperature of over 77° F. or a temperature lower than 34° F. is unsuitable for its propagation, the temperature most suitable being between 50° to 60° F. The tomato and some other solanaceous plants are also subject to the attack of the fungus, and it is necessary to suspend the cultivation of all these crops for two or three years when the potato-rot appears in any locality.

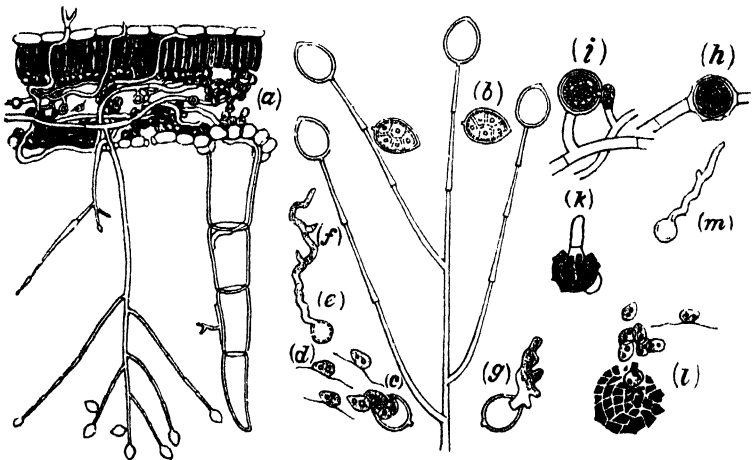

FIG. 116.—PHYTOPHTHORA INFESTANS.

*Explanation of the figure.*—(a) Section through an infected potato-leaf showing greater protrusion of the fungus from the under surface than from the upper surface ( $\times 50$ ); (b) Conidiophore with conidia shown greatly magnified ( $\times 250$ ). (c) and (d) Zoospores coming out of a conidiophore. (e) Germinating zoospore. (f) Promycelium from zoospore. (g) Promycelium growing directly out of a conidiophore. (h) and (j) Oogonia and Antheridia inside the potato-leaf shown enlarged ( $\times 250$ ). (k) Germinating oospore. (l) Zoospores coming out of an oospore. (m) Germinating zoospore.

If a particle of an affected leaf is examined under the microscope, it will be seen that the fungus grows chiefly at the lower part of the leaf, and the growth is downwards from leaf to stem and from stem to tuber. The mycelium or spawn-thread will be found branching out and bursting through the stomata of the lower surface, and wherever one of these threads comes in contact with a leaf-cell the latter gets discoloured and putrefied. Occasionally a thread comes out at the upper surface also (*vide* Fig. 116a). The stomata getting blocked up with mycelia, transpiration is prevented, and ultimately putrefaction results. Conidiophores, *i.e.*,

jointed branches bearing little fruit-like bodies (conidia), appear chiefly at the under surface. The conidia observed under a high power microscope magnifying about 250 diameters will be found to be divided into compartments; and if aconidium is placed on a moist substance, each compartment will be found coming out as a ciliated zoospore and sailing about in the slightest film of moisture. These zoospores after a little time become non-motile and more spherical. After resting a while each zoospore, if properly conditioned, throws out a mycelium, and thus the life of the parasite is repeated.

The conidia also sometimes throw out a pro-mycelium without producing zoospores. The conidia are carried about with the wind, and the zoospores swim over the surface of leaves bedewed with moisture, and the infection spreads in this two-fold way. Insects and birds also act as carriers of infection from field to field. When the mycelia reach the tubers, they decompose the cells and corrode the starch. In bad cases the tubers rot altogether, but in mild cases the mycelium hibernates in the tuber and becomes perennial, and these tubers which contain the disease in an undeveloped form may give rise, when they are used as seed, to potato-rot in the next crop. But perennial mycelium cannot survive an unusual amount of heat, cold or moisture, and disease seed-potatoes, therefore, do not *necessarily* produce a diseased crop.

Besides the non-sexual reproductive functions by means of mycelia and conidia (which usually form zoospores as an intermediate stage before the pro-myceliol growth), *Phytophthora intestans* is reproduced by sexual means also. If a section of the leaf intersected by mycelial growth is closely observed, little thickenings and buds will be observed in the mycelia themselves as apart from conidiophores. These thickenings and buds are called Oogonia and the enclosed cells Oospheres. Smaller buds growing out of the mycelia will be also noticed which are called the Antheridia. The Antheridia are the male cells, and these coming in contact with Oogonia, and the protoplasm of the Antheridia flowing into the Oospheres, fertilisation takes place and Oospores are the result. These fertilised Oospores are also called Resting-spores. They are round and sometimes smooth and sometimes spiny in appearance looked at under a powerful microscope. The Oospores abound in diseased seed-potatoes after they have germinated and spent themselves. The perennial mycelium in the tuber, not being able to produce conidiophores and conidia (which require contact with free atmosphere for their development), develops Oogonia and antheridia as it multiplies. As zoospores give rise to germinal threads, so do oospores when kept uniformly moist and warm. The oospores are of brown colour and thus easily distinguished from zoospores, which are almost colourless. The oospores, having a longer vitality than zoospores, and remaining in old potato fields in decayed tubers and old leaves and haulms

they germinate again next summer, and it is usually by their means and not by means of the perennial mycelia of the seed-tuber, that potato-disease reappears year after year. As the potato-disease spreads from leaf to stem and from stem to tuber, and as it is never observed to take the opposite course of development from the tuber upwards, the source of infection is not so much the seed-tuber as the decayed haulms and tubers of the previous year. It is not necessary for the mycelial growth from the oospore to take place on the leaf of the potato plant itself. The fungus can grow at first on the moist soil and then gradually spread by means of conidia and zoospores to the leaves of the new crop. The source of infection being chiefly the previous year's decayed tubers and haulms whether lying in fields or in manure heaps, and the oospores which possess greater power of resisting climatic conditions than the non-sexual reproductive tissues such as mycelia, conidia and zoospores, germinating in the hill districts in spring at or immediately before the potato sowing season, the treatment indicated is both preventive and curative. Sulphate of copper solution or corrosive sublimate may be sprinkled on the field with the help of a knapsack vaporiser immediately before the potatoes are sown. Then the crop should be carefully watched and if any black patches and white bloom appear at the lower surface of the leaves at any portion of the field, the vaporising should be repeated. One preventive and two curative treatments should be sufficient. But if treatment is not feasible all over a tract affected with potato blight, it is best to give up potato cultivation for three or four years, that the vitality of the resting-spores may die out before potato cultivation is resumed in that tract. This is how the potato-blight, which ruined the crops in the Darjeeling hills about ten years ago, had to be faced. There was entire suspension of potato cultivation for three years all over these hills, but since then the disease has reappeared.

In France, the potato-blight was successfully combated with the help of the *Bouillie bordelaise*, or the Bordeaux mixture which consists of a half per cent. solution of sulphate of copper in hot water to which a quantity of milk of lime is added. This was applied with the help of the knapsack spraying machine called Eclair Vaporiser, both before sowing and two or three times after germination of the seed, during the growth of the crop.

*Rust*.—This is a disease of cereal plants caused by a minute fungus known as *Puccinia*. There are different species of *Puccinia*, the commonest of which attacking wheat is called *Puccinia graminis*. This is different from the *Puccinia* known to attack oats or barley plants. Barley plants growing in the midst of rusted wheat at the Sibpur Farm were found entirely free from rust, but barley is also subject to a rust.

The fungus was first noticed by Fontana, an Italian botanist, of 1767, but its biology was first studied by the great German botanist, De Bary. De Bary discovered that the fungus has three

distinct stages, (1) the uredo or the orange colour stage, (2) the teleuto, or the black colour stage, and (3) the æcidial stage. De Bary also discovered that the æcidial stage of the fungus was passed in a different host plant altogether such as the bramble, the barberry, or the borage, and not in the cereal plant affected. Dr. Prain discovered, at the Sibpur farm, all the three stages of the fungus on a common weed belonging to the order Compositæ locally known as *tikchoná* (*Launea asplenifolia*). The absence of the teleuto-stage in the wheat-rust at Sibpur may, perhaps, be accounted for according to the same authority by its presence in the *tikchoná*. The connection between wheat-rust and the *Puccinia* fungus found on *tikchoná* has not, however, been satisfactorily established as yet, and it may be looked upon in the light of a theory for the present.

Humidity and heat are alone required for germination of uredo and æcidiospores. Teleutospores require a period of repose before they are active. In pickling wheat seed before sowing, one kills only the teleutospores. The other sources of infection are not done away with. So even after sowing pickled wheat seed one may have rust in wheat, the infection coming from the æcidia or cluster cups on some other plants, or uredospores blown along by

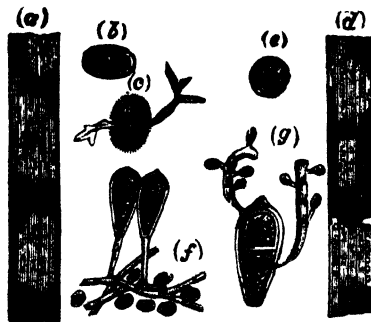

FIG. 117.—PUCCINIA GRAMINIS.

[(a) Large oval sori in clumps on a blade of wheat. (b) One uredospore detached from its clinode or stalk ( $\times 300$ ). (c) A germinating uredospore. (d) Smaller, detached and round sori of *Puccinia graminis* var. *rubigo-vera*. (e) A detached *rubigo-vera* uredospore ( $\times 300$ ). (f) Two teleutospores attached to their clinodes. (g) Promycelial growth from the two sections of a teleutospore, showing also sporidia borne on short stalks.]

the wind from other wheat plants. the æcidial stage, at least in the case of Indian wheat-rust, not being definitely established, only the uredo and teleuto-stages are represented in the annexed figure (Fig. 117).

Linseed, mustard, gram, *khesári*, castor, and beet are also subject to distinctive diseases caused by fungi closely related to *Puccinia*. *Melampsora linii* causes the linseed disease. Another *Melampsora* causes rust in mustard and rape. *Uromyces* fungi cause diseases of the same class in pulses and in beet.



The commonest Indian rust which affects *juár*, *bájrá*, *shámá*, and some wild grasses, is known by the name of *Puccinia penniseti*. The red patches on *juár* and other leaves affected with this fungus are due to uredo pustules. It should be noted, however, that certain races of *juár* are naturally almost immune against this disease. These should alone be selected for seed. Attempts are being made to establish stocks of wheat which would be immune against rust, but so far no definite results have been obtained by the use of the so-called rust-resisting varieties in India.

*Smut* (*Ustilago*).—This is another disease of cereals chiefly affecting the *juár*, but noticed also in paddy, oats, wheat, barley, *bájrá*, maize and *shámá*. It is caused by a minute fungus called *Ustilago segetum* (or *Ustilago zeamays*, the variety which affects the maize). It affects chiefly the grain, while rust affects chiefly the leaves and only indirectly the grain. The loss due to smut is not, however, so great in this country as that caused by rust, except in the case of *juár* and *shámá*. An ear-head here and an ear-head there may be seen affected with smut almost in any cornfield, but wholesale destruction due to smut is not known in the case of wheat, barley, or oats. In June and July are commonly seen smutted grass at Sibpur, and even earlier in the season one plot of *Khari* sugarcane showed a profuse quantity of smut in 1901. It is a disease, however, which comes in connection with seeds, and if one is negligent about the harvesting of grains kept for seed, it is possible to have smut in an epidemic form; while, on the other hand, it is a disease which can be easily prevented in a large measure by pickling the seed. The spores of the fungus germinate after the seed of the cereal, with which they were entangled, has been sown. The germinating spore throws out one or more promycelia from the joints of which are thrown out sporidia or conidia. These throwing out minute germinal tubes penetrate the tissues of the seedling of *juár* or wheat, or whatever the cereal may be, and once inside the tissues of the plant, the fungus grows up along the stem forming hyphæ and finally fructifying in the grains of the cereal affected. This is how all the grains on the ear appear smutted. It is curious, the fungus when it develops inside the stem of the cereal, scarcely affects the growth of the cereal. The sorghum grown at the Sibpur Farm in 1898 was nearly all smutted, and yet it was surprising how vigorously the plants grew. But when the cereal plant reaches the stage of fructification the fungus prevents seeding altogether, and where the ears of grain should be there we see only a mass of black spores. But these sooty spores wafted by the wind affect healthy grains which get these spores entangled on their surface, and sown unpicked the next year, they again give rise to this fungus. In the case of the maize, smut-swellings appear on the stem as well as inside the cob.

*Bunt* (*Tilletia foetens*).—Bunt or stinking smut is also caused by a fungus (*Tilletia foetens*), the life-history of which closely resembles that of the smut-fungus (*vide* Fig. 118). The rice plant

is affected by it, as well as wheat, barley and oats. The grains become abnormally inflated, and they emit a putrid odour. The leaves and stems close to grains are also affected by the black spores. *Dhaner-gû* is the name given to the bunt fungus when it affects grains of paddy. The same fungus affects oats also.

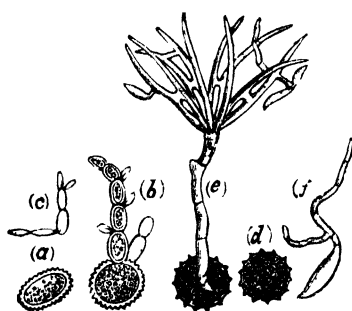

FIG. 118.—SMUT AND BUNT FUNGI.

[(a) Spore of *Ustilago* (smut). (b) Spore of *Ustilago* throwing out promycelium with sporidia. (c) A germinating sporidium of smut. (d) Spore of *Tilletia* (bunt). (e) Spore of *Tilletia* throwing out promycelium with sporidia. (f) A germinating sporidium of bunt.]

Bunt spores adhering to grains not only give rise to bunt in the next crop when the grains so affected are used as seed, but they are far more injurious to health than spores of ordinary odourless smut. Headache, eruptions on the face, indigestion and other forms of human ailment have been traced in some cases to the spores of bunt. When bunt is known to be amongst seed-grain, it should be steeped in some weak germicidal solution before use. Salt, quicklime slaked with boiling water, permanganate of potash, sulphate of copper and sulphate of soda solutions, have been recommended for use. The spores being lighter than water mere steeping of the grain in water is also efficacious, as the excess water afterwards run out usually carries with it all the spores which originally adhered to the grains.

*Sugarcane Disease* (*Trichosphaeria sacchari*).—This sugarcane disease, due to a fungus, broke out a few years ago in the West Indies and Mauritius, and it has appeared recently in the Godavari District of Madras. The disease was first observed in Barbados in 1893, then in Trinidad, and then in British Guiana. In 1896 it was noticed in the District of Mozuffarnagar in the United Provinces, and since that time, it has been found almost everywhere in India where sugarcane is grown.

The diseased canes are first recognized in July or August by dark red and brown marks on the rind in one or two joints towards the middle or base of the canes. Up to the time of ripening in January or February, the red patches steadily increase in size and number. The fibro-vascular bundles become less juicy,

red and spongy in character. Fine-looking, thick and soft canes are specially affected. Towards the ripening of the canes black specks begin to appear which burst open from within outwards. These first appear near the roots and then work upwards and then finally the affected cane shrivels up and dies. The Rind Fungus and Root Fungus, at one time considered different, are only two stages of the same fungus. The yield of sugar from a diseased plantation is very poor, and the fungus in its epidemic form does very extended damage to the crop. Juice obtained from diseased canes takes longer to crystallize.

Experience on the Sibpur Farm has shown us that superior varieties, such as the Chittagong *Patna Kusur*, and the *Samsara* are far more subject to the attack of this fungus than poorer varieties such as the *Khari* sugarcane. It has been also seen that if tops are used for seed and if these are dipped in a solution (1 : 200 or 300) of sulphate of copper at the time of planting, the disease can sometimes be arrested. The old affected fields must be set fire to as also the dry leaves and trash accumulating at the time of harvesting and crushing of canes. Rotation should be invariably practised in cultivating sugarcane, as the same field if it is used for growing sugarcane year after year must become a hot-bed both for the conidia of this fungus and for the grubs of the borer moth. Growing of canes from seed and then gradually establishing a healthy stock has been found beneficial in Java and other cane-growing localities where European planters are employed in the cultivation of cane.

## CHAPTER CXXXVII.

### MUSHROOMS (*AGARICUS CAMPESTRIS*).

It must not be supposed that all fungi are noxious pests. Some of the mushrooms (which are among the highest fungi) offer very palatable food, and if the food can be digested, it is very nutritious. Some mushrooms are very poisonous, and the most practical methods of distinguishing edible mushrooms are:—(a) To taste a bit of the raw mushroom. If the taste is sweetish and pleasant, it is quite safe to count it as an edible mushroom. If it has a bitterish or acrid taste, it may be rejected as a poisonous one. (b) To rub a little bit of the raw mushroom with the fingers. If the colour changes from white into green, the mushroom is poisonous. If the colour does not change, it is a safe one to eat. But, it is still safer to rely upon imported French 'spawn' bought from the Great Eastern Hotel, Calcutta, or some other reliable firm, and grow the mushrooms from it in artificially prepared beds. The spawn incorporated with loose manure is sold by the Himalaya Seed Stores, Mussoorie, at Rs. 2-4 per box of 2 lbs. This gives very good results. The best place to choose for mushroom-beds is a damp godown, where a specially prepared soil is to be

spread to a depth of 18". The soil should consist of five parts of garden mould, 10 parts of fresh horse-dung and one part of fresh ashes, thoroughly mixed up and exposed for two days to the sun before it is spread out in the godown. After four or five days the spawn should be sown a foot apart each way. The spawn should be taken in pieces about 2 inches square, dipped in water and sown in holes 3 inches deep covered up after sowing and beaten down firmly. After a month 2 inches of garden mould are to be spread over the bed, beaten down and well watered. No further attention is needed afterwards except occasional watering to the walls to ensure dampness of the atmosphere of the godown. If spawning is done early in September, the first mushrooms will come up at the end of October. Small cellars are utilized in Europe for growing mushrooms on shelves fixed in the walls one above another. So grown, the mushroom crop may prove remunerative in this country also, grown in towns like Calcutta where there is a rich European population who value mushrooms as a delicacy.

## PART VIII.

### CHAPTER CXXXVIII.

#### GENERAL REMARKS ON INDIAN FAMINES.

FAMINES are not to be looked upon as a novel phenomenon in India. Famines occur and have always occurred, except in the most highly civilized countries of modern Europe. In these countries trade and manufactures are in such an advanced state of development, that people in them do not need to depend on their local agricultural produce only. The yield per acre in these countries is also larger, and total failure of crops is prevented by the adoption of scientific methods of tillage and treatment. Severe famines are spoken of in most ancient historical works, and in India it is the paucity of ancient historical records that makes the subject of periodical failures of crops so difficult of demonstration. Famines of long duration are, however, casually mentioned in many Sanskrit works, and they are spoken of as the consequence of the sins of the sovereign. The tendency of Hindus to blame the sovereign power whenever there is a famine, is, therefore, quite orthodox according to their notions. It is known, however, that even during the most prosperous and illustrious reigns, famines have occurred. In 1596, in the reign of the popular Emperor Akbar, a very severe famine raged in India, in which people were reduced to such extremity that many kept themselves alive by devouring human flesh. In 1615-16 a similar famine occurred followed by plague, which lasted several years. It is also known from authentic history that severe famines raged in the reigns of Shah Jehan and Aurangzeb. In the famine of 1770, in nine months ten million people died in Bengal. The famine of 1784 was of such bad type that four seers of wheat were sold for a rupee, and the deaths from starvation were innumerable. The most recent of serious famines, *viz.*, that prevailing in some part of India or other from 1896 to 1901, was severer than the famine of 1874-78, but neither of these two famines which are within our living memory can be compared in destructiveness of human life to the famines which prevailed more than one hundred years ago.

On the other hand, it must not be supposed, that because more land has been under cultivation now than ever there was

in former times ; that because, on the whole, there has been steady progress in the export of food-stuffs from India ; that because India has had no occasion yet to look to foreign countries for means of livelihood ; that because the agricultural population appear to be generally better off now than they ever were before, that therefore there is nothing to fear from the steady increase of population and the necessary limit there is to extension of cultivation. Already the extension of cultivation has gone on to such an extent in the populous localities, that there is not sufficient pasture-land left for the cattle. Barring occasional famines, no actual stress is felt yet regarding the food-supply of the country. But in another twenty years, unless agricultural improvements keep pace with the increase of population, or plague decimates the people at a still greater rate than it has been doing, the aspect of affairs may change entirely, and India like England may have to look to foreign sources for food-supply, or take to emigration on a more wholesale scale. How India stands at present with reference to the rest of the Empire can be seen at a glance from the following table :—

|   | Approximate area. | Population. | Density of population per sq. mile —(640 acres).       |
|---|-------------------|-------------|--|
|   | Sq. miles.        |             |  |
| 1. Great Britain and European possessions                             | 125,000           | 41,000,000  | 328 (less than 2 acres per individual).                |
| 2. India and other Asiatic possessions ..                             | 1,720,000         | 325,000,000 | 189 (—over 3 acres per individual).                    |
| 3. African possessions including Transvaal and Orange River Colony .. | 3,000,000         | 50,000,000  | 16 $\frac{2}{3}$ (nearly 40 acres per individual).     |
| 4. American possessions   | 3,765,000         | 7,000,000   | Nearly 2 (—320 acres per individual).                  |
| 5. Australian colonies ..   | 3,257,000         | 5,170,000   | About 1 $\frac{1}{2}$ (over 400 acres per individual). |
| TOTAL ..  | 11,867,000        | 428,170,000 | 37   |

Taking the area under food-grains in India at 164 million acres and the produce of grain per acre per annum at 840 lbs. and the population at 350 millions, we have to the lot of each individual of the population only 393 lbs. of food-grains per annum, a quantity, though sufficient for the present needs, is alarmingly

little, if any future expansion of population is taken into consideration. Of course, for a time the difficulty will be naturally met by the conversion of non-food areas into food-growing areas, but there is a limit to this source of expansion also.

The area covered by the British Empire is about one-sixth of the area of the whole earth's surface, and the population represents a fourth of the population of the whole world. The stress of population, though highest in England itself, cannot now result in famines in that country. The following among other reasons may be ascribed for this immunity: (1) The produce per acre is much larger in England. (2) The population does not depend upon agriculture solely for subsistence as commercial and manufacturing pursuits have increased the wealth of England to such an extent that unless all means of communication by sea with foreign countries can be stopped, there is no possibility of food becoming scarce in that country. (3) The superabundance of food-produce in one part or other of the vast Empire can always supply the deficient produce of England. England in fact is not able now to produce the food she requires for her consumption. But she need not depend upon foreign countries at all: her own possessions in other parts of the world making her quite independent in this respect, though as a matter of fact England still imports a good deal of wheat from Russia, France, the United States, and South America. (4) Emigration to other countries is another means whereby England has maintained her position as a wealthy country notwithstanding the great stress of population. As the population of India is getting large, it is by the fourfold means noted in the case of England that India must also learn in the near future to keep herself above want in the matter of food-supply:—(1) She must learn better methods of cultivation whereby the produce of land may be enhanced. (2) She must direct her attention to commerce and manufacture, whereby stress on land will be lightened. (3) She must learn to import food-stuffs from those parts of the Empire where meat and corn are produced excessively cheap, as soon as famine becomes certain. (4) She must learn to send out her superfluous population voluntarily and willingly to those parts of the Empire. The stress of population, in normal years, is not yet felt in India because the allotment of three acres per individual of population is quite sufficient. But where cultivators readily convert their surplus food into cash in a good year, and where this surplus food goes out into foreign countries, a bad year brings sudden distress, which is not relieved by indigenous commercial enterprise bringing food-stuffs in from foreign sources, as would be the case in more civilized countries. The Indian grain dealer does not trouble himself about the price of grain in Australia, Canada, or Cape Colony when a bad year comes round, and he in common with the cultivator looks to Government for means of subsistence to be brought to his very doors. The need for

emigration also is not felt yet except in special localities. But in another twenty years, the question of emigration into other parts of the Empire may have to be more seriously taken up, and then India must make common cause with England and try to be recognized as an integral part of the Empire, looking upon the sparsely populated portions of the Empire as the natural field for her expansion. By assisting in the foreign wars of the Empire, and by common political sympathies with the heart of the Empire, and not by the encouragement of merely national or racial feelings, can India hope to be recognized as an integral part of the Empire, with equal rights and privileges with England in the matter of colonial expansion. The time will come when the right political attitude will be forced by necessity upon the intellects and consciences of the leaders of Indian thought, who can still afford to indulge in the idea that India's resources make her quite independent of the ideas of colonial expansion by which the nations of Europe are *perforce* guided, compelling them to seek fresh fields and pastures new in sparsely populated regions of the globe. What is now recognized as the 'Imperial feeling' is neither a bye-word nor a mistake, but a concrete necessity, which English politicians of all schools of thought are beginning to realize, and it must be the solid foundation of that vast Empire to which we have the privilege to belong.

The *cause of famines* is, as is well known, the failure of the monsoons. The tracts protected from failure from this cause are (1) the canal irrigated tracts, and (2) the regions of heavy rainfall, *viz.*, Assam and parts of Eastern Bengal, the Cis-Himalayan regions of Northern Bengal, and Eastern and Western Ghauts and Southern Burma, *i.e.*, all those tracts where the normal rainfall is seventy inches per annum or more. The rest of India may be looked upon as 'precarious tracts.' Because the Rarh country suffered more than the Bagri in the famine of 1874; the Rarh was at one time considered a precarious tract, but in the famine of 1897 it was the Bagri country that suffered and not the Rarh.

## CHAPTER CXXXIX.

### THE SYSTEM OF LAND REVENUE AS AFFECTING THE QUESTION.

It has been said that the land revenue levied by Government is so heavy that it is indirectly a potent cause of famines. The total annual income from all sources which our Government receives is a little over 100 crores of rupees, of which land revenue accounts for about 26 to 27 crores, or a little over one-fourth of the total income. Sir William Hunter estimates the revenue demand at  $5\frac{1}{2}$  per cent. of the gross produce of land. In Bengal where most of the land is permanently settled on zemindars, the revenue demand of Government usually bears but a small



proportion to the rent recovered by zamindars or the superior landlords from actual cultivators. The Government demand alone, bearing but a small proportion to the actual outturn from land, causes no appreciable hardship to the cultivator in Bengal. In comparison with the United Provinces of Agra and Oudh, for instance, Bengal has to carry a very light burden in the shape of land revenue, though the actual rent paid by cultivators to their landlords is higher, specially in Bihar and in Eastern Bengal, than in those up-country Provinces. The acreage of the United Provinces of Agra and Oudh is only two-thirds that of Bengal. Debarred by the Permanent Settlement from materially increasing the land revenue of Bengal, Government is obliged to assess a higher rate of revenue from most of the other Provinces, and the burden is consequently unequal. And yet the land revenue in the United Provinces seldom exceeds ten per cent. of the gross produce of land. This is a lighter burden than what was imposed by former Governments on land. Akbar claimed one-third of the gross produce of land as his due. From the historian Strabo we learn that, at the time of Alexander's invasion of India, the Raja's share of the produce was a *chouth* or fourth. Manu put the king's share variously at one-sixth, one-eighth and one-sixteenth of the produce of land. The total land revenue obtained at the time of Akbar was indeed about ten crores shorter than what is obtained by the British Government. But this may be accounted for by two causes: (1) Akbar was never able to bring to complete subjection for the purpose of assessment of land revenue such a large territory as is owned for this purpose by the present Government. (2) There is far more land under cultivation and less jungle now than in the days of Akbar. The development of the country's resources by means of roads and canals and railways has been very great and the purchasing power of the rupee is also far less now than in the time of Akbar. The land revenue collection, therefore, though nominally higher, is intrinsically of less value than in the time of Akbar. It should be noted, however, that in the reign of Aurangzeb the land revenue exceeded the present limit.

The present land revenue systems of India are a direct heritage from former Governments. The modifications under the British Government have been few and unimportant, the tendency having been to recognize the local customs prevailing at the time of the codification of any law regarding land. And yet tracing the main feature of the Indian land revenue system from the oldest time to the present, one cannot help confessing, the change has not been altogether to the benefit of the cultivator. The earliest inhabitants of India, known to ethnologists as Kolarians, recognized the patriarchal or family system. The proprietary rights in land rested in the family or tribal organization by whose labours the land had been cleared or reclaimed from the jungle. Their institutions were democratic. The chiefs, though they

held larger and more fertile holdings, claimed no tribute or revenue as a matter of right and only accepted gifts. The democratic instinct is still ingrained among Kols and Sonthals who cultivate jungle land without waiting for anybody's permission, and who consider themselves harshly treated if they are ousted by the zemindar afterwards. The Dravidians who followed the Kolarians extended the system of their predecessors. They permitted the proprietary rights in the land to rest with the actual cultivator. The king, however, exacted a certain share of the produce from each holding, except from those held by priests, military officers and others rendering service. The Aryans who followed the Dravidians kept up the land system of their predecessors and recognized the reclamer of land from jungle as the true proprietor, and all landholders, except priests, kotwals and others who rendered service, paid a portion of the produce of land to the king. The Hindu system never recognized the king as the proprietor of cultivated land, but only its protector or overlord. The Mahomedan conquerors accepted the system of their predecessors as it happened to be in accord with their own laws and customs. The first important change was made by Akbar, who substituted cash payment for payment in kind. It was during the decadence of the Moghul empire that petty chiefs, rajas, and jagirdars rose into power. They had sufficient local authority to prevent collection of revenue by the officers of Government. It became necessary for the British Government in its early days to recognize these magnates and to transfer to them the claims of Government in return for an annual tribute paid by them to Government. In most cases the revenue paid by rajas and talukdars to Government is of this nature only. Another class of people also arose at the decadence of the Mahomedan power, *viz.*, one to whom Government farmed out the right to collect revenue, to retain a certain share of it for their trouble (afterwards known as Malikana), and to pay the balance to Government. This is the origin of the zemindar class. The Permanent Settlement recognized permanently the maximum collection the British Government could make at the latter end of the eighteenth century in these provinces. Lord Cornwallis only carried on the existing system by collecting revenue through zemindars. The Permanent Settlement, however, was saddled with three serious mistakes, which Government have been since trying hard to rectify without breaking its pledge with the zemindars: (1) No survey of estates or holdings was made and the revenue was fixed for ever irrespective of the extent or the possibilities of the estate. (2) The rights of the cultivators were not safeguarded, and practically no limit was placed to the rent demands, though the revenue demand was fixed for ever. (3) In fixing the land revenue for ever, Government is hampered in the matter of taxation, zemindars, for instance, being exempt from the payment of income-tax at the expense of their fellow-subjects. When it is remembered that half the income-tax of Bengal is

derived from the residents in Calcutta, it may be inferred how trade is unduly hampered by this limit of choice on the part of Government. The light burden of land revenue of about three per cent. of produce imposed on permanently settled estates necessitates the imposition of a heavy burden of ten per cent. in the case of estates not permanently settled, and thus the burden is unequal without any adequate reason as regards prosperity or otherwise of the cultivator.

The actual incidence of land revenue per acre of cultivated *net cropped* area in the different Provinces of British India and Native States may be judged from the following figures compiled from the Agricultural Statistics for 1898-99 :—

|                           | Rs. A. P. |    |    |
|---------------------------|-----------|----|----|
| Bengal .. .. .            | 0         | 12 | 7  |
| Assam .. .. .             | 1         | 3  | 4  |
| United Provinces .. .. .  | 2         | 0  | 2  |
| Oudh .. .. .              | 1         | 15 | 1  |
| Punjab .. .. .            | 1         | 2  | 10 |
| Sind .. .. .              | 2         | 6  | 0  |
| Bombay .. .. .            | 1         | 6  | 0  |
| Madras .. .. .            | 2         | 4  | 11 |
| Berar .. .. .             | 1         | 2  | 10 |
| Central Provinces .. .. . | 0         | 9  | 4  |
| Ajmir-Marwar .. .. .      | 1         | 3  | 11 |
| Upper Burma .. .. .       | 2         | 2  | 1  |
| Lower Burma .. .. .       | 1         | 15 | 4  |
| Coorg .. .. .             | 1         | 4  | 11 |
| Mysore .. .. .            | 1         | 8  | 6  |
| Bikanir .. .. .           | 0         | 7  | 7  |
| Jaipur .. .. .            | 4         | 3  | 11 |
| Gwalior .. .. .           | 2         | 5  | 9  |
| Marwar .. .. .            | 0         | 15 | 10 |
| Tonk .. .. .              | 2         | 9  | 6  |

The above figures show that the Government demand in the shape of land revenue is very light, and it is not any more in British India than in most Native States. Though a rupee was far more valuable in olden days than now, the land revenue in the days of the Moghul Emperors was about the same as at the present time. In 1664 the land revenue of India under the Moghul Empire stood at 26 crores 74 lakhs, and in 1665 at 24 crores 5 lakhs. In Aurangzeb's time the land revenue was assessed at 34 crores of rupees. In the case of Bengal, it will be seen that though the Government demand is only about 4 annas per bigha, the rent actually paid by the cultivating raiyat is seldom so low as 4 annas and it is often as much as Rs. 3 or even Rs. 10 per bigha, and the average rent of agricultural land in Bengal is about Re. 1 per bigha or Rs. 3 per acre. To lay the blame, when famine or distress of any kind prevails in the country, on Government, and to say the poverty of the people is due to over-assessment of land revenue, is absurd. Of course, the high rent actually paid by cultivators in other than Government estates is due to the facilities at present existing for the creation of intermediate proprietorship and tenures between the Government and the actual

cultivator. But this system can be changed only at the sacrifice of the Permanent Settlement, to which Government is pledged in most parts of Bengal. Besides, it cannot be said Bengal suffers any more from famine than other parts of India, or that the raiyats in permanently settled estates in Bengal are worse off than the raiyats of the Central Provinces, for instance, though the former pay the average rent of Rs. 3 per acre, while the latter only 12 annas per acre. The greater fertility and the more settled rainfall of the Gangetic plain make our province more secure against famines, though the cultivator is burdened with larger demands in the shape of rent by their immediate landlords.

## CHAPTER CXL.

### MEASURES OF PROTECTION AND RELIEF.

*Legislative measures.*—It is not impossible for Government to help the cultivator by legislative methods. (1) The exportation of new rice may be prohibited, this may have the effect of cultivators, zemindars, mahajans, and grain dealers holding large stocks of grain until the next season's prospects are certainly known. It is not difficult to distinguish between old and new rice, and the prohibition can be easily enforced. (2) The export of bones and oil-seeds (not oils) may be prohibited. (3) The minimum proportion between land revenue and rent paid by the actual occupier who is a cultivator may be fixed for ever. (4) All cultivating raiyats may be compelled by law to maintain one food or fodder-yielding tree per acre of land he holds, the list of such trees being published from time to time and nurseries maintained in connection with District Engineers' offices and inspection bungalows, whence planting from road, river and canal sides may also proceed systematically. (5) Each Village Union may be compelled to maintain a conservancy establishment, and allotted fields for burial of dead animals, night-soil and other refuse matter, where trees yielding food and fodder may be systematically grown, and fuel and fodder sold from this miniature forest after 10 years' growth. This is a modification of Dr. Voelcker's recommendation regarding propagation of fuel and fodder reserves.

*Departmental measures.*—The Agricultural Department may teach raiyats how to store grain, by having stores of superior varieties of seed at certain recognized centres for sale to raiyats. One variety of seed may yield twice as much as another variety, all other circumstances remaining the same. The collection of seeds of prolific varieties of grains, pulses, etc., may occupy the time of a special travelling officer of the Agricultural Department. The same officer may collect seeds, tubers, etc., of drought-resisting and flood-resisting crops. Some varieties of rice do well in dry soils by sending their roots deep down into the soil. Some varieties

on the other hand, increase in height as the flood increases. A list of such prolific, drought-resisting, and flood-resisting crops may gradually be prepared by the Agricultural Department after careful enquiry and experiment; and seeds, roots and cuttings of such crops may be kept for sale to raiyats in the recognized seed-distribution centres. This may also have the effect of protecting raiyats from taking inferior seeds from *mahajans* on loan on ruinous terms. A maund of paddy seed, for instance, may be valued by the *mahajan* at the sowing season when he gives it out for Rs. 2. At harvest time he values the paddy at Re. 1 a maund, and takes back two maunds of paddy by way of principal and another maund by way of interest. The *mahajan* does not mind if the raiyat loses his crop. He advances another maund of seed again to him next year, and then if he has a good crop he takes back from him  $7\frac{1}{2}$  maunds, i.e., 3 maunds on account of previous year,  $1\frac{1}{2}$  maunds on account of interest for that 3 maunds subsequent to the harvest, and 3 maunds for the second year's loan. Thus in two years the *mahajan* gets back  $7\frac{1}{2}$  maunds for the loan of 2 maunds of seed which he may have bought at a cheaper price than what he sells his  $7\frac{1}{2}$  maunds at. It is the local price at harvest time that the *mahajan* considers when securing his grain, and it is the local price at seed time at which he gives it out, and if the price of seed is cheap, he sometimes does not give it out at all, but holds his stock till next year, or the year after, when he gets the best bargain, selling the grain as grain and not as seed. It is in this way some *mahajans* in Bengal were found to own several lakhs of maunds of paddy in the famine year of 1897, and they let it all out that year. The *mahajani* system has its advantages, if no better system of supply of good seed at more reasonable rates can be substituted in its place. But if an official system, or a system devised with the aid of local bodies or bankers, can be substituted for it, one of the greatest of curses under which the Indian cultivator has lived from time immemorial, will be removed.

The Agricultural Department may also organize a system through village unions and *putwaris*, of lending out irrigation and other machinery, superior bulls, etc., on hire. Behia mills have, no doubt, been popularized without such aid, but as a matter of fact, the *raiya* needs a helping hand, as small farmers in every other country do. The fruits of agricultural science can filter down to actual cultivators only by means of an organized agency where the cultivators are either illiterate or very poorly educated, who are not accustomed of their own accord to make new departures. Of course, the principal lever to move the *raiya* is education, specially agricultural education, but an expert agency, working in connection with village unions, may also accomplish a great deal.

The extension of canals and railways are further measures of protection which Government has been steadily developing.

Death from starvation even in localized famines was more general in times past than now, when means of communication with the interior are easier. But greater progress in these directions is desirable.

*Relief works.*—The means of affording relief when famine actually breaks out are detailed in the Famine Code. One suggestion, however, will not be quite out of place in a book like this. By the end of September or middle of October it becomes quite evident whether famine is going to take place or not. If the general outturn estimated for the whole province by the Agricultural Department, of *Bhadoi* and *Aman* crops, falls short of 50 per cent., it may be assumed that there will be famine, though people may not begin to come to test or relief works till February. Relief works should be started in each *thana* where the estimated crop is 25 per cent. or less. All works organized for relief of famine should be arranged for from October to January,—the actual opening of test-works, however, being delayed as long as possible. The programme of works should include only such as are calculated to increase the produce of land directly or indirectly. It is a sorry sight to see thousands of men and women employed in raising a road four or five feet high, when their energy might have been devoted to irrigating lands on canal and river sides, and raising a food-crop, or when they might be employed more usefully in excavating canals, irrigation channels, tanks and even wells. The roads made by famine people are usually so badly made, that the next rainy season makes the fact quite patent that making of *kutchra* roads is not a suitable work for these people. Growing a crop by irrigation at the driest season of the year, from February to May, would be a splendid object-lesson to *railyats*, which may have a permanent effect in their learning how to avoid famines for all times to come. Relief works ought to aim at giving such object-lessons to the cultivators. Earth-work in a tank or a well is as easily measured as on a road, and in the large expanse of a paddy field it would be easy getting 5,000 labourers employed under one supervising staff, if 1,000 wells are excavated in it at regular distances. Each well would cost about Rs. 25, inclusive of the cost of well-rings, and the work would not take more than a week accomplishing. Each party of five can be then employed in irrigating with leather buckets, worked by bamboo levers, an acre or two of land, one-tenth to one-fifth of an acre being irrigated every day according as the soil is light or heavy, cultivating the land, and raising a crop from it, in three months, of maize, or millet, or *aus* paddy, or some pulse. The crop will just come in when the famine is at its full height, from May to July. If 2,000 acres can be irrigated out of a paddy field 5,000 acres in expanse and 40,000 maunds of food-grains thus raised from the tract, the lesson thus taught is not likely to be forgotten very soon. In some suitable localities *dons* may be employed, and a thousand of these, worked beside a canal or a stream, may serve to irrigate 4,000

acres of land, by the employment of 3,000 persons, 2,000 being employed in working the *dōns* and distributing the water, and 1,000 in cultivating, sowing, weeding, etc. We never hear of the energies of famine labourers being thus utilized in raising a crop at the worst time of the year, and throwing in an extra supply on the market when the food supply usually gets to the lowest ebb. Another special advantage claimed for the system of relief work here recommended is, cultivators will be able to go and work in their own fields from June instead of diverting their attention to famine works to the great detriment of the agricultural prospects for the succeeding year. From February to May is the slack time for cultivators, and if by artificial methods a food-crop can be then raised by people in distress, the advantage will be two-fold.

*Agricultural Banks.*—These should be under Government supervision, and Government can guarantee an interest of 3 per cent. per annum and transfer to the Banks the duty of granting *talavi* loans on interest. Any *raiyat* contributing to this Bank can thus be sure of his principal and at least 3 per cent. by way of interest, and of getting back in years of local distress the whole amount of his contributions and accumulated profits, or, on joint application of a number of cultivators and shareholders, of getting back the whole amount of their joint contribution. A larger amount can be lent on joint security, under certain restrictions, and interest charged thereon at  $6\frac{1}{2}$  per cent. As shareholder, a *raiyat* should be eligible to share in the profits of a Bank provided his balance does not fall below Rs. 100, though he may contribute any amount down to a minimum of Rs. 10 per annum to make him eligible for sharing in the benefits in years of distress. The Banks should invest the money in securities approved by Government; but speculations of an agricultural character approved by Government should be allowed. A scheme worked on such a line will teach *raiyats* economy, and it may lay the foundation of a great many agricultural improvements. If 3 per cent. of interest is guaranteed by Government and if the Banks are controlled by Government, there should be no lack of shareholders and of capital.

## CHAPTER CXLI.

### AGRICULTURAL EDUCATION.

WE have alluded to agricultural education as one of the principal means of overcoming famines. The means must necessarily be slow in its operation, but it is the surest means of all; and if the system of agricultural education devised is of a sufficiently practical character, the effect need not take very long in being perceived. Foundation has been laid of agricultural education in Bengal; but the arrangements formerly made, at Sibpur only enabled Government to give agricultural education of a rather

high standard, to only about a dozen individuals annually. If these men (who were mostly graduates in science of the Calcutta University) had been judiciously employed, they might have been able to supply all the special agricultural agency needed for developing the educational and experimental works under Government. A much larger scheme of superior agricultural education has, however, now been carried out, involving the establishment of an agricultural college at Bhagalpur, which may ultimately turn out fifty or sixty trained men each year. The passed men from this college might be employed in charge of farms attached to the Normal Schools, which should form the centres of that form of agricultural education which should be imparted in the different vernaculars of the province. The practical work of the farms can then be conducted under those conditions under which agriculturists have to work in the different parts of these Provinces. The methods or staples that may be introduced with success at Sibpur or Bhagalpur may not answer for Hazaribagh, or for Kalimpong, or for Cuttack. Men trained in scientific principles of agriculture will, however, be able to adopt new methods suited to the conditions and environments under which they work, and what village school-masters should be taught are not so much the principles or the theories, but concrete facts regarding improvements that are feasible in their own particular localities. At the School of Agriculture at Nagpur, village school-masters are given training in agriculture for a period of six months only (inclusive of holidays and vacation). In six months or one year, these men can be taught to advantage only certain new methods, and if they go back to their villages or village schools with seeds and cuttings of half a dozen new and valuable staples, one or two new implements, and with their minds stocked with various useful information regarding the manner of picking seed, of avoiding insect and fungus pests, of avoiding the effects of drought or inundation, their training will be directly beneficial in introducing improvements in the villages in which they will be employed, by means of school-gardens. The knowledge communicated through textbooks by means of object-lessons in the school-garden is bound to spread in a real manner. The pupils will be naturally anxious, for instance, to get from their school-garden seeds of such valuable staples as the fine *aus* paddy, Cabul gram, popat beans, white-linseed, bulbs of African yam, cuttings of cassava and suckers of *Sansieviera trifasciata* and *Fourcreaca gigantea*. Their books on agriculture should not be devoted to teaching, on the one hand, what the pupils and their parents are already quite familiar with, nor, on the other, to attempting to stock the minds of the pupils with abstract notions of botanical physiology and abstruse facts regarding nitrogen, potash, and phosphoric acid, leaving to the pupils the hopeless task of making use of the *principles* they are taught in introducing agricultural improvements in their own way. They should be shown certain definite examples of



improvement in their school-gardens, and their teaching should be thoroughly concrete. The school-masters themselves may be taught agriculture in a more systematic manner in farms attached to Normal Schools, but in village schools should be taught only certain definite facts which will enable the pupils to derive some immediate benefit from their school education. If the school-going son of a cultivator can be of help to his father in his own difficulties, the father and the son will both begin to find out that education and farming are not necessarily antagonistic to each other. If the village school-master can be of help to the *raiyat* in his own business, the *raiyat* will think more highly of his own business also than he is accustomed to think at present. The tendency among cultivators and artizans who attain to some amount of prosperity by following their own ancestral craft is to shun their craft, to take to money-lending, and to make clerks of their sons. The spread of literary education has been antagonistic to the advancement of arts and industries, and it is very important that from the lowest stage children should have education of such a character as may enable them to pursue their ancestral occupations with greater ability and interest, instead of despising such occupations and taking to others which are considered genteel.

The principle already recognized for primary and secondary schools can be recognized also for high schools and colleges, and permission may be granted to all mofussil schools and colleges to teach agriculture in place of physics or chemistry. It is less expensive organizing gardens and farms in connection with mofussil colleges and high schools than making an adequate arrangement for teaching chemistry and physics, and many colleges and high schools may avail themselves of the permission right off by employing passed students of the Sibpur agricultural classes, to teach agriculture in place of chemistry and physics. However meagre the arrangement that may be made by a mofussil school or college for teaching agriculture, this subject cannot possibly be worse taught than physics or chemistry is at present. Facts of agricultural science abound in the mofussil, and if the teacher employed has been himself taught in a practical manner, he will not need much outlay of money to impart sound knowledge of such facts and the principles underlying them, to his pupils. There cannot, in other words, be such occasion for cramming in the case of agriculture, as there is in the case of chemistry and physics, in the case of mofussil schools and colleges. In course of time, specimens of rocks, minerals, crops, manures, economic products, insect and fungus pests, will accumulate, if the teacher does his duty, and the subject will be always better and better taught. In the case of chemistry and physics, an opposite tendency is often noticed in mofussil colleges. A sort of a laboratory is fitted up at, what is regarded as, great cost, and there is unwillingness on the part of the college authorities to replace implements and chemicals as they get broken or used up. Some agricultural implements must

be bought, but their working can be shown with hired bullocks and no great outlay is needed for this purpose. Thriftiness on the part of school and college authorities will be less detrimental to agricultural education, than it now is to the imparting of a sound knowledge of chemistry or physics. As a means of developing the faculties of the mind, agricultural education is far more valuable than even a sound training in any one particular branch of science. If it is contended that a preliminary knowledge of all the sciences is necessary for a systematic study of agriculture, it may be pointed out that agriculture as a subject by itself, which can be taught in a very easy manner and also in a very difficult manner to students of various standards of education, is recognized in all advanced countries, and that what is really needed for a right understanding of agricultural science is only the science of every-day life, which intelligent farmers of Europe and America, without any scientific training, find sufficient to enable them to keep abreast with the times in their own particular occupation. If a farmer has first to be a chemist and botanist and geologist and zoologist and engineer, he will never make money by farming.

In the introduction to this book, which is virtually the inaugural lecture delivered at the Sibpur Engineering College some years ago at the opening of the agricultural classes, we have expressed doubt as to the usefulness of high caste Bengalis in the sphere of practical agriculture. After some years' experience we have had ample reason for modifying the opinion. The number of students seeking admission into these classes who were really interested in agriculture steadily increased, and the men who passed out and are employed in agricultural work are doing such excellent work that we feel disposed to assert that English education will have as much influence in remodelling and improving the agricultural condition of the country, as it has had in other walks of Indian life.

THE END.



## I N D E X .

- ABORTION**, 496.  
**Aeromotors**, 87.  
**Agaves**, 146, 150, 154, 248, 249.  
**Agricultural Banks**, 612.  
**Agricultural Education**, 612—615.  
**Aich**, 150.  
**Akanda**, 248.  
**Albizza procera**, 507.  
**Albuminoids**, 151—153, 518, 479, 48.  
**Aloe**, 248, 250.  
**All-stock-and-no-crop**, 161.  
**Alumina**, 118.  
**Amada**, 146, 150.  
**Ambari Hemp**, 148, 234—236.  
**Amlaki**, 150, 166.  
**Ammonia**, 419—421.  
**Analysis**, 448—475.  
**Anise**, 149, 320.  
**Ant**, 563—565.  
**Anthrax**, 492, 572, 590.  
**Anti-toxin Treatment**, 577.  
**Apatite**, 14, 427.  
**Aphides**, 567—568.  
**Aphthæ**, 496.  
**Apiculture**, 384—385.  
**Arahar**, 26, 40, 112, 148, 149, 204 -  
 221, 246, 332, 535.  
**Areca Nut**, 387.  
**Arharia Sim**, 64, 148, 206, 507, 583.  
**Arrowroot**, 146, 150, 345—346.  
**Artesian well**, 133—134.  
**Artichoke**, 149.  
**Asan**, 150, 386.  
**Aulacophora abdominalis**, 543, 544,  
 566.  
**BARUI**, 69, 148, 150, 156, 386, 387.  
**Bacon**, 527—529.  
**Bacteria**, 409, 578—593.  
**Bæl**, 387, 503.  
**Bahera**, 150.  
**Bajra**, 39, 64, 145, 154, 202.  
**Bakhar**, 75, 104, 194.  
**Bakla**, 148, 503, 579.  
**Baldeo Balti**, 123, 133, 136.  
**Bamboo**, 146, 150, 346—348, 387.  
**Banana**, 253—256.  
**Barbati**, 148, 149, 203—208, 281, 505.  
**Barley**, 39, 40, 69, 145, 154, 192—194.  
**Barui**, 313.  
**Beans**, 39, 73, 117, 203—208, 266—270,  
 503.  
**Beet**, 2, 36, 149, 266—270, 274.  
**Behia Mill**, 7, 109, 274—288.  
**Belun Pat**, 248, 251.  
**Betel-nut**, 316—317.  
**Bhela-nut**, 149, 208, 210, 232.  
**Bhringi**, 148, 150, 204, 206, 208, 503.  
**Bhura**, 144.  
**Bhusa**, 152, 503.  
**Bidia**, 111.  
**Black Cotton Soil**, 13. (*See* Regur.)  
**Bloody Milk**, 582.  
**Bone manure**, 218, 252, 398, 427, 428.  
**Bone super**, 429—432, 460—464.  
**Bordeaux Mixture**, 264, 534, 535, 596.  
**Boring Insects**, 533, 561, 563.  
**Bot-fly**, 547.  
**Bottle-gourd**, 150.  
**Bread-fruit**, 387.  
**Brinjal**, 147, 150, 261—263.  
**Broccoli**, 266—270.  
**Brussels Sprout**, 266—270.  
**Bucket-pump**, 131, 134, 138.  
**Buck-wheat**, 40, 149, 202, 203.  
**Buffaloes**, 476—478.  
**Bullock Gear**, 102.  
**Bullock's Heart**, 251.  
**Bull's Dredger**, 138.  
**Bunt**, 199, 598—599, 684.  
**Butter**, 5, 520—523, 583—584.  
**CABBAGE**, 2, 37, 39, 117, 149, 266—270.  
**Camphor**, 317—320.  
**Canna edulis**, 146.  
**Carbohydrate**, 151—153.  
**Carboniferous rocks**, 15, 16—17, 18.  
**Cardamom**, 150.  
**Carob Bean**, 387.  
**Carrot**, 37, 149, 150, 196, 266—270.  
**Cashew Nut**, 37, 150, 208, 209, 387.  
**Cassava**, 147—150, 339—344.  
**Castor**, 147, 149, 208—210, 217—220,  
 246.  
**Casuarina**, 386.  
**Caterpillars**, 545—546.  
**Cauliflower**, 39, 149, 266—270.  
**Cawnpore Chain-pump** 127.  
**Ceara Rubber**, 147, 154, 351—353.

Celery, 149, 266—270.  
 Centrifugal Pump, 93—94, 135.  
 Chaff-cutter, 138.  
 Chai, 147, 150.  
 Champa Noté Sag, 150.  
 Cheena, 145, 201, 203.  
 Cheese, 5, 523—527, 583.  
 Chemical Analysis 448—475.  
 Chichinga, 148, 150.  
 Chillies, 147, 150, 264—265.  
 Chilo simplex, 541, 561—563.  
 Chironji, 208.  
 Chlorine (in soil), 36—45.  
 Chufa, 146, 150.  
 Chupri Alu, 14.  
 Cicindela sexpunctata, 542.  
 Cinnamon, 319—320.  
 Clod-crusher, 111.  
 Cock-chafers, 543, 544.  
 Coconut, 150, 208, 209, 211, 223—224, 387.  
 Coffee 154, 330—335  
 Coir 223, 224, 248.  
 Coleoptera, 537—541.  
 Colza, 208, 213.  
 Condensed Milk, 581.  
 Coriander, 149, 320, 535.  
 Cotton, 3, 37, 64, 112, 148, 154, 242—248.  
 Cotton-gin, 139, 140.  
 Coulter, 110.  
 Country Figs, 150, 339.  
 Cow-dung, 161.  
 Cow-gram, 161—165.  
 Cow-pea, 64, 149.  
 Cream, 520—523.  
 Crickets, 550—551.  
 Cucumber, 147, 150.  
 Cucurbitaceous Vegetables, 40, 42, 64, Curing, 527—530.  
 Cut-worms, 559—561.  
 Cyamopsis psoralioides, 64, 204, 207.  
 Cyst Disease, 495.  
 DAHI, 581—583.  
 Dal-bhanga rog, 264.  
 Date, 37, 150, 274, 289—296, 387, 440.  
 Degumming, 241.  
 Dengo Sag, 150.  
 Deshi jute, 148.  
 Deodhan. (See Juar.)  
 Dextrose, 296—300.  
 Dhaincha, 64, 69, 148, 162, 221, 231, 251, 281, 314, 398, 421.  
 Dhenki, 138, 181, 220, 227.  
 Dhenkli, 122, 136, 137.  
 Dhundul, 147.  
 Diarrhoea, 496.  
 Diptera, 537.  
 Divi-divi, 386.  
 Don, 119, 122, 132, 133, 136, 138.  
 Dracaena ovalifolia, 146.  
 Dragon-flies, 551.  
 Drainage, 69, 70, 75, 121, 421.  
 Drilling, 73, 74, 140.

EARTH-NUT. (See Ground-nut.)  
 Eau Celeste, 534.  
 Ecto-parasites, 533.  
 Elachi, 321.  
 Endive, 266.  
 Engelberg Huller, 181—187, 334.  
 Enzymes, 574—576.  
 Era-kati, 146, 504.  
 Eri-silk, 217, 220.  
 FAMINE, 602—605.  
 Famine-food, 339—344.  
 Farmyard-manure, 414—417.  
 Fat, 151—153.  
 Feering, 107.  
 Fermentation, 576.  
 Five-plot experiment, 45.  
 Fodder Crops 154, 197—198, 501—507.  
 Foot-and-mouth Disease, 494—495.  
 Fungicidal Appliances, 139, 534.  
 Fungoid Diseases, 534, 593—600.  
 GANJA, 234.  
 Garlic, 146, 150.  
 Gathering, 107.  
 Germicides, 574, 579.  
 Ghani, 139, 182, 219, 223, 227, 245.  
 Ghi, 5, 225.  
 Ginger, 146, 150, 272—273.  
 Ginjelly. (See Til.)  
 Ginning Cotton, 249.  
 Glucoses, 296—300.  
 Goat-farming, 487.  
 Gohany Land, 34.  
 Golmarich, 320.  
 Gomukh, 147.  
 Gondli, 145, 202.  
 Gourds, 150, 315.  
 Grafting, 389—391.  
 Gram, 38, 148, 149, 154, 191.  
 Granary Pests, 555—557.  
 Grasshoppers, 550, 551.  
 Green Manuring, 421.  
 Grewia, 346, 347.  
 Ground-nut, 64, 148, 149, 221—222, 246.  
 Grubber, 110.  
 Guano, 425, 426.  
 Guinea-grass, 2, 146, 150, 504—505.  
 Guttapercha, 350—353.  
 Gypsum, 18, 71, 400, 443—447.  
 HAM, 527—529.  
 Haritaki, 150.  
 Harrow, 78, 111.  
 Helancha Sag, 150.  
 Hemiptera, 537.  
 Hemp, 40, 236—237.  
 Hieroglyphus furcifer, 554, 555, 569.  
 Hoe, American Hand, 113.  
 " " Wheel, 113, 193.  
 " Bullock, 83, 114, 147, 159.  
 " Hand, 113, 114.  
 " Hunter 78, 80, 83.  
 " Wheel, 113, 114.  
 Hopperdozer, 555.  
 Horse-gram, 149.

Hoven, 495.  
Humus, 29, 30, 39, 38, 39—42, 417.  
Hymenoptera, 537, 540—542

ICHNEUMON, 535.  
Impaction of Rumen, 196, 495—496.  
Inarching, 392.  
Indian Corn. (See Maize.)  
Indian Horse Radish, 150.  
    " Spinach, 167.  
India Rubber, 350—353.  
Indigo, 69, 148, 154, 300—304.  
Inoculation, 587, 589—590.  
Insect Pests, 531—572.  
Insecticides, 139, 531.  
Iron (in soil), 36—54.  
Irrigation, 7, 8, 69, 75, 116—138, 161,  
    196—197, 258—259, 401.  
Irrigation Spoon, 73.

JACK, 150, 272, 387.  
Jainti, 251.  
Jerusalem Artichoke, 149, 150, 266—270.  
Jhand, 387.  
Jhinga, 147.  
Jhumkalata, 251.  
Jira, 150, 320—321.  
Juan, 321.  
Juar, 39, 64, 145, 152, 154, 191, 197—  
    200, 246.  
Jute, 4, 81, 148, 150, 154, 228—234, 314.

KACHU, 146.  
Kalai, 26, 39, 81, 148, 191.  
Kamela, 386.  
Kankar, 19, 24—30, 46, 49, 400, 439.  
Kankri, 147.  
Kankrol, 147.  
Karala, 148.  
Kasha, 145.  
Kasturi, 251.  
Kayon, 145.  
Kenja, 208, 210.  
Keyaphul, 150, 251.  
Khag, 145.  
Kham Alu, 146.  
Khesari, 40, 148, 203—208.  
Khurpi, 113, 310.  
Knol-kol, 150, 266—270.  
Kodali, 60, 83.  
Kuli-begun, 147, 262.  
Kulthi or Kurthi, 148, 149, 191,  
    203—208, 507.  
Kumra, 147.  
Kundruki, 148.  
Kunra, 180.  
Kurthi or Kulthi, 148, 149, 191,  
    203—208, 507.  
Kutki, 202.  
Kuté-laga, 264.

Lac, 154, 321—322.  
Lac-dye, 323.  
Ladder, 111.  
Ladle. (See Irrigation Spoon.)

Ladies' Finger, 148, 150, 251.  
Lady-bird, 568.  
Lal Garanyia Alu, 146.  
Lata Grass, 146, 150.  
Lau, 147.  
Layering, 392.  
Lentils. (See Musuri.)  
Lepidoptera, 537.  
Leptocorisca acuta, 557  
Lettuce, 149, 150, 266—270.  
Lewa, 324.  
Lime (in soil), 36—54, (as manures),  
    400, 405, 430—443.  
Lime Trees, 436.  
Linseed, 148, 149, 154, 193, 209, 210,  
    214—215.  
Litter, 194.  
Loam, 32, 39, 39—41.  
    " Sandy, 32, 33, 39.  
    " Clay, 32, 33.  
Locust, 28, 551—554.  
Lucerne, 2, 41, 505—506.

MADUR KATTI, 146, 150.  
Magnesia (in soil), 36—54.  
Magnesium, Chloride, 118.  
    " Sulphate, 118.  
Mahua, 208, 210, 225, 387, 503.  
Maize, 2, 39, 44, 64, 112, 145, 149, 154,  
    195—197, 246.  
Maize Huller, 139  
Makhan Sim, 148.  
Mammites, 496.  
Mancipium Nepalensis, 545.  
Mandar, 316.  
Mango, 36, 150, 272, 387, 565.  
Mangold, 30, 503.  
Manila Hemp, 146, 150, 251, 256.  
Mankachu, 146.  
Manure, 395—447, 515—517.  
Maple Tree, 274, 298.  
Marua, 64, 145, 200—202.  
Mat-grass, 346, 347.  
Mauritius Hemp, 150, 250.  
Melons, 13, 150, 339.  
Menjhri, 145, 202.  
Mesta, 148, 234—236.  
Microbes, 572—593.  
Milk, 517—520.  
Mint, 150  
Mosquito-blight, 325  
Mot, single, 123, 136, 137.  
Mot, double, 124—125, 136, 137.  
Moth, 203—208.  
Mowers, 114.  
Mug, 148, 203—208.  
Mulberry, 141, 147, 150, 353—360,  
    387, 507.  
Mulching, 78.  
Munj-grass, 146, 150, 251.  
Mushroom, 600—601, 684.  
Musk-mallow, 148, 150.  
Mustard, 13, 26, 39, 69, 149, 154, 191,  
    208, 211—214.  
Musuri, 40, 148, 203—208.

- Mutha-grass, 146.  
 Mylabris pustulata, 544.  
 Myrabolan, 386.
- NALITA, 228.  
 Neuroptera, 537.  
 Night-soil, 417.  
 Nim, 208, 210.  
 Nitrates, 75, 117, 403—404, 409—427, 464.  
 Nitrification, 72, 412—414, 584—587.  
 Nitrogen (in soils and manures), 402—427.  
 Noria, 131.  
 Nubian Tube-well, 133.
- OATS, 2, 37, 145, 194.  
 Oil-cake, 151, 209, 211—228, 244, 467—472.  
 Oil-cake Crusher, 139.  
 Oilseeds, 208—222.  
 Ol, 146, 339.  
 Onions, 37, 146, 150, 266—270.  
 Open Furrow, 107.  
 Opium, 154, 322—324.  
 Oranges, 348—349.  
 Orthoptera, 537.  
 Oxen, 551—571, 478—487.
- PADDY, 39, 73, 81, 145, 149, 154, 166.  
 „ Aus, 39, 119, 165, 166, 194.  
 „ Aman, 119, 165, 166, 174  
 „ Boro, 75, 176, 177.  
 „ Long-stemmed Aman, 177.  
 „ Rayda, 177.  
 Paikota, 122, 127.  
 Palam, 148, 150.  
 Palas, 148, 150.  
 Palval, 150, 266, 339.  
 Pan, 32, 150, 218, 313—316.  
 Pans, 35.  
 Papaya, 2, 147, 150, 338—339.  
 Para-rubber, 154, 350—353.  
 Parsnip, 266—270.  
 Pasewa, 323.  
 Pasteurization, 581.  
 Patal, 148, 263—264.  
 Payra-mater, 204.  
 Peas, 39, 117, 148, 149, 203—208, 266—270.  
 Peat, 15, 17, 32.  
 Peepul, 163, 150, 320.  
 Pepper, 147.  
 Phapar, 202.  
 Phosphoric Acid, 37—54.  
 Phuti, 147.  
 Physical Properties of Soil, 31—36, 54—61.  
 Pigeon Pea. (*See* Arahar.)  
 Pineapple, 146, 252—253.  
 Pittaraj, 149, 208, 210.  
 Plant-lice, 567—568.  
 Plantain, 2, 146, 251, 253—256, 388.  
 Pleuro-pneumonia, 495.  
 Polaroscope, 298.
- Plough, Baldeo, 97.  
 „ Double Furrow 98.  
 „ Double-mould-board or Ridg-  
 ing, 76, 98, 104.  
 „ Indian, 94—110.  
 „ Meston, 97.  
 „ Multiple, 103—104.  
 „ Paring, 98, 104.  
 „ Potato-digging, 98, 105.  
 „ Pulverising, 98, 105.  
 „ Sibpur, 97.  
 „ Steam, 98, 106.  
 „ Sub-soil, 76, 98, 104.  
 „ Sulky, 98, 105.  
 „ Swing, 98, 99, 102.  
 „ Three Furrow, 98.  
 „ Turnwrest, 98.  
 „ Watt's 97.  
 „ Wheel, 98, 99, 102.  
 Popat, 203, 205.  
 Popped corn, 195.  
 Poppy, 210, 218, 322—324.  
 Potash (in soil), 36—53, (manures),  
 400, 433—439.  
 Potatoes, 2, 6, 36, 76, 116, 141, 150,  
 256—260, 594.  
 Poudrette, 417, 418.  
 Poultry, 488—491.  
 Preservation of Food, 387, 388, 530—  
 581.  
 Proteids, 151—153, 421, 422.  
 Proteid Ratio, 511—515.  
 Prout's Plan, 161.  
 Pruning, 393—394.  
 Pulping, 333.  
 Pumpkins, 150, 315.
- QUARTER-ILL, 495, 572.
- RABI LAND, 39.  
 Rabies, 572.  
 Radhuni, 150.  
 Radish, 149, 150, 266—270, 271—272,  
 273.  
 Rai, 211, 214.  
 Rajgir, 202.  
 Rake, 111.  
 Rambha, 148.  
 Randhuni, 320—321.  
 Ranga Alu, 147.  
 Rape, 26, 149, 154, 193, 208, 211, 314,  
 216—217.  
 Ratoon. (*See* Sugarcane.)  
 Reana luxurians, 150, 504.  
 Red-water, 496.  
 Regur, 45, 49.  
 Reh, 71.  
 Resin, 533.  
 Retting, 232.  
 Rhea, 26, 149, 237—241.  
 Ribbons. (*See* Rhea.)  
 Rice. (*See* Paddy.)  
 Rice-husker, 138, 151—157.  
 Rinderpest, 493.  
 Roller, 78, 111, 112.  
 Root-rotter, 138.

Root-nodules, 584—587.  
 Root pulper, 138.  
 Roselle, 148, 150, 251.  
 Rotation, 161—165, 256, 265, 306, 322.  
 Round Pepper, 147, 320.  
 Rubber, 154, 350, 353.  
 Ruisa-grass, 346, 347  
 Rust, 199, 596, 597  
  
 SABAI-GRASS, 26.  
 Sada Alu, 147.  
 Safflower, 149—150, 210, 226—228.  
 Sajina, 148, 339, 387.  
 Sal-ify, 266—270.  
 Salt, 400, 444—447.  
 Saltpetre, 175, 190, 194, 409—427, 464—467.  
 Sani, 482.  
 Sank Alu, 148, 150.  
 Sansivieras, 146, 248.  
 Sapheda, 496, 571.  
 Sarson. (See Rape.)  
 Sathu, 146.  
 Scale-insects, 533, 567—568.  
 Scattering, 107.  
 Sea-Pale, 266—270  
 Seed-drills, 112, 140.  
 Seed-lac, 381—383.  
 Sericulture, 353—380.  
 Serum Simultaneous Method, 492—494.  
 Sesamum, 147, 154, 208, 216.  
 Sewage, 425.  
 Shadoof, 130—131.  
 Shama, 145, 387.  
 Shell-lac, 382.  
 Sheera, 582.  
 Shorshe, 211.  
 Shushni-sag, 150.  
 Shyala, 293.  
 Shyalkanta, 208, 210.  
 Shyalnaja, 202.  
 Silicates (in soil), 36—54.  
 Silk, 217.  
 Silk, Cotton, 148, 248.  
 Silos, 139, 507—511.  
 Silt, 418, 419.  
 Sim, 148, 535.  
 Simul, 148, 248.  
 Singhara, 149.  
 Sirajgunge Jute, 148.  
 Small-pox, 492.  
 Smut, 199, 598, 599.  
 Snake-gourd, 150.  
 Soda (in soil), 36—54.  
 Soil, 24—61, 452—457, 584—587.  
 Sola, 148.  
 Sorghum. (See Juar.)  
 Sorghum Halipense, 150, 152, 197, 503.  
 Sorguja, 40, 69, 149, 210, 216—217.  
 Soy Bean, 148, 203—214.  
 Spinach, 266—270.  
 Splitting, 107, 108.  
 Standardizing, 450—452.

Sthal Padma, 251.  
 Stoney's Water-lift, 124—125.  
 Straw (as manure), 422.  
 Subba Rao's Seesaw Water-lift, 125—126.  
 Subsoiling, 77.  
 Subsoil Ploughing, 104.  
 Subsoiler, 78, 98, 105.  
 Sucroses, 296—300.  
 Sugarcane, 26, 39, 76, 80, 141, 146, 154, 274—288, 599.  
 Sugar, 222, 225, 296—300.  
 Sugar, Beet, 299—300.  
 „ Cane, 274—288.  
 „ Date, 288—296.  
 „ Grape, 297.  
 „ Invert, 298—299.  
 „ Malt, 297.  
 Suastus grevius, 553—569.  
 Sulpa, 150, 321, 535.  
 Sultan Water-lift, 125, 139  
 Sunflower, 149, 208, 209.  
 Sunn Hemp, 64, 69, 148, 150, 231, 236—237, 281.  
 Supari, 150.  
 Sweet Potato, 270—272, 308.  
 Swing-basket, 131, 136, 138.  
 Swingle, 101.

TAMARIND, 148.  
 Tapioca, 26, 341.  
 Taramani, 149, 193, 208, 211.  
 Tarmuj, 147.  
 Tea, 150, 154, 325—330.  
 Teeperi, 147.  
 Tejpata, 150, 319.  
 Threshing, 115, 140.  
 Thysanoptera, 537.  
 Thysanura, 537.  
 Til, 40, 64, 147, 154, 211, 214, 215, 216, 246.  
 Tobacco, 2, 7, 40, 73, 141, 147, 154, 305—313.  
 Toddy Palm, 387.  
 Tomato, 147, 150, 266—270.  
 Tori, 211—212.  
 Tree-tomato, 147.  
 Trenching, 75.  
 Trichosporia, 561—563, 599.  
 Turbine, 91, 92.  
 Turmeric, 146, 150, 272—273.  
 Turnip, 39, 149, 266—270.  
 Tusser, Silk, 355—363.

UCHHE, 147.  
 Ulat Kambal, 150.  
 Ule-tree, 350—353.  
 Ulu, 145, 150.  
 Umbelliferous Spices, 149.  
 Urd, 203—208.  
 Urine, 413.  
 Usar Land, 32, 37, 69, 71, 118, 121, 444.

VACCINES, 587—592.  
 Vanilla, 160, 335—337.



- WALNUT, 210.  
Warping, 79.  
Water-analysis, 474—475.  
Water-lifts, 122—138.  
Water-nut, 149, 150.  
Water-power, 89, 92.  
Weevils, 192, 210, 555—556, 565.  
Wheat, 39, 119, 145, 149, 154, 187 -  
192.  
Wheat Soil, 190.  
White-ants, 563—565.  
Windlass, 134
- Wind-mills, 85, 86, 87, 122.  
Wind-power, 85, 86.  
Winnowers, 116.  
Winnowing, 334.
- YAMS, 150, 344.  
Yoke, 102.  
Yoke-galls, 496.  
Yucca, 146, 248.
- ZEDOARY, 146.  
Zymotic Diseases, 572—575.



## DATE OF ISSUE

This book must be returned  
within 3, 7, 14 days of its issue. A  
fine of ONE ANNA per day will  
be charged if the book is overdue

---

|  |  |
|--|--|
|  |  |
|--|--|

