

Birla Central Library

PILANI (Jaipur State)

Engg College Branch

Class No:- 669.

Book No:- C69H

Accession No:- 34193

Acc. No.....

ISSUE LABEL

Not later than the latest date stamped below.

--	--	--

PITMAN METALLURGY SERIES

FRANK T. SISCO, *Advisory Editor*

HARDENABILITY AND STEEL SELECTION

PITMAN METALLURGY SERIES

Sisco: MODERN METALLURGY FOR ENGINEERS

Lord: ALLOY SYSTEMS

Crafts and Lamont: HARDENABILITY AND STEEL SELECTION

Comstock, Urban, and Cohen: TITANIUM IN STEEL

Schwartz: FOUNDRY SCIENCE

HARDENABILITY AND STEEL SELECTION

Walter Crafts

CHIEF METALLURGIST, UNION CARBIDE AND
CARBON RESEARCH LABORATORIES, INC.

John L. Lomont

RESEARCH METALLURGIST, UNION CARBIDE
AND CARBON RESEARCH LABORATORIES, INC.

SIR ISAAC PITMAN & SONS, LTD.

LOND.

COPYRIGHT, 1949

BY

PITMAN PUBLISHING CORPORATION

All rights reserved. No part of this book
may be reproduced in any form without
the written permission of the publisher.

1.1

Associated Companies

SIR ISAAC PITMAN & SONS, LTD.

London Melbourne Johannesburg

SIR ISAAC PITMAN & SONS (CANADA), LTD.

Toronto

PRINTED IN THE UNITED STATES OF AMERICA

PREFACE

HARDENABILITY, IN THE broad sense of a quantitative understanding and control of quenching and tempering, has resulted in a greater opportunity than ever before for the rational selection and the effective heat treatment of carbon and low-alloy steels. The accelerated research and the rapid transfer to the shop of knowledge gained in the laboratory during World War II demonstrated that hardenability calculations were of much value in striving for increased economy in the use of alloying elements and for improved serviceability of parts fabricated from heat-treated steels. So rapid has been this development, however, that the information has up to now been available only in hundreds of scattered articles in many publications available to the metallurgist only after laborious research and critical review. In order to facilitate the use of this information, therefore, this book has been prepared to consolidate and summarize into a coordinated pattern the hardenability theories and calculations that are well supported by facts. The underlying principles are outlined for the student and for those engineers and executives who lack the opportunity to secure an intimate knowledge of the subject; they should also be useful for the guidance of metallurgists who must use the calculations. For those metallurgists, materials engineers, and designers who are responsible for the selection and heat treatment of steel, the whole pattern of hardenability equations, tables, and graphs is assembled for ready reference.

Hardenability calculations for the selection of steel and for the determination of proper heat treatment represent quantitative predictions of behavior for each step in the process of economically developing reliable qualities in the finished product. These separate steps involve the evaluation of quenching rates, of depth of hardening in quenching (hardenability in its restricted sense), and of softening and toughening in tempering; and also the effects of chemical composition on this evalua-

tion and on the resulting mechanical properties. The quantitative accuracy of calculations of hardenability is good enough to be exceedingly helpful and poor enough to stimulate criticism and improvement. This challenge has been met with enthusiasm by many workers, and continual revision of basic data, factors, and methods of calculation has tended to increase accuracy but, unfortunately, at the expense of clarity. In order to maintain the highest degree of utility, some otherwise acceptable modifications of the basic constants or calculations have necessarily been treated rather briefly in this book where it appeared that the benefit was not commensurate with the loss of simplicity.

Utility has been used as the principal criterion in the selection of the subject matter, and theoretical considerations have been limited to the relatively uncontroversial field where the factual confirmation is strong. This position was not taken to imply that the theories and calculations of hardenability can be considered as a closed book and treated as a mechanical function. Successful application of steel has always required and still demands a high degree of intuitive judgment and a wealth of experience. Hardenability calculations can only present a frame of reference that is useful as a guide to better and more accurate decisions. This should be emphasized most strongly with respect to the chapters dealing with the economical selection of steel and with the relation between the conventional mechanical properties and serviceability.

We wish to acknowledge our indebtedness to many friends in the industry from whom we have absorbed consciously and unconsciously ideas that are expressed in the book. Special acknowledgment is due to our colleagues who have contributed their help liberally; notably to A. B. Kinzel, President, Union Carbide and Carbon Research Laboratories, Inc., for his stimulating interest, constructive suggestions, and steadfast support; to S. M. Norwood, Vice-President, and G. K. Herzog and R. K. Kulp, of the Electro Metallurgical Division, Union Carbide and Carbon Corp., for their valuable contributions to the initial plan and for a careful review of the manuscript; to C. M. Offenbauer, Union Carbide and Carbon Research Laboratories, Inc., for continued helpful discussion and assistance; and to W. D. Forgeng, also of the Laboratories, who prepared a number of micrographs especially to illustrate structures described in the text. Appreciation is also due to Union Carbide and Carbon Research Laboratories, Inc., and to Electro Metallurgical Division, Union Carbide and Carbon Corp., for their continued support of research on hardenability over many years, as well as for their permission to write and publish this book.

The source of all the data and illustrations not obtained in the authors'

laboratory is clearly indicated in the text and by the references in the bibliography. In this connection special thanks should be accorded by us (and by all authors as well) to the American Society for Metals, American Institute of Mining and Metallurgical Engineers, American Iron and Steel Institute, The Society of Automotive Engineers, and other technical societies, and to a large number of publishers of technical books and journals for their long-continued policy of permitting the reproduction and use of data in text, tables, and charts copyrighted by them, provided reference to the original source is made. This liberal policy has been a large factor in the wide dissemination of metallurgical knowledge and is, in no small measure, responsible for the steady advance of the art and science of metallurgy in this country and in certain areas abroad.

Finally, we wish to express our appreciation to Frank T. Sisco, whose familiarity with the subject matter and whose wide experience as a technical editor were used to advantage in making the major revisions in the original manuscript that were necessary to present the subject in its present connected form.

WALTER CRAFTS
JOHN L. LAMONT

CONTENTS

PREFACE	v
CHAPTER 1. THE HARDENABILITY PATTERN	3
1.1. Recent History of the Heat Treatment of Steel	4
1.2. The Development of the Hardenability Concept	5
1.3. The Fundamental Structure of Steel as Affected by Heat Treatment	6
1.4. The Fundamental Relation between Structure and Properties.	8
1.5. Important Factors in Hardening.	9
1.6. Hardenability and Cooling Rates	10
1.7. Interpretation of Hardenability and the Importance of Tempering	11
1.8. Relation of Hardenability to Engineering Properties	12
1.9. Summary	13
CHAPTER 2. HEATING FOR HARDENING	14
2.1. Effect of Carbon on Hardening Temperature	16
2.2. Effect of Alloying Elements on Hardening Temperature	17
2.3. Effect of Rate of Heating on Formation of Austenite.	20
2.4. Austenitization of Hypoeutectoid and Hypereutectoid Steels	21
2.5. Effect of Heating Rate on Warping and Cracking.	23
2.6. Determination of Austenitic Grain Size.	23
2.7. The Importance of Grain Size	26
2.8. The Importance of Furnace Atmosphere	27
2.9. Salt Baths and Protective Coatings	28
2.10. Protective Atmospheres in Heat Treating	29
2.11. Summary	31
CHAPTER 3. THE TRANSFORMATION OF AUSTENITE	32
3.1. Studying the Transformation of Austenite by Continuous-Cooling Methods	33

3.2. Studying the Transformation of Austenite by Isothermal Methods	35
3.3. Pearlite Formed by Isothermal Transformation	38
3.4. Formation of Bainite and Martensite	40
3.5. Effect of Carbon Content and Grain Size on the Transformation of Austenite	44
3.6. General Effects of the Alloying Elements on Isothermal Transformation of Austenite	46
3.7. Transformation of Austenite to Martensite.	47
3.8. Transformation of Austenite during Continuous Cooling.	50
3.9. Summary	52
CHAPTER 4. QUENCHING	53
4.1. Methods Used for Studying the Quenching of Steel	54
4.2. Relative Cooling Rates at Surface and Center during Quenching	54
4.3. Stages in Cooling the Surface during Quenching	56
4.4. Cooling Rates with Various Quenching Mediums	57
4.5. Application of French's Method	58
4.6. Determination of the Severity of the Quench	62
4.7. Determination of Severity of Quench for Round Bars and Plates.	64
4.8. Determination of Severity of Quench from Jominy Tests	69
4.9. Application of Jominy Test and Severity of Quench to Round Bars	71
4.10. Application of the Severity of Quench from the Jominy Test to Squares, Flats, and Plates	77
4.11. Summary	78
CHAPTER 5. HARDNESS AND HARDENABILITY	84
5.1. Relation of Hardness to Structure	85
5.2. Maximum Hardness Attained by Quenching	87
5.3. Relation between Hardness and Hardenability	89
5.4. Standard Index of Hardenability—Critical Diameter and Ideal Critical Diameter.	92
5.5. Determination of Ideal Critical Diameter	96
5.6. Percentage of Martensite from Ideal Critical Diameter	98
5.7. Ideal Critical Diameter from Chemical Composition	99
5.8. Grossmann's Method of Calculating Hardenability	100
5.9. Example of Calculated Hardenability	103
5.10. The Accuracy of Calculated Hardenability.	104

5.11. Relation between Quenched Structure and Mechanical Properties	105
5.12. Effect of Boron on the Hardness Gradient after Quenching	107
5.13. Summary	109
CHAPTER 6. HARDENABILITY TEST METHODS	111
6.1. Method of Making Jominy End-Quench Hardenability Tests	113
6.2. Specifying Jominy End-Quench Hardenability.	115
6.3. Relation between Actual Cooling Rates and the End-Quench Test	116
6.4. Relation between Actual Cooling Rates in Oil and Water and the End-Quench Test	119
6.5. Relation of the Jominy Test to Severity of Quench and Critical Diameter	120
6.6. Relation of the Jominy Test to Severity of Quench and Center Hardness	121
6.7. Advantages and Disadvantages of the Jominy End-Quench Test	122
6.8. Special Hardenability Tests for Shallow-Hardening Steels	123
6.9. Special Hardenability Tests for High-Carbon Tool Steels.	125
6.10. Hardenability Test for Air-Hardening Steels	127
6.11. Summary	127
CHAPTER 7. JOMINY HARDENABILITY CONTROL	128
7.1. Calculation of the Jominy Curve from Ideal Critical Diameter	130
7.2. Example of Calculation of Jominy Curve from Ideal Critical Diameter	131
7.3. Calculation of the Jominy Curve by the Addition Method	132
7.4. Example of Calculation of Jominy Hardness by the Addition Method	135
7.5. The Development of Hardenability Bands	139
7.6. Use of Hardenability Bands for Specifying Hardenability.	143
7.7. Factors to Be Considered in the Use of the Hardenability Band	145
7.8. Summary	146
CHAPTER 8. TEMPERING AFTER HARDENING	147
8.1. Effect of Tempering on Structure	147
8.2. Relation between Tempering and the Hardness of Quenched Steel	149

8.3. General Effects of Alloying Elements on Tempered Hardness	154
8.4. Effect of Alloying Elements on Tempered Hardness in Low-Alloy Steels	156
8.5. Calculation of Tempered Hardness by Addition Method	161
8.6. Estimation of Tempered Hardness from Ideal Critical Diameter	168
8.7. Explanations of the Effect of Alloying Elements on Retardation of Softening by Tempering	171
8.8. Effect of Time on Tempered Hardness	175
8.9. Method of Using the Time-Temperature Relation in Estimating Tempered Hardness	177
8.10. Summary	181
CHAPTER 9. MECHANICAL PROPERTIES AND HARDENABILITY	183
9.1. Tensile Strength	183
9.2. Relation among Hardenability, Tensile Strength, and Tempered Hardness	186
9.3. Yield Strength and Yield Ratio	187
9.4. Hardenability and Yield Strength	190
9.5. Elongation, Reduction of Area, and Hardenability	193
9.6. Estimation of Elongation and Reduction of Area from Tensile Strength	194
9.7. Notch Toughness	198
9.8. Calculation of Izod Impact Strength by Addition Method	200
9.9. Temper Brittleness	202
9.10. Notch Toughness and Hardenability	204
9.11. Significance of Impact Properties	205
9.12. Fatigue Strength	207
9.13. Summary	208
CHAPTER 10. FACTORS IN THE SELECTION OF STEEL	210
10.1. Factors to Be Considered in the Selection of Steel	211
10.2. Properties Affecting Serviceability: Full Hardening	213
10.3. Properties Affecting Serviceability: Incomplete Hardening	214
10.4. Factors Affecting Hot Working	215
10.5. Factors Affecting Machining	216
10.6. Other Important Variables in Processing	217
10.7. General Principles for the Selection of Steel	219
10.8. Selection of a Steel of Non-Standard Composition	220

CONTENTS

xiii

10.9. Selection of a Steel of Standard Composition 224
10.10. Summary 234

APPENDICES

I. Composition Limits of H Steels 235
II. End-Quench Hardenability Bands 239
III. SAE Standard Numbering System for Wrought Steel. 247
IV. Hardness Conversion Numbers for Steel 256

BIBLIOGRAPHY 263

NAME INDEX. 271

SUBJECT INDEX 275

HARDENABILITY AND STEEL SELECTION

CHAPTER 1

THE HARDENABILITY PATTERN

THE FUNDAMENTAL operations underlying the production of a satisfactory tool or other hard and strong steel article are simple and consist of no more than heating iron containing considerable carbon to a bright red heat, cooling rapidly (*quenching*) to a temperature that will not burn the hand, and then reheating (*tempering*) to a temperature that will just char a piece of dry wood—an operation that is necessary to remove most of the brittleness caused by the rapid cooling.

Because the art of quenching and tempering is simple it has been practiced successfully for many centuries; Homer, who probably lived in the ninth century B.C., describes it in the *Odyssey* in these words: “And when a smith dips an axe or adze in chill water with a great hissing, then he would temper it, for whereby anon comes the strength of iron.” There are many other references to the superiority of heat-treated steel in the literature of the Greeks, Romans—Pliny described it in detail in 77 A.D.—and other ancient but civilized peoples.

In medieval times the art of quenching and tempering became highly developed, and the famous swordsmiths of Damascus, Spain, and Japan were thoroughly aware of the importance of complete hardening—of quenching to form a structure consisting primarily of the hard constituent martensite before tempering—although all they knew was that such a treatment produced a keen and lasting cutting edge on a blade that would not shatter in hand-to-hand combat.

Despite the slow but steady progress in the art of heat treatment

during ancient and medieval times there could, of course, be no real perfection of the art, nor could it be practiced economically on a large scale, until the underlying fundamentals regarding the effect of heat on the structure of iron and steel and the role played by carbon were understood, and this understanding did not come until late in the history of iron. In 1722 Réaumur proposed an explanation for the difference between iron and steel that seems remarkably accurate today if we substitute carbon for Réaumur's "sulphur and salts," and 60 years later Bergman in Sweden formulated an hypothesis that eventually became the keystone of the whole arch of heat treatment—that iron was allotropic and that steel differed from iron because of the carbon it contained.

Bergman's ideas about the role of carbon were shown to be correct by Davy who, in 1815, succeeded in producing steel by dissolving a diamond in molten iron. The final step in about 150 years of speculation on the inner nature of steel and why it hardened when quenched came in 1868, when Tchernoff read his classic paper at a meeting of the Imperial Russian Scientific Society.* He showed that steel cannot be hardened by quenching unless it contains considerable carbon and unless it is heated above a certain critical temperature which is nearly always in the vicinity of a cherry-red or a bright-red heat.

1.1. Recent History of the Heat Treatment of Steel

Practically everyone who is concerned with the manufacture, the processing, or the use of ferrous alloys knows that the hardening of steel is possible because iron can exist in two crystallographically different forms—*alpha*, stable between normal temperature and about 1670°F. (910°C.), and *gamma*, stable above this latter temperature—and because carbon is soluble in gamma iron but practically insoluble in the alpha allotropic form. This is a basic and highly important phenomenon in our present-day civilization, and it is probably unfortunate that until comparatively recently we knew little about the structural changes that occur when alloys of iron and carbon are heated to a temperature where gamma iron is stable and are then cooled at various rates. One of the principal factors that prevented an earlier understanding of these changes was the lack of suitable methods for studying them.

Credit for the first application of the microscope to the study of the structure of steel and other alloys is usually given to Sorby, who presented his important papers on the subject to the British Iron and Steel Institute in 1885, 1886, and 1887. Martens had been working along

*Tchernoff's paper was not published until 1876 when a translation appeared in the British journal *Engineering*.

the same line in Germany and had reported his findings to the Verein Deutscher Ingenieure some seven or eight years earlier, but his work did not attract the attention it deserved. Another important development during this period was the invention, in 1888, of the platinum/platinum-rhodium thermocouple by Le Chatelier, which made available a simple and accurate method of studying the transformations in steel and other metallic alloys.

With metallography and pyrometry available, study of the fundamentals of the constitution and heat treatment of the alloys of iron and carbon and of the effect of a large number of other elements on the iron-carbon alloys began, and in the 30 years between 1890 and 1920 more progress was made than in the 200 years previously. A large volume of experimental work was completed, and a multitude of technical papers totaling at least a thousand printed pages were presented and discussed by Howe and Sauveur in the United States, Roberts-Austen, Arnold, Rosenhain, and Hadfield in England, Le Chatelier, Osmond, and Guillet in France, Martens, Tammann, Heyn, and Ruer in Germany, Honda in Japan, and a host of others.

This work gave us the iron-carbon diagram and considerable precise information on the effect of heating and cooling on the constitution and structure of carbon and alloy steels. It told us much about what happened in quenching but practically nothing about the relation between the quenched structure and the engineering properties of the steel after it was tempered and ready for use. This is a development of the last 15 or 20 years.

1.2. The Development of the Hardenability Concept

It has been known for nearly 50 years that steels vary widely in their response to heat treatment; i.e., in their *hardenability*; for example, it is common knowledge that practically all unalloyed carbon steels and some low-alloy steels, when quenched, even drastically in cold water, as sections larger than about 1 in., would harden only at and just below the surface, while other low-alloy steels would harden completely in large sections and when cooled in oil or even in air. It has also been known vaguely for many years that the important engineering properties of steel—tensile and yield strength, elongation and reduction of area and other measures of ductility, endurance limit, impact resistance and other measures of toughness—were somehow related to the structure after heat treatment; but there were no quantitative data to show whether this relation was close or not.

Because of this varying response of the common engineering steels to heat treatment, and of the lack of definite knowledge of the relation

between structure and properties, it was natural that for many years metallurgists and engineers thought that each individual carbon and low-alloy steel had, when quenched and tempered, a unique set of properties that was an inherent characteristic of its chemical composition and heat treatment. To some extent this is qualitatively true, but the assumption fails to take into consideration that the hardenability—which is a measure of the over-all response of a particular steel to quenching and is affected by the hardening temperature and time, cooling rate, section size, grain size, and other variables in addition to the various elements making up the chemical composition—must be known if optimum properties are desired.

Another important factor that was overlooked until comparatively recently was that steels of the same hardenability, when quenched so that the structure is martensite and then tempered to the same strength, will have similar mechanical properties at least 90 per cent of the time. This means that the quenched structure is the most important variable in securing the desired properties, and the chemical composition can be varied widely, and various alloying elements or combinations of alloying elements and carbon can be used provided the structure as quenched will be as desired.

A large number of metallurgists, principally in the United States and to a lesser extent in Germany and England, have had a hand in the development of the modern concept of hardenability and the formulation of what might be called a new philosophy of the engineering properties of carbon and low-alloy steels. The work of most of the American workers in this field forms the subject matter of the chapters that follow, and their important publications are listed in the bibliography appended to this book; it is, therefore, unnecessary to name them here.

The ramifications of the work on hardenability are already far-reaching,* and there are many indications that the principles underlying hardenability and the closely related principles underlying the relation between structure and engineering properties will become even more important in the future.

1.3. The Fundamental Structure of Steel as Affected by Heat Treatment

The over-all picture of the structural changes in carbon and low-alloy steels produced by heat treatment is relatively simple, and it has been sketched quite accurately so far as the broad outline is concerned.

*Application of the principles of hardenability was largely responsible for the almost overnight development during the late war of the triple-alloy (National Emergency) steels, which were put into immediate production and use without the customarily long period of testing and preliminary trial.

When viewed from a distance the picture is a relatively coherent and meaningful whole, and the metallurgist or the engineer who wishes to use heat-treated carbon and low-alloy steels more effectively and more economically can make good use of it as it is now drawn. It is true that closer inspection reveals areas that are hazy, and that there are many details yet to be filled in; the picture will be more satisfactory when this is accomplished, but practically and pragmatically it is a good one now as the discussion in the chapters to come should show.

Steel is essentially an alloy of iron and carbon and its final properties are controlled primarily by the size and distribution of the carbide particles present. When an iron-carbon alloy is heated above 1350 to 1400°F. (730 to 760°C.)—the critical temperature—alpha iron, the allotropic form stable at and near room temperature, changes to gamma, and the carbon dissolves to form the high-temperature phase known in metallographic terminology as *austenite*. On cooling, the reverse changes occur, gamma iron changes to alpha (*ferrite*), and the carbon as iron carbide (*cementite*), which is practically insoluble in alpha iron, is rejected to form an aggregate of ferrite and cementite. The structure (and the properties) of this aggregate depends on the cooling rate, or upon composition and other variables that have an effect analogous to changing the cooling rate. The meaning of this will become clear later.

When austenite is cooled slowly from a temperature where gamma iron is stable and carbon is in solution, the gamma changes to alpha and the iron carbide is precipitated as discrete particles whose size depends upon the cooling rate and other variables. When austenite is cooled very rapidly, these changes are prevented until a temperature of about 500°F. (260°C.) or lower is reached where the gamma iron changes to an unstable strained alpha iron (tetragonal lattice) and the carbon is retained in supersaturated solution. This structure is known as *martensite*, and when it is reheated (tempered) the strained lattice changes into the stable ferrite lattice and the carbon is precipitated. Further reheating increases the size of the carbide particles, and under some conditions they may become as large as the particles formed during slow cooling.

When the austenite is cooled very rapidly to some temperature below that at which gamma iron is stable and above that at which martensite is formed, the gamma iron tends to transform and precipitate its dissolved carbon. As the temperature is lowered, this tendency or driving force increases, but at the same time the resistance of the material to change—sometimes called rigidity or viscosity—also increases. Thus, if austenite is cooled rapidly to any subcritical temperature (but above the martensite-formation temperature), the speed with which the trans-

formation occurs at this temperature and the resulting structure are dependent on a balance of these two forces. The transformation of austenite into an aggregate of ferrite and cementite (iron carbide) at any subcritical temperature and above the temperature at which martensite forms takes place by nucleation and growth—by the formation of small nuclei and the subsequent growth of these nuclei—and the process depends upon temperature, time, and other variables.

When austenite is transformed at temperatures between 1300 and about 1000°F. (705 and 540°C.), the aggregate that forms consists of ferrite and relatively coarse particles of cementite. Frequently this aggregate, which is known as *pearlite*, has a laminated appearance under the microscope. The aggregate formed at temperatures between approximately 1000°F. (540°C.) and the temperature where martensite forms consists of ferrite and very small carbide particles; it has a feathery or acicular structure and is known as *bainite*.

1.4. The Fundamental Relation between Structure and Properties

Strength, hardness, and many other properties are related directly to the size and the distribution of the carbide particles. A steel with a pearlitic structure is soft, a steel with a bainitic structure is relatively hard, and a steel whose structure is mostly martensite is very hard. The hardness (and other properties) of the pearlitic or bainitic steels varies considerably with the size and distribution of the ferrite and carbide making up either of these aggregates. Reheating a steel that has a martensitic structure produces—in addition to the stabilization of the ferrite lattice—a coagulation of the carbide and a proportional softening. It is, therefore, possible to produce the same hardness either by the direct formation of pearlite or bainite or indirectly by tempering martensite. However, and this is important, the carbides of tempered martensite are usually of favorable shape and favorable distribution, and the yield strength, ductility, and toughness of a steel are usually greater for a given hardness if the steel is processed through the intermediate martensitic step. Thus, the properties of steel depend in a large part on the degree to which martensite is produced in quenching or, to express it as the corollary, the degree to which the formation at elevated temperatures of ferrite, pearlite, or bainite is suppressed.

The suppression of premature transformation may be accomplished by quenching so fast in water or oil that there is insufficient time for even partial transformation to take place at high temperatures; the cooling speed necessary to avoid this transformation is known as the *critical cooling rate*. Heat is abstracted from the steel by cooling the surface in the quenching medium and then by conducting heat from

the inside to the surface; hence, complete cooling takes an appreciable time and becomes much slower as the size of the piece (the mass) is increased. In plain carbon steels, the high-temperature formation of pearlite cannot be suppressed entirely if the section is much over $\frac{1}{2}$ in. in diameter. In order to avoid such premature transformation at high temperatures, and to insure that martensite can be formed in larger sections that cool more slowly, the steel may be alloyed with elements such as manganese, silicon, nickel, chromium, and molybdenum. By the use of low-alloy steels it is possible to produce martensite and to obtain optimum mechanical properties in section sizes that are relatively large.

Alloying elements suppress the high-temperature transformation to varying degrees, but their effects are not interdependent and for many of them one may be substituted for another to achieve the same effect on the critical cooling rate. They do, however, have individual effects on unhardened or partially hardened steels, and this may influence the conventional mechanical properties and the machinability and other secondary characteristics as well. Alloys also increase the resistance of steel to tempering, so that it has been necessary to consider the tempering behavior in order to provide a formula for evaluating the actual properties as well as the relative quality of different alloy steels.

1.5. Important Factors in Hardening

Early workers established the basic character of steel and worked out the iron-carbon equilibrium diagram. Equilibrium conditions as shown by this diagram are of the greatest practical interest in heating for hardening. Except in special cases, it is the aim of the heat treater to produce homogeneous austenite on heating, as the success of hardening depends primarily on the solution of carbon in the austenite and on its uniform distribution by diffusion.

The reactions involved in hardening are controlled primarily by factors shown schematically in Fig. 1.1. The cooling rate, chemical composition, and other variables determine the temperature and the rate of austenite transformation, the resulting degree of hardening—in other words, the amount of martensite formed—and the ability to develop strength and toughness; and for an understanding of these variables an understanding of the mechanism of austenite transformation is important. Although recent emphasis on hardenability has tended to emphasize only the distinction between martensitic and non-martensitic structures in hardened steel, the formation and character of the non-martensitic constituents are of great practical significance. In the final heat treatment it may be desirable to produce 100 per cent martensite during quenching in order to develop the most favorable

combination of mechanical properties, but this objective is not attained in a large number of cases. The resulting non-martensitic constituents may be harmful, and it may be necessary to anticipate and control their formation. Knowledge of the transformation of austenite at elevated temperatures has been greatly advanced by the isothermal techniques of

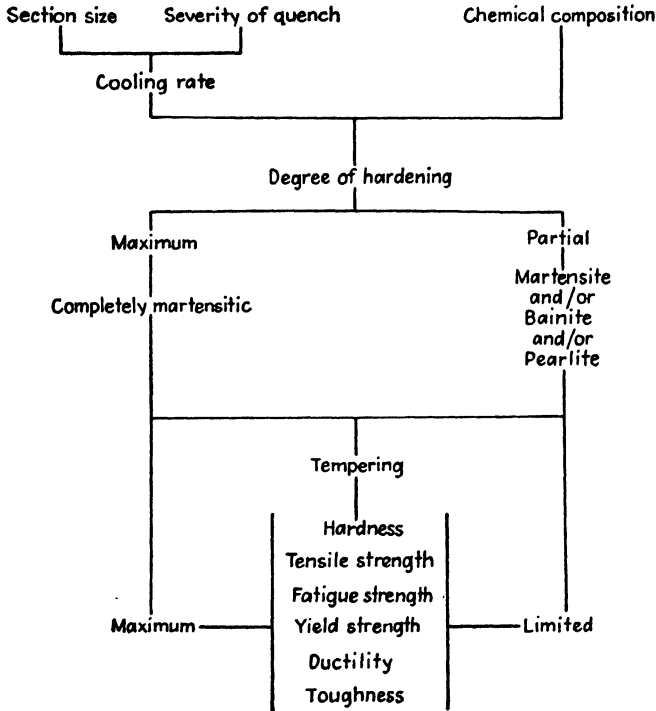

FIG. 1.1. Schematic representation of factors to be considered in the heat treatment of carbon and low-alloy steels.

Davenport and Bain and by the study of martensite formation by Greninger and Troiano. Although efforts to integrate isothermal transformation into terms of continuous cooling have had little quantitative success, the qualitative understanding is of considerable practical as well as theoretical value.

1.6. Hardenability and Cooling Rates

Evaluation of hardening capacity in quenching requires the quantitative interpretation of cooling rate.* This unwieldy problem has been

*Hardening capacity, as discussed in this section, refers to the amount of martensite formed rather than to the numerical value of the hardness that is attained.

simplified by the assumption that a grain of steel transforms in a certain manner when cooled at a certain rate regardless of whether it is at the surface or center of a large or small piece of steel or regardless of whether the steel is cooled in air, oil, or water. With this assumption it is possible to use a simple criterion of cooling rate, such as the rate at any convenient temperature or the time to cool to halfway between the initial and final temperature. Quenching rates have been measured by French and others and have been used to establish their relation to the size and shape of the quenched article. Russell, and Grossmann, Asimow, and Urban have also developed parameters for severity of the quench based on the theory that the rate of heat abstraction depends on the temperature difference between surface and interior. The theory is useful as it permits the conception of a standard or *ideal quench* to which any other severity of quench can be related.

Grossmann, Asimow, and Urban added to this conception a standard or "critical" degree of hardening of the steel in order to evaluate the relative behavior of steels under different cooling conditions and of steels of different compositions. This conception of an *ideal critical diameter* gave a standard condition by which steels could be compared and their susceptibility to hardening (hardenability) expressed by a standard term having a fixed significance. Grossmann also compared steels of different composition and found that hardenability could be calculated by multiplying together factors for grain size, carbon content, and alloy composition. This made it possible to predict at least approximately the hardenability of a steel from its chemical composition. Other dependent relations have since been established so that it is possible to calculate the percentage of martensite and the hardness of quenched steel.

1.7. Interpretation of Hardenability and the Importance of Tempering

For optimum mechanical properties it is necessary that a steel be deep hardening; i.e., that it can be quenched to a wholly martensitic structural condition throughout before tempering. The required hardenability has been evaluated in terms of the amount of martensite in the steel, or by the hardness gradients across the diameter. Shallow-hardening steels are desirable in certain cases, however, in order to utilize the resulting compressive surface stress that tends to neutralize the applied service stress.

Practical utilization of the relations between cooling rate, mass effect, and hardenability requires a testing procedure that is reproducible from day to day and by different workers. Several standardized hardenability-test methods have been developed of which the most versatile

and generally accepted is the Jominy test devised by Jominy and Boegehold. The test consists of water quenching the end of a 1-in. diameter specimen under controlled conditions and measuring hardness at various distances from the water-quenched end so that the hardness is determined for a wide range of definite cooling rates. The cooling rate and corresponding ideal critical diameter have been established so that by means of the Jominy test it is possible to study and control hardenability readily. Methods have been developed by Field and by Crafts and Lamont for calculating the Jominy hardness from chemical analysis. Because the Jominy test is cheap and accurate it has been responsible for many advances toward understanding and controlling hardenability. The test has been used as a basis for specifying hardenability, and hardenability bands for common alloy steels have been developed for specification purposes.

The last operation in heat treatment is the tempering of hardened steel in order to develop the potential quality that was introduced by the quench and to relieve brittleness which is inherent in freshly formed martensite. The mechanism of tempering is complex and not too well understood, but convenient formulas for calculating tempered hardness have been developed by Wellauer and by Crafts and Lamont. These methods together with the tempering-time coefficient determined by Hollomon and Jaffe make it possible to predict the approximate hardness of quenched and tempered steel.

1.8. Relation of Hardenability to Engineering Properties

Methods for estimation of the strength-dependent quality properties such as fatigue strength, yield strength, ductility, and toughness have been worked out and have been correlated with structure. Janitzky found that hardened and tempered alloy steels of different types have similar properties when they are fully hardened and tempered to the same hardness. The effect of incomplete hardening in the quench has been estimated roughly for yield strength and ductility and an evaluation of the effect on impact strength has been determined by Crafts and Lamont. It is, therefore, possible to calculate not only hardness and tensile strength but also the other properties that are important in controlling the suitability of steel for successful service. Although the calculations are simple and their sequence is obvious some confusion arises from the number of methods by which the same end point may be reached. Since the calculations are based on similar simplifying assumptions and statistical behavior there is little real difference between the different methods. Selection of an alternative method is usually dependent on its adaptability to the specific problem.

The relations just outlined may be applied to the selection and heat treatment of a steel to a certain hardness by way of a controlled proportion of martensite in the quenched condition. The degree of hardening in quenching and the final tempered hardness determine the primary qualities that are necessary to make a steel serviceable, so that any composition that will harden adequately in quenching and retain enough hardness after tempering could be chosen for a specific application. In practice, however, the problems and costs of processing and heat treating restrict the selection. These processing factors are much more difficult to evaluate and only some of the outstanding characteristics are described in this book.

1.9. Summary

The major recent developments in the art of heat treating steel are summarized in this chapter and are coordinated in the following chapters so that the information now available may be utilized more readily. Much has been omitted, much is over-simplified, but the evaluation of hardenability in recent years is sufficiently accurate to be a great forward step in the heat treatment and economical use of alloy steel. The gamut of calculable factors is now sufficiently complete to have practical value and provides a standard basis for comparison by which it is possible to improve the selection of steel and control its heat treatment. It is hoped that this discussion of methods for calculating the response to heat treatment will facilitate the rational and economical application of alloy steel.

CHAPTER 2

HEATING FOR HARDENING

THE FIRST STAGE IN hardening a steel consists of heating it to the proper temperature and then holding at this temperature until the desired structural changes have taken place. This is a concise statement of an operation that may be comparatively simple and performed by a blacksmith with a small forge fire, or it may be very complicated, involving the use of automatically regulated fuel or electric furnaces containing controlled gaseous atmospheres, or baths of special molten salts, together with accurate pyrometers to measure the temperatures; and considerable knowledge of metallurgy may be necessary to carry it on successfully.

To produce a satisfactory chisel the blacksmith takes a short section of a hexagonal or octagonal bar of 0.6 per cent carbon steel, puts it in his fire, packs charcoal around it, and heats it until the end becomes cherry red. He maintains this condition for a few minutes and then quenches the point in water. This is followed immediately by tempering in which the smith allows the heat from the shank to flow into the point; when this is the correct shade of blue he quenches the whole tool in water.

At the other extreme a complicated, expensive, and carefully machined gear or shaft will be heated in a hydrocarbon atmosphere adjusted so that it is neither decarburizing nor carburizing, to a temperature that is just high enough to form a homogeneous austenite but not so high that excessive grain growth will take place. In such a carefully con-

trolled operation it is necessary to know the grain-growth tendency of the steel, what carbides are present and how rapidly they dissolve and diffuse at various high temperatures, and finally how complete the solution of these carbides must be for the application involved. When the

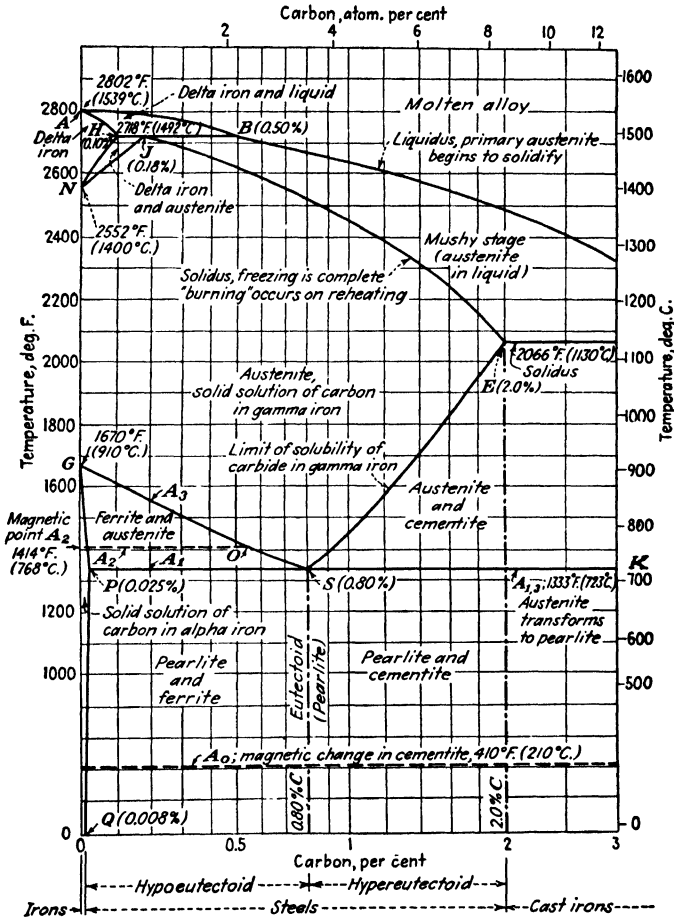

FIG. 2.1. Portion of the iron/iron carbide equilibrium diagram. (*Metals Handbook*.)⁵

steel is properly austenitized it is quenched, usually in a special oil, and then tempered carefully according to the procedure that will produce the desired properties for that particular steel.

Whether the heating procedure is the one used by the blacksmith or the one specified by the metallurgist, or whether it is more precise than

the one or not so carefully controlled as the other depends upon the composition and the cost of the steel, on what sort of service the finished part must withstand, and above all on how much has been spent in fabricating it, i.e., on how much money would be lost if the heat treatment were improperly done. In general most carbon steels and practically all low-alloy steels should be, and are, carefully heat treated, and the variables that should be controlled during the heating and the holding at the hardening temperature are the subject of this chapter.

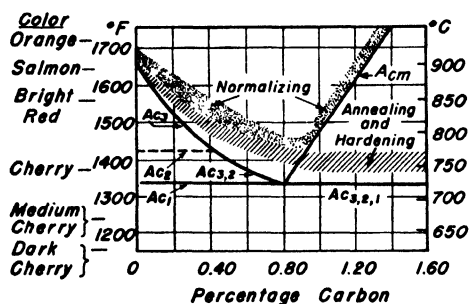

FIG. 2.2. Recommended temperature ranges for the heat treatment of carbon steels. (*Metals Handbook*.)⁵

(ferrite) dissolves less than 0.01 per cent carbon at room temperature, while gamma iron (austenite) may dissolve over 1 per cent at high temperatures. It is this difference in the solid solubility of carbon that makes hardening possible, for when austenite is transformed to ferrite on cooling, the carbon in the austenite solid solution becomes insoluble in the ferrite and is rejected as a carbide. Consequently, proper hardening technique requires that the steel is heated above the transformation temperature and held at this temperature sufficiently long to insure a homogeneous austenite.

2.1. Effect of Carbon on Hardening Temperature

The temperature at which steel transforms from ferrite to austenite on heating is not the same for all steels but is influenced by carbon and by alloying elements as well as by the rate of heating and prior structure.

Transformation from ferrite to austenite occurs at a single temperature, 1670°F. (910°C.) in pure iron, and the gamma allotropic form is maintained up to a temperature of 2550°F. (1400°C.). The addition of carbon causes the transformation to extend over a range of temperatures. Between the limits A_1 and A_3 (Fig. 2.1) and with less than 0.8 per cent carbon—the hypoeutectoid steels—austenite and ferrite coexist; and

It was noted in the previous chapter that when alpha iron is heated to a certain critical temperature it changes to gamma iron, and that carbon is soluble in the high-temperature gamma-iron lattice—forming austenite—but not in the low-temperature ferrite. This transformation is reversed on cooling so that austenite changes to ferrite and carbide. Alpha iron

between the limits A_1 and A_{cm} and with more than 0.8 per cent carbon—the hypereutectoid steels—austenite and carbide coexist. At the eutectoid composition of 0.8 per cent carbon transformation occurs at a single temperature. Since incomplete absorption in austenite of excess (proeutectoid) ferrite or carbide reduces the capacity of the steel to harden, it is usually desirable to exceed the A_3 or A_{cm} temperature in heating for hardening. There are some exceptions to this rule, which are encountered principally in high-carbon steels.

The usual hardening (and annealing and normalizing) temperatures for carbon steels are shown in Fig. 2.2.

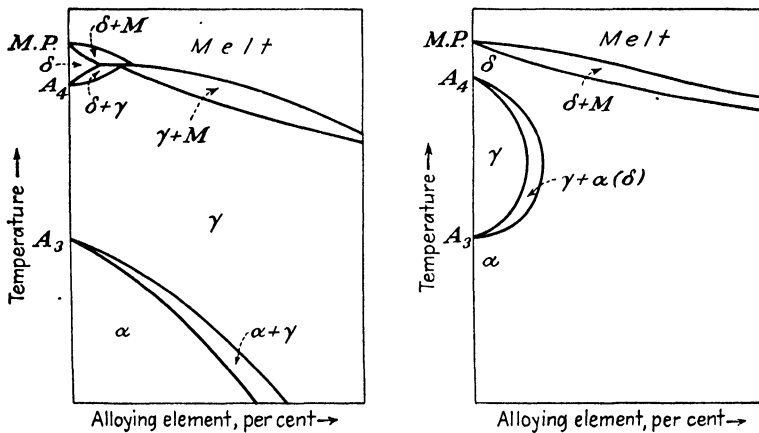

FIG. 2.3. Principal types of iron-alloy equilibrium diagrams. (Bain,¹⁹ after Wever.)

2.2. Effect of Alloying Elements on Hardening Temperature

Alloying elements affect the transformation of iron and iron-carbon alloys primarily by raising or lowering the critical-temperature range. In general, the action of these elements on the transformation characteristics of iron can be illustrated by two typical diagrams as shown in Fig. 2.3.

Manganese and nickel widen the temperature range for stable austenite chiefly by depressing the temperature at which austenite transforms to ferrite and carbide, and their effect is illustrated by the diagram on the left. The tendency of silicon, chromium, tungsten, molybdenum, vanadium, and aluminum is represented by the diagram on the right; it is to restrict the temperature and composition range for stable austenite so that the austenite field is completely enclosed to form the so-called "gamma loop." Chromium is somewhat of a special

case. In alloys containing no carbon, chromium up to about 7 or 8 per cent lowers the transformation temperature slightly, while larger amounts raise the temperature and a loop is formed. In low-carbon iron alloys the limit of the austenite field—the right limit of the loop—is reached at about 2 per cent silicon, 12 per cent chromium, 3 per cent

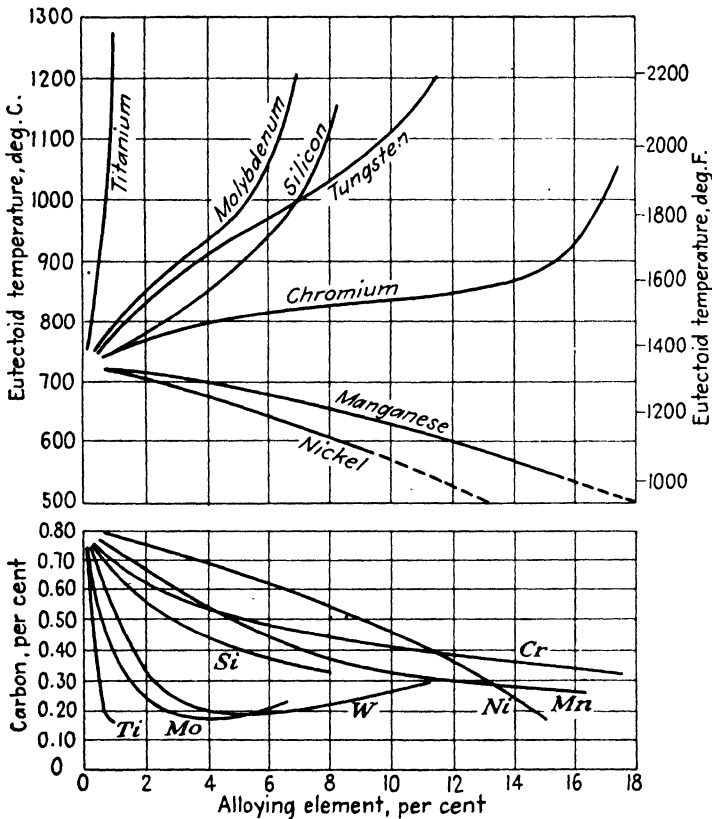

FIG. 2.4. Effect of alloying elements on eutectoid composition and temperature. (Bain.)¹⁹

molybdenum, 6 per cent tungsten, 1 per cent vanadium, or 1 per cent aluminum.

Alloying elements influence the transformation characteristics of iron-carbon alloys in much the same manner as they affect the transformation of iron. They change the eutectoid composition (point *S*, Fig. 2.1) of iron-carbon alloys as well as the eutectoid temperature by the amounts shown in Fig. 2.4. Thus, the solubility of carbon is lower in the austenite of moderately high alloy steels than in plain iron-carbon

alloys. Furthermore, in high-alloy low- and medium-carbon steels, such as 12 to 15 per cent chromium stainless steel, the austenite field is limited by ferrite, and relatively high heating temperatures are necessary to convert all of the ferrite to austenite.

There seems to have been no systematic study of the effects produced by adding two or more alloying elements to carbon steels. However,

TABLE 2.1. Normalizing and Austenitizing Temperatures* for Common Carbon and Low-Alloy Steels†

Specified carbon percentage‡	Normalizing temperature		Austenitizing temperature	
	°F.	°C.	°F.	°C.
Steel series 1000, 1300, 3100, 3200, 4000, 4100, 4300, 4600, 5000, 5100, 8600, 8700, 9400, 9700, 9800, 9900				
Up to 0.25	1700	925	1700	925
0.26 to 0.36	1650	900	1600	870
0.37 and over	1600	870	1550	845
Steel series 2300, 2500, 3300, 4800, and 9200				
Up to 0.25	1700	925	1550	845
0.26 to 0.36	1650	900	1500	815
0.37 and over	1600	870	1475	800
0.50 and over (9200)	1650	900	1600	870

*A variation of $\pm 10^\circ\text{F}$. from the temperatures given is permissible.

†Society of Automotive Engineers.¹³⁴

‡Detailed compositions of the SAE constructional alloy steels are given in Appendix III.

their effects on transformation temperatures seem to be largely additive in character. Because of the absence of information on the complex alloys of iron it is usually desirable to determine the transformation characteristics of each type of steel that is to be heat treated if such information is not already available. Although a knowledge of the lower critical temperature (line *PSK*, Fig. 2.1) is important for some purposes, it is essential that the upper critical temperature (line *GOS* and in some cases line *SE*, Fig. 2.1) is exceeded for effective hardening (see Fig. 2.2). The transformation characteristics of many of the common heat-treating grades of steels have been determined, and heating temperatures recommended by The Society of Automotive Engineers^{134*}

*Superior numbers refer to the Bibliography at the end of the book.

are shown in Table 2.1. Steels of the SAE 6100 series, which contain vanadium, are normalized and austenitized at temperatures about 50°F. (30°C.) higher than those shown in Table 2.1, owing to the difficulty of dissolving the carbides that may be present in these materials.

2.3. Effect of Rate of Heating on Formation of Austenite

Heating for hardening is carried on in furnaces that are heated by electricity, gas, or oil, in which heating is accomplished chiefly by radia-

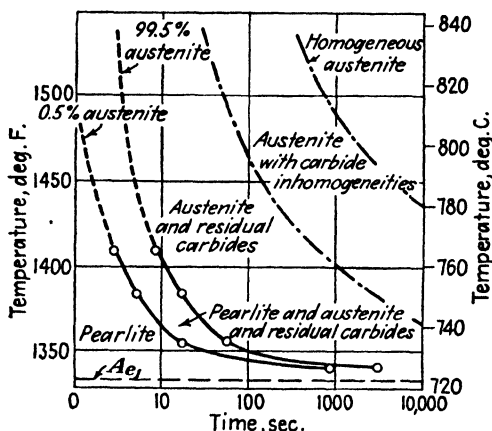

FIG. 2.5. Time-temperature isothermal diagram for austenitizing an eutectoid steel. Initial structure, normalized fine pearlite. (Roberts and Mehl.)¹¹⁸

tion; in salt baths or lead pots, in which heating is by conduction; and in high-frequency induction coils, where heating is by induction. The rates of heating are quite different, those of the electric and gas furnaces being generally lower than the heating rate of the salt bath or high-frequency induction furnace. Extremely fast rates of heating may be obtained by the last-mentioned method, although, except for light sections, the method is generally limited to surface heating in applications requiring a hard surface and a soft core. The oxyacetylene flame is also used for similar purposes.

Absorption of ferrite or carbide in austenite is a reaction that requires a significant time and that proceeds faster as the temperature is raised. Some idea of the time-temperature relation is given in Fig. 2.5.

The effect of insufficient time for solution of carbides on the hardenability of 1 per cent carbon, 1.5 per cent chromium steel (SAE 52100) is shown by Fig. 2.6. It will be noted that the maximum hardness, as well as the depth of hardening, increases with time at temperature and

that the effect is more evident with a relatively coarse initial structure (in this case, spheroidized). The rate of solution of carbides was found by Roberts and Mehl¹¹⁸ to be proportional to the carbide-ferrite interfacial area. Thus, fine carbides dissolve more rapidly than coarse carbides at the hardening temperature, and those of lamellar shape are more readily soluble than the spheroidal type. It is sometimes advantageous to avoid complete solution of carbides in high-carbon steels by not heating over the limit of carbide solubility in order to preserve fine

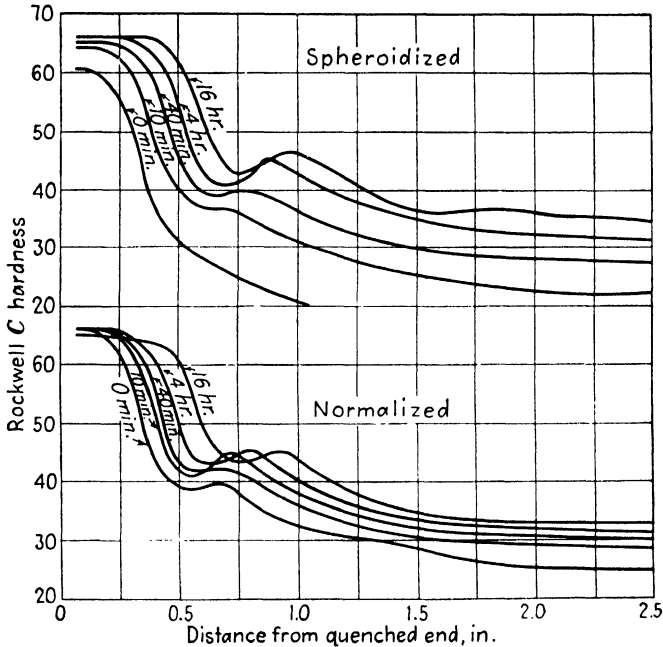

FIG. 2.6. Effect on Jominy hardenability of insufficient time to permit full carbide solubility in austenite. (Rowland, Welchner, and Marshall.)¹²¹

grain size and freedom from residual austenite, which may remain untransformed to martensite on quenching. The presence of strong carbide-forming elements such as chromium, vanadium, and titanium makes the use of this practice recommendable in some cases.

2.4. Austenitization of Hypoeutectoid and Hypereutectoid Steels

In low- and medium-carbon (hypoeutectoid) steels, carbides are dissolved first to form the initial austenite pools, and ferrite is absorbed last. This tendency may persist to fairly high temperatures in "abnormal" steels in which ferrite may not be absorbed completely. The required

diffusion of carbon and alloying elements is affected by the initial condition as indicated by the results of hardenability tests shown in Fig. 2.7. On account of the different structural conditions in which steel may be received it is sometimes desirable to give the steel a preliminary treatment prior to hardening in order to promote rapid diffusion. In the

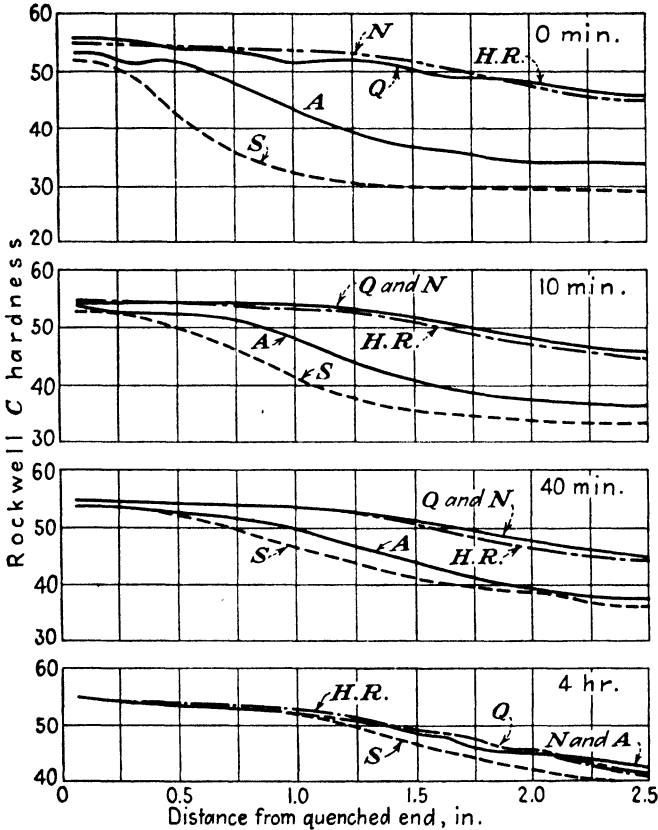

FIG. 2.7. Influence of initial structure and time at 1550°F. (845°C.) on Jominy hardenability characteristics of SAE 4340. (H.R.=hot rolled, N=normalized, A=annealed, S=spheroidized, Q=quenched.) (Welchmer, Rowland, and Ubben.)¹²⁷

study and control of hardenability, it is the customary practice to give heat-treating steels a preliminary normalizing at a temperature at least as high as, or preferably some 50°F. (30°C.) higher than, is used in heating for hardening.

After complete solution of the ferrite or the carbides is attained, there must still be time allowed for further diffusion to produce a homogeneous austenite. An extreme case of non-uniformity may be seen in the

pseudomorphs of pearlite in induction-hardened steel.⁴⁵ The old rule of heating the steel in the furnace for one hour per inch of thickness does not mean a great deal because ordinarily only the time above the critical temperature is significant, but it is usually representative of a conservative practice. Similarly, the practice of heating to 75 or 100°F. (40 to 60°C.) above the critical range is desirable provided there is no danger of grain coarsening. The classic procedure for determining suitable quenching temperatures for constructional steels as well as for tool steels was to quench specimens from graduated temperatures, break them, and select the quenching temperature producing the finest grain size as the best for that particular steel. Quenching temperatures might also be determined by hardenability tests.

2.5. Effect of Heating Rate on Warping and Cracking

In addition to having an effect on transformation temperature the rate of heating is also important in determining the condition of the steel after hardening has been completed. If heating rates are so great that the steel is not heated uniformly, either as a result of the heating operation or as a result of improper location within a furnace, warping or cracking may occur. Generally, warping that takes place during heating is retained after the quenching and tempering operations, and it is probable that in many instances warpage considered to be due to quenching actually occurred during heating. Warping is usually caused by impinging flames or by placing articles on hot furnace bottoms, so that rapid heating takes place in one spot. Conditions that produce warping may also produce cracking in pieces that have been previously hardened. Practical experience has indicated that high-alloy steels and heavy sections such as die blocks should be heated uniformly at very slow rates if cracking is to be avoided in the subsequent quenching. In such cases it is often desirable to put the material in a cold furnace and raise the temperature slowly to the quenching temperature. In cases of light and medium sections of such material as tool steels and die steels, it is helpful to preheat to an intermediate temperature before transferring to a furnace at the austenitizing temperature.

2.6. Determination of Austenitic Grain Size

The austenitic grain size has a marked effect on the behavior in hardening and on the final properties of the steel. Grain size may be measured in several ways; it is usually determined by microscopic examination and expressed as the A.S.T.M. grain number.⁶ A No. 1 grain size represents one grain per square inch at a magnification of 100 diameters, No. 2 two grains, No. 3 four grains, No. 4 eight grains, No. 5

sixteen grains, and so on to No. 8, 128 grains per sq. in. Typical examples of steels with grain sizes 2, 5, and 8, respectively, are shown in Fig. 2.8. The dividing line between coarse- and fine-grained steel is usually taken as A.S.T.M. No. 5.

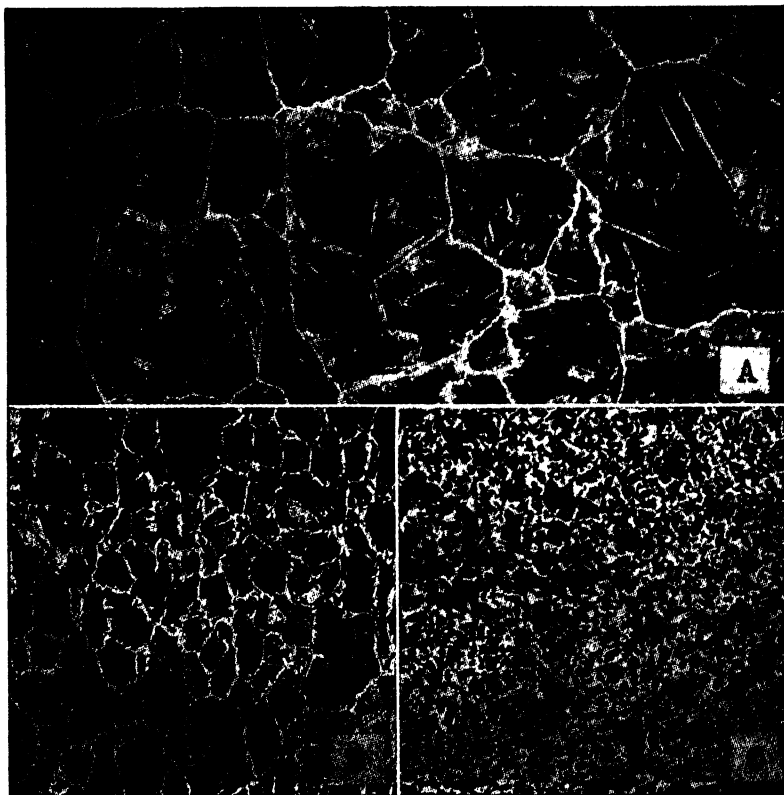

FIG. 2.8. Typical structure of slowly cooled carbon steel having (A) grain size 2; (B) grain size 5; and (C) grain size 8. Etched; 100 \times . (*Sisco*).¹³²

The fracture of a hardened specimen has also long been used for determining grain size which is then evaluated by comparison with a graduated series of standard fractures. Another method (McQuaid-Ehn test⁶) is to outline the grain boundaries, as shown in Fig. 2.9, by carburizing for 8 hr. at 1700°F. (925°C.) or by decarburizing in a furnace or salt bath.¹³⁵ The McQuaid-Ehn test has been used principally on carburizing steels where it has the advantage that it closely approximates the actual carburizing cycle, and it also reveals characteristics of

specific interest for carburizing such as the type of case and tendency toward abnormality. For medium-carbon steels that are not to be carburized, the McQuaid-Ehn test has the disadvantage that it must be carried out at a higher temperature and for a longer time than the

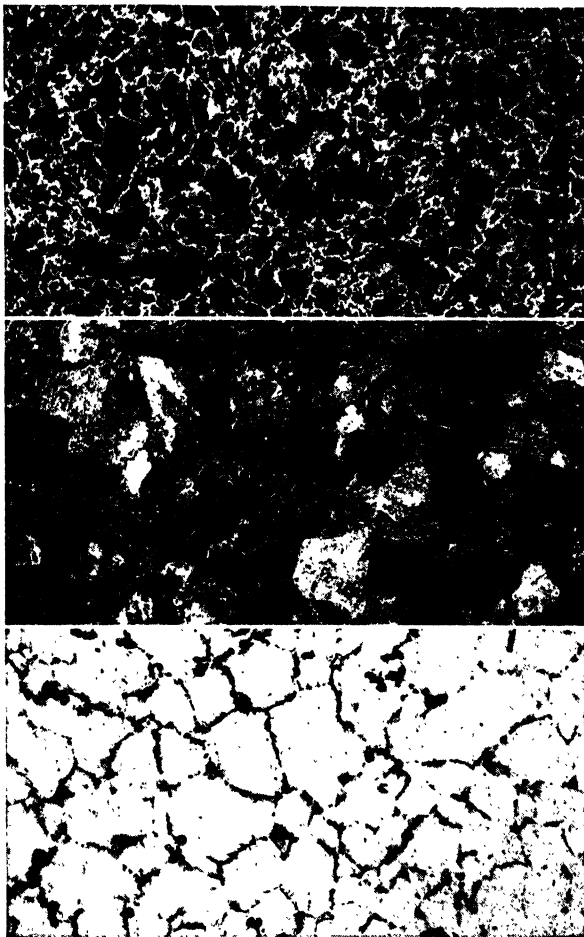

FIG. 2.9. Austenitic grain size determined by: carburizing (top); Vilella's martensite reagent (center); and gradient quenching (bottom). 100 \times . (*Forgeng.*)

actual hardening treatment in order to produce a visible carbide network. Recent practice, therefore, has favored microscopic examination after a typical hardening treatment. The microscopic examination is difficult if the specimen is wholly martensitic, although Vilella¹³⁶ has developed a special etching reagent for the purpose, as shown in Fig. 2.9. Vilella's

reagent is made up of 95 cu. cm. ethyl alcohol, 1 gram of picric acid, and 5 cu. cm. of concentrated hydrochloric acid. It is much easier to secure satisfactory results with this reagent if there is some ferrite or pearlite at the martensitic grain boundaries, and slower cooling, interrupted quenching, or gradient quenching (Jominy test) is usually employed. Grain size determined in this manner on martensitic or ferritic structures is designated as "actual" grain size to differentiate it from the grain size revealed by less direct methods.

2.7. The Importance of Grain Size

As steel is heated through the critical range it is recrystallized with the formation of fine grains. These grains tend to grow as the tempera-

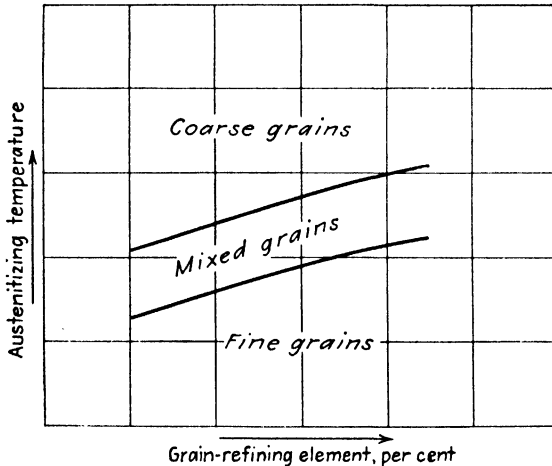

FIG. 2.10. Schematic representation of the effect of temperature and grain-refining elements on grain size.

ture is raised, but the growth is more or less abrupt at a characteristic temperature—with the formation of first some coarse and some fine grains and finally all coarse grains, as indicated by Fig. 2.10. Prolonged heating also tends to increase the grain size.

Each steel has a characteristic coarsening-temperature range and if that temperature is below the maximum commonly used for hardening, say 1700°F. (925°C.), the steel is classed as coarse grained. If the steel is treated with effective amounts of aluminum, zirconium, titanium, or vanadium, it does not coarsen at the usual hardening temperatures and is classed as fine grained.

Coarse-grained steels (grain No. 1-5) have some advantages in easier

machining, higher creep strength at elevated temperatures, greater hardenability, and possibly less notch sensitivity in fatigue, but they have lower notched-bar impact strength and the impact resistance falls off rapidly at subnormal temperatures. Their principal application is in unhardened sections such as crankshafts, heavy forgings, and free-machining steel. Fine-grained steels (grain No. 5-8 plus) have much better toughness, and virtually all heat-treating alloy steels used in machine construction are treated during melting so that they will be fine grained. Steels that develop a mixture of coarse and fine grains tend to give erratic properties, warp in heat treatment, and are usually not used.

The grain-coarsening temperature of fine-grained steels varies somewhat but can be expected to be in the neighborhood of 1800°F. (980°C.) for aluminum-treated steel, 1700°F. (925°C.) for zirconium-treated, 1800°F. (980°C.) for titanium-treated, and 1750°F. (955°C.) for vanadium-treated steel. These temperatures may, however, vary widely with the composition and prior treatment. The coarsening temperature of high-carbon steels tends to be relatively low but grain growth may be restrained by undissolved carbides.¹³⁹ Vanadium is particularly effective for this purpose in both carbon and low-alloy steels. High manganese (up to about 2.0 per cent) tends to lower the grain-coarsening temperature, while high silicon (up to about 1.0 per cent) intensifies the effect of the grain-refining agents. Generally, higher coarsening temperatures are desirable in order to permit retention of a fine grain size with normal hardening procedures, but coarse grain size is sometimes desired in order to develop structures favorable for easy machinability. Vanadium steels are frequently processed by heating to a moderately high temperature, say 1750°F. (955°C.), to develop coarse grains for machinability; they are then hardened at a lower temperature with the formation of a desirable fine grain size in the finished product. Under some conditions, zirconium-treated steels could be similarly treated, but steels treated with aluminum and titanium tend to coarsen at higher temperatures so that such a double treatment is not convenient or economic. The short time used in induction heating involves very high maximum temperatures and no commercially available grain-refining treatment is capable of retarding grain growth at those temperatures.

2.8. The Importance of Furnace Atmosphere

During heating for hardening, the steel is generally surrounded by an atmosphere that contains appreciable quantities of oxygen, carbon monoxide, carbon dioxide, water vapor, and occasionally other reactive gases, which, unless precautions are taken, may react with the metal

and cause oxidation, decarburization, carburization, or roughening of the surface. As these reactions influence the final appearance and hardness of the finished product, it is customary to protect the surface of the metal or to control the atmosphere so that these reactions will not occur. In some cases, such as tempering at low temperatures and very rapid heating by electric induction or direct resistance, heating may be carried out in a normal atmosphere without excessive oxidation or decarburization.

Undetected decarburization caused by heat treatment in an oxidizing atmosphere has in the past been responsible for many failures of steel parts. This is due primarily to the fact that usually the decarburized surface layer has properties that are inferior to the properties of the remainder of the section. Many examples of this could be cited, but one will suffice. Boegehold^{20, 21} found that an automobile spring treated to about 450 Brinell hardness to withstand a maximum torsional stress of 115,000 lb. per sq. in. had a torsional strength at the decarburized surface of only 30,000 lb. per sq. in. In service, cracks formed at the surface and were propagated through the sound core causing premature failure. Either machining or grinding after heat treatment, or the use of a protective atmosphere is necessary to prevent such failure.

If the condition of the atmosphere is such that decarburization has taken place, as in air or uncontrolled combustion gases, and it is desired to remove the decarburized surface, the usual machining allowances, according to Johnson,⁸⁶ are as follows:

<i>Diameter of Section</i>	<i>Machining Allowance</i>
1 in. and under	$\frac{1}{2}$ in.
1-in. to 2-in. diameter	$\frac{1}{8}$ in.
2-in. to 3-in. diameter	$\frac{1}{8}$ in.
3-in. to 4½-in. diameter	$\frac{1}{4}$ in.
4½-in. to 6-in. diameter	$\frac{3}{8}$ in.

Greater decarburization in the heavier sections results from the longer exposure at temperature. In making Jominy tests it is recommended¹²⁴ that $\frac{1}{8}$ in. be removed after normalizing and before hardening to insure against decarburization and low hardness readings.

2.9. Salt Baths and Protective Coatings

The use of molten salt baths for heating and heat-treating operations is one means of protecting the metal surface, since immersion in the molten salt eliminates the atmosphere. However, unless care is taken in the choice of salts, the surface of the metal may be damaged as salts may be oxidizing, reducing, or neutral. Neutral baths are generally

used but differ in composition according to the temperature ranges in which they are employed.¹²⁰ For tempering and interrupted quenching in the temperature range of 300 to 1000°F. (150 to 540°C.) the salts are usually nitrates and nitrites of sodium and potassium. Care must be taken if the work has been previously treated in a cyanide bath as the cyanide may react rapidly or even explosively with the nitrate-nitrite bath components. Care must also be taken not to overheat the bath as the salt may attack the steel or the container. In the temperature range of 1150 to 1650°F. (620 to 900°C.), used for normalizing, hardening, annealing, and tempering, neutral salts are composed of chlorides or carbonates of potassium, sodium, calcium, and barium. As carbonates tend to decarburize steel, the preferred compositions are mixtures of potassium and sodium chloride. Sodium cyanide is sometimes added to the chloride-carbonate bath to minimize decarburization. While the chloride baths are neutral, they may with use become decarburizing, and a rectifier, usually a compound containing boron such as borax glass and boric acid, is used to restore the bath to the neutral condition. In the temperature range of 1750 to 2350°F. (955 to 1290°C.), used in the hardening of high-speed steel and the heat treating of stainless steel, the salt composition may be one of three general types: (1) boric acid and borax, (2) calcium, barium, strontium, or other silicates, or (3) calcium, barium, or sodium fluoride and barium chloride. The borax type tends to dissolve iron, while the glasslike silicates are sometimes difficult to remove from the surface after quenching.

Protective coatings such as borax, lithium compounds, metal paints, or electroplating may in special cases be applied to the surface for protection.

2.10. Protective Atmospheres in Heat Treating

Special atmospheres of inert gases such as purified argon and helium may be used in containers sealed against air infiltration. Ordinary tank nitrogen contains some oxygen, and tank hydrogen contains moisture and even when dried has a decarburizing tendency. A local protective atmosphere may be developed around the work by packing in cast-iron chips, spent carburizing compound, or charcoal. Except for salt baths, which are being used in many applications, the use of the methods described in the foregoing is usually limited to small volumes of work and to special cases. Although cracked ammonia gas is sometimes used, the bulk of heat treatment in protective atmospheres is carried out in a mixture of gases resulting from the partial combustion of hydrocarbon gases such as coke oven, natural, propane, or butane gas. Mixtures containing approximately 93 per cent nitrogen and 7 per cent

hydrogen are used effectively for bright-annealing and are virtually free from the explosion hazard.

Because the partial combustion of the hydrocarbon gases results in the formation of water vapor in fairly large quantities, it is not practical to heat the metal directly in the gases at the time of combustion if reactions with the metal are to be avoided; the protective gases when combustion occurs must be in a self-contained unit provided with some means of eliminating the moisture. The heat source, if a gaseous fuel is used, must also be separated from the furnace atmosphere by some means such as a muffle. In electrically heated furnaces the heat source and protective atmosphere do not have to be separated.

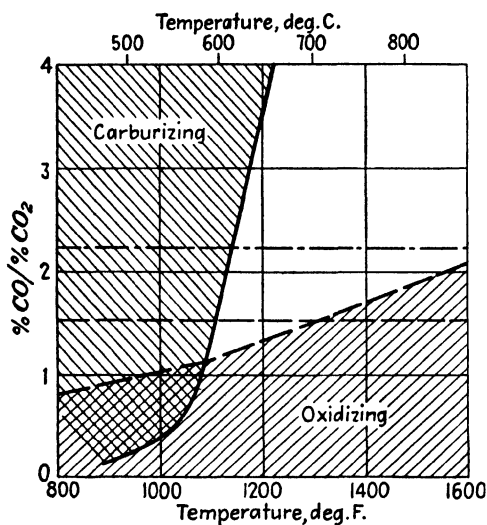

FIG. 2.11. Probable action of a furnace atmosphere on steel surface under specific conditions. (Austin and Day.)¹⁴

aid in predicting how a gas of known composition will react at various temperatures, Austin and Day¹⁴ have presented data on equilibrium constants and have shown examples of their use. From these constants it is possible to construct diagrams of the type shown in Fig. 2.11. The reactions in the diagrams are expressed in terms of the ratio of CO to CO₂ (or H₂ to H₂O) and indicate whether a gas of known composition will oxidize, carburize, or decarburize at various temperatures.

Practically, it is difficult to produce an atmosphere exactly in equilibrium with the steel. If there is some tendency toward oxidation, decar-

Of the constituents present in the gas after removal of moisture, carbon dioxide (CO₂) is oxidizing, while carbon monoxide (CO) and hydrogen (H₂) are reducing. When used as an atmosphere during the heating and cooling of steel, the individual gases may react readily with the iron and carbon in the steel, with iron oxide, and with each other, depending upon the temperature and composition of the gas. As a result the gas may act to decarburize or oxidize the surface of the metal.

To facilitate the selection of a gas composition and to

burization, or carburization, an increase in the rate of gas flow will tend to aggravate the tendency as equilibrium cannot be approached so closely as when the gas moves less rapidly and thus has a better opportunity to come to equilibrium. Equilibrium also cannot be reached if temperature non-uniformity exists in the steel or in the furnace, or if the furnace temperature fluctuates. Careful control of gas composition and temperature is essential to the successful use of protective gas atmospheres. The efficiency of a controlled atmosphere may be determined by a method suggested by Koebel,⁹² in which the weight change of a standard sample is observed.

2.11. Summary

Heating of steel for hardening should, ideally, be carried out at such a temperature and for such a time that (1) ferrite and carbide are absorbed completely in the austenite and (2) the carbon and alloying elements may diffuse to give a uniform austenite. Critical temperatures may be estimated or determined, but effective heat treatment requires austenitization at 50 to 150°F. (30 to 85°C.) above the critical temperature depending on the composition of the steel, its prior condition, and time at temperature. This temperature should also be consistent with the grain-size characteristics of the steel and the grain size desired in the product. In high-carbon steels an incomplete solution of carbides may be desirable to restrain grain growth and to minimize the retention of austenite, but in low-carbon steels an incomplete solution of ferrite gives poor hardenability and a tendency toward brittleness and cracking.

The conditions of heating have a major influence on the success of heat treatment. Avoidance of warping and cracking is favored by slow heating, and rapid heating is largely restricted to small parts, simple shapes, or to the heat treatment of the surface skin. Rapid heating also requires greater care in the selection of steel and control of the structure prior to heating in order to avoid erratic hardening and cracking. The condition of the surface is extremely important with respect to the cost of finishing and to the fatigue life, and most careful precautions are essential to successful service of any heat-treated steel article.

CHAPTER 3

THE TRANSFORMATION OF AUSTENITE

IT CANNOT BE EMPHASIZED too strongly or too often that many of the most important properties of steel—for example, strength and hardness, such quality factors as ductility and toughness, and such an economically important property as machinability—are dependent on microstructure—on the composition and distribution of carbide particles in a matrix consisting largely of unalloyed or alloyed ferrite—and that the nature of this microstructure depends primarily on how the austenite is transformed during cooling. This is a principle of prime importance to everyone who uses steel in the design and building of structures and machines, and the engineering profession is fortunate that by various thermal treatments a wide variety of microstructures can be secured, accompanied by engineering properties that are subject to more or less definite metallurgical control.

The use of the modifying “more or less” to detract from the force of the statement “definite metallurgical control” is justified because there are a few inherent characteristics in the heat treatment of steel about which the metallurgist can do little but accept them with the best grace possible. It is the object of this and the chapters that follow to describe the methods by which the structure of steel can be regulated, and to emphasize which of the many variables entering into the process can be controlled readily and economically, and which can be controlled with difficulty or not at all.

Of the many factors that affect the final structure of carbon and alloy steels, clearly the most important are those entering into the transformation of austenite; these are, therefore, discussed in detail.

3.1. Studying the Transformation of Austenite by Continuous-Cooling Methods

For many years, the transformation of austenite has been studied by subjecting steels of different composition to cooling at various rates

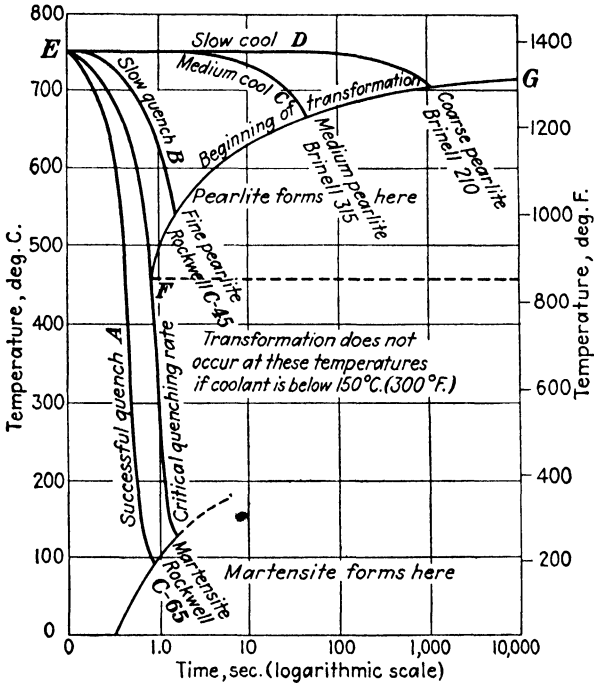

FIG. 3.1. Relation between time and temperature of transformation of 0.80 per cent carbon steel. (Bain.)¹⁷

and observing the effect of the cooling rate on the microstructure, the hardness, and the location of the transformation temperatures (A_{r1}) where gamma iron changes to alpha iron upon slow cooling. As is well known, this A_{r1} temperature is normally in the vicinity of 1325°F. (720°C.), slightly below the A_1 equilibrium temperature, which is at 1333°F. (723°C.) as indicated by Fig. 2.1 (p. 15).*

*The A_1 equilibrium temperature, usually designated A_{e1} , is a hypothetical temperature found by extrapolating to zero rate the actual transformations determined during slow heating and cooling. The actual transformation temperature observed

The effect of increasing the cooling rate on the structure and transformation temperatures of a high-carbon steel as determined by Bain¹⁷ is shown in Fig. 3.1. Increasing the cooling rate causes the pearlite to be finer, it increases the hardness, and it lowers the temperature (line

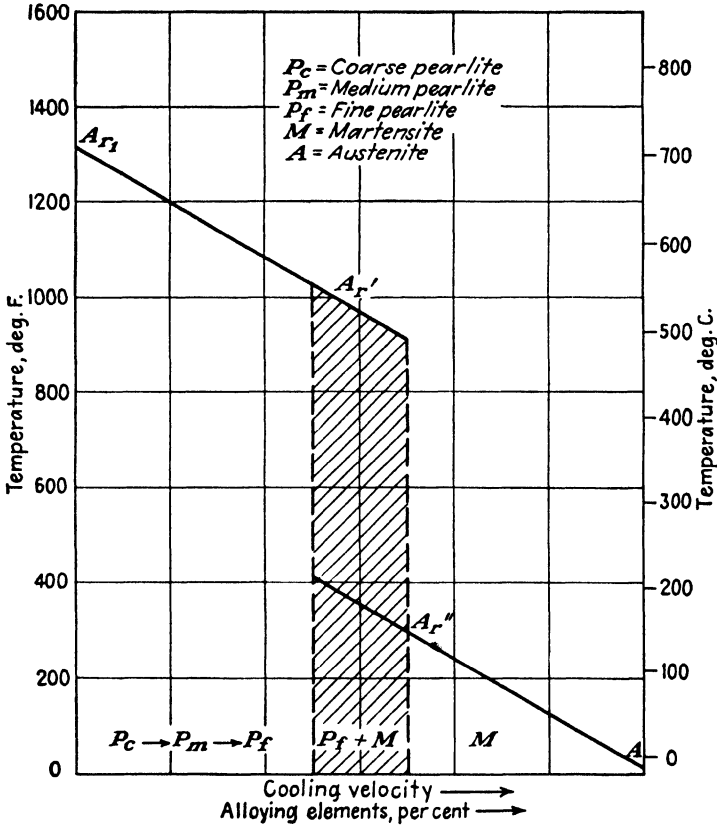

FIG. 3.2. Effect of cooling velocity and alloying elements on the location of the lower transformation point (A_{r1}) in cooling. (Sauveur.)¹⁷³

GF in Fig. 3.1) where the austenite begins to transform. This lowered transformation is known as $A_{r'}$ to distinguish it from the A_{r1} transformation, which occurs at a relatively constant temperature.

When the cooling rate is increased still more, a speed is reached where the $A_{r'}$ transformation is suppressed almost entirely and a new trans-

during slow heating is ordinarily designated A_{c1} (see Fig. 2.2), and the corresponding transformation found during slow cooling is known as A_{r1} . With very slow heating or cooling rates, A_{c1} and A_{r1} (also A_{c2} and A_{r2}) range from 3 to 10°F. above and below the A_{e1} (A_{e2}) temperature, respectively.

formation appears at a much lower temperature. The speed of cooling necessary to suppress the upper $A_{r'}$ temperature also suppresses the formation of pearlite and is known as the critical cooling rate (Fig. 3.1). When this rate is exceeded, the austenite transforms to martensite. The lower transformation point, where martensite is formed, is usually called $A_{r''}$.

Most of the alloying elements, when added to carbon steel, have an effect analogous to that of increasing the cooling rate; for example, if a cooling rate of 350°F. (200°C.) per second results in a structure of fine pearlite in a plain carbon steel, the same cooling rate will result in a structure of martensite in a steel containing considerable chromium and manganese. The effect of increasing the cooling rate and of adding alloying elements is shown schematically in Fig. 3.2. As indicated by this illustration, it is possible to have cooling rates (or a combination of a certain cooling rate and alloying elements) that will result in a structure containing both pearlite and martensite (shown by the hatched area in Fig. 3.2); and it is also possible to have certain combinations of high cooling rates and alloying elements—or enough alloying elements so that cooling rate is not important—so that the $A_{r''}$ transformation occurs below room temperature, with the result that the structure contains varying amounts (up to 100 per cent) of austenite.

3.2. Studying the Transformation of Austenite by Isothermal Methods

Studying the transformation of austenite by continuous cooling at various rates has the disadvantage that it is difficult to determine the nature of the resulting structures and almost impossible to discover the mechanism by which these structural constituents are formed. One of the outstanding advances in metallurgy during the last twenty years has been the perfection by Davenport and Bain¹⁰ of the isothermal-transformation technique: Instead of cooling continuously, samples are rapidly quenched in a salt bath maintained at a certain temperature; they are then held at that temperature for graduated time intervals before quenching in water. In this way the structure is formed at one temperature so that the time required to initiate and complete the transformation can be determined for comparison with that for other temperatures or with other steels. The procedure followed in this method is shown schematically in Fig. 3.3.

In studying isothermal transformation it is customary to examine enough specimens to establish the beginning and ending of visible transformation as well as to determine the progress of transformation at each of several temperature levels. Once the time intervals for the various stages of transformations are obtained, they may be used to

plot the complete diagram. The procedure is illustrated in Fig. 3.4. Several hundred very small specimens were used for the complete diagram. Of these, 29 were quenched in a salt bath maintained at 700°F. (375°C.) in which they were held for intervals varying from about 2 sec. to about 2000 sec.; after that, they were quenched in iced brine and examined to determine the amount of transformed constituents in the structure. The results are plotted in the upper part of Fig. 3.4,

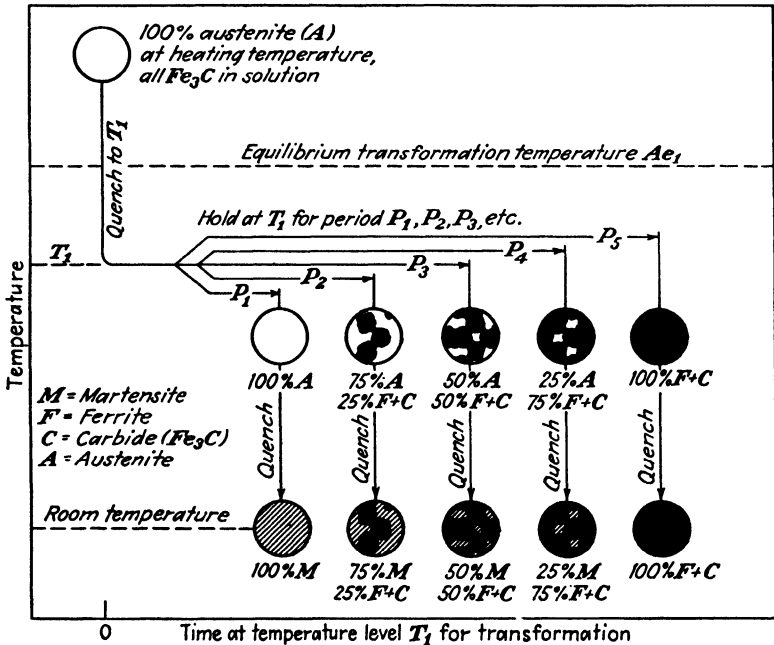

FIG. 3.3. Heat-treating cycles employed in studies of isothermal transformation. (Davenport.)⁴¹

and the points for the beginning of visible transformation, for 50 per cent transformation, and for the apparent end of the reaction are inserted in a plot of reaction temperature versus time on a logarithmic scale. Similar data were obtained for other temperature levels. The complete diagram, shown in the lower section of Fig. 3.4, is commonly known as a time-temperature-transformation (T-T-T) diagram, and the lines in such a diagram are frequently spoken of as S-curves.

A typical T-T-T diagram for a commonly used low-alloy steel (SAE 4140) is reproduced in Fig. 3.5. It will be noted that for this steel, when transformed between 1300 and 500°F. (705 and 260°C.), an

appreciable amount of time is required for initiation and completion of transformation to produce ferrite and pearlite or bainite. Below 500°F., martensite forms⁶² instantaneously and continuously as the temperature is lowered, until the transformation is completed.* These characteristic

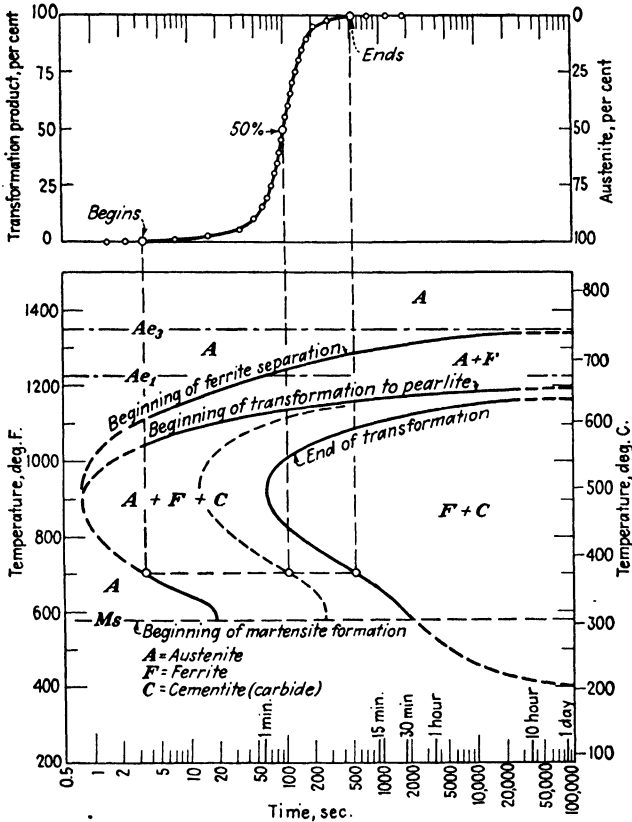

FIG. 3.4. Method of constructing a T-T-T diagram, and complete diagram for a medium-carbon nickel steel. (Atlas.)¹¹⁵

differences in the time required for austenite transformation at different temperature levels determine the microstructure and the degree of hardening produced during continuous cooling.

The salient features of the T-T-T diagram for carbon and many low-alloy steels (Figs. 3.3 and 3.4) are the “nose,” where the transformation of austenite is the most rapid—and which generally occurs in the temperature range 900 to 1100°F. (480 to 595°C.)—and the bay or “chin”

*The martensite beginning (*M_s*) line is not shown on Fig. 3.5. See Figs. 3.4 and 3.14 for approximate location of this transformation.

below the nose, where the reaction rate usually slows down. At and above the nose, pearlite (plus excess ferrite or carbide, depending on the carbon content) is the reaction product; below the nose, and above the temperature where martensite begins to form (the M_s temperature), the reaction product is bainite.

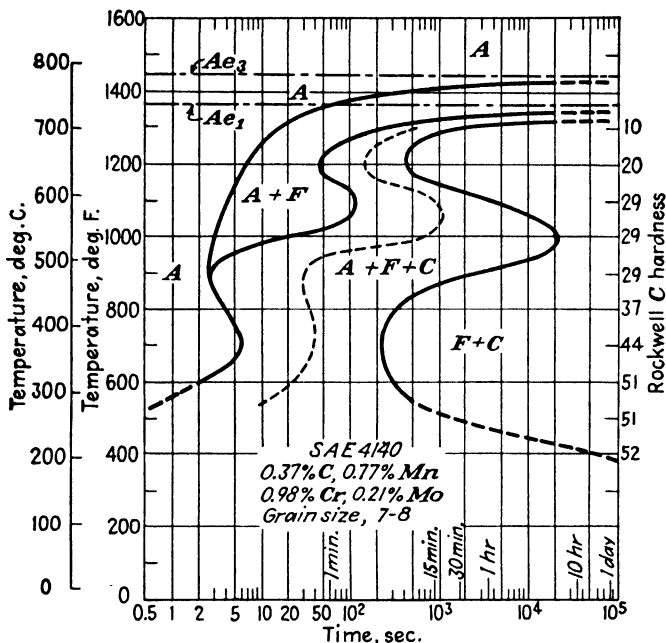

FIG. 3.5. T-T-T diagram of SAE 4140 steel austenitized at 1550°F. (845°C.), indicating time for beginning of transformation (left-hand lines) and for complete transformation (right-hand lines). Phases: A = austenite; F = ferrite; C = carbide. (*Atlas.*)¹¹⁵

3.3. Pearlite Formed by Isothermal Transformation

In the range of temperatures from the lower critical temperature (A_{r1}) down to about 1000°F. (540°C.), pearlite is formed with the carbide and ferrite in the form of thin plates or lamellae. The distance between the plates decreases as the transformation temperature is decreased, as indicated in Figs. 3.6 and 3.7. In this temperature range the rejection of excess (proeutectoid) ferrite in low-carbon steel or proeutectoid carbide in high-carbon steel will precede the formation of pearlite.

Pearlite can also be formed by slow continuous cooling, and the structure is soft and readily machinable, but for the best finish in machining



FIG. 3.6. Coarse pearlite formed at 1300°F. (705°C.). 2000 \times . (*Forgeng.*)

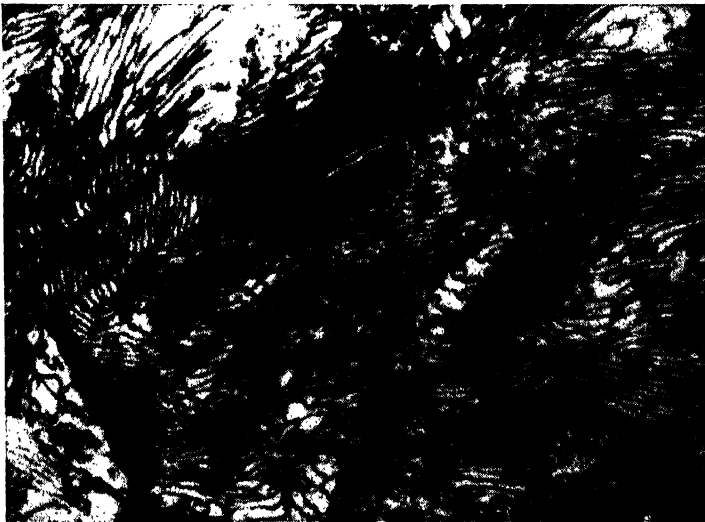

FIG. 3.7. Fine pearlite formed at 1185°F. (640°C.). 2000 \times . (*Forgeng.*)

it is frequently desirable to have relatively small and well-distributed ferrite grains with rather coarse pearlite lamellae. To secure this structure the steel is cooled rather rapidly to the range of 1150 to 1300°F. (620 to 705°C.) and then held at that temperature for some 6 to 12 hr. until pearlite is formed isothermally. The maximum temperature in heating prior to isothermal annealing is quite important and should be high—1600 to 1800°F. (870 to 980°C.)—for coarse-grained steels and for some fine-grained alloy steels, notably the low-chromium steels,



FIG. 3.8. Bainite formed at about 700°F. (370°C.). 2000 \times . (*Forgeng.*)

that transform readily to pearlite.⁶⁰ A controlled normalizing treatment may also be used for this purpose. Most fine-grained steels and some low-nickel steels that tend to form lamellar carbide particles with difficulty should be heated only to a temperature between A_{c1} and A_{c3} (Fig. 2.2) and then transformed isothermally at a barely subcritical temperature (1150 to 1300°F.).^{26, 109} Data reported by Brophy²⁶ on the relation between the various annealing treatments and machinability are collected in Table 3.1.

3.4. Formation of Bainite and Martensite

During isothermal transformation at temperatures below about 1000°F. (540°C.), the ferrite of the ferrite-carbide aggregate (bainite) is acicular in structure, and the carbide is present as fine, spheroidal particles, which are relatively coarse when formed at the higher temperatures of this range and fine and more uniformly distributed when formed at the lower temperatures, as shown in Figs. 3.8 and 3.9.

TABLE 3.1. Machinability-Test Results on a Few SAE Steels after Regular and Cycle Annealing*

SAE grade	Composition, per cent				Normalizing		Austenitizing		Transformation			Brinell hardness number	Tool life, sec., for speed of 132 rpm.		
	C	Mn	Ni	Cr	Mo	Temperature		Time, hr.	Temperature		Time, hr.				
						°F.	°C.		°F.	°C.					
2340	0.40	0.67	3.30			1475	800	1500	815	2	Slowly cooled	186	210†		
								1325	720	1	1100	595	10	212	464
								1325	720	1	1100	595	10	202	702
4340	0.43	0.66	1.80	0.70	0.26	1550	845	1550	845	2	Slowly cooled	216	60†		
								1375	745	2	1250	675	24	196	293
								1375	745	2	1250	675	24	195	843
3045	0.48	0.84	0.75	0.80		1500	815	1525	830	2	Slowly cooled	203	210		
								1375	745	2	1200	650	2	207	94
								1375	745	2	1250	675	10	196	700
4640	0.42	0.66	1.78	0.30		1900	1040	1375	745	2	1250	675	10	207	450
								1500	815	2	1150	620	24	196	103
								1500	815	2	1150	620	24	187	400
T1340	0.41	1.79				1500	815	1375	745	2	1200	650	24	187	854
								1375	745	2	1200	650	24	187	323
								1375	745	2	1225	665	24	186	
3140	0.44	0.79	1.40	0.68		1450	790	1500	815	2	Slowly cooled	207	43		
								1375	745	2	1200	650	10	196	245
								1375	745	2	1200	650	10	179	588
								1375	745	2	1225	665	24	184	1500
								1500	815	2	Slowly cooled	207	43		
								1425	775	2	1250	675	2	196	300
								1375	745	2	1250	675	15	174	600

* Brophy.¹⁶

† Speed = 130 rpm.

Bainite occurs frequently in incompletely hardened steels and may be produced intentionally by austempering* or by time quenching as in the Purnell process.† The treatment consists of quenching in a salt or lead bath to a temperature of 400 to 800°F. (205 to 425°C.), which is suitable for transformation to bainite, at such a rate that transformation in the pearlite range and at the nose of the S-curve is avoided (see Fig. 3.15, p. 49). The process is utilized to develop high strength and toughness in small sections of high-carbon steels, with a minimum of distortion and cracking.



Fig. 3.9. Bainite formed at about 480°F. (250°C.). 2000X. (*Forgeng.*)

At still lower temperatures, martensite, which is a supersaturated solid solution of carbon in ferrite that has a distorted cubic or tetragonal lattice, starts to form below a characteristic temperature depending upon the composition of the steel. This structure is truly acicular in appearance with well-formed “needles” as shown in Fig. 3.10. Austenite starts to transform to martensite as soon as the characteristic temperature is reached without any period of incubation. It is, therefore, virtually impossible to suppress martensite formation if the temperature is lowered very rapidly to the appropriate range.

The ease with which the transformation of austenite is suppressed until the temperature range where martensite forms is reached depends upon several factors. First of all it depends on how fast the heat is extracted, which is determined by the quenching medium (the coolant)

* U.S. Patent 1,924,099.

† U.S. Patent 2,322,777.

and the size of the specimen treated;* second, it depends upon the speed with which austenite transforms to pearlite or bainite. In other words, it depends on the location of the S-curves with respect to the time ordinate of the T-T-T diagram.

Both pearlite and bainite are formed from austenite by a process that involves the birth of nuclei and the growth of these nuclei into sizeable particles. Nucleation and growth depend principally on temperature and time, but in addition—and this is the important factor in harden-

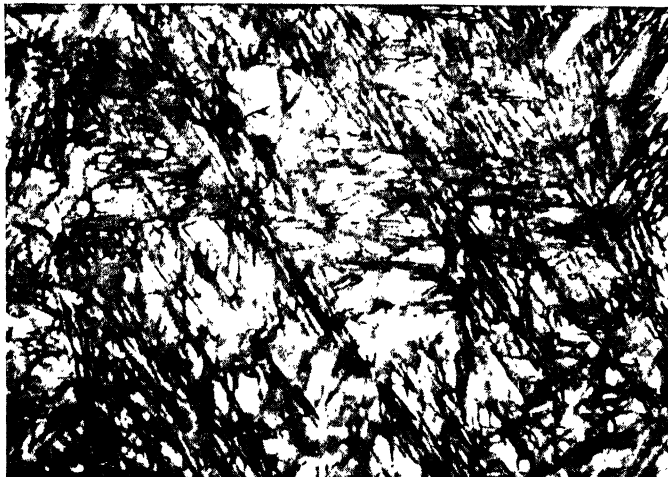

Fig. 3.10. Martensite. 1000 \times . (*Forgeng.*)

ability—nucleation (but not growth) is structure-sensitive; it is affected greatly by the composition and structure (which depends on composition) of the material. Hence it is possible, by altering the composition and structure of the austenite, to accelerate or retard the nucleation of pearlite or bainite and thus in effect to shift the position of the S-curve to the left or right.

If nucleation is accelerated, the transformation of austenite is speeded up, and the difficulty of quenching to the martensite temperature without prior transformation is increased; if nucleation is retarded, it is easier to cool the steel so that all or practically all of the austenite will transform only to martensite.

*The role of the quenching medium and the effect of section size (mass) are discussed in later chapters; it may be noted here, however, that a quenching medium may extract the heat from the surface very rapidly or very slowly depending upon its temperature and characteristics. Heat flow from the center to the surface of a large piece of steel, however, depends primarily on thermal conductivity and is not much affected by the quenching medium.

3.5. Effect of Carbon Content and Grain Size on the Transformation of Austenite

The rate of nucleation is, as noted in the preceding section, the most important factor in the speed of the transformation of austenite to pearlite and bainite; but it is not a factor in the formation of martensite which forms almost instantaneously when austenite is cooled unchanged

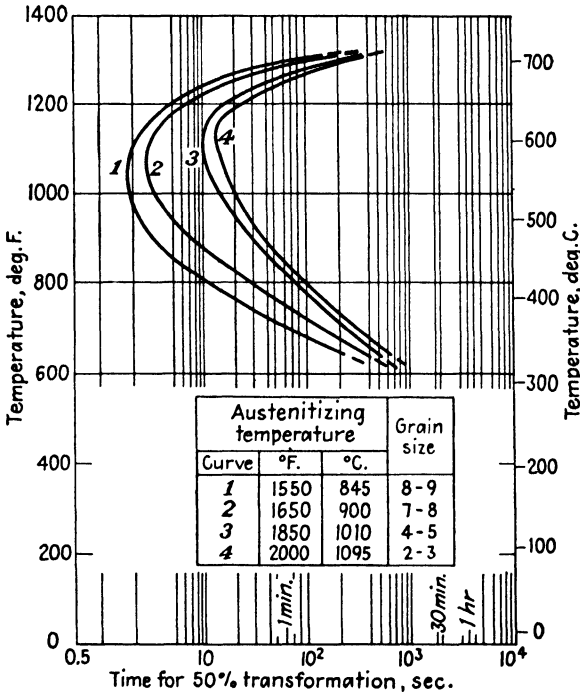

FIG. 3.11. Comparative time intervals for 50 per cent transformation in a single steel as influenced by austenite grain size. (Davenport)⁴¹

to the proper temperature. In general, carbon and alloying elements retard the rate of nucleation, and in addition they affect the temperature (M_s) where martensite forms, but not the rate of formation.

Carbon has a considerable effect on the speed of the formation of bainite; data reported by Davenport⁴¹ and confirmed by others indicate that increasing the carbon 0.30 per cent may slow down the beginning of bainite formation in a carbon steel at temperatures between 700 and 500°F. (370 and 260°C.) as much as 500 per cent.

Directly carbon has little effect on the speed with which austenite transforms to pearlite. Indirectly it may have considerable influence.

When steels containing less than 0.75 to 0.85 per cent carbon (hypoeutectoid) are cooled below the A_{r1} temperature, excess ferrite separates, and if the carbon is higher than 0.85 per cent (hypereutectoid), excess carbide separates. Particles of excess ferrite or excess carbide act as loci where nucleation of pearlite will take place prematurely; thus, high-

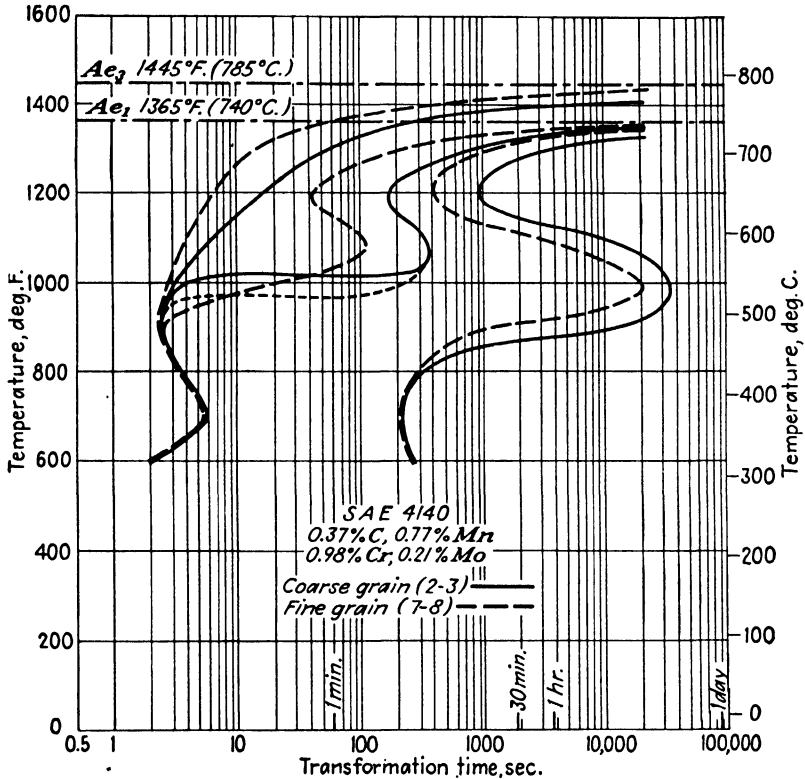

FIG. 3.12. T-T-T diagrams for SAE 4140 steel with grain size 2-3 and 7-8. (Davenport, Grange, and Hafsten.)⁴²

carbon steels and low-carbon steels will transform a little more rapidly in the pearlite range than steels containing approximately the amount of carbon (0.80 per cent) in pearlite.

Transformation of austenite to pearlite is also accelerated if undissolved carbides or inclusions are present in the austenite. These also act as loci where premature nucleation of pearlite starts. The extent to which the transformation is speeded up depends on the amount, the size, and especially the distribution of these undissolved particles.

The grain size of a steel also influences the transformation charac-

teristics. It has been shown by Davenport⁴¹ and by Davenport, Grange, and Hafsten⁴² that the coarser the grain size the greater is the delay in the start of transformation. The effect is more pronounced at temperatures near the nose of the curve, as indicated in Figs. 3.11 and 3.12, and diminishes at higher and lower temperatures. Hollomon and Jaffe⁷⁸

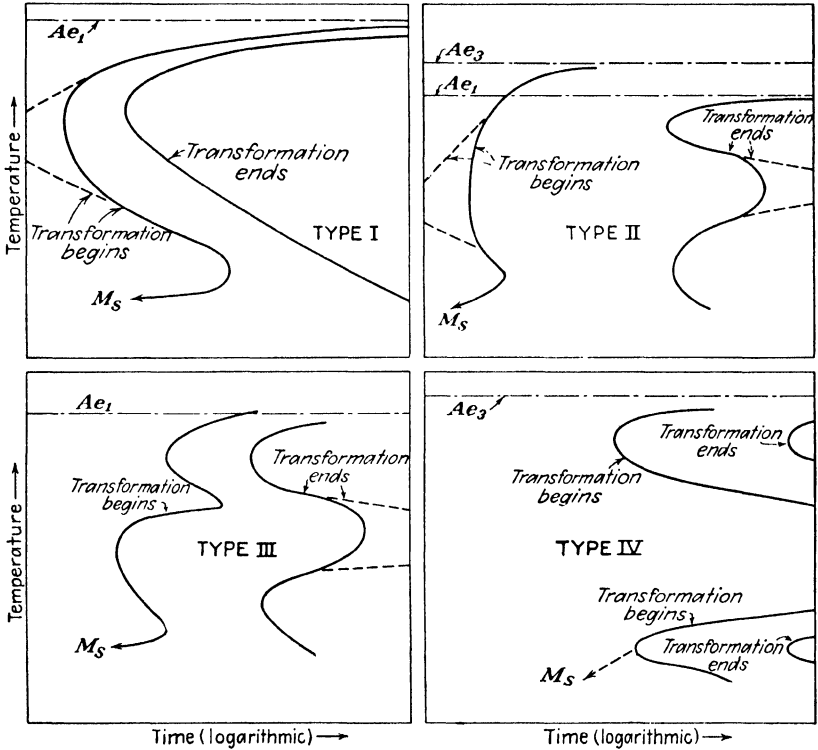

FIG. 3.13. General types of T-T-T diagrams for alloy steels. (Morral)¹⁰⁶

indicated that in isothermal transformation the formation of pearlite is affected by grain size to a much greater degree than that of bainite, but that in continuous cooling grain size has a material effect on the bainite reaction.

3.6. General Effects of the Alloying Elements on Isothermal Transformation of Austenite

The effect of individual alloying elements on the reaction rates has been extensively studied. Each element has a tendency to exert a characteristic influence on the austenite → pearlite and the austenite →

bainite transformations, so that each type of steel has a characteristically shaped T-T-T diagram. The gross effects of alloying elements may be considered simply as tendencies to increase or decrease the time for nucleation of the pearlitic and/or the bainitic constituents, and the S-curves of steels containing alloying elements may be grouped qualitatively into a number of classes.

Morral, after a survey of the available isothermal-transformation data, found that the time-temperature-transformation curves of simple and complex steels may be classified into four basic types.* As will be seen in Fig. 3.13, he classified the S-curves with respect to qualitative translation of the same shape to greater time intervals and also with respect to their tendency to develop a bay (or chin or shelf), which differentiates the pearlite and bainite temperature areas of the diagrams. In general, the austenite-forming elements manganese and nickel tend to increase the time without greatly changing the shape of the curve. The strongly carbide-forming elements chromium and molybdenum increase the time required for pearlite formation but have relatively less effect on bainite, so that they tend to accentuate the separation of the curve into two noses (types II and III). Molybdenum has less effect on bainite than does chromium. The time for bainite formation in chromium steels is greatly increased by carbon so that high-carbon chromium steels have T-T-T curves similar to those of plain manganese and nickel steels. The Morral classification of some common steels is shown in Table 3.2.

TABLE 3.2. General Classification of Steels According to T-T-T Diagrams

<i>Morral type</i>	<i>SAE and other steels</i>
I	1000, 1300, 2300, 2515, high-carbon tool steels
II	3100, 3200, 4000, 4130, 4600, 4815, 5100, 6100, 8600, 8700
III	3310, 4100 (except 4130), 4300, 5200
IV	A few complex nickel-chromium steels, medium- and high-alloy tool and die steels, special air-hardening steels, high-chromium cutlery and die steels, and high-speed steels.

3.7. Transformation of Austenite to Martensite

The primary purpose of quenching is to produce martensite. If the cooling rate is sufficiently fast to suppress the formation at high temperatures of ferrite, pearlite, and bainite, further lowering of the temperature results in transformation of austenite to martensite. As found by Greninger and Troiano,⁶² the transformation of austenite to martensite

* Morral's original classification was published in 1945¹⁰⁴ and gave five types. He has recently made a new study of the literature;¹⁰⁶ Fig. 3.13 is based on his latest classification.

depends on the composition, which affects the temperature of martensite formation, but the transformation does not depend on time. In low-alloy steels the reaction is completed above room temperature, but some high-alloy steels require treatment at lower temperatures to complete transformation.^{51, 56, 71}

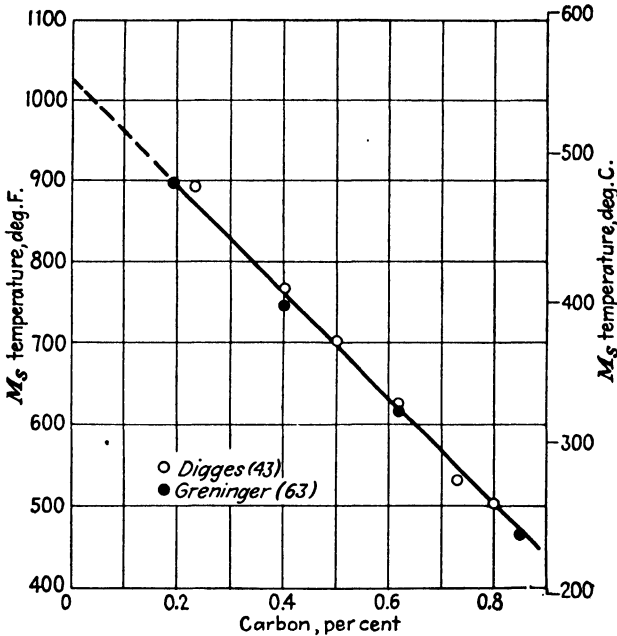

FIG. 3.14. Effect of carbon on upper limit of martensite formation (M_s) in high-purity iron-carbon alloys. (Grange and Stewart.)⁵⁹

Carbon and alloying elements lower the temperature range in which martensite forms. Greninger and Troiano⁶² and Digges⁴³ found that carbon lowered the temperature at which martensite starts to form (M_s) by the amounts indicated in Fig. 3.14. Several investigators^{30, 46, 59, 110} have studied the effect of alloying elements on the M_s temperature, and different formulas have been proposed for calculation of the temperature from the composition. Grange and Stewart⁵⁹ suggested that, when several alloying elements are present, they act in an additive manner in depressing the M_s temperature according to the following formula:

$$M_s \text{ (}^\circ\text{F.)} = 1000 - (650 \times \% \text{ C}) - (70 \times \% \text{ Mn}) - (35 \times \% \text{ Ni}) - (70 \times \% \text{ Cr}) - (50 \times \% \text{ Mo}).^*$$

* These factors apply only for chromium up to 1.5 per cent and for molybdenum up to about 1 per cent.

The temperature for completion of martensite formation (M_f) may be 150 to 300°F. (85 to 170°C.) below M_s , depending on carbon and alloy content. Grain size has no appreciable effect on the martensite reaction.

The ability to estimate the temperature at which austenite transforms to martensite on quenching is of practical value in interrupted-quenching

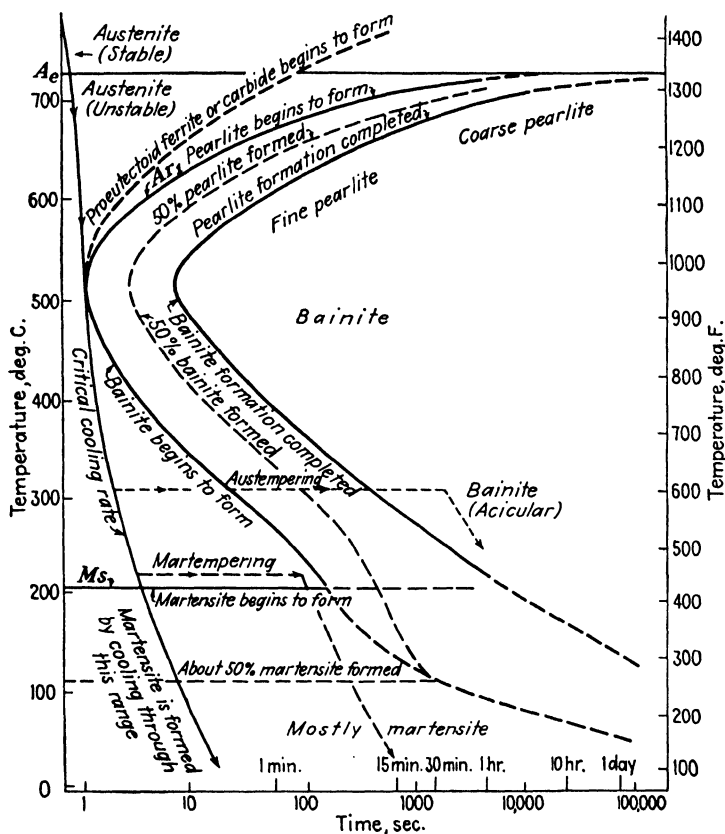

FIG. 3.15. Schematic T-T-T diagram for carbon steel showing critical-cooling-rate curve, M_s temperature, and temperatures for austempering and martempering. (McMullin.)¹⁰²

treatments such as austempering and martempering. The latter treatment was devised by Shepherd¹²³ to minimize quench cracking. The steel is quenched in a bath maintained at a temperature just above the M_s temperature for that particular steel. It is held in the bath just long enough for the temperature to become equalized but not long enough for bainite to form isothermally, after which it can be cooled

slowly (as in air) to room temperature, whereupon martensite forms. The absence of thermal gradients minimizes the tendency of the steel to distort and crack during hardening, which may occur in quenching directly into the coolant at room temperature. A schematic representation of austempering and martempering, for carbon steels, is shown in Fig. 3.15 based on a chart prepared by McMulkin.¹⁰²

In the common low-alloy engineering steels, the martensite reaction is completed above room temperature, but with high carbon or high alloy contents, the end of the transformation of austenite to martensite (M_f) may be lowered to below room temperature, when a structure consisting of martensite and untransformed (retained) austenite results. Retained austenite is also common in the high-carbon case of carburized steels. In order to complete austenite transformation to martensite these steels may be cooled to subzero temperatures. The subzero treatment is carried out in mechanical refrigerators, dry ice, or liquid nitrogen and is effective in raising the hardness (producing more martensite) of steels containing substantial amounts of residual austenite. Sufficient time should be allowed at the subzero temperature for the entire piece to attain that temperature.

3.8. Transformation of Austenite during Continuous Cooling

Hardening of steel to maximum hardness is accomplished by quenching at such a rate that austenite is transformed to martensite uncontaminated by excess ferrite, pearlite, or bainite, and the critical rate of cooling required to produce such hardening depends on the tendency to form the softer constituents at elevated temperatures. The tendency toward premature transformation, measured by the location of the beginning-of-transformation curve in the T-T-T diagram, should eventually provide a rational basis for predicting the composition and cooling rate required to produce a certain degree of hardening, although up to the present more accurate predictions of hardenability have resulted from empirical quenching tests.

The study of austenite transformation at constant temperatures has indicated that, above the temperature of martensite reaction, transformation is sensitive to time. During continuous cooling from the quenching temperature, therefore, transformation may occur over a range of temperatures. Work by Grange and Kiefer⁵⁷ and by Liedholm⁹⁷ indicates that transformation starts during continuous cooling at temperatures and times that are lowered and displaced to the right as compared with those of isothermal-transformation diagrams; this is shown in Fig. 3.16. The amount by which temperature and time are displaced is dependent on a complex integration of the effects of time and tem-

perature on nucleation and rate of reaction as discussed by Hollomon, Jaffe, and Norton⁷⁶ and by Manning and Lorig.⁹⁹

The last-named have indicated that transformation of austenite to ferrite and pearlite during continuous cooling may be estimated from isothermal-transformation data with some approach toward accuracy. They assumed that the effects of time at a higher temperature could be

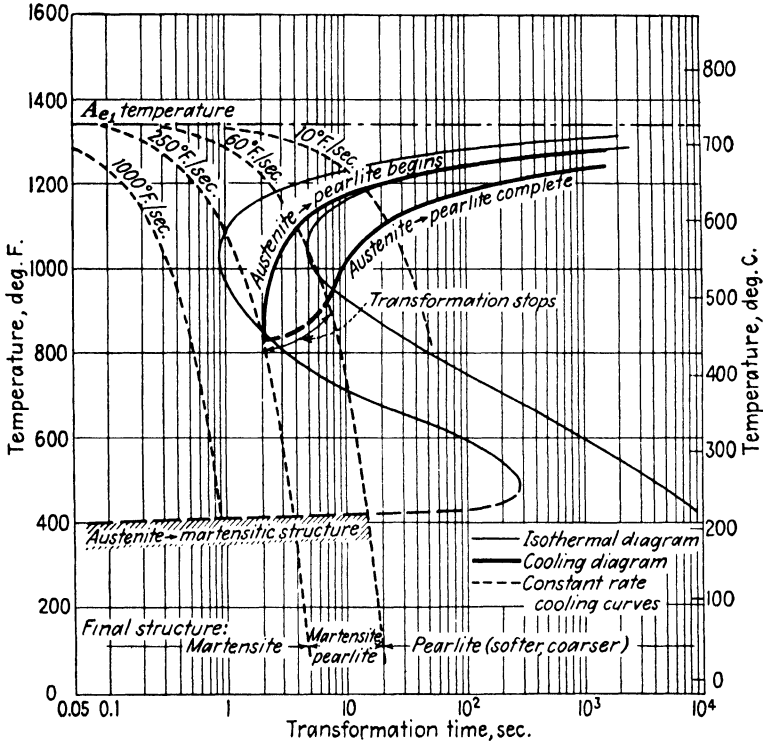

FIG. 3.16. Relation between continuous cooling rates and the T-T-T diagram for a eutectoid steel. (Grange and Kiefer.)⁸⁷

considered additive to time at a lower temperature so that the increments of time in successively lower temperature brackets could be integrated to a total time at the temperature of transformation. Bainite formation was not found to be predictable by this additive formula. A complicating factor is that bainite is affected by change in the austenite composition due to prior ferrite rejection and to the initial stages of the bainite formation.

The difficulty in translating isothermal-transformation into continuous-cooling behavior makes it impractical at present to estimate

quantitative hardenability by this means. Isothermal data are helpful in a qualitative sense, but the mechanism of even isothermal transformations is poorly understood and the basic characteristics of the resulting structures are barely recognized. The calculations in the following chapters on hardenability are based largely on empirical observations of hardening during continuous cooling, and such progress as has been made is remarkable when it is considered that no effective approach has yet been made to understanding why alloying elements increase hardenability.

3.9. Summary

Steel is essentially an iron-carbon alloy that dissolves carbide on heating to the austenitic condition and rejects it on cooling. The sub-critical temperature at which austenite transforms controls the form and size of the carbide particles in the structure and thereby governs the degree of hardening. Under conditions of isothermal transformation, proeutectoid ferrite or carbide and relatively soft lamellar pearlite are formed in the temperature range of 1000 to 1300°F. (540 to 705°C.). Between about 500 and 1000°F. (260 and 540°C.) the ferrite-carbide aggregate is the harder acicular bainite, and at lower temperatures carbon is retained in supersaturated solution in the ferrite lattice to form hard martensite. All of the non-martensitic constituents formed above the martensite temperature require a certain amount of time for nucleation and growth. Thus, on continuous cooling (quenching) it is possible to suppress their formation by fast cooling or by increasing the nucleation time with alloying elements. The effects of alloying elements on the isothermal transformation of austenite have been established qualitatively but their effects during continuous cooling have not been definitely evaluated and recourse must be made to empirical observations of the type described in the following chapters.

CHAPTER 4

QUENCHING

EVEN IN ITS SIMPLEST form the modern heat treatment of steel is an expensive process, but for many thousands of applications the high cost is entirely justified. The necessity for high hardness in tools is plain to everyone, and it is equally clear that the modern machine would be an unattainable ideal if high-strength quenched and tempered parts were unavailable. This is self-evident to every metallurgist and every engineer and does not need to be labored further.

Since heat treatment is such an important operation for steels used in a multitude of modern structures and machines, it is equally obvious that metallurgists and engineers should be vitally interested in the response of the various carbon and alloy steels to quenching; i.e., in the degree of hardening—the hardenability—and the structure (and properties) that can be attained by cooling from a red heat at various rates.

The degree of hardening attained in any given steel by quenching and the resulting structure and properties are dependent on two main factors. These are the severity of the quench and the mass of the quenched section. In other words, we should know if the quenching medium will cool the surface of the steel rapidly enough to produce the desired structure and also if the center, or any definite area below the surface, will cool rapidly enough to have the structure desired there.

An evaluation of the effect of mass is complicated by the fact that the heat from the center of a sizeable piece of steel will travel to the surface, where it can be dissipated by the coolant, at a relatively slow rate that depends primarily on the thermal conductivity of the material and only to a much lesser extent on the cooling ability of the quenching medium.

Further, the rate at which the heat travels from center to surface is for all practical purposes independent of the chemical composition.

A large amount of experimental work has been done on relative cooling rates of steel in various quenching mediums, at the surface and center, and at different positions between surface and center, in sections of different sizes and shapes; and the names of French, Scott, Grossmann, and Russell, to list only a few, are well known in this metallurgical field of endeavor. An outline of present-day knowledge of cooling rates and of the variables that affect the rates, based on the work of these and other investigators, is sketched broadly in this chapter.

4.1. Methods Used for Studying the Quenching of Steel

In general, three methods have been used to study the quenching of steel. These are (1) determining the relation between cooling rate and the surface and volume of steels of various sizes and shapes; (2) determining the severity of the quench, using cylindrical bars or plates, by comparing the amount of martensite produced with a standard (usually 50 per cent martensite) in sections of various sizes and shapes and by various quenching mediums; and (3) determining the severity of the quench by means of the Jominy hardenability test (discussed in Chapter 6) and applying the data thus obtained to cylindrical bars and to square and flat sections, and to various quenching conditions.

To work out a definite relation for the severity of the quench for various quenching conditions and for sections of various shapes and sizes, it has been necessary to make a number of assumptions, some of which are of doubtful validity. The errors inherent in the procedure may, therefore, be serious, and in extreme cases the calculations may actually be misleading. In general, however, these relations are probably as trustworthy as some of the other factors involved in the hardening of steel, especially as many of the values used have been determined experimentally. More important, however, is the fact that a rough estimate of cooling rates is a very useful tool, and it is being used satisfactorily to determine at least approximately the response to quenching of steels of widely varying composition and size.

4.2. Relative Cooling Rates at Surface and Center during Quenching

The rate of cooling within a specific bar depends upon the speed with which the surface of the bar is cooled to the temperature of the quenching bath. Because of the inherent limitations imposed by thermal conductivity and the fact that in quenching, heat is extracted only at the surface of the bar, there is a cooling-rate gradient between the surface and the center of the bar as indicated in Fig. 4.1. The greater the rate of

cooling at the surface, the steeper is the gradient and, consequently, the faster is the cooling rate at all positions within the bar. This is shown by data cited by Sisco¹³² (based on work by French⁶²) for spheres

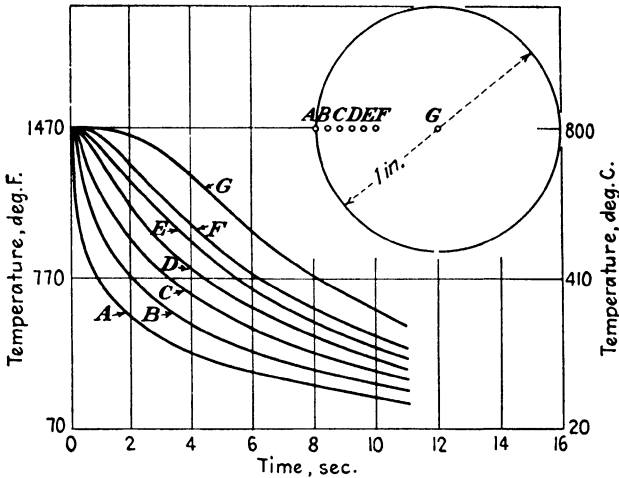

FIG. 4.1. Times required for various locations within a bar to cool when quenched in cold water. (Grossmann.)⁶⁶

quenched in slowly moving water or oil, or cooled in still air; the values given are the total times, in seconds, measured during quenching from 1400 to 600°F. (760 to 315°C.):

Size, in.	Water		Oil		Air	
	Surface	Center	Surface	Center	Surface	Center
1	0.1	5	8	35	450	475
2½	0.3	20	30	>100	>1000	>1000

The rate at which the surface of a piece of steel is cooled to a given temperature is dependent upon its size and shape and the severity of quench. With a given severity, the cooling rate at the surface of a cylindrical bar decreases with an increase in diameter, and an over-all decrease in the internal cooling rate of the bar results. This is illustrated in Fig. 4.2, in which the cooling times are shown for a position ½ in. below the surface and at the center of plates 1½, 3, and 6 in. thick when water quenched under the same conditions. Less drastic quenching acts in much the same manner as increasing the bar size. Similarly, a decrease of the surface area for the same volume of metal results in a decrease in cooling rate. The effect of mass then is to decrease the

cooling rates at all positions within the bar as the ratio of surface to mass is decreased by increase of size or change in shape.

4.3. Stages in Cooling the Surface during Quenching

Scott¹²⁴ showed that in the cooling of a metal surface by a liquid, the first stage is one of slow heat transfer because of vapor films that separate the liquid from the metal. The heat transfer from metal to coolant is least effective in liquids having low and sharp boiling points, such as

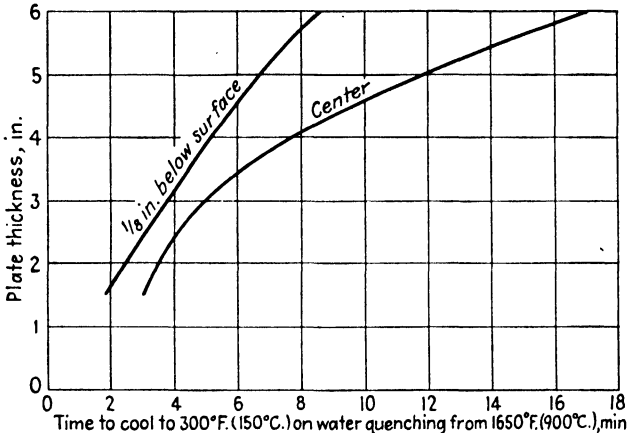

FIG. 4.2. Effect of plate thickness on cooling time during quenching. (After Martin and Pappas.)¹⁰⁰

water. The second stage is the one most active in heat transfer because cool liquid is continuously brought to the metal surface as bubbles of vapor leave it, and in this stage, water is particularly effective. Cooling in the third stage is by convection since the surface temperature of the metal is below the boiling point of the liquid. The thermal conductivity of the liquid is the chief factor in determining the activity in this stage.

In hardening steel, the most desirable quenching medium would be one that avoids the first stage, as with the use of oils; that would give a rapid heat loss in the second stage, as in the case of water; and that would cool slowly, like oil, in the third stage to avoid a rapid drop in temperature through the low-temperature range where martensite forms. However, although a search is still being made for the "perfect" quenching medium, in practical quenching operations we are generally limited to the use of water, water solutions, and natural or prepared oils. The choice depends upon the economy with which cooling rates giving the desired degrees of hardening are attained without excessive

distortion and cracking. In order to make such a selection, it is necessary to be able to evaluate the effect of the various quenching mediums in terms of cooling rate, or severity of quench.

Although the shapes of the cooling curves vary with different quenching mediums, it has been necessary for purposes of calculation to assume that all mediums will give the same shape of cooling curve in order to obtain a simple criterion for evaluation of quenching rates. It has also been assumed for purposes of calculation that the physical constants of the steel such as heat conductivity, density, and thermal diffusivity do not change with temperature and are the same for all steels. The error introduced with these assumptions is sometimes significant, but generally it is sufficiently small to permit a useful approximation that is better than the alternative intuitive guess.

4.4. Cooling Rates with Various Quenching Mediums

The effect of the various quenching mediums may be measured as the cooling rate attained at a certain temperature at a definite location in a bar of specific size and shape when cooled under uniform or controlled conditions. Since the amount of agitation in the quenching bath influences the speed with which the bath extracts heat from the metal, this has to be constant or controlled for accurate comparison. The cooling rate may be determined experimentally^{52, 124} by quenching bars of a definite size in various quenching mediums and recording the change of temperature with respect to time at a definite location within the bar.

TABLE 4.1. Relative Cooling Rates at Center of 1/4-in. Cylinders of 0.95 Per Cent Carbon Steel, Quenched from 1610°F. (875°C.). Rates Observed at 1330°F. (720°C.)*

Water solutions	Cooling rate at 1330°F. (720°C.)		Oils	Cooling rate at 1330°F. (720°C.)	
	°F./sec.	°C./sec.		°F./sec.	°C./sec.
Water	234†	130†	Prepared oil, No. 1 . .	144	80
5% sodium hydroxide	396	220	Prepared oil, No. 2 . .	122	68
5% calcium chloride . .	378	210	Crude	117	65
10% sodium carbonate	342	190	Cottonseed	117	65
0.06% white soap solution	41	23	Neat's-foot	108	60
			Fish	99	55
			Machine	70	39
			Transformer	56	31
			Palm	47	26

* French.⁵²

† Average: actual rates 216 to 252°F. (120 to 140°C.) per sec.

French⁵² determined the cooling rates attained at the center of $\frac{1}{2}$ -in. cylinders of 0.95 per cent carbon steel when quenched in different coolants without agitation. Some of his data are collected in Table 4.1. The cooling rates apply only to the specific conditions of the test. At the same location in larger bars, slower rates would have been obtained; upon quenching into agitated baths, the cooling rates would have been greater, and upon quenching from another temperature, the quenching rates would have been different.

To approximate the cooling rates of spheres, cylinders, and plates, French⁵² established the following formula by which the center cooling velocities in terms of degrees centigrade per second at 720°C. may be estimated for coolants having cooling characteristics similar to those of oil and water:

$$V = \left(\frac{S}{W} \right)^n \times C_2,$$

where V = velocity in degrees centigrade at 720°C.,
 S = surface area in square inches,
 W = volume in cubic inches, and
 n and C_2 = constants depending on quenching mediums.

The formula indicates that the cooling rate bears a direct relation to some power of the ratio of the surface area to the volume of the material. The ratio of surface to volume varies with the diameter or thickness in any given shape and with different shapes, such as spheres, rounds, plates, and others. It is, therefore, possible to express section and shape effects in a single parameter, the ratio of surface to volume. The constants n and C_2 in the formula do not change with the shape or size of the material but are dependent only upon the type of coolant.

4.5. Application of French's Method

To illustrate French's method assume that constants are desired for an agitated water quench so that the cooling rate to be expected at the center of bars of various sizes may be estimated for these quenching conditions. First, it is necessary to measure the cooling rate at the center of a bar of known dimensions. For convenience assume that a bar, 1 in. in diameter by 4 in. long and quenched under the specified conditions, has a cooling rate at 1330°F. (720°C.) of 126°F. (70°C.) per sec. when quenched from 1610°F. (875°C.). The bar has a surface area of 14.14 sq. in. and a volume of 3.14 cu. in. and, therefore, a surface area per unit volume of $14.14 \div 3.14 = 4.50$. Having determined the cooling rate and the surface area per unit volume, reference is made to Fig. 4.3 in which the cooling velocity at 1330°F. (720°C.) is plotted against the

value for the n constant of the coolant for various values of the surface area per unit volume S/W . In the diagram, a horizontal line representing a center cooling velocity of 126°F. (70°C.) per sec. intersects an imaginary curved line for $S/W=4.50$ at a point indicating a value, on the abscissa, of 1.92 for n .

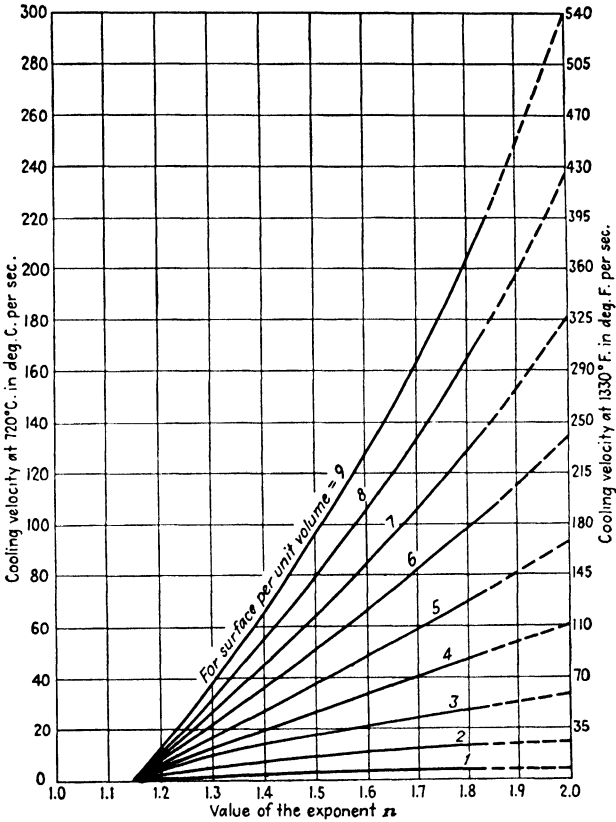

FIG. 4.3. Relation between center cooling velocity at 1330°F. (720°C.), the n exponent in French's equation, and surface per unit volume for steels quenched from 1610° F. (875°C.). (French.)⁵²

By substituting the value of $n=1.92$ and the cooling rate of 126°F. (70°C.) per sec. in the above formula the value of the other constant (C_2) may be determined. By substitution then:

$$126^\circ\text{F. (70}^\circ\text{C.)} = (4.5)^{1.92} \times C_2,$$

$$C_2 = 3.9.$$

These constants can then be applied to the calculation of the center cooling rate of bars of different sizes quenched under the same conditions

and from the same temperature. The cooling rate may also be determined graphically from Fig. 4.3 if the value of n is known.

The constants, determined by French, for quenching in still brine, water, oil, and air are shown in Table 4.2 to serve as a guide for constants that may be expected for various mediums.

TABLE 4.2. Constants for Several Quenching Mediums for Use with French's Formula, in Quenching from 1610°F. (875°C.)

Quenching medium and shape	Value for constant	
	n	C_2
5% NaOH, rounds.	1.84	3.86
Water		
Spheres.	1.75	3.89
Rounds.	1.75	3.91
Plates.	1.75	4.03
Average.		3.94
No. 2 oil		
Spheres.	1.40	3.22
Rounds.	1.40	3.03
Average.		3.12
Still air, rounds.	1.15	0.31

By substituting in the above formula the values of the constants appropriate for the quenching medium, the center cooling velocities of bars of various sizes obtained in quenching in 5 per cent NaOH brine, water, oil, or air may be estimated. A more rapid estimation may be made of the center cooling velocities taken at 1330°F. (720°C.) for these same conditions of cooling by the use of Fig. 4.4, in which the cooling velocity is plotted against the ratio of surface area to volume for different quenching mediums. For example, if a bar has an S/W ratio of 5.0, the diagram shows that the vertical line representing $S/W=5.0$ intersects the curved line for air cooling at a point representing a cooling rate of 3.6°F. (2.0°C.) per sec.; the curved line for oil quenching at a point equivalent to about 54°F. (30°C.) per sec.; and the line for water quenching at a point equivalent to about 117°F. (65°C.) per sec. These cooling rates at 1330°F. (720°C.) would then be those at the center of such a bar quenched in these mediums.

If quenching temperatures other than 1610°F. (875°C.) are to be used, the center cooling rate at 1330°F. (720°C.) may be determined if the cooling rate obtained in quenching from 1610°F. is known. For

example, suppose that a bar with a value for S/W of 4.5 is quenched from 1610°F. into agitated water with an n value of 1.92 and that the center cooling rate is 126°F. (70°C.) per sec. If the cooling rate is to be estimated during quenching from 1520°F. (825°C.), locate in Fig. 4.5 the

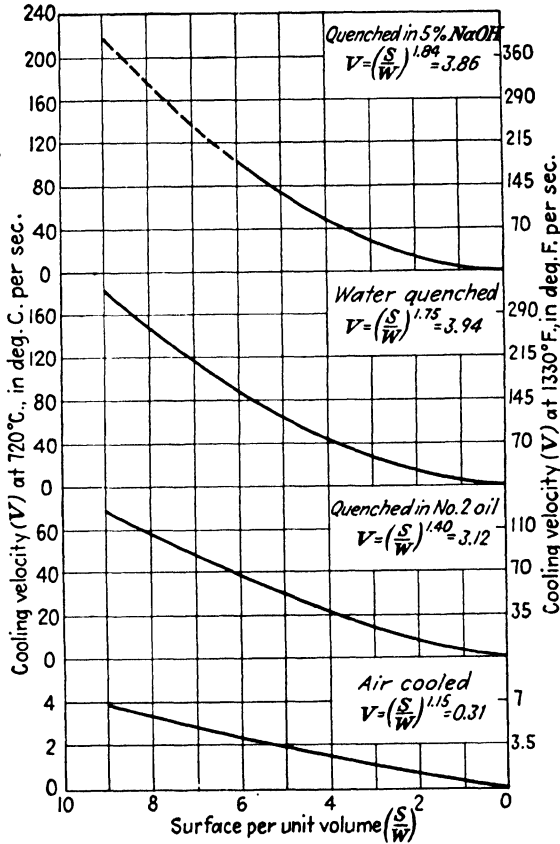

FIG. 4.4. Relation between center cooling velocity at 1330°F. (720°C.) and the surface per unit volume of steels quenched from 1610°F. (875°C.) in different coolants. (French.)⁸²

intersection at the vertical line for 1610°F. (875°C.) and an imaginary line for S/W at 4.50 and read on the ordinate the factor represented by this point or 0.30. For the new temperature, 1520°F. (825°C.), the factor is 0.265. The center cooling velocity at 1330°F. (720°C.) in quenching from 1520°F. (825°C.) will be 0.265/0.30 of 126°F. (70°C.) per sec., or 111°F. (61.8°C.) per sec. It should be noted that Jackson and Christenson⁸³ found later that the cooling rate increases with quenching

temperature only where the surface-to-volume ratio is large, but that with low surface-to-volume ratio (as in Jominy specimens) increase of temperature lowers the cooling rate.

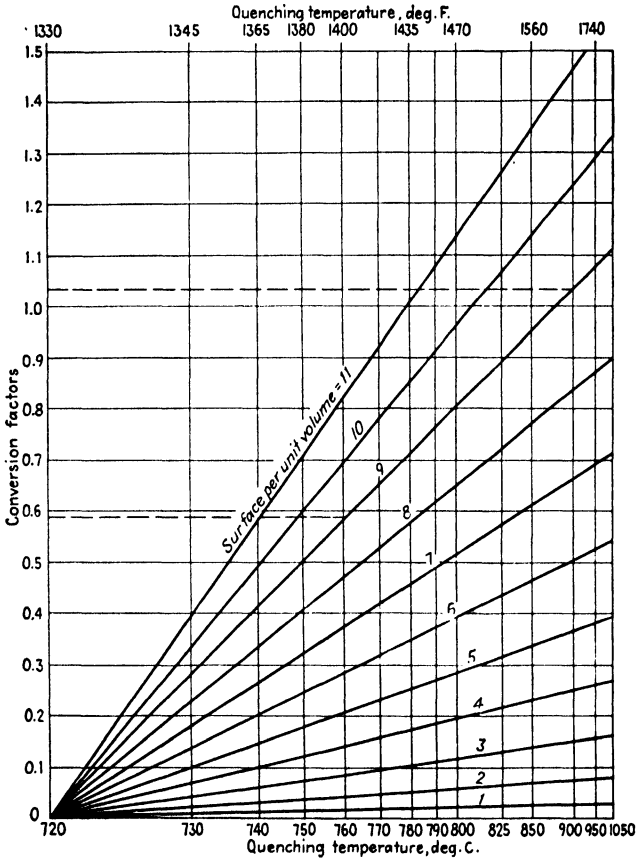

FIG. 4.5. Factors for converting center cooling velocity at 1330°F. (720°C.) determined at one quenching temperature to that for a different quenching temperature. (French.)⁶²

4.6. Determination of the Severity of the Quench

Another means of evaluating the relative effectiveness of quenching mediums is by reference to numerical values expressing their quenching severity. This avoids expression in terms of specific bar size as in the case of cooling rate. It has the further advantage that, if the value for the severity of quench is known, the time required to cool to any specific temperature between the austenitizing temperature and that of the coolant can be calculated for any location within a bar from such con-

stants as those given by Russell.¹²² Such a calculation assumes that thermal conductivity, specific heat, and density of steel do not change with temperature or composition and that the rate of abstraction of heat is proportional to the difference between the initial temperature and that of the coolant in accordance with Newton's law. The rate at which the coolant lowers the surface temperature and extracts heat is assumed to follow the laws of conductivity. By evaluation of factors for temperature, time, and dimension in terms of thermal conductivity, specific heat, and density, the effect of the coolant is then derived as an independent variable representing the severity of the quench, which theoretically can be applied to a steel section of any size or shape under any heating or quenching conditions. The severity of the quench was designated as H by Grossmann, Asimow, and Urban⁶⁵—the designation which is used in this book—and as h by Russell.^{*122}

TABLE 4.3. Approximate Severity of Quench, H, for Several Quenching Mediums*

Agitation of quenching medium or movement of the piece		Severity of quench H in			
Quenching medium	Piece	Air	Oil	Water	Brine
None	None	0.02	0.3	1.0	2.2
None	Moderate		0.4 to 0.6	1.5 to 3.0	7.5
None	Violent	0.6 to 0.8	3.0 to 6.0		
Violent or spray		1.0 to 1.7	6.0 to 12.0		

*Grossmann and Asimow.⁶⁷

Basing on data from such calculations and the results of experimental work, Grossmann and Asimow⁶⁷ were able to determine the approximate severity of quench for several quenching mediums as shown in Table 4.3. An agitated salt bath at 400°F. (205°C.) has a quenching-severity value of H = 0.25 to 0.30 on parts that have a machined surface. With materials having a light scale, the quenching severity is H = 0.20.⁸² Like cooling rate, the severity of quench is influenced markedly by such factors as rate of agitation, composition, and viscosity of the coolant as well as by any scale on the surface of the bar. It is recommended that for close control of quenching the value of H be determined for each set of quenching conditions. Once the severity of quench has been

*The letter H used by Grossmann, Asimow, and Urban to designate severity of quench is numerically equal to one half of h as used by Russell. In other words, 2H = h. Both H and h are measured in reciprocal inches (1/in.) and are heat-transfer ratios of f, the heat-transfer factor in Btu/in.² × sec. × °F., to K, the thermal conductivity in Btu/in. × sec. × °F. A complete discussion of the mathematics involved is given by Asimow in the appendix of the paper by Grossmann, Asimow, and Urban.⁶⁵

established for certain conditions, it is applicable to other treatments under the same conditions. The strongest possible quench, in which the surface temperature is instantly lowered to that of the quenching medium, is called an ideal quench and is expressed as $H = \infty$. The conception of the ideal quench is of much value as it is a basis to which other severities of quench may be related.

Constants from which it is possible to calculate the time required for round bars of various sizes to cool to various temperatures below the quenching temperature have been determined by Grossmann, Asimow, and Urban⁶⁵ for different quenching severities. From these constants a method of estimating the numerical value for severity of quench of round bars and plates was developed by these investigators. According to this method, gradients can be calculated for bars of various sizes for different values of severity of quench. The results can then be plotted as isohalf-temperature/time lines with respect to the position in the bar.

In Fig. 4.6, the quenching rate of the bar is expressed as the diameter of the bar multiplied by the numerical value for severity of quench. If a bar of a given diameter (D) is quenched with a given severity (H), a certain time is required to reach a certain temperature at a certain position in the bar. If the bar is larger or smaller, the same temperature will be reached in the same time at a different position in the bar of different diameter. For an equivalent cooling time the critical depth in the bar is expressed as the ratio of the unhardened partial diameter (Du) to the total bar diameter (D). If the time and temperature are critical with respect to hardening of the steel, the outer circumference will be hardened and the core will be unhardened, so that the partial diameter is expressed as (Du) to indicate the unhardened core. As the section is increased, without change in the severity of quench, the location for equivalent cooling time moves toward the surface. Then, as the section (D) becomes larger, the ratio of the unhardened diameter to bar diameter—that is, the ratio of Du to D —increases and follows the curved lines in Fig. 4.6 representing severity of quench. Thus, if equivalent cooling time is measured in different bar diameters and plotted as the ratio of Du to D against D , it is possible to match the curve against the curved lines representing severity of quench and graphically determine HD . The severity of quench (H) is found by dividing HD by bar diameter D .

4.7. Determination of Severity of Quench for Round Bars and Plates

In determining the severity of quench by the method of Grossmann, Asimow, and Urban,⁶⁵ at least three cylindrical bars of graduated size

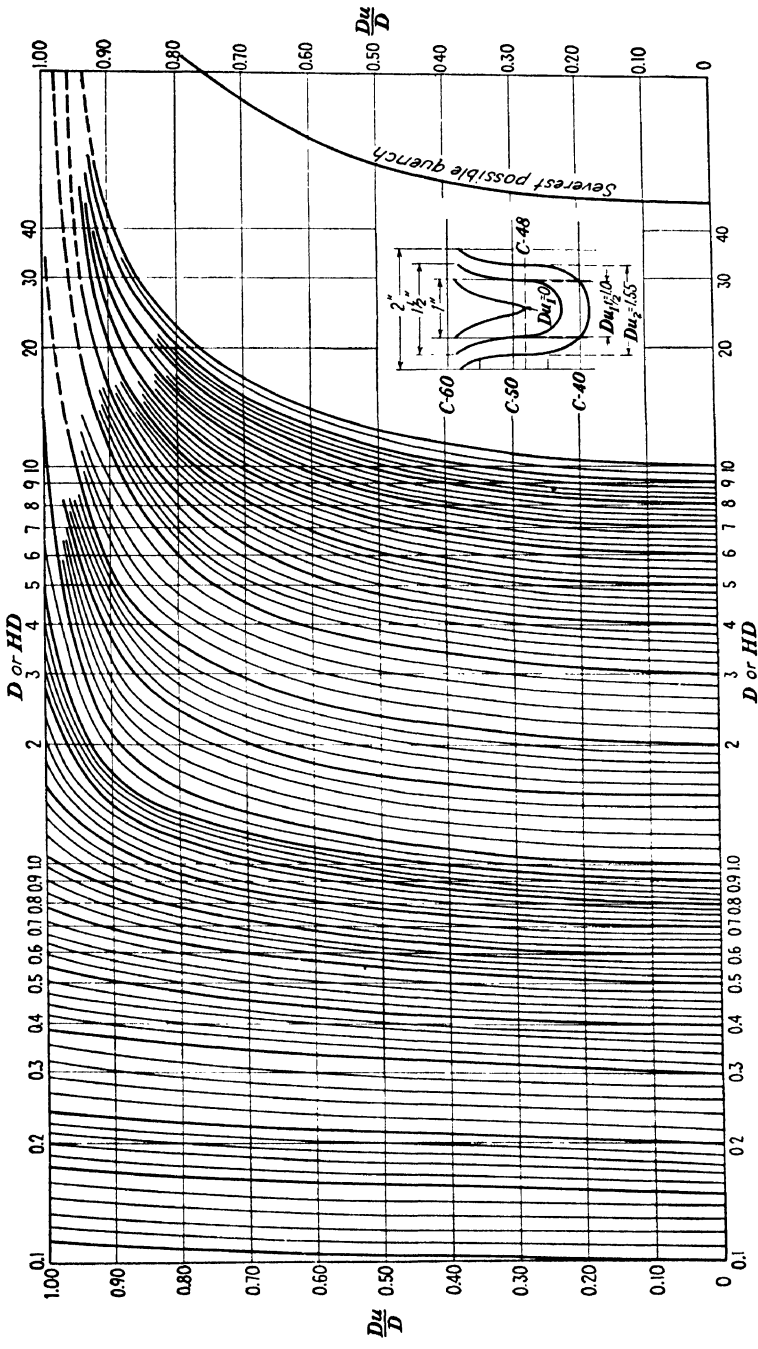

FIG. 4.6. Relation between quenching severity, bar diameter, and depth of hardening. (Grossmann.)⁶⁶

are quenched under the conditions for which the numerical value for quenching severity is to be determined. After quenching, the bars are sectioned and etched to reveal the hardened case and the unhardened core as shown in Fig. 4.7. The diameter of the unhardened core, that is, the diameter of the dark-etching material, is measured and is expressed as Du .

The value of Du may also be determined from hardness traverse curves of the cross sections, such as those shown by the small inset

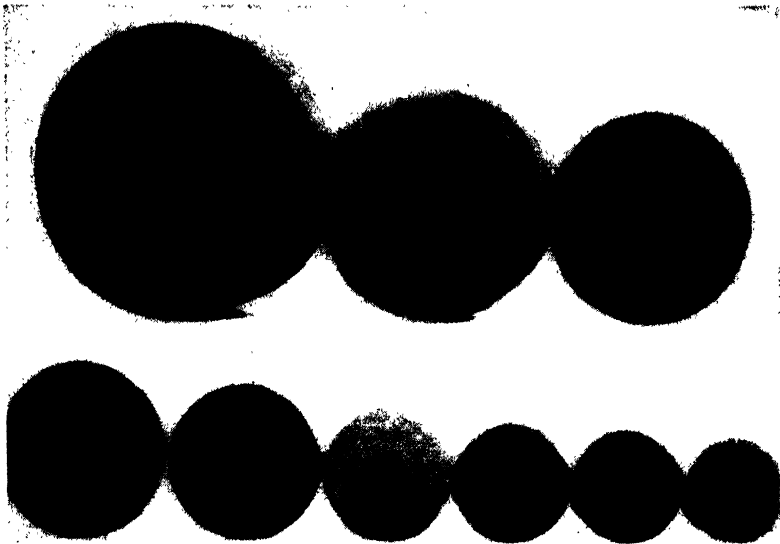

FIG. 4.7. Unhardened cores of graduated series of etched bars quenched under identical conditions. (Grossmann.)⁶⁶

drawing in Fig. 4.6. A hardness common to the three (or more) curves, say Rockwell C 48 in the diagram, is selected, and the distance between the points on the cross section at which this hardness occurs is the value of Du .

From the value of Du for each bar the ratios between the unhardened core and the bar diameters are calculated. For example, in the inset in Fig. 4.6 the unhardened core of the 2-in. bar or Du_2 is 1.55 in. so that $Du \div D = 1.55 \div 2.00 = 0.775$. These ratios are plotted against the diameters of the bars as shown in Fig. 4.8. The plot should be made on transparent semilog paper having coordinate dimensions equaling those of the master chart shown in Fig. 4.6 or on a cover slide of some transparent material over the master chart with reference lines drawn perpen-

dicular to and horizontal to the abscissa of the master chart. A line may be drawn through the plotted points if desired.

The transparent cover slide or graph paper that is superimposed on the master chart is moved horizontally back and forth until the plotted points fall on a single matching curve. Assume, for example, that the line determined experimentally (Fig. 4.8) falls on the curved line that intersects the abscissa at $HD=5.0$ and also intersects the horizontal line $Du/D=0.775$ at the vertical line $HD=10.0$. The numerical value

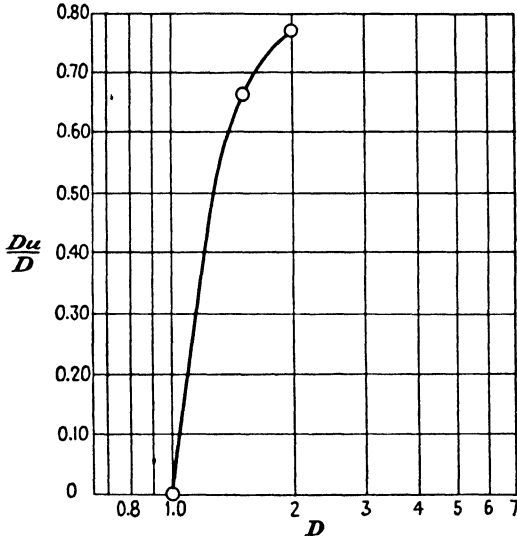

FIG. 4.8. Ratio of unhardened core indicated for 48 Rockwell C (inset, Fig. 4.6) and bar diameter against bar diameter.

for the quenching severity H is determined by dividing the value for HD at which the curve intersects the horizontal line representing a given Du/D ratio, by the diameter of the bar to which the ratio applies. For example, the curved line intersects the horizontal line for $Du/D=0$ at an HD value of 5.0. This is then divided by the diameter of the bar, that is, by 1.0 in which $Du/D=0$. Thus, $H=HD \div D=5.0 \div 1.0=5.0$. In the 2.0-in. diameter bar $Du/D=0.775$ and $HD=10.0$ so that $H=HD \div D=10.0 \div 2.0=5.0$. The value of H is considered to be constant for all sections quenched under the same condition as the bars on which the value for H was determined.

In an analogous manner the numerical value for severity of quench H may be determined from data obtained on quenched plates by means of the master chart shown in Fig. 4.9. The unhardened thickness is called Lu and the plate thickness is represented by L .

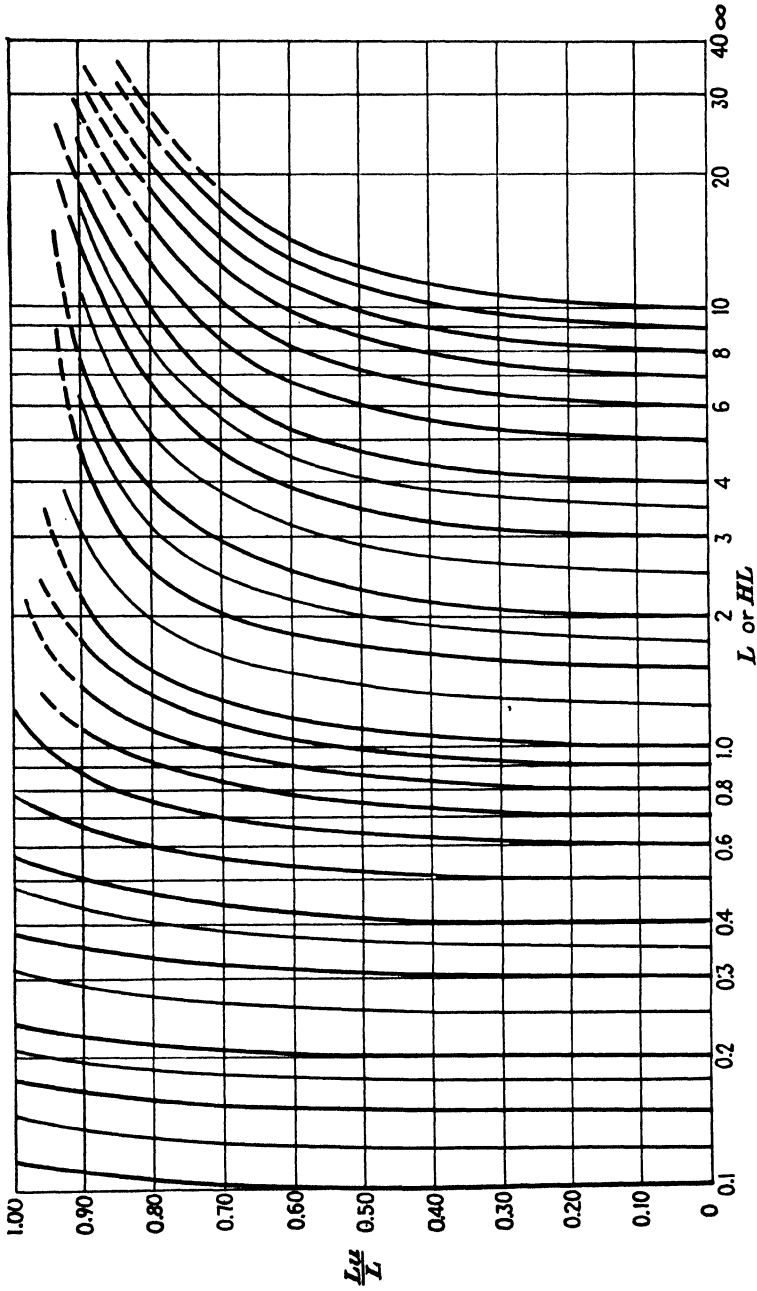

Fig. 4.9. Relation between quenching severity, plate thickness, and depth of hardening. (A simow and Grossmann.)¹¹

4.8. Determination of Severity of Quench from Jominy Tests

In the method developed by Lamont⁹⁶ for determining the numerical value for severity of quench, it is necessary to make a Jominy test (described in detail in Chapter 6) of a steel of medium hardenability and quench a bar of the same steel of such size that it will harden only

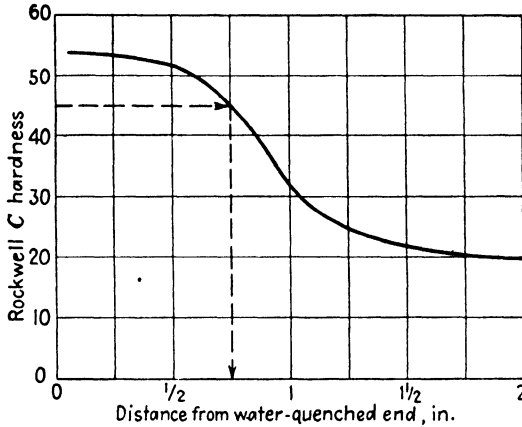

FIG. 4.10. Jominy hardenability curve of a low-alloy steel. (Lamont.)⁹⁶

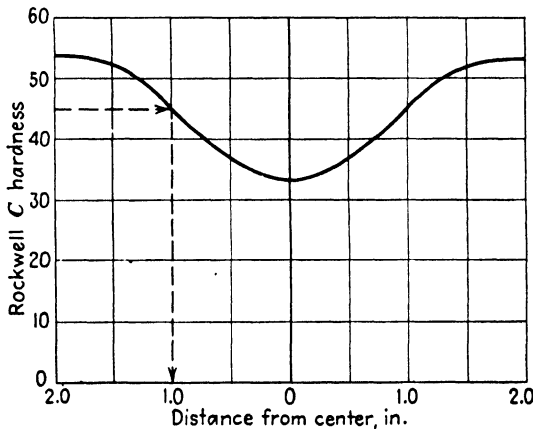

FIG. 4.11. Cross-sectional hardness of a 4-in. diameter quenched bar of the same steel. (Lamont.)⁹⁶

partially at the center when quenched under the conditions for which the H value is to be determined. Assume that the steel has a Jominy hardness curve similar to that shown in Fig. 4.10 and that a 4-in. diameter quenched bar of the same steel has a hardness distribution similar to that shown in Fig. 4.11. A hardness value (say, of 45

Rockwell C) is then selected that is found in both the Jominy curve and the hardness-distribution curve. This hardness, as shown in Figs. 4.10 and 4.11, occurs at a Jominy depth of $\frac{3}{4}$ in. from the water-quenched end and at a distance of 1.0 in. from the center of the 4.0-in. diameter bar; that is, at a fractional depth between center and surface of the bar of $r/R=0.5$, where r is the distance from the center of the bar to 45 Rockwell C (Fig. 4.11) and R is the radius of the bar.

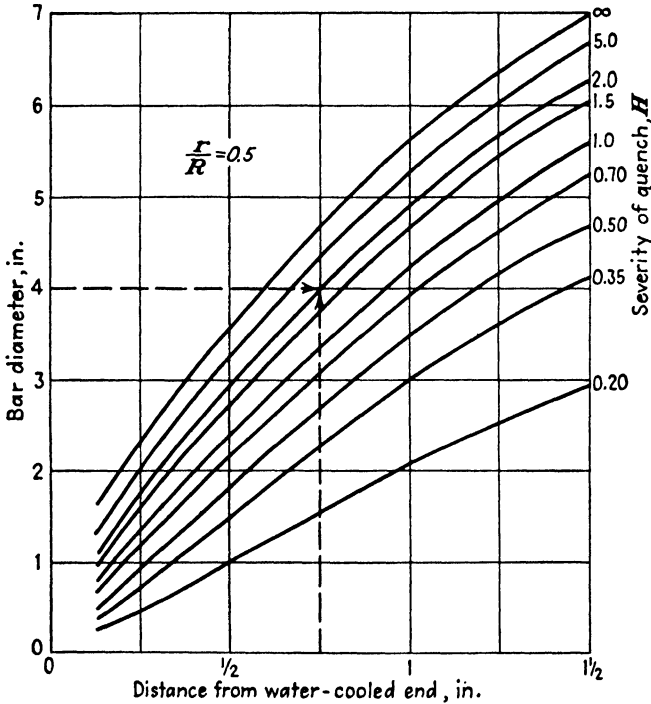

Fig. 4.12. Relation between severity of quench, Jominy depth, and bar size at a fractional depth $r/R=0.5$. (Lamont.)⁹⁶

Reference is made to the appropriate one of the charts indicating the relation between Jominy depth, severity of quench, and bar diameter for various fractional depths shown in Figs. 4.14 to 4.24 or, in this example, to the chart for the fractional depth $r/R=0.5$ shown in Figs. 4.12 and 4.19. The value for the severity of quench is determined, as shown in Fig. 4.12, by the intersection of the horizontal line representing 4.0-in. diameter and the vertical line for a Jominy depth of $\frac{3}{4}$ in. at the curved line $H=2.0$, which represents the numerical value for the severity of quench in this case. Once the H value has been estab-

lished on one steel it is presumed to be applicable to other steels and other sections quenched under the same conditions.

4.9. Application of Jominy Test and Severity of Quench to Round Bars

For illustration of the manner in which the relation between Jominy hardness, severity of quench, and bar size may be applied to practical operations, assume that for a steel having the same Jominy hardness characteristics as the one shown in Fig. 4.13, it is desired to know the

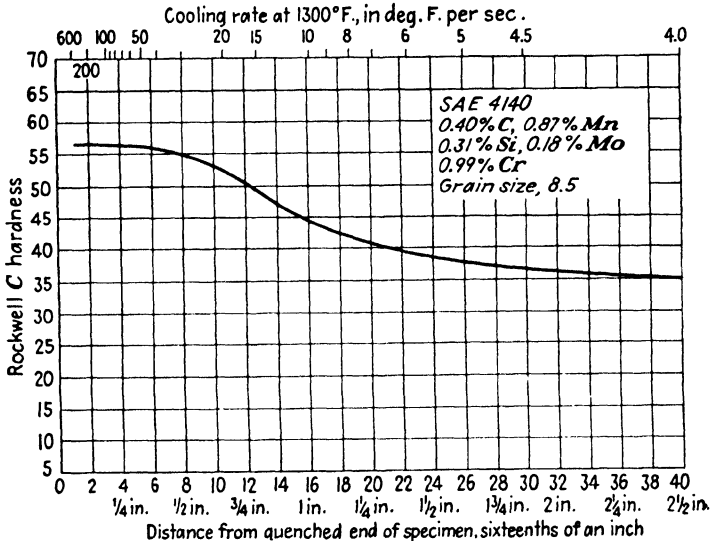

FIG. 4.13. Jominy hardenability curve of a SAE 4140 steel.

maximum size of round bar that will fully harden when cooled with a quenching severity $H=0.35$; the center hardness of the fully hardened bar; the severity of quench required to develop full hardening in a 2.0-in. bar; the severity of quench necessary to develop full hardening to a depth of 0.3 in. below the surface in a 3.0-in. diameter bar; and finally, the cross-sectional hardness that is obtained in a 4.0-in. diameter bar when quenched with a severity $H=1.0$. Use is made of the relations shown in Figs. 4.13 to 4.24 to determine the desired information.

In the steel under discussion (Fig. 4.13), maximum hardening is considered to occur in the Jominy specimen to a depth of 6 sixteenths of an inch and is represented by a hardness of 55.8 Rockwell C. In order to find the maximum size that will develop full hardening at the center in quenching with a severity $H=0.35$, reference is made to Fig. 4.14. The vertical line for a Jominy depth of 6 sixteenths of an inch intersects

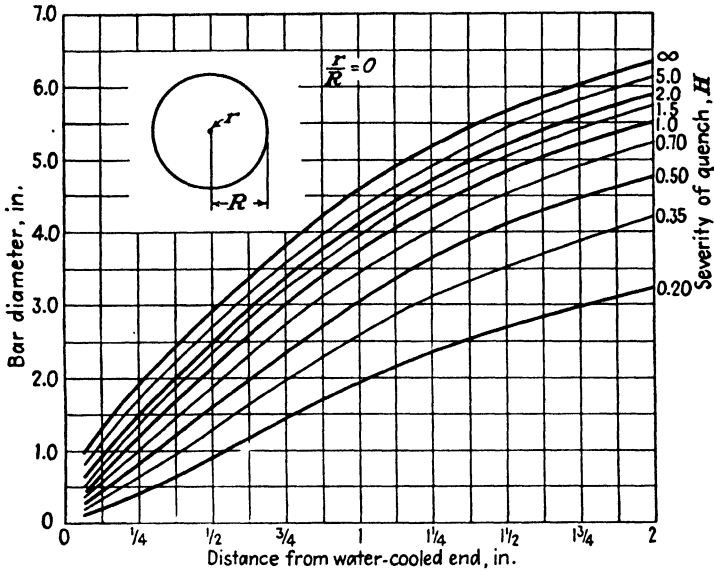

FIG. 4.14. Location on end-quenched Jominy hardenability specimen corresponding to the center of round bars. (Lamont.)⁹⁸

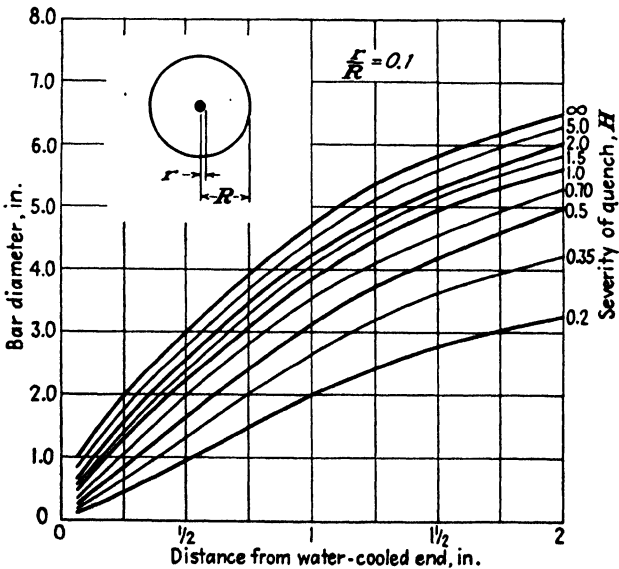

FIG. 4.15. Location on end-quenched Jominy hardenability specimen corresponding to 10 per cent from the center of round bars. (Lamont.)⁹⁸

the quenching-severity curve $H=0.35$ at a point on the horizontal line indicating a bar diameter of about 1 in. in diameter. A hardness after quenching of 55.8 Rockwell C would be expected in bars 1.0 in. or less in diameter when quenched under these conditions.

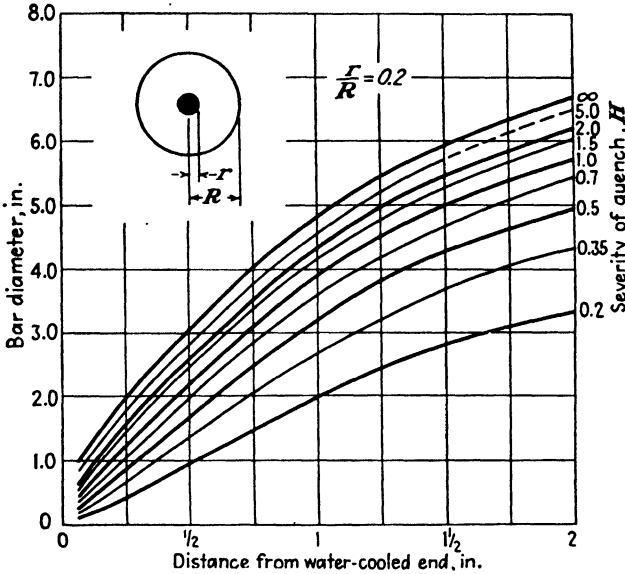

Fig. 4.16. Location on end-quenched Jominy hardenability specimen corresponding to 20 per cent from the center of round bars. (Lamonl.)⁹⁸

The severity of quench necessary to develop full hardening at the center of a 2.0-in. diameter bar, comparable to the Jominy depth of 6 sixteenths of an inch in Fig. 4.13, is indicated where the vertical line at 6 sixteenths of an inch of Jominy depth in Fig. 4.14 intersects the horizontal line for the 2.0-in. diameter bar on the curved line $H=2.0$.

Estimation of the severity of quench necessary to develop full hardening to a depth of 0.3 in. below the surface of a 3.0-in. diameter SAE 4140 bar may be made from Fig. 4.22 representing fractional depth of hardening of 0.8. In this bar, the fractional depth of hardening between center and surface is $\frac{r}{R} = \frac{1.5 - 0.3}{1.5} = \frac{1.2}{1.5} = 0.8$. By reference to Fig. 4.22 for the fractional depth $r/R=0.8$ it will be found that the vertical line for the Jominy depth of 6 sixteenths of an inch intersects the horizontal line for a diameter of 3.0 in. at a point just above the curved line $H=1.0$. A 3.0-in. diameter bar would, therefore, be expected fully to harden to a depth of 0.3 in. below the surface and would have a Rockwell C hardness of 55.8 at that depth when quenched with a severity $H=1.1$. The

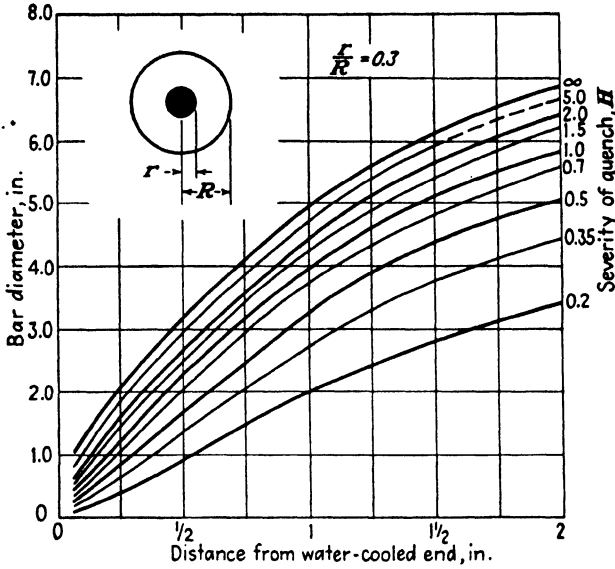

FIG. 4.17. Location on end-quenched Jominy hardenability specimen corresponding to 30 per cent from the center of round bars. (Lamont.)⁹⁸

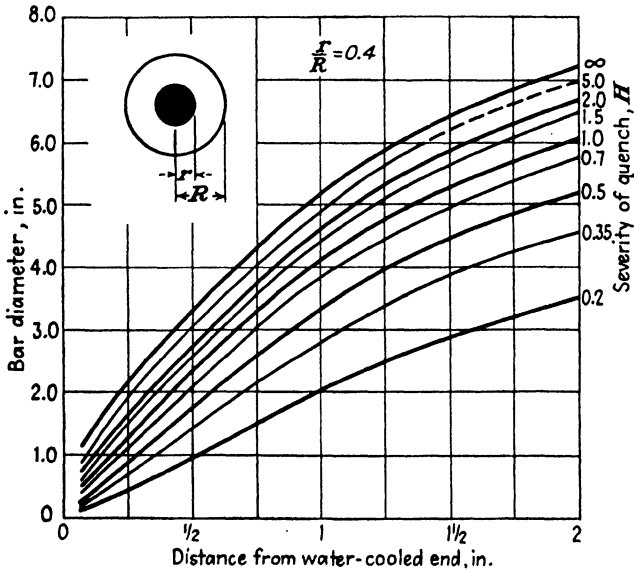

FIG. 4.18. Location on end-quenched Jominy hardenability specimen corresponding to 40 per cent from the center of round bars. (Lamont.)⁹⁸

center of this 3-in. diameter bar quenched with a severity of $H=1.1$ would be equivalent, according to Fig. 4.14, to a Jominy depth of $11\frac{1}{2}$ sixteenths of an inch and, according to Fig. 4.13, should have a hardness of 51.0 Rockwell C.

In order to estimate the cross-sectional hardness of a 4.0-in. diameter bar of the SAE 4140 steel when quenched with a severity $H=1.0$, Figs. 4.14 to 4.24 are used. The hardness at the center of the bar is deter-

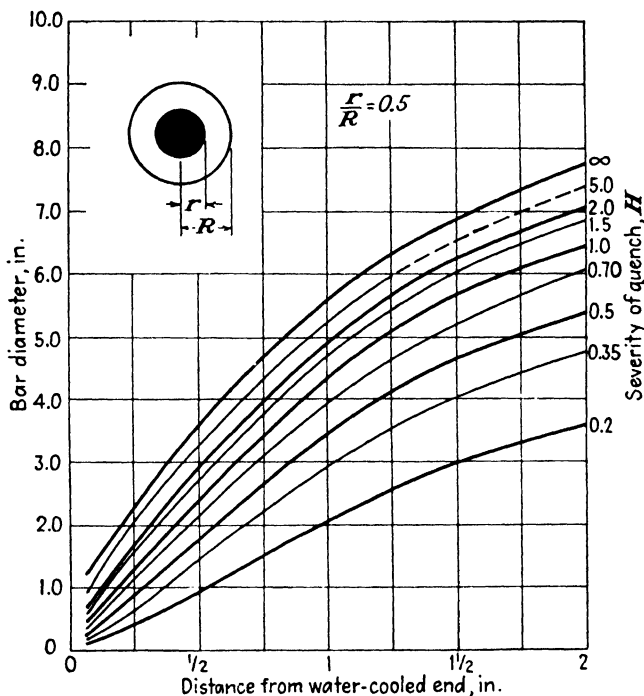

Fig. 4.19. Location on end-quenched Jominy hardenability specimen corresponding to 50 per cent from the center of round bars. (Lamont.)⁹⁶

mined by reference to Fig. 4.14 for a fractional depth of $r/R=0$, in which a diameter of 4 in. and a severity of quench of $H=1.0$ indicate a Jominy depth of about 18 sixteenths of an inch. At this distance on the Jominy hardness curve in Fig. 4.13 the hardness is 42.8 Rockwell C and is considered to be the center hardness. At a fractional depth of $r/R=0.1$, or at a distance ($r=2.0 \times 0.1$) 0.20 in. from the center of the bar, according to Fig. 4.15, a diameter of 4.0 in. and a severity of quench $H=1.0$ are equivalent to a Jominy depth of 17 sixteenths of an inch. At this distance on the Jominy hardness curve the hardness is 43.2

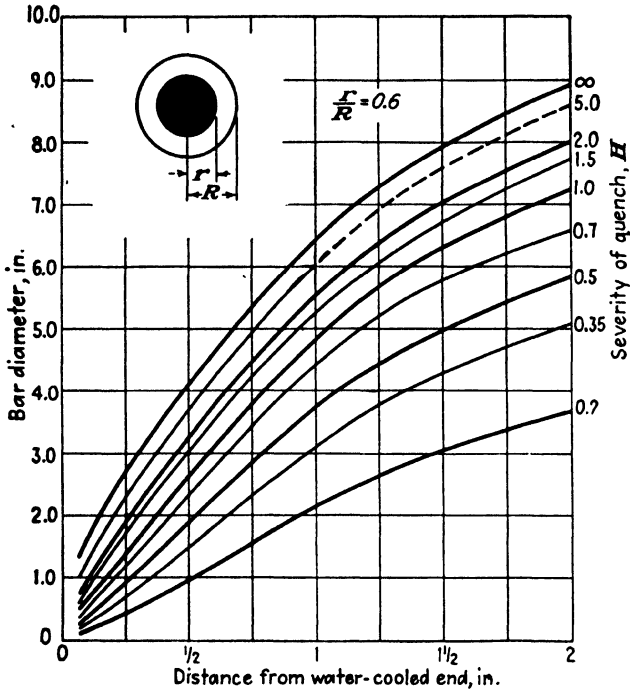

FIG. 4.20. Location on end-quenched Jominy hardenability specimen corresponding to 60 per cent from the center of round bars. (Lamont.)⁹⁶

Rockwell C, so that at a distance of 0.20 in. from the center of the bar a hardness of 43.2 Rockwell C would be expected. Hardness values for the other locations in the bar are determined in the same manner from Figs. 4.16 to 4.24; the cross-sectional hardness gradient is as follows:

Fractional depth, r/R	Distance from center, in.	Rockwell C hardness
0.0 (center)	0.0	42.8
0.1	0.2	43.2
0.2	0.4	43.8
0.3	0.6	44.2
0.4	0.8	45.0
0.5 (midway)	1.0	46.0
0.6	1.2	48.5
0.7	1.4	51.8
0.8	1.6	54.5
0.9	1.8	55.8
1.0 (surface)	2.0	56.6

Caution should be used in applying these calculations too rigidly to small bars and to the surfaces of very large bars, as experience has shown that the actual hardness may be somewhat higher than calculated.

4.10. Application of the Severity of Quench from the Jominy Test to Squares, Flats, and Plates

The relation of Jominy hardenability to the center of square bars, 1 to 2 flats, and plates is shown in Figs. 4.25, 4.26, and 4.27. With these

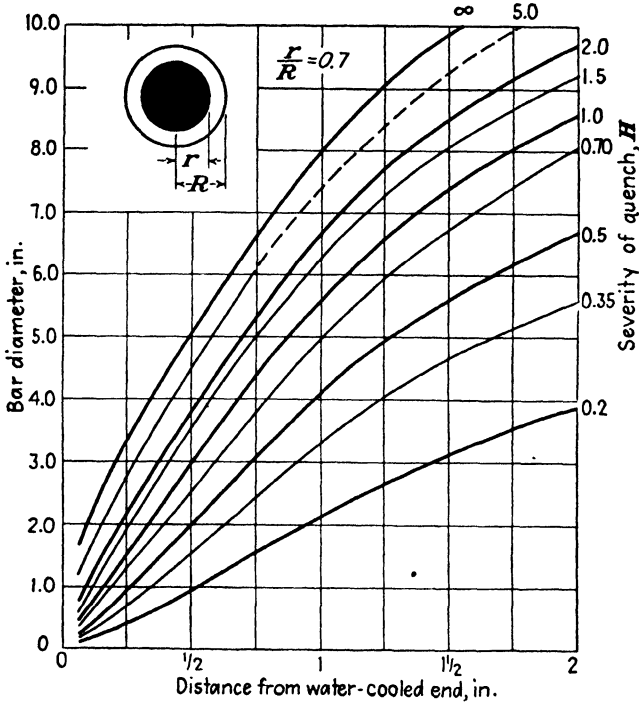

FIG. 4.21. Location on end-quenched Jominy hardenability specimen corresponding to 70 per cent from the center of round bars. (Lamont.)⁹⁸

diagrams it is possible to estimate the degree of hardening to be expected at the center of these shapes when hardened with quenching severities of $H = \infty$, $H = 1.0$ (still water), and $H = 0.35$ (still oil). The charts are used in the same manner as Fig. 4.14 for the center of round bars. Although the relations are not given in the same degree of completeness as in the charts for round bars, an approximation sufficient to estimate the extent of hardening may be gained from these diagrams.

A comparison for the center of square bars, 1 to 2 flat bars, plates, and round bars hardened with quenching severities of $H = \infty$, $H = 1.0$,

and $H=0.35$ is shown in Figs. 4.28, 4.29, and 4.30. With these diagrams it is possible to estimate the size of bar that will harden at the center to the same degree as one of another shape of known size when quenched with one of the illustrated quenching severities. For instance, if a 4.0-in. round bar will harden to 45 Rockwell C at the center when quenched with a severity of $H=0.35$, then, according to Fig. 4.30, a

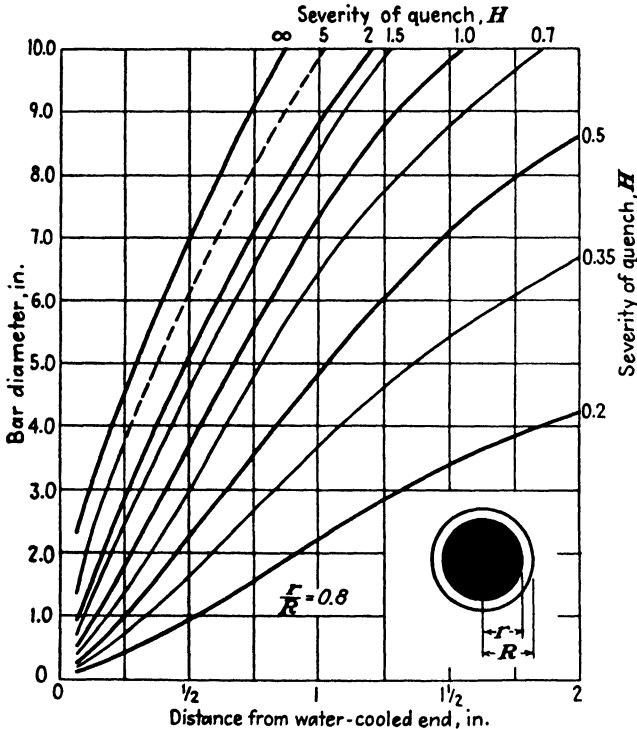

FIG. 4.22. Location on end-quenched Jominy hardenability specimen corresponding to 80 per cent from the center of round bars. (Lamont.)⁹⁶

$3\frac{5}{8}$ -in. square, a 1 to 2 flat bar $2\frac{1}{8}$ in. thick by $5\frac{9}{8}$ in. wide, or a plate $2\frac{1}{2}$ in. thick will also harden to 45 Rockwell C at the center when quenched in a similar manner. It will be noted in the diagrams that the ratio relation between different shapes changes with the severity of quench, so that it cannot be assumed that there is a fixed ratio between two shapes unless the quenching severity is the same.

4.11. Summary

By means of simplifying assumptions it has been possible to evaluate the severity of quench and the effects of mass in the heat treatment of

engineering steels. The errors inherent in these calculations are sufficiently serious so that the calculations may be misleading in extreme cases, but in general the calculations are at least as accurate as some of the other factors involved in hardening steel. Furthermore, since so many of the values used in calculation are determined empirically, such as the severity of quench of a given coolant under given conditions or the effect of mass in an irregular section, the errors are not so significant

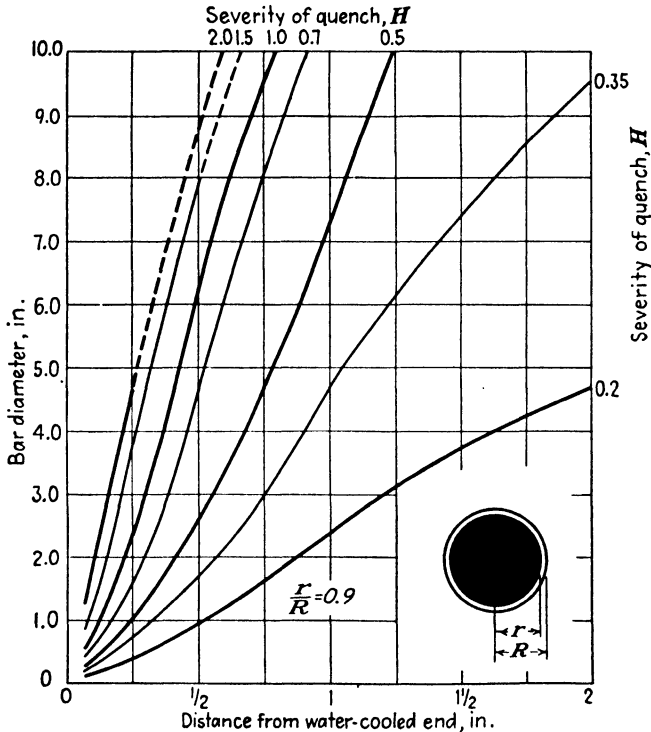

FIG. 4.23. Location on end-quenched Jominy hardenability specimen corresponding to 90 per cent from the center of round bars. (Lamont.)⁹⁶

as might be expected. Thus, although much more study must be given to the problem, the deficiencies should not obscure the fact that the rough estimation of cooling rate is a very useful tool, the importance of which should not be underestimated.

In using the methods outlined in this chapter to determine the relations between cooling rate, severity of quench, and bar size—which are based primarily on calculated values—the limitations of the methods, which have been emphasized, should be kept clearly in mind. For

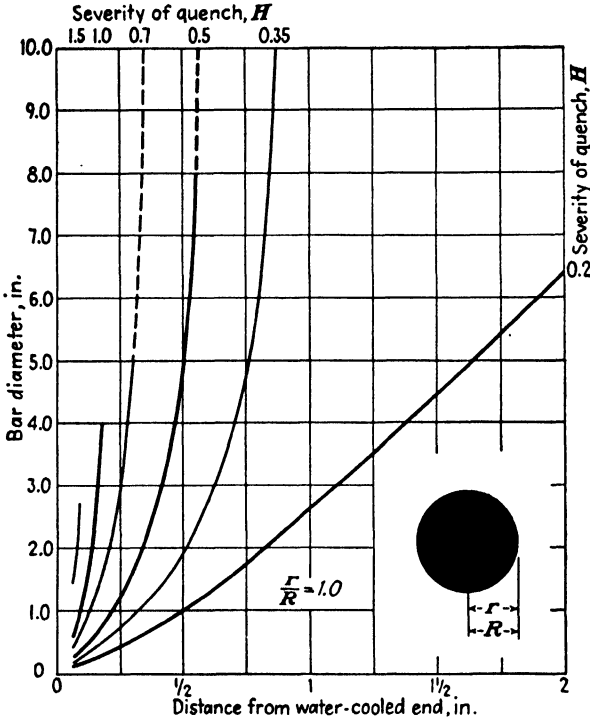

FIG. 4.24. Location on end-quenched Jominy hardenability specimen corresponding to the surface of round bars. (Lamont.)⁹⁸

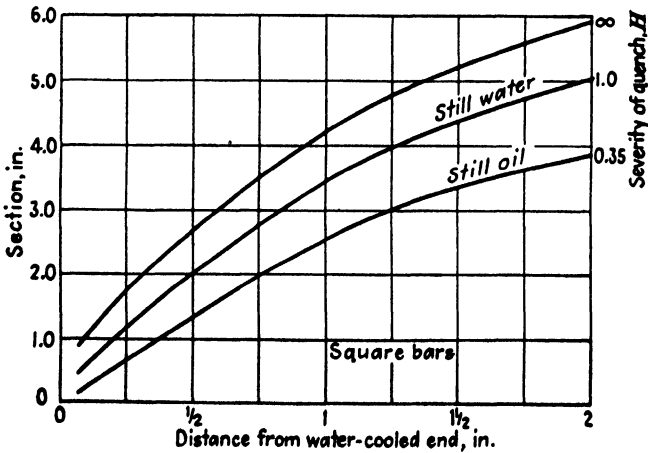

FIG. 4.25. Location on end-quenched Jominy hardenability specimen corresponding to the center of square bars. (Lamont.)⁹⁸

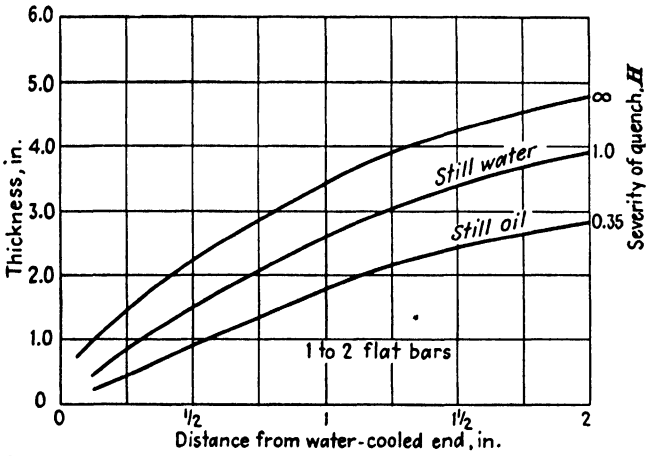

FIG. 4.26. Location on end-quenched Jominy hardenability specimen corresponding to the center of 1 to 2 flat bars. (Lamont.)⁹⁶

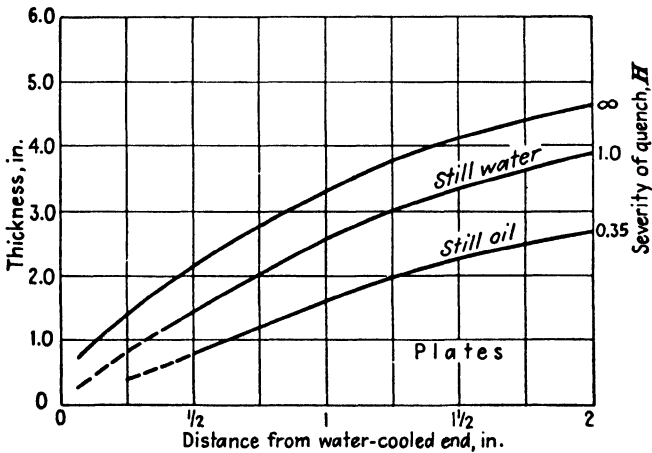

FIG. 4.27. Location of end-quenched Jominy hardenability specimen corresponding to the center of plates. (Lamont.)⁹⁶

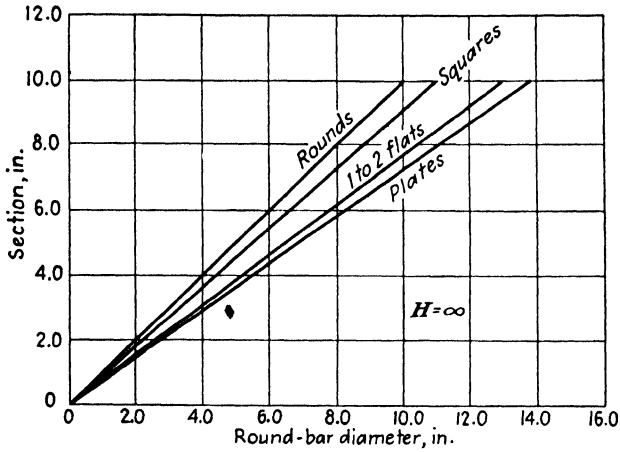

FIG. 4.28. Relation of round-bar diameter to the bar or plate thickness for an ideal quench ($H = \infty$). (Lamont.)⁹⁸

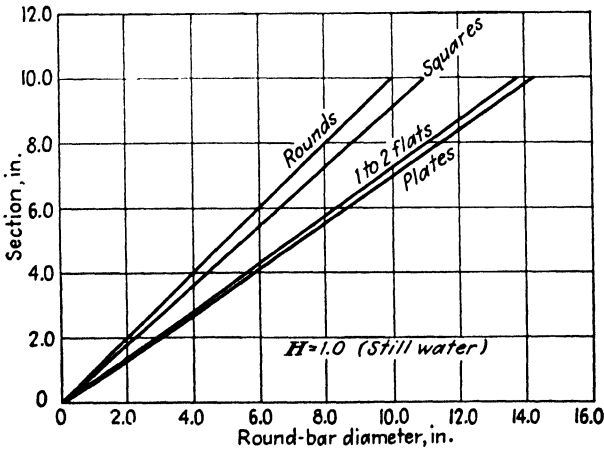

FIG. 4.29. Relation of round-bar diameter to bar or plate thickness for quenching in still water ($H = 1.0$). (Lamont.)⁹⁸

example, the cooling rate within $\frac{1}{4}$ in. of the water-cooled end of a Jominy specimen is usually faster than indicated so that the accuracy of the charts given in Figs. 4.14 to 4.20 is questionable for very small sections and near the surface of larger sections. There has been some evidence that the effective H value for constant quenching conditions is higher in very small sections and is changed somewhat when there is scale on the bars or when the coefficient of thermal diffusivity is appreciably

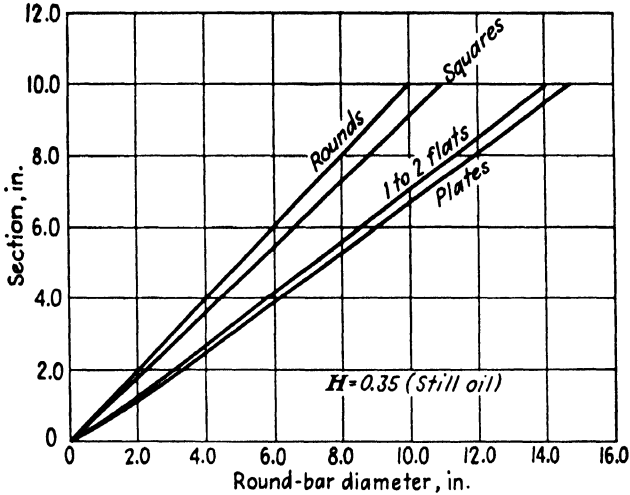

FIG 4.30. Relation of round-bar diameter to bar or plate thickness for quenching in still oil ($H = 0.35$). (Lamont.)⁹⁶

affected by alloy content. It is also considered doubtful whether it is practically possible to produce the very thin hardened skin that is theoretically possible in shallow-hardening steels. The effects of strain on austenite transformation are not taken into consideration. Although the applicability of the calculations must be qualified in the case of small sections, they have proved to be generally suitable for estimation of the relation between cooling rate, severity of quench, and bar size with a useful order of accuracy.

CHAPTER 5

HARDNESS AND HARDENABILITY

ONE OF THE INHERENT characteristics of steel that has been treated so that the structure is almost entirely martensitic is that the treatment used—namely, cooling very rapidly from a red heat to room temperature—almost invariably causes undesirable internal stresses accompanied by brittleness and occasionally distortion, as well as the desired high hardness. To relieve these stresses and to eliminate this brittleness it is necessary to temper the quenched material, which, at the same time, lowers the strength and the hardness.

It is evident from the foregoing that the hardness (and strength) of the quenched section must be high enough to permit adequate tempering to relieve internal stresses and eliminate brittleness without softening below the desired strength and hardness levels.

It is a generally accepted theorem in the present-day metallurgy of the solid state that the most satisfactory combination of mechanical properties in a quenched and tempered carbon or low-alloy steel depends upon securing an essentially martensitic structure throughout the cross section; and for a large number of steels, and for sizes larger than a small tool or a razor blade, it depends on the hardenability of the steel whether this structure can be obtained.

The two most vital factors in securing the best combination of mechanical properties in engineering steels are, therefore, hardness and hardenability—which are the subject of the discussion in this chapter.

5.1. Relation of Hardness to Structure

Unalloyed carbon steel is essentially an aggregate of iron carbide (cementite) in a matrix of relatively soft ferrite and, as brought out in Chapter 9, the properties of a steel depend primarily on the composition, size, and distribution of the carbides in the matrix. Alloying elements, when added to carbon steel, may affect the hardness and strength of the ferrite, they may form carbides and, as discussed earlier, they usually affect the temperature where austenite transforms to pearlite, and they change the composition of the eutectoid. In addition, the commonly used alloying elements (except cobalt) tend to increase the hardenability—some strongly, some weakly.

TABLE 5.1. Principal Effects of Alloying Elements on Medium- and High-Carbon Steels*

Alloying element	Effect in strengthening ferrite	Effect in forming carbides	Effect on transformation temperature	Effect on hardenability
Manganese	Strong	Weak	Lowers	Strong
Silicon	Strong	None	Raises	Moderate
Phosphorus	Strong	None	Raises	Moderate
Nickel	Moderate	None	Lowers	Moderate
Chromium	Weak	Moderate	†	Strong
Copper	Moderate	None	Lowers	Weak
Molybdenum	Strong	Strong	Raises	Strong
Vanadium	Weak	Strong	Raises	Mild‡
Tungsten	Moderate	Strong	Raises	Moderate

*Adaptation of classification by Bain,¹⁸ modified subsequently by Bain¹⁹ and Austin.¹³

†Raises or lowers depending on carbon content.

‡May be strong if completely dissolved in austenite.

The effect of the common alloying elements on most of these characteristics is summarized in Table 5.1, and an approximate estimate of their effect on the strength of ferrite is shown in Fig. 5.1. Data obtained recently by Austin¹³ indicate that small amounts of manganese and molybdenum have a slightly greater effect, and small percentages of chromium have a slightly smaller effect, than those shown in Fig. 5.1.

Briefly, the effect of heat treatment is to change the size and distribution of the carbide particles, and the effect of alloying elements is to change the properties of the ferrite matrix, in some cases to change the composition of the carbides, and, most important, to affect the hardenability—the rate at which austenite transforms at subcritical

temperatures. The high hardness of steel is due primarily to the obstruction offered by the carbide particles to the ease with which the soft ferrite flows under stress. This has been shown by the work of Gensamer, Pearsall, Pellini, and Low,⁵⁴ who evaluated the effect of carbides in terms of the average distance in which the ferrite was free to slip without interference between carbide particles. Hardness was found to increase as the "mean ferrite path" became smaller. These tests were made on steels in which the carbides were large enough to be identified and counted microscopically, but extrapolation of the data

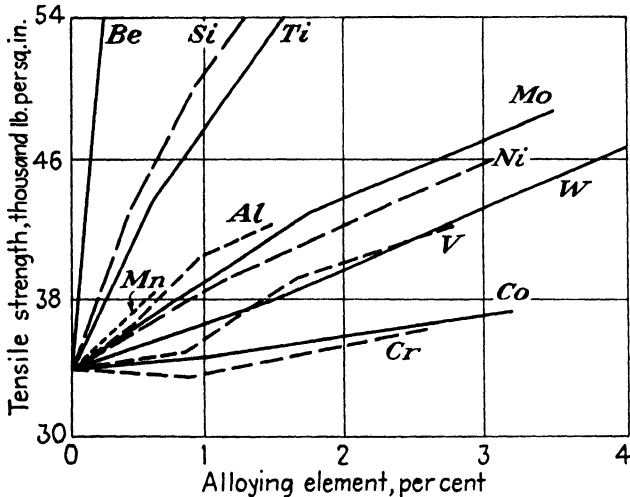

FIG. 5.1. Effect of the common alloying elements, when dissolved in iron, on the strength of ferrite. (Lacy and Gensamer, according to Comstock and Urban.)⁵¹

to molecular-size carbide particles indicated that the calculated tensile strength was consistent with the hardness in fully hardened steel.

In the temperature ranges of (isothermal) pearlite and bainite formation, the carbide particles become smaller as the transformation temperature is lowered. Correspondingly the hardness is increased by transformation at lower temperatures. Hardness values that were obtained in several low-alloy steels transformed at various temperatures are shown in Fig. 5.2. The scatter that is evident in steels transformed at 900 to 1100°F. (480 to 595°C.) is due to the change, in this temperature range, from a structure that is mostly lamellar to one that is predominantly acicular. Davenport⁴¹ calls attention to the fact that the greatest irregularity is evident in steels containing the strongly carbide-forming alloying elements; for example, steels 5140, 6140, and 4140.

5.2. Maximum Hardness Attained by Quenching

Maximum hardness is attained in steels containing considerable carbon only if they transform completely to martensite in quenching. The high hardness is supposedly associated with distortion of the cubic (ferrite) lattice by interstitial carbon atoms so that the lattice assumes

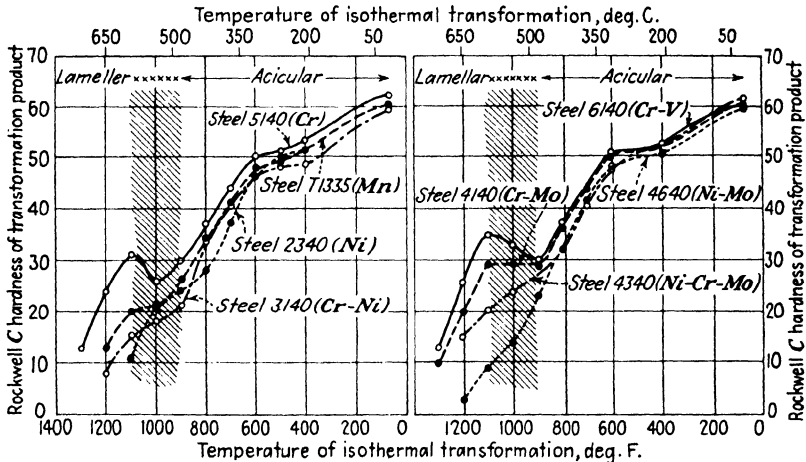

FIG. 5.2. Rockwell C hardness of several SAE steels transformed isothermally. (Davenport.)⁴¹

the tetragonal shape characteristic of freshly formed martensite. However, equal or even slightly higher hardness may be obtained when by tempering at very low temperatures the martensite is just decomposed to cubic ferrite and possibly molecular-sized carbide particles. If the effective carbide particle size is at a minimum, then the maximum hardness depends on the number of carbides and is proportional to carbon content. This has been demonstrated by Burns, Moore, and Archer²⁹ and is shown by the upper curve in Fig. 5.3.

The maximum hardness given by Burns, Moore, and Archer²⁸ represents the highest hardness values they observed on very small specimens of carbon and low-alloy steels quenched under favorable conditions. In practice, the average maximum hardness level is somewhat lower; Sisco,¹³² plotting data obtained by Boegehold,²² showed it as a hatched band as in Fig. 5.3; and Crafts and Lamont³⁷ reported maximum hardness obtained on Jominy test specimens of more than a thousand heats as shown by the band in Fig. 5.4. It will be noted that there is a spread of about ± 4 Rockwell C in the data given in Fig. 5.4; this is due primarily to errors inherent in Rockwell hardness testing and secondarily

HARDENABILITY AND STEEL SELECTION

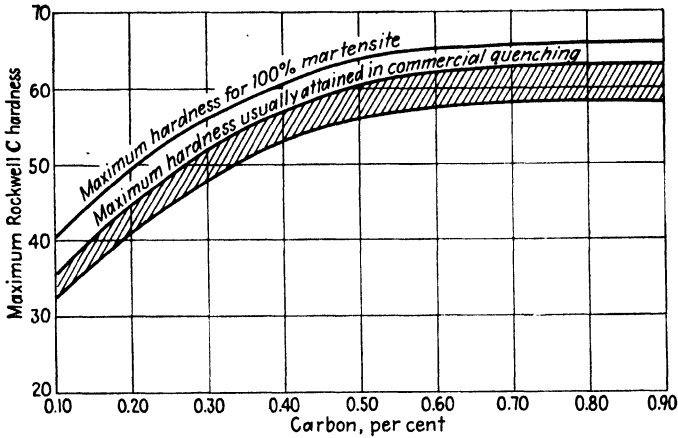

FIG. 5.3. Relation between carbon content and maximum martensitic hardness (upper curve); and maximum hardness usually attained (hatched band). (Plotted by Sisco,¹²² based on data by Burns, Moore, and Archer²⁸ and by Boegehold.²²)

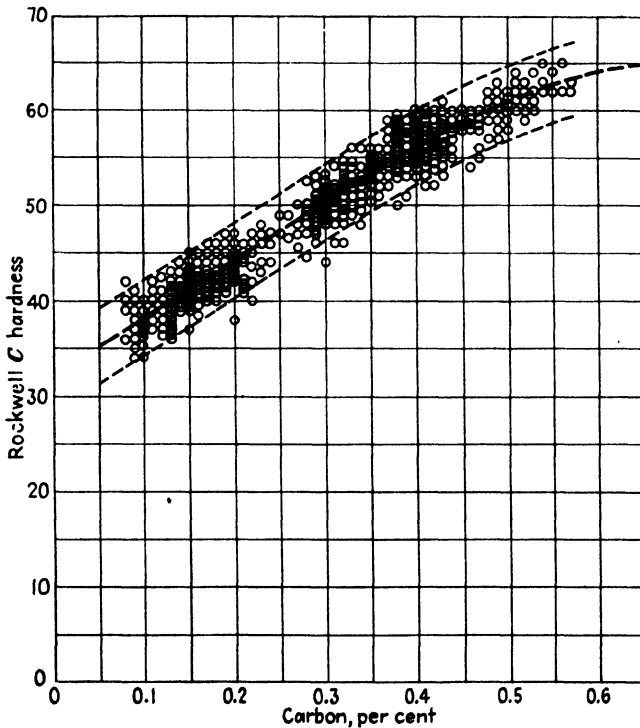

FIG. 5.4. Maximum hardness obtained by Jominy test specimens from 1063 steels. (Crafts and Lamont.)²⁷

to segregation, variations in heat treatment, and errors in the determination of carbon.

The level of average maximum hardness (Figs. 5.3 and 5.4) as dependent on carbon content is in agreement with the results of other tests⁴⁹ and is appreciably lower than the curve given by Burns, Moore, and Archer (Fig. 5.3). The level of hardness obtained from Jominy specimens (Fig. 5.4) seems to be typical of commercial heat treatment and is recommended for practical application. Maximum hardness has not been investigated extensively beyond the range of common low-alloy heat-treating steels, so that it cannot be stated categorically that alloys have no effect on it; but in the range of alloy constructional steels maximum hardness may be considered to be dependent only on carbon content.

5.3. Relation between Hardness and Hardenability

There is a definite quenching speed (the critical cooling rate) for each steel that produces the maximum as-quenched hardness of martensite, and faster rates produce no higher hardness. Slower rates permit a certain amount of transformation—depending on the location of the nose of the S-curve as shown in Fig. 3.16, p. 51—to take place at elevated temperatures and the hardness is less than the maximum. If the cooling rate is sufficiently high at the center of a section, maximum hardness will be obtained over the entire cross section. At slower rates of cooling there will be a decrease in the center hardness and thus there will be a hardness gradient over the cross section of the bar as illustrated in Fig. 4.7 (p. 66) and in Fig. 5.5 showing the hardness distribution in SAE 6140 steel after oil quenching bars of graduated sizes.

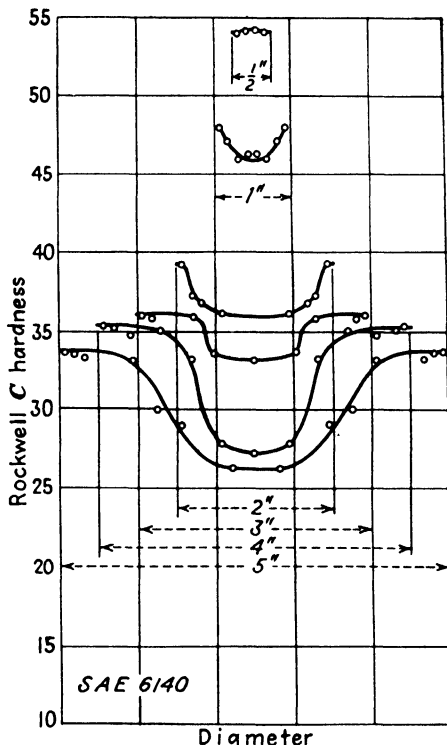

FIG. 5.5. Effect of section size on the hardness of oil-quenched SAE 6140 steel. (Grossmann.)⁶⁶

It is apparent from Fig. 5.5 that complete or full hardening was obtained in the $\frac{1}{2}$ -in. section and that the degree of hardening became progressively lower as the section size increased, and at progressively greater depths below the surface of the larger sections. Comparison of Fig. 5.5 with Fig. 5.6 shows the influence of composition and quenching medium on the degree of hardening. It is evident that the degree of hardening is affected by composition, section size, position within the section, and quenching medium.

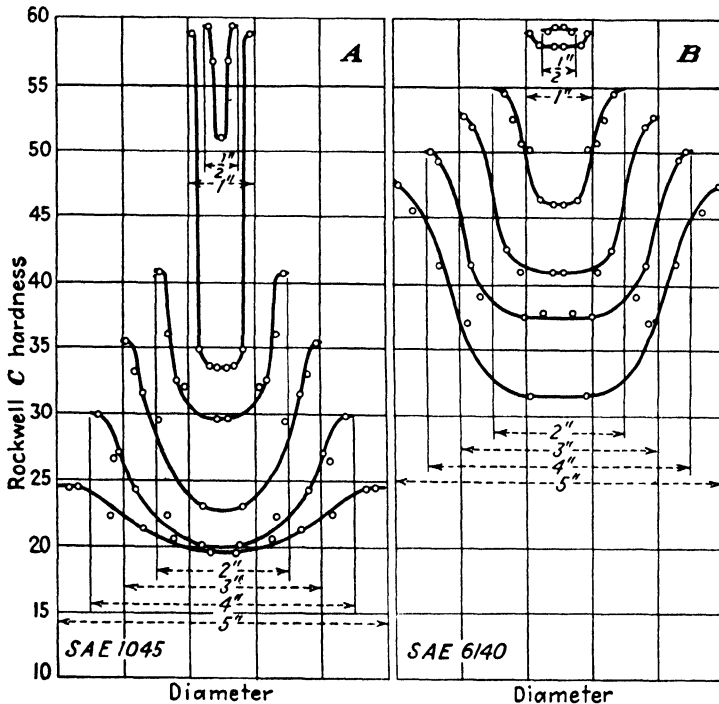

FIG. 5.6. Effect of section size on the hardness of water-quenched SAE 1045 and 6140 steels. (Grossmann.)⁶⁶

The degree of hardening that is developed in a steel may be expressed as a single hardness at a specific location within a section and may be measured as the cooling rate necessary to attain that hardness at the specified location. For example, in the SAE 6140 steel, if 55 Rockwell C at the center of a section is used to express degree of hardening, oil quenching will develop this hardness at the center of a round bar between $\frac{1}{2}$ and 1 in. in diameter (Fig. 5.5), while water quenching will produce the same hardness at the center of a round bar between 1 and 1 $\frac{1}{2}$

in. in diameter (Fig. 5.6B). If these sections are considered to be critical diameters, it is apparent that the severity of quench and the critical diameter define the cooling rate necessary to produce 55 Rockwell C at the center of quenched sections of this steel. That is, they measure the capacity of a steel to harden to a certain degree, in this case 55 Rockwell C.

In the comparison of two steels the maximum hardness is the same if the carbon contents are the same, but the degree of hardening in the interior of the larger sections may be different. Figure 5.6 shows the hardness gradients of water-quenched SAE 1045 steel in comparison with SAE 6140. It is evident that the maximum hardness values are the same, and it may be assumed that the actual carbon contents are very nearly alike. Since the SAE 1045 steel, when quenched in water, had a critical diameter of less than $\frac{1}{2}$ in. it is apparent that for the same quenching medium the degree of hardening is greater for the SAE 6140 steel. It is possible also to develop the same amount of hardening at the center of a $\frac{1}{2}$ -in. diameter bar in the SAE 6140 steel with a slower cooling rate than that necessary for the SAE 1045 steel as indicated by Figs. 5.5 and 5.6A. The slower the cooling rate at which a steel develops any specific degree of hardening the greater is its capacity to harden. As noted in the previous chapter, this susceptibility of a steel to overcome the effect of mass is its hardenability. For comparative purposes, it may be expressed in terms of any severity of quench and of any degree of hardening. In many cases it is desirable to refer to a standard condition such as ideal critical diameter representing 50 per cent martensite after an infinitely fast quench.

Obviously, it is advisable to evaluate the hardenability of a steel in order to predict its response to heat treatment and to compare it with other steels. The method of quenching bars of graduated diameters (Fig. 5.6) is laborious and sometimes impracticable so that other test methods have been devised. All of these hardenability test methods seek to simplify the test procedure by reducing the number of specimens. Some interpret the depth of penetration by extrapolation formulas, while others are designed to give graduated cooling rates. The most popular laboratory test method for engineering steels is the end-quench Jominy test devised by Jominy and Boegehold,⁸⁷ which is described in Chapter 6.

In order to make hardenability tests useful for more than limited application, it is necessary that they are strictly reproducible, and that they can be used to evaluate the cooling rates and to develop a correlation between simple shapes. After this has been done it is possible to determine the hardenability of a heat of steel and predict the response

to quenching in an article of a given size and shape. For prediction of the hardening reaction of another heat of even the same grade of steel some knowledge of the effect of composition on hardenability is desirable and is necessary for proper control in steelmaking. For this reason a number of studies have been made to determine the effect of composition on hardenability. These are discussed later in this chapter.

5.4. Standard Index of Hardenability—Critical Diameter and Ideal Critical Diameter

As emphasized previously, the capacity of a steel to harden depends upon the cooling rate and upon the factors of composition and grain size that control transformation at elevated temperatures. For purposes of comparing the capacity to harden of one steel with that of another steel, cooling rate, composition, and grain size have to be considered in relation to the microstructure resulting from the transformation of austenite. A convenient index by which to compare different steels is the cooling rate required to give a specific structure in a given steel. Grossmann, Asimow, and Urban⁶⁵ used structures with 50 per cent martensite as a reference point and in addition referred this structure to the section in which it could be obtained with an infinite severity of quench, so that a standardized expression of capacity to harden was established.

The selection of a specific microstructure for evaluation of critical cooling rates implies that the selected structure has special utility or that other useful structures can be related to it. Thus, a structure containing 100 per cent martensite is much more desirable as it is important to know the minimum cooling rate for complete hardening. It has, consequently, been used by many investigators, but it must be determined by careful microscopic examination and it is so influenced by microsegregation that it is frequently difficult to measure it accurately. Grossmann, Asimow, and Urban⁶⁵ used 50 per cent martensite as a reference structure because in high-carbon steels it can be measured accurately by macroscopic examination of etched cross sections (see Fig. 4.7, p. 66) or by hardness tests. This method is subject to the valid criticism that the non-martensitic constituents may be different in different steels; i.e., they may consist of proeutectoid ferrite or carbide and pearlite or bainite or a mixture of these constituents.

In this method of rating, microstructures containing more than 50 per cent martensite are considered to be *hardened*, while those containing less than 50 per cent martensite are *unhardened*. The critical diameter (D) is the largest size of cylindrical bar that contains no unhardened core after quenching, that is, the structure at the center contains exactly

50 per cent martensite. The critical size can be determined by quenching rounds of various sizes and macroetching the cross sections after polishing. The unhardened core will appear dark, while the hardened surface will appear white, as shown in Fig. 4.7. The fourth bar from the lower left in this figure is the largest bar of this series in which the unhardened core is just absent and is the critical size.

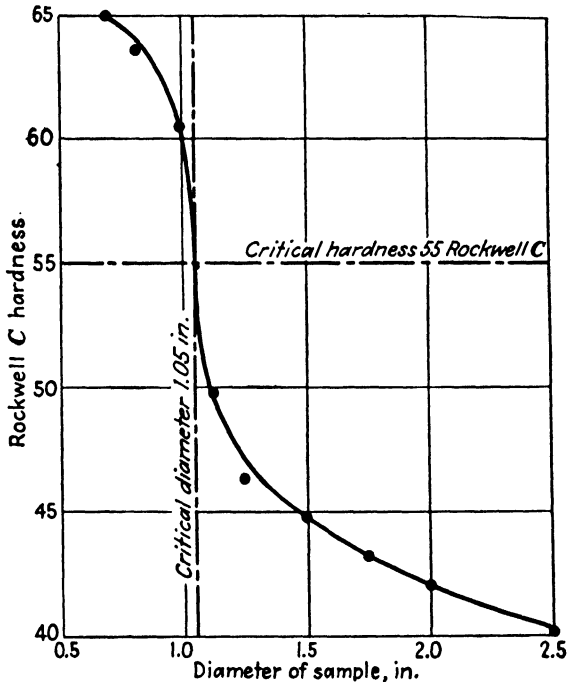

FIG. 5.7. Critical diameter determined from the center hardness of a series of quenched round bars. (Grossmann, Asimow, and Urban.)⁶⁵

The critical size can also be estimated from transverse hardness tests made on the cross section of quenched bars, by plotting the center hardness of the series of quenched bars against the diameter as shown in Fig. 5.7. The size of bar indicated at the point on the hardness curve at which the hardness is changing most rapidly, that is, the inflection point of the curve, is taken as the critical size. In Fig. 5.7, for instance, the critical size would be estimated as 1.05 in. in diameter.

In some low- and medium-carbon alloy steels the secondary constituent is bainite, which makes it difficult to distinguish macroscopically between the hardened and unhardened portions of the bar. In tests on these steels the estimation of critical size from the results of a

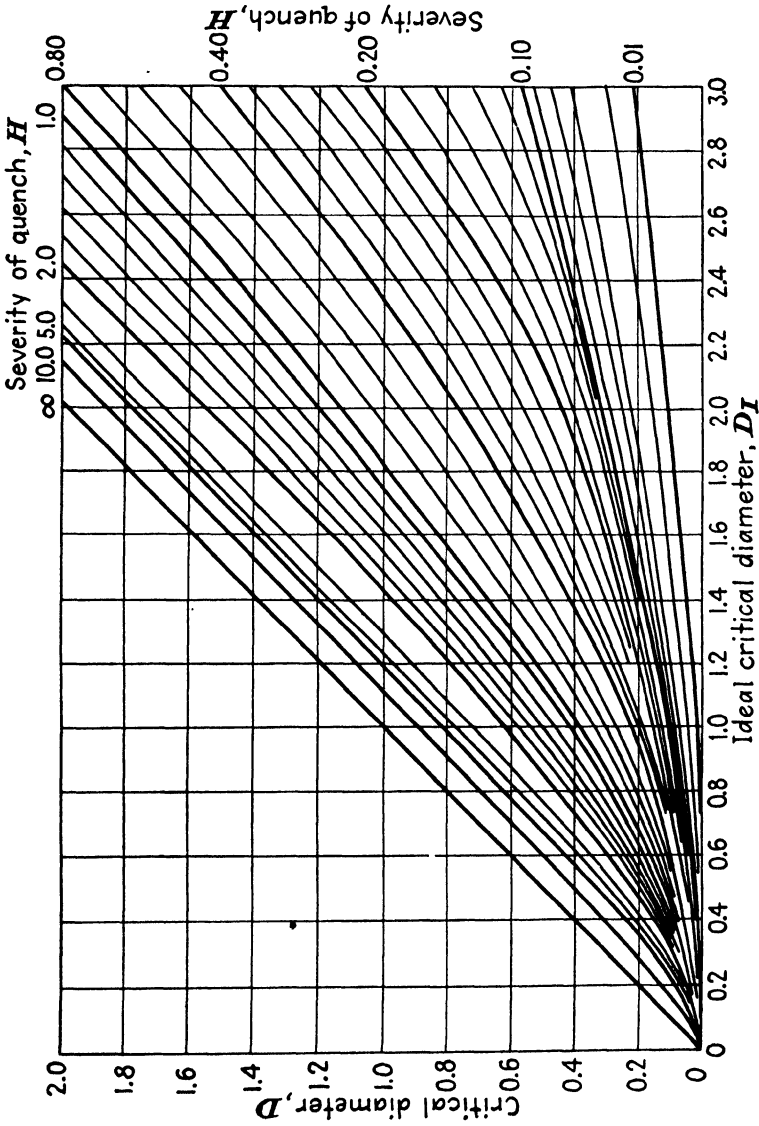

Fig. 5.8. Relation between critical diameter (D), severity of quench, and ideal critical diameter (D_I) for small bars. (Grossmann, Astinow, and Urban.)¹⁵

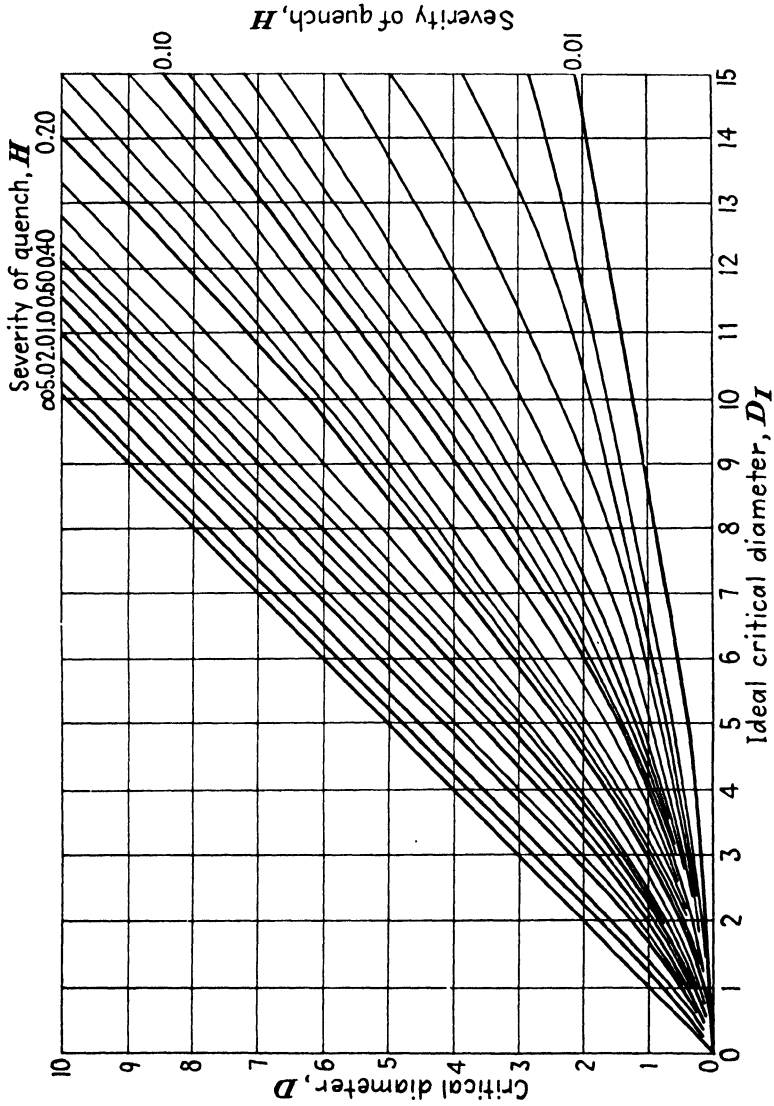

Fig. 5.9. Relation between critical diameter (D), severity of quench, and ideal critical diameter (D_I) for large bars. (Grossmann, Astmow, and Urban.)¹⁸

microscopic survey is preferable, but Grossmann⁶⁸ has given an approximate relation between carbon and 50 per cent martensite hardness that has been further elaborated by Field⁴⁹ as described in a later section.

5.5. Determination of Ideal Critical Diameter

Although the critical diameter (D) as a measure of hardenability effectively indicates the degree of hardening to be expected in a given steel and is useful in comparing the hardening characteristics of various steels, its applicability is limited to the quenching conditions under

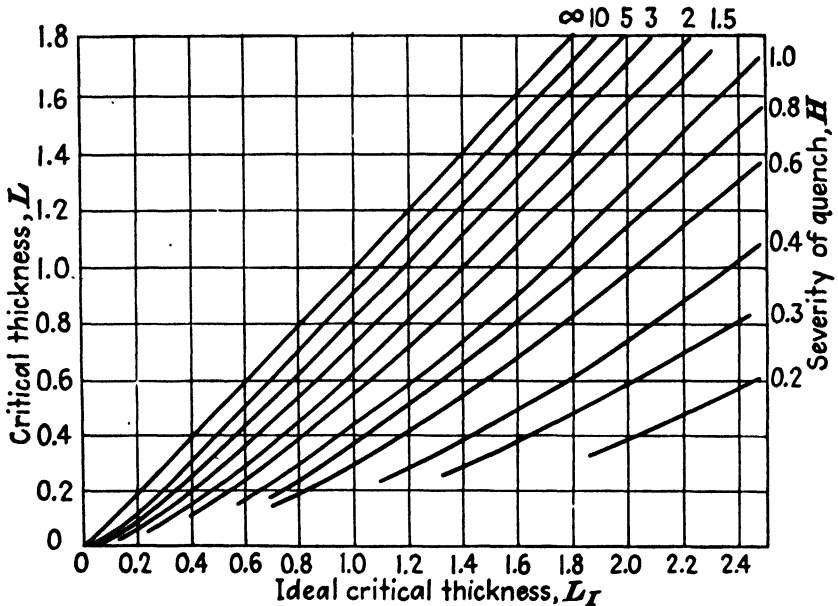

FIG. 5.10. Relation between critical plate thickness (L), severity of quench, and ideal critical plate size (L_I) for relatively thin plates. (Asimow and Grossmann.)¹¹

which the tests are made. As noted briefly in Section 4.6, Grossmann, Asimow, and Urban⁶⁵ suggested a universally applicable standard quench in which the surface of a bar is assumed to be cooled instantaneously to the temperature of the bath and maintained at that temperature during the cooling treatment. This ideal quench represents the fastest conceivable cooling with a severity of H equal to infinity. Since this is the fastest possible quench, the critical size indicated for such a quench would be the largest critical size that might be imagined for steel of a given hardenability and, therefore, gives a useful index for comparing different hardenabilities. Hardenability may then be

expressed as the critical diameter for standard ideal quench or as ideal critical diameter (D_I).

The relation between critical size (D), severity of quench, and ideal critical diameter (D_I) is shown in Figs. 5.8 and 5.9 for round bars, and in Figs. 5.10 and 5.11 for plates, where L is the critical thickness and L_I the ideal critical thickness, for H values representing various quenching severities.

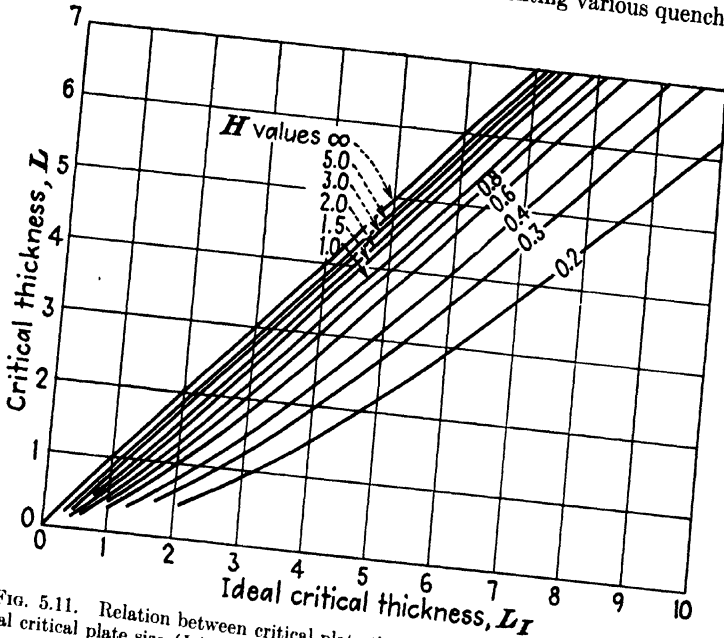

Fig. 5.11. Relation between critical plate thickness (L), severity of quench, and ideal critical plate size (L_I) for relatively thick plates. (Asimov and Grossmann.)¹¹

Although the relations shown in Figs. 5.8 to 5.11 are valid only for the 50 per cent martensite criterion of hardenability, analogous relations hold for any desired criterion such as 100 per cent martensite, 90 per cent martensite, zero martensite, or any other convenient degree of hardening.

After the critical diameter has been determined, the ideal critical diameter D_I may be established from the diagrams for the relation between critical size, severity of quench, and ideal critical diameters shown in Figs. 5.8 to 5.11. If, for example, the critical size of a steel is found to be 2.10 in. in diameter when quenched with a severity of $H=0.50$, the ideal critical diameter, according to Fig. 5.9, is 3.60 in.

The ideal critical diameter may also be estimated from a Jominy

bar by determining metallographically the distance from the water-quenched end of the bar at which a 50 per cent martensitic structure is obtained and referring to Fig. 4.14, which shows the relation between Jominy distance and ideal critical diameter. If the 50 per cent martensite structure occurs at a distance of 11 sixteenths of an inch from the water-quenched end of a Jominy specimen of this particular steel, the

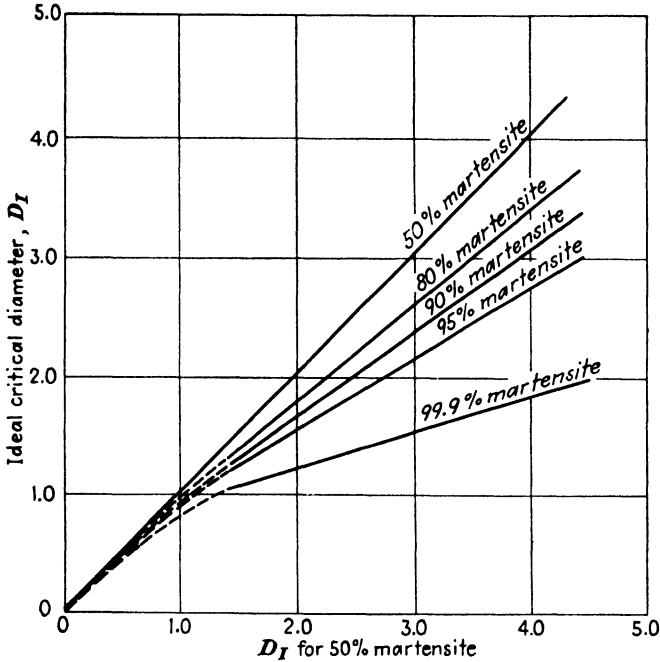

FIG. 5.12. Relation between ideal critical diameter and bar sizes that will contain more than 50 per cent martensite. (Hodge and Orehoski.)⁷⁴

indicated ideal critical diameter will be 3.60 in. The approximate ideal critical diameter may also be estimated in the same way from the critical hardness by determining the depth at which the critical hardness occurs on the Jominy hardness curve.

5.6. Percentage of Martensite from Ideal Critical Diameter

From the ideal critical diameter, which represents the size of bar that will harden at the center to 50 per cent martensite when quenched at an infinitely fast rate ($H = \infty$), it is possible to estimate the diameter of bar that will harden to structures containing between 50 and 99.9 per cent martensite through the relation shown by Hodge and Orehoski⁷⁴ in Fig. 5.12.

If, for example, it is determined from experimental data that the ideal critical diameter of a steel is equal to 3.60 in., the intersection of a vertical line representing a D_I of 3.60 in. (in Fig. 5.12) with the 99.9 per cent martensite line indicates that a bar about 1.8 in. in diameter will harden fully at the center (99.9 per cent martensite) when quenched with a severity of $H = \infty$.

If the diameter of 1.8 in. representing that of the fully hardened bar is considered to be the ideal diameter for 99.9 per cent martensite (not the ideal critical diameter), the size of bar that will harden to a similar degree when quenched with any specific quench may be determined from Fig. 5.8. If a quenching severity of $H = 0.50$ is used, a bar about 0.72 in. in diameter will harden fully at the center.

5.7. Ideal Critical Diameter from Chemical Composition

There is no doubt that the Jominy end-quench test described in the next chapter gives a rapid and readily reproducible evaluation of hardenability; but occasions arise in the production and selection of heat-treatable steels when it is desirable to know the hardenability of a steel or the relative response of two or more steels without resorting to such a test, and a large amount of effort has been expended in attempting to devise a method whereby hardenability could be estimated from chemical composition.

Such a procedure is, however, subject to a number of variables some of which are controlled with difficulty, and it is based on a number of assumptions some of which are of doubtful validity. These are discussed in the sections that follow. In general, therefore, calculated hardenability should be used only with a full awareness of its shortcomings.

The qualitative and quantitative effects of alloying elements on hardenability have been investigated, and numerical values have been assigned to each one of them in methods developed by Herty, McBride, and Hollenback,⁷² Burns, Moore, and Archer,²⁸ and Burns and Riegel.²⁹ In general, however, the applications of these methods were restricted to specific conditions, and a more generally applicable formula for calculating hardenability from chemical composition was developed by Grossmann,⁶⁸ which has made possible the specification and manufacture of steels of controlled hardenability.

Grossmann calculated hardenability in terms of ideal critical diameter. He assumed and confirmed that the hardening of steel is primarily a reaction between iron and carbon in an iron-carbon alloy, and that the alloying elements essentially affect only the rate of the reaction. The effects of the individual alloying elements were found to be independent

of carbon, grain size, and each other, so that one element increases the ideal critical diameter in one steel in the same manner as in another steel of otherwise entirely different composition. The calculation is based on the criterion of 50 per cent martensite and it is assumed that it is unaffected by the other 50 per cent of non-martensitic material, regardless of whether it is ferrite, pearlite, or bainite, or a mixture of these constituents. The calculation also assumes that the steel was completely austenitized prior to quenching. Subsequent work by others has confirmed the general usefulness of the method, but some disagreement has arisen over the values to be assigned to the factors. Those given in the next section were chosen by Boyd and Field²⁴ as a fairly reasonable approximation.

5.8. Grossmann's Method of Calculating Hardenability

Grossmann's method consists of multiplying the ideal critical diameter appropriate for the carbon content of the "pure" iron-carbon alloy, as indicated in Fig. 5.13, by factors proportional to and characteristic of all the alloying elements present in the steel. The effect of grain size should be applied to the ideal critical diameter of the "pure" iron-carbon alloy as in Fig. 5.13. The multiplying factors of the individual alloying elements may be represented by straight or curved lines as indicated in Fig. 5.14.

All of the elements, except gases, must be considered, even though they are present only as residual amounts that would not ordinarily be determined by chemical analysis. Excepted are sulphur and phosphorus when present in the small amounts that occur in basic open-hearth or electric-furnace steel made by the usual practice, and factors are not given for them in Fig. 5.14. Phosphorus increases and sulphur decreases hardenability slightly and, if less than 0.03 or 0.04 per cent of both is present, the effects cancel each other out.

Because the factors are multiplied together, the first increments of alloying elements have a greater percentage effect on ideal critical diameter than similar increments at higher levels of alloy content. It has been inferred from this that small amounts of a number of alloys, such as in the low-alloy triple-alloy steels, promote hardenability more efficiently than a large amount of a single alloy.

In calculating hardenability by the Grossmann method the normally expected error is within about 15 per cent. However, some complex steels develop significantly less hardenability than is indicated by the calculation. The deficiency in hardenability is most noticeable in steels containing both chromium and molybdenum. The discrepancy in chromium-molybdenum steels seems to become worse as the alloy

content is increased or as the carbon content is lowered. Silicon and, to some extent, nickel also appear to aggravate the condition. In standard steels such as SAE 4100 and the triple-alloy types the actual ideal critical diameter is seldom less than 60 or 80 per cent of the cal-

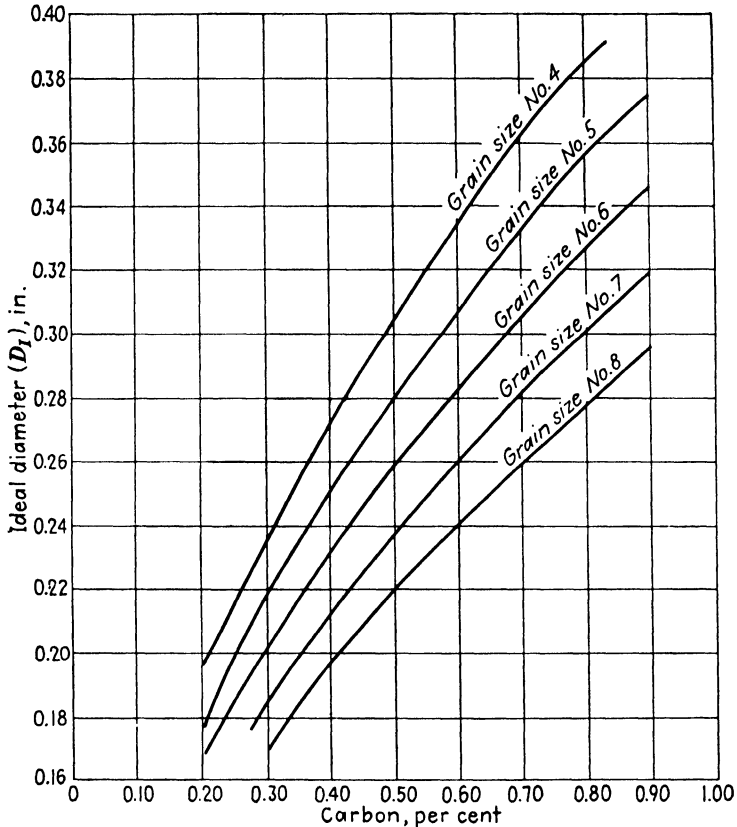

FIG. 5.13. Relation between ideal diameter (D_I), carbon content, and grain size. (Boyd and Field,²⁴ after Grossmann.⁸⁶)

culated ideal critical diameter, but in unstandard high-alloy compositions hardenability as low as 15 per cent of the calculated ideal critical diameter has been observed. The degree of the discrepancy in standard steels is illustrated by Fig. 5.15.

The reasons for this behavior are not entirely obvious. For one thing the individual multiplying factors were largely based on simple steels in which the element being studied was the primary constituent. The factors were studied within a whole pattern of compositions only in the

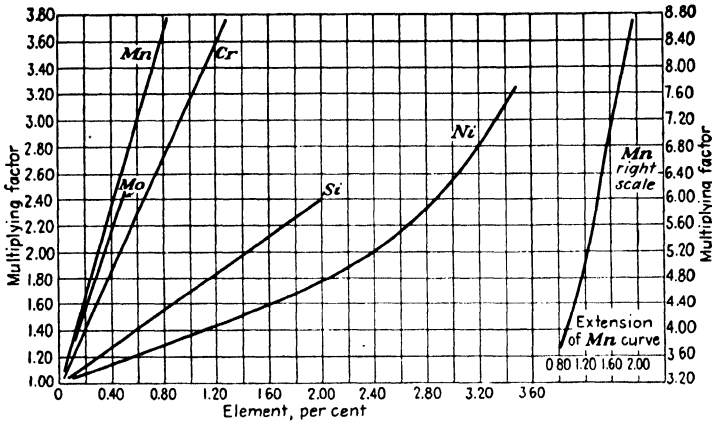

FIG. 5.14. Multiplying factors for the five common alloying elements. (Boyd and Field.)²⁴

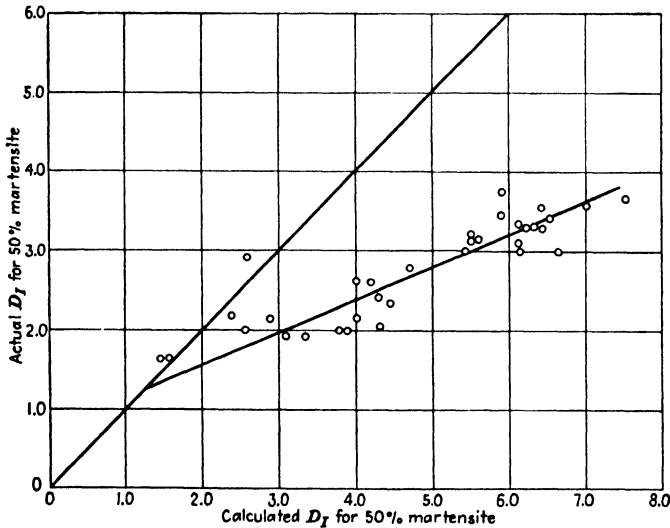

FIG. 5.15. Discrepancy between actual and calculated ideal critical diameters of chromium-molybdenum steels. (Hodge and Orehoski.)⁷⁴

carbon-manganese-silicon-aluminum steels investigated by Crafts and Lamont,³⁵ and in that case the factors were not influenced by the other elements present. Grossmann, with specific reference to SAE 4150, considered that the error resulted from incomplete solution of carbides in austenite or from the transformation of austenite that was not entirely homogeneous. Hollomon and Jaffe⁷⁸ proposed that it might

result from the change in the non-martensitic constituents from pearlitic to bainitic transformation products and that somewhat different sets of multiplying factors would be necessary both for pearlitic and for bainitic steels.

5.9. Example of Calculated Hardenability

The general formula for calculating hardenability from chemical composition is as follows:

$$D_I = D_{IC} \times MF\%Mn \times MF\%Si \times MF\%Ni \cdot \cdot \cdot \text{etc.}$$

where D_I = the ideal critical diameter,

D_{IC} = the ideal critical diameter for the carbon percentage and grain size from Fig. 5.13,

MF = the multiplying factor from Fig. 5.14.

Assume that it is desirable to calculate the ideal critical diameter of a triple-alloy steel of the following composition and grain size:

<i>Component</i>	<i>%</i>	<i>Component</i>	<i>%</i>
C	0.40	Si	0.25
Mn	0.90	Ni	0.55
P	0.020	Cr	0.50
S	0.020	Mo	0.20

Actual grain size, No. 8

The first step is to determine the D_{IC} for 0.40 per cent carbon and No. 8 grain size from Fig. 5.13. In this case, D_{IC} is 0.198 in. The multiplying factor for manganese is determined from Fig. 5.14, in which the numerical value for the multiplying factor is read on the ordinate. As the manganese content of the steel is 0.90 per cent, the multiplying factor is 4.0. In a similar manner the values for the multiplying factors of the other elements are determined, and substituted in the formula as follows:

$$D_I = D_{IC} \text{ Mn P S Si Ni Cr Mo} \\ D_I = (0.198)(4.0)(1.04)(0.98)(1.13)(1.21)(2.09)(1.60) = 3.68$$

The ideal critical diameter of the steel is, therefore, calculated to be 3.68 in.

A comparison of the multiplying factors as given in Fig. 5.14 affords an estimate of the relative effectiveness of the five common alloying elements in increasing hardenability. Manganese is the most powerful, with molybdenum, at least in amounts of 0.50 per cent or less, a close second. Chromium is also effective in promoting deep hardening; silicon and nickel have much less effect.

5.10. The Accuracy of Calculated Hardenability

The validity of the Grossmann method and the accuracy of the multiplying factors have been studied critically by a number of workers in the field.^{36, 44, 94} Some of these have used the microscopic examination of the structure, but most of the work has been done by estimating 50 per cent martensite from hardness on the basis of the data given in Fig. 5.16. However, the hardness of 50 per cent martensite varies with

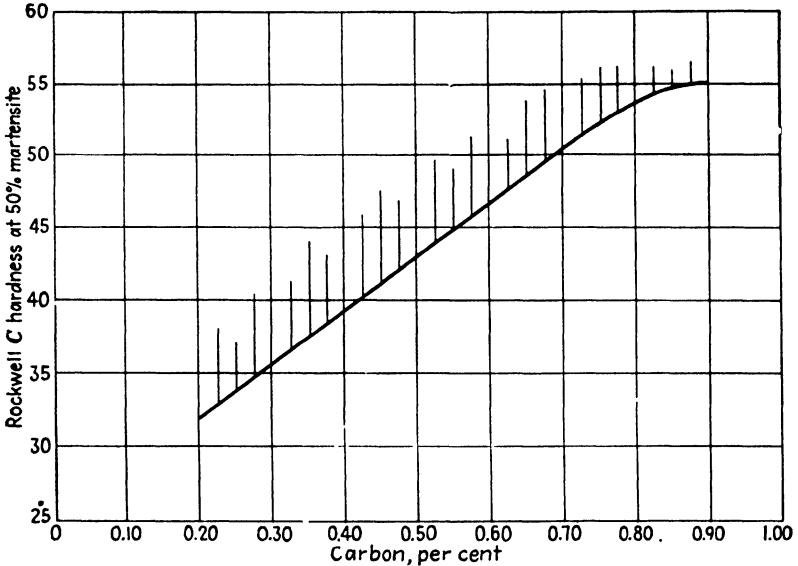

FIG. 5.16. Effect of carbon on the hardness of 50 per cent martensite. (Solid line for plain carbon steel; hatched portion for low- and medium-alloy steels.) (Grossmann.)⁹⁸

alloy content in steels of the same carbon content, and because of the interrelated effects of alloying elements on non-martensitic structure it is difficult to evaluate their effect with respect to the 50 per cent martensite criterion. This variation in hardness of structures containing 50 per cent martensite has led to some discrepancies in determining multiplying factors.

A recent study by Kramer, Siegel, and Brooks⁹⁵ indicated that some of the inconsistencies could be corrected by use of a different carbon base after a correction has been made for deoxidation treatment. The multiplying factors did not appear to be simple, straight lines, and the principle that the first increment of alloy is most effective was questioned. Although this study tended to confirm the principle of the

Grossmann method, it emphasized that more work is required to develop accurate factors.

Grossmann's factors with a few modifications have been used for the past four or five years for the prediction of hardenability with good results except in the case of low-carbon steels and a few special low-alloy materials. The factors that have been accepted by the American Iron and Steel Institute²⁴ are Grossmann's iron-carbon/grain-size base and the multiplying factors that have appeared most reasonable in tests on many steels as reported in the literature (Fig. 5.14). In general, the calculation has been found to be reliable and useful for the design and selection of many low-alloy steels as well as for the control of composition in manufacturing steels of specified hardenability.

TABLE 5.2. Comparison of the Mechanical Properties of Steels after Full Hardening and after Partial Hardening

Class of steel	Diameter of bar, in.	Martensite at center of quenched bar, per cent	Tensile strength, lb./sq. in.	Yield strength, lb./sq. in.	Yield point (drop of beam), lb./sq. in.	Elongation, per cent	Reduction of area, per cent	Izod impact, ft-lb.
SAE 1040	0.40	100	148,100	132,200	138,100	18.6	63.9	61.8*
	0.49	66	148,300	118,600	124,100	16.1	56.9	
SAE 1340	0.40	100	147,200	136,300	136,300	20.0	55.6	54.3*
	1.25	30	145,000	115,500	121,000	15.0	48.1	30.0
SAE 8640	0.56	100	147,000	142,500	142,500	21.0	61.8	63.5
	1.625	40	148,750	123,000	125,500	18.0	56.2	40.0
SAE 4340	0.53	100	146,500	136,000	136,000	20.5	62.6	60.8
	1.00	100	147,500	132,500	133,000	20.0	61.8	62.0
	5.0 (sq.)	50 =	148,500	122,000	126,500	16.5	46.0	29.8

*Quenched as 0.394-in. squares

5.11. Relation between Quenched Structure and Mechanical Properties

The criterion of 50 per cent martensite used as an index of hardenability has no special significance with respect to useful service properties. In applications requiring optimum mechanical properties the section should be fully quenched to a virtually 100 per cent martensitic structure. This has been shown by several investigators^{73, 74, 85, 107} and is illustrated in Table 5.2, which lists mechanical properties of fully hardened steels and of the same steels when partially hardened.

Some important engineering applications for carbon and low-alloy steels require full hardening and maximum properties only at the surface.

The gradient of hardness, or percentage of martensite, is particularly critical in shallow-hardening steels that are subjected to bending or torsional loading, such as automobile rear axles and springs. In this case the maximum stress is at the surface, and the best possible combination of properties is necessary at that point. In such parts service stresses decrease rapidly beneath the surface and the need of optimum properties throughout the section is open to question. If such parts are made of shallow-hardening steel, such as SAE 1045 illustrated in Fig. 5.6A, the surface is made martensitic in drastic quenching while the

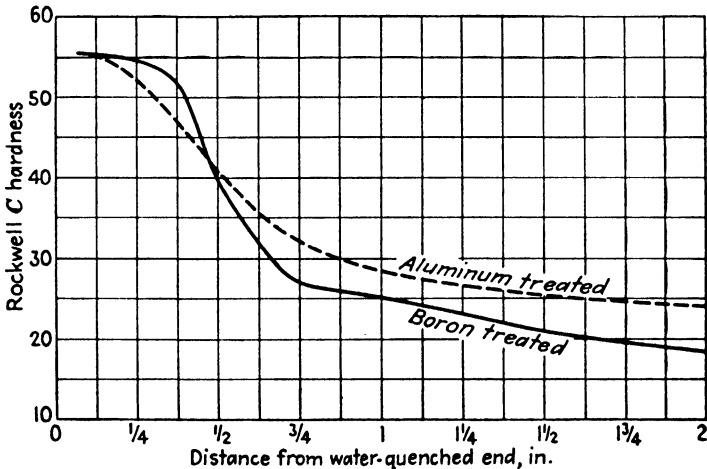

Fig. 5.17. Effect of boron on the hardness gradient of steels having the same ideal critical diameter. The curves are for Jominy tests on aluminum-treated 0.40 per cent carbon, 1.75 per cent manganese steel and boron-treated 0.40 per cent carbon, 1.15 per cent manganese steel.

interior transforms at a relatively high temperature. Thus the expansion resulting from transformation of austenite takes place at a high temperature in the core, whereas at low temperature there is only expansion due to martensite formation at the surface. This leaves the steel with a compressive stress at the surface that tends to counteract the tensile stress imposed in service, and the apparent fatigue limit is increased. As it is possible to produce the desired steep hardness gradient only with certain compositions and heat-treating conditions, information on the degree of hardening at different cooling rates is essential.

The study by Hodge and Orehoski^{73, 74} of the martensite gradient between 50 and 99.9 per cent martensite indicates that it is possible to predict from the ideal critical diameter the gradient of martensite

hardening, as shown in Fig. 5.12. The relation has been found to be independent of carbon content and individual alloying elements, but it does vary somewhat with deoxidation practice.

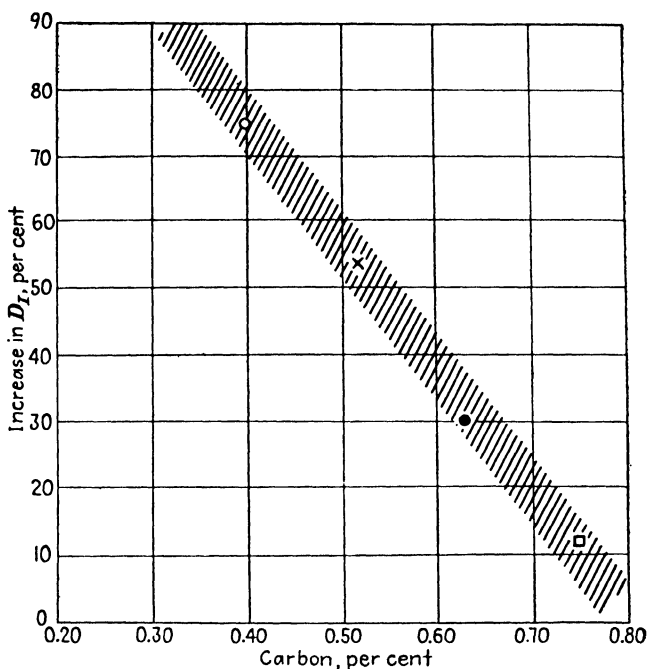

FIG. 5.18. Relation of carbon content to the ideal critical diameter in carbon steels containing an effective boron addition (0.001 per cent minimum). (*Grange and Garvey.*)⁵⁸

5.12. Effect of Boron on the Hardness Gradient after Quenching

Fine-grained (aluminum-deoxidized) steels treated with boron have a much steeper hardness gradient than those not so treated, as shown in Fig. 5.17. Boron was used successfully during World War II as a partial substitute for the conventional alloying elements that were in short supply. It was found that about 0.001 per cent boron is effective in increasing hardenability and that much more than this is not necessary. Usually about 0.002 per cent is added and, in order to be effective, the steel must be subjected to a strong deoxidation treatment. It is preferable to add the boron as a dilute alloy with deoxidizers in order to obtain uniform distribution through the steel. If added properly, it does not impair the rolling properties of the steel. The relation of the ideal critical diameter of boron-treated steel to the carbon content is shown in Fig. 5.18.

It will be noted from Fig. 5.19 that the increase of ideal critical diameter (50 per cent martensite) is appreciable, and in addition the depth of 100 per cent martensite is increased to an even greater extent. Treatment with boron adds almost nothing to the hardness of non-martensitic structures, so that for a given ideal critical diameter the boron-treated lower alloy steel is usually softer and more machinable in the as-rolled or annealed condition than the comparable conventional

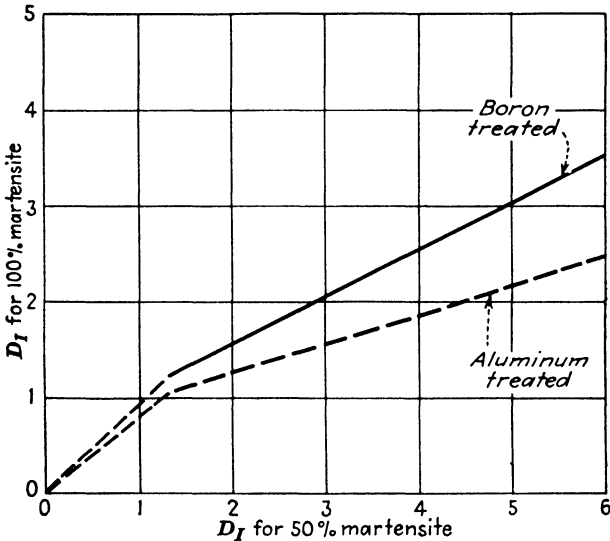

FIG. 5.19. Effect of boron on the relation between the ideal critical diameter for 50 per cent martensite and that for 100 per cent martensite.

aluminum-treated higher alloy steels. Boron does not confer resistance to tempering. Because of the strong deoxidizers usually employed when boron is used and owing to a tendency toward a higher proportion of martensite in hardened boron steels, the impact strength is relatively high. However, boron reduces the impact strength of unhardened steel so that it should be used only if the structure after quenching is designed to be predominantly martensitic at least at the surface.

Treatment with boron has specific value for steels selected and heat treated to have a martensitic case and an unhardened core in order to obtain a surface compressive strength. In this application the benefit to the hardened surface overbalances the low impact strength of the lightly stressed core. This is illustrated in Fig. 5.20, which shows the relations between ideal critical diameter of the steel, the severity of quench, and the bar diameters that can be hardened to a maximum

of 50 per cent martensite at the center with a rim of 100 per cent martensite of a thickness of at least 20 per cent of the radius of the bar. These diagrams are based on Figs. 4.14 and 4.19 (pp. 72 and 75). In Fig. 5.20, the section that can be treated effectively for a given severity of quench lies in an area above the dotted line for 50 per cent martensite and below the solid line for 100 per cent martensite.

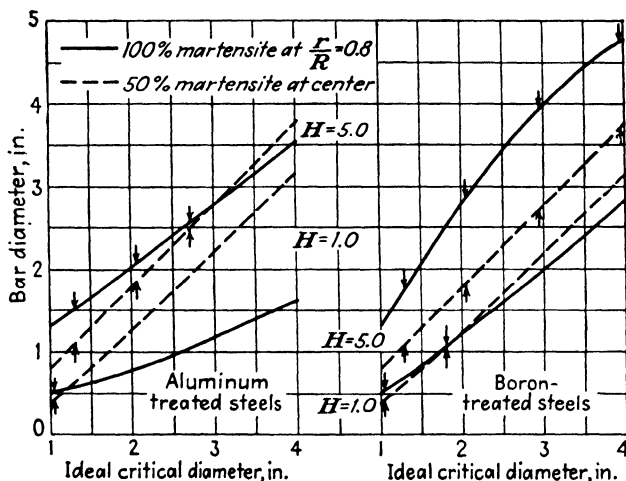

FIG 5.20. Calculated range of bar diameters (above dotted lines and below solid lines) that can be hardened to 50 per cent martensite at the center with a rim of 100 per cent martensite that has a thickness of at least 20 per cent of the radius of the bar.

Obviously, this effective zone is very small unless the quench is drastic and even then the conditions are so rigidly fixed as to restrict the use of the treatment to relatively small and uniform sections. Boron-treated steel has a very much greater latitude in section and severity of quench. Zirconium has an effect on the hardness gradient that is similar to that of boron. Vanadium also is used for this purpose in some tool steels.

5.13. Summary

For purposes of predicting the capacity of a steel to harden in sections of practical size the degree to which martensite is formed during quenching has been evaluated with respect to cooling rate. This property of hardenability is measured conveniently by the ideal critical diameter representing 50 per cent martensite. A formula for calculating ideal critical diameter has made it possible to predict and control hardenability on the basis of composition. In general, the conventional alloy-

ing elements behave in a substitutional manner, but deoxidizing and grain-refining elements have specific effects. The ideal critical diameter (50 per cent martensite) bears a fixed relation to the ideal diameter for higher percentages of martensite for any given deoxidation treatment. Boron- and zirconium-treated steels have a much steeper hardness or martensite gradient than plain aluminum-treated steels and develop 100 per cent martensite to greater depths for the same degree of 50 per cent martensite hardenability. This is of special value where the optimum properties of wholly martensitic structures are desired. It also facilitates the application of shallow-hardened steels.

CHAPTER 6

HARDENABILITY TEST METHODS

THE PRACTICAL APPLICATION of our knowledge of quenching severity and mass effect to the response of steel to thermal treatment requires that hardenability be measured quickly, easily, and cheaply. The classic research procedures of determining cooling rates or martensite gradients in a number of sections of various sizes are laborious and require a high order of experimental ability and many specimens of the material. Practical hardenability tests using a single critical section for a specific application (for example, tool steels) have been widely used for many years. In order to extend the utility of such tests, specimens of various sizes and shapes, and various quenching methods, have been tried so that a broader range of cooling rates may be studied. The quenching conditions have been standardized, and methods of measuring cooling rates have been worked out for some test procedures so that the conditions are reproducible. Of the standardized hardenability tests the most popular for steels of the medium degree of hardenability is the end-quench test devised by Jominy and Boegehold.⁸⁷ The cooling characteristics of the end-quenched specimen have been calibrated and interpreted with respect to uniformly quenched articles. Because the end-quench test is easy to reproduce consistently, it has become a standard means of determining hardenability and has been instrumental in the rapid development of factors necessary for accurate control of hardenability.

End-quench hardenability tests, as devised by Jominy and Boegehold⁸⁷

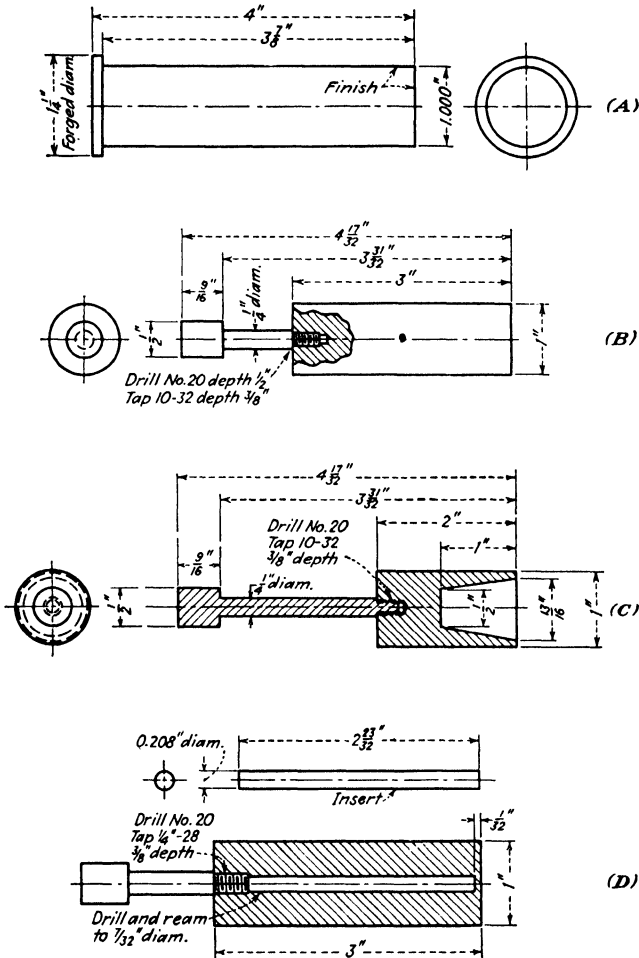

FIG. 6.1. Jominy test specimens: (A) preferred test specimen; (B) optional specimen; (C) type L specimen; (D) insert-type bar for steel available only in small sizes. (SAE Handbook.)¹³⁴

and Jominy,⁸⁸ make it possible to determine with a single specimen the degree of hardening that can be attained with a wide range of cooling rates. As fairly comprehensive data on degree of hardening with respect to various cooling rates have been determined for the test, and as the data have been correlated with cross section and severity of quench, the test is widely used and has been recommended by The Society of Automotive Engineers¹³⁴ and by The American Society for Testing Materials⁷ as the standard method of measuring hardenability of auto-

motive and other engineering steels. It is particularly well adapted to low-alloy steels used in sections up to 4 or 5 in. in diameter. The test was used extensively during World War II in the development of the National Emergency steels (now known as triple-alloy steels) by the Technical Committee on Alloy Steels of the American Iron and Steel Institute.^{3, 4} It was considered that steels that gave similar Jominy end-quench hardness curves would have similar properties in quenched bars of identical sections, and it was found possible to substitute new

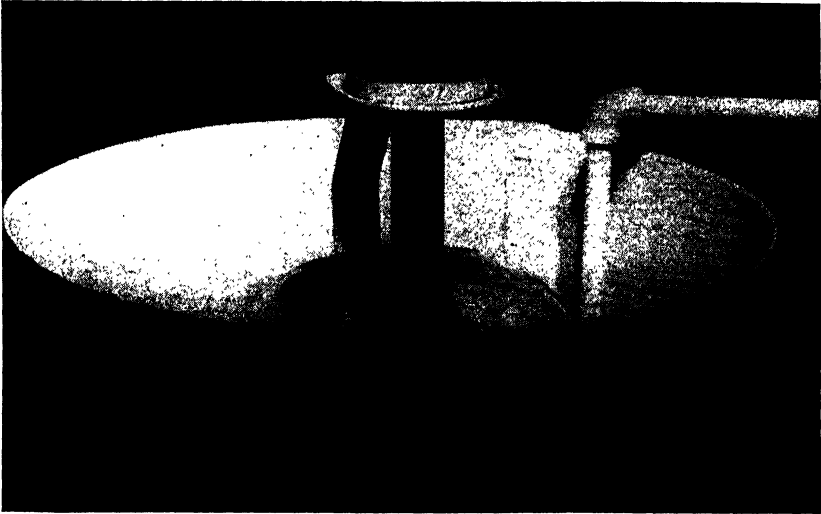

FIG. 6.2. Jominy test in operation.

types of alloy steel for types containing greater amounts of strategically critical alloys by the use of the Jominy test without the extensive laboratory and service testing usually considered necessary before a new steel is widely used in important engineering applications.

6.1. Method of Making Jominy End-Quench Hardenability Tests

In the Jominy test, which is described in readily available publications,^{7, 134} two types of specimens may be used, the standard specimen, or the L type for shallow-hardening and carburizing steels. Figure 6.1 shows the various types of specimens and their dimensions. During heating, the end of the specimen, which has been ground, is protected from scaling and decarburizing by a neutral atmosphere, by cast-iron chips, or by standing the specimen on a graphite block. After heating for 30 min. at the proper austenitizing temperature, the specimen is rapidly transferred to a fixture, and a column of water controlled as to

temperature and volume is directed against the end of the specimen as shown in Fig. 6.2. Water at $75 \pm 5^\circ\text{F}$. (about 25°C .) is directed through a $\frac{1}{2}$ -in. orifice, and the column of the water is adjusted to a height of $2\frac{1}{2}$ in. before the sample is placed in the fixture. The specimen, transferred as rapidly as possible from the furnace to the quenching fixture, is hung so that the end to be quenched is $\frac{1}{2}$ in. above the orifice, and the water is turned on by means of a quick-acting valve. Strong air drafts should be avoided. When the specimen has been cooled to room temperature two flat surfaces, 180 deg. apart, are ground 0.015 in. deep

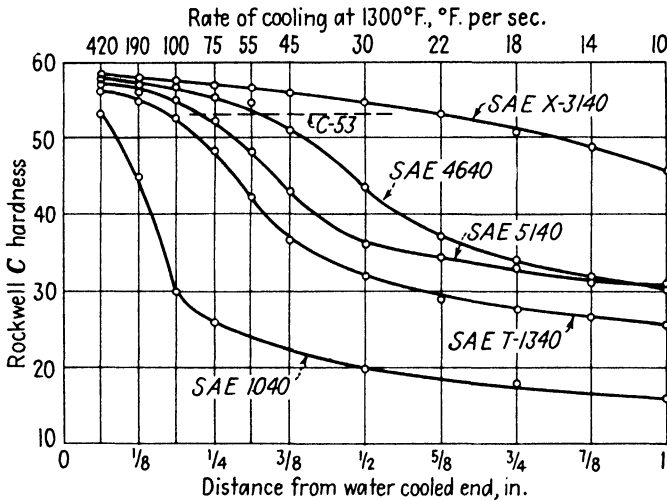

FIG. 6.3. Jominy end-quench curves for carbon and low-alloy steels containing 0.40 per cent carbon. (Jominy.)⁹⁰

along the entire length of the bar. Caution should be exercised during the grinding operation so as not to heat the bar enough to cause tempering. Rockwell C measurements are made at $\frac{1}{16}$ -in. intervals along the center line of the two flats. Jigs that systematize the determination of Rockwell C hardness are now commercially available and facilitate making accurate measurements. The average hardness readings at a given location are plotted against the distance of the readings from the water-quenched end, and a smooth curve is drawn through the points. Some typical curves are given in Figs. 6.3 and 6.4.

As the specimen is quenched under controlled conditions, the cooling rate, which varies from very rapid to very slow between the water-quenched end and the air-cooled end, is considered to be the same at identical points in every specimen quenched under these conditions. Thus, in one test piece the hardening characteristics and actual hardness

are obtained for a range of cooling rates comparable to quenching rates in bars up to 4 or 5 in. in diameter. By comparing the Jominy curves of various steels, the differences in hardenability are readily apparent. For example, it is evident from Figs. 6.3 and 6.4 that SAE steels 1040 and 1045 are shallow hardening and steels X3140 (1.25 per cent nickel and 0.75 per cent chromium) and 4145 are deep hardening; the other steels range from relatively shallow to relatively deep hardening in their response to quenching. Incidentally, the horizontal dashed lines in Figs. 6.3 and 6.4 represent the usual maximum hardness values attained by quenching plain carbon steels containing 0.40 and 0.45 per cent carbon.

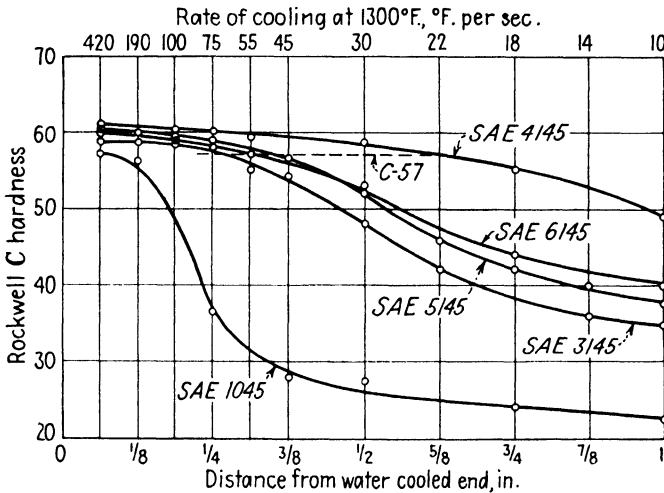

FIG. 6.4. Jominy end-quench curves for carbon and low-alloy steels containing 0.45 per cent carbon. (*Jominy*.)⁹⁰

6.2. Specifying Jominy End-Quench Hardenability

In describing hardenability it is customary to use a code for hardness and the distance from the water-quenched end at which that hardness is obtained. Table 6.1 indicates the hardness reference numbers in Rockwell C suggested by The Society of Automotive Engineers¹³⁴ for steels of various carbon contents. As an example, an alloy steel of 0.45 per cent carbon could be specified to have a hardenability of $J_{50}=6$ minimum, which means that the steel should have a Rockwell C hardness of 50 at a minimum distance of 6 sixteenths of an inch from the quenched end. If minimum and maximum limits are desired, the specified Jominy hardenability might be designated as $J_{50}=6$ to 12 (sixteenths). The specification can also be written $J_{35/45}=8$, which

TABLE 6.1. Hardness Reference Numbers Designating Hardenability for Steels of Various Carbon Contents*

Carbon range, per cent	Hardness, in Rockwell C	
	Alloy steels	Carbon steels
0.08 to 0.17	25	
0.18 to 0.22	30	25
0.23 to 0.27	35	30
0.28 to 0.32	40	35
0.33 to 0.42	45	40
0.43 to 0.52	50	45
0.53 to 0.62	55	50

*Society of Automotive Engineers.¹³⁴

indicates that a Rockwell C hardness in the range 35 to 45 is required at a distance of 8 sixteenths from the quenched end. A more detailed outline of the methods for specifying hardenability is included in the discussion of hardenability bands in the next chapter (Section 7.6).

The American Society for Testing Materials⁷ recommends that, in reporting end-quench hardenability curves, chemical composition, grain size, austenitizing temperature, and quenching temperature be also supplied in every case.

6.3. Relation between Actual Cooling Rates and the End-Quench Test

*By establishing cooling rates at definite positions in the Jominy specimen it is possible to predict from the test the hardness that is to be expected in quenched bars. In estimating the quenched hardness from the Jominy test, it is assumed that identical cooling rates will, in a given steel, produce identical hardness values regardless of whether that rate is produced in the Jominy specimen or at any point in the cross section of a bar.

The cooling rates at various points along the length of the standard Jominy specimen were determined by Jominy and Boegehold⁸⁷ and are shown in Tables 6.2 and 6.3. It will be noted that the cooling rate at 1000°F. varies somewhat as the quenching temperature is changed. A similar change in cooling rate at a given temperature will occur when commercial bars are quenched.

In order to check the relation between Jominy tests and actual bars Jominy⁸⁸ used the cooling rates at the center of water- and oil-quenched bars of various sizes as determined by Scott,¹²⁴ these are shown in Table 6.3. Hardness traverses were made on various steels and the center hardness values were compared with those at positions of corre-

sponding cooling rate on the Jominy bar. The close correlation between results is illustrated in Fig. 6.5 showing the Jominy curves of SAE 5145 and 3145 steels on which have been superimposed the hardness traverses of bars oil-quenched in sections between 1 and 4 in. in diameter. The close agreement between the two types of test indicates that a fairly accurate estimation may be made from the Jominy test of the hardness to be expected at the center of quenched bars.

TABLE 6.2. Cooling Rates at Various Distances from Water-Quenched End of Jominy Test Bar*

Distance from water-quenched end, in.	Rate of cooling, deg. F. per sec.		
	At 1300°F.	At 1000°F.	
	Upon quenching from		
	1700°F.	1700°F.	1425°F.
$\frac{1}{16}$	420	420	700
$\frac{1}{8}$			400
$\frac{3}{16}$	93	42	53
$\frac{1}{4}$			35
$\frac{5}{16}$	61	24	
$\frac{1}{2}$			14
$\frac{9}{16}$	25	12.5	
$\frac{3}{4}$			9
$\frac{13}{16}$	12.5	8.1	
1			6.8
$1\frac{5}{16}$	7.0	5.0	
$1\frac{1}{2}$			4.6
$2\frac{1}{2}$	4.5	2.7	2.8

* Jominy and Boegehold.⁸⁷

TABLE 6.3. Cooling Rate at Center of Bars of Various Diameters*

Bar diameter, in.	Rate of cooling at 1330°F., in deg. F. per sec., at center of bar quenched from 1610°F.	
	In still oil	In still water
$\frac{1}{2}$	115	330
$\frac{3}{4}$	72	185
1	47	108
$1\frac{1}{2}$	29	54
2	18	31
3	9.2	14
4	5.5†	8.5†

* Scott.¹²⁴

† Determined at Research Laboratory Division, General Motors Co.

Subsequent to the original calibration by Jominy and Boegehold of the cooling rate at various distances from the water-quenched end of the specimen, Boegehold and Weinman, according to Kopecki,⁹³ redetermined the rates and found them to be appreciably higher near the

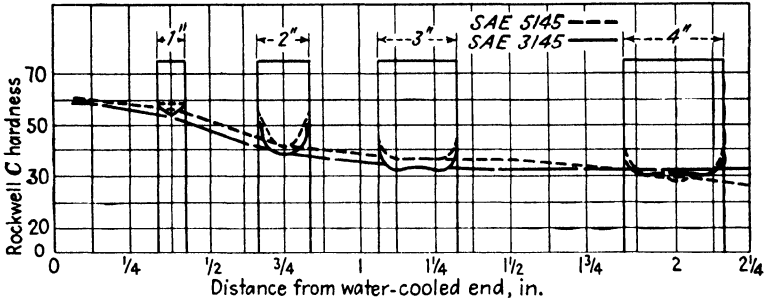

FIG. 6.5. Comparison between hardness values at the center of round bars and those of the Jominy test bar at locations where cooling rates correspond to those at the center of the appropriate bar sizes. (Jominy.)⁹⁸

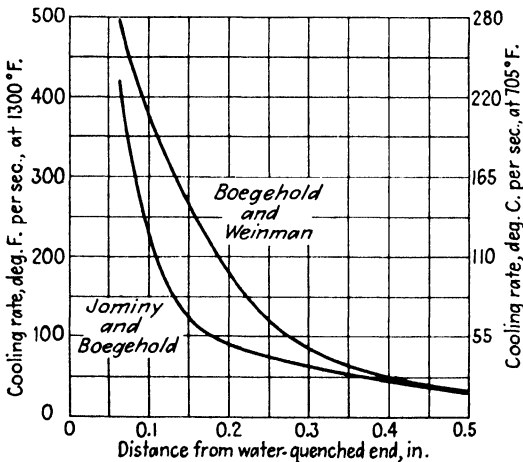

FIG. 6.6. Cooling rates along the Jominy test specimen determined originally by Jominy and Boegehold⁹⁷ and later by Boegehold and Weinman, according to Kopecki.⁹³

water-quenched end than in the original calibration. A comparison of the original determination and the cooling rates determined by Boegehold and Weinman is shown in Fig. 6.6 for distances up to $\frac{1}{2}$ in. from the water-quenched end.

Since hardening of actual bars represented by points close to the water-quenched end of the Jominy bar has not correlated too well with

that estimated by use of the original calibration, it is probable that closer agreement can be attained with the cooling rates determined by Boegehold and Weinman. Even with this improvement Manning⁹⁸ reported some discrepancies between Jominy specimens and quenched round bars.

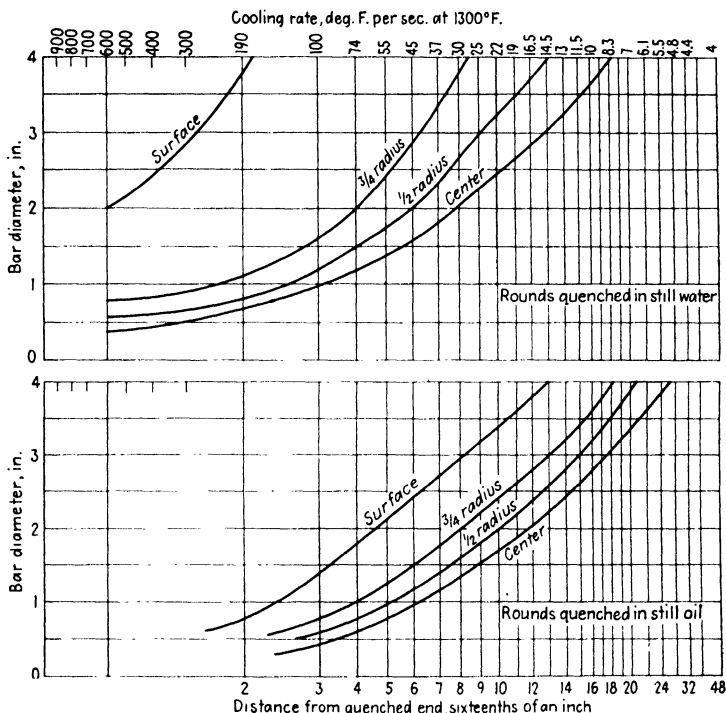

FIG. 6.7. Relation between Jominy depth, bar diameter, and various positions within the bar for quenching in still water and still oil. (Boegehold, in *SAE Handbook*.)¹³⁴

6.4. Relation between Actual Cooling Rates in Oil and Water and the End-Quench Test

The degree of hardening and the quenched hardness to be expected in round bars quenched in still water or oil may be estimated from the results of Jominy tests by use of the charts shown in Fig. 6.7. To determine the size of bar that will harden completely throughout when quenched in still oil, assume that a SAE 6145 steel has a Jominy hardness curve like that in Fig. 6.4, which shows a hardness of 56 Rockwell C at 6 sixteenths of an inch of Jominy depth. By reference to the lower chart in Fig. 6.7 it will be seen that complete hardening will occur at the center of bars 1.0 in. and less in diameter as indicated by the intersection

of the vertical line indicating 6 sixteenths of an inch and the curve for the center position of the bar. For quenching in agitated oil it would be estimated that progressively larger bars would harden as the rate of agitation increases.

By the same process, the bar size that will harden to a given hardness at various positions within the bar may be determined. For example,

if full hardening to 56 Rockwell C is desired at a point midway between center and surface, then a bar 1.2 in. in diameter should give this hardness if quenched in still oil.

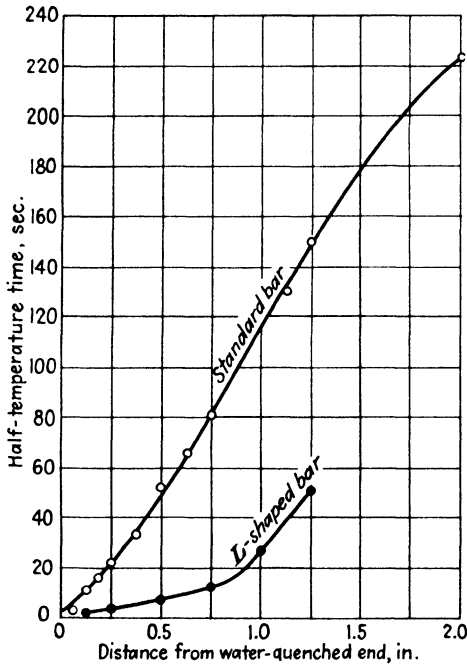

FIG. 6.8. The time needed for various locations on the Jominy test bars to cool to half-temperature.

time," to be used instead of cooling rate. In order to make the Jominy test applicable to this relation, Asimow, Craig, and Grossmann,¹² in cooperation with Jominy, determined the half-temperature/time characteristics for the standard Jominy specimen, and Jominy⁸⁹ determined the same relation for the L-type specimen. These relations are shown in Fig. 6.8. By means of these half-temperature times it is possible to show the relation between Jominy depth and ideal diameter as in Fig. 6.9.

The ideal critical diameter may be estimated directly from this relation if the Jominy depth at which 50 per cent martensite occurs is determined from microscopic examination of the Jominy specimen. If this is estimated at, for example, a depth of 8 sixteenths of an inch, by reference

6.5. Relation of the Jominy Test to Severity of Quench and Critical Diameter

Grossmann, Asimow, and Urban,⁶⁵ in establishing the relationship between critical diameter, severity of quench, and ideal critical diameter, calculated the time required to cool to a temperature midway between the quenching temperature and the temperature of the quenching medium, which they designated as "half-temperature

to Fig. 6.9 it will be seen that the ideal critical diameter is equal to 3 in. at 8 sixteenths (0.5 in.) on the Jominy specimen. This was the method used by Crafts and Lamont³⁶ in estimating ideal critical diameter in their determination of multiplying factors for calculating hardenability as discussed in the previous chapter. If hardness is used as a reference point in estimating ideal critical diameter, the Jominy depth for the point of inflection of the Jominy hardness curve, or the Jominy depth

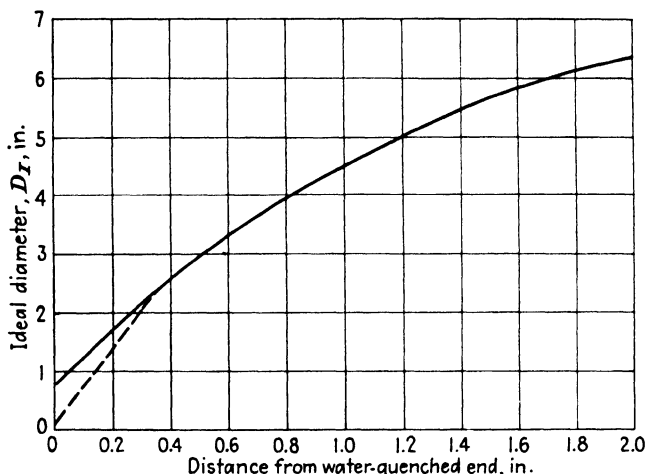

FIG. 6.9. Relation between ideal diameter and Jominy depth. (Asinow, Craig, and Grossmann,¹² as modified by Hodge and Orehoski.⁷³)

for the appropriate hardness, shown in Fig. 5.16 (p. 104) for Grossmann's relation between hardness and 50 per cent martensite, is referred to the curve in Fig. 6.9 and the ideal critical diameters can be read off for the appropriate depths. Such a method of estimating ideal critical diameter was used by Crafts and Lamont,³⁵ Kramer, Hafner, and Toleman,⁹⁴ Kramer, Siegel, and Brooks,⁹⁵ Brophy and Miller,²⁷ and in some cases by Grossmann⁶⁸ to determine multiplying factors for calculating hardenability. The assumption that hardness may be used for estimating percentage of martensite is of great practical value, but the effect of differences in the non-martensitic constituents is by no means negligible and the practice should be used only when the possibility of error is recognized.

6.6. Relation of the Jominy Test to Severity of Quench and Center Hardness

In addition to being able to predict ideal critical diameter, it is possible to determine the hardness to be expected at the center of bars.

that have been quenched with a known severity by applying the foregoing relations to any hardness value instead of only to 50 per cent martensite. The Jominy depth for a given hardness may be utilized to determine ideal diameter by reference to Fig. 6.9; the diameter of bar that will give a certain hardness at the center when cooled with a given severity of quench may then be determined from the relation to ideal diameter given in Fig. 4.14 (p. 72). This method has only to be manipulated in the reverse direction to determine the Jominy depth required to give a desired center hardness for a known severity of quench.

The relation between the Jominy test and round bars has been further extended by Lamont⁹⁶ by the use of Russell's¹²² constants to include graduated positions from center to surface as typified by Fig. 4.22 (p. 78), which shows the relation at 20 per cent of the radius from the surface ($r/R=0.8$). Similar relations, which are given in Figs. 4.14 to 4.24 for different positions, make it possible to estimate directly from Jominy hardenability data the gradients to be expected in round bars if the severity of quench is known.

This relation provides a simple method for evaluating the severity of quench. If, in addition to Jominy hardenability data, the cross-sectional hardness is determined on a bar of the same steel, quenched under the conditions it is desired to evaluate, the numerical value for the severity of quench may be determined on the appropriate chart in Figs. 4.14 to 4.24 by the intercept of the bar diameter and the Jominy depth at which the reference hardness is located.

Similar relations have also been established for shapes other than round bars. The comparison of Jominy depth and ideal plate size makes it possible to apply hardenability data to plates at various quenching severities through the relation for ideal plate thickness, severity of quench, and plate thickness as given by Asimow and Grossmann¹¹ and shown in Figs. 5.10 and 5.11 (pp. 96 and 97). The hardness to be expected at the center of round bars, squares, flats, and plates after quenching in still oil or water may be estimated directly from the results of Jominy tests by the relations given by Lamont and shown in Figs. 4.25 to 4.30 (pp. 80 to 83), where the application of the charts is described in detail.

6.7. Advantages and Disadvantages of the Jominy End-Quench Test

The Jominy end-quench test can be made rapidly and economically and, if ordinary precautions are observed, it is entirely reproducible for engineering steels whose hardenability is neither very low nor very high. In other words, Jominy test data obtained in one laboratory check closely with test data on specimens of the same steel as secured in any

other laboratory. What is most important, however, is that the actual test is far more accurate for the determination of the response to quenching than any method of calculated hardenability and should always be used when quantitative data are required.

Another advantage is that it is suitable for hardenability control during the melting and refining of a heat of low-alloy steel. It has been shown conclusively that Jominy end-quench curves for a cast steel coincide almost exactly with the curves for the same steel as rolled.* This means that the hardenability of a heat can be judged from cast specimens taken when the heat is being tapped, and the results will be known before the ingots are rolled into blooms, slabs, or billets.

The determination of cooling rates for various locations on the Jominy bar and the accumulation of data on the relation of the end-quench test to severity of quench and the size of the section that will harden completely under various quenching conditions have greatly increased the value and utility of this method of determining hardenability. Despite this, however, it has a number of faults. The test covers a wide range of cooling rates, but it is relatively inaccurate at the very fast rates necessary to form martensite in sections of appreciable size in such shallow-hardening materials as carbon steels and some low-alloy carburizing steels. Furthermore, the test cannot be used where the cooling rates necessary to produce complete hardening are low—the minimum is about 5°F. (3°C.) per sec.—so that it is not applicable to the air-hardening alloy steels.

Because of the limitations of the Jominy test, other methods have been worked out for certain classes of steel. Some of these are used for shallow-hardening materials as, for example, the methods devised by Burns, Moore, and Archer,²⁸ Shepherd,^{126, 127, 129} Post, Greene, and Fenstermacher,¹¹² and McMullan.¹⁰³ A method for determining the hardenability of very deep hardening steels of the air-hardening variety was devised by Post, Fetzer, and Fenstermacher.¹¹³ Several of these methods have been correlated with Grossmann's ideal critical diameter and, therefore, may be related readily to quenched bars and have greater applicability than others. However, each method has its own advantages and disadvantages, so that the choice of a method depends upon its suitability to the application and the amount of testing to be done.

6.8. Special Hardenability Tests for Shallow-Hardening Steels

Much work has been done in an effort to devise a generally acceptable test for determining hardenability of shallow-hardening steels, but so

*This is discussed in some detail by Sisco.¹³²

far no universally satisfactory method has been developed. The L specimen pictured in Fig. 6.1 is a partial solution to the problem of comparing the response of these steels to quenching, and has been widely used, but specimens are not easy to prepare and there are other disadvantages such as non-uniform heat conduction, tendency of the specimen to crack in quenching when used for high-carbon steels, and others, which have been responsible for the effort to develop a better test.

One of the earliest tests for use on shallow-hardening materials and especially on unalloyed steels containing 0.30 to 0.60 per cent carbon is the *Rockwell-Inch* or SAC (surface hardness/area under the hardenability curve/center hardness) test, which was devised more than 10 years ago by Burns, Moore, and Archer.²⁸ The specimen, described by these investigators and in the *Metals Handbook*,⁵ is a bar 4 to 6 in. long and 1 in. in diameter that is machined from a forged section about 10 in. long and at least $1\frac{1}{8}$ in. in diameter.

The specimen, previously normalized, is austenitized at the proper temperature—usually 1550°F. (845°C.)—and quenched in agitated cold water. The hardened and untempered bar is cut transversely, and the cut surface is ground smooth, lightly polished, and usually etched to show the depth of hardening. Rockwell hardness tests are made on the surface of the bar, and at the center, and a series of seven measurements is made uniformly from center to surface. Another series of tests is made across the radius at an angle of 90 degrees to the first series.

One half of the hardness value at the surface and one half of the value at the center are added to the seven intermediate values and the total is divided by eight. This is the Rockwell-Inch value and represents the area under the transverse hardenability curve. Values for steels containing 0.30 to 0.60 per cent carbon range from 32 to 60 depending on the carbon content and the hardenability. The method is accurate (to about ± 1 Rockwell-Inch) when values are obtained on the same bar, but the accuracy may be much less in comparing commercial heats of practically identical composition if residuals or other factors have an appreciable effect on hardness and hardenability.

The Rockwell-Inch test is used by a considerable number of steel producers and consumers and is now being considered as a recommended practice by the Iron and Steel Technical Committee of The Society of Automotive Engineers.

A proposal was made a few years ago by McMullan¹⁰³ that the end-quench method be applied to wedge-shaped specimens for carburizing and shallow-hardening steels, with the quench being applied to one surface and hardness determinations being taken on the opposite side

of the wedge. It is claimed that the method permits more readings to be taken and that consequently fewer errors result from inaccuracy of spacing. It also presumably avoids some of the other disadvantages of the Jominy L specimen.

6.9. Special Hardenability Tests for High-Carbon Tool Steels

One method that has been used widely for determining hardenability of carbon tool steels is the Shepherd *disc hardenability* test.¹²⁶ Slabs of graduated thickness are heated for 20 min. in a pot of lead at 1420°F. (770°C.) and then quenched in a brine spray. The hardened slabs are sectioned with a thin grinding wheel and are etched to show the depth of hardening. Hardenability is reported as the thickness in thirty-seconds of an inch of the thinnest slab that shows an unhardened core of $\frac{5}{64}$ in. or larger.

Shepherd¹²⁷ later suggested another test for carbon tool steel based partially on the principles of the test described in the previous paragraph but taking grain size into account. This test, which is known as the *penetration-fracture* or P-F test, is described in the *Metals Handbook*.⁵ It consists of quenching four $\frac{3}{4}$ -in. diameter by 3-in. long samples in a brine spray, one each from 1450, 1500, 1550, and 1600°F. (790, 815, 845, and 870°C.), notching each in the middle, and fracturing it by impact. One half of each is examined for the grain size of the hardened case by comparison with a standard set of fractured specimens. Depth of hardening is observed on the other half after grinding the surface, rough polishing, and etching. The P-F characteristic is given as a numeral, in which the first four digits represent the penetration in sixty-fourths of an inch and the last four digits the fracture grain size. The first number of each group is the P-F value for a quenching temperature of 1450°F., the second represents a quenching temperature of 1500°F., and so on.

Post, Greene, and Fenstermacher¹¹² developed the *cone* test for evaluating the hardenability of steels with Shepherd P-F numbers of 10 through 16. The test consists of hardening a conical specimen, 5 in. long and having a $\frac{1}{4}$ -in. diameter at the small end and a $1\frac{1}{4}$ -in. diameter at the large end, by quenching from a furnace containing a controlled atmosphere into a 3-in. spray of 10 per cent brine solution with the small end of the cone down. After hardening, the cone is split longitudinally through the center, and Rockwell C hardness is determined on the longitudinal axis. The cooling-rate contour of the cone specimen during brine quenching from 1450 and 1650°F. (790 and 900°C.) is determined, and, with the point of critical hardness (Rockwell C hardness 55 for hypereutectoid steels) fixed by a hardness traverse of the axis of the

cone, it is possible to determine the cooling rate necessary to obtain that hardness.

The most recent modification of the end-quench test for high-carbon tool steels is the P-V (*penetration-velocity*) test developed by Shepherd.¹²⁹ Specimens with a 90-deg. chisel point and $1\frac{1}{8}$ in. long are austenitized and transferred rapidly to the quenching fixture, with the chisel edge down, and the coolant (usually brine) is sprayed on the beveled surfaces with a definite pressure.

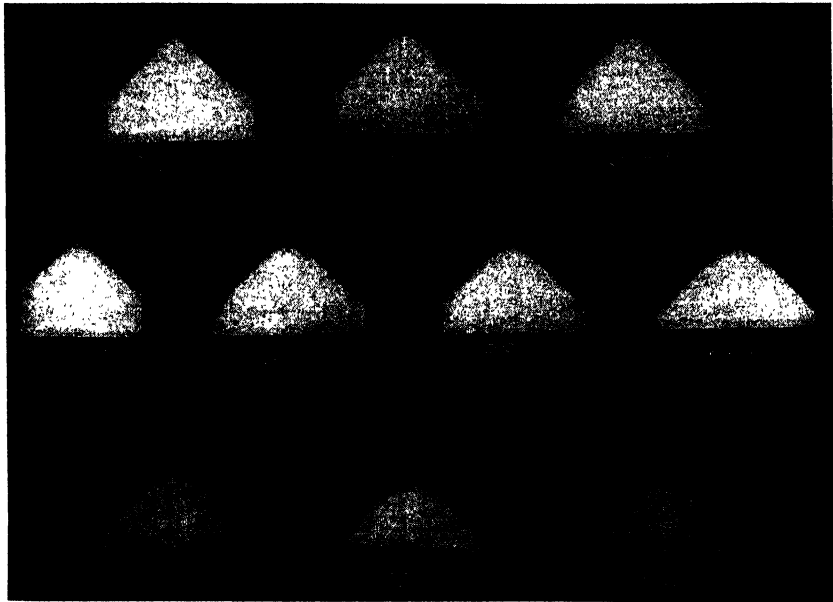

FIG. 6.10. Etched slabs in P-V hardenability test. Transition zone is much sharper in steels of lower hardenability. P-V values of specimens A67, QK-3, BC-3, BR-1, and MU are 0.162, 0.227, 0.256, 0.342, and 0.446, respectively. One half natural size. (Shepherd.)¹²⁹

When the specimen is cold enough to be handled, a center slab is cut perpendicular to the chisel edge. This is ground, if necessary, rough polished, and etched to indicate the depth of hardness (Fig. 6.10). A hardness survey may also be made as shown for specimen PX in Fig. 6.10. It was noted in a previous chapter (p. 92) that the etching characteristics of a rough-polished cross section of a quenched bar change radically when the structure contains less than 50 per cent martensite. Using this criterion Shepherd expressed hardenability (P-V value) as the distance from the apex of the angle to the location where the structure is approximately 50 per cent martensite. This distance

corresponds closely to a hardness level of 55 Rockwell C, 73 Rockwell N, 78.5 Rockwell A, or 598 Vickers (10-g. load).

The test is made readily and cheaply; and it is especially applicable to steels having an ideal critical diameter between $\frac{1}{2}$ and $\frac{3}{4}$ in. Because the 50 per cent martensite criterion is easily recognized, the P-V value can be rapidly determined and steels can be quickly compared by the etching characteristics, as indicated by Fig. 6.10, without the necessity of determining hardness, although this is valuable as a check. In addition, Shepherd found that the accuracy of the test was not affected by slight tempering, an advantage in the rapid preparation of specimens by grinding.

6.10. Hardenability Test for Air-Hardening Steels

Comparing the hardenability of steels whose critical cooling rate is very low has been a problem for some time. A few years ago, Post, Fetzer, and Fenstermacher¹¹³ developed a test for steels of this type by which it is possible to determine the relative air-hardening properties of a given high-hardenability steel for cylinders ranging from 1 in. round by 8 in. long to 6 in. round by 6 in. long.

Hardenability is given as the cooling rate at which a steel must be cooled past 1000°F. (540°C.) to obtain a definite Rockwell C hardness. As the variation in hardenability in steels of the same type is negligible, this test can be used to estimate the hardness to be expected in tools of various sizes and shapes when fabricated from air-hardening steels.

6.11. Summary

Many methods have been devised for testing hardenability by means of a standardized severity of quench calibrated with respect to the ideal quench. The most useful test for low-alloy engineering steels is the Jominy test in which a small bar is quenched on the end by a procedure that simulates the over-all quenching of larger sections. The cooling rates and half-temperature times of this specimen have been measured so that the results of a test may be utilized readily in formulas for estimating the behavior of steel in quenching. The test is, therefore, of great value for control in the manufacture as well as in the application of steel. The standard Jominy test is most useful over the middle range of hardenability, and the other commonly used test methods are mainly for application to steels of very low or very high hardenability.

CHAPTER 7

JOMINY HARDENABILITY CONTROL

PREDICTION AND CONTROL

of hardenability are essential to insure uniform response to heat treatment. The first requirement of a reproducible test method has been met in the Jominy test, so that the producer and the heat treater of low-alloy engineering steels have a common basis for measuring hardenability. Furthermore, since steels are usually specified by composition, the user should be able to predict hardenability from composition. Similarly, the producer should have the same knowledge in order to control the composition to obtain the desired hardenability. The basic effects of composition have been determined with sufficient accuracy to serve as a guide, and agreement has been reached on ranges of hardenability that may be expected in standard types of steel. Hardenability has been expressed as a band of Jominy hardness values that is guaranteed by the producer and that can be utilized effectively by the user of steel.

It is shown in Chapter 5 that it is possible to calculate hardenability in terms of ideal critical diameter by the multiplying method developed by Grossmann. This method gives us a rapid, and for many steels a relatively satisfactory, means of evaluating the merits of steels according to their response to thermal treatment, but it does not furnish directly—as does the Jominy test—quantitative data on the structure and properties that result from quenching. The ability to predict quenched hardness directly from composition and grain size is, however,

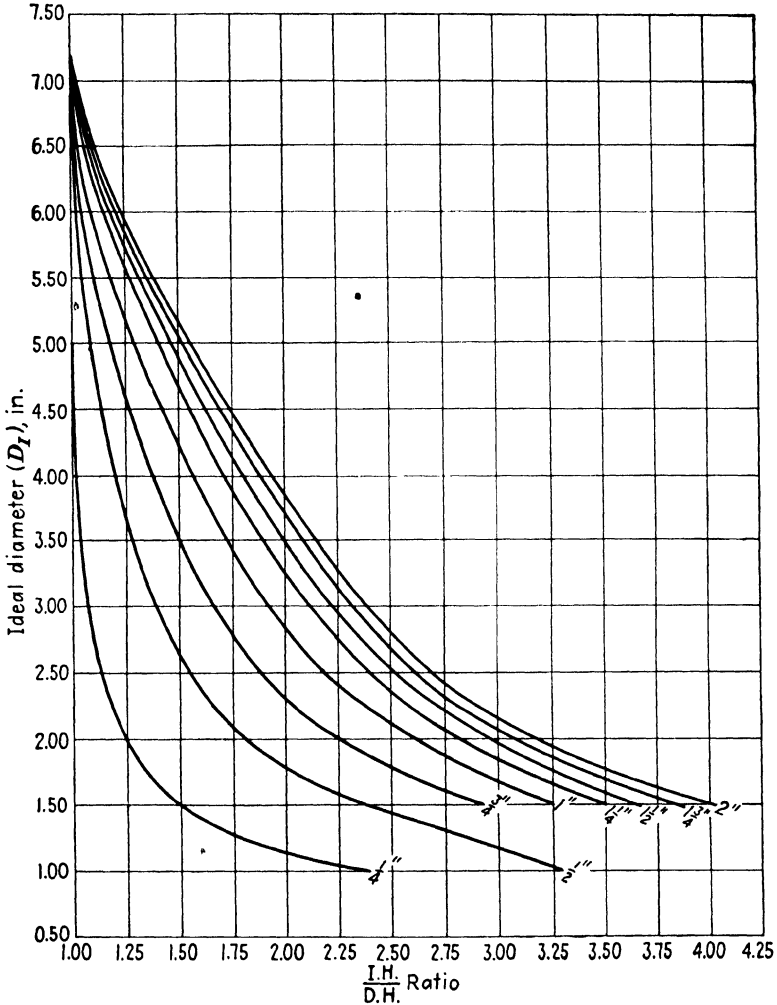

FIG. 7.1. Relation between ideal critical diameter and the ratio of initial hardness to distance hardness (IH/DH). (Boyd and Field,²⁴ after Field.⁴⁹)

frequently useful, with the result that methods have also been developed for calculating the hardness gradient in the Jominy end-quench test. In other words, it is now possible to plot a Jominy end-quench curve without making the test.

The principal methods for the calculation of hardness gradients in the Jominy curve from chemical composition and grain size are the method proposed by Field⁴⁹ based on ideal critical diameter, and the addition

method worked out by Crafts and Lamont.³⁷ These are discussed in this chapter. It should be strongly emphasized again that these methods do not and should not replace the end-quench test; they can be used to advantage where it is impossible or inconvenient to make the test, but the curves obtained should be considered only as approximations of the hardenability as determined by experimental test methods.

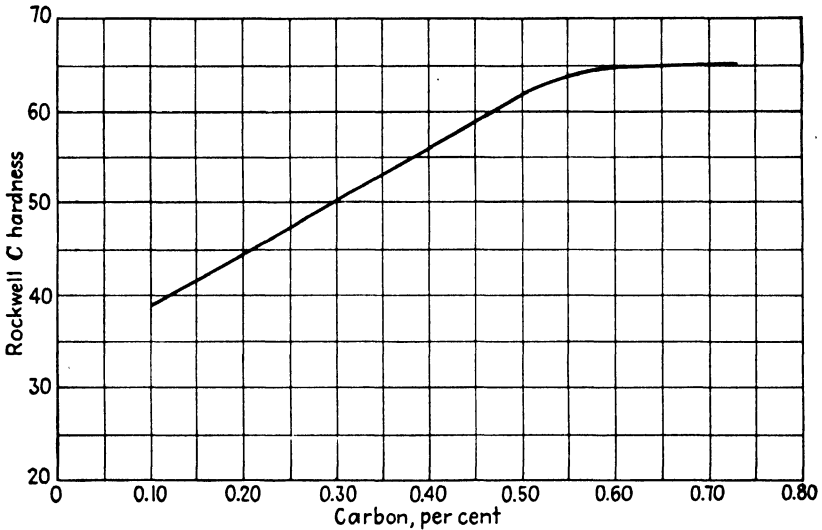

FIG. 7.2. Relation between carbon content and initial hardness at one-sixteenth of an inch from quenched end of Jominy specimen. (Boyd and Field.)²⁴

7.1. Calculation of the Jominy Curve from Ideal Critical Diameter

The method proposed by Field⁴⁹ is based on three assumptions: that the hardness at the extreme quenched end of the Jominy specimen, that is, the *initial hardness* (IH), is a function of the carbon content of the steel; that the hardness at any distance from the water-quenched end of the Jominy bar (DH) is a function of the ideal critical diameter for steel of a given carbon content; and that the ratio of the initial hardness (IH) to the hardness at any other distance (DH) is a constant function of the ideal critical diameter for any carbon content. The first step in the method is to calculate the ideal critical diameter, using the Grossmann factors shown in Figs. 5.13 and 5.14. The ratio of IH/DH is then estimated for the various desired Jominy depths from the empirically determined relation shown in Fig. 7.1. To find the hardness at a position on the Jominy curve, the initial hardness, determined from the

relation of maximum hardness to carbon as shown in Fig. 7.2, is divided by the IH/DH ratio for each position. The probable degree of error is indicated in Fig. 7.3. Because of the variable hardness of the non-martensitic constituents, the method is most accurate on the triple-alloy types of steel on which the relation was first established.

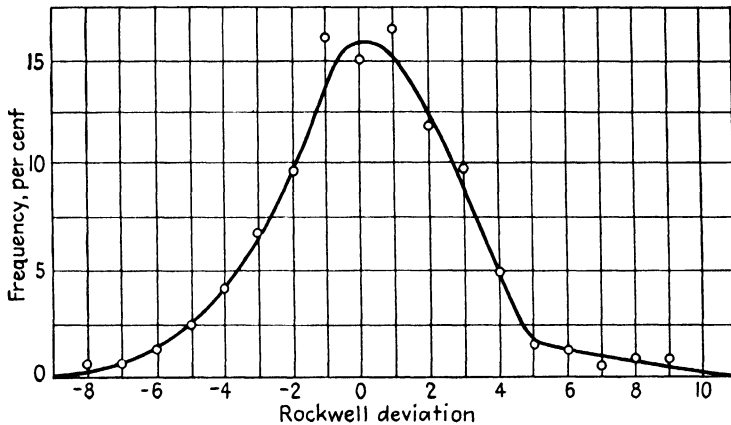

FIG. 7.3. Distribution curve of deviation between calculated results and actual results for 43 heats of low-alloy steels. (*Field*)⁴⁹

7.2. Example of Calculation of Jominy Curve from Ideal Critical Diameter

To illustrate Field's method we shall use as an example the 8640 steel containing 0.40 per cent carbon, 0.90 per cent manganese, 0.55 per cent nickel, 0.50 per cent chromium, and 0.20 per cent molybdenum whose hardenability was calculated in Section 5.9 (p. 103). If no material of this steel is available for preparing Jominy bars, the end-quench curve can be approximated. The ideal critical diameter calculated by Grossmann's method (see Section 5.9) was found to be 3.68 in. The maximum hardness for the carbon content (0.40 per cent), as shown by Fig. 7.2, is 56 Rockwell C and represents the initial hardness (IH). This hardness value is considered to represent the hardness at a distance of 1 sixteenth of an inch from the water-quenched end of the Jominy specimen.

From Fig. 7.1 the value of the ratio IH/DH is determined for each Jominy position from the point at which a horizontal line representative of $D_I = 3.68$ in. intersects the position curve. The value of the IH/DH ratio is divided into the value for IH to determine the hardness for each Jominy position as follows:

Jominy distance, in.	IH/DH	IH ÷ (IH/DH)	Calculated Rockwell C
$\frac{1}{8}$	1.00	56 ÷ 1.00	56.0
$\frac{1}{4}$	1.03	56 ÷ 1.03	54.4
$\frac{3}{8}$	1.24	56 ÷ 1.24	45.2
$\frac{3}{4}$	1.46	56 ÷ 1.46	38.4
1	1.66	56 ÷ 1.66	33.7
$1\frac{1}{4}$	1.83	56 ÷ 1.83	30.6
$1\frac{1}{2}$	1.92	56 ÷ 1.92	29.2
$1\frac{3}{4}$	2.00	56 ÷ 2.00	28.0
2	2.05	56 ÷ 2.05	27.3

By means of these values it is possible to construct the Jominy hardness curve, and using the relations between bar size, severity of quench, and Jominy test described previously (pp. 69 to 83) we can estimate the manner in which a steel of this composition will respond to heat treatment when quenched. From these relations it is found that the hardness at the center of the 0.72-in. diameter bar of this steel, indicated previously (p. 99) to be the maximum bar size in which full hardening is attained, is 55 Rockwell C after quenching with a severity $H = 0.50$.

7.3. Calculation of the Jominy Curve by the Addition Method

As the depth of hardening of the Jominy test specimen is usually measured in terms of Rockwell C hardness, it was considered by Crafts and Lamont³⁷ that it should be possible to predict hardness by a more direct method than that used by Field.⁴⁹ This was accomplished by the addition of Rockwell C units proportional to carbon and alloy content and grain size. Certain inaccuracies observed in calculating the ideal critical diameter of low-carbon and chromium-molybdenum steels were not found in this method of calculating Jominy hardness.

The method assumes that "pure" iron-carbon alloys, when cooled at rates corresponding to those of the Jominy specimens, will have a certain hardness indicated in Fig. 7.4 as "carbon-base" hardness. Up to a certain hardness, designated as the "martensite-base" hardness, alloying elements present in the steel add hardness units to the carbon-base hardness in the proportion shown in Table 7.1.

TABLE 7.1. Increment of Quenched Hardness Due to Addition of 1 Per Cent Alloying Element*

Alloying element	Rockwell C units per 1 per cent of alloying element
Manganese	15.5
Silicon	5.0
Nickel	5.5
Chromium	15.0
Molybdenum	37.5

*Grain size—Add 1 Rockwell C unit for each grain number below 10.

In the martensitic range there is a disproportionate increase in hardness so that the excess in the sum of carbon-base and alloy-addition units over the martensite-base hardness is multiplied by a factor that increases from 1.25 at 0.05 per cent carbon to 4 at 0.60 per cent carbon. The factors and a convenient nomographic chart are given in the next

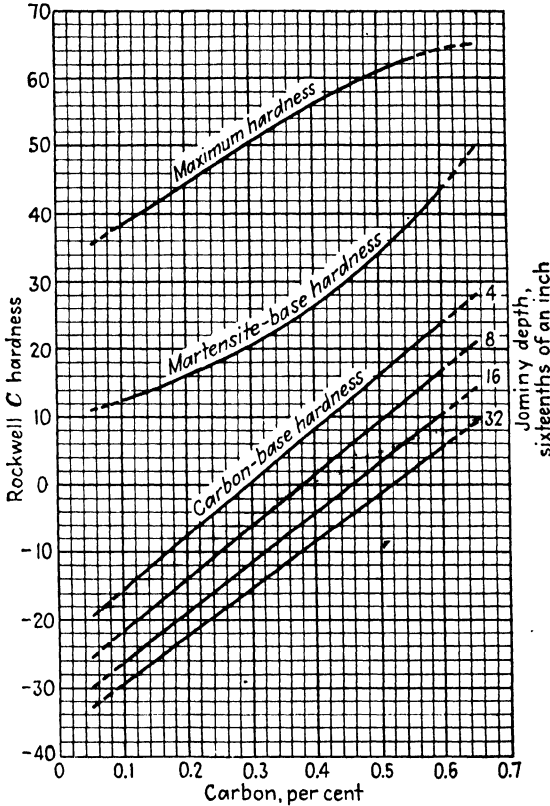

FIG. 7.4. Carbon-base hardness, martensite-base hardness, and maximum hardness as dependent on carbon content. (Crafts and Lamont.)³⁷

section. The accuracy of the calculation is illustrated by Fig. 7.5 showing actual and calculated hardness values in comparison with the hardenability band of 8640 steel.

It should be noted that the martensite-base hardness, the martensite factor, and the maximum hardness are dependent only on carbon and that the carbon-base hardness is dependent to only a slight degree on cooling rate. Similarly, the effects of the alloying additions are independent of carbon, cooling rate, and each other, and have effects analo-

gous to an increase of cooling rate. Thus, it is again confirmed that alloying elements affect the hardening of steel primarily through their effect on the cooling rate.

The calculation of Jominy hardness is accurate within about ± 6 Rockwell C, which is accurate enough to serve as a guide to the selection and heat treatment of alloy steel, but it is probably not accurate enough

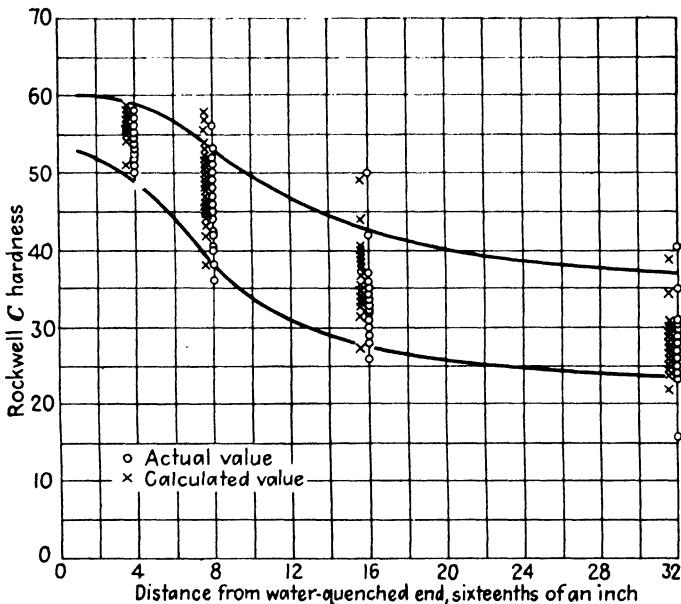

FIG. 7.5. Comparison of actual and calculated hardness of 37 specimens with the tentative hardenability band of 8640 steel. (Crafts and Lamont.)³⁷

for control purposes. Reasonably accurate results may be obtained in the comparison of similar steels by adding increments for differences of composition to an experimentally determined base. The use of Rockwell hardness is convenient in that it is a logarithmic function of hardness. Thus, according to the addition formula, each unit of alloying element contributes equally to hardness, and it is easy to evaluate the relative benefit of different elements.

By the method developed by Crafts and Lamont^{38, 39, 40} (discussed in this section and in the next chapter) it is possible to estimate not only the Jominy hardness, but also the tempered hardness and the notched-bar impact resistance from chemical composition. In these calculations advantage is taken of the logarithmic relation between Rockwell C hardness and Brinell hardness or tensile strength so that functions that

ordinarily require multiplication are made additive by the use of Rockwell C hardness as the index of strength.

7.4. Example of Calculation of Jominy Hardness by the Addition Method

Assume that it is desired to know the Jominy hardness curve for an 8645 steel of grain size 8 and the following composition:

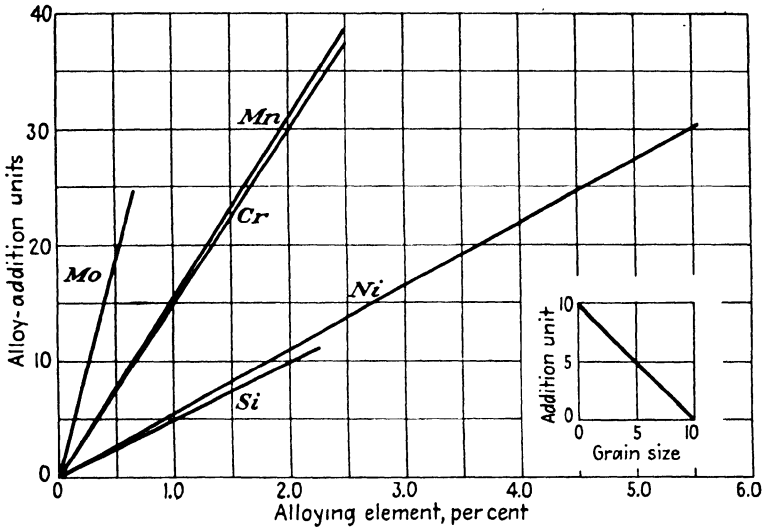

FIG. 7.6. Alloy addition units (Rockwell C) for the common alloying elements. (Crafts and Lamont.)³⁷

Element	Percentage
Carbon	0.45
Manganese	0.85
Silicon	0.22
Nickel	0.50
Chromium	0.50
Molybdenum	0.20

Actual grain size, No. 8

The first step is to determine the addition units by which the individual alloys increase the hardness of the “pure” iron-carbon alloy. This may be done graphically from Fig. 7.6 by reading off the addition units proportional to the amount of each alloying element present in the steel. These amounts together with the grain-size unit are added to obtain the total number of alloy-addition units. The addition units may also be calculated by multiplying the percentage of the alloying

element by the factors given in Table 7.1 for 1 per cent of each element as follows:

<i>Alloying element</i>	<i>Percentage × Factor</i>	<i>Addition unit calculated or determined from Fig. 7.6</i>
Manganese	0.85×15.5	13.2
Silicon	0.22×5.0	1.1
Nickel	0.50×5.5	2.7
Chromium	0.50×15.0	7.5
Molybdenum	0.20×37.5	7.5
No. 8 grain size		2.0
Total alloy-addition units		34.0

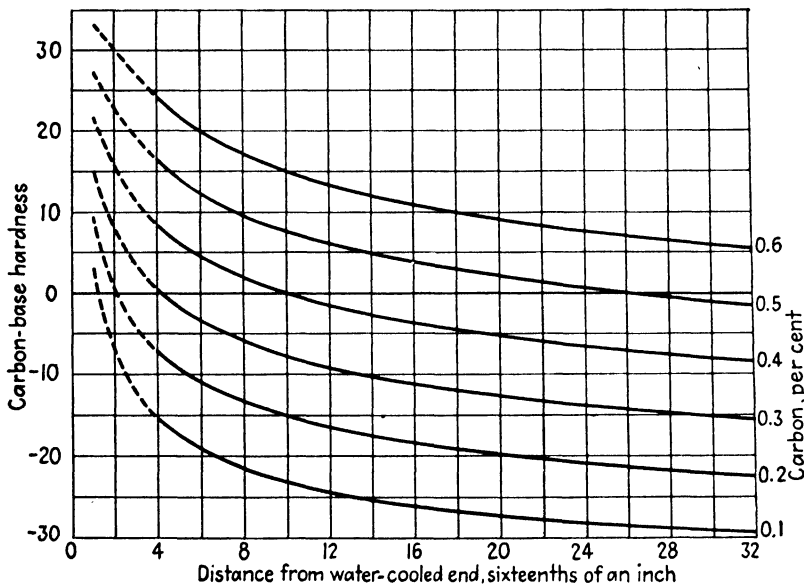

FIG. 7.7. Effect of cooling rate, expressed as Jominy distance, on carbon-base hardness (Rockwell C). (*Crafts and Lamont.*)²⁷

The total alloy-addition units are then added to the carbon-base hardness of the “pure” iron-carbon alloy for each Jominy depth shown in Fig. 7.4. For Jominy depths not shown on this curve the carbon-base hardness may be estimated from Fig. 7.7 for the carbon content of the steel.

If the sum of the carbon-base hardness and the alloy-addition units exceeds the martensite-base hardness indicated for the carbon content in Fig. 7.4—that is, if it exceeds 30 Rockwell C in 0.45 per cent carbon steel—an addition increment for martensite must be added. This

factor has been incorporated in the nomographic chart given in Fig. 7.8 to avoid further calculation. To obtain the quenched hardness, the sum of carbon and alloy-addition units is located on the right-hand side of the diagram and traced to the left. If the lower boundary line is met before the ordinate representing the carbon content of the steel is reached, the hardness at that point represents the calculated hardness. If the upper boundary line is reached before the carbon ordinate is reached, the hardness at that point represents the maximum hardness.

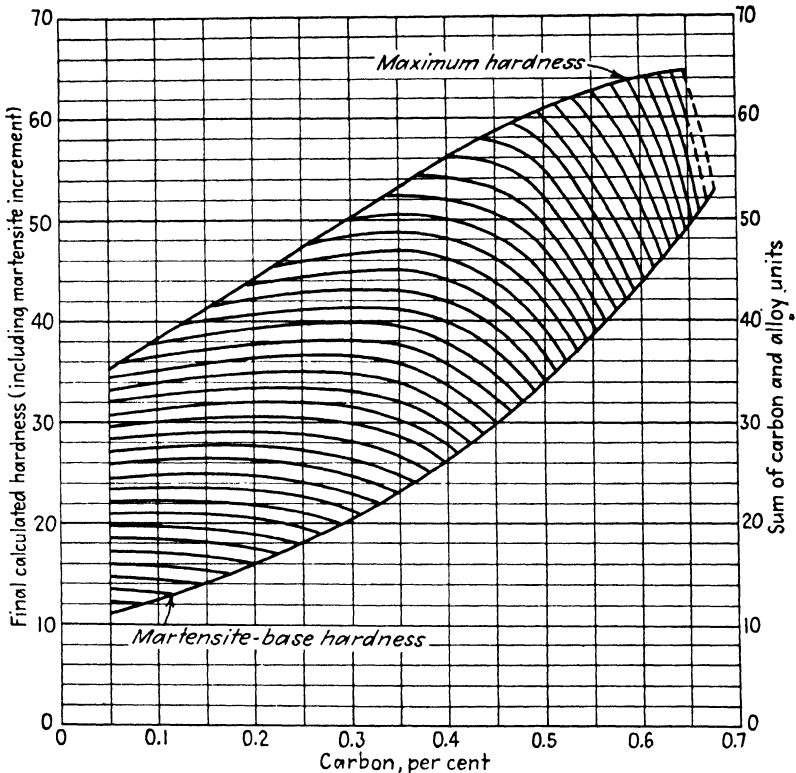

FIG. 7.8. Nomographic chart for determining as-quenched hardness (Rockwell C) from sum of carbon-base hardness and alloy units. (Crafts and Lamont.)³⁷

reached, the upward-curving line is followed to the carbon ordinate and the hardness at that point is read off the left-hand scale. This is the case at the 8 and 16 sixteenths of an inch locations in the example shown in Table 7.2. If the upper boundary line is reached before the carbon ordinate, as it is at the 4 sixteenths location, the boundary line is followed to the carbon content and that point represents the calculated (maximum) hardness. If the carbon ordinate is reached first, in the lower hardness levels, the sum of carbon and alloy-addition units represents the calculated hardness. This is the case at the 32 sixteenths

TABLE 7.2. Example of Use of Nomographic Chart Shown in Fig. 7.8 for Determining Calculated Hardness

Steps of calculation	Jominy depth, in.			
	$\frac{1}{16}$	$\frac{1}{8}$	$\frac{1}{4}$	$\frac{3}{8}$
Carbon-base hardness	+12.1	+ 5.4	- 0.3	- 5.0
(Plus) alloy-addition units	34.0	34.0	34.0	34.0
Sum	46.1	39.4	33.7	29.0
Calculated hardness (Fig. 7.8)	58.7	51.6	38.5	29.0

location in Table 7.2, where 29 Rockwell C is less than the martensite-base hardness of 30 Rockwell C.

If it is desired to make the calculation arithmetically without the nomographic chart, the martensite increment is determined by subtracting the martensite-base hardness from the sum of the carbon-base hardness and total alloy and grain-size addition units and multiplying this difference by the martensite factor shown in Fig. 7.9. The product is added to the martensite-base hardness to obtain the calculated Jominy hardness as indicated in Table 7.3. If the hardness from this calculation exceeds the maximum attainable hardness for the carbon content of the steel indicated by the maximum line in Fig. 7.4, that is, if it exceeds 58.7 Rockwell C in a steel containing 0.45 per cent carbon as it does at the 4 sixteenths location, the maximum hardness is considered to be the calculated hardness. If the sum of the carbon and alloy units

TABLE 7.3. Example of Determining Calculated Hardness Arithmetically

Steps of calculation	Jominy depth, in.			
	$\frac{1}{16}$	$\frac{1}{8}$	$\frac{1}{4}$	$\frac{3}{8}$
Sum of carbon and alloy units	46.1	39.4	33.7	29.0
(Minus) martensite-base hardness, from Fig. 7.4	30.0	30.0	30.0	30.0
Difference	16.1	9.4	3.7	
(Times) martensite factor, from Fig. 7.9	2.3	2.3	2.3	
Product	37.0	21.6	8.5	
(Plus) martensite-base hardness, from Fig. 7.4	30.0	30.0	30.0	
Total	67.0	51.6	38.5	
Calculated hardness	58.7	51.6	38.5	29.0

is less than the martensite-base hardness, as it is at a Jominy depth of 32 sixteenths of an inch in Table 7.3, this sum (29.0 Rockwell C in the above calculation) is the calculated hardness. The calculated-hardness values may be plotted and a Jominy hardness curve drawn as in Fig. 7.10.

Full hardening is maintained to a depth of about 6 sixteenths of an inch from the water-quenched end, and the hardness at this point is

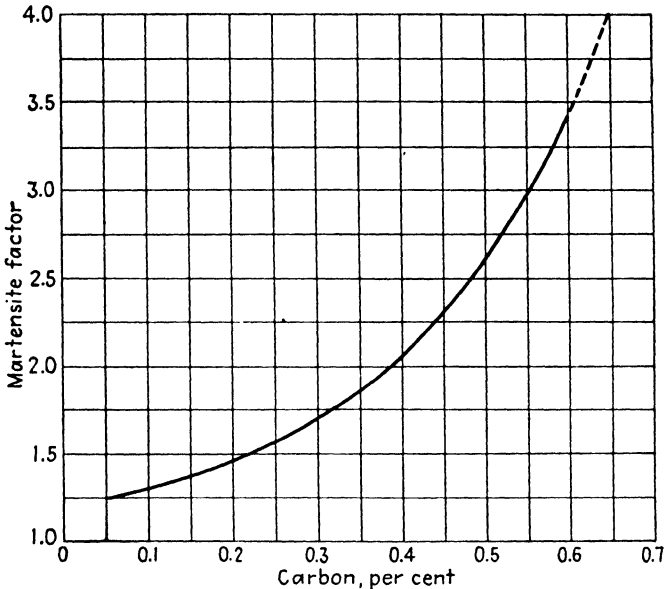

FIG. 7.9. Relation between carbon content and martensite factor. (*Crafts and Lamont.*)³⁷

57.6 Rockwell C. From the relations between Jominy hardness, severity of quench, and hardening discussed previously, it may be estimated that the maximum size of bar that will harden completely at the center when quenched with a severity of $H = 0.35$ is 1.0 in. in diameter.

7.5. The Development of Hardenability Bands

Bands defining the minimum and maximum Jominy hardness to be expected in commercial heats of alloy steels have been established within the past five years by The Society of Automotive Engineers and the American Iron and Steel Institute.¹³³ These hardenability bands are recommended for specification purposes, and it is now possible to purchase steels of several types (compositions given in Appendix I) with hardenability guaranteed to fall within these bands.

During World War II, the demand for alloying elements was so great

that it was not possible to produce enough of the SAE type steels containing relatively large amounts of scarce alloys. New alloy-steel compositions were introduced—the so-called National Emergency (NE) steels—to use the more available alloying elements and to utilize the residual alloying elements in the scrap more effectively. These triple-alloy steels were designed to have hardenability characteristics similar

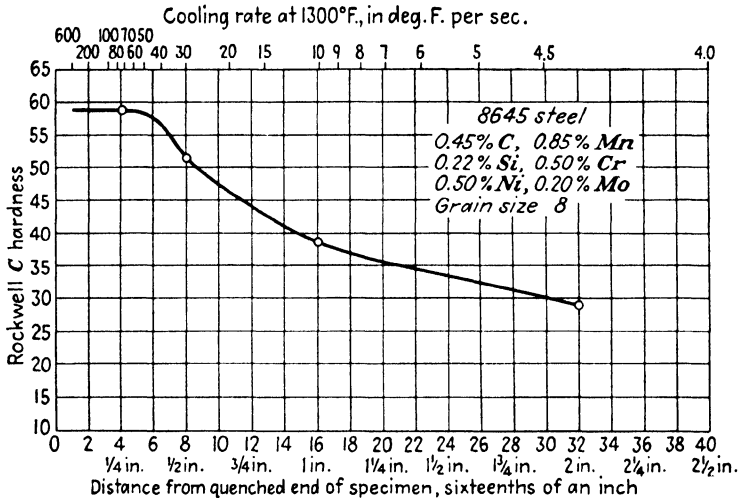

FIG 7.10. Jominy hardenability curve for 8645 steel calculated by addition method.

to those of the older steels and were substituted for many of the older SAE grades on the basis of Jominy hardenability. As soon as some experience was gained in the large-scale application of Jominy testing it became apparent, however, that the range of hardenability resulting from differences of composition in one grade was too wide to insure adequate minimum properties economically. For example, Parker¹⁰⁰ states that there is a possible spread in the hardenability of 4140 made to standard chemical specifications of 29 Rockwell C numbers (i.e., from 29 to 58) at a Jominy distance of 16 sixteenths from the quenched end of the specimen.

Study of Jominy hardenability test data for heats of standard types by the Technical Committee on Alloy Steel of the American Iron and Steel Institute revealed that extremely high and low hardenability resulted from only a small percentage of the heats. Even this percentage could be reduced, if the composition ranges were broadened so that during refining of the heat more compensation could be made for

alloying elements that happened to be near the limits of the composition ranges. By cooperation with the Iron and Steel Committee of the War Engineering Board and the Iron and Steel Division of The Society of Automotive Engineers mutually agreeable bands of minimum and maximum Jominy hardenability were tentatively established for a number of commonly used steels.¹³³ The composition specifications were broadened somewhat (Table 7.4), and the steels were guaranteed to have hardenability within the accepted limits.

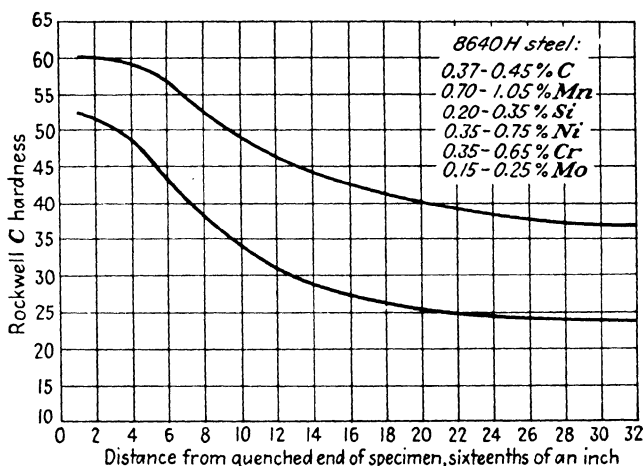

FIG. 7.11. Tentative hardenability band for 8640H steels. (Society of Automotive Engineers and American Iron and Steel Institute.)¹³³

The steels specified to hardenability-band limits are distinguished by the suffix letter H added to the series number; e.g., 8640H, for which a typical hardenability band is shown in Fig. 7.11. The degree of relaxa-

TABLE 7.4. Composition Limits (1947) for Two Low-Alloy Steels for Which Hardenability (H) Is and Is Not Specified*

Steel No.	Chemical composition, per cent					
	C	Mn	Si	Ni	Cr	Mo
4140	0.38-0.43	0.75-1.00	0.20-0.35		0.80-1.10	0.15-0.25
4140H	0.37-0.45	0.70-1.05	0.20-0.35		0.80-1.15	0.15-0.25
8640	0.38-0.43	0.75-1.00	0.20-0.35	0.40-0.70	0.40-0.60	0.15-0.25
8640H	0.37-0.45	0.70-1.05	0.20-0.35	0.35-0.75	0.35-0.65	0.15-0.25

*Society of Automotive Engineers and American Iron and Steel Institute.¹³³

ation in the chemical composition for two commonly used steels is shown by Table 7.4.

Although the bands are wider than the steel user would like, they reflect a high order of hardenability control in steelmaking. Thus, they represent a major improvement over the earlier specification of composition, but the possible range is so wide that in an individual case the actual hardenability may be more or less than is desired. For economical and precise application of steel it would appear reasonable

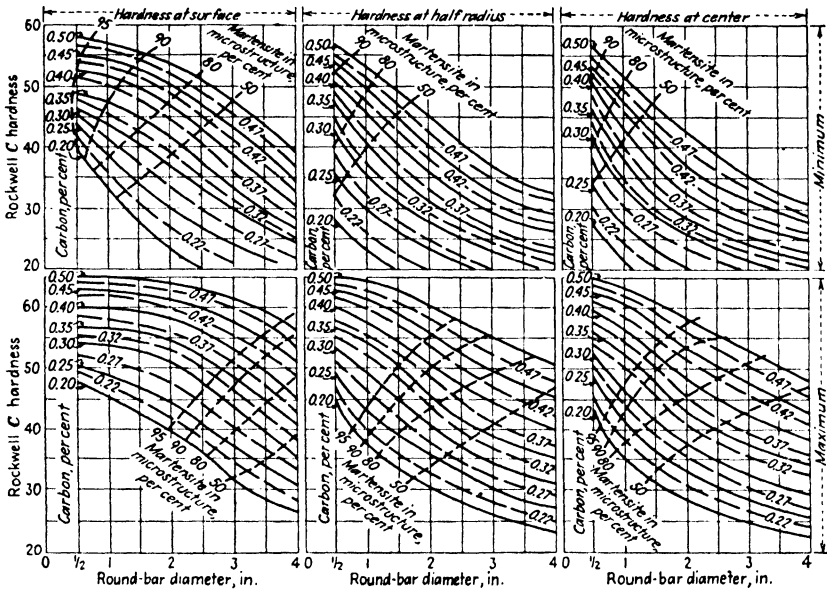

FIG. 7.12. Hardness to be expected for minimum and maximum hardenability at the surface, mid-radius, and the center of oil-quenched rounds of 8600H steels. (Boegehold.)²³

to practice selection and diversion of heats within still narrower ranges. The relation between minimum and maximum hardenability and the hardness of quenched and tempered bars of 8600 steels is shown in Figs. 7.12 and 7.13. Because of the effect of percentage of martensite on the final properties, the deficiencies of inadequate hardenability are even more significant than indicated by the hardness levels.

After experience had been gained in making and using steels of specified hardenability, revisions of the tentative bands were made.¹³³ In general, they were narrowed somewhat, largely by raising the minimum limit. It appeared that heats near the maximum do not tend to give unreasonable difficulty in machining, warping, or cracking, whereas

heats near the minimum may be critically deficient in strength and ductility after tempering. One effective solution of this problem, where maximum hardenability is important, is to use a somewhat lower carbon and higher alloy content to achieve the desired degree of hardening combined with a lower maximum hardness and better ductility. Additional data on other types of steel have permitted the specification of hardenability in a considerable number of steels. The current hardenability-band limits for H steels are given in Appendix II.

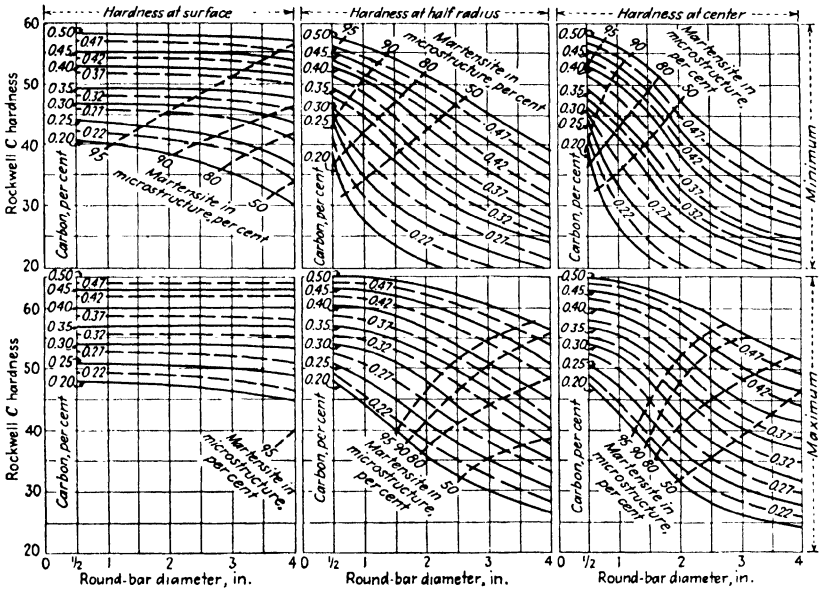

FIG. 7.13. Hardness to be expected for minimum and maximum hardenability at the surface, mid-radius, and the center of water-quenched rounds of 8600H steels. (Boegehold.)²³

7.6. Use of Hardenability Bands for Specifying Hardenability

The Society of Automotive Engineers and the American Iron and Steel Institute¹³³ recommend that, in using hardenability bands for specification purposes, certain "points on the curves should be selected [as indicated in Fig. 7.14]; the full length of the curve should not be specified." To identify the points with assurance, hardness values from available tables,¹³³ such as those given in Appendix II, should be used rather than reading the values from end-quench curves.

A typical illustration of the methods of specifying hardenability requirements is shown in Fig. 7.14. These are as follows:

- (A) The maximum and minimum distances at which the desired

hardness values occur. This is indicated by A-A on Fig. 7.14, and in this case the specification would read $J_{45}=4$ to 11 sixteenths.

(B) The maximum and minimum hardness values at any desired distance. This is indicated by points B-B on Fig. 7.14, and in this case the specification would read $J_{36/50}=8$ sixteenths. Obviously the distance on the Jominy curve selected for specification purposes should correspond to the section treated by the consumer.

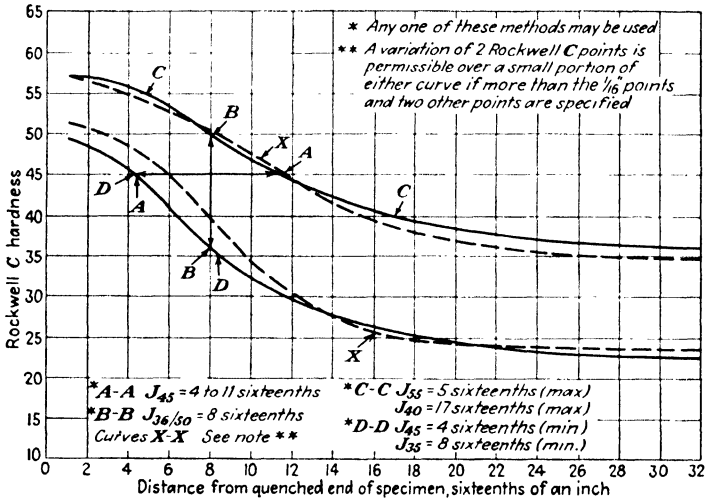

FIG. 7.14. Methods for specifying hardenability. (Society of Automotive Engineers and American Iron and Steel Institute.)¹³³

(C) Two maximum hardness values at two desired distances could be specified as indicated by points C-C; or two minimum hardness values at two desired distances could be required as indicated by points D-D in Fig. 7.14.

It is, of course, possible to specify any point on the minimum curve and any point on the maximum curve, and in addition maximum and minimum values at a distance of $\frac{1}{8}$ in. from the quenched end may also be included in the requirements.

The Society of Automotive Engineers and the American Iron and Steel Institute¹³³ recommend that, where it is desirable to specify more than two locations on the band (exclusive of the maximum and minimum at $\frac{1}{8}$ in.), a tolerance of 2 Rockwell C numbers be permitted over any small section of the curve. This is necessary because the Jominy curves of individual heats may vary slightly from the standard band limits and thus may deviate a little at one or more points on the whole

curve. Such a condition is shown by the dotted curves marked X-X in Fig. 7.14.

7.7. Factors to Be Considered in the Use of the Hardenability Band

The manner in which the hardenability band is used for the selection of an engineering steel depends on how strictly the final properties must be controlled. If the severity of the quench and the effective section are known, the appropriate Jominy distance from the water-quenched end may be estimated by the methods given in Chapter 4. The severity of service will determine the percentage of martensite or the as-quenched hardness that is desirable at a definite Jominy distance. When a high order of properties demands a high proportion of martensite, the minimum hardness of the band at the pertinent point on the Jominy hardenability band is usually well below the hardness that will just give the required strength after a minimum of tempering. If the requirements are not so severe and only stipulate a certain tensile strength after tempering in the range of 800 to 1000°F. (425 to 540°C.), the minimum as-quenched hardness necessary to achieve a certain tempered hardness may be calculated by the methods given in the next chapter.

In making calculations that require the use of chemical composition it has been found that a reasonably close approximation may be made by assuming that the minimum limit of hardenability corresponds to a composition in which the amount of each element is one-third of its range of chemical analysis above the minimum of the specification. Similarly, the maximum hardenability may be considered to be represented by one-third of the range of each element below the maximum of the specified range. If it is imperative that the very lowest expected value be estimated, it must be remembered that the hardenability band is based on ladle samples. Segregation may result in less than minimum hardenability locally in a heat that is otherwise within the specified range of hardenability. This principle is recognized in check-analysis variations and should be expected in hardenability. An allowance of 2 to 4 Rockwell C may be made for segregation. In critical cases, the chemical composition used for calculating estimates of minimum hardness has sometimes been as low as 10 per cent above the minimum of the specified range. Such low values might occur only in a small part of a heat and only in a very small proportion of the heats so that such rigid control of the minimum hardenability would be justified only in those extreme cases in which there is a negligible factor of safety. Furthermore, the difficulty of controlling the quench to a comparable degree is such that it seems academic to attempt to be too precise in trying to estimate the hardenability of the steel.

7.8 Summary

Hardenability is a critical characteristic that is a key to many of the properties that may be developed in heat-treatable steel and has proved useful as a criterion of potential applicability. Control of hardenability is possible only because the effects of composition have been evaluated. It is possible to predict hardenability from composition with some degree of accuracy. This makes control in production feasible and facilitates the selection of suitable and economical steels. Specified hardenability, as manifested by the hardenability bands of H steels, is a promising step toward the economical and effective selection of low-alloy steel. The band is wider than is desirable, and for accurate control it may be helpful to select heats within the specified range. Fine distinctions in degrees of hardenability, however, do not appear to be justified by the present state of the art of heat treating.

CHAPTER 8

TEMPERING AFTER HARDENING

STEEL IS RARELY PUT into service in the as-quenched condition owing to the stresses introduced by quenching and because of the lack of toughness and ductility that is associated with the presence of much freshly formed martensite. To reduce these stresses and improve toughness and ductility, the quenched steel is tempered by reheating to some temperature below the one where alpha iron changes to gamma. A stress-relieving treatment, at temperatures up to 500°F. (260°C.), is generally applied to high-carbon and a few low-alloy steels that have been drastically quenched to produce a structure consisting primarily of martensite and where high hardness or strength is required, as for tools, gears, and bearings. Such a treatment produces improved dimensional stability, ductility, and resistance to cracking. Steels requiring still greater toughness are tempered at temperatures between about 800 and 1200°F. (425 and 650°C.). This results generally in a material decrease in hardness and tensile strength and an increase in ductility and toughness. Regardless of the tempering treatment, however, the optimum combination of strength and toughness is obtained by first quenching to a fully martensitic structure.

8.1. Effect of Tempering on Structure

The changes in mechanical properties of a steel during tempering result partly from stress relief but mainly from microstructural changes

that occur during heating. These changes are influenced primarily by the tempering temperature but also by factors such as carbon and alloy content, time held at tempering temperature, and the character of the initial structure. When freshly formed martensite is reheated, it undergoes a change in lattice structure from the tetragonal to the cubic structure of ferrite with rejection of carbon, which was in supersaturated solution in the tetragonal lattice. This process also acts to

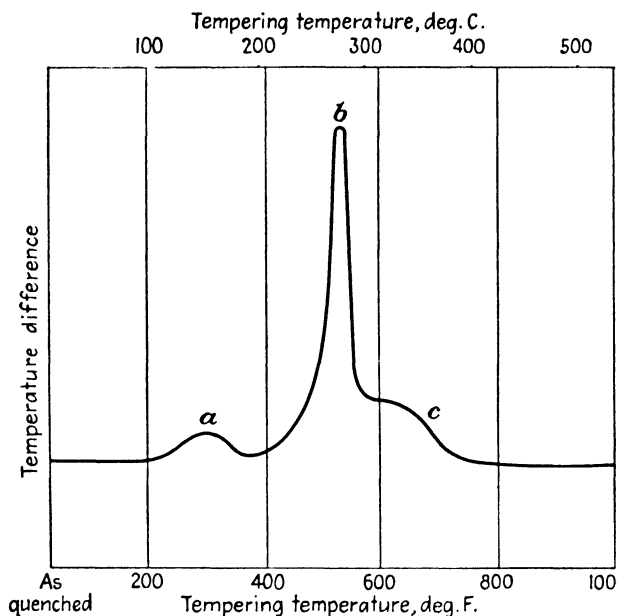

FIG. 8.1. Heat evolution in quenched steel (martensitic) with increasing tempering temperature. (Esser and Cornelius.)⁴⁸

give a dark-etching appearance to the martensite needles without materially altering the structure. Although there is some question as to the nature of the carbide rejection during the early stages of tempering, Antia, Fletcher, and Cohen⁹ concluded that the carbon is rejected in some transitory form that ultimately transforms into cementite. This conclusion is substantiated by the work of Arbutov and Kurdyumov,¹⁰ who studied the decomposition of a single crystal of martensite and found X-ray evidence of a transition structure. Unpublished work* on the residues of electrolytic extraction has suggested that the transition structure is Fe_2C .

In heating to somewhat higher temperatures the austenite that is

*C. M. Offenbauer, at Union Carbide and Carbon Research Laboratories, Inc.

retained with the martensite tends to transform. In plain carbon steels examined by Antia, Fletcher, and Cohen, transformation occurred either isothermally or on heating in the range of 450 to 550°F. (230 to 290°C.). The decomposition product is quite similar to the martensite of the first stage of tempering although its acicular configuration is more like bainite.

At slightly higher temperatures—550 to 750°F. (290 to 400°C.)—the transition structure that is precipitated with the ferrite from martensite transforms to cementite. Transformation is evidenced by a heat effect and by the appearance of the cementite X-ray diffraction pattern. In the decomposition of martensite, Esser and Cornelius⁴⁸ have shown three apparent heat evolutions in the course of heating to about 1000°F. (540°C.) as illustrated in Fig. 8.1. The heat evolution at the point marked *a* is thought to be associated with the change of the tetragonal alpha-iron lattice to the normal cubic lattice with the rejection of the transition carbide. The heat of transformation accompanying the change from austenite to the aggregate of ferrite and transition carbide structure is shown by point *b*. Point *c* would, according to Antia, Fletcher, and Cohen's conclusions, be indicative of heat evolved during the transformation of the transition structure to cementite. However, Bain¹⁹ suggests that it may be related to the recrystallization of the ferrite matrix as it changes from one form to another.

At temperatures higher than those of the third stage of tempering, the individual cementite particles are considered to coalesce and increase in size with increase in temperature. If it is desired to have large spheroidized carbide particles, the steel is tempered at a temperature just below A_1 for a fairly long period of time. The effect of longer time on the tempering reactions is to some extent the same as the effect of higher temperature.⁷⁵

8.2. Relation between Tempering and the Hardness of Quenched Steel

The changes in carbide distribution and form during tempering greatly affect the hardness of steel. Structural changes occur almost continuously over the range of subcritical temperatures, and the chief reaction after the formation of cementite is the growth of the carbide particles. It would be expected, therefore, that the hardness would in general decrease as the tempering temperature is raised since coalescence and growth of the carbide particles result in an increase in the mean ferrite path (see p. 86). This is shown for high-carbon steel in Fig. 8.2. However, at temperatures below those at which cementite is formed, that is, in the first two stages of tempering, reactions occur that may result in a slight increase in hardness as shown in Fig. 8.3 taken

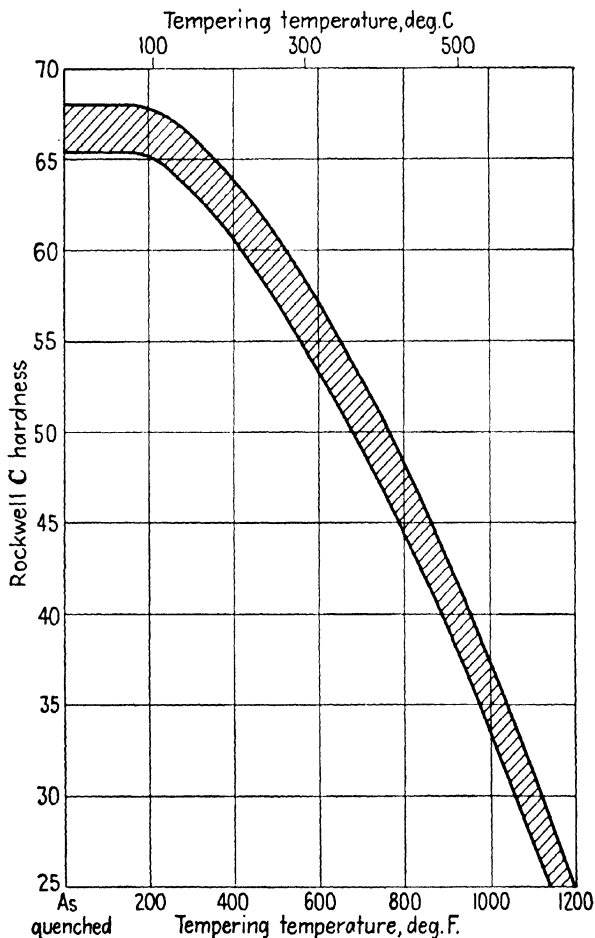

FIG. 8.2. Effect of tempering on the hardness of water-quenched high-carbon steel. (Gill and associates.)⁵⁶

from the work of Fletcher and Cohen.⁵⁰ Except for the 0.49 per cent carbon steel a slight increase in hardness is shown in all the steels. This is considered to result from a precipitation-hardening effect of the carbide transition structure. It should be noted that transformation of residual austenite in tempering is comparable to isothermal transformation on initial cooling and that steels containing austenitic bainite structures may require tempering for a long time or at a high temperature to complete the transformation of the austenite.

In an investigation of tempered hardness of Jominy specimens at the Union Carbide and Carbon Research Laboratories, it was observed that at the martensitic water-quenched end of the specimens, the appearance of the martensite could be classified into the three types as shown in Fig. 8.4. Type I near the water-quenched end consists of

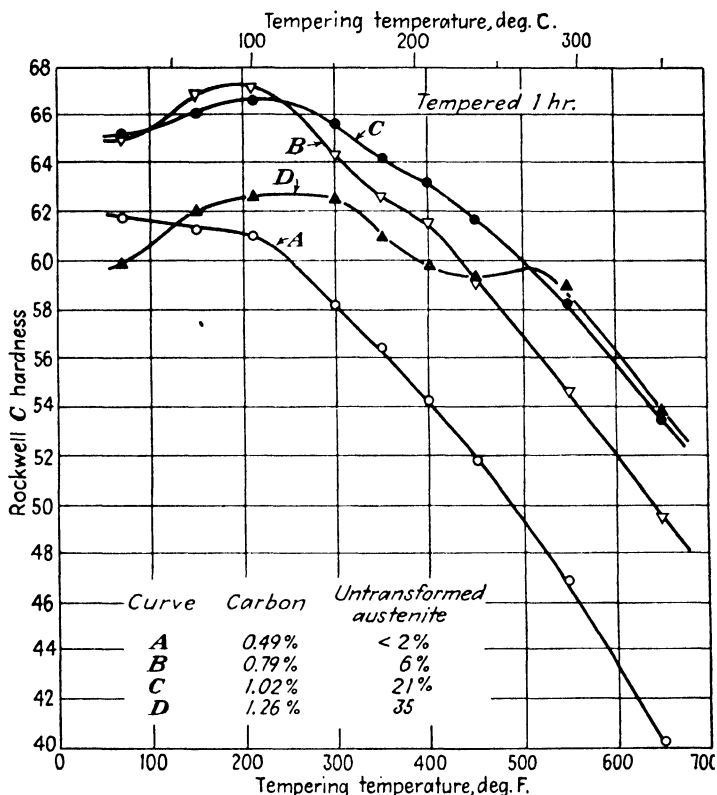

FIG. 8.3. Hardness-tempering curves for tempering for one hour at various temperatures steels containing 0.49 to 1.26 per cent carbon. (Fletcher and Cohen.)⁶⁰

well-defined needles, whereas type III nearest to the higher temperature transformation products is less well defined and has a tempered appearance.

The structural differences of the three types are believed to reflect primarily degrees of self-tempering during quenching. If retained austenite is present, it may be present in types II and III to a greater extent than in type I in accordance with Mathews¹⁰¹ observation that greater stresses induced by very rapid cooling promote more complete

transformation. On tempering in the range of 400 to 600°F. (205 to 315°C.) a disproportionate softening occurs in the type I martensite, as shown in Fig. 8.5. In the barely full-hardened zone, where the structure is predominantly type III martensite, little or no softening is found. In the next zone, which is largely martensitic with some bainite

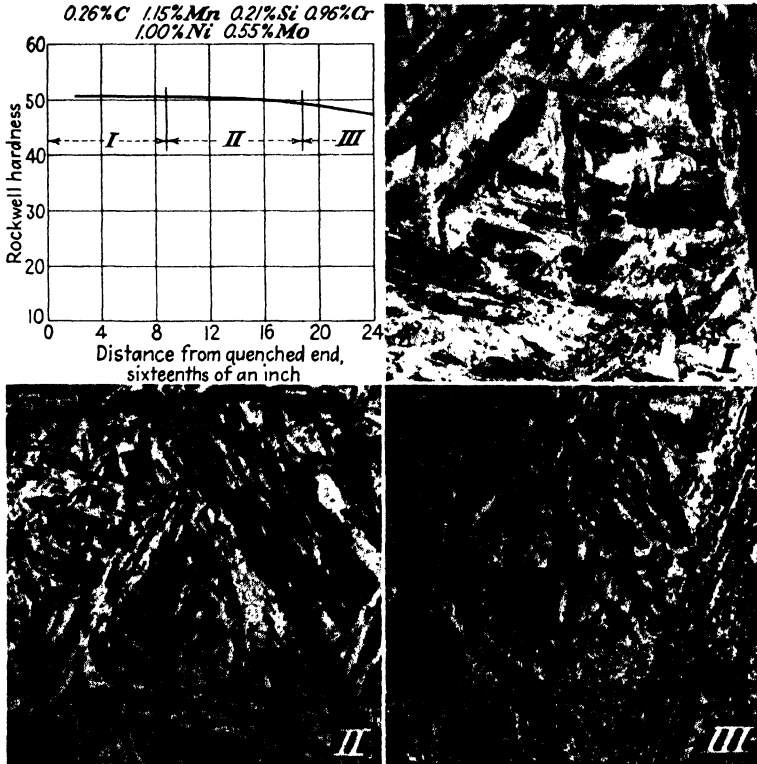

FIG. 8.4. Types of martensite in hardened Jominy specimens. Original magnification 2000 \times ; reduced $\frac{1}{8}$.

and ferrite and consequently of a lower as-quenched hardness, tempering produces an increase in hardness, the increase becoming less as the initial hardness and the percentage of martensite become less. These changes in hardness have not been studied sufficiently to give substantiated reasons for the behavior. However, the ferrite-bainite-martensite structure may contain a substantial amount of residual austenite, as indicated by Klier and Lyman,⁹¹ which will increase the hardness when transformed on tempering. These observations are of interest in connection with the behavior of quenched high-carbon gear

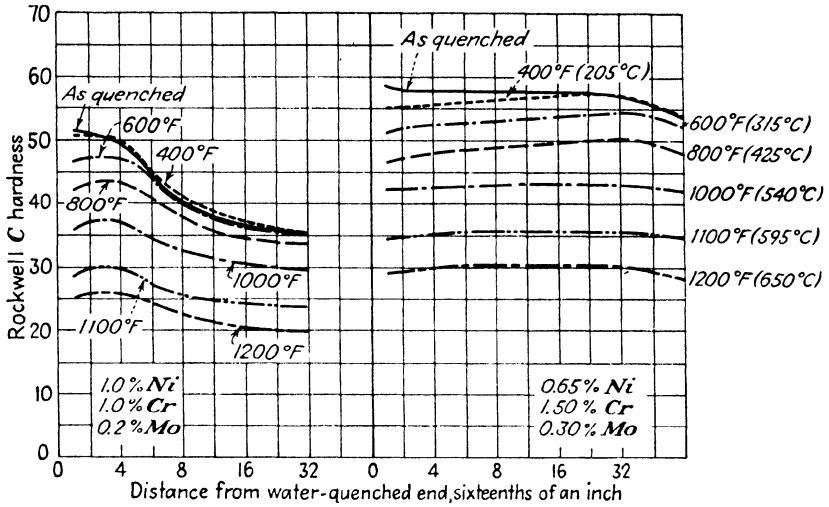

FIG. 8.5. Tempered Jominy hardness curves of semideep-hardening (left curves) and deep-hardening (right curves) steels.

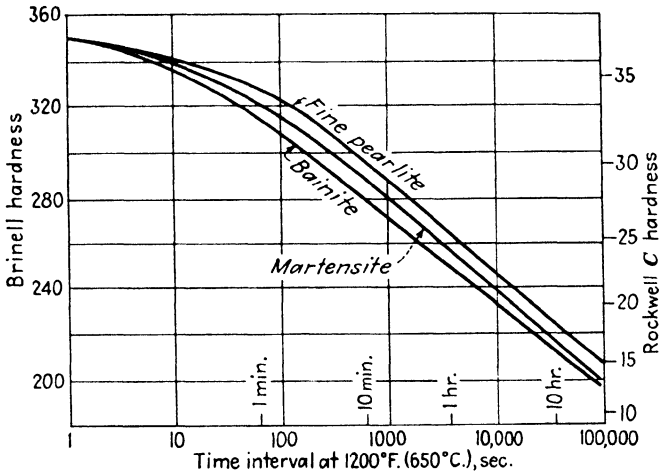

FIG. 8.6. Rate of softening at 1200°F. (650°C.) of three characteristic structures of the same initial hardness. (Engel.)⁴⁷

steel, which seems to require more than a bare minimum of alloying addition to produce a martensitic structure with high ductility.

In the third stage of tempering, the hardness of plain carbon steels progressively decreases with tempering temperature. In structures transformed from austenite during quenching at elevated temperatures

to pearlite and bainite, there is relatively little change in hardness until the tempering temperature approaches the temperature at which the carbide was formed. Thus, the unhardened portion of the Jominy specimen shown in Fig. 8.5 was not significantly softened until a temperature over 800°F. (425°C.) was reached. Engel⁴⁷ showed that at high tempering temperatures the rate of softening is virtually the same for martensite, bainite, and pearlite (Fig. 8.6).

8.3. General Effects of Alloying Elements on Tempered Hardness

Except for increasing the tendency of the structure to contain some retained austenite, all of the alloying elements but silicon seem to have

TABLE 8.1. Typical Tensile Properties of SAE Carbon and Low-Alloy Steels Quenched in Oil and Tempered at 1000°F. (540°C.)*

Steel No.	Nominal composition, per cent					Tensile strength, lb. per sq. in.	Yield strength, lb. per sq. in.	Elongation in 2 in., per cent	Reduction of area, per cent
	C	Mn	Ni	Cr	Mo				
1045	0.45	0.75				110,000	78,000	20	50
1340	0.40	1.75				141,000	120,000	18	52
3140	0.40	0.75	1.25	0.60		143,000	119,000	17	57
4140	0.40	0.75		1.00	0.20	170,000	147,000	16	56
4340	0.40	0.65	1.75	0.65	0.35	184,000	160,000	15	52

*Sisco.¹³² Properties determined on 0.505-in. specimens from bars about 1 in. in diameter as quenched.

TABLE 8.2. Typical Tensile Properties of SAE Carbon and Low-Alloy Steels Treated to a Tensile Strength of 150,000 lb. per sq. in.*

Steel No.	Nominal composition, per cent					Tempering temperature		Yield strength, lb. per sq. in.	Elongation in 2 in., per cent	Reduction of area, per cent
	C	Mn	Ni	Cr	Mo	°F.	°C.			
1045	0.45	0.75				600	315	114,000	10	35
1060	0.60	0.75				750	400	113,000	15	45
1340	0.40	1.75				950	510	128,000	16	50
3130	0.30	0.65	1.25	0.60		850	455	128,000	17	57
3140	0.40	0.75	1.25	0.60		950	510	127,000	17	56
4130	0.30	0.65		0.65	0.20	1050	565	131,000	20	61
4140	0.40	0.75		1.00	0.20	1100	595	131,000	18	60
4340	0.40	0.65	1.75	0.65	0.35	1200	650	130,000	19	57
8640	0.40	0.90	0.50	0.50	0.20	1050	565	133,000	17	53
8740	0.40	0.90	0.50	0.50	0.25	1100	595	130,000	18	56

*Sisco.¹³² Properties determined on 0.505-in. specimens from bars about 1 in. in diameter as quenched.

little influence on hardness in the first two stages of tempering. This is indicated by work reported by Fletcher and Cohen⁵⁰ and by Crafts and Lamont.³⁸ However, at tempering temperatures in the range above 800°F. (425°C.) the carbide-forming elements manganese, chromium, molybdenum, and vanadium are known to produce materially

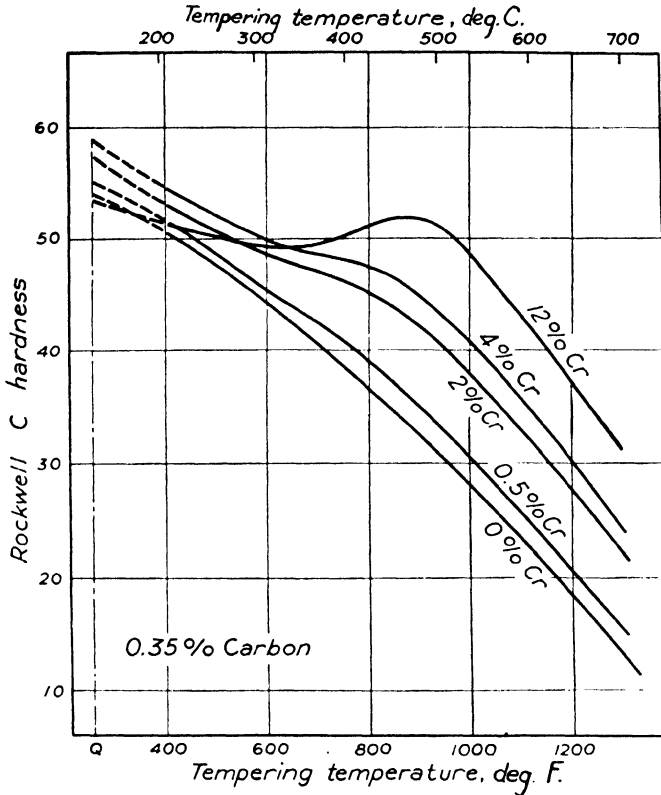

FIG. 8.7. Effect of chromium on the resistance of 0.35 per cent carbon steel to tempering. (Bain.)¹⁹

higher hardness and strength for the same treatment than those attained in essentially alloy-free steel. This is clearly indicated by mechanical-property data summarized by Sisco,¹³² which are reproduced in part in Table 8.1. Similarly, the carbide-forming elements, in inhibiting the softening due to tempering, make it possible to temper at a considerably higher temperature than that used for unalloyed carbon steels if a definite hardness and strength are desired. This is shown by Table 8.2.

The retarding effect of the carbide-forming elements on tempering,

when present in relatively large amounts, is shown qualitatively in Figs. 8.7 and 8.8 from Bain.¹⁹ For a tempering temperature of 1000°F. (540°C.) increasing the chromium from 0 to 2 per cent increases the Rockwell C hardness about 10 numbers; approximately 0.5 per cent molybdenum has nearly the same effect.

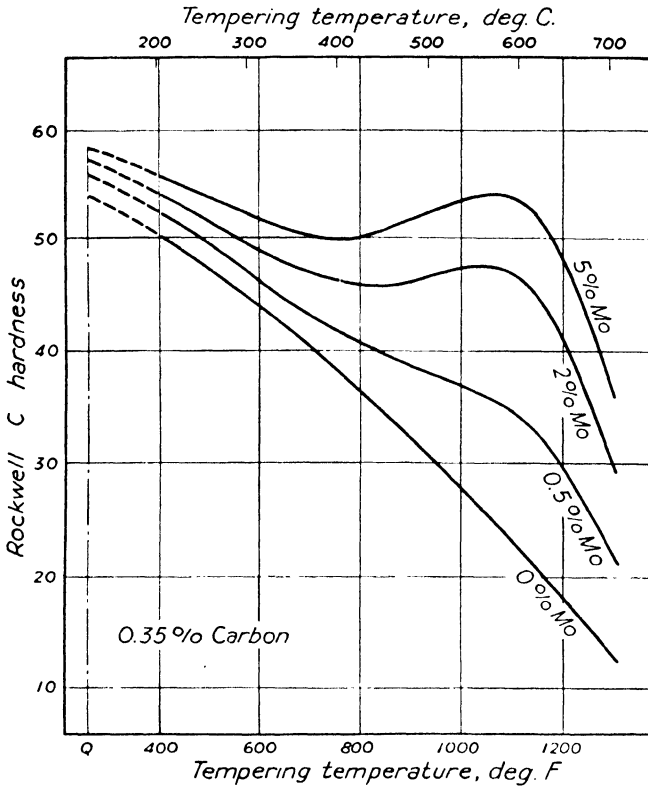

FIG. 8.8. Effect of molybdenum on the resistance of 0.35 per cent carbon steel to tempering. (Bain.)¹⁹

8.4. Effect of Alloying Elements on Tempered Hardness in Low-Alloy Steels

The effect of the alloying elements on the tempered hardness of engineering-type steels has been determined by Crafts and Lamont.³⁸ It was assumed that tempered Rockwell C hardness is dependent upon the quenched hardness, composition, the tempering temperature, and the time at the tempering temperature. The method was based on hardness surveys made on end-quenched Jominy specimens of simple

and complex alloy steels before and after tempering for 2 hr. at temperatures between 400 and 1200°F. (205 and 650°C.). Calculated hardness values were correlated with values obtained on quenched and tempered carbon- and alloy-steel bars between about $\frac{1}{2}$ and 4 in. in diameter and gave an accuracy of ± 5 Rockwell C.

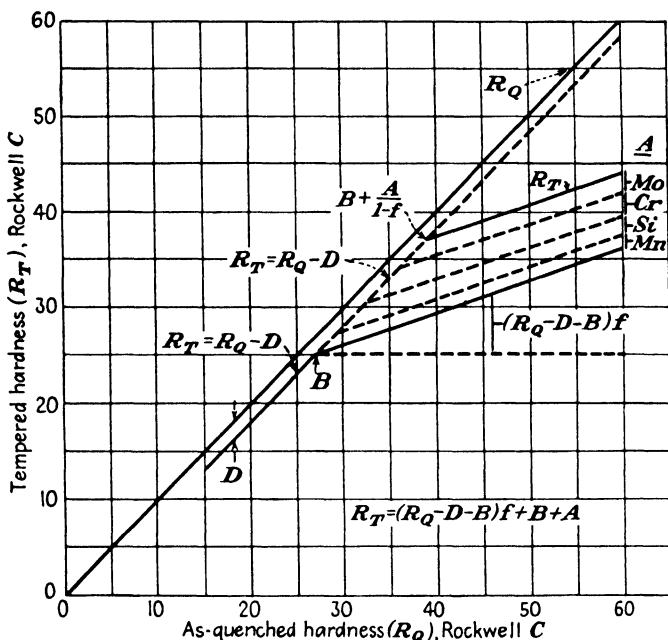

FIG. 8.9. Schematic diagram for tempered-hardness calculation. (*Crafts and Lamont.*)³⁸

The general pattern of the calculation, which is described more fully in the next section, is shown in Fig. 8.9, in which the as-quenched hardness is plotted against the hardness after tempering at a given tempering temperature. The as-quenched hardness (R_Q) may be taken as a point on the 45-deg. line. After tempering, the hardness (R_T) is lowered by a certain amount D , which is independent of the degree of initial hardening, plus an additional amount in steels with a high as-quenched hardness. The disproportionate loss in hardened steel is less in the presence of alloying elements so that these may be considered to add hardness increments to the hardness that might be obtained in an alloy-free base composition. The percentages of alloying elements that are effective in retarding softening by 1 Rockwell C unit are shown in Table 8.3.

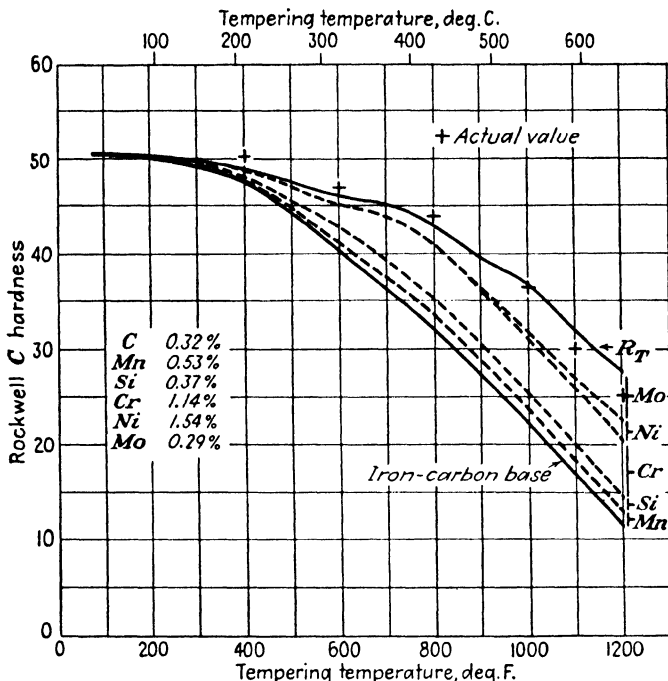

FIG. 8.10. Hardness/tempering-temperature curve indicating schematically the effect of alloys on retardation of softening. (Crafts and Lamont.)³⁸

It will be noted that, except for nickel, the effect of an alloying element in resisting softening becomes greater as the temperature is raised until a maximum effect is reached at a temperature that is characteristic of the element. The characteristic temperatures above which alloys exert a constant maximum retardation of softening during tempering

TABLE 8.3. Percentage of Alloying Element Required to Retard Softening by 1 Rockwell C Unit at Various Tempering Temperatures

Element	Tempering temperature					
	400°F. (205°C.)	600°F. (315°C.)	800°F. (425°C.)	1000°F. (540°C.)	1100°F. (595°C.)	1200°F. (650°C.)
Manganese.....	1.33	0.65	0.40	0.40	0.40	0.40
Silicon*.....		0.22	0.22	0.22	0.22	0.22
Chromium*....	1.33	0.45	0.19	0.19	0.19	0.19
Nickel.....				3.33	1.67	0.77
Molybdenum*.		0.32	0.13	0.06	0.06	0.06

*Up to 1 per cent silicon, 1.5 per cent chromium, or 0.5 per cent molybdenum.

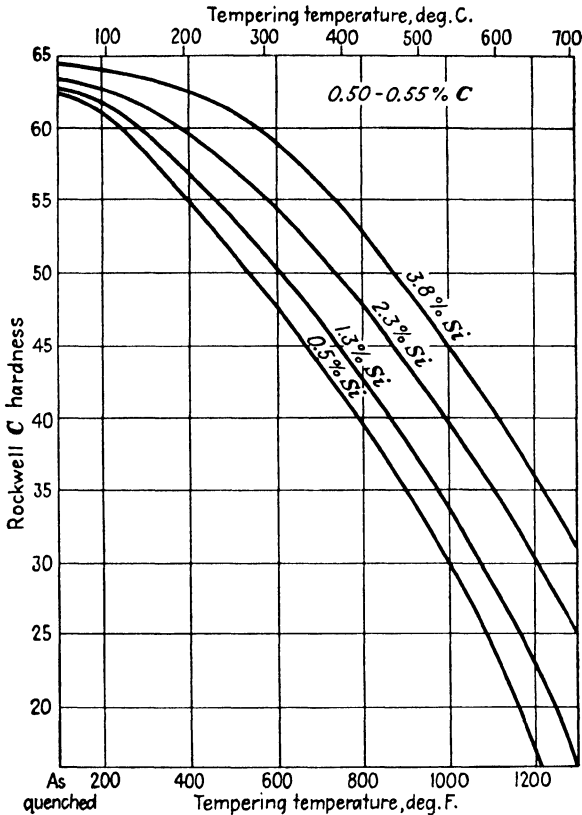

FIG. 8.11. Resistance to softening during tempering for 1 hr. conferred by silicon on 0.50 to 0.55 per cent carbon steels. (Bain.)¹⁹

are as follows: silicon, 600°F. (315°C.); manganese and chromium, 800°F. (425°C.); molybdenum, 1000°F. (540°C.); and vanadium, 1100°F. (595°C.). Above these temperatures, as shown in Fig. 8.10, the hardness of an alloy steel decreases with increase of temperature at the same rate as in carbon steel but at a higher level of hardness.

It is evident that the carbide formers chromium, molybdenum, and vanadium are desirable for maintaining strength with high tempering temperatures. On the other hand, silicon becomes effective at low temperatures, as illustrated in Fig. 8.11. High-carbon gear steel with somewhat less than 1 per cent silicon, when hardened and tempered at 400 to 500°F. (205 to 260°C.), may have 30,000 lb. per sq. in. higher strength than similar steel with the usual silicon content. Nickel has little effect until the tempering temperature is over 1000°F. (540°C.).

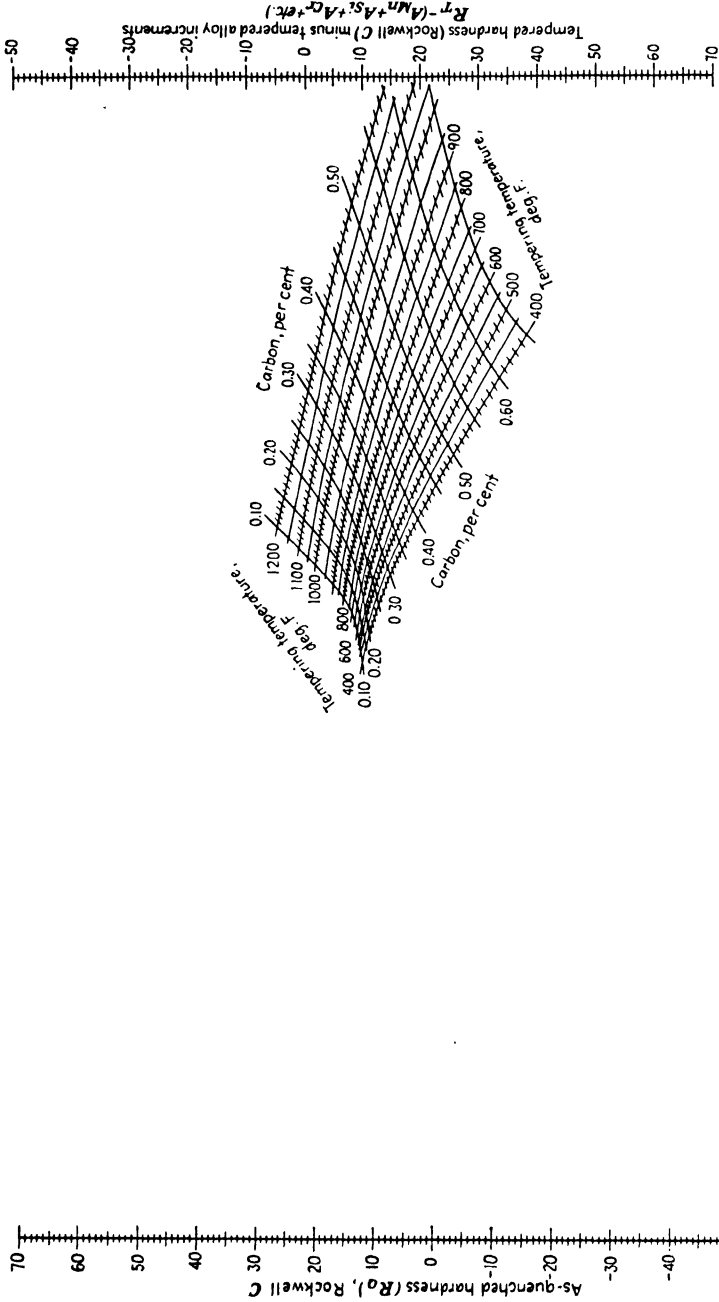

Fig. 8.12. Nomograph for determining Jominy hardness after tempering for 2 hr. (Crafts and Lamont.)³⁸

8.5. Calculation of Tempered Hardness by Addition Method

In the addition method³⁸ for estimating tempered Rockwell C hardness after a tempering time of 2 hr., use is made of the following formula:

$$R_T = (R_Q - D - B)f + B + A$$

where R_T = tempered hardness,

R_Q = as-quenched hardness,

D = tempering decrement shown in Fig. 8.18,

B = critical hardness for carbon content and tempering temperature shown in Fig. 8.19,

f = tempering factor for carbon content and tempering temperature shown in Fig. 8.20,

A = sum of individual alloy increments shown in Figs. 8.13 to 8.17.

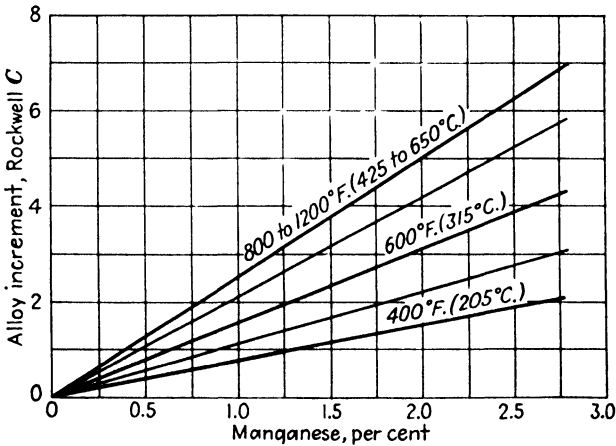

FIG. 8.13. Effect of manganese on resistance to softening at various tempering temperatures. (Crafts and Lamont.)³⁸

In order to avoid calculation, a nomographic chart (Fig. 8.12) is used to estimate tempered hardness. Use of the chart for a given steel requires that the as-quenched hardness, carbon content, and the total increment by which the alloys retard softening at a specific tempering temperature are known. The alloy increments are estimated from Figs. 8.13 to 8.17. Suppose, for example, it is desired to know the tempered hardness of 8645 steel over a range of temperatures between 400 and 1200°F. (205 and 650°C.); the alloy increments are estimated for each tempering temperature and totaled as in Table 8.4.

To use the nomographic chart, a straight edge is placed between

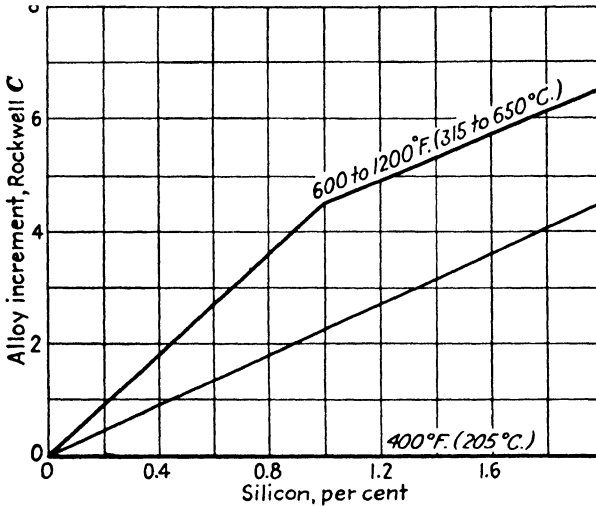

FIG. 8.14. Effect of silicon on resistance to softening at various tempering temperatures. (Crafts and Lamont.)²⁸

the as-quenched hardness, indicated at the left in Fig. 8.12, and the point of intersection of the carbon-content and the tempering-temperature lines in the central grille. The hardness of the "pure" iron-carbon alloy at the right is noted and to this is added the total alloy increment previously determined. Assume, for example, that a fully hardened 1-in. diameter bar of 8645 steel has an as-quenched hardness of 57.6 Rockwell C and it is desired to know the hardness after tempering at 1000°F. (540°C.). A straight edge is placed between 57.6 Rockwell C on the ordinate at the left and the point of intersection of the line for 1000°F. and the cross line for 0.45 per cent carbon. The hardness of

TABLE 8.4. Alloy Increments for Various Tempering Temperatures for 8645 Steel

Element	Per-centage	Refer to Fig.	Alloy increments for a tempering temperature of					
			400°F. (205°C.)	600°F. (315°C.)	800°F. (425°C.)	1000°F. (540°C.)	1100°F. (595°C.)	1200°F. (650°C.)
C	0.45							
Mn	0.85	8.13	0.6	1.3	2.1	2.1	2.1	2.1
Si	0.22	8.14	0.0	1.0	1.0	1.0	1.0	1.0
Ni	0.50	8.15	0.0	0.0	0.0	0.2	0.3	0.7
Cr	0.50	8.16	0.4	1.1	2.6	2.6	2.6	2.6
Mo	0.20	8.17	0.0	0.6	1.4	3.6	3.6	3.6
Total alloy increment			1.0	4.0	7.1	9.5	9.6	10.0

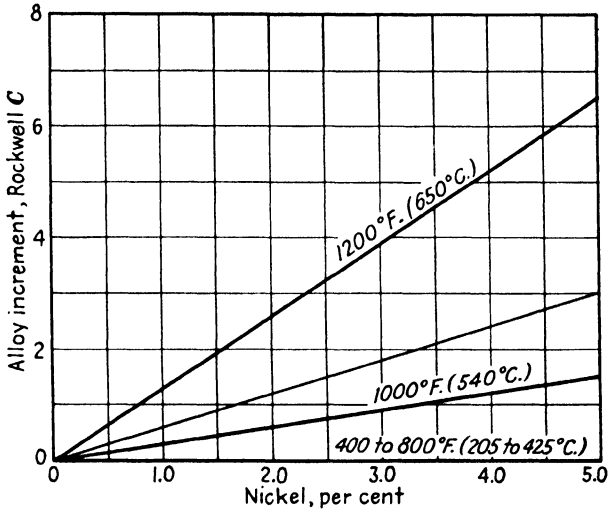

FIG. 8.15. Effect of nickel on resistance to softening at various tempering temperatures. (Crafts and Lamont.)³⁸

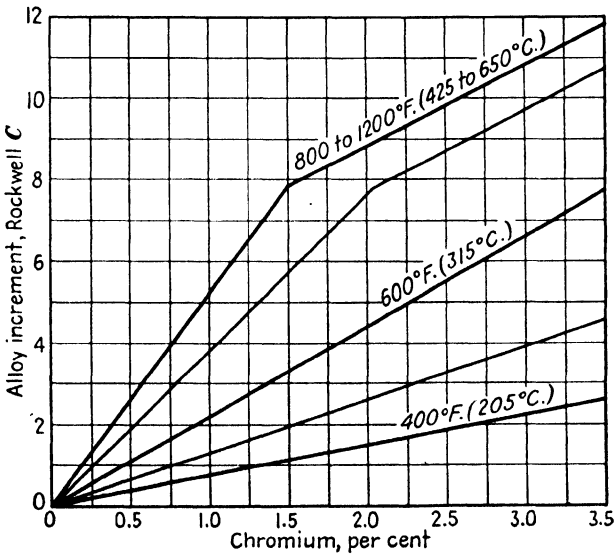

FIG. 8.16. Effect of chromium on resistance to softening at various tempering temperatures. (Crafts and Lamont.)³⁸

the “pure” iron-carbon alloy after tempering at 1000°F. is then 24.1 Rockwell C as read on the right. The tempered hardness of the steel is obtained by adding the alloy increment for 1000°F., i.e., 9.5 Rockwell C according to Table 8.4, to 24.1 Rockwell C for the “pure” iron-carbon alloy, so that the tempered hardness is estimated to be 33.6 Rockwell C.

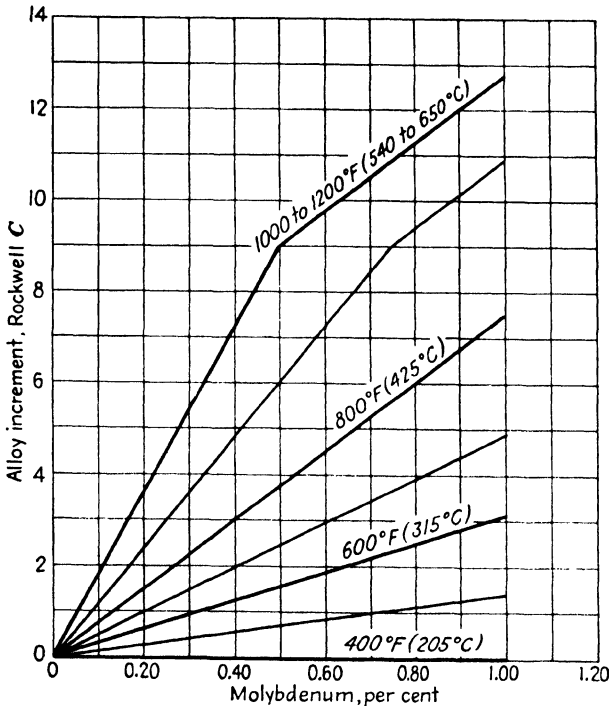

FIG. 8.17. Effect of molybdenum on resistance to softening at various tempering temperatures. (Crafts and Lamont.)³⁸

TABLE 8.5. Calculated Tempered Hardness for 8645 Steel for Tempering Temperatures of 400 to 1200°F. (205 to 650°C.) Based on Nomograph, Fig. 8.12

Steps of calculation	Hardness for a tempering temperature of					
	400°F. (205°C.)	600°F. (315°C.)	800°F. (425°C.)	1000°F. (540°C.)	1100°F. (595°C.)	1200°F. (650°C.)
Hardness of iron-carbon base	54.0	44.4	35.0	24.1	19.0	13.4
(Plus) sum of alloy increments	1.0	4.0	7.1	9.5	9.6	10.0
Tempered hardness of the steel, Rockwell C.....	55.0	48.4	42.1	33.6	28.6	23.4

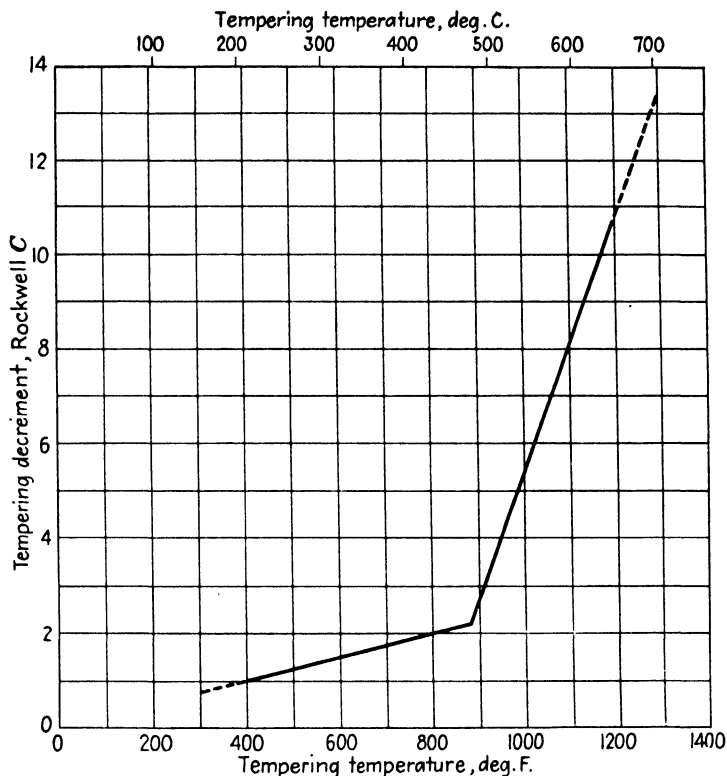

Fig. 8.18. Hardness decrement (D) caused by tempering for "unhardened" steel. (Crafts and Lamont.)³⁸

In a similar manner the tempered hardness of the 8645 steel may be estimated for other tempering temperatures; the values are given in Table 8.5. Interpolation of the tempered-hardness values for temperatures between 400 and 1200°F. (205 and 650°C.) indicates that this steel will have to be tempered at 1020°F. (550°C.) for 2 hr. in order to have a tempered hardness of 33 Rockwell C and, according to the conversion chart shown in Fig. 9.1, a tensile strength of 150,000 lb. per sq. in. The calculation is accurate within ± 5 Rockwell C or 15,000 lb. per sq. in. tensile strength.

The tempered hardness may also be calculated by substituting in the formula the quenched Rockwell C hardness and the values for the other expressions for the tempering temperature under consideration. The values for the tempering decrement D , the critical hardness B , and the disproportionate softening factor f are determined from Figs. 8.18 to 8.20, respectively. For the 8645 steel these factors

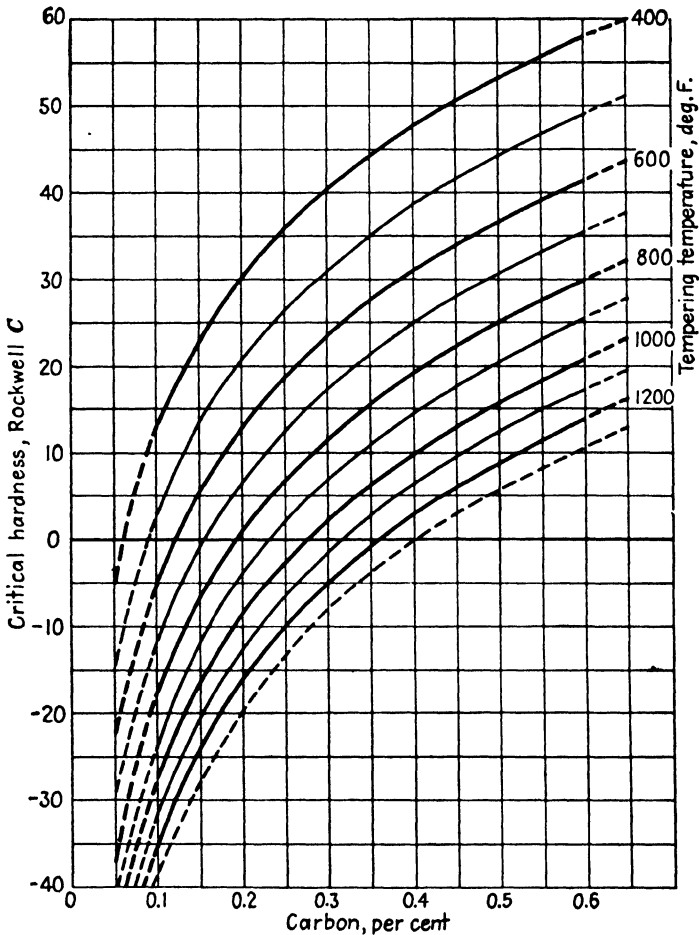

FIG. 8.19. Critical hardness (B) for alloy-free steel as affected by carbon content and tempering temperature. (Crafts and Lamont.)²⁸

have the values given in Table 8.6. These values together with the alloy increments shown in Table 8.4 are then substituted in the formula $R_T = (R_Q - D - B)f + B + A$ so that:

$$\begin{aligned}
 R_T(400^\circ\text{F.}) &= (57.6 - 1.0 - 50.6)0.57 + 50.6 + 1.0 = 55.0 \\
 R_T(600^\circ\text{F.}) &= (57.6 - 1.5 - 34.0)0.47 + 34.0 + 4.0 = 48.4 \\
 R_T(800^\circ\text{F.}) &= (57.6 - 2.0 - 22.3)0.38 + 22.3 + 7.1 = 42.1 \\
 R_T(1000^\circ\text{F.}) &= (57.6 - 5.3 - 13.1)0.28 + 13.1 + 9.5 = 33.6 \\
 R_T(1100^\circ\text{F.}) &= (57.6 - 8.0 - 9.8)0.23 + 9.8 + 9.6 = 28.6 \\
 R_T(1200^\circ\text{F.}) &= (57.6 - 10.7 - 6.1)0.18 + 6.1 + 10.0 = 23.4
 \end{aligned}$$

TABLE 8.6. Values for Calculating Tempered Hardness for 8645 Steel for Tempering Temperatures of 400 to 1200°F. (205 to 650°C.)

Calculation factors	Refer to Fig.	Hardness for a tempering temperature of					
		400°F. (205°C.)	600°F. (315°C.)	800°F. (425°C.)	1000°F. (540°C.)	1100°F. (595°C.)	1200°F. (650°C.)
As-quenched hardness, R_q	—	57.6	57.6	57.6	57.6	57.6	57.6
Tempering decrement, D	8.18	1.0	1.5	2.0	5.3	8.0	10.7
Critical hardness, B	8.19	50.6	34.0	22.3	13.1	9.8	6.1
Tempering factor, f	8.20	0.57	0.47	0.38	0.28	0.23	0.18

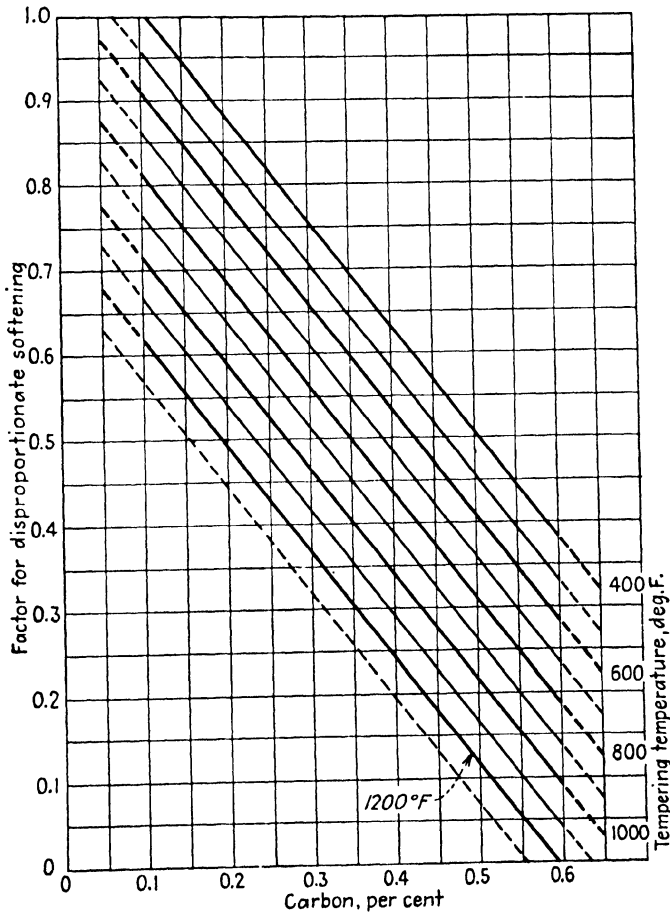

FIG. 8.20. Factor (f) for disproportionate softening in "hardened" steel as affected by carbon content and tempering temperature. (Crafts and Lamont.)³⁸

If the calculated value of R_T is greater than $R_Q - D$, then $R_Q - D$ is the tempered hardness. However, as this is not the case for 8645 steel, the calculated R_T values are the estimated Rockwell C hardness values after tempering at the indicated temperatures.

TABLE 8.7. Approximate Hardness Increments for 0.15 Per Cent Vanadium in Steels of Indicated Carbon Content When Tempered at Temperatures Shown

Carbon, per cent	1000°F. (540°C.)			1100°F. (595°C.)			1200°F. (650°C.)		
	Un- hard- ened	Par- tially hard- ened	Fully hard- ened	Un- hard- ened	Par- tially hard- ened	Fully hard- ened	Un- hard- ened	Par- tially hard- ened	Fully hard- ened
0.20	4.5	7.0	6.0	7.1	12.0	8.5	8.2	15.0	7.0
0.30	4.5	4.0	5.0	7.1	8.0	7.5	8.2	11.0	6.5
0.40	4.5	2.0	5.0	7.1	7.5	7.5	8.2	8.0	6.5
0.50	4.5	1.0	5.0	7.1	7.0	7.5	8.2	8.0	5.0

In steels containing vanadium, the basic factors for calculating tempered hardness seem to be different from those shown for aluminum-treated steel. In addition, the calculation is complicated by the fact that the effectiveness of vanadium in retarding softening during tempering varies with the carbon content of the steel. The effect of vanadium on tempered hardness can be estimated; the approximate increments by which 0.15 per cent vanadium increases the hardness of tempered steels are shown in Table 8.7. At tempering temperatures below about 1000°F. (540°C.), the hardness of vanadium steels approaches that of aluminum-treated steels so that increments are not given for tempering temperatures below 1000°F. The tempered hardness of a steel containing 0.15 per cent vanadium, therefore, may be estimated by the method outlined in the previous paragraphs and by adding to this the increment of hardness conferred by vanadium shown in Table 8.7. For instance, in the example shown in the previous paragraph the hardness after tempering at 1100°F. of the fully hardened 8645 steel is 28.6 Rockwell C. From Table 8.7 it may be estimated that 0.15 per cent vanadium would increase this by 7.5 Rockwell C. The hardness of this 8645 steel containing 0.15 per cent vanadium, after tempering at 1100°F. for 2 hr., therefore would be equal to $28.6 + 7.5 = 36.1$ Rockwell C.

8.6. Estimation of Tempered Hardness from Ideal Critical Diameter

The tempered Rockwell C hardness to be expected after quenching and tempering for 1 hr. at between 900 and 1200°F. (480 and 650°C.)

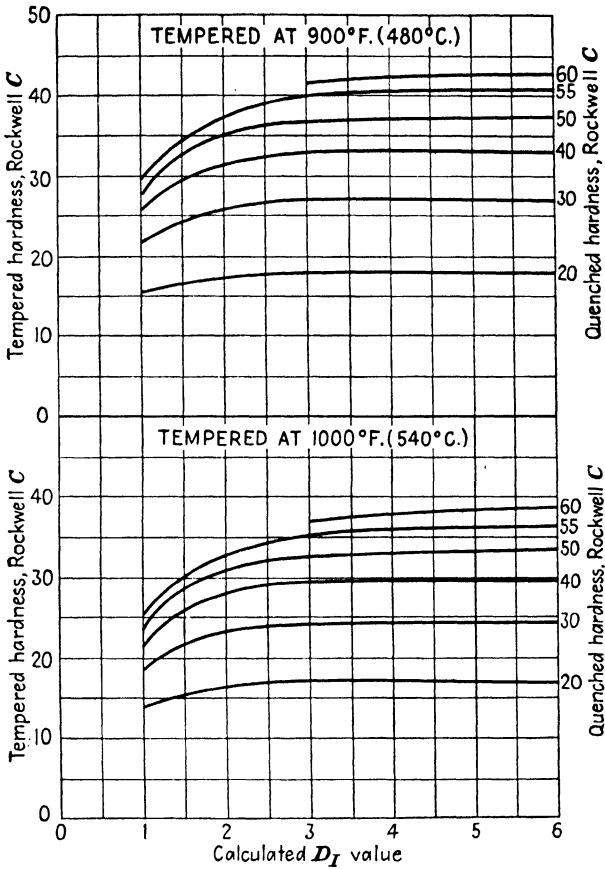

FIG. 8.21. Hardness after tempering at 900 and 1000°F. (480 and 540°C.) as affected by ideal critical size and as-quenched hardness. (Wellauer.)¹³⁸

may be estimated from the quenched hardness and the ideal critical diameter by the method developed by Wellauer¹³⁸ and illustrated in Figs. 8.21 to 8.23. Assume that it is desirable to know what tempering temperature will give a tensile strength of 175,000 lb. per sq. in. or a hardness of 38 Rockwell C at the center of a quenched 0.72-in. diameter bar to the 8640 steel described in Section 5.9, which, according to Section 7.2, has a hardness as quenched of 55 Rockwell C. Since the calculated ideal critical diameter of 3.68 in. (see p. 103) is greater than 3.0 in., reference is made to Fig. 8.23, in which tempered hardness is plotted against tempering temperature for different levels of quenched hardness for steels having ideal critical diameters in excess

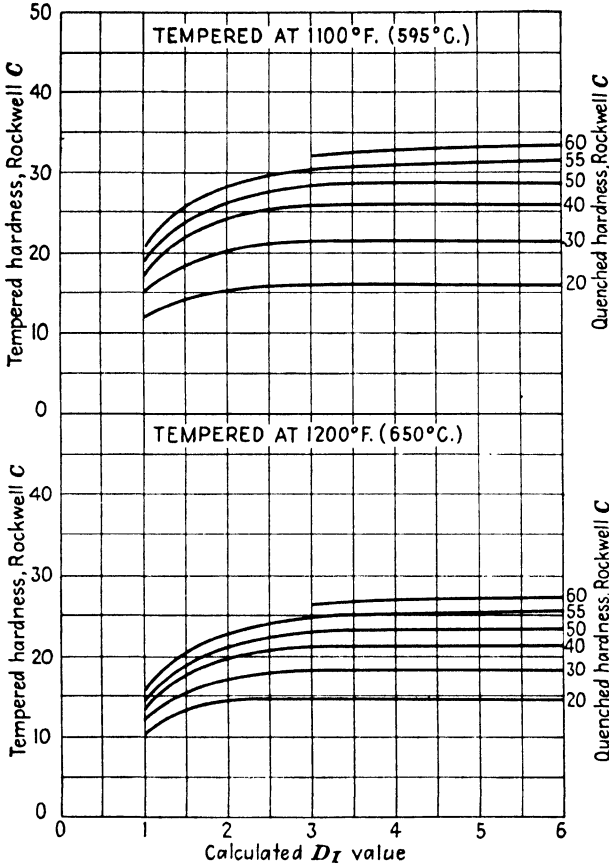

FIG. 8.22. Hardness after tempering at 1100 and 1200°F. (595 and 650°C.) as affected by ideal critical size and as-quenched hardness. (Wellauer.)¹³⁸

of 3.0 in. Since the desired hardness is 38 Rockwell C, an imaginary line is drawn horizontally to the point of intersection with a line representing the quenched hardness of 55 Rockwell C. An imaginary vertical line is then drawn through the point of intersection, and the tempering temperature required to give the desired hardness after tempering 1 hr. is determined on the abscissa. In this case a tempering temperature of 965°F. (520°C.) should give the required hardness of 38 Rockwell C. By reversing this manipulation, the hardness that results from tempering at various tempering temperatures at different levels of quenched hardness may be estimated. For calculated ideal critical diameters of less than 3.0 in. similar estimations may be made by interpolation in

Figs. 8.21 and 8.22. The error amounts to about ± 5 Rockwell C except for steels with high silicon, vanadium, or molybdenum contents where larger errors may be found. Tensile strength, yield strength, ductility, and impact strength may be estimated from charts for the estimated tempered hardness as described in the next chapter.

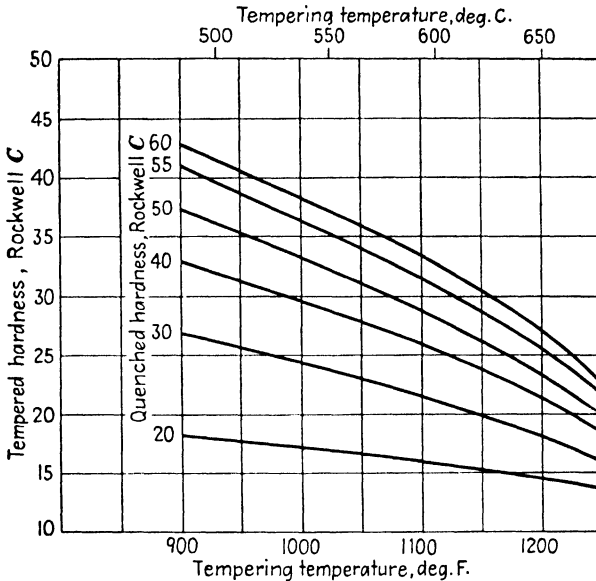

FIG. 8.23. Relation between tempering temperature, tempered hardness, and quenched hardness for steels having ideal critical diameters greater than 3.0 in. (Wellauer.)¹³⁸

8.7. Explanations of the Effect of Alloying Elements on Retardation of Softening by Tempering

The mechanism by which alloying elements retard softening during the tempering of quenched steels has not been explained satisfactorily. As shown by Crafts and Lamont³⁸ and illustrated in Fig. 8.24, the alloying elements tend to become concentrated in the carbides during tempering at high temperatures. In steels with large amounts of carbide-forming elements, this results in a change of phase from cementite (Fe_3C) to an alloy carbide.

It has been thoroughly demonstrated that changes in carbides occur during tempering. Austin,¹⁵ for example, after surveying the whole field of carbide formation and the relation of the carbides to the matrix, showed conclusively that increasing the tempering temperature and in some cases the tempering time usually increases the percentage of

alloying element in the carbide. In the case of manganese, the cementite in a low-carbon alloy with 2 per cent manganese contained 4.6 per cent manganese after tempering 10 hr. at 750°F. (400°C.) and 17 per cent after tempering 50 hr. at 1255°F. (680°C.).

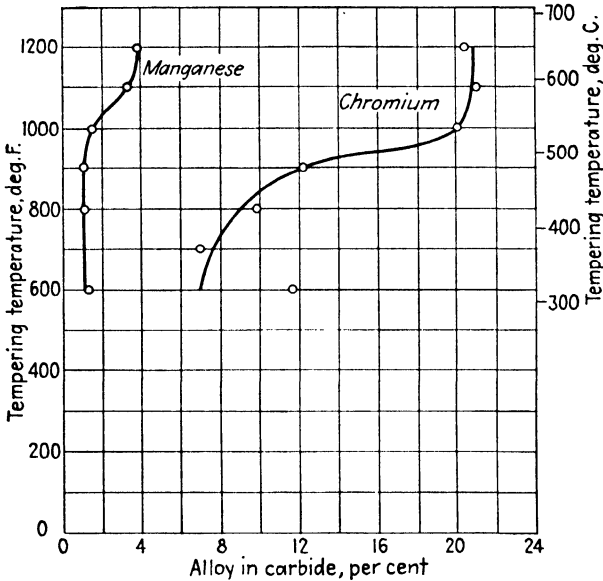

FIG. 8.24. Alloy content of electrolytically extracted iron-manganese and iron-chromium carbides. (Crafts and Lamont.)³⁸

Analogous data from the literature and previously unpublished data were cited by Austin for chromium, molybdenum, and tungsten. For example, an alloy containing 0.5 per cent carbon and 5 per cent tungsten was quenched after a homogenizing treatment at 2100°F. (1150°C.), and the carbides were extracted after various tempering treatments. When the alloy was tempered at 1290°F. (700°C.) the amount of WC in the carbides increased from 10 per cent for a time of 5 hr. to about 80 per cent for a time of 140 hr. The amount of $(\text{FeW})_{23}\text{C}_6$ decreased from 80 to less than 10 per cent during the same treatment. That these changes in alloy carbides during tempering have an effect on the hardness changes seems unquestioned, but the underlying mechanism is by no means clear.

Bain and Jeffries,¹⁶ in 1923, and later Houdremont, Bennek, and Schrader³¹ suggested that iron carbide particles formed after martensite decomposition tend to grow with corresponding softening of the steel, but that on tempering at approximately 1100°F. (595°C.) the alloy

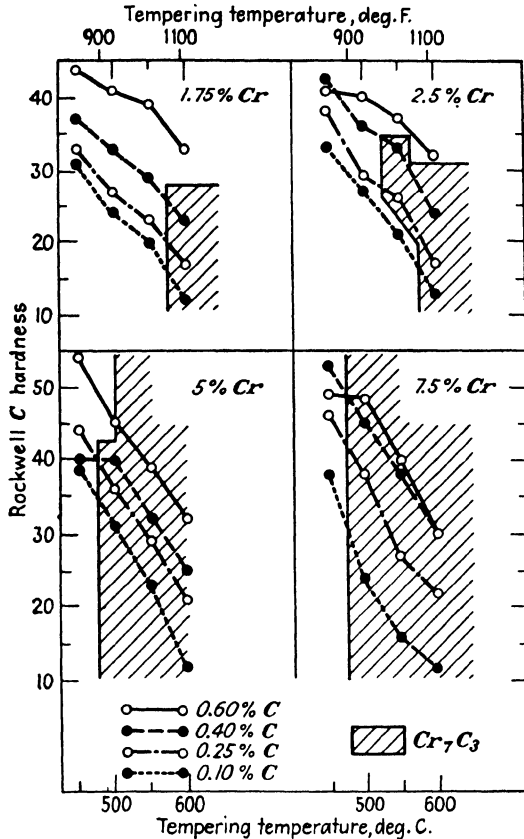

FIG. 8.25. Hardness of chromium steels quenched and tempered 64 hours. (Crafts and Offenbauer.)³⁴

carbide in high-alloy steel becomes more stable than iron carbide. The carbon tends to diffuse to nuclei of alloy carbide, and the freshly formed alloy carbide particles of very small size are responsible for the secondary hardening frequently observed in tempering high-alloy steels (see Figs. 8.7 and 8.8). This theory would explain positive rehardening but suggests a conflict with the observations outlined in previous sections that alloying elements only retard softening in the low-alloy constructional steels. However, quantitative considerations indicate that the retarded softening of low-alloy steel may reflect the same mechanism as positive rehardening in higher alloy steel, but that the amount of the tendency is insufficient to produce more than a retardation of softening. There is also a discrepancy in the temperature of the carbide

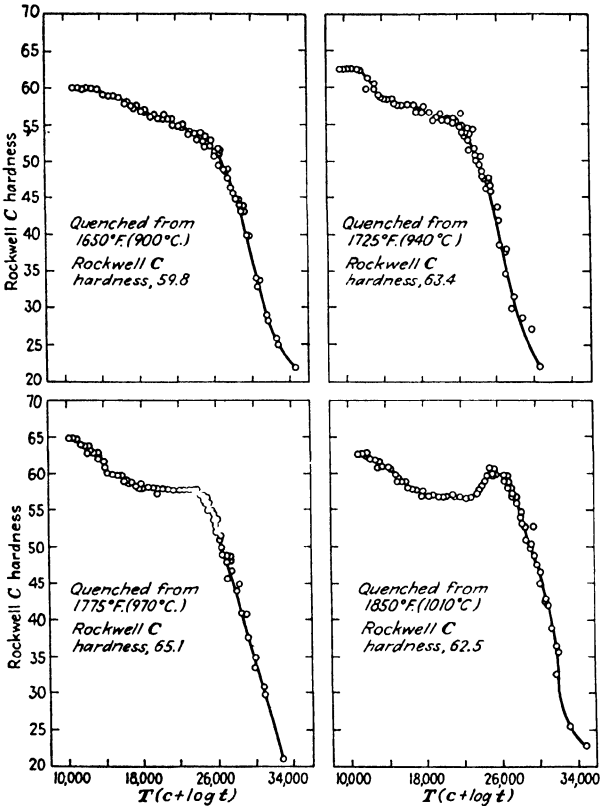

FIG. 8.26. Tempering diagrams for a steel containing 1 per cent carbon, 5 per cent chromium and 1 per cent molybdenum showing considerable rehardening in samples quenched from 1850°F. (1010°C.) but not in those quenched from lower temperatures. In the expression $T(c + \log t)$, T = absolute temperature, t = time, and c = a constant for the steel. (Roberts, Grobe, and Moersch, Jr.)¹¹⁹

change illustrated in Fig. 8.24 and the temperature at which the hardening tendency becomes evident, and an absence of a discontinuity in hardness with change of the carbide phase as shown in Fig. 8.25. Thus, although the resistance to tempering conferred by carbide-forming elements appears to be associated with the entry of alloy into the carbide, the nature of the mechanism is still somewhat conjectural.

Positive rehardening, as exemplified by the 12 per cent chromium steel in Fig. 8.7, seems to be associated in part with residual austenite. This is illustrated in Fig. 8.26 for a steel containing 1 per cent carbon, 5 per cent chromium, and 1 per cent molybdenum. In this case, positive secondary hardening developed only when the quenching temperature

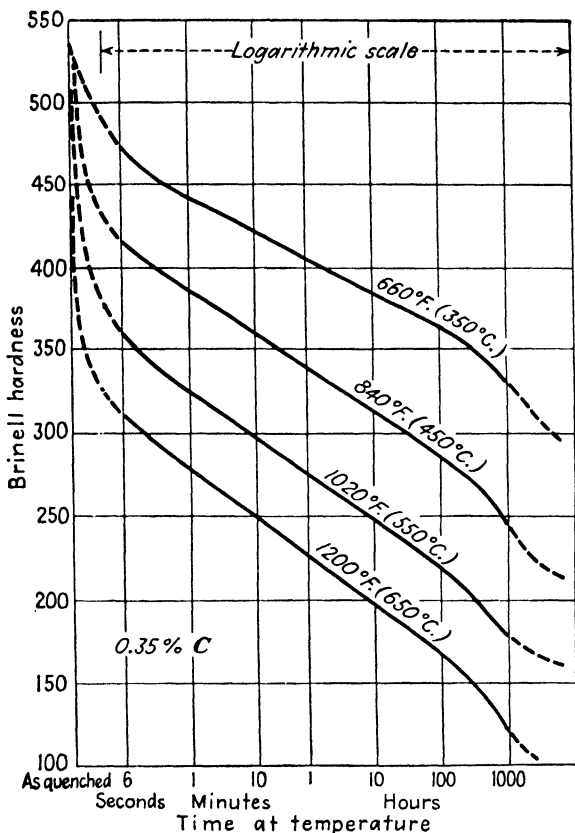

FIG. 8.27. Effect of time at tempering temperature upon the softening of quenched 0.35 per cent carbon steel. (Bain.)¹⁹

was high enough to lower the as-quenched hardness by retention of some austenite. Presumably, the residual austenite transforms during the tempering cycle, and the freshly formed martensite adds to the hardness. However, secondary hardening occurs in high-speed steel to a much greater degree than is readily explained by residual austenite, the secondary hardness reaching the approximate level of the quenched hardness. That an intermetallic compound precipitates in these steels and contributes to secondary hardness has also been considered a possible explanation.

8.8. Effect of Time on Tempered Hardness

The time that a steel is held at the tempering temperature has a major effect on the degree of softening and therefore on the final hardness of the

steel. This is illustrated in Figs. 8.27 and 8.6 (p. 153). Bain¹⁹ found that softening of martensite in quenched plain carbon steel had an approximately linear relation to the logarithm of time except for a relatively rapid decrease in the first few seconds and after 1600 hr. Hollomon and Jaffe⁷⁵ demonstrated that the effects of time and temperature are such that the softening of steels proceeds in a regular and predictable manner. They found that softening during tempering is a function of both time and temperature and that, if the progress of tempering is known for a given time, the progress for another time interval can be predicted quite accurately.

To illustrate, if the tempering times that are actually to be used are different from the 2-hr. period selected by Crafts and Lamont³⁸ for their experiments (see Section 8.5), the difference in time may be converted to temperature by the method worked out by Hollomon and Jaffe⁷⁵ and discussed in detail in the next section. The calculations may then be based on factors for the converted temperature that are equivalent to tempering for 2 hr. rather than on the actual tempering temperature for a longer or shorter time. The following formula for medium-carbon steels is used to convert the actual tempering time to the equivalent temperature for the 2-hr. period upon which the factors used by Crafts and Lamont are based:

$$T_2 = \frac{(T_1 + 459)(19.5 + \log t_1)}{19.801} - 459,$$

where T_1 = actual tempering temperature in °F.,*

t_1 = actual tempering time in hours,

T_2 = equivalent temperature for 2-hr. tempering period, in °F.,

$19.801 = 19.5 + \log 2$ hr.

As an example assume that a 4-hr. tempering period is to be used in tempering at 1000°F. (540°C.). By substituting in the formula

$$T_2 = \frac{(1000 + 459)(19.5 + 0.602)}{19.801} - 459,$$

$$T_2 = 1027^\circ\text{F.}$$

The various expressions involved in the formula for calculating tempered hardness must, therefore, be based on a temperature of 1027°F. (555°C.) instead of 1000°F.

According to Hollomon and Jaffe,⁷⁵ tempering time and tempering temperature are, therefore, interchangeable, for a given steel, according

*The formula for degrees centigrade would be:

$$T_2 = \frac{(T_1 + 273)(19.5 + \log t_1)}{19.801} - 273$$

to a simple relation; the effects of time and temperature may be combined in a single parameter so that, if the tempering-hardness gradient is established under one set of conditions, other equivalent tempering periods and temperatures may be calculated. The relation holds true for steels having strong secondary-hardening characteristics as well as for carbon steels that soften continuously with increase of tempering temperature. In the latter case it is possible to predict the progress of tempering from a single tempering treatment. The relation is also accurate regardless of whether the initial condition is martensitic, bainitic, or pearlitic.

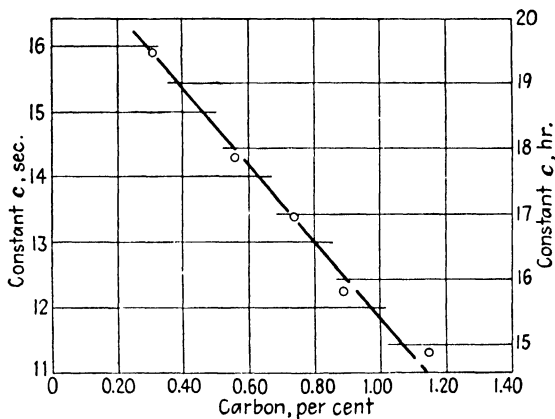

FIG. 8.28. Variation with carbon content of constant c in time/temperature parameter for tempering fully quenched plain carbon steels. (Hollomon and Jaffe.)⁷⁵

8.9. Method of Using the Time-Temperature Relation in Estimating Tempered Hardness

It was found by Hollomon and Jaffe⁷⁵ that the Rockwell C hardness of a given steel is a function of the parameter:

$$T(c + \log t),$$

where T = tempering temperature, in °K (tempering temperature in °F + 459),

t = time at the tempering temperature,

c = constant for the particular steel.

The constant c was found to vary with the carbon content of steel in the manner shown in Fig. 8.28.

If the tempering time and temperature required to obtain a certain hardness value are known, then, to determine a different time or tem-

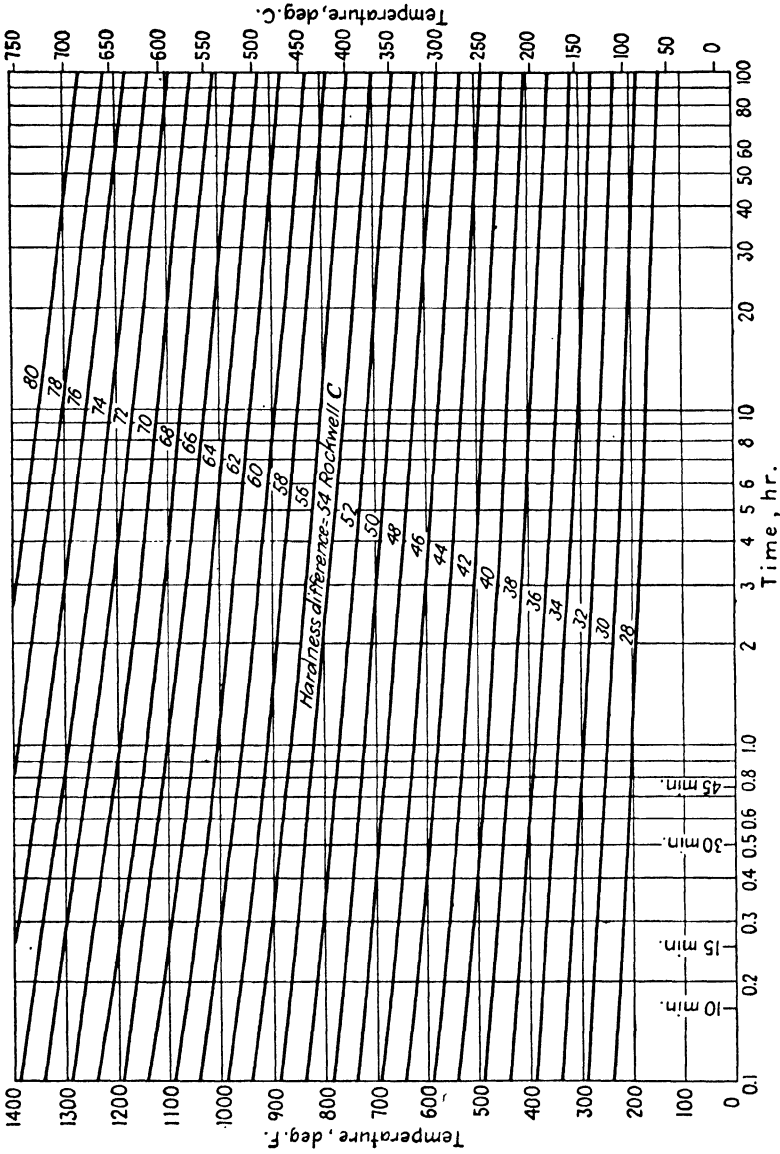

Fig. 8.29. Chart for finding time/temperature combinations giving equivalent tempering. (Primarily for 0.20 to 0.40 per cent carbon steels, $c = 19.5$ minus time in hours.) (Hollomon and Jaffe.)¹⁵

perature in order to obtain the same hardness, the following formula may be used:

$$(T_2+459)(c+\log t_2) = (T_1+459)(c+\log t_1),$$

where T_2 = unknown or assumed temperature in °F.,

t_2 = unknown or assumed time in hours,

T_1 = tempering temperature at which the given hardness was obtained, in °F.,

t_1 = time, in hours, of tempering treatment by which the given hardness was obtained.

To illustrate the manner in which the formula is manipulated (another example is given in the previous section) assume that it is known that a hardness of 45 Rockwell C was obtained in a 0.40 per cent carbon low-alloy steel after tempering at 1000°F. (540°C.) for 4 hr. In order to shorten the tempering treatment it is desired to know the time necessary to develop the same hardness after tempering at 1100°F. (595°C.). The value for c is obtained from Fig. 8.28 for 0.40 per cent carbon steel. In this case, $c = 18.9$ and is substituted in the formula together with the known tempering temperature and time and the new tempering temperature.

$$(1100+459)(18.9+\log t) = (1000+459)(18.9+\log 4),$$

then

$$\log t = \frac{(1000+459)(18.9+0.602)}{(1100+459)} - 18.9,$$

$$t = 0.20 \text{ hr. or } 12 \text{ min.}$$

The same hardness, i.e., 45 Rockwell C, will be developed in this steel after tempering 12 min. at 1100°F.

In order to simplify the estimation of the interchangeability of time and temperature, the equation has been plotted in Figs. 8.29 and 8.30 for $c = 19.5$ and $c = 15.0$, respectively (for time in hours). Because the value for c is not very critical, it is considered that the charts may be applied to steels that have no secondary-hardening characteristics, containing between 0.20 and 0.40 per cent carbon (Fig. 8.29) and between 0.90 and 1.20 per cent carbon (Fig. 8.30), respectively.

To use the charts, the point corresponding to the time and the temperature that are known to produce the desired hardness is located on the pertinent graph. A real or imaginary line is drawn through the point parallel to the neighboring curved lines of the chart. All combinations of time and temperature indicated by the values on this line should produce the desired hardness. If in the previous example the point for a temperature of 1000°F. (540°C.) and a time of 4 hr. is located

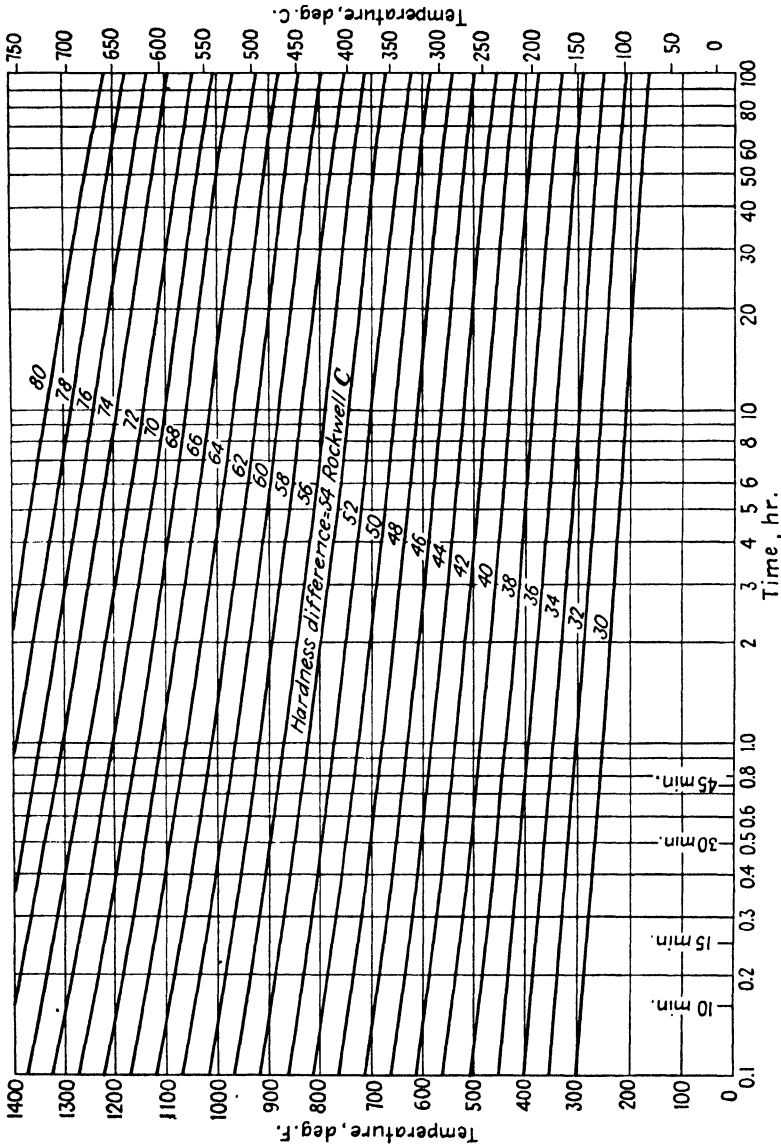

Fig. 8.30. Chart for finding time/temperature combinations giving equivalent tempering. (Primarily for 0.90 to 1.20 per cent carbon steels, $c = 15.0$ minus time in hours.) (Holomon and Jaffe.)¹⁸

on Fig. 8.29, it will be found that it falls just below the "hardness-difference" line marked 64. A line parallel to this hardness-difference line indicates that the same hardness will be obtained after tempering 2 hr. at a temperature of 1020°F. (550°C.), 1 hr. at 1040°F. (560°C.), or 0.2 hr. at 1100°F. (595°C.).

The hardness-difference lines shown in the charts are used to determine the hardness that may be developed after different tempering treatments if the hardness produced by another tempering treatment is known. Suppose that in an alloy steel containing 0.30 per cent carbon, which has practically no secondary-hardening characteristics, a hardness of 26 Rockwell C is produced after tempering at 1200°F. (650°C.) for 1 hr. and it is desired to know the hardness after tempering 2 hr. at 800°F. (425°C.). The hardness difference for 1 hr. and 1200°F. is found in Fig. 8.30 to be 70. To this value the hardness obtained after the tempering treatment is added to get the "characteristic hardness" of the steel; in this case, $70 + 26 = 96$. The hardness difference for the new treatment, that is, for the point 2 hr. and 800°F., according to Fig. 8.29, is approximately 54 and is subtracted from the characteristic hardness to give the Rockwell C hardness value. The hardness of this steel after tempering 2 hr. at 800°F. is, therefore, $96 - 54 = 42$ Rockwell C.

It should be emphasized that the relations shown in Figs. 8.29 and 8.30 may not apply to steels having secondary-hardening characteristics unless the range of tempering temperature under consideration is above the characteristic tempering temperature at which normal softening occurs during tempering. Hollomon and Jaffe's⁷⁵ formula has been utilized by several investigators under widely varying conditions and is considered to be quite accurate.

8.10. Summary

Tempering of hardened steel is carried out primarily to increase proportional limit ductility, and toughness rather than to lower the hardness. Secondary properties may, however, be estimated from hardness so that the chief practical measure of the effect of tempering is its effect on hardness. Hardness is lowered by increasing the temperature and time of tempering, and softening is resisted by the effect of alloying elements. Study of the effect of alloying elements in constructional steels has indicated that they retard softening. The rate of softening in low-alloy steels has been determined so that reasonably accurate predictions of the tempered hardness and tensile strength may be made.

The tempered hardness of fully quenched low-alloy engineering steels may be calculated by the method worked out by Crafts and Lamont.³⁸

The accuracy is about ± 5 Rockwell C, equivalent to 15,000 lb. per sq. in. tensile strength.

Another method has been proposed by Wellauer,¹³⁸ in which the individual effects of the alloying elements are disregarded and the effect of the alloying elements is assumed to be proportional to their effect on the ideal critical diameter in hardening. According to this method, tempered hardness depends on quenched hardness and ideal critical diameter; however, the diameter has only a negligible effect if it exceeds 3 in. Wellauer's method is most satisfactory when used for the triple-alloy steels for which it was developed but it may be seriously in error for other types of alloy steels, where variations of up to 10 Rockwell C may be encountered.

CHAPTER 9

MECHANICAL PROPERTIES AND HARDENABILITY

THERE ARE A NUMBER of mechanical properties of heat-treated steel, which reflect the behavior of the material when subjected to stress and indicate the resulting elastic or plastic strain, that are of great importance in the designing of parts subject to dynamic loads and are, therefore, vital to an economical and long-lasting structure or machine. These properties are mainly related to tensile strength and hardness and are affected by the degree of hardening (hardenability) in quenching. In general, the maximum yield strength (yield point), ductility, toughness, and fatigue strength for a given level of tensile strength and hardness result from quenching to a wholly martensitic structure followed by tempering to the desired tensile strength. The strength that is considered suitable is, on the other hand, governed by ductility and toughness as well as by yield- and fatigue-strength considerations, so that selection of a steel to meet a service requirement calls for the ability to predict the strength-dependent properties as well as the actual tensile strength and hardness. The strength-dependent properties are, therefore, of controlling importance in the estimation of minimum hardenability and maximum tensile strength for satisfactory service.

9.1. Tensile Strength

Tensile strength is the standard property to which other qualities such as yield strength, elongation, reduction of area, impact resistance,

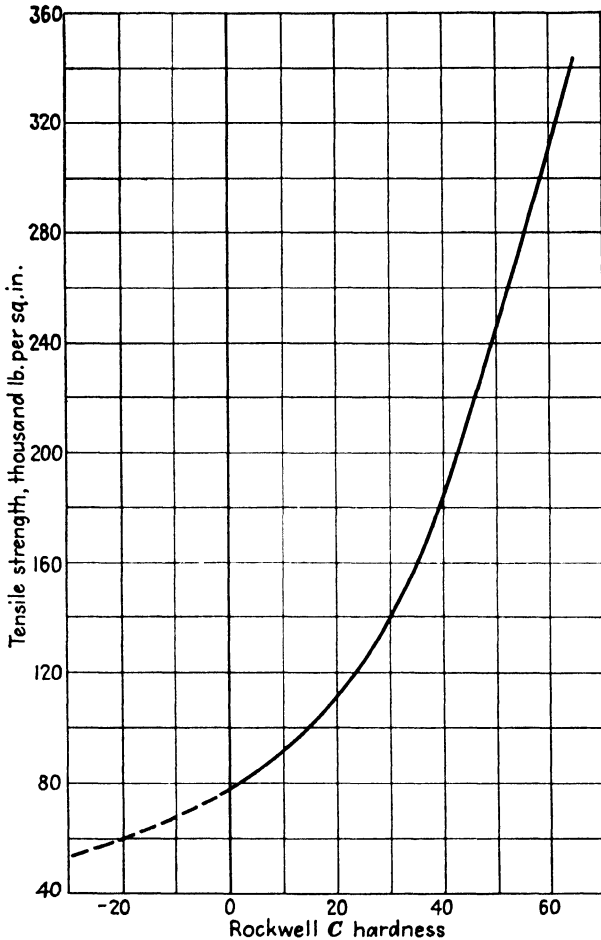

FIG. 9.1. Approximate relation between Rockwell C hardness and tensile strength of steels. (After *SAE Handbook*.)¹³⁴

and fatigue strength are related. Different heat treatments and correspondingly different microstructures affect these strength-dependent properties, but the major controlling factor is the amount of martensite formed in quenching. The strength-dependent properties, therefore, should be considered with respect to both strength and degree of hardening in quenching.

Tensile strength (and some of its related properties) is nearly always determined by breaking a standard bar under standard conditions in a machine specially designed for the purpose. Tensile strength may also

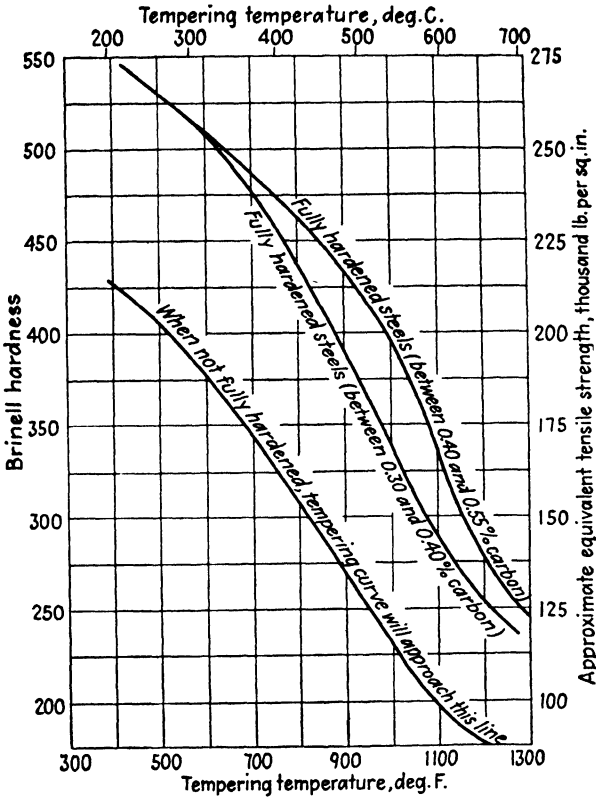

FIG. 9.2. Effect of tempering on the Brinell hardness and equivalent tensile strength of quenched steels. (SAE Handbook.)¹³⁴

be estimated, and with sufficient accuracy for most design purposes, from hardness. A recent conversion table is given in Appendix IV. A typical conversion chart for estimating tensile strength from Rockwell C hardness is shown graphically in Fig. 9.1. The Rockwell C hardness test has been utilized in hardenability investigations to a greater degree than any other test because of convenience and because it bears an approximate logarithmic relation to tensile strength. For all practical purposes hardness and tensile strength are considered to be equivalent properties.

In engineering low-alloy steels of the type mainly under consideration in this book the maximum hardness or tensile strength depends on the carbon content, as shown in Figs. 5.3 and 5.4 (p. 88). Tempering lowers the strength of steels of this type. Since tempering has been found by experience to be advantageous to serviceability, it is obvious

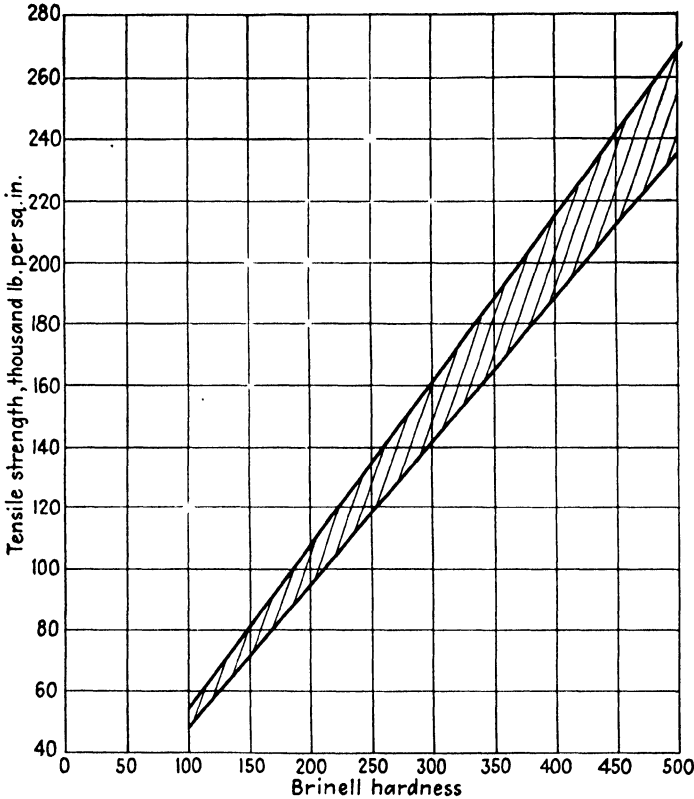

FIG. 9.3. Relation between Brinell hardness and tensile strength of steels. (SAE Handbook.)¹³⁴

that properties other than tensile strength are of controlling importance and that steel is used only to a limited extent when heat treated to its maximum strength. Residual stresses due to quenching are undoubtedly of considerable importance and, in addition, ductility and toughness are considered to be of major significance in the useful life of most machine parts. Serviceability is a poorly explored field, and until some better criteria of quality are developed it is necessary to be guided by the ductility and toughness considerations that have been found adequate in past experience.

9.2. Relation among Hardenability, Tensile Strength, and Tempered Hardness

The hardness that can be attained after tempering in a fully hardened 1-in. diameter bar may be approximated by reference to Fig. 9.2.

It will be noted that the vertical line for a tempering temperature of 1000°F. (540°C.) intersects the curved line marked "fully hardened steels between 0.40 and 0.50 per cent carbon" at a point just below the horizontal line representing a Brinell hardness of 400, or at about 395 Brinell. For the sake of simplicity assume that a temperature of 985°F. (530°C.) is used in the tempering treatment to obtain a tempered Brinell hardness of 400, which is equivalent to a tensile strength of 200,000 lb. per sq. in.

If the steel were not fully hardened during quenching, the Brinell hardness value after tempering would be somewhat lower than indicated for the example and, according to Fig. 9.2, would lie between 400 and about 230 depending upon the hardenability. Similarly, as indicated by the pertinent line in the diagram, the tensile strength may be as low as about 113,000 lb. per sq. in.

The relation between Brinell hardness and tensile strength is shown in Fig. 9.3, which indicates the spread in tensile-strength values that may be obtained in fully hardened steels at one hardness. For example, if the Brinell hardness is 400, a spread of tensile strength between 185,000 and 215,000 lb. per sq. in. may be expected.

9.3. Yield Strength and Yield Ratio

It is sometimes difficult to measure accurately the point on the stress-strain diagram of a specimen tested in tension where the strain becomes plastic and the specimen undergoes permanent elongation. In nearly all untreated low- and medium-carbon steels this point (yield point) is clearly indicated by the drop of the beam of the testing machine. For most heat-treated steels it is common to use some definite amount of elongation over the gage length of the specimen, usually that representing a permanent elongation of 0.2 per cent in 2 in., to fix the value known as the yield strength, but this is not always satisfactory as different steels may differ in their stress-strain behavior. In spite of the possible inaccuracy, the relation between yield strength and tensile strength is fairly constant, as shown by Figs. 9.4 and 9.5, which give a summary of values collected by Janitzky and Baeyertz.⁸⁵ The data for these curves were derived from a variety of low-alloy SAE steels that were quenched as 1-in. diameter bars in oil (0.40 to 0.45 per cent carbon) or in water (0.30 per cent carbon) and tempered over a range of temperatures. It was considered that the steels were entirely martensitic as quenched, but, according to recent standards, this might possibly be questioned. The data indicate, however, that in fully hardened steels there is a relation between yield strength and tensile

strength that is not dependent on the specific alloying elements in the steel.

The ratio of yield strength to tensile strength in fully hardened and tempered steels is in the neighborhood of 90 per cent, if the tempering

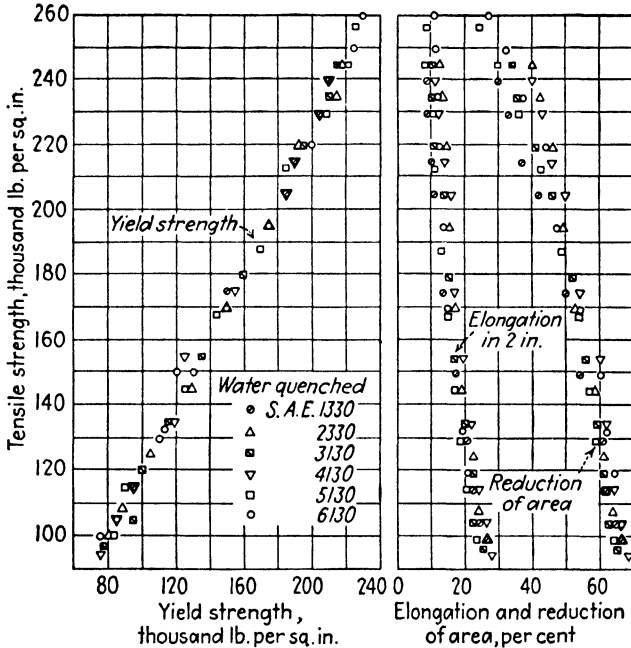

Fig. 9.4. Tensile properties of water-quenched and tempered SAE low-alloy steels containing about 0.30 per cent carbon. (Janitzky and Baeyertz.)⁵⁵

temperature is high enough to relieve stresses effectively. With lower tempering temperatures and tensile-strength values above 200,000 lb. per sq. in., the apparent yield strength tends to be erratic owing, probably, to the presence of unrelieved internal stresses. Such hard steels may have a proportional limit of only 50,000 to 100,000 lb. per sq. in. with a tensile strength of 250,000 to 300,000 lb. per sq. in. Tempering above 800°F. (425°C.) is usually necessary to restore the elastic stiffness.

The constant relation between the tensile strength and the yield strength of fully hardened and tempered low-alloy steels found by Janitzky and Baeyertz was later confirmed by Patton,¹⁰⁷ who plotted data on more than 400 tests obtained from 180 heats of 37 grades of carbon and low-alloy steels. For a tensile strength of 100,000 to 200,000 lb. per sq. in., yield-strength values (and elongation and reduction-of-area values as well) were close to a line representing expected values

at least 70 per cent of the time, and 90 per cent of the values fell within a band that varied about ± 5 per cent from the expected values. Patton found considerably more scatter if the tensile strength was over 200,000 lb. per sq. in., which was undoubtedly due to residual internal stresses.

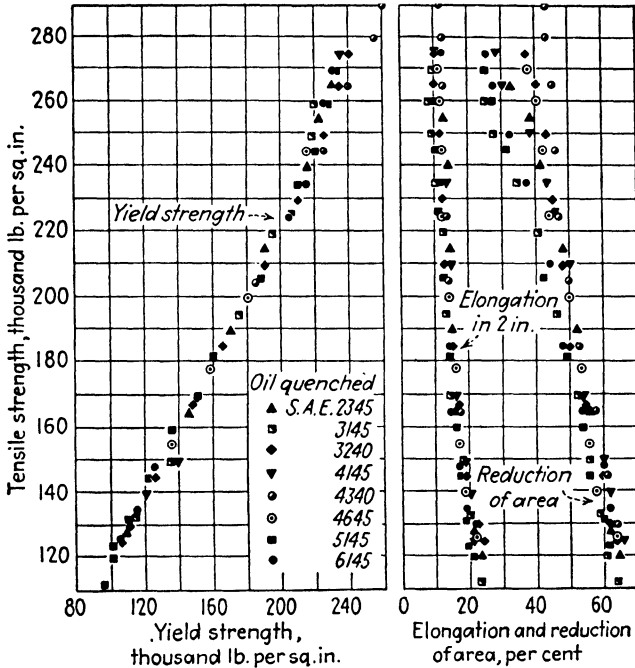

FIG. 9.5. Tensile properties of oil-quenched and tempered SAE low-alloy steels containing 0.40 to 0.45 per cent carbon. (Janitzky and Baeyertz.)⁸⁵

Yield strength may be estimated from either hardness or tensile strength by reference to the yield-ratio chart published by The Society of Automotive Engineers¹³⁴ and reproduced as Fig. 9.6. For example, suppose that a steel has a Brinell hardness of 400 at the center of the section and consequently an equivalent tensile strength of 200,000 lb. per sq. in. Since it is fully hardened, it would be expected to have a yield ratio of about 90 per cent or a yield strength of 180,000 lb. per sq. in.

The broken lines in Fig. 9.6 indicate the variation that may be expected in the ratio. In incompletely hardened steels, these values approach the broken line on the left, so that a steel having a tensile strength of 200,000 lb. per sq. in. might have a yield strength as low

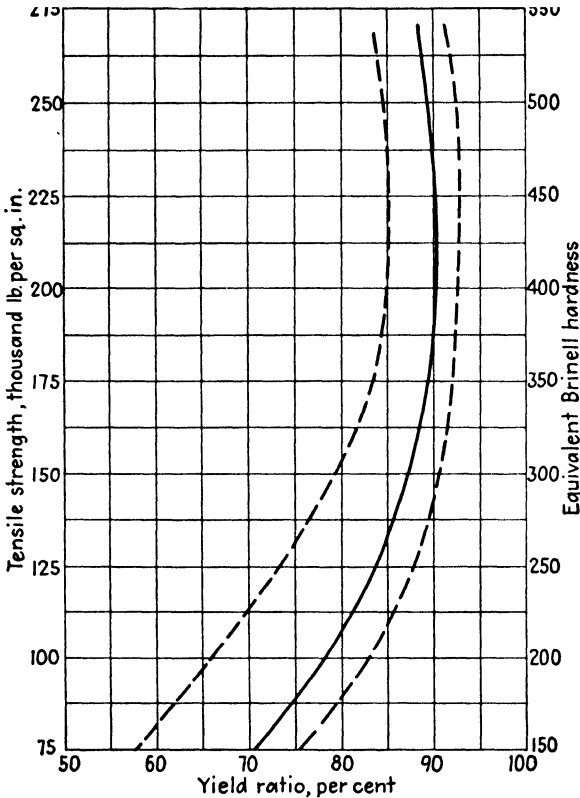

FIG. 9.6. Yield ratio to be expected for a definite tensile strength or Brinell hardness of hardened steels. Range to right of solid line applies to fully hardened steels. Range to left of solid line applies to incompletely hardened steels. (*SAE Handbook*.)¹³⁴

as $200,000 \times 0.85 = 170,000$ lb. per sq. in. depending upon its response to hardening.

9.4. Hardenability and Yield Strength

The yield strength of incompletely hardened steels is, as Fig. 9.6 indicates, considerably below that of tempered steels in which the quenched structure was entirely martensitic. The authors have determined and plotted the yield ratio of a representative group of carbon and low-alloy steels covering a wide range of carbon and alloy contents. Results are shown in Fig. 9.7. The steels were oil quenched in sections from $\frac{1}{2}$ to 4 in. in diameter and were tempered at 1000, 1100, and 1200°F. (540, 595, and 650°C.). Incomplete hardening is expressed

as the difference between the as-quenched Rockwell C hardness (R_Q), as indicated at the appropriate location on the Jominy test, and the maximum hardness (R_M) that a steel of that carbon content could have. The yield strength was measured at 0.2 per cent elongation, and inspection of the test data indicated that this index does not always represent the same location on the stress-strain curves of different steels. The yield ratio drops linearly from between 84 and 98 per cent with complete hardening to between 55 and 70 per cent in the unhardened condition. The significance of the drop is minimized by the realization that the yield ratio of unhardened steels is affected to a considerable extent by the effect of the specific alloying elements and their combinations, as well as of deoxidation treatments, on the unhardened structure.

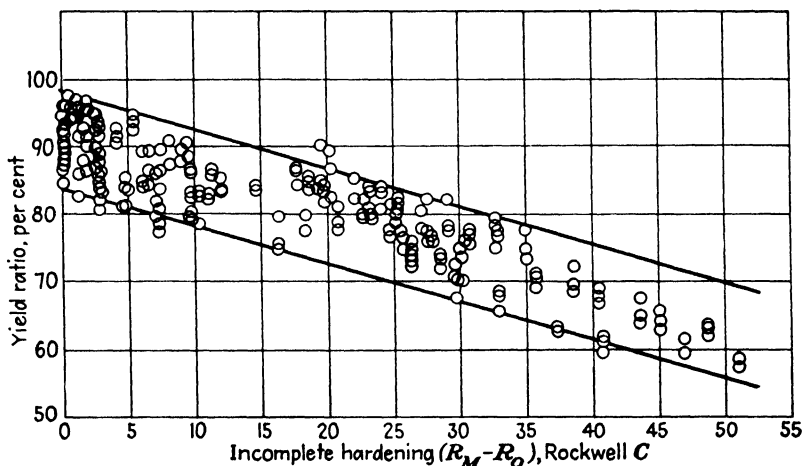

FIG. 9.7. The effect of incomplete hardening on the ratio of yield strength to tensile strength.

In many cases, low yield strength is of no consequence, and it may frequently be neglected if occasional high loads are not encountered. For parts such as automotive steering components or aircraft landing gear, however, where occasional high loads may cause distortion or premature failure, high yield strength is of considerable importance. Since these loads are usually of a shock type, a steel that is fully hardened before tempering is preferable on account of both higher yield ratio and greater toughness. In some cases it is impossible to secure a fully hardened steel, as in some carburized gears and in heavy sections, and the yield strength may be raised by using a vanadium steel that has a relatively high yield strength in the normalized or incompletely hardened condition.

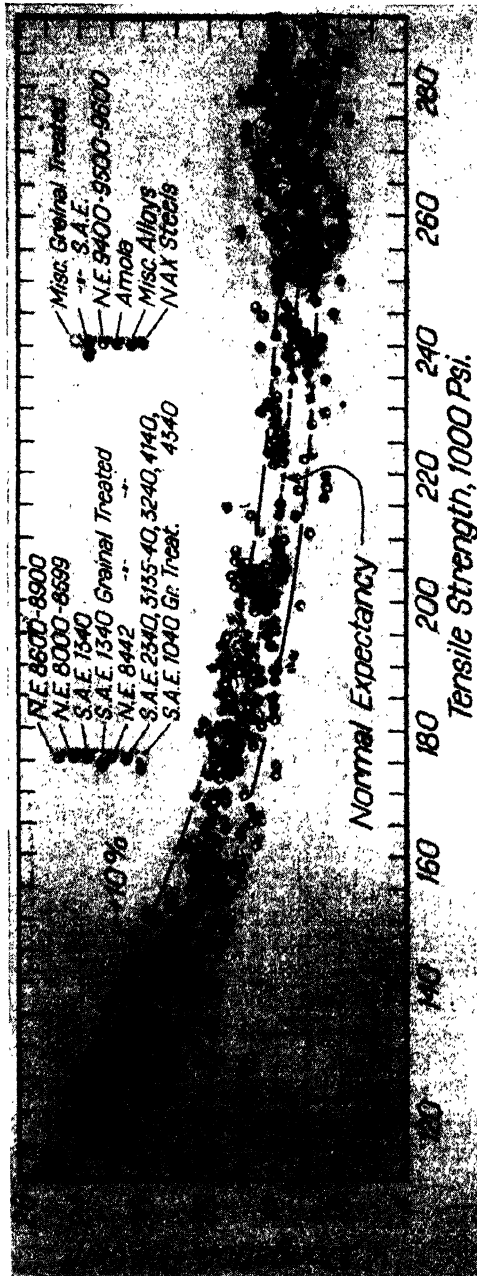

FIG. 9.8. Relation between elongation and tensile strength of fully hardened and tempered steels. (Patton.)¹⁰⁷

9.5. Elongation, Reduction of Area, and Hardenability

Elongation and reduction of area are both indirectly proportional to tensile strength, provided the structure was mostly martensite before tempering and provided no residual internal stresses of consequence are present. The relation as worked out by Janitzky and Baeyertz is shown in Figs. 9.4 and 9.5. The scatter for tensile-strength values of 200,000 lb. per sq. in. and above is considerable, indicating residual stresses. Similar data were reported by Patton¹⁰⁷ (see Fig. 9.8). At high strength levels, the reduction of area particularly is liable to be erratic, and at very high strengths the steel may be brittle. The level at which steel becomes brittle is dependent primarily on carbon, which controls the hardness and strength, but it also depends on the quality of the steel.

It will be noted from Figs. 9.4 and 9.5 that low-alloy steels, presumably quenched so that the structure is mainly martensite and tempered to a tensile strength of about 120,000 to 130,000 lb. per sq. in., have a reduction of area of 60 to 65 per cent. Hollomon, Jaffe, McCarthy, and Norton⁷⁹ determined the specific relation between structure and reduction of area. For a tensile strength of 125,000 lb. per sq. in., the reduction of area was 68 per cent if the quenched structure was entirely martensite, 63 per cent if it was a mixture of martensite and bainite, and 58 per cent if it was a mixture of martensite and pearlite. This indicates that the steels tested by Janitzky and Baeyertz were not entirely martensitic as quenched.

Ductility as measured by reduction of area is very sensitive to "quality" factors that are poorly understood. Even in steels tempered to a tensile strength below 200,000 lb. per sq. in. there are frequently unexplained deficiencies that lower the reduction of area below the maximum that is attained by most low-alloy steels at a given strength level. Usually the difference is small enough percentagewise so that the significance is open to question. Incomplete hardening of "high-quality" steels may lower the reduction of area by about 10 per cent; e.g., from 65 to 55 per cent. A similar and cumulative difference may result from "poor quality" regardless of hardenability. This deficiency caused by poor quality has been ascribed to microsegregation or banding, but no conclusive evidence has been reported. Steels containing in the neighborhood of 0.10 per cent carbon are almost immune to these defects. With 0.20 per cent carbon, the effect of hardenability is barely noticeable and with 0.40 per cent carbon, both hardenability and quality factors have a very marked influence on reduction of area. Increase of tempering temperature, even in the range of 1000 to 1200°F.

(540 to 650°C.), raises the reduction of area to a greater degree than it lowers tensile strength.

Ductility, especially reduction of area, may also be lowered because of other harmful quality factors such as inclusions and segregation. In castings and heavy forgings, the effects of inclusions may be minimized by suitable steelmaking practices, by keeping the sulphur low, and by treatment with aluminum and calcium;^{33,130} but even with these precautions low ductility may occasionally be encountered. It has been found helpful to temper the quenched steel at as high a temperature as possible, and vanadium has been used successfully to resist softening during the high-temperature tempering employed as insurance against low ductility and mediocre impact strength in heavy forgings. Vanadium also avoids another source of low ductility by elimination of the need for aluminum.

9.6. Estimation of Elongation and Reduction of Area from Tensile Strength

The elongation of fully hardened steels may be estimated from data given by Janitzky and Baeyerz⁸⁵ as shown in Figs. 9.4 and 9.5, or from the relation illustrated by Patton¹⁰⁷ in Fig. 9.8. A tensile strength of 200,000 lb. per sq. in. in a fully hardened steel would be expected to be accompanied normally by about 12.5 per cent elongation and a range from 11.5 to 14 per cent. Steels that are incompletely hardened during quenching would have lower values than those indicated in the diagram, depending upon the degree of hardening attained during quenching.

Reduction of area may be estimated roughly from hardness or tensile strength by using Fig. 9.9. In this figure, the heavy diagonal lines represent the normal-expectancy curves while the intersecting lines represent variations from the mean which "may be caused by quality differences or by the magnitude of parasitic stresses induced by quenching." If a steel has a tensile strength of 200,000 lb. per sq. in. after quenching and tempering, then by reference to Fig. 9.9 its reduction of area would be expected to be about 44 per cent most of the time, and to lie always within a range of 35 to 53 per cent. It is evident from Fig. 9.9 that the ductility of plain carbon steels as measured by reduction of area is greatly inferior to that of the alloy steels at a given tensile-strength or hardness level.

Most heat-treated machine parts are made from bars that are rolled or forged. Such hot working elongates the ferrite areas, the corresponding carbon-rich zones, and any inclusions present into fibers that lie in the direction of working. This fibrous structure, which is charac-

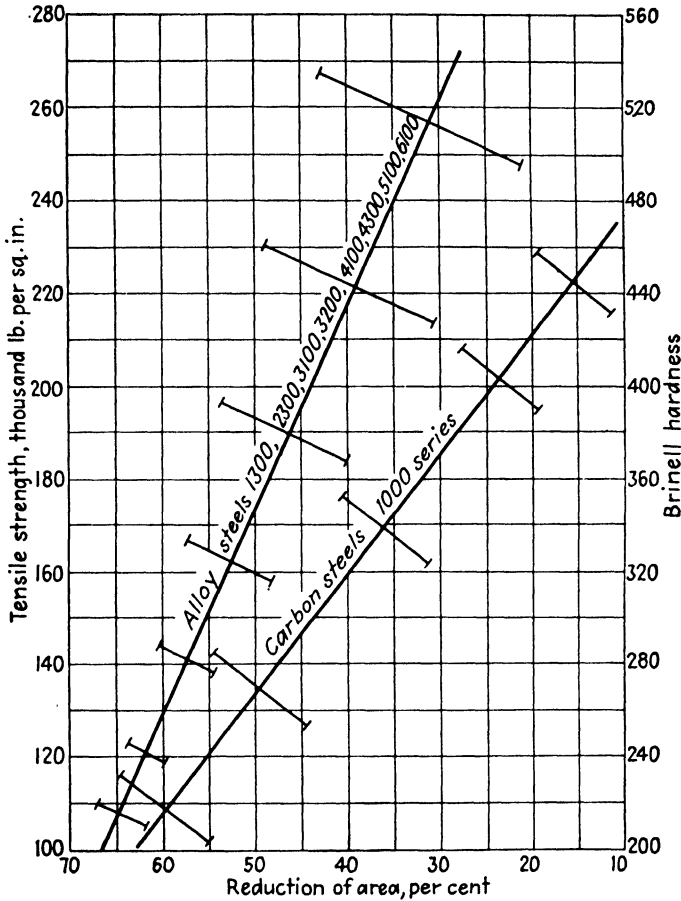

FIG. 9.9. Relation between reduction of area and tensile strength or Brinell hardness of quenched carbon and alloy steels. (SAE Handbook.)¹³⁴

teristic of hot-worked steel, is very persistent and is frequently not eliminated by heat treatment.

Unless a bar is very large, it is impossible to cut a test specimen at right angles to the direction of rolling; hence, there are few data on transverse properties except in the case of sheet, plate, and other wide flat-rolled products. Practically all tensile and impact properties on bars are, therefore, taken parallel to the direction of working (longitudinal), and the properties so far discussed in this book are all from such tests. The ductility and toughness determined on specimens taken at an angle to the direction of rolling or forging may be much inferior to the same properties of a longitudinal specimen—the degree of

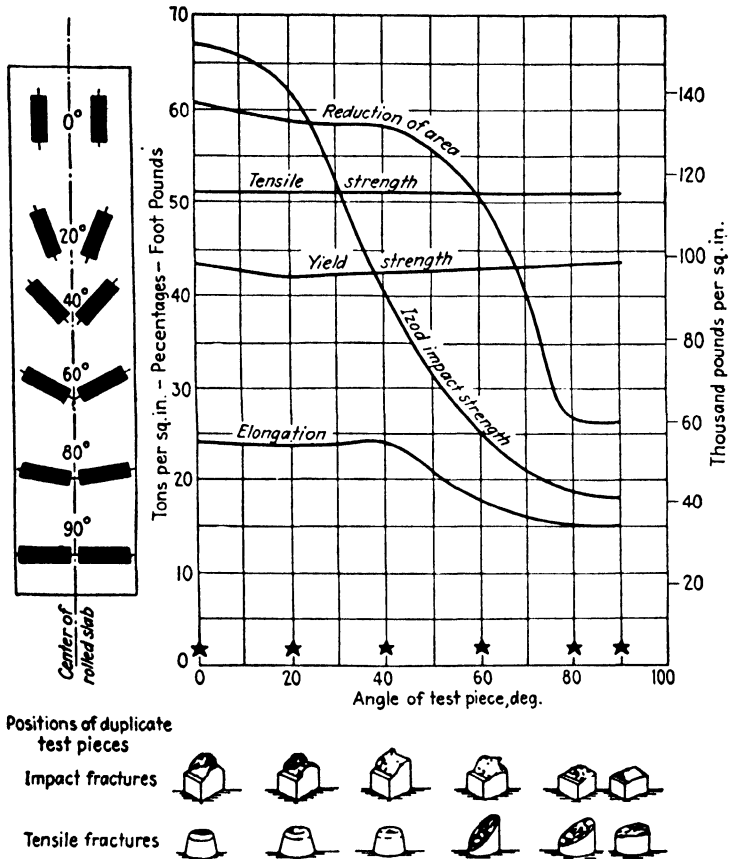

FIG. 9.10. Relation between the mechanical properties and the angle of inclination of the fibers to the axis of the test piece. (Aitchison,¹ after Brearley.)

inferiority depending on the characteristics of the steel, the amount and kind of hot working, the direction of the fibrous structure in the test specimen, and how thoroughly the oriented structure was eliminated during heating prior to quenching.

The effect of the direction of rolling on the mechanical properties is well illustrated by the classic experiments of Brearley as reported by Aitchison¹ and shown in Fig. 9.10. Tensile strength and yield strength are mostly unaffected, but elongation and reduction of area, and impact resistance, are seriously reduced, in some cases to a relatively small fraction of the original value as Fig. 9.10 shows.

With the possible exception of some crankshafts, gears, and a few other articles, transverse properties are not ordinarily considered to be

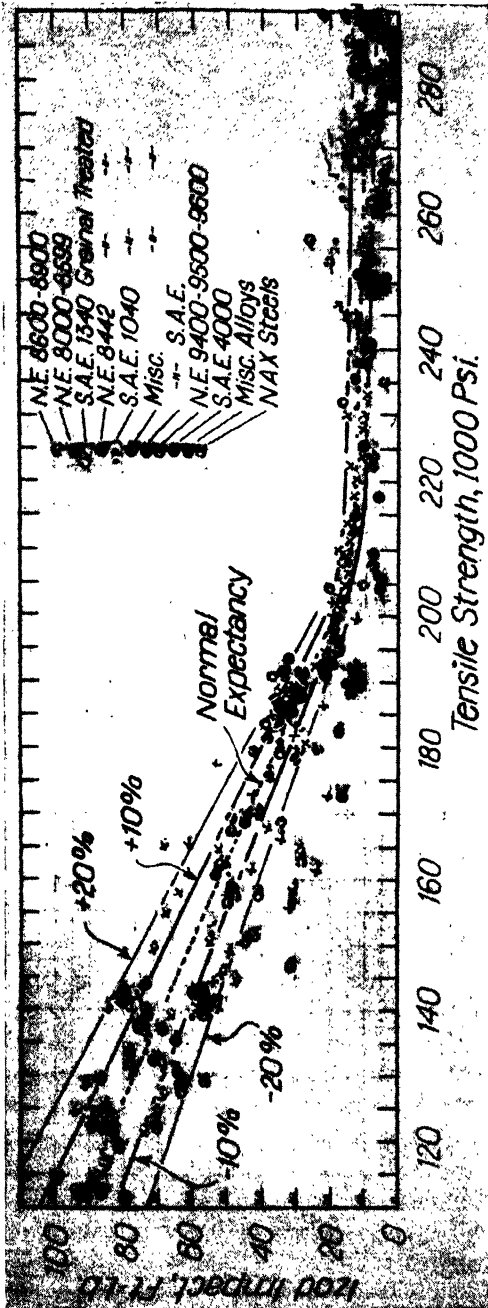

Fig. 9.11. Relation between Izod impact value and tensile strength of fully hardened and tempered steels. (Patton.)¹⁰

important in machine design, but it should be kept in mind that heat-treated carbon and low-alloy steels with satisfactory properties as determined on longitudinal specimens may be less ductile under transverse loads, and that the property relations discussed in this and other chapters hold only for specimens cut in the direction of hot working.

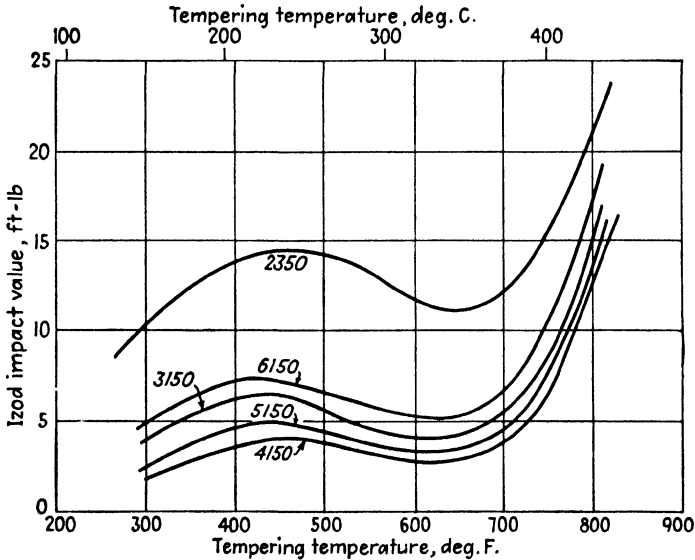

FIG. 9.12. Effect of tempering temperature on the Izod impact value of fully hardened SAE steels. (Grossmann.)⁶⁶

9.7. Notch Toughness

The resistance of a steel to fracture when notched and subjected to impact stresses varies approximately inversely with tensile and yield strength, provided that the structure was martensitic as quenched and that internal stresses are not present; in other words, provided that the tensile strength is not over 200,000 lb. per sq. in. This has been demonstrated by Patton¹⁰⁷ as shown by Fig. 9.11. With high strength values, the impact resistance is low and changes little as the strength increases.

Excessive amounts of inclusions are likely to reduce the impact resistance, and fine-grained steels have a considerably higher resistance than coarse-grained materials of similar composition. Impact resistance is sensitive to slight variations in structure and to differences in the so-called "quality factors" so that there is much more scatter in Patton's values (Fig. 9.11) than in the values for elongation and reduction of area as shown in Figs. 9.4, 9.5, and 9.6. It is also greatly affected by the

type and the size of the specimen, and especially by the type of the notch and the accuracy with which the notch is cut.

Impact resistance has a characteristic anomaly if the quenched steel is tempered at a low temperature. As shown in Fig. 9.12 from Grossmann,⁶⁶ for most steels, this temperature lies between 550 and 700°F. (290 and 370°C.). The lower toughness for this range is common to

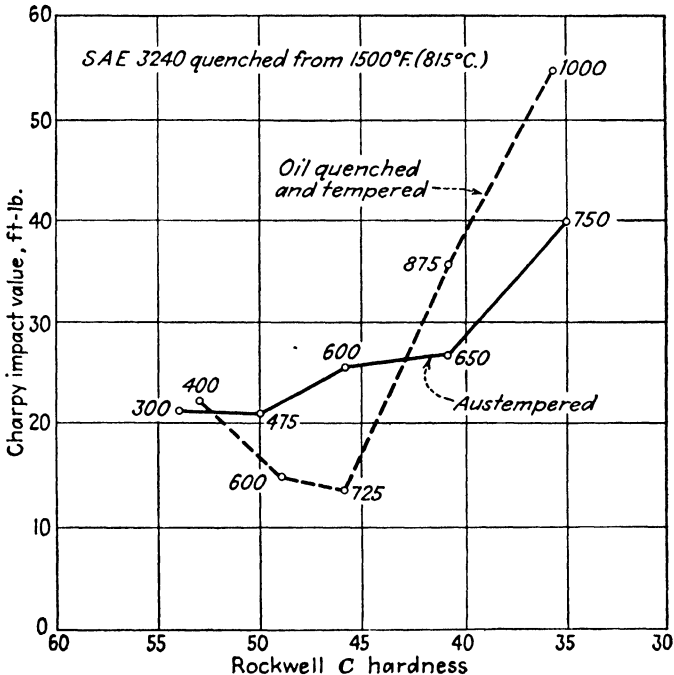

FIG. 9.13. Effect of austempering in avoiding tempering brittleness. Numbers in diagram indicate tempering temperature in degrees Fahrenheit. (Payson and Hodapp.)¹⁰⁸

all hardened steels and is considered by Grossmann⁶⁹ to result from the carbide distribution following martensite decomposition. Bain¹⁹ has suggested that this brittleness could be avoided by austempering, as shown in Fig. 9.13, since the resulting bainite does not exhibit this form of brittleness. No means has been found for curing the brittleness developed by tempering martensite in the intermediate range, and for most purposes tempering is carried on below 500°F. (260°C.)—for tool and die steels—and above 800°F. (425°C.) for engineering steels. Even 800°F. is borderline, and higher tempering temperatures are recommended to avoid erratic tensile properties as well as low impact strength.

9.8. Calculation of Izod Impact Strength by Addition Method

The Izod impact strength may be estimated directly from tests made on tempered and end-quenched Jominy specimens according to a method worked out by Crafts and Lamont.³⁹ This is done by machining an Izod impact specimen from the end-quenched Jominy bar after tempering at the desired temperature, say 1020°F. (550°C.) as with the previously mentioned (p. 165) example of 8645 steel tempered to 33

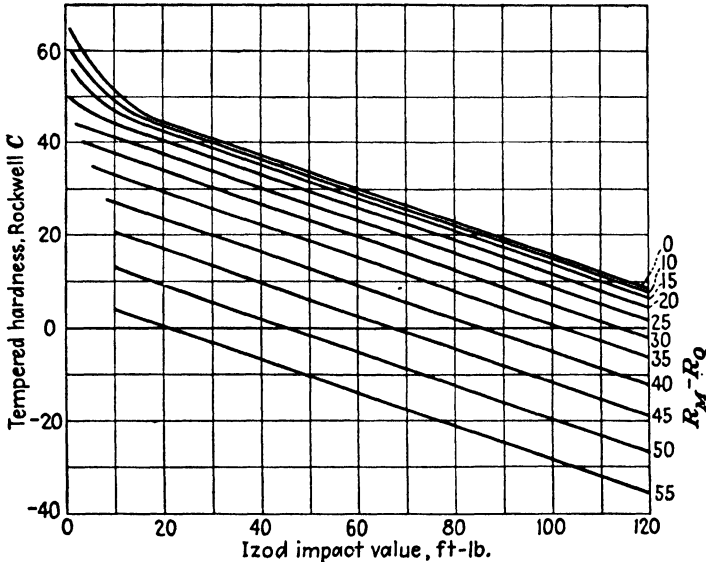

FIG. 9.14. Relation between Izod impact strength, tempered hardness, and degree of hardening of fine-grained alloy steels. (Crafts and Lamont.)³⁹

Rockwell C. The Izod notch is cut at a depth from the water-quenched end corresponding to the severity of quench and size of bar for which the Izod impact strength is to be estimated. For example, if the impact strength of a 4-in. diameter bar quenched with a severity $H=0.35$ is to be estimated after tempering at 1020°F. (550°C.), the Jominy specimen is tempered at 1020°F., machined to impact-specimen size, and notched at a Jominy depth of 29 sixteenths of an inch in accordance with the relation between Jominy depth, severity of quench, and bar size shown in Fig. 4.14 (p. 72). Because of the dimensions of the Izod specimen, the notch cannot be located closer to the water-quenched end of the specimen than $1\frac{1}{8}$ in. and, therefore, the use of such a test is limited to the estimation of impact strength in sections over about $2\frac{1}{2}$ in. in diameter. A normal error of about ± 20 ft.-lb. may be expected from

this method of estimating Izod impact strength, which is too great except for a very rough approximation.

The Izod impact strength of fine-grained low-alloy steels may also be calculated from quenched and tempered Rockwell C hardness.³⁹ Figures 9.14 and 9.15 may be used for this purpose, or the

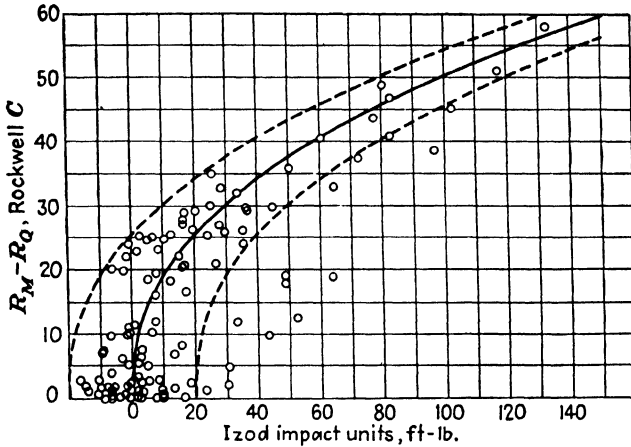

FIG. 9.15. Decrement in Izod impact values (ft-lb.) for degree of hardening during quenching. (Crafts and Lamont.)³⁹

Izod impact strength may be calculated from the following formula:

$$I \text{ (below 45 Rockwell C)} = 2.8(51.7 - R_T) - \frac{(R_M - R_Q)^{2.35}}{100}$$

$$I \text{ (above 45 Rockwell C)} = \text{(top curve, Fig. 9.14)} - \frac{(R_M - R_Q)^{2.35}}{100},$$

where I = Izod impact strength, in ft-lb.,

R_T = tempered hardness,

R_M = maximum hardness for carbon content,

R_Q = as-quenched hardness.

Assume, for example, that it is desired to know the Izod impact strength at the center of the fully hardened bar of 8645 steel with a hardness of 33 Rockwell C. The maximum hardness for 0.45 per cent carbon steel is 58.7 Rockwell C and the quenched hardness at the center of the 1-in. diameter bar is, as previously determined, 57.6 Rockwell C, so that the Izod impact strength is calculated to be 52.3 ft-lb. by substituting these values in the proper formula thus:

$$I = 2.8(51.7 - 33.0) - \frac{(58.7 - 57.6)^{2.35}}{100},$$

$$I = 52.3 \text{ ft-lb.}$$

In order to avoid calculation the Izod impact strength may be determined by interpolation directly from Fig. 9.14. If the tempered hardness is 33 Rockwell C and if the steel had a maximum hardness at the center after quenching, R_M minus R_Q would be equal to zero and the Izod impact strength would be represented by intersection of the horizontal line representing a tempered hardness of 33 Rockwell C and the diagonal line for $R_M - R_Q = 0$, or an Izod impact value of 52.3 ft-lb. If the as-quenched hardness is 57.6 Rockwell C, the value for R_M minus R_Q is equal to 1.1 and the impact strength would be represented at the point where the horizontal line representing a tempered hardness of 33 Rockwell C intersects a line parallel to, but very slightly below, the line for $R_M - R_Q = 0$.

However, assume that the 8645 steel had been oil quenched as a 3-in. diameter section with a quenched center hardness of 35.2 Rockwell C, and that it was tempered to 33 Rockwell C. The impact strength would then be represented in Fig. 9.14 by the intersection of the horizontal line for 33 Rockwell C and an imaginary line drawn parallel to the other lines in the diagram at an estimated $R_M - R_Q = 23.5$. The steel would have an estimated Izod impact strength of 35 ft-lb. or a loss of about 17 ft-lb. due to incomplete hardening. The loss in impact strength due to incomplete hardening, that is, the value for the expression $\frac{(R_M - R_Q)^{2.35}}{100}$ in the above formula, may be estimated directly from

Fig. 9.15. For example, if $R_M - R_Q = 23.5$, the horizontal line for this value intersects the solid curved line at a point representing a value on the abscissa of about 17 ft-lb.

It should be emphasized that this method of estimating Izod impact resistance is applicable only to fine-grained alloy steels and that the impact strength of carbon steels and coarse-grained steels cannot be reliably predicted. As stated in a previous paragraph, the accuracy is low.

9.9. Temper Brittleness

Temper brittleness is an ailment that develops rapidly only in some low-alloy steels and with some treatments. If susceptible steels are tempered for a short time in the range of 800 to 1200°F. (425 to 650°C.) and slowly cooled, they may become brittle, as indicated by the impact test, but if they are water quenched from the tempering temperature, they will be tough as shown in Fig. 9.16. Hollomon,⁷⁷ who recently reviewed the subject, pointed out that steels that are apparently not susceptible in tests at room temperature may be temper brittle at very low temperatures, and they will show embrittlement at higher subzero

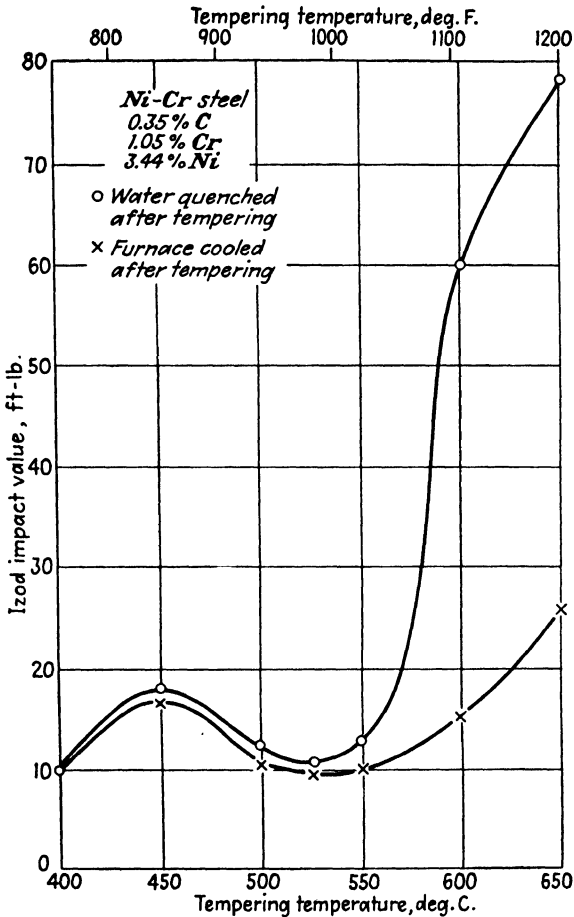

FIG. 9.16. Effect of cooling rate in avoiding temper brittleness after tempering a susceptible steel in the critical temperature range. (Hollomon.)²⁷

temperatures than steels not subject to this defect. This is of special interest for aircraft and other equipment operating at low temperatures. The embrittlement seems to result from a precipitation phenomenon, and practically all low-alloy steels are affected after long tempering in the temperature range where they are sensitive. Molybdenum is helpful in reducing the susceptibility that develops during short tempering treatments; and the total alloy content, according to Hollomon, increases susceptibility in proportion to the increase in hardenability that results from a higher total percentage of alloying elements.

The low-temperature brittleness accompanying temper brittleness

was studied by Hollomon and his associates.⁷⁹ A nickel-chromium (3135) steel was quenched in water from 1600°F. (870°C.) and tempered at 1110°F. (600°C.). All of the specimens were water quenched from the tempering temperature and some of them were reheated to 850°F. (455°C.)—the embrittling temperature—for periods up to 500 hr. Both the embrittled and non-embrittled specimens had approximately the same tensile properties and hardness, and there was practically no difference in the endurance limit. The effect of the embrittling treatment on the Charpy (V-notch) impact resistance is indicated by the data in Table 9.1.

TABLE 9.1. Effect of Temper Brittleness on the Impact Resistance of Quenched and Tempered 3135 Steel at Various Temperatures*

Testing temperature		Charpy impact value, ft.-lb.	
°F.	°C.	Not brittle	Brittle
390	200	95	95
210	100	95	78
120	50	97	25
Room	Room	93	20
32	0	100	15
- 40	-40	80	10
-112	-80	38	8

*Hollomon, Jaffe, McCarthy, and Norton.⁷⁹

9.10. Notch Toughness and Hardenability

The normal notched-bar impact strength of steel is seriously reduced in imperfectly hardened steels. As postulated by Grossmann,⁶⁹ the presence of ferrite in the structure is probably a major cause of the low impact strength. Crafts and Lamont³⁹ found that the Izod impact strength of fine-grained alloy steels was inversely proportional to the tensile strength for all degrees of hardening (see also Fig. 9.11), but that the level of impact strength became increasingly lower as the initial hardness or the proportion of martensite decreased. It was also found that coarse grain size may lower the impact strength of incompletely hardened steel by a large amount. Very fine grain size tends to give higher values than most of those indicated in Fig. 9.11. Elements such as phosphorus are harmful, and data on steel castings¹¹⁴ indicate that sulphur is also detrimental. Boron is beneficial to the extent that it increases the percentage of martensite in quenching, but in incompletely hardened steels it may be harmful to impact resistance. With the exception of nickel, which increases toughness in unhardened steels and

at low temperatures, the usual alloying elements have no marked specific effects on the normally expected impact strength (see Fig. 9.11), so that, aside from temper brittleness and impurities, the composition of fine-grained low-alloy steels is significant only as it affects hardenability and resistance to tempering. It should be noted that, although carbon is no exception to this rule, high carbon tends to lower the attainable impact strength by raising the hardness without increasing the degree of hardenability correspondingly. Plain carbon steels are erratic and their impact strength cannot be predicted with the reliability that has been found for most low-alloy steels.

Hollomon and associates⁷⁹ recently studied the effect of incomplete hardening on the impact resistance of two 0.35 per cent carbon low-alloy (3135 and 8735) steels. Specimens were quenched at rates that resulted in structures of martensite, martensite plus bainite, and martensite plus pearlite. They were then tempered to a tensile strength of 125,000 lb. per sq. in. Charpy impact data at various temperatures are collected in Table 9.2. The effect of incomplete hardening during quenching is clear; even on testing at room temperature this effect is readily apparent.

TABLE 9.2. Effect of Incomplete Hardening on the Impact Resistance (Charpy V-notch) of Two Low-Alloy Steels at Various Temperatures*

Testing temperature		Charpy impact value, ft.-lb., for a quenched structure of		
°F.	°C.	Martensite	Martensite plus bainite	Martensite plus pearlite
390	200	108	84	60
210	100	109	88	58
120	50	112	88	60
Room	Room	107	92	46
32	0	110	42	38
- 40	-40	102	22	18
-112	-80	97	16	12

*Hollomon, Jaffe, McCarthy, and Norton.⁷⁹

9.11. Significance of Impact Properties

The significance of notched-bar impact strength is not obvious and it has not been generally accepted as a specified or standard test. It is generally not capable of being utilized in design as are tensile strength and other directly related properties, so that, except in a few cases, such as for steel for low-temperature service, the value of impact strength

has not been correlated satisfactorily with serviceability. In sections such as armor plate where ability is needed to absorb great loads with deformation but without failure, the advantage of high impact strength is obvious. Intuitively, it is felt that some toughness is desirable for most steel applications even though failure in machine parts is usually by fatigue. There appears to be some justification for this feeling in hard steels and in brittle steels. Riegel^{116, 117} found that service failures increased when the impact strength dropped below a certain level. There has also been some indication that tougher steels are somewhat more resistant to fatigue in the presence of notches. Although the evidence is sparse and questionable, there is probably some relation between low impact strength and poor fatigue life. Quite possibly, the relation is indirect and is the result of other common causes, such as massive ferrite in the microstructure. As the testing temperature is lowered to below room temperature, there is an abrupt reduction in impact resistance (see Table 9.2) and a sudden change in the character of the break from one that is ductile to one that is brittle. Recent thought has been in the direction that this transition temperature where the steel becomes brittle under impact is more significant than the actual impact value and that the transition temperature should be appreciably lower than the minimum temperature the steel will encounter in service.

Impact strength reflects incomplete hardening and, with other factors held constant, is a rough index of hardenability. In addition, it reflects other qualities, such as grain size. With steels made under close composition control, and with hardenability and grain size specifications, the impact test is roughly predictable and a specification is probably not necessary to insure freedom from brittle steel. In Great Britain, where neither chemical composition, nor hardenability, nor grain size is rigidly specified, it is rational to utilize an impact-strength specification in order to insure the desired quality in the steel. Use of such a specification in Great Britain²⁵ has been considered to be very successful. Carbon steels, it should be remembered, are not sufficiently consistent to permit prediction of impact strength, and there is no substitute for the test itself. Its limitations should, however, be clearly recognized.

Although the significance of the notched-bar impact test is open to question, it indicates the capacity of a steel to absorb strain under the constraint imposed by complex stresses to a more effective degree than do elongation and reduction of area in the tensile test. The impact test has, therefore, been preferred, in comparison with the tensile test, as the more sensitive criterion of ductility. Inasmuch as the need for some ductility is generally recognized, it would seem that hardness alone is inadequate as a criterion of serviceability. In order to provide a

definite limit to useful hardness, it seems reasonable that impact strength be used as a measure of limiting ductility. While the ultimate significance of this criterion may be questioned, the evaluation of tensile strength at comparable levels of impact strength provides a basis for estimating the desirable degree of hardenability in the selection of steel.

9.12. Fatigue Strength

Fatigue strength under repeated loading is usually considered to be proportional to tensile strength. If smooth unnotched specimens are considered, the fatigue strength of steel (endurance limit) is usually in the range of 35 to 65 per cent of the tensile strength, and Sisco¹³¹ recommends that the engineer should use 40 per cent of the tensile strength, although the average expected value is nearer to 50 per cent. Steels with a tensile strength higher than 250,000 lb. per sq. in. may have relatively low fatigue strength; in fact, values for an endurance limit of more than 100,000 lb. per sq. in. are rarely reported. The endurance limit of notched bars and of bars with a rough surface is much lower, and design notches, machining notches, etching, electroplating, and corrosion should if possible be avoided. Peterson¹¹¹ has suggested that fine-grained steel is more notch sensitive in fatigue than coarse-grained steel, but this conclusion is at variance with so many other advantages of fine-grained steel that it is felt that confirmatory evidence is needed. It is usually considered that a steel whose structure is tempered martensite is less sensitive to notches and has a higher endurance ratio than steels containing incompletely hardened structures, especially at high strength levels.

As the endurance limit is more or less proportional to the tensile strength, any lowering of hardness can be expected to have a significant effect. Thus, articles with soft decarburized surfaces are likely to have a low fatigue life. In partially hardened steel, the first constituent to appear is usually ferrite, and, as it is soft, it may lead to a local weakness and premature failure. Precipitated compounds such as carbides or inclusions in the structure may provide notches for stress concentration. Thus, any structural inhomogeneity may be deleterious and should be avoided as much as possible. There is also some indication that elements with a strong tendency to segregate, such as manganese, may contribute to low fatigue strength.

In general, however, the fatigue strength of a quenched and tempered low-alloy steel is not so structure sensitive as the impact resistance or the elongation or reduction of area. Hollomon and associates⁷⁹ found a practically straight-line relation between yield strength (for 0.1

per cent elongation) and the endurance limit regardless of whether the structure as quenched was entirely martensite, martensite plus bainite, or martensite plus pearlite. Since yield strength depends to a considerable extent on quenched structure, the ratio of endurance limit to tensile strength may deviate from the usual 50 per cent, depending on the amount of martensite in the structure as quenched. For a low-alloy steel with a tensile strength of 125,000 to 130,000 lb. per sq. in., Hollomon and coworkers⁷⁹ found endurance ratios of about 57 per cent for a quenched structure of martensite, 53 per cent for martensite plus bainite, and 48 per cent for martensite plus pearlite.

Fatigue life is subject to so many factors that it is impossible to do more than point out some of these. Decarburization lowers the endurance limit so that it is proportional to the tensile strength equivalent to the carbon content at the surface. Decarburization is particularly hard to control in springs, and fatigue failures are relatively common if the springs are highly stressed. Certain steels, notably the vanadium and high-silicon types, are responsive to the furnace atmosphere in heating, so that after heat treatment in mildly reducing atmospheres their fatigue life is greatly increased in comparison with their life after treatment in an oxidizing atmosphere.⁷⁰ Protective atmospheres tend to reduce oxidation, but according to Funk and Von Ludwig,⁵³ apparently perfect protection still leaves an undesirable surface condition. Grinding may leave a detrimental residual tensile surface stress. Almen² has forcibly brought out the advantages of shot peening, which produces a compressive surface stress and thereby increases the endurance limit. A similar advantage resulting from the use of shallow-hardening, nitriding, and carburizing steels has been described in Chapter 5. The presence of any weak component of the structure, such as ferrite, has been found to be so harmful that a wholly martensitic as-quenched structure is believed to be essential to maximum fatigue strength.

9.13. Summary

All of the strength-dependent properties are predictable with some degree of accuracy. Fatigue strength is the least amenable to quantitative treatment, but it is probably at least as structure sensitive as yield strength. Experience has indicated that some degree of capacity for deformation results in better service even in applications where such capacity is not an obvious requirement. Of the measures of ability to absorb energy, elongation and reduction of area are relatively insensitive as they are measured under a nearly uni-axial loading, in which the steel has the greatest opportunity to deform gradually rather than to fail abruptly. The notched-bar impact test, on the other hand, is designed

to approach the more restrained condition of tri-axial loading that is commonly found in service. It is, therefore, considered that impact strength is the most suitable available criterion of capacity for deformation and that it can be used effectively to evaluate the requirements of minimum hardenability and maximum tensile strength for the purpose of selecting a steel suitable for the intended service.

Considerable evidence is now available to show that all of the structure-sensitive mechanical properties—yield strength, endurance limit, elongation and reduction of area, and resistance to single-blow impact—are improved and attain their optimum values if the steel as quenched has a structure consisting almost wholly of martensite. For a given tensile strength, at least between 100,000 and 200,000 lb. per sq. in., steel having a structure consisting of martensite and bainite has after tempering a lower yield ratio, a lower endurance ratio, lower elongation and reduction of area, and a lower impact resistance than if the quenched structure is entirely martensite, but the properties of steels with such structures are considerably superior to those whose quenched structure contains much pearlite. In general it is, therefore, advisable to select a steel with sufficient hardenability so that the as-quenched structure at the center of the bar will not contain appreciable quantities of pearlite.

CHAPTER 10

FACTORS IN THE SELECTION OF STEEL

THERE ARE MANY FACTORS that must be considered in the selection of a carbon or low-alloy steel that is to be used for a stressed part in a structure or machine. The principal ones are, of course, reliability and economy. Reliability depends largely on the mechanical properties that will meet the requirements in service, and these depend in turn on composition, heat treatment, hardenability, and other factors. Reliability also depends on quality, which in turn depends on the control of a number of variables in manufacture and processing.

The economy depends in part on the heat treatment necessary to secure the desired mechanical properties and on the first cost, which depends on composition, melting, refining, and further processing. It also depends, and very importantly too, on the ease or difficulty of fabricating the part by machining, welding, or a number of other operations.

It is evident from the foregoing that the selection of the best and most economical steel for any specific engineering use where relatively high stresses are encountered is exceedingly complex and consists of consideration of so many tangibles and intangibles that each step in the process of preparing a finished steel article for use, as well as the history of the material, must be studied individually and the several variables must be integrated by skill of a high order. Some of the factors may be

evaluated with a measurable degree of accuracy, others are entirely qualitative, and many are unrecognized. Experience and intuitive judgment may be aided by application of known factors, but practical art is still dominant in spite of our massive but fragmentary knowledge of the behavior of steel during processing and subsequent fabrication. The object of the following discussion is to coordinate some of our knowledge in a form that will facilitate the selection and heat treatment of steel.

10.1. Factors to Be Considered in the Selection of Steel

The opportunity to select a steel implies that there are a number from which to choose. Of the many significantly different chemical compositions available the requirements of a given application limit the choice to a certain group of steels. If, for example, the part is to be subjected to wear, it must be hard, especially at the surface, and the choice is limited to high-carbon, carburizing, or nitriding steels. If the section is small, carbon steel may be adequate with a water quench. If the section is relatively large, alloy steel is necessary and the carbon content is limited by the tendency of the steel to crack when drastically quenched. If only load-carrying ability is required, the serviceable strength may be dependent on resistance to shock. The required dimensions, strength, and toughness define the necessary degree of hardenability and this defines the total effective content of alloying elements. Then, from a small number of steels that are similar in character on the basis of reliability and on the basis of the cost of processing into the finished article, a specific composition may be selected.

The preceding chapters have outlined methods for producing desired microstructure, strength, and toughness by control of heating, hardening, and tempering. Nearly always heating is controlled by convenience and cost, so that the rate and method of heating are of great commercial but relatively little technical importance. There are some exceptions to this; for example, induction heating or flame heating or carburizing may be used where gradients of temperature or of composition are desired. In cooling from above the critical temperature, however, the temperature-time cycle is all-important. The types of microstructure that may be developed in different temperature ranges by isothermal transformation and by continuous cooling at various rates have been qualitatively determined for different steels. Treatments of great practical value, such as isothermal annealing for machinability, austempering to produce high strength and toughness in certain sections

of high-carbon steels, and martempering to avoid quench cracking, as well as many other interrupted-quenching procedures, are used commercially.

Correlation of isothermal transformation with respect to hardening during continuous cooling has not yet reached a quantitative status, but quenching velocities have been evaluated in terms of the resulting martensite structure and hardness. The conception of the ideal or infinitely fast quench has served as a basis for comparison of standardized hardenability tests so that the hardenability of a steel or of a hypothetical composition may be determined readily. The approximate relationship between the degree of hardening obtained on quenching and the strength and toughness of steels in the tempered condition has also been determined. Thus, it is possible to predict roughly, but accurately enough for most purposes, the primary properties that may be produced in the finished article. Tensile strength may be estimated within about 15,000 lb. per sq. in. if the composition, quenching rate, and tempering treatment are carefully controlled. A comparable error may also be expected from inescapable variations in the composition of commercial steel and from lack of control of the rate of quenching. Although the accuracy of such control leaves much to be desired, a first approximation of the tensile strength is now possible and is essential as a primary factor in steel selection because many of the other qualities may be expressed most readily as a function of tensile strength.

In low-alloy steels, properties such as yield strength, elongation, reduction of area, and notched-bar impact resistance are approximately the same at one tensile-strength level regardless of composition and heat treatment, provided the steel has been quenched to a wholly martensitic structure and provided there are no internal stresses of consequence present. This similarity of properties also demonstrates that, in fully hardened steel, one alloying element may be substituted for another without changing the relation. This corollary is essential to the freedom of selection of steels on the basis of hardenability. In incompletely hardened steels an analogous similarity of properties in different types of alloy steels has been assumed when the degree of partial hardening is the same. The validity of the substitution principle was generally confirmed in practice during World War II when the so-called National Emergency (NE) steels were used successfully in place of those containing strategically critical alloying elements. The only unsuccessful substitutions of NE steels for the older materials were in cases where the compositions were unbalanced with respect to some of the fabricating properties. Because of the validity of the substitution principle, it is

possible to group the steels according to hardenability and according to the resulting properties developed by heat treatment.

After selection of a group of steels that is suitable for developing the desired final properties, a further elimination can be made of those steels that give disproportionate difficulties in processing. Some steels may decarburize too readily, some may be difficult to anneal, some may machine with difficulty, some may be prone to abnormal brittleness, some may tend to warp or crack during quenching, and some may be difficult to heat treat consistently. These characteristics will be discussed more fully. Although they are not easy to evaluate, they may be vitally important to the quality and the cost of the finished article. The first cost of the steel is always important, but the cost of processing and the reliability of the product must always be considered if the most economical production is to be realized. Finally, if after consideration of the pertinent factors there is more than one steel left to choose from, the ultimate choice depends primarily on first cost. The success of economical selection depends on the degree to which sound principles are followed and accurate data utilized, and the outline in the following sections is designed to facilitate such an evaluation.

10.2. Properties Affecting Serviceability: Full Hardening

The degree to which the optimum potential properties of a steel may be realized depends perhaps more upon the degree to which complete hardening is attained during quenching than upon any other factor in the treatment of steel. Fully hardened wholly martensitic steels have the highest hardness after quenching and also the highest combinations of tensile strength with yield strength, ductility, and toughness after tempering. The same combinations of optimum properties can be obtained in heat treating steels of different alloy combinations and can be produced consistently. The martensitic structure is, therefore, a convenient and reliable basis for evaluation of less completely hardened structures and is considered as a standard representing optimum quality.

If the steel is overquenched* or the martensite reaction is not completed at room temperature, the as-quenched hardness may be relatively low owing to the presence of austenite, and the tempered hardness may be higher than desired owing to austenite transformation during tempering. This tendency to retain austenite is noticeable in some automotive carburizing and heat-treating steels. To some degree it is proportional to hardenability, but it tends to become more noticeable

*Colloquialism signifying that the martensite is contaminated by considerable retained austenite.

in steels containing relatively high nickel and manganese. The corresponding less-than-maximum hardness can be seen near the water-quenched end of Jominy bars. It is objectionable in gears that must retain their dimensional accuracy in service, and it may explain some of the premature failures of steels containing much more than the necessary alloy content.

10.3. Properties Affecting Serviceability: Incomplete Hardening

Incompletely hardened steels have a quenched structure that is only partially martensitic and, when tempered, they are not only lower in strength but disproportionately lower in respect to other properties than fully hardened steels. It is, therefore, necessary to sacrifice more than a corresponding amount of strength in order to obtain an adequate degree of ductility and toughness. The as-quenched hardness of incompletely hardened steel is obviously lower than that of fully hardened steel and, in general, the same is true after tempering. There is an important exception to this statement, illustrated by Fig. 8.5 (p. 153), in which the hardness of tempered Jominy specimens is shown to reach a maximum after tempering at the points corresponding to about 90 per cent martensite near the "shoulder" of the Jominy curve. At points near the water-quenched end the steel may soften to as much as 5 Rockwell C less than at the point of maximum tempered hardness. Between the 50 and 90 per cent martensite location in the upper part of the Jominy curve gradient, the hardness after tempering at low temperatures may actually be higher than after quenching. Steels in this condition are hard but deficient in ductility, so that they are generally unsuitable for most engineering applications. After tempering above 800°F. (425°C.), the steels containing approximately 90 per cent martensite as quenched may have relatively high combinations of strength with ductility and toughness. However, the non-martensitic constituent is usually ferrite, and, if so, the fatigue strength is likely to be low. Thus the apparent advantage of submartensitic structures is questionable. Further, it is virtually impossible to design a useful steel article of a sufficiently uniform section, to purchase steel of sufficiently accurately controlled hardenability, or to control the quenching rate closely enough to take advantage of whatever benefit might be derived from this submartensitic structure.

In spite of the desirability of selecting steels that will harden fully, there are many applications in which the need of maximum properties has not been demonstrated. These require only a certain amount of tensile strength to carry the applied loads with enough yield strength to withstand occasional overloads, enough fatigue strength to stand

the repeated loading imposed, and adequate toughness to avoid premature or abrupt failure and to provide a "cushion" permitting full development of the strength properties. Of these strength-dependent properties impact strength seems to be the most critical one, and it is considered to be the basic quality that is essential to serviceability for a number of applications. This may seem arbitrary and academic, but the predictions using this conception agree surprisingly well with common usage based on experience.

10.4. Factors Affecting Hot Working

A thorough survey of the factors involved in securing the desired mechanical properties is only one phase in the selection of a satisfactory steel for a specific application. It is also usually necessary to forge, machine, and heat treat the article in an economical manner. This is a vague and abstruse problem that at present defies quantitative solution; it is, therefore, only possible to note a few of the points that should be considered. Fortunately, there is a wealth of experience available in using the common carbon and low-alloy engineering steels in the design of machine parts and, unless the specified composition is abnormal or the design is extremely unconventional, none of these materials should give unusual trouble in forging.

In hot working, the difference between the various low-alloy engineering steels is small. Most of them are slightly more difficult to roll or forge than carbon steels; for example, the resistance of 0.40 per cent carbon low-alloy steel to deformation at high temperatures is about the same as that of unalloyed steel containing 0.60 to 0.70 per cent carbon. In addition, and because of the increased stiffness caused by the alloying elements, more care is necessary in the case of the low-alloy steels than for carbon steels not to forge at temperatures below the critical temperatures or internal ruptures may result. In the low-alloy grades difficulty in forging increases a little with increase in carbon content.

The low-alloy steels differ considerably in their scaling characteristics; some, especially those containing molybdenum, scale freely and the scale drops off readily; others, especially those containing considerable nickel, scale freely but the scale is difficult to remove during rolling or forging. In general, however, none of the low-alloy steels are exceptionally difficult to work and the extra precautions necessary in heating, rolling, or forging, or in other hot-processing operations, are not an all-important factor in the final cost or quality.

The low-alloy steels also vary considerably in the extent to which they decarburize during heating for hot working. Decarburization is generally greater in steels containing nickel than in those containing

manganese, chromium, or relatively high silicon, but here again this is not a very important factor in final cost or quality.

10.5. Factors Affecting Machining

Machining is probably the most expensive operation in producing a finished steel part, and it is one of the most poorly understood. The work required to remove metal is of significant interest, and the difficulties of machining increase with hardness and strength more than with any other property. The ability to produce a cool broken chip and a smooth finish is usually of immediate concern, and these characteristics appear to be more sensitive than any others to the microstructure. Many heat-treating steels are made with a small amount of added sulphur to improve machinability and are benefited greatly even though the addition is small and the steel contains no more than 0.050 per cent sulphur.

Two types of structural conditions are preferred for machining low-alloy steels. In both cases a hardness of a little below 200 Brinell should be approached if possible. Much lower hardness is liable to result in tearing, and higher hardness requires slower speeds and results in short tool life. One desirable structure is a coarse pearlite and the other is a uniform distribution of fine spheroidal carbides. For most purposes the pearlitic type is preferred and is obtained by heating to a high normalizing temperature, transferring to a furnace at 1150 to 1300°F. (595 to 705°C.), depending on the type of steel, and holding at that temperature for several hours or until transformation is completed.

An isothermal anneal to produce pearlite is commonly used for carburizing steels and for some of the lower alloy, higher carbon steels. Higher alloy materials and particularly fine-grained steels and some nickel-containing steels may be heated within the critical range and transformed isothermally to produce a desirable spheroidized structure. Generally, the higher alloy steels (3 to 6 per cent total alloy content including manganese), regardless of carbon content, require such a long treatment that they are submitted to a spheroidizing treatment which is usually a normalize or quench followed by tempering at a high temperature. The isothermal annealing treatment must be executed carefully at the temperature determined by the type of steel. Grange⁶⁰ has shown that in cycle annealing to develop pearlite, some low-alloy steels tend to give a broken carbide structure rather than well-defined lamellar pearlite. Coarse grain size is helpful in avoiding this structure and chromium-containing steels seem to be relatively easy to control. Some steels, notably chromium-vanadium carburizing steel, develop a similar structure on normalizing. In the vanadium steel, which is

normally fine grained, the grain-coarsening temperature is low enough so that normalizing from about 1700 to 1800°F. (925 to 980°C.) is effective in developing coarse grain size and good machining characteristics. Soft, readily machinable structures are developed with difficulty in deep-hardening manganese steels containing additional alloying elements, and in steel of this type machinability is improved by lowering the manganese content and at the same time increasing the amounts of the other alloying elements.

While machining at high hardness levels is difficult, it cannot always be avoided. The uncarburized parts of deep-hardening carburizing steels can be finish-machined after hardening if the maximum carbon content is not over about 0.12 per cent and hardness is not more than about 40 Rockwell C. Vanadium in these steels tends to reduce the maximum hardness of the core to a significant degree. Higher alloy steels are machinable with difficulty up to levels of somewhat more than 400 Brinell. The chromium and molybdenum steels that tend to form bainite readily at subcritical cooling rates seem to machine more easily than those in which bainite formation is strongly repressed. Traces of martensite resulting from microsegregation add disproportionately to machining difficulties. Boron is unusual in that it adds little or nothing to the hardness of unhardened steel, so that boron steel is relatively softer after annealing or normalizing than a conventionally alloyed steel of the same hardenability and may be machined that much more readily. This quality is of special value in low-carbon steel where boron is extremely powerful and where large amounts of alloying elements are required to obtain high hardenability.

10.6. Other Important Variables in Processing

In carburizing, there is a great difference among the commonly used low-alloy steels. In all carburizing it is generally true that the higher the carburizing temperature the higher is the carbon concentration in the case and the greater is the depth of case. Carbide-forming elements such as manganese, chromium, and molybdenum act in a manner similar to an increase of temperature, while nickel and silicon, which do not form carbides, tend to act in an opposite manner. The effects of the alloying elements, whether positive or negative, are additive so that carbon concentration and depth of case can be controlled by the composition as well as by the heating cycle. Fine grain size tends to reduce the depth of case. In some low-alloy steels, especially those containing nickel, retained austenite may be present in the case after quenching so that low hardness (55 Rockwell C) may result. This is usually harmful but is sometimes considered to be beneficial for heavy-duty

gears in which dimensional accuracy is not needed. The residual austenite may be transformed to martensite by a suitable subzero treatment.

In heating for hardening in oxidizing atmospheres, an inward diffusion of oxygen and an outward diffusion of the constituents of the steel result in decarburization and scaling. The presence of alloying elements affects the relative tendency to scaling and decarburization. Manganese and chromium tend to reduce decarburization, nickel tends to increase it, and variable tendencies have been observed with relatively high silicon and with molybdenum and vanadium. Generally, the effect of composition is quite small and unimportant as compared with the effects of even minor changes in the furnace atmosphere.

Residual stresses, distortion, and cracking during quenching are problems that are controlled to a greater extent by factors other than the steel composition, provided major groups of sensitive steels are recognized as such and are eliminated. Although distortion may be produced by poor support of the article in the furnace and by irregular heating, the bulk of the trouble results from the volume increase accompanying martensite formation during quenching. The volume change is greater at higher carbon contents, and the temperature of martensite formation is lower. Jaffe and Hollomon⁸⁴ have suggested that quench cracking is promoted by lower M_s temperatures. Nickel steels are considered to be less sensitive than others to distortion and cracking in quenching on account of their lower austenitizing temperatures, but silicon alloy steels are also relatively free from distortion. Mixed grain size and abnormality in structure are undesirable. Deoxidation practice is significant in carburizing steels,³² and characteristically dirty steels, especially those containing considerable manganese, tend to crack easily. Scott and Gray¹²⁵ reported that rolling direction had an influence on distortion. Grossmann⁶⁴ has shown that residual austenite and controlled tempering could have a material influence on volume changes, and it has been implied that residual stress can be controlled in a similar manner. The most obvious factor is that the quenching rate is of great importance. Cracking and warping are greatest with water, less with oil, still less when the steel is quenched in molten salts, and are minimized in martempering¹²⁸ by equalizing the distribution of temperature in the piece at a point just above the M_s temperature.

Weldability is a property that must be considered for many applications. It is a complex property and difficult to define. Much work has been done on the effect of carbon and the various alloying elements on weldability⁸ and on the properties of the welded section, so much in fact that it cannot be covered here even sketchily.

In general, any of the low-alloy steels can be welded without danger of cracking or warping and without prior or subsequent heat treatment if the carbon is low—not over 0.15 or 0.18 per cent—and if the steel is so shallow hardening that the rapid cooling in and adjacent to the weld does not produce any appreciable amount of martensite or hard bainite.

If the metal at and near the weld becomes hardened in welding, either because the carbon is too high or because the alloying elements present induce hardening at the cooling rate normal for the prevailing welding conditions, warping or cracking will occur unless the sections to be welded are preheated to 400 to 1000°F. (205 to 540°C.)—depending on the alloy content and the sensitivity of the steel—or unless they are subsequently reheated to relieve stresses or both preheating and stress relieving are employed.

10.7. General Principles for the Selection of Steel

The qualities affecting the serviceability of steel are all related to or dependent on carbon content, grain size, and hardenability. Under normal conditions, carbon content and grain size are controlled by the requirements of the application and processing methods. As far as the final tensile and related properties of the steel are concerned, any one of the common alloying elements may usually be substituted for another. If there are no specific conditions, the selection of the alloying elements to be used may be determined by cost, availability, or personal preference.

The process of determining the potentialities inherent in a given steel is simply a matter of making the calculations described in earlier chapters. The process of designing some definite article from a specific steel according to over-all requirements is a reversal of the scheme and may not be so simple. It can be assumed that the desired article has certain dimensions and that it will be quenched at a certain rate based on critical locations in the article where controlled properties will be required. If the required strength is low, the section is small, and service conditions are not severe, a steel that can be quenched in water might be selected. In this case, full hardenability is not expected or required, and a low-alloy steel will probably be adequate; but to avoid cracking in water quenching, the carbon content should not exceed about 0.35 per cent. If more severe conditions are imposed in service, and more hardness without cracking is required, it is necessary to quench in oil or molten salt. The carbon should be higher but probably not much over 0.50 per cent except for simple sections. With the carbon content and rate of cooling (the quenching medium) established, the calculating procedure may be started.

The required degree of hardening must be estimated from the severity of service. If maximum reliability is needed, the steel must be fully hardened in quenching and tempered at a temperature high enough to develop adequate ductility and toughness as well as whatever other properties are required. If the service is less severe, some compromise may be indicated. The degree of quality may be expressed as hardenability in terms of percentage of martensite or the difference between maximum potential hardness and estimated as-quenched hardness.

If the ideal critical diameter system is followed, the severity of quench and the bar diameter in Fig. 5.8 or 5.9 (pp. 94 and 95) may be used to estimate the ideal diameter needed. The desired percentage of martensite can be converted to ideal critical diameter for 50 per cent martensite by the Hodge and Orehoski^{73, 74} relation. Field's relation between ideal critical diameter and hardness (Fig. 7.1, p. 129) will give the quenched hardness, and Wellauer's¹³⁸ charts (Figs. 8.21 to 8.23, pp. 167 to 171) will indicate roughly the appropriate tempering temperature for the desired strength. If the indicated hardness or temperature is too low, it is obvious that a higher percentage of martensite and, therefore, a steel with higher carbon or a more highly alloyed steel with greater hardenability will be required to obtain the desired final hardness. When the necessary ideal critical diameter and the carbon content (and grain size) are known, it is possible to use Grossmann's method for calculating compositions that will give the desired ideal critical diameter. Instead of calculating a composition, however, it is much more desirable, and easier, to refer to published Jominy curves in order to select a steel.

If the Rockwell C addition method for calculation is followed, the difference between the potential maximum hardness for the selected carbon content and the desired as-quenched hardness at the appropriate cooling rate or Jominy depth may be utilized, together with the carbon content, to estimate the total alloy units from Figs. 7.4, 7.6, 7.7, and 7.8 (pp. 133 to 137). Reference to Fig. 9.14 (p. 200) will indicate whether the combination of as-quenched and final hardness will permit development of adequate toughness. With the total alloy units necessary the composition is selected and the tempering temperature may be calculated from as-quenched hardness and composition by Figs. 8.12 to 8.17 (pp. 160 to 164).

10.8. Selection of a Steel of Non-Standard Composition

In working out an alloy-steel composition, it is necessary to use a good deal of judgment. Manganese alone is commonly used in amounts up to about 2 per cent, but efforts to combine high manganese with other alloying elements in deep-hardening steels usually give trouble in

annealing, by quench cracking, through retained austenite, and occasionally by poor toughness and fatigue resistance. It may also be difficult to retain a fine grain size in steels containing relatively high manganese. The manganese content must usually be scaled down and other elements must be added; hence, in medium- and deep-hardening steels the manganese is held below 1 per cent for reasons other than hardenability considerations. Silicon is usually present in the amount of 0.25 to 0.35 per cent, but it has been used very successfully up to 1 per cent and at 2 per cent. However, hot shortness in rolling or forging may be developed if the steel contains between 1 and 2 per cent silicon. Nickel is commonly used up to 5 per cent, although poor surface quality and some difficulties in annealing may be encountered with high nickel percentages. Chromium is used up to somewhat over 1 per cent in open-hearth steels and at higher levels in electric-furnace steels. The limitation has been the ability of open-hearth steel to absorb the cold alloying metal, and the introduction of exothermic ferrochromium ladle-addition agents is helpful in producing higher chromium steels. Steels containing over 2 per cent chromium require relatively high quenching temperatures, and the same is true if more than 0.50 per cent molybdenum is present. Boron-treated steel should be used only when the steel is to be fully hardened in quenching, and it should be avoided for sections that are to be welded.

The relative cost of alloying elements in terms of hardenability is difficult to evaluate from the Grossmann multiplying factors. In the first place, the individual multiplying factors and the interrelation of alloying effects are still in question so that relative differences may be subject to considerable error. Hostetter⁸⁰ derived a method in which the cost of successive increments of each alloying element was evaluated by means of straight-line multiplying factors. Using the then current 1945 prices of \$0.13 per lb. of chromium, \$0.80 for molybdenum, and \$0.30 for nickel, and assuming recoveries of 80, 90, and 95 per cent, respectively, he estimated that chromium was cheaper than molybdenum up to 0.40 per cent chromium, and that chromium and molybdenum together would be cheaper than nickel up to 0.77 per cent chromium and 0.18 per cent molybdenum. Hostetter arbitrarily used a chromium factor that was designed to be low enough to compensate for some of the deficiencies of chromium-molybdenum steels. If the multiplying factors determined by Crafts and Lamont³⁶ are used in the Hostetter formula, chromium appears to be cheaper than molybdenum up to 1.5 per cent chromium. The application of this calculation demands more accurate factors than are now available, and the validity of the method is also thrown in doubt by the work of Kramer, Siegel, and Brooks⁹⁵ who found

that the Grossmann multiplying factors may possibly be most accurately expressed as curved lines.

Estimation of the cost of alloying elements is quite complex and, since the cost of the alloying element itself is sometimes only a minor part of the cost of the steel, it may bear little relation to the over-all price of the part. There are several schemes for calculation, but it is necessary to assume a complete cycle including the alloy content lost in the scrap. Because it is difficult to segregate scrap, some assumption has to be made of the amount recovered. It is not uncommon to assume that only half the amount of alloying elements in the scrap is recovered, and some purchasing of segregated scrap has been based on half of the price for the contained recoverable element. Such an assumption seems a little extreme, and it is assumed here that two-thirds of the scrap is segregated and the alloying element recovered. A shipped-product yield of 65 per cent is assumed. To make a ton of product it would then be necessary to make 3080 lb. of ingot, of which 2000 lb. will be shipped, 720 lb. will be segregated and recovered as alloy scrap, and 360 lb. will be lost. Recoveries in melting and refining may be assumed to be 95 per cent for virgin additions of molybdenum and nickel with complete recovery from segregated scrap, 85 per cent for virgin chromium with 30 per cent recoverable from segregated scrap, 70 per cent for virgin manganese with 20 per cent recoverable from segregated scrap, and 95 per cent for silicon with no recovery from scrap. In a continuous cycle the alloying element recovered from segregated scrap is retained, so that only the virgin addition is charged to the alloy cost. The iron in the ferroalloy is credited at \$30.00 per net ton. No allowance is made for residuals from other sources. The amount and cost of alloying addition necessary to produce 1 lb. per ton in the shipped product are

TABLE 10.1. Amount and Cost of Alloying Addition to Produce One Product Ton Containing One Pound of Alloying Elements

Alloying element	Amount (lb.) of				Cost (\$) of	
	Alloy in 3080-lb. ingot	Alloy recovered from 720 lb. of scrap	Virgin alloy in ingot	Virgin alloy addition	Alloy per lb. (net)	1 lb. of alloy per ton of product
Manganese, high carbon	1.54	0.07	1.47	2.10	0.075	0.158
Chromium, high carbon	1.54	0.11	1.43	1.68	0.150	0.252
Silicon, 50% Si ferrosilicon.....	1.54		1.54	1.62	0.063	0.102
Molybdenum.....	1.54	0.36	1.18	1.24	0.80	0.992
Nickel.....	1.54	0.36	1.18	1.24	0.35	0.434

shown in Table 10.1 where Eastern United States prices as of mid-1947 were used.

The relative cost of the alloying elements with respect to hardenability may be calculated directly by the addition method. The prices shown in Table 10.1 were used to estimate the cost of each alloying element per unit of Rockwell C hardness as indicated in Table 10.2. Obviously, on account of the martensite correction, the cost per actual Rockwell C number is too high, but the relative differences between alloying elements remain fixed in all conditions of heat treatment and at all levels of alloy content to which the addition method is applicable. In carburizing steels requiring low-carbon ferromanganese and ferrochromium, the comparable alloy costs per ton per Rockwell C unit would be \$0.54 and \$0.48, respectively.

TABLE 10.2. Relative Cost of Alloying Elements in Adding 1 Rockwell C Unit of As-Quenched Hardness

Alloying element	Amount per Rockwell C unit, per cent	Cost per ton per Rockwell C unit, \$	Relative cost, \$
Manganese	0.0645	0.204	1.00
Chromium	0.0667	0.336	1.65
Silicon	0.20	0.408	2.00
Molybdenum	0.027	0.536	2.63
Nickel	0.182	1.580	7.76

If the relative resistance to softening in tempering is considered, the cost of alloying under conditions in which the alloying elements exert their maximum effects is shown in Table 10.3. The last column shows the combined ratio of costs when both hardening and tempering are averaged with equal weight assigned to each. The costs for hardening in Table 10.2 would be more applicable in slightly tempered steel, and

TABLE 10.3. Relative Cost of Alloying Elements in Resisting Softening by 1 Rockwell C Unit during Tempering

Alloying element	Amount per Rockwell C unit, per cent	Cost per ton per Rockwell C unit, \$	Relative cost, \$	Combined relative cost, \$
Manganese	0.40	1.26	1.00	1.00
Chromium	0.19	0.96	0.76	0.88
Silicon	0.22	0.45	0.36	0.59
Molybdenum	0.06	1.19	0.94	1.18
Nickel	0.77	6.68	5.30	5.64

the costs for resisting tempering would be more significant in toughened steel. If both are equally significant, the minimum cost with respect to hardness would be achieved by adding successively silicon, chromium, manganese, molybdenum, and nickel as the hardenability increases and as the practical maximum for each element is reached.

10.9. Selection of a Steel of Standard Composition

Fortunately, it is not necessary to specify a new steel for every application as the standard SAE and AISI grades include a range of compositions that have been tested by the experience of many users and that are made in sufficient tonnage so that both producers and users are familiar with their characteristics. These steels with their composition ranges and hardenability-band limits are listed in Appendices I and II.

The structure-dependent properties of a specific heat-treated low-alloy steel—hardness, tensile properties (including yield strength and such ductility factors as elongation and reduction of area), endurance limit, and impact resistance—depend primarily on hardenability and grain size, but additional knowledge is necessary to indicate how much strength (and related properties) can reasonably be expected of a steel of definite composition. Such knowledge includes, for example, details of the particular conditions under which the steel is quenched and tempered, and because these conditions may vary widely, it is certainly unsafe to generalize too broadly about the relation between composition, thermal treatment, and properties, especially in regard to the various methods of calculating properties discussed elsewhere in this book.

Despite the possibility of generalizing too broadly and of misinterpreting the results such calculations have been made³² by the addition method for the tensile strength and Izod impact strength to be expected in SAE and AISI steels after quenching and tempering bars of various diameters. The lower third of the specified range of alloy content was used for 0.20 to 0.50 per cent carbon steels with No. 8 grain size, and residual amounts of 0.07 per cent chromium, 0.08 per cent nickel, and 0.02 per cent molybdenum were assumed to be present.

Also included were steels designated as 2Cr00 (0.75 per cent manganese, 0.25 per cent silicon, and 1.50 per cent chromium) and 3Cr00 (0.50 per cent manganese, 0.25 per cent silicon, 3.00 per cent chromium, and 0.50 per cent molybdenum). Because of inadequate information on the effect of zirconium on as-quenched hardness, the values given for X9100* were calculated from actual Jominy curves.⁶¹ Vanadium was

*The composition of X9100 is as follows: 0.50 to 0.75 per cent manganese, 0.60 to 0.90 per cent silicon, 0.50 to 0.65 per cent chromium, 0.10 to 0.20 per cent molybdenum, and 0.10 to 0.20 per cent zirconium.

assumed to have no effect on as-quenched hardness, and vanadium steels may have less strength as calculated than that actually attainable. The calculations were based on a quenching severity of $H=0.35$ for oil and $H=1.0$ for water at the centers of round bars. Tempering time was assumed to be one hour at temperature per inch of diameter. As-quenched hardness was estimated by the addition method,³⁷ and tempered hardness and tensile strength were calculated³⁸ for a minimum tempering temperature of 800°F. (425°C.). These hardness values were used to estimate Izod impact strength.

The results of the calculations are given in Tables 10.4, 10.5, and 10.6 in which the interrelation of impact strength, tensile strength, and section size is indicated. The bracket of tensile strength in which each steel was grouped was determined by the requirements that the maximum strength of the bracket and the indicated Izod impact strength could be obtained by tempering at 800°F. (425°C.) or higher. A tempering temperature of 800°F. was assumed to be the minimum for a reliable and consistent tempering treatment and, as the tensile-strength values approximate the maximum strength values attainable, the tables must be viewed with some reservation. The range of tensile strength in each bracket was chosen so that at a tensile strength over 140,000 lb. per sq. in., each bracket would correspond to a change of 10 ft-lb. in the Izod impact strength. Because the impact strength is less critical below 140,000 lb. per sq. in. tensile strength, the range of 15,000 lb. per sq. in. in each of the lower strength brackets was selected for convenience. The Izod levels of 30 ft-lb. average (10 ft-lb. minimum) in Table 10.4, 40 ft-lb. average (20 ft-lb. minimum) in Table 10.5, and 50 ft-lb. average (30 ft-lb. minimum) in Table 10.6 were selected for illustration because they appeared to be of the greatest interest.

The steels shown in the top group of each table are all limited by impact strength and are calculated to be tempered at temperatures higher than 800°F. in order to lower the strength to a level consistent with the desired impact strength. All of the steels shown below the heavy line running through each table had more than the indicated impact strength after tempering at 800°F., so that the tensile strength shown is the maximum attainable with an 800°F. minimum tempering temperature. Similarly, in the intermediate groups, the strength of some of the steels was lowered for the sake of satisfactory impact strength while others required no adjustment. The steels shown in the highest group represent types that are essentially martensitic after quenching and for which the probability of obtaining the anticipated impact strength is quite good. In the lower groups, below the heavy line in Table 10.4, the steels are not completely hardened during quenching,

TABLE 10.4. Calculated Tensile Strength of Fine-Grained Quenched and Tempered—800°F. (425°C.) Minimum—Steels with 30 ft.-lb. Average (10 ft.-lb. Minimum) Izod Impact Strength

Tensile strength, lb. per sq. in., after quenching in still oil (H = 0.35) or in still water (H = 1.0), depending on bar diameter	Designation of steels meeting the requirements in bar sizes of				
	1-in. diameter (H = 0.35) or 1½-in. diameter (H = 1.0)	2-in. diameter (H = 0.35) or 3-in. diameter (H = 1.0)	3-in. diameter (H = 0.35) or 4-in. diameter (H = 1.0)	4-in. diameter (H = 0.35) or 5-in. diameter (H = 1.0)	
170,000 to 190,000	3Cr20 3330 4330 3Cr30 3240 3340 4140 4340 X9140	4350 4650 8650 8750 X9150 9450 9850 2Cr50 3Cr50	3Cr20 4340 3Cr40 3330 3Cr30 3340	4350 9850 2Cr50 3Cr50	3Cr20 3330 3Cr30 3Cr20 3340 3Cr40 3Cr50
155,000 to 170,000	3320 9320 X9130 9830	8740 2Cr30 2350 2340 5150 8640 6150	3320 4330 4140 X9140	8650 8750 X9150 9450	4340 4350 9850 2Cr50
140,000 to 155,000	3230 1340 3140	4640 5140 6140	9320 9830 2Cr30	2350 4650 6150	3320 9840 3150 8650 8750 9450

125,000 to 140,000	9820 2Cr20	4130	8730 4040	X9130 1340 2340	3140	4640 8640 5150	9320 4330 X9130	9830 3240 8740	1350 2350 4650	4330 4140 X9140	2350 3150	3250 8750 9450
110,000 to 125,000	2520 3220 4320 4820 X9120	1330 2330 3130 4630	5130 6130 8630 9430 9740	3230 6140	9440	4050 9750	2Cr30 2340 4640	8640	4050 5150 6150	9320 X9130 9830	2Cr30 2340 3240 1350	4650 6150 8650
95,000 to 110,000	1320 4120 8620		8720 9920 4030	2520 4320 4820 X9120 9820	2Cr20 1330 2330 3130 4130 4630	8630 8730 4040 5140 9740	9820 2330 3230	1340 3140 5140	6140 9440 9750	3230 1340 3140 4640	6140 8640 8740	9440 4050 5150 9750
80,000 to 95,000	2320 3120	4620 5120 6120	9420 9730	1320 2320 3120 3220 4120	4620 8620 8720 9920	4030 5130 6130 9430 9730	2520 3220 4120 4320 4820 8720 X9120	9920 2Cr20 1330 3130 4130 4630	5130 6130 8630 8730 9430 4040 9740	2520 3220 4320 4820 X9120 9820 2Cr20	1330 2330 3130 4130 4630 5130	6130 8630 8730 9430 4040 5140 9740
65,000 to 80,000		4020 9720		4020 5120	6120	9420 9720	1320 2320 3120 4020	4620 5120 6120 8620	9420 9720 4030 9730	1320 2320 3120 4120	4620 5120 6120 8620 8720	9420 9920 4030 9730
50,000 to 65,000										4020		9720

TABLE 10.5. Calculated Tensile Strength of Fine-Grained Quenched and Tempered—800°F. (425°C.) Minimum—Steels with 40 ft.-lb. Average (20 ft.-lb. Minimum) Izod Impact Strength

Tensile strength, lb. per sq. in., after quenching in still oil (H = 0.35) or in still water (H = 1.0), depending on bar diameter	Designation of steels meeting the requirements in bar sizes of						
	1-in. diameter (H = 0.35) or 1½-in. diameter (H = 1.0)	2-in. diameter (H = 0.35) or 3-in. diameter (H = 1.0)	3-in. diameter (H = 0.35) or 4-in. diameter (H = 1.0)	4-in. diameter (H = 0.35) or 5-in. diameter (H = 1.0)			
155,000 to 170,000	3320 9320 3Cr20 3330 4330 3Cr30 3240 3340 4140 4340	4150 X9140 9840 4650 8650 3Cr40 8750 X9150 2350 9450 3150 9850 3250 2Cr50 3350 3Cr50	3320 3Cr20 3330 3Cr30 3340	3Cr40 3350 4350 9850 2Cr50 3Cr50	3Cr20 3330 3340	3Cr20 3330 3340 3350 3360 3370 3380 3390 3400 3410 3420 3430 3440 3450 3460 3470 3480 3490 3500 3510 3520 3530 3540 3550 3560 3570 3580 3590 3600 3610 3620 3630 3640 3650 3660 3670 3680 3690 3700 3710 3720 3730 3740 3750 3760 3770 3780 3790 3800 3810 3820 3830 3840 3850 3860 3870 3880 3890 3900 3910 3920 3930 3940 3950 3960 3970 3980 3990 4000 4010 4020 4030 4040 4050 4060 4070 4080 4090 4100 4110 4120 4130 4140 4150 4160 4170 4180 4190 4200 4210 4220 4230 4240 4250 4260 4270 4280 4290 4300 4310 4320 4330 4340 4350 4360 4370 4380 4390 4400 4410 4420 4430 4440 4450 4460 4470 4480 4490 4500 4510 4520 4530 4540 4550 4560 4570 4580 4590 4600 4610 4620 4630 4640 4650 4660 4670 4680 4690 4700 4710 4720 4730 4740 4750 4760 4770 4780 4790 4800 4810 4820 4830 4840 4850 4860 4870 4880 4890 4900 4910 4920 4930 4940 4950 4960 4970 4980 4990 5000	
140,000 to 155,000	3230 X9130 9830 2Cr30 1340	8740 9440 4050 5150 6150 8640	9320 4330 9830 2Cr30 3240 4140 8740	X9140 9840 2Cr40 1350 2350 3150 3150	3250 4150 X9150 9450 2Cr40 9850 2Cr50 3250 4150 X9150 9450	3320 4340 9840 2Cr40 9840 2Cr50 3250 4150 X9150 9450	3320 4340 9840 2Cr40 9840 2Cr50 3250 4150 X9150 9450

FACTORS IN STEEL SELECTION

125,000 to 140,000	9820 4130 4040 2Cr20 8730 9750	X9130 2340 8640 3140 3140 6150 1340 4640	9320 3240 3150 4330 4140 4650 X9130 X9140 8650 9830 2350 8750	4330 4150 2350 X9150
110,000 to 125,000	2520 1330 5130 3220 2330 6130 4320 3130 8630 4820 4630 9430 X9120 4630 9740	3230 4050 6140 5150 9440 9750	2Cr30 8740 2340 1350 4640 5150 8640 6150	3240 4650 4140 6150 X9140 8650 1350 8750 3150 9450 3250
95,000 to 110,000	1320 8720 4120 9920 8620 4030	2Cr20 8630 1330 8730 2330 4040 4820 3130 5140 X9120 4130 9740 9820 4630	9820 5140 2330 6140 3230 9440 1340 4050 3140 9750	3230 9440 1340 4050 3140 5150 4640 9750
80,000 to 95,000	2320 4620 9420 3120 5120 9730 3120 6120	1320 4030 2320 4620 5130 3120 6130 8630 3220 8720 9430 4120 9920 9730	2520 9920 5130 3220 6130 8630 4120 1330 8630 4320 4820 3130 8730 X9120 4130 4040 9820 4630 5140 2Cr20 5130 9740	6130 8630 8730 9430 4040 5140 9740
65,000 to 80,000	4020 9720	4020 6120 9420 5120 9720	1320 4620 9420 2320 5120 9720 3120 6120 4030 4020 8620 9730	4620 9420 5120 9920 6120 4030 8620 9730
50,000 to 65,000			4020	9720

TABLE 10.6. Calculated Tensile Strength of Fine-Grained Quenched and Tempered—800°F. (425°C.) Minimum—Steels with 50 ft.-lb. Average (30 ft.-lb. Minimum) Izod Impact Strength

Tensile strength, lb. per sq. in., after quenching in still oil (H = 0.35) or in still water (H = 1.0), depending on bar diameter	Designation of steels meeting the requirements in bar sizes of				
	1-in. diameter (H = 0.35) or 1½-in. diameter (H = 1.0)	2-in. diameter (H = 0.35) or 3-in. diameter (H = 1.0)	3-in. diameter (H = 0.35) or 4-in. diameter (H = 1.0)	4-in. diameter (H = 0.35) or 5-in. diameter (H = 1.0)	
140,000 to 155,000	3320	4150			
	X9140	4350			
	9320	9840			
	3Cr20	4650	3320		
	3330	8650	3Cr40		3Cr40
	4330	8750	3330		3330
	3Cr30	1350	3Cr30		3340
	3240	2350	9850		3Cr50
	3340	3150	9850		
	4140	3250	2Cr50		
4340	3350	3Cr50			
125,000 to 140,000	9820	6140	4140		
	2Cr20	1340	9320	3250	
	3230	2340	4330	4340	3250
	4130	3140	X9140	X9140	4150
	8730	4040	9830	9840	X9150
	X9130	4640	2Cr40	9840	4330
	9830	5140	2Cr30	2Cr40	X9130
			1350	8750	9450
			2340	X9150	9850
			3240	9450	2Cr50

110,000 to 125,000	2520 3220 4320 4820 X9120	1330 2330 3130 4630 5130	6130 8630 9430 9740 9750	3230 4640 6140 8640 3140	9440 5150 6150	2Cr30 2340 3240	8740 4650 1350 3150 8750	9820 X9130 9830 2Cr30	2340 3240 4140 X9140 2350	3250 4150 8750 9450
95,000 to 110,000	1320 4120 8620	8720 9920 4030	2520 4320 4820 X9120 9820 2Cr20	1330 2330 3130 4130 4630 8630	8730 4040 5140 9740 4050 9750	9820 2330 3230 1340 3140	9440 4640 5140 6140 8640 9750	1340 3140 8640 8740	9440 1350 3150	4650 5150 6150 8650
80,000 to 95,000	2320 3120	4620 5120 6120	1320 2320 3120 3220 4120	4620 8620 8720 9920 4120	4030 5130 6130 9430 9730	2520 3220 4120 4320 4820 X9120	9920 2Cr20 1330 3130 4130 4630 9740	2520 3220 4320 4820 X9120 9820 2Cr20 1330	2330 3130 3230 4130 4630 5130 6130 8630 8730	9430 4040 4640 5140 6140 9740 4050 9750
65,000 to 80,000		4020 9720	4020 5120	6120	9420 9720	1320 2320 3120 4020	4620 5120 6120 8620 9730	1320 2320 3120 4120	4620 5120 6120 8620 8720	9420 9920 4030 9730
50,000 to 65,000								4020	9720	

232 . **HARDENABILITY AND STEEL SELECTION**

and the possibility of less than anticipated toughness is greater. General experience has indicated that incompletely hardened steels may be erratic in ductility and toughness, and predictions of impact strength for steels below the heavy line should be applied with some reservations.

The steels shown in Tables 10.4 to 10.6 may be classified according to their relative capacity for developing tensile strength and impact resistance in approximately equivalent groups at graduated levels; this classification is given in Table 10.7. Obviously, this grouping does not take into consideration factors such as abnormal composition, sensitivity to temper brittleness, tendency toward segregation, directional effects, inclusions, abnormal structure after heat treatment, difficulty of holding fine grain sizes, and difficulty of securing complete austenitization.

TABLE 10.7. Relative Classification of Steels According to Tensile Strength and Impact Resistance

<i>Group</i>	<i>Type of steel</i>
1	3Cr00
2	3300
3	4300 (except 4320), 9320
4	9800, 2Cr00
5	4100 (except 4120, 4130), X9100
6	2520, 3200, 4320, 4820
7	2300, 4120, 4130, 8700, 9450, 9920
8	1300, 3100, 4600, 5147, 5152, 8600
9	5100 (except 5147, 5152), 6100, 9400 (except 9450)
10	4000, 9700

Although it has been indicated in previous paragraphs that many characteristics of steels, and particularly those that are important in processing the steel, may vary widely with composition, most of the standard steels have been found to be readily fabricated by normal methods. In this group of steels, it is possible, therefore, to apply the theory of substitution of alloying elements with more confidence than in the case of untried compositions. For this reason the costs of fabrication for different steels of a given degree of hardenability might be expected to vary less widely and a comparison of costs is of more practical value. Since the price of the steels is published and the approximate properties are estimated in the tables, a simple appraisal of cost can be made. Such an evaluation based on prices current in early 1947 is shown in Table 10.8. It is evident that in the low hardenability ranges SAE 1300 is relatively cheap according to calculation and that, if its deficiencies cannot be tolerated, SAE 5140 and 8640 would be the least expensive alternatives. In intermediate ranges, SAE 4100 is relatively economical, and at higher levels the prices of the triple-alloy

TABLE 10.8. Classification of Low-Alloy Steels (0.40 per cent Carbon) According to Price and According to Strength for an Average Izod Impact Value of 30 ft.-lb. (Table 10.4)

Tensile strength, lb. per sq. in., after quenching in still oil (H=0.35)	Designation of steels meeting the requirements in bar sizes of the following diameters			
	1 in.	2 in.	3 in.	4 in.
170,000 to 190,000	4140 9840 4340	4340		
155,000 to 170,000	8640 8740 2340	4140 9840	9840 4340	4340
140,000 to 155,000	1340 5140 3140 4640 6140	8740	4140	9840
125,000 to 140,000	4040	1340 8640 3140 4640 2340	8740	4140
110,000 to 125,000		6140	8640 4640 2340	2340
95,000 to 110,000		5140 4040	1340 5140 3140 6140	1340 8640 8740 3140 4640 6140
80,000 to 95,000			4040	5140 4040

Price (1947) per pound of steel

Steel	Price, ¢	Steel	Price, ¢	Steel	Price, ¢
1340	3.55	4140	3.95	6140	4.65
5140	3.55	8740	4.05	4640	4.70
4040	3.70	3140	4.20	4340	4.95
8640	3.95	9840	4.60	2340	5.40

SAE 4300 and 9800 steels are not disproportionate to their capacity to develop strength and toughness. Other steels must obviously have other values and advantages that outweigh hardenability considerations in order to justify their use.

10.10. Summary

It has been shown that methods have been developed for calculating all of the primary factors essential to the selection and heat treatment of steel. Selection requires first an appraisal of the service requirements and interpretation into tangible mechanical properties. The most important property is tensile strength. Other qualities, such as yield strength, ductility, and toughness are related to tensile strength by hardenability. Estimation of the composition and heat treatment required to develop the desired tensile strength is accomplished by a series of simple calculations. It is possible by more or less mechanical calculation to arrive at a group of steels having similar qualities from which the choice is to be made. Further selection may be made by eliminating the steels that tend to give undue trouble in processing.

If all of the tangible factors have been properly evaluated, the final selection is primarily dependent on the cost of the steel. In general, the cost of the most economical steels is proportional to hardenability or tensile strength attainable with toughness and to the amount and kind of alloying element used. In spite of the wide variety of available steels only one or two are outstandingly economical at each strength level. These compositions generally reflect the lower cost of manganese and chromium. Molybdenum and nickel are introduced in steels for use at high strength levels as the useful ceiling of the less expensive elements is approached and if exceptional properties are desired. The selection of steel costing more than the minimum per unit of hardenability must depend on factors that are not evaluated in the hardenability calculation. In almost all cases it is possible to draw on a background of experience pertaining to the performance of certain steels in similar applications, so that the calculations may be used on a comparative rather than on an absolute basis with much greater assurance of reliability.

APPENDICES

APPENDIX I*

Composition Limits of H Steels

TABLE 1. H Steels—Chemical Composition Ranges—Electric-Furnace or Open-Hearth Steels—Bars, Billets, Blooms. The ranges and limits in this table apply only to material not exceeding 200 sq. in. in cross-sectional area, or 18 in. in width, or 10,000 lb. in weight, per piece.

Steel designation, SAE or AISI	Chemical composition, per cent					
	C	Mn	Si	Ni	Cr	Mo
1320H	0.17-0.24	1.50-2.00	0.20-0.35			
1330H	0.27-0.34	1.50-2.00	0.20-0.35			
1335H	0.32-0.39	1.50-2.00	0.20-0.35			
1340H	0.37-0.45	1.50-2.00	0.20-0.35			
2512H	0.08-0.15	0.35-0.65	0.20-0.35	4.70-5.30		
2515H	0.11-0.18	0.35-0.65	0.20-0.35	4.70-5.30		
2517H	0.14-0.21	0.35-0.65	0.20-0.35	4.70-5.30		
3310H	0.07-0.14	0.35-0.65	0.20-0.35	3.20-3.80	1.35-1.75	
3316H	0.13-0.20	0.35-0.65	0.20-0.35	3.20-3.80	1.35-1.75	
4130H	0.27-0.34	0.35-0.65	0.20-0.35		0.80-1.15	0.15-0.25
4132H	0.30-0.37	0.35-0.65	0.20-0.35		0.80-1.15	0.15-0.25
4135H	0.32-0.39	0.60-0.95	0.20-0.35		0.80-1.15	0.15-0.25
4137H	0.35-0.43	0.60-0.95	0.20-0.35		0.80-1.15	0.15-0.25
4140H	0.37-0.45	0.70-1.05	0.20-0.35		0.80-1.15	0.15-0.25
4142H	0.40-0.48	0.70-1.05	0.20-0.35		0.80-1.15	0.15-0.25
4145H	0.42-0.50	0.70-1.05	0.20-0.35		0.80-1.15	0.15-0.25
4147H	0.44-0.52	0.70-1.05	0.20-0.35		0.80-1.15	0.15-0.25
4150H	0.46-0.54	0.70-1.05	0.20-0.35		0.80-1.15	0.15-0.25
4317H	0.14-0.21	0.40-0.70	0.20-0.35	1.50-2.00	0.35-0.65	0.20-0.30
4320H	0.16-0.23	0.40-0.70	0.20-0.35	1.50-2.00	0.35-0.65	0.20-0.30
4340H	0.37-0.45	0.60-0.95	0.20-0.35	1.50-2.00	0.65-0.95	0.20-0.30

*Data in Appendix I by courtesy of The Society of Automotive Engineers and American Iron and Steel Institute.¹³³

APPENDICES

TABLE 1. (Continued)

Steel designation, SAE or AISI	Chemical composition, per cent					
	C	Mn	Si	Ni	Cr	Mo
4620H	0.17-0.24	0.40-0.70	0.20-0.35	1.50-2.00		0.20-0.30
4640H	0.37-0.45	0.55-0.85	0.20-0.35	1.50-2.00		0.20-0.30
4812H	0.10-0.17	0.30-0.60	0.20-0.35	3.20-3.80		0.20-0.30
4815H	0.12-0.19	0.35-0.65	0.20-0.35	3.20-3.80		0.20-0.30
4817H	0.14-0.21	0.35-0.65	0.20-0.35	3.20-3.80		0.20-0.30
4820H	0.17-0.24	0.45-0.75	0.20-0.35	3.20-3.80		0.20-0.30
5140H	0.37-0.45	0.60-0.95	0.20-0.35		0.65-0.95	
5145H	0.42-0.50	0.60-0.95	0.20-0.35		0.65-0.95	
5150H	0.46-0.54	0.60-0.95	0.20-0.35		0.65-0.95	
6150H	0.46-0.54	0.60-0.95	0.20-0.35		0.80-1.15	(0.15 min. V)
8617H	0.14-0.21	0.60-0.95	0.20-0.35	0.35-0.75	0.35-0.65	0.15-0.25
8620H	0.17-0.24	0.60-0.95	0.20-0.35	0.35-0.75	0.35-0.65	0.15-0.25
8622H	0.20-0.27	0.60-0.95	0.20-0.35	0.35-0.75	0.35-0.65	0.15-0.25
8625H	0.22-0.29	0.60-0.95	0.20-0.35	0.35-0.75	0.35-0.65	0.15-0.25
8627H	0.25-0.32	0.60-0.95	0.20-0.35	0.35-0.75	0.35-0.65	0.15-0.25
8630H	0.27-0.34	0.60-0.95	0.20-0.35	0.35-0.75	0.35-0.65	0.15-0.25
8632H	0.30-0.37	0.60-0.95	0.20-0.35	0.35-0.75	0.35-0.65	0.15-0.25
8635H	0.32-0.39	0.70-1.05	0.20-0.35	0.35-0.75	0.35-0.65	0.15-0.25
8637H	0.35-0.43	0.70-1.05	0.20-0.35	0.35-0.75	0.35-0.65	0.15-0.25
8640H	0.37-0.45	0.70-1.05	0.20-0.35	0.35-0.75	0.35-0.65	0.15-0.25
8641H*	0.37-0.45	0.70-1.05	0.20-0.35	0.35-0.75	0.35-0.65	0.15-0.25
8642H	0.40-0.48	0.70-1.05	0.20-0.35	0.35-0.75	0.35-0.65	0.15-0.25
8645H	0.42-0.50	0.70-1.05	0.20-0.35	0.35-0.75	0.35-0.65	0.15-0.25
8647H	0.44-0.52	0.70-1.05	0.20-0.35	0.35-0.75	0.35-0.65	0.15-0.25
8650H	0.46-0.54	0.70-1.05	0.20-0.35	0.35-0.75	0.35-0.65	0.15-0.25
8655H	0.50-0.60	0.70-1.05	0.20-0.35	0.35-0.75	0.35-0.65	0.15-0.25
8660H	0.55-0.65	0.70-1.05	0.20-0.35	0.35-0.75	0.35-0.65	0.15-0.25
8720H	0.17-0.24	0.60-0.95	0.20-0.35	0.35-0.75	0.35-0.65	0.20-0.30
8735H	0.32-0.39	0.70-1.05	0.20-0.35	0.35-0.75	0.35-0.65	0.20-0.30
8740H	0.37-0.45	0.70-1.05	0.20-0.35	0.35-0.75	0.35-0.65	0.20-0.30
8742H	0.40-0.48	0.70-1.05	0.20-0.35	0.35-0.75	0.35-0.65	0.20-0.30
8745H	0.42-0.50	0.70-1.05	0.20-0.35	0.35-0.75	0.35-0.65	0.20-0.30
8747H	0.44-0.52	0.70-1.05	0.20-0.35	0.35-0.75	0.35-0.65	0.20-0.30
8750H	0.46-0.54	0.70-1.05	0.20-0.35	0.35-0.75	0.35-0.65	0.20-0.30
9260H	0.55-0.65	0.70-1.05	1.80-2.20			
9261H	0.55-0.65	0.70-1.05	1.80-2.20		0.05-0.35	
9262H	0.55-0.65	0.70-1.05	1.80-2.20		0.20-0.50	
9437H	0.35-0.43	0.85-1.25	0.20-0.35	0.25-0.65	0.25-0.55	0.08-0.15
9440H	0.37-0.45	0.85-1.25	0.20-0.35	0.25-0.65	0.25-0.55	0.08-0.15
9442H	0.40-0.48	0.95-1.35	0.20-0.35	0.25-0.65	0.25-0.55	0.08-0.15
9445H	0.42-0.50	0.95-1.35	0.20-0.35	0.25-0.65	0.25-0.55	0.08-0.15

*Sulphur content 0.040-0.060 per cent.

NOTE 1. Phosphorus and sulphur on open-hearth steel to be 0.040 per cent max. each except where noted (*).

Phosphorus and sulphur on electric-furnace steel to be 0.025 per cent max. each except where noted (*).

Note 2. Small quantities of certain elements may be found in alloy steel which are not specified or required. These elements are to be considered as incidental and acceptable to the following maximum amounts: copper, 0.35 per cent; nickel, 0.25 per cent; chromium, 0.20 per cent; molybdenum, 0.06 per cent.

Note 3. The chemical ranges and limits shown in Table 1 are subject to the standard permissible variations for check analysis shown in Table 2.

TABLE 2. Standard Permissible Variations from Specified Chemical Ranges and Limits Applicable to H Steels—Electric-Furnace and Open-Hearth Steels

Elements	Limit, or maximum of specified range, per cent	Standard variation by size ranges as shown below: Per cent over maximum limit or under minimum limit	
		100 sq. in. or less	Over 100 to 200 sq. in.
Carbon	To 0.30 incl.	0.01	0.02
	Over 0.30 to 0.75 incl.	0.02	0.03
Manganese	To 0.90 incl.	0.03	0.04
	Over 0.90 to 2.10	0.04	0.05
Phosphorus	Over max. only	0.005	0.01
Sulphur	To 0.60 incl.	0.005	0.01
Silicon	To 0.35 incl.	0.02	0.02
	Over 0.35 to 2.20 incl.	0.05	0.06
Nickel	To 1.00 incl.	0.03	0.03
	Over 1.00 to 2.00 incl.	0.05	0.05
	Over 2.00 to 5.30 incl.	0.07	0.07
Chromium	To 0.90 incl.	0.03	0.04
	Over 0.90 to 2.10 incl.	0.05	0.06
Molybdenum	To 0.20 incl.	0.01	0.01
	Over 0.20 to 0.40 incl.	0.02	0.03
Vanadium	Min. value only specified Check under spec.	0.01	0.01

APPENDIX II*

End-Quench Hardenability Bands

TABLE 1. Tabulation of Band Limits for Steels Containing 0.12 to 0.16 Per Cent Carbon

Jominy distance		2512		2515		3316		4812		4815	
		Rockwell C		Rockwell C		Rockwell C		Rockwell C		Rockwell C	
Inches	Sixteenths of an inch	Max.	Min.	Max.	Min.	Max.	Min.	Max.	Min.	Max.	Min.
		$\frac{1}{16}$	1	43.0	36.5	44.5	37.5	47.5	40.0	43.5	37.0
$\frac{1}{8}$	2	43.0	33.5	44.5	36.0	47.0	39.0	43.0	33.0	44.5	37.0
$\frac{3}{16}$	3	42.0	30.0	44.0	33.0	47.0	38.0	42.0	29.5	44.0	34.0
$\frac{1}{4}$	4	41.0	26.5	43.0	29.0	46.0	37.0	41.0	26.5	43.0	30.0
$\frac{5}{16}$	5	40.0	23.0	42.0	26.0	45.5	35.5	39.5	24.5	41.5	27.0
$\frac{3}{8}$	6	38.5	21.0	41.0	23.0	45.0	34.5	38.0	22.5	40.0	25.5
$\frac{7}{16}$	7	36.5		39.5	21.0	44.5	33.5	37.0	21.0	38.5	24.0
$\frac{1}{2}$	8	35.0		38.0		44.0	32.5	35.0	20.0	37.5	22.5
$\frac{9}{16}$	9	33.5		36.0		43.5	32.0	33.5		36.0	21.0
$\frac{5}{8}$	10	32.0		34.5		43.0	31.5	32.0		34.5	20.5
$\frac{11}{16}$	11	30.5		33.0		43.0	31.0	30.5		33.0	20.0
$\frac{3}{4}$	12	29.5		32.0		42.5	30.5	29.0		31.0	
$\frac{13}{16}$	13	28.0		30.5		42.0	30.0	28.0		30.0	
$\frac{7}{8}$	14	27.0		29.5		41.5	30.0	27.0		29.0	
$\frac{15}{16}$	15	26.5		28.5		41.0	29.5	26.0		28.5	
1	16	25.5		28.0		40.5	29.5	25.5		28.0	
$1\frac{1}{8}$	18	24.0		26.5		40.0	29.0	24.5		27.0	
$1\frac{1}{4}$	20	23.0		26.0		39.5	28.5	24.0		26.5	
$1\frac{3}{8}$	22	22.0		25.0		39.0	28.5	23.5		25.5	
$1\frac{1}{2}$	24	21.5		24.0		39.0	28.5	23.0		25.5	
$1\frac{5}{8}$	26	21.0		23.5		39.0	28.5	23.0		25.0	
$1\frac{3}{4}$	28	20.5		23.0		39.0	28.5	22.5		25.0	
$1\frac{7}{8}$	30	20.0		23.0		38.5	28.5	22.5		24.5	
2	32	20.0		23.0		38.5	28.5	22.5		24.0	

*Data in Appendix II by courtesy of The Society of Automotive Engineers and American Iron and Steel Institute.¹³³

TABLE 2. Tabulation of Band Limits for Steels Containing 0.20 Per Cent Carbon

Jominy distance		1320		4320		4620		4820		8620		8720	
Inches	Six- teenths of an inch	Rockwell C		Rockwell C		Rockwell C		Rockwell C		Rockwell C		Rockwell C	
		Max.	Min.	Max.	Min.	Max.	Min.	Max.	Min.	Max.	Min.	Max.	Min.
$\frac{1}{16}$	1	48.0	40.5	49.0	41.5	48.0	40.5	48.0	40.5	48.0	40.5	48.0	40.5
	2	47.5	37.0	48.0	38.5	45.5	31.0	47.5	39.5	46.5	35.0	46.5	35.5
	$\frac{3}{16}$	46.5	33.0	46.5	34.0	43.0	26.0	47.0	37.5	44.0	30.0	44.5	29.0
	$\frac{1}{4}$	45.0	28.5	44.5	31.0	39.0	22.0	46.0	35.0	41.0	26.5	41.5	25.5
$\frac{5}{16}$	5	42.5	24.0	42.0	29.0	35.5	20.0	45.0	32.0	37.0	23.5	38.0	23.5
	$\frac{3}{8}$	39.0	20.5	40.0	27.0	33.0		43.5	30.0	34.5	21.0	36.0	22.0
	$\frac{7}{16}$	36.0		37.5	25.0	31.0		42.5	28.0	32.5		34.0	21.0
	$\frac{1}{2}$	33.5		35.5	24.0	29.5		41.0	26.5	31.0		33.0	20.5
$\frac{9}{16}$	9	31.5		34.0	22.5	28.0		39.0	25.5	29.5		31.5	
	$\frac{5}{8}$	30.0		32.5	21.5	27.5		37.5	24.5	28.5		30.0	
	$\frac{11}{16}$	29.0		31.0	20.5	26.5		36.0	23.5	28.0		29.5	
	$\frac{3}{4}$	28.0		30.0	20.0	26.0		34.5	23.0	27.0		28.5	
1	$\frac{13}{16}$	27.5		29.5		25.5		33.5	22.0	26.0		28.0	
	$\frac{7}{8}$	27.0		29.0		25.0		32.5	21.5	25.5		27.0	
	$\frac{15}{16}$	26.5		28.0		24.5		31.5	21.0	25.0		26.5	
	1	26.0		27.5		24.0		31.0	20.5	24.5		26.5	
$1\frac{1}{8}$	18	25.0		27.0		23.5		30.0	20.0	24.0		25.5	
	$1\frac{1}{4}$	24.0		26.5		23.0		29.0		23.0		25.0	
	$1\frac{3}{8}$	23.5		26.0		22.5		28.5		23.0		24.5	
	$1\frac{1}{2}$	23.0		26.0		22.5		28.0		22.5		24.0	
$1\frac{5}{8}$	26	22.5		25.5		22.0		27.5		22.0		23.5	
	$1\frac{3}{4}$	22.0		25.5		22.0		27.0		22.0		23.5	
	$1\frac{7}{8}$	21.5		25.5		22.0		27.0		22.0		23.5	
	2	21.0		25.5		22.0		26.5		22.0		23.5	

TABLE 3. Tabulation of Band Limits for Steels Containing 0.30 Per Cent Carbon

Jominy distance		1330		4130		4132		8630		8632	
Inches	Sixteenths of an inch	Rockwell C		Rockwell C		Rockwell C		Rockwell C		Rockwell C	
		Max.	Min.	Max.	Min.	Max.	Min.	Max.	Min.	Max.	Min.
$\frac{1}{16}$	1	54.0	46.5	54.0	46.5	55.5	48.0	54.0	46.5	55.5	48.0
$\frac{1}{8}$	2	53.5	44.5	54.0	45.0	55.0	46.0	54.0	45.0	55.5	47.0
$\frac{3}{16}$	3	53.0	42.0	53.0	42.0	54.5	43.5	53.5	42.5	55.0	45.0
$\frac{1}{4}$	4	52.0	38.0	52.0	39.0	53.5	40.5	52.0	39.0	54.0	42.0
$\frac{5}{16}$	5	50.5	33.5	50.5	36.0	52.0	37.5	50.5	35.5	52.5	38.5
$\frac{3}{8}$	6	49.0	29.5	48.0	33.5	50.5	35.5	48.0	33.0	50.5	35.5
$\frac{7}{16}$	7	47.5	27.0	45.0	31.5	48.5	33.5	45.0	30.5	48.0	33.0
$\frac{1}{2}$	8	45.0	25.0	43.0	30.0	46.5	32.0	42.5	29.0	45.5	31.0
$\frac{9}{16}$	9	43.0	23.0	41.5	28.5	44.5	31.0	40.5	27.5	43.5	29.0
$\frac{5}{8}$	10	40.0	21.5	40.0	27.5	43.0	29.5	39.0	26.0	42.0	28.0
$\frac{11}{16}$	11	38.0	21.0	38.5	26.5	42.0	29.0	37.5	25.0	40.5	27.0
$\frac{3}{4}$	12	37.0	20.0	37.5	26.0	40.5	28.0	36.5	24.5	39.0	26.0
$\frac{13}{16}$	13	36.0		36.0	25.0	39.5	27.0	35.0	23.5	38.0	25.0
$\frac{7}{8}$	14	35.0		35.0	24.0	39.0	26.5	34.5	23.0	37.0	24.5
$\frac{15}{16}$	15	34.5		34.5	23.5	38.0	26.0	33.5	22.0	36.5	23.5
1	16	34.0		33.5	23.0	37.5	25.0	33.0	22.0	35.5	23.0
$1\frac{1}{8}$	18	33.0		32.5	22.0	36.0	24.0	32.0	21.0	34.5	22.0
$1\frac{1}{4}$	20	32.0		31.5	21.0	35.5	23.0	31.0	20.5	33.5	21.5
$1\frac{3}{8}$	22	31.5		31.0	20.5	35.0	22.5	30.5	20.0	33.0	21.0
$1\frac{1}{2}$	24	31.0		30.5	20.0	34.0	22.0	30.0		32.5	20.5
$1\frac{5}{8}$	26	30.0		30.0		34.0	21.0	29.5		32.0	20.0
$1\frac{3}{4}$	28	30.0		30.0		34.0	20.5	29.5		32.0	20.0
$1\frac{7}{8}$	30	29.5		29.5		34.0	20.5	29.0		31.5	
2	32	29.0		29.5		34.0	20.0	29.0		31.5	

TABLE 4. Tabulation of Band Limits for Steels Containing 0.35 Per Cent Carbon

Jominy distance		1335		4135		8635		8735		9437	
Inches	Sixteenths of an inch	Rockwell C		Rockwell C		Rockwell C		Rockwell C		Rockwell C	
		Max.	Min.	Max.	Min.	Max.	Min.	Max.	Min.	Max.	Min.
$\frac{1}{16}$	1	57.0	49.5	57.0	50.0	57.0	49.5	57.0	49.5	58.5	51.5
$\frac{1}{8}$	2	57.0	48.0	57.0	49.0	57.0	48.5	57.0	48.5	58.5	49.5
$\frac{3}{16}$	3	56.5	46.0	57.0	48.0	57.0	47.0	56.5	47.5	58.0	47.0
$\frac{1}{4}$	4	56.0	41.5	56.5	46.0	56.0	44.5	56.0	45.5	57.5	43.5
$\frac{5}{16}$	5	55.0	36.0	55.5	44.5	55.0	42.0	55.0	43.5	56.5	40.0
$\frac{3}{8}$	6	53.5	32.0	54.5	42.0	53.0	38.0	53.5	41.0	55.5	37.5
$\frac{7}{16}$	7	51.0	29.0	53.5	39.5	51.0	35.5	52.0	38.5	54.5	35.0
$\frac{1}{2}$	8	49.0	27.0	52.0	37.5	48.0	33.5	50.0	36.0	53.0	33.0
$\frac{9}{16}$	9	47.0	25.0	51.0	35.5	46.0	31.5	48.0	34.0	51.5	31.5
$\frac{5}{8}$	10	45.0	24.0	49.5	34.0	44.5	30.0	47.0	32.0	49.5	30.0
$\frac{11}{16}$	11	43.0	23.0	48.5	32.0	43.0	28.5	45.5	31.0	48.0	28.5
$\frac{3}{4}$	12	42.0	22.0	47.5	31.0	42.0	27.5	44.5	29.5	47.0	27.5
$\frac{13}{16}$	13	40.5	21.0	46.5	30.5	40.5	26.5	43.0	28.5	45.5	26.5
$\frac{7}{8}$	14	39.5	20.5	45.5	29.5	39.5	26.0	42.5	28.0	44.5	26.0
$\frac{15}{16}$	15	39.0	20.0	45.0	29.0	39.0	25.0	41.5	27.0	43.5	25.0
1	16	38.0		44.0	28.5	38.0	24.5	41.0	26.5	43.0	24.0
$1\frac{1}{8}$	18	36.5		43.0	28.0	37.0	24.0	39.5	25.5	42.0	23.0
$1\frac{1}{4}$	20	35.0		42.0	27.5	36.0	23.0	38.5	24.5	41.0	22.0
$1\frac{3}{8}$	22	34.5		41.5	27.0	35.0	22.5	38.0	24.0	40.0	21.5
$1\frac{1}{2}$	24	34.0		41.0	26.5	34.5	22.0	37.5	23.5	39.0	21.0
$1\frac{5}{8}$	26	33.5		40.5	26.0	34.0	21.5	37.0	23.0	38.5	21.0
$1\frac{3}{4}$	28	33.0		40.0	26.0	33.5	21.5	36.5	23.0	38.0	20.5
$1\frac{7}{8}$	30	32.5		40.0	25.5	33.0	21.0	36.0	22.5	38.0	20.5
2	32	32.0		39.5	25.5	33.0	21.0	36.0	22.5	37.5	20.5

TABLE 5. Tabulation of Band Limits for Steels Containing 0.40 Per Cent Carbon

Jominy distance		1340		3140		4140		4340		4640		5140		8640		8740		9440	
		Rockwell C		Rockwell C		Rockwell C		Rockwell C		Rockwell C		Rockwell C		Rockwell C		Rockwell C		Rockwell C	
Inches	Sixteenths of an inch	Max.	Min.	Max.	Min.	Max.	Min.	Max.	Min.	Max.	Min.	Max.	Min.	Max.	Min.	Max.	Min.	Max.	Min.
		$\frac{1}{16}$	1	60.0	52.5	60.0	52.5	60.0	52.5	60.0	52.5	60.0	52.5	60.0	52.5	60.0	52.5	60.0	52.5
$\frac{1}{8}$	2	60.0	51.5	59.5	51.5	60.0	52.5	60.0	52.5	60.0	51.5	59.5	52.0	60.0	51.5	60.0	51.0	60.0	51.0
$\frac{3}{16}$	3	59.5	49.5	59.0	50.0	60.0	52.5	60.0	52.5	59.5	50.5	59.0	50.0	60.0	50.0	60.0	51.0	60.0	49.0
$\frac{1}{4}$	4	59.0	47.0	58.5	49.0	59.5	50.0	60.0	52.5	59.0	49.0	58.0	47.0	59.0	48.5	59.0	49.5	59.5	46.5
$\frac{5}{16}$	5	58.5	43.0	58.0	47.5	59.0	48.5	60.0	52.5	57.5	46.0	57.0	42.0	58.5	46.0	58.5	47.5	58.5	43.0
$\frac{3}{8}$	6	57.5	37.0	57.5	45.5	59.0	47.0	60.0	52.5	56.5	43.0	55.0	37.0	57.0	43.0	57.5	45.0	57.5	40.0
$\frac{7}{16}$	7	56.5	32.5	56.5	43.5	58.5	45.0	60.0	52.5	55.0	40.0	53.0	33.5	55.0	40.5	56.5	42.5	56.5	37.5
$\frac{1}{2}$	8	55.0	30.0	56.0	41.0	58.0	43.5	60.0	52.0	53.0	37.5	51.0	31.5	53.0	38.0	55.0	40.0	55.0	35.0
$\frac{9}{16}$	9	53.0	28.0	55.0	38.5	58.0	41.5	60.0	52.0	50.5	35.0	49.0	29.5	51.0	36.0	54.0	37.5	53.5	33.5
$\frac{5}{8}$	10	51.5	27.0	54.0	36.5	57.5	40.0	60.0	51.5	49.0	33.5	47.0	28.0	49.5	34.0	52.5	36.0	52.5	32.0
$\frac{11}{16}$	11	49.5	25.5	53.0	34.5	57.0	38.5	60.0	51.5	47.5	32.0	45.0	27.0	48.0	32.5	51.5	34.0	51.0	30.0
$\frac{3}{4}$	12	48.0	24.5	52.0	33.5	56.0	37.5	60.0	51.0	46.0	31.0	43.5	26.0	46.5	31.0	50.0	33.0	50.0	29.0
$\frac{13}{16}$	13	46.0	24.0	51.0	32.0	55.5	36.5	60.0	51.0	45.0	29.5	42.0	25.5	45.5	30.0	49.0	32.0	49.0	28.0
$\frac{7}{8}$	14	44.5	23.0	50.0	31.5	55.0	35.5	60.0	50.5	44.0	29.0	41.0	25.0	44.5	29.0	48.0	31.0	48.0	27.0
$\frac{15}{16}$	15	43.0	22.5	48.5	30.5	54.5	34.5	60.0	50.5	43.5	28.0	40.0	24.5	43.5	28.0	47.0	30.0	47.0	26.0
1	16	41.5	22.0	47.5	30.0	54.0	34.0	60.0	50.0	42.5	27.5	39.0	24.0	42.5	27.5	46.0	29.5	46.0	25.0
$1\frac{1}{16}$	18	39.5	21.0	46.0	29.0	53.0	33.0	60.0	49.0	41.5	26.5	37.5	23.0	41.5	26.5	44.5	28.0	44.5	24.0
$1\frac{1}{8}$	20	38.0	21.0	44.5	28.5	52.0	32.0	60.0	48.0	41.0	25.5	36.0	22.0	40.5	26.0	43.0	27.5	43.0	23.0
$1\frac{3}{16}$	22	37.0	20.5	43.0	28.0	51.5	31.5	60.0	47.0	40.0	25.0	35.0	21.0	39.5	25.0	42.5	27.0	42.0	22.5
$1\frac{1}{2}$	24	36.5	20.0	42.0	27.5	51.0	31.0	60.0	46.0	39.5	25.0	34.0	20.0	38.5	25.0	42.0	26.5	41.5	22.0
$1\frac{5}{8}$	26	36.0		41.0	27.0	50.5	30.0	60.0	45.0	39.0	24.5	33.0		38.0	24.5	41.5	26.0	40.5	21.5
$1\frac{3}{4}$	28	36.0		40.5	26.5	50.0	30.0	60.0	44.5	38.5	24.0	32.0		37.5	24.0	41.0	25.5	40.0	21.5
1 1/8	30	35.5		40.0	26.0	49.5	29.5	60.0	44.0	38.0	24.0	31.0		37.0	24.0	40.5	25.5	39.5	21.0
2	32	35.0		39.0	25.0	49.0	29.5	60.0	43.0	38.0	24.0	30.0		37.0	24.0	40.5	25.5	39.5	21.0

TABLE 6. Tabulation of Band Limits for Steels Containing 0.45 Per Cent Carbon

Jominy distance		4145		5145		8645		8745		9445	
		Rockwell C		Rockwell C		Rockwell C		Rockwell C		Rockwell C	
Inches	Sixteenths of an inch	Max.	Min.	Max.	Min.	Max.	Min.	Max.	Min.	Max.	Min.
		$\frac{1}{16}$	1	63.0	55.0	63.0	55.0	63.0	55.0	63.0	55.0
$\frac{1}{8}$	2	63.0	54.5	62.5	54.5	63.0	54.5	63.0	55.0	63.0	54.0
$\frac{3}{16}$	3	62.5	54.0	62.0	53.0	63.0	53.0	63.0	54.5	63.0	52.5
$\frac{1}{4}$	4	62.0	53.0	61.0	51.0	62.5	51.5	62.5	53.5	62.5	51.0
$\frac{5}{16}$	5	62.0	52.5	60.0	48.0	61.5	49.5	62.0	52.0	62.5	49.0
$\frac{3}{8}$	6	61.5	51.0	58.5	42.0	61.0	47.5	61.0	50.0	62.0	46.0
$\frac{7}{16}$	7	61.0	50.0	57.0	36.5	59.0	45.5	60.0	48.0	61.5	43.0
$\frac{1}{2}$	8	61.0	48.5	55.5	33.5	57.5	43.0	59.5	45.5	61.0	41.0
$\frac{9}{16}$	9	60.5	47.0	53.5	31.5	56.0	41.0	58.5	43.5	60.0	39.0
$\frac{5}{8}$	10	60.0	45.0	52.0	30.0	55.0	39.0	58.0	41.5	59.0	37.0
$\frac{11}{16}$	11	60.0	43.5	50.0	29.0	53.5	37.5	57.0	40.0	58.0	35.5
$\frac{3}{4}$	12	59.5	42.0	48.0	28.0	52.5	35.5	56.0	38.5	57.0	34.0
$\frac{13}{16}$	13	59.0	40.5	46.0	27.5	51.0	34.0	55.0	37.0	56.0	33.0
$\frac{7}{8}$	14	59.0	39.5	44.5	27.0	50.0	33.0	54.5	36.0	55.0	32.0
$\frac{15}{16}$	15	58.5	38.5	43.0	26.5	49.0	32.0	53.5	35.0	54.0	31.0
1	16	58.0	38.0	42.0	26.0	48.5	31.0	52.5	34.0	53.0	30.0
$1\frac{1}{8}$	18	57.5	36.5	40.5	25.0	47.0	30.0	51.5	32.5	51.5	28.5
$1\frac{1}{4}$	20	57.0	35.5	39.0	24.0	46.0	29.0	50.0	31.5	50.0	28.0
$1\frac{3}{8}$	22	56.0	34.5	38.0	23.0	44.5	28.5	49.5	30.5	49.0	27.0
$1\frac{1}{2}$	24	55.5	34.0	37.0	22.0	43.5	28.0	48.5	30.0	48.0	26.5
$1\frac{5}{8}$	26	55.0	33.5	36.0	21.0	43.0	28.0	48.0	30.0	47.5	26.0
$1\frac{3}{4}$	28	54.5	33.0	35.0	20.0	42.5	27.5	47.5	29.5	46.5	26.0
$1\frac{7}{8}$	30	54.0	33.0	34.0		42.0	27.5	47.0	29.5	46.0	26.0
2	32	53.5	32.5	33.0		41.5	27.5	47.0	29.5	45.5	26.0

TABLE 7. Tabulation of Band Limits for Steels Containing 0.50 Per Cent Carbon

Jominy distance		4150		5150		6150		8650		8750	
Inches	Six- teenths of an inch	Rockwell C		Rockwell C		Rockwell C		Rockwell C		Rockwell C	
		Max.	Min.	Max.	Min.	Max.	Min.	Max.	Min.	Max.	Min.
$\frac{1}{16}$	1	65.0	58.0	65.0	58.0	65.0	58.0	65.0	58.0	65.0	58.0
$\frac{1}{8}$	2	65.0	58.0	65.0	57.5	64.5	57.5	65.0	57.5	65.0	58.0
$\frac{3}{16}$	3	65.0	57.5	64.5	56.5	64.0	57.0	65.0	56.5	65.0	57.5
$\frac{1}{4}$	4	65.0	57.0	64.0	55.0	63.5	56.0	65.0	55.0	65.0	56.5
$\frac{5}{16}$	5	64.5	56.5	63.5	52.0	62.5	54.0	64.5	53.5	65.0	55.5
$\frac{3}{8}$	6	64.5	55.0	62.5	48.0	62.0	51.0	63.5	52.0	65.0	54.5
$\frac{7}{16}$	7	64.0	54.0	61.5	43.0	61.0	48.5	63.0	50.0	64.5	53.0
$\frac{1}{2}$	8	64.0	53.0	60.0	37.5	60.0	45.5	62.0	48.5	64.0	51.0
$\frac{9}{16}$	9	64.0	51.5	58.5	33.5	59.0	42.5	61.0	46.5	64.0	49.0
$\frac{5}{8}$	10	63.5	50.0	57.0	32.0	58.0	40.0	60.0	44.5	63.5	47.0
$\frac{11}{16}$	11	63.0	48.0	55.0	31.0	57.0	38.0	59.0	42.5	63.0	45.0
$\frac{3}{4}$	12	63.0	46.5	52.0	30.0	56.0	36.5	58.0	41.0	62.5	43.5
$\frac{13}{16}$	13	63.0	45.0	50.0	29.5	55.0	35.5	57.0	39.5	62.0	42.0
$\frac{7}{8}$	14	62.5	44.0	48.0	29.0	53.5	35.0	56.0	38.0	61.5	40.5
$\frac{15}{16}$	15	62.0	42.5	46.5	28.5	52.0	34.5	55.0	37.0	61.0	39.5
1	16	62.0	42.0	45.0	28.0	51.0	34.0	54.0	36.0	60.0	38.5
$1\frac{1}{8}$	18	61.5	40.0	43.5	27.0	48.0	33.0	52.0	34.0	59.0	37.0
$1\frac{1}{4}$	20	61.0	39.0	42.0	26.0	46.0	31.5	51.0	32.5	57.5	35.0
$1\frac{3}{8}$	22	60.5	38.0	41.0	25.0	45.0	30.5	49.5	31.5	56.5	34.0
$1\frac{1}{2}$	24	60.0	37.0	40.0	24.0	44.0	29.5	48.5	31.0	55.5	33.5
$1\frac{5}{8}$	26	59.5	36.5	39.0	23.0	43.0	28.5	48.0	30.5	55.0	33.0
$1\frac{3}{4}$	28	59.0	36.0	38.0	22.0	42.0	27.5	47.0	30.0	54.5	33.0
$1\frac{7}{8}$	30	58.5	36.0	37.0	21.0	41.0	26.5	46.5	29.5	54.0	32.5
2	32	58.0	35.5	36.0	20.0	40.0	25.0	46.0	29.5	54.0	32.5

TABLE 8. Tabulation of Band Limits for Steels Containing 0.55 to 0.62 Per Cent Carbon

Jominy distance		8655		8660		9260		9261		9262	
Inches	Sixteenths of an inch	Rockwell C		Rockwell C		Rockwell C		Rockwell C		Rockwell C	
		Max.	Min.	Max.	Min.	Max.	Min.	Max.	Min.	Max.	Min.
$\frac{1}{16}$	1		60.0		60.0		60.0		60.0		60.0
$\frac{1}{8}$	2		59.5		60.0		58.0		59.0		60.0
$\frac{3}{16}$	3		59.0		60.0		55.0		57.0		59.0
$\frac{1}{4}$	4		58.0		59.5	65.0	50.5		55.0		57.5
$\frac{5}{16}$	5		57.0		59.0	63.5	44.0	65.0	51.0		56.0
$\frac{3}{8}$	6		55.5		58.0	62.0	39.5	64.0	46.0		53.5
$\frac{7}{16}$	7		54.0		57.0	60.0	37.0	62.5	42.0	65.0	50.0
$\frac{1}{2}$	8		52.0		55.5	58.0	35.0	60.5	39.0	64.0	44.0
$\frac{9}{16}$	9	65.0	50.5		54.0	56.0	33.5	59.0	37.5	63.0	41.0
$\frac{5}{8}$	10	64.5	48.5		52.0	53.0	32.5	57.0	36.0	62.0	38.5
$\frac{11}{16}$	11	64.0	47.0		50.0	50.0	32.0	54.5	35.0	60.0	37.5
$\frac{3}{4}$	12	63.0	45.0		48.5	48.0	31.0	52.0	34.0	58.5	36.5
$\frac{13}{16}$	13	62.0	43.5		47.0	46.0	30.0	50.0	33.0	56.5	36.0
$\frac{7}{8}$	14	61.0	42.0	65.0	45.5	44.0	29.5	48.0	32.0	53.5	35.0
$\frac{15}{16}$	15	60.0	40.5	64.5	44.5	43.0	29.0	46.0	31.5	50.5	34.0
1	16	59.0	39.5	64.0	43.0	41.5	28.5	44.5	31.0	48.0	33.5
$1\frac{1}{8}$	18	57.0	37.5	62.0	41.0	40.0	27.5	42.5	30.0	45.0	32.5
$1\frac{1}{4}$	20	55.5	36.0	60.0	39.5	38.5	26.5	41.0	29.5	43.5	31.5
$1\frac{3}{8}$	22	54.0	35.0	58.5	38.0	37.5	26.0	40.5	28.5	43.0	30.5
$1\frac{1}{2}$	24	53.0	34.0	57.5	37.0	37.0	25.5	40.0	28.0	42.5	30.0
$1\frac{5}{8}$	26	52.0	33.0	56.5	35.5	37.0	25.0	39.5	27.5	42.0	29.5
$1\frac{3}{4}$	28	51.5	32.5	56.0	35.0	36.5	24.5	39.5	27.0	41.5	29.0
$1\frac{7}{8}$	30	51.0	32.0	55.5	34.0	36.0	24.0	39.0	26.5	41.5	28.5
2	32	50.5	31.5	55.0	33.5	36.0	24.0	39.0	26.0	41.0	28.0

APPENDIX III*

SAE Standard Numbering System for Wrought Steel

A numeral index system is used to identify the compositions of the SAE steels, which makes it possible to use numerals on shop drawings or blue-prints that are partially descriptive of the composition of material covered by such numbers. In the original conception the first digit indicated the type to which the steel belongs; thus '1-' indicated a carbon steel; '2-' a nickel steel, and '3-' a nickel-chromium steel. In the case of the simple alloy steels the second digit generally indicates the approximate percentage of the predominant alloying element. Usually the last two or three digits indicate the approximate average carbon content in 'points,' or hundredths of 1 per cent. Thus '2340' indicates a nickel steel of approximately 3 per cent nickel (3.25 to 3.75) and 0.40 per cent carbon (0.38 to 0.43).

In some instances, in order to avoid confusion it has been found necessary to depart from this system of identifying the approximate alloy composition of a steel by varying the second and third digits of the number. Instances of such departure are the steel numbers selected for several of the corrosion- and heat-resisting alloys and the triple-alloy steels.

The basic numerals for the various types of SAE steel† are:

<i>Type of steel</i>	<i>Numerals (and digits)</i>	<i>Type of steel</i>	<i>Numerals (and digits)</i>
Carbon steels.....	1xxx	Chromium steels.....	5xxx
Plain carbon.....	10xx	Low Cr.....	51xx
Free cutting (screw).....	11xx	Low Cr (bearing).....	501xx
		Medium Cr (bearing).....	511xx
Manganese steels.....	13xx	High Cr (bearing).....	521xx
		Corrosion and heat resisting.	51xxx
Nickel steels.....	2xxx	Chromium-vanadium steels....	6xxx
3.50 Ni.....	23xx	1 per cent Cr.....	61xx
5.00 Ni.....	25xx		
Nickel-chromium steels.....	3xxx	Silicon-manganese steels.....	9xxx
1.25 Ni, 0.60 Cr.....	31xx	2 per cent Si.....	92xx
1.75 Ni, 1.00 Cr.....	32xx		
3.50 Ni, 1.50 Cr.....	33xx	Triple-alloy steels	
Corrosion and heat resisting.	30xxx	Ni 0.40-0.70, Cr 0.40-0.60,	
		Mo 0.15-0.25.....	86xx
Molybdenum steels.....	4xxx	Ni 0.40-0.70, Cr 0.40-0.60,	
C, Mo.....	40xx	Mo 0.20-0.30.....	87xx
Cr, Mo.....	41xx	Ni 3.00-3.50, Cr 1.00-1.40,	
Cr, Ni, Mo.....	43xx	Mo 0.08-0.15.....	93xx
Ni, Mo (1.75 Ni).....	46xx	Ni 0.30-0.60, Cr 0.30-0.50,	
Ni, Mo (3.50 Ni).....	48xx	Mo 0.08-0.15.....	94xx
		Ni 0.40-0.70, Cr 0.10-0.25,	
		Mo 0.15-0.25.....	97xx
		Ni 0.85-1.15, Cr 0.70-0.90,	
		Mo 0.20-0.30.....	98xx
		Low alloy, high tensile.....	9xx

*SAE Handbook.¹²⁴

† Report of Iron and Steel Division adopted January 1912. Last revision by Iron and Steel Technical Committee, October 1947.

CHEMICAL COMPOSITIONS

In 1941 the SAE Iron and Steel Division in collaboration with the American Iron and Steel Institute effected a major change in the method of expressing composition ranges for the SAE steels. The plan was based in general on narrower mill-heat analysis ranges plus certain check-analysis allowances on individual samples, in place of the previously fixed ranges and limits without tolerances formerly provided for carbon and other elements in the SAE steels. Under the close cooperation between the AISI and the SAE Iron and Steel Committee no changes in compositions, additions, or deletions of numbers are made by either society without informing the other of the proposed changes and holding open discussion between both groups in order to effect simultaneous changes.

The compositions in Tables 1 to 10 may apply to either open-hearth or electric-furnace steels. Where they apply to electric-furnace steels, the maximum P and S shall be 0.025. The nominal chemical limits or ranges in the compositions are subject to standard variations in check analysis given in the SAE Handbook. Where there is no prefix in AISI number, the steel is predominantly open hearth.

TABLE 1. Carbon Steels (see Notes 1 and 2).* These compositions are applicable only to semifinished products, bars (hot rolled and cold finished), and wire rods.

SAE number	Nominal chemical ranges, per cent				Corresp. AISI number
	C	Mn	P max.	S max.	
1006	0.08 max.	0.25-0.40	0.040	0.050	C1006
1008	0.10 max.	0.25-0.50	0.040	0.050	C1008
1010	0.08-0.13	0.30-0.60	0.040	0.050	C1010
1015	0.13-0.18	0.30-0.60	0.040	0.050	C1015
1016	0.13-0.18	0.60-0.90	0.040	0.050	C1016
1017	0.15-0.20	0.30-0.60	0.040	0.050	C1017
1018	0.15-0.20	0.60-0.90	0.040	0.050	C1018
1019	0.15-0.20	0.70-1.00	0.040	0.050	C1019
1020	0.18-0.23	0.30-0.60	0.040	0.050	C1020
1022	0.18-0.23	0.70-1.00	0.040	0.050	C1022
1024	0.19-0.25	1.35-1.65	0.040	0.050	C1024
1025	0.22-0.28	0.30-0.60	0.040	0.050	C1025
1027	0.22-0.29	1.20-1.50	0.040	0.050	C1027
1030	0.28-0.34	0.60-0.90	0.040	0.050	C1030
1033	0.30-0.36	0.70-1.00	0.040	0.050	C1033
1034	0.32-0.38	0.50-0.80	0.040	0.050	C1034
1035	0.32-0.38	0.60-0.90	0.040	0.050	C1035
1036	0.30-0.37	1.20-1.50	0.040	0.050	C1036
1038	0.35-0.42	0.60-0.90	0.040	0.050	C1038
1039	0.37-0.44	0.70-1.00	0.040	0.050	
1040	0.37-0.44	0.60-0.90	0.040	0.050	C1040
1041	0.36-0.44	1.35-1.65	0.040	0.050	C1041
1042	0.40-0.47	0.60-0.90	0.040	0.050	C1042
1043	0.40-0.47	0.70-1.00	0.040	0.050	C1043
1045	0.43-0.50	0.60-0.90	0.040	0.050	C1045
1046	0.43-0.50	0.70-1.00	0.040	0.050	C1046
1050	0.48-0.55	0.60-0.90	0.040	0.050	C1050
1052	0.47-0.55	1.20-1.50	0.040	0.050	C1052
1055	0.50-0.60	0.60-0.90	0.040	0.050	C1055
1060	0.55-0.65	0.60-0.90	0.040	0.050	C1060
1062	0.54-0.65	0.85-1.15	0.040	0.050	C1062
1064	0.60-0.70	0.50-0.80	0.040	0.050	C1064
1065	0.60-0.70	0.60-0.90	0.040	0.050	C1065
1066	0.60-0.71	0.85-1.15	0.040	0.050	C1066
1070	0.65-0.75	0.60-0.90	0.040	0.050	C1070
1074	0.70-0.80	0.50-0.80	0.040	0.050	C1074
1078	0.72-0.85	0.30-0.60	0.040	0.050	C1078
1080	0.75-0.88	0.60-0.90	0.040	0.050	C1080
1085	0.80-0.93	0.70-1.00	0.040	0.050	C1085
1090	0.85-1.00	0.60-0.90	0.040	0.050	C1090
1095	0.90-1.05	0.30-0.50	0.040	0.050	C1095

*Notes for Tables 1-10 follow Table 10.

TABLE 2. Free-Cutting Steels (see Notes 1 and 2). Applicable only to blooms, billets, slabs, bars, and rods. Basic open-hearth and acid Bessemer resulphurized carbon steels. Subject to permissible variations for check analysis. (Resulphurized steel is not subject to check analysis for sulphur.)

SAE number	Nominal chemical ranges, per cent				Corresp. AISI number
	C	Mn	P	S	
Bessemer					
1111	0.13 Max.	0.60-0.90	0.07-0.12	0.08-0.15	B1111
1112	0.13 Max.	0.70-1.00	0.07-0.12	0.16-0.23	B1112
1113	0.13 Max.	0.70-1.00	0.07-0.12	0.24-0.33	B1113
Open hearth			Max.		
1109	0.08-0.13	0.60-0.90	0.045	0.08-0.13	C1109
1114	0.10-0.16	1.00-1.30	0.045	0.08-0.13	C1114
1115	0.13-0.18	0.60-0.90	0.045	0.08-0.13	C1115
1116	0.14-0.20	1.10-1.40	0.045	0.16-0.23	C1116
1117	0.14-0.20	1.00-1.30	0.045	0.08-0.13	C1117
1118	0.14-0.20	1.30-1.60	0.045	0.08-0.13	C1118
1119	0.14-0.20	1.00-1.30	0.045	0.24-0.33	C1119
1120	0.18-0.23	0.70-1.00	0.045	0.08-0.13	C1120
1126	0.23-0.29	0.70-1.00	0.045	0.08-0.13	C1126
1132	0.27-0.34	1.35-1.65	0.045	0.08-0.13	
1137	0.32-0.39	1.35-1.65	0.045	0.08-0.13	C1137
1138	0.34-0.40	0.70-1.00	0.045	0.08-0.13	C1138
1140	0.37-0.44	0.70-1.00	0.045	0.08-0.13	C1140
1141	0.37-0.45	1.35-1.65	0.045	0.08-0.13	C1141
1144	0.40-0.48	1.35-1.65	0.045	0.24-0.33	C1144
1145	0.42-0.49	0.70-1.00	0.045	0.04-0.07	C1145
1146	0.42-0.49	0.70-1.00	0.045	0.08-0.13	C1146
1151	0.48-0.55	0.70-1.00	0.045	0.08-0.13	C1151

TABLE 3. Manganese Steels (see Note 3)

SAE number	Nominal chemical ranges, per cent					Corresp. AISI number
	C	Mn	P max.	S max.	Si	
1320	0.18-0.23	1.60-1.90	0.040	0.040	0.20-0.35	1320
1330	0.28-0.33	1.60-1.90	0.040	0.040	0.20-0.35	1330
1335	0.33-0.38	1.60-1.90	0.040	0.040	0.20-0.35	1335
1340	0.38-0.43	1.60-1.90	0.040	0.040	0.20-0.35	1340

TABLE 4. Nickel Steels (see Note 3)

SAE number	Nominal chemical ranges, per cent						Corresp. AISI number
	C	Mn	P max.	S max.	Si	Ni	
2317	0.15-0.20	0.40-0.60	0.040	0.040	0.20-0.35	3.25-3.75	2317
2330	0.28-0.33	0.60-0.80	0.040	0.040	0.20-0.35	3.25-3.75	2330
2340	0.38-0.43	0.70-0.90	0.040	0.040	0.20-0.35	3.25-3.75	2340
2345	0.43-0.48	0.70-0.90	0.040	0.040	0.20-0.35	3.25-3.75	2345
2512*	0.09-0.14	0.45-0.60	0.025	0.025	0.20-0.35	4.75-5.25	E2512
2515	0.12-0.17	0.40-0.60	0.040	0.040	0.20-0.35	4.75-5.25	2515
2517*	0.15-0.20	0.45-0.60	0.025	0.025	0.20-0.35	4.75-5.25	E2517

* Electric-furnace steel.

TABLE 5. Nickel-Chromium Steels (see Note 3)

SAE number	Nominal chemical ranges, per cent							Corresp. AISI number
	C	Mn	P max.	S max.	Si	Ni	Cr	
3115	0.13-0.18	0.40-0.60	0.040	0.040	0.20-0.35	1.10-1.40	0.55-0.75	3115
3120	0.17-0.22	0.60-0.80	0.040	0.040	0.20-0.35	1.10-1.40	0.55-0.75	3120
3130	0.28-0.33	0.60-0.80	0.040	0.040	0.20-0.35	1.10-1.40	0.55-0.75	3130
3135	0.33-0.38	0.60-0.80	0.040	0.040	0.20-0.35	1.10-1.40	0.55-0.75	3135
3140	0.38-0.43	0.70-0.90	0.040	0.040	0.20-0.35	1.10-1.40	0.55-0.75	3140
3141	0.38-0.43	0.70-0.90	0.040	0.040	0.20-0.35	1.10-1.40	0.70-0.90	3141
3145	0.43-0.48	0.70-0.90	0.040	0.040	0.20-0.35	1.10-1.40	0.70-0.90	3145
3150	0.48-0.53	0.70-0.90	0.040	0.040	0.20-0.35	1.10-1.40	0.70-0.90	3150
3310*	0.08-0.13	0.45-0.60	0.025	0.025	0.20-0.35	3.25-3.75	1.40-1.75	E3310
3316*	0.14-0.19	0.45-0.60	0.025	0.025	0.20-0.35	3.25-3.75	1.40-1.75	E3316

* Electric-furnace steel.

TABLE 6. Molybdenum Steels (see Note 3)

SAE number	Nominal chemical ranges, per cent							Corresp. AISI number	
	C	Mn	P max.	S max.	Si	Ni	Cr		Mo
4017	0.15-0.20	0.70-0.90	0.040	0.040	0.20-0.35			0.20-0.30	4017
4023	0.20-0.25	0.70-0.90	0.040	0.040	0.20-0.35			0.20-0.30	4023
4024	0.20-0.25	0.70-0.90	0.040	0.035 .050	0.20-0.35			0.20-0.30	4024
4027	0.25-0.30	0.70-0.90	0.040	0.040	0.20-0.35			0.20-0.30	4027
4028	0.25-0.30	0.70-0.90	0.040	0.035 .050	0.20-0.35			0.20-0.30	4028
4032	0.30-0.35	0.70-0.90	0.040	0.040	0.20-0.35			0.20-0.30	4032
4037	0.35-0.40	0.70-0.90	0.040	0.040	0.20-0.35			0.20-0.30	4037
4042	0.40-0.45	0.70-0.90	0.040	0.040	0.20-0.35			0.20-0.30	4042
4047	0.45-0.50	0.70-0.90	0.040	0.040	0.20-0.35			0.20-0.30	4047
4053	0.50-0.56	0.75-1.00	0.040	0.040	0.20-0.35			0.20-0.30	4053
4063	0.60-0.67	0.75-1.00	0.040	0.040	0.20-0.35			0.20-0.30	4063
4068	0.63-0.70	0.75-1.00	0.040	0.040	0.20-0.35			0.20-0.30	4068
4119	0.17-0.22	0.70-0.90	0.040	0.040	0.20-0.35		0.40-0.60	0.20-0.30	
4125	0.23-0.28	0.70-0.90	0.040	0.040	0.20-0.35		0.40-0.60	0.20-0.30	
4130	0.28-0.33	0.40-0.60	0.040	0.040	0.20-0.35		0.80-1.10	0.15-0.25	4130
4137	0.35-0.40	0.70-0.90	0.040	0.040	0.20-0.35		0.80-1.10	0.15-0.25	4137
4140	0.38-0.43	0.75-1.00	0.040	0.040	0.20-0.35		0.80-1.10	0.15-0.25	4140
4145	0.43-0.48	0.75-1.00	0.040	0.040	0.20-0.35		0.80-1.10	0.15-0.25	4145
4150	0.48-0.53	0.75-1.00	0.040	0.040	0.20-0.35		0.80-1.10	0.15-0.25	4150
4317	0.15-0.20	0.45-0.65	0.040	0.040	0.20-0.35	1.65-2.00	0.40-0.60	0.20-0.30	4317
4320	0.17-0.22	0.45-0.65	0.040	0.040	0.20-0.35	1.65-2.00	0.40-0.60	0.20-0.30	4320
4340	0.38-0.43	0.60-0.80	0.040	0.040	0.20-0.35	1.65-2.00	0.70-0.90	0.20-0.30	4340
4608	0.06-0.11	0.25-0.45	0.040	0.040	0.25 max.	1.40-1.75		0.15-0.25	4608
4615	0.13-0.18	0.45-0.65	0.040	0.040	0.20-0.35	1.65-2.00		0.20-0.30	4615
4617	0.15-0.20	0.45-0.65	0.040	0.040	0.20-0.35	1.65-2.00		0.20-0.30	
4620	0.17-0.22	0.45-0.65	0.040	0.040	0.20-0.35	1.65-2.00		0.20-0.30	4620
X 4620	0.18-0.23	0.50-0.70	0.040	0.040	0.20-0.35	1.65-2.00		0.20-0.30	
4621	0.18-0.23	0.70-0.90	0.040	0.040	0.20-0.35	1.65-2.00		0.20-0.30	4621
4640	0.38-0.43	0.60-0.80	0.040	0.040	0.20-0.35	1.65-2.00		0.20-0.30	4640
4812	0.10-0.15	0.40-0.60	0.040	0.040	0.20-0.35	3.25-3.75		0.20-0.30	4812
4815	0.13-0.18	0.40-0.60	0.040	0.040	0.20-0.35	3.25-3.75		0.20-0.30	4815
4817	0.15-0.20	0.40-0.60	0.040	0.040	0.20-0.35	3.25-3.75		0.20-0.30	4817
4820	0.18-0.23	0.50-0.70	0.040	0.040	0.20-0.35	3.25-3.75		0.20-0.30	4820

TABLE 7. Chromium Steels (see Note 3)

SAE number	Nominal chemical ranges, per cent						Corresp. AISI number
	C	Mn	P max.	S max.	Si	Cr	
5045	0.43-0.48	0.70-0.90	0.040	0.040	0.20-0.35	0.55-0.75	5045
5046	0.43-0.50	0.75-1.00	0.040	0.040	0.20-0.35	0.20-0.35	5046
5115	0.13-0.18	0.70-0.90	0.040	0.040	0.20-0.35	0.70-0.90	
5120	0.17-0.22	0.70-0.90	0.040	0.040	0.20-0.35	0.70-0.90	5120
5130	0.28-0.33	0.70-0.90	0.040	0.040	0.20-0.35	0.80-1.10	5130
5132	0.30-0.35	0.60-0.80	0.040	0.040	0.20-0.35	0.80-1.05	5132
5135	0.33-0.38	0.60-0.80	0.040	0.040	0.20-0.35	0.80-1.05	5135
5140	0.38-0.43	0.70-0.90	0.040	0.040	0.20-0.35	0.70-0.90	5140
5145	0.43-0.48	0.70-0.90	0.040	0.040	0.20-0.35	0.70-0.90	5145
5147	0.45-0.52	0.75-1.00	0.040	0.040	0.20-0.35	0.90-1.20	5147
5150	0.48-0.53	0.70-0.90	0.040	0.040	0.20-0.35	0.70-0.90	5150
5152	0.48-0.55	0.70-0.90	0.040	0.040	0.20-0.35	0.90-1.20	5152
50100*	0.95-1.10	0.25-0.45	0.025	0.025	0.20-0.35	0.40-0.60	E50100
51100*	0.95-1.10	0.25-0.45	0.025	0.025	0.20-0.35	0.90-1.15	E51100
52100*	0.95-1.10	0.25-0.45	0.025	0.025	0.20-0.35	1.30-1.60	E52100

* Electric-furnace steel.

TABLE 8. Chromium-Vanadium Steels (see Note 3)

SAE number	Nominal chemical ranges, per cent							Corresp. AISI number
	C	Mn	P max.	S max.	Si	Cr	V min.	
6150	0.48-0.53	0.70-0.90	0.040	0.040	0.20-0.35	0.80-1.10	0.15	6150

TABLE 9. Silicon-Manganese Steel (see Note 3)

SAE number	Nominal chemical ranges, per cent						Corresp. AISI number
	C	Mn	P max.	S max.	Si	Cr	
9254	0.50-0.60	0.50-0.80	0.040	0.040	1.20-1.60	0.50-0.80	
9255	0.50-0.60	0.70-0.95	0.040	0.040	1.80-2.20		9255
9260	0.55-0.65	0.70-1.00	0.040	0.040	1.80-2.20		9260
9261	0.55-0.65	0.75-1.00	0.040	0.040	1.80-2.20	0.10-0.25	9261
9262	0.55-0.65	0.75-1.00	0.040	0.040	1.80-2.20	0.25-0.40	9262

TABLE 10. Triple-Alloy Steels (see Note 3)

SAE number	Nominal chemical ranges, per cent								Corresp. AISI number
	C	Mn	P	S	Si	Ni	Cr	Mo	
8615	0.13-0.18	0.70-0.90	0.040	0.040	0.20-0.35	0.40-0.70	0.40-0.60	0.15-0.25	8615
8617	0.15-0.20	0.70-0.90	0.040	0.040	0.20-0.35	0.40-0.70	0.40-0.60	0.15-0.25	8617
8620	0.18-0.23	0.70-0.90	0.040	0.040	0.20-0.35	0.40-0.70	0.40-0.60	0.15-0.25	8620
8622	0.20-0.25	0.70-0.90	0.040	0.040	0.20-0.35	0.40-0.70	0.40-0.60	0.15-0.25	8622
8625	0.23-0.28	0.70-0.90	0.040	0.040	0.20-0.35	0.40-0.70	0.40-0.60	0.15-0.25	8625
8627	0.25-0.30	0.70-0.90	0.040	0.040	0.20-0.35	0.40-0.70	0.40-0.60	0.15-0.25	8627
8630	0.28-0.33	0.70-0.90	0.040	0.040	0.20-0.35	0.40-0.70	0.40-0.60	0.15-0.25	8630
8632	0.30-0.35	0.70-0.90	0.040	0.040	0.20-0.35	0.40-0.70	0.40-0.60	0.15-0.25	8632
8635	0.33-0.38	0.75-1.00	0.040	0.040	0.20-0.35	0.40-0.70	0.40-0.60	0.15-0.25	8635
8637	0.35-0.40	0.75-1.00	0.040	0.040	0.20-0.35	0.40-0.70	0.40-0.60	0.15-0.25	8637
8640	0.38-0.43	0.75-1.00	0.040	0.040	0.20-0.35	0.40-0.70	0.40-0.60	0.15-0.25	8640
8641	0.38-0.43	0.75-1.00	0.040	0.040	0.20-0.35	0.40-0.70	0.40-0.60	0.15-0.25	8641
8642	0.40-0.45	0.75-1.00	0.040	0.040	0.20-0.35	0.40-0.70	0.40-0.60	0.15-0.25	8642
8645	0.43-0.48	0.75-1.00	0.040	0.040	0.20-0.35	0.40-0.70	0.40-0.60	0.15-0.25	8645
8647	0.45-0.50	0.75-1.00	0.040	0.040	0.20-0.35	0.40-0.70	0.40-0.60	0.15-0.25	8647
8650	0.48-0.53	0.75-1.00	0.040	0.040	0.20-0.35	0.40-0.70	0.40-0.60	0.15-0.25	8650
8653	0.50-0.56	0.75-1.00	0.040	0.040	0.20-0.35	0.40-0.70	0.50-0.80	0.15-0.25	8653
8655	0.50-0.60	0.75-1.00	0.040	0.040	0.20-0.35	0.40-0.70	0.40-0.60	0.15-0.25	8655
8660	0.55-0.65	0.75-1.00	0.040	0.040	0.20-0.35	0.40-0.70	0.40-0.60	0.15-0.25	8660
8720	0.18-0.23	0.70-0.90	0.040	0.040	0.20-0.35	0.40-0.70	0.40-0.60	0.20-0.30	8720
8735	0.33-0.38	0.75-1.00	0.040	0.040	0.20-0.35	0.40-0.70	0.40-0.60	0.20-0.30	8735
8740	0.38-0.43	0.75-1.00	0.040	0.040	0.20-0.35	0.40-0.70	0.40-0.60	0.20-0.30	8740
8745	0.43-0.48	0.75-1.00	0.040	0.040	0.20-0.35	0.40-0.70	0.40-0.60	0.20-0.30	8745
8750	0.48-0.53	0.75-1.00	0.040	0.040	0.20-0.35	0.40-0.70	0.40-0.60	0.20-0.30	8750
9310*	0.08-0.13	0.45-0.65	0.025	0.025	0.20-0.35	3.00-3.50	1.00-1.40	0.08-0.15	E9310
9315*	0.13-0.18	0.45-0.65	0.025	0.025	0.20-0.35	3.00-3.50	1.00-1.40	0.08-0.15	E9315
9317*	0.15-0.20	0.45-0.65	0.025	0.025	0.20-0.35	3.00-3.50	1.00-1.40	0.08-0.15	E9317
9437	0.35-0.40	0.90-1.20	0.040	0.040	0.20-0.35	0.30-0.60	0.30-0.50	0.08-0.15	9437
9440	0.38-0.43	0.90-1.20	0.040	0.040	0.20-0.35	0.30-0.60	0.30-0.50	0.08-0.15	9440
9442	0.40-0.45	1.00-1.30	0.040	0.040	0.20-0.35	0.30-0.60	0.30-0.50	0.08-0.15	9442
9445	0.43-0.48	1.00-1.30	0.040	0.040	0.20-0.35	0.30-0.60	0.30-0.50	0.08-0.15	9445
9747	0.45-0.50	0.50-0.80	0.040	0.040	0.20-0.35	0.40-0.70	0.10-0.25	0.15-0.25	9747
9763	0.60-0.67	0.50-0.80	0.040	0.040	0.20-0.35	0.40-0.70	0.10-0.25	0.15-0.25	9763
9840	0.38-0.43	0.70-0.90	0.040	0.040	0.20-0.35	0.85-1.15	0.70-0.90	0.20-0.30	9840
9845	0.43-0.48	0.70-0.90	0.040	0.040	0.20-0.35	0.85-1.15	0.70-0.90	0.20-0.30	9845
9850	0.48-0.53	0.70-0.90	0.040	0.040	0.20-0.35	0.85-1.15	0.70-0.90	0.20-0.30	9850

* Electric-furnace steel.

NOTE 1. For standard variations in composition limits, refer to the table of standard variations, open-hearth and acid-Bessemer carbon-steel bars given in the SAE Handbook.

NOTE 2. When silicon is specified in basic open-hearth steels, silicon may be ordered only as 0.10 per cent maximum in grades up to SAE 1010 incl.; 0.10 per cent max., 0.10–0.20, or 0.15–0.30 per cent in grades from SAE 1015 to 1025 incl.; and 0.10–0.20 or 0.15–0.30 for grades over SAE 1025. In the case of many grades of basic open-hearth steel, special practice is necessary in order to comply with a specification including silicon. Acid-Bessemer steel is not furnished with specified silicon content.

NOTE 3. For standard variations in composition limits, refer to the table of standard variations, open-hearth alloy and electric-furnace steel bars and billets given in the SAE Handbook.

APPENDIX IV*

Hardness Conversion Numbers for Steel

TABLE 1. Conversions Based on Rockwell C. The values in this table shown in bold-faced type correspond to the values shown in the corresponding joint SAE-ASM-ASTM Committee on Hardness Conversions as printed in ASTM Spec. E48-43T, Table 2. Values in () are beyond normal range and are given for information only.

Rockwell C-scale hardness number	Diamond pyramid hardness number, Vickers			Brinell hardness number, 10-mm. ball, 3000-kg. load		Rockwell hardness number			Rockwell superficial hardness number, Superficial Brale penetrator			Shore sclero-scope hardness number	Tensile strength (approx.), 1000 lb. per sq. in.	Rockwell C-scale hardness number		
	Col. 2	Col. 3	Col. 4	Col. 5	Col. 6	Col. 7	Col. 8	Col. 9	Col. 10	Col. 11	Col. 12				Col. 13	Col. 14
68	940	85.6	...	76.9	93.2	84.4	75.4	97	...	68			
67	900	85.0	...	76.1	92.9	83.6	74.2	95	...	67			
66	865	84.5	...	75.4	92.5	82.8	73.3	92	...	66			
65	832	739	83.9	...	74.5	92.2	81.9	72.0	91	...	65			
64	800	722	83.4	...	73.8	91.8	81.1	71.0	88	...	64			
63	772	705	82.8	...	73.0	91.4	80.1	69.9	87	...	63			
62	746	688	82.3	...	72.2	91.1	79.3	68.8	85	...	62			
61	720	670	81.8	...	71.5	90.7	78.4	67.7	83	...	61			
60	697	...	613	654	81.2	...	70.7	90.2	77.5	66.6	81	...	60			
59	674	...	599	634	80.7	...	69.9	89.8	76.6	65.5	80	336	59			
58	653	...	587	615	80.1	...	69.2	89.3	75.7	64.5	78	315	58			
57	633	...	575	595	79.6	...	68.5	88.9	74.8	63.2	76	305	57			
56	613	...	561	577	79.0	...	67.7	88.3	73.9	62.0	75	295	56			
55	595	...	546	560	78.5	...	66.9	87.9	73.0	60.9	74	287	55			
54	577	...	534	543	78.0	...	66.1	87.4	72.0	59.8	72	278	54			
53	560	...	519	525	77.4	...	65.4	86.9	71.2	58.6	71	269	53			
52	544	500	506	512	76.8	...	64.8	86.4	70.2	57.4	69	262	52			
51	528	487	494	496	76.3	...	63.8	85.9	69.4	56.1	68	253	51			
50	513	475	481	481	75.9	...	63.1	85.5	68.5	55.0	67	245	50			
49	498	460	460	460	75.2	...	62.1	85.0	67.6	53.8	66	239	49			
48	484	451	455	455	74.7	...	61.4	84.5	66.7	52.5	64	232	48			
47	471	442	443	443	74.1	...	60.8	83.9	65.8	51.4	63	225	47			
46	458	432	432	432	73.6	...	60.0	83.5	64.8	50.3	62	219	46			

APPENDIX IV

Col. 1	Col. 2	Col. 3	Col. 4	Col. 5	Col. 6	Col. 7	Col. 8	Col. 9	Col. 10	Col. 11	Col. 12	Col. 13	Col. 14
45	446	421	421	421	421	73.1	59.2	83.0	64.0	49.0	60	212	45
44	434	409	409	409	409	72.5	58.5	82.5	63.1	47.8	58	206	44
43	423	400	400	400	400	72.0	57.7	82.0	62.2	46.7	57	201	43
42	412	390	390	390	390	71.5	56.9	81.5	61.3	45.5	56	196	42
41	402	381	381	381	381	70.9	56.2	80.9	60.4	44.3	55	191	41
40	392	371	371	371	371	70.4	55.4	80.4	59.5	43.1	54	186	40
39	382	362	362	362	362	69.9	54.6	79.9	58.6	41.9	52	181	39
38	372	353	353	353	353	69.4	53.8	79.4	57.7	40.8	51	176	38
37	363	344	344	344	344	68.9	53.1	78.8	56.8	39.6	50	172	37
36	354	336	336	336	336	68.4	52.3	78.3	55.9	38.4	49	168	36
35	345	327	327	327	327	67.9	51.5	77.7	55.0	37.2	48	163	35
34	336	319	319	319	319	67.4	50.8	77.2	54.2	36.1	47	159	34
33	327	311	311	311	311	66.8	50.2	76.6	53.3	34.9	46	154	33
32	318	301	301	301	301	66.3	49.2	76.1	52.1	33.7	44	150	32
31	310	294	294	294	294	65.8	48.4	75.6	51.3	32.5	43	146	31
30	302	286	286	286	286	65.3	47.7	75.0	50.4	31.3	42	142	30
29	294	279	279	279	279	64.7	47.0	74.5	49.5	30.1	41	138	29
28	286	271	271	271	271	64.3	46.1	73.9	48.6	28.9	41	134	28
27	279	264	264	264	264	63.8	45.2	73.3	47.7	27.8	40	131	27
26	272	258	258	258	258	63.3	44.6	72.8	46.8	26.7	38	127	26
25	266	253	253	253	253	62.8	43.8	72.2	45.9	25.5	38	124	25
24	260	247	247	247	247	62.4	43.1	71.6	45.0	24.3	37	121	24
23	254	243	243	243	243	62.0	42.1	71.0	44.0	23.1	36	118	23
22	248	237	237	237	237	61.5	41.6	70.5	43.2	22.0	35	115	22
21	243	231	231	231	231	61.0	40.9	69.9	42.3	20.7	35	113	21
20	238	226	226	226	226	60.5	40.1	69.4	41.5	19.6	34	110	20
(18)	230	219	219	219	219	60.1	39.7	68.8	40.8	18.5	33	106	(18)
(16)	222	212	212	212	212	59.6	39.1	68.2	40.2	17.4	32	102	(16)
(14)	213	203	203	203	203	59.1	38.5	67.6	39.6	16.3	31	98	(14)
(12)	204	194	194	194	194	58.6	37.9	67.0	39.0	15.2	29	94	(12)
(10)	196	187	187	187	187	58.1	37.3	66.4	38.4	14.1	28	90	(10)
(8)	188	179	179	179	179	57.6	36.7	65.8	37.8	13.0	27	87	(8)
(6)	180	171	171	171	171	57.1	36.1	65.2	37.2	12.0	26	84	(6)
(4)	173	165	165	165	165	56.6	35.5	64.6	36.6	11.0	25	80	(4)
(2)	166	158	158	158	158	56.1	34.9	64.0	36.0	10.0	24	77	(2)
(0)	160	152	152	152	152	55.6	34.3	63.4	35.4	9.0	24	75	(0)

*SAE Handbook. 14

TABLE 2. Conversions Based on Brinell. The value in this table shown in bold-faced type correspond to the values shown in the corresponding joint SAE-ASM-ASTM Committee on Hardness Conversions as printed in ASTM Spec. E48-43T, Table 3. Values in () are beyond normal range and are given for information only.

Brinell indentation diameter, mm.	Brinell hardness number.				Diamond pyramid hardness number, Vickers	Rockwell hardness number				Rockwell superficial hardness			Shore scleroscope hardness number	Tensile strength (approx.), 1000 lb. per sq. in.	Brinell indentation diameter, mm.
	Stand-ard ball	10-mm. ball, 3000-kg. load	Tung-sten carbide ball			A-scale, 60-kg. load, 1/16-in. dia. ball	C-scale, 150-kg. load, Brale penetrator	D-scale, 100-kg. load, Brale penetrator	Superficial Brale penetrator						
			Hult-gren ball	Col. 3					Col. 4	Col. 5	Col. 6	Col. 7			
...	940	85.6	...	68.0	76.9	93.2	84.4	75.4	97
...	920	85.3	...	67.5	76.5	93.0	84.0	74.8	96
...	900	85.0	...	67.0	76.1	92.9	83.6	74.8	95
...	880	84.7	...	66.4	75.7	92.7	83.6	73.6	93
...	860	84.4	...	65.9	75.3	92.5	82.7	73.1	92
2.25	840	84.1	...	65.3	74.8	92.3	82.2	72.2	91	...	2.25
...	820	83.8	...	64.7	74.3	92.1	81.7	71.8	90
...	800	83.4	...	64.0	73.8	91.8	81.1	71.0	88
2.30	780	83.0	...	63.3	73.3	91.5	80.4	70.2	87	...	2.30
...	760	82.6	...	62.5	72.6	91.2	79.7	69.4	86
...	740	82.2	...	61.8	72.1	91.0	79.1	68.6	85
2.35	737	82.2	...	61.7	72.0	90.7	79.0	68.5	84	...	2.35
...	720	81.8	...	61.0	71.5	90.7	78.4	67.7	83
...	700	81.3	...	60.1	70.8	90.3	77.6	66.7	81
2.40	697	81.2	...	60.0	70.7	90.2	77.5	66.5	81	...	2.40
...	680	81.1	...	59.7	70.5	90.1	77.2	66.2	80
...	680	80.8	...	59.2	70.1	89.8	76.8	65.7	80
...	670	80.6	...	58.8	69.8	89.7	76.4	65.3	79
2.45	667	80.5	...	58.7	69.7	89.6	76.3	65.1	79	...	2.45
...	677	80.7	...	59.1	70.0	89.8	76.8	65.7	77
2.50	640	79.8	...	57.3	68.7	89.0	75.1	63.5	77	...	2.50
...	640	79.8	...	57.3	68.7	89.0	75.1	63.5	77
2.55	615	79.1	...	56.0	67.7	88.4	73.9	62.1	75	...	2.55
...	607	78.8	...	55.6	67.4	88.1	73.5	61.6	73
2.60	591	78.4	...	54.7	66.7	87.8	72.7	60.6	73	...	2.60
...	579	78.0	...	54.0	66.1	87.5	72.0	59.8	71
2.65	569	77.8	...	53.5	65.8	87.2	71.6	59.2	71	...	2.65
...	553	77.1	...	52.5	65.0	86.7	70.7	58.0	70
2.70	547	76.9	...	52.1	64.7	86.5	70.3	57.6	70	...	2.70
...	539	76.7	...	51.6	64.3	86.3	69.9	56.6	70
...	530	76.4	...	51.1	63.9	86.0	69.3	56.2	70
2.75	528	76.3	...	51.0	63.8	85.9	69.4	56.1	68	...	2.75

APPENDIX IV

Col. 1	Col. 2	Col. 3	Col. 4	Col. 5	Col. 6	Col. 7	Col. 8	Col. 9	Col. 10	Col. 11	Col. 12	Col. 13	Col. 14	Col. 15
2.80	477	477	...	516	75.9	...	50.3	63.2	85.6	68.7	55.2	..	94.7	2.80
...	477	508	75.6	...	49.6	62.7	85.3	68.2	54.5	66	243	...
2.85	461	461	...	405	72.0	...	48.8	61.9	84.9	67.4	53.5	...	237	2.85
...	461	401	74.0	...	48.5	61.7	84.7	67.2	53.2	65	235	...
2.90	444	444	...	474	74.3	...	47.2	61.0	84.1	67.2	51.7	...	236	2.90
...	444	472	74.2	...	47.1	60.8	84.0	65.8	51.5	...	225	...
2.95	429	429	...	455	73.4	...	45.7	59.7	83.4	64.6	49.9	61	217	2.95
3.00	415	415	...	440	72.8	...	44.5	58.3	82.8	63.5	48.4	59	210	3.00
3.05	401	401	...	425	72.0	...	43.1	56.8	82.0	62.3	46.9	58	202	3.05
3.10	388	388	...	410	71.4	...	41.8	56.8	81.4	61.1	45.3	56	195	3.10
3.15	375	375	...	396	70.6	...	40.4	55.7	80.9	59.9	43.6	54	188	3.15
3.20	363	363	...	383	70.0	...	39.1	54.6	80.0	58.7	42.0	52	182	3.20
3.25	352	352	...	372	69.3	...	37.9	53.8	79.3	57.6	40.5	51	176	3.25
3.30	341	341	...	360	68.7	...	36.6	52.8	78.6	56.4	39.1	50	170	3.30
3.35	331	331	...	350	68.1	...	35.5	51.9	77.9	55.4	37.8	48	166	3.35
3.40	321	321	...	339	67.5	...	34.3	51.0	77.3	54.3	36.4	46	163	3.40
3.45	311	311	...	328	66.9	...	33.1	50.0	76.7	53.3	35.0	45	160	3.45
3.50	302	302	...	319	66.5	...	31.9	49.0	76.1	52.3	33.8	44	157	3.50
3.55	293	293	...	310	65.7	...	30.8	48.3	75.5	51.2	32.4	43	155	3.55
3.60	285	285	...	301	65.1	...	30.0	48.3	75.0	50.3	31.2	43	145	3.60
3.65	277	277	...	292	64.6	...	29.0	47.9	74.4	49.3	30.0	41	137	3.65
3.70	269	269	...	284	64.1	...	28.8	46.9	73.7	48.3	28.5	40	133	3.70
3.75	262	262	...	276	63.6	...	27.6	45.9	73.1	47.3	27.3	39	130	3.75
3.80	255	255	...	269	63.0	...	26.6	45.0	72.5	46.2	26.0	38	126	3.80
3.85	248	248	...	261	62.5	...	25.4	44.2	72.5	45.1	24.8	37	122	3.85
3.90	241	241	...	253	61.8	...	24.2	43.2	71.7	44.1	23.8	36	118	3.90
3.95	235	235	...	247	61.4	...	23.5	42.0	70.9	42.9	22.8	35	115	3.95
4.00	229	229	...	241	60.8	...	22.8	41.4	70.3	41.9	21.5	34	111	4.00
4.05	223	223	...	234	20.5	40.5	69.7	...	20.1	33	105	4.05
4.10	217	217	...	228	18.8	33	102	4.10
4.15	212	212	...	222	17.5	32	102	4.15
4.20	207	207	...	218	16.0	32	102	4.20
4.25	201	201	...	212	15.2	31	108	4.25
4.30	197	197	...	207	13.8	31	95	4.30
4.35	192	192	...	202	12.7	29	93	4.35
4.40	187	187	...	197	11.7	28	90	4.40
4.45	183	183	...	193	10.7	27	87	4.45
4.50	179	179	...	188	10.0	26	85	4.50
4.55	174	174	...	182	8.9	26	83	4.55
4.60	170	170	...	178	6.4	25	81	4.60
4.65	167	167	...	175	5.4	25	79	4.65
4.70	163	163	...	171	4.4	23	76	4.70
4.80	156	156	...	163	3.3	23	73	4.80
4.90	149	149	...	156	2.9	21	67	4.90
5.00	143	143	...	150	2.0	21	67	5.00
5.10	137	137	...	143	20	63	5.10
5.20	131	131	...	137	20	60	5.20
5.30	126	126	...	132	18	58	5.30
5.40	121	121	...	127	18	58	5.40
5.50	116	116	...	122	15	56	5.50
5.60	111	111	...	117	15	56	5.60

TABLE 3. Conversions Based on Vickers (DPH). The values in this table shown in bold-faced type correspond to the values shown in the corresponding joint SAE-ASM-ASTM Committee on Hardness Conversions as printed in ASTM Spec. E48-43T, Table 1. Values in () are beyond normal range and are given for information only.

Diamond pyramid hardness number, Vickers	Brinell hardness number.			Rockwell hardness number					Rockwell superficial hardness number.			Tensile strength (approx.) 1000 lb. per sq. in.	Shore sclero-scope hardness number	Diamond pyramid hardness number, Vickers			
	Standard ball	Hultgren ball	Tungsten carbide ball	Superficial Brale					15-N scale, 15-kg. load	30-N scale, 30-kg. load	45-N scale, 45-kg. load						
				10-mm. ball, 3000-kg. load	A-scale, 60-kg. load, Brale penetrator	B-scale, 100-kg. load, 1/8-in. dia. ball	C-scale, 150-kg. load, Brale penetrator	D-scale, 100-kg. load, Brale penetrator							Col. 2	Col. 3	Col. 4
940	85.6	68.0	76.9	93.2	84.4	75.4	97	...	940			
920	85.3	67.5	76.5	93.0	84.0	74.8	96	...	920			
900	85.0	67.0	76.1	92.9	83.6	74.2	95	...	900			
880	767	84.7	66.4	75.7	92.7	83.1	73.6	93	...	880			
860	757	84.4	65.9	75.3	92.5	82.7	73.1	92	...	860			
840	745	84.1	65.3	74.8	92.3	82.2	72.2	91	...	840			
820	733	83.8	64.7	74.3	92.1	81.7	71.8	90	...	820			
800	722	83.4	64.0	73.8	91.8	81.1	71.0	88	...	800			
780	710	83.0	63.3	73.3	91.5	80.4	70.2	87	...	780			
760	698	82.6	62.5	72.6	91.2	79.7	69.4	86	...	760			
740	684	82.2	61.8	72.1	91.0	79.1	68.6	84	...	740			
720	670	81.8	61.0	71.5	90.7	78.4	67.7	83	...	720			
700	657	81.3	60.1	70.8	90.3	77.6	66.7	81	...	700			
680	...	615	647	81.0	59.7	70.5	90.1	77.2	66.2	80	...	680			
660	...	603	638	80.8	59.2	70.1	89.8	76.8	65.7	79	...	660			
640	...	597	630	80.6	58.8	69.8	89.7	76.4	65.3	78	...	640			
620	...	590	620	80.3	58.3	69.4	89.5	75.9	64.7	77	...	620			
600	...	585	611	80.0	57.8	69.0	89.2	75.5	64.1	76	...	600			
580	...	578	601	79.8	57.3	68.7	89.0	75.1	63.5	75	...	580			
560	...	571	591	79.5	56.8	68.3	88.8	74.6	63.0	74	...	560			
540	...	564	582	79.2	56.3	67.9	88.5	74.2	62.4	73	...	540			
520	...	557	573	78.9	55.7	67.5	88.2	73.6	61.7	72	...	520			
500	...	550	564	78.6	55.2	67.0	88.0	73.2	61.2	71	...	500			
480	...	542	554	78.4	54.7	66.7	87.8	72.7	60.5	70	...	480			
460	...	535	545	78.0	54.1	66.2	87.5	72.1	59.9	69	...	460			
440	...	527	535	77.8	53.6	65.8	87.2	71.7	59.3	68	...	440			
420	...	519	525	77.6	53.0	65.4	86.9	71.2	58.6	67	...	420			
400	...	512	517	77.0	52.3	64.8	86.3	70.0	57.0	66	...	400			
380	...	503	507	76.4	51.7	64.4	86.0	69.5	56.2	65	...	380			
360	...	495	488	76.4	50.5	63.9	85.7	68.3	55.6	64	...	360			
340	...	487	488	76.1	49.8	63.5	85.4	67.7	55.2	63	...	340			
320	...	479	479	75.7	49.1	62.9	85.0	67.3	54.7	62	...	320			
300	...	471	471	75.3	48.1	62.2	84.5	66.7	53.9	61	...	300			

APPENDIX IV

Col. 1	Col. 2	Col. 3	Col. 4	Col. 5	Col. 6	Col. 7	Col. 8	Col. 9	Col. 10	Col. 11	Col. 12	Col. 13	Col. 14
490	456	460	460	74.9	...	48.4	61.6	84.7	67.1	53.1	64	234	490
480	448	452	452	74.5	...	47.7	61.5	84.5	67.4	52.2	64	230	480
470	441	442	442	74.1	...	46.9	60.7	83.9	65.7	51.3	64	224	470
460	433	433	433	73.6	...	45.1	59.1	83.2	64.9	50.4	62	220	460
455	425	425	425	73.3	...	44.3	58.8	82.8	64.3	49.4	62	214	455
440	415	415	415	72.8	...	43.6	58.2	82.3	63.5	48.4	59	210	440
430	405	405	405	72.3	...	42.7	57.5	81.8	62.7	47.4	57	204	430
420	397	397	397	71.8	...	41.8	56.8	81.4	61.9	46.4	57	200	420
410	388	388	388	71.3	...	40.8	56.1	81.0	61.1	45.3	55	195	410
400	379	379	379	70.8	...	39.8	55.2	80.3	60.2	44.1	55	190	400
390	369	369	369	70.3	(110 0)	38.8	54.4	79.8	59.3	42.9	52	185	390
380	360	360	360	69.8	(110 0)	37.7	53.6	79.2	58.4	41.7	52	180	380
370	350	350	350	69.2	(110 0)	36.6	52.8	78.6	57.4	40.4	50	175	370
360	340	340	340	68.7	(108 0)	35.5	51.9	78.0	56.4	39.1	50	170	360
350	331	331	331	68.1	(108 0)	34.4	51.1	77.4	55.4	37.8	47	165	350
340	322	322	322	67.6	(108 0)	33.3	50.2	76.8	54.4	36.5	47	161	340
330	313	313	313	67.0	(107 0)	32.2	49.4	76.2	53.6	35.2	45	156	330
320	303	303	303	66.4	(107 0)	31.0	48.4	75.6	52.3	33.9	45	151	320
310	294	294	294	65.8	(105.5)	29.8	47.5	74.9	51.3	32.5	42	146	310
300	284	284	284	65.2	(105.5)	28.8	46.5	74.6	50.2	31.1	41	141	300
290	275	275	275	64.8	(104.5)	27.8	46.0	74.2	49.0	29.5	41	136	290
285	270	270	270	64.5	(103.5)	27.1	45.3	73.8	48.4	28.7	40	134	285
280	265	265	265	64.2	(103.5)	26.4	44.9	73.4	47.8	27.9	40	131	280
275	261	261	261	63.8	(102.0)	25.6	44.3	73.0	47.2	27.1	38	129	275
270	256	256	256	63.5	(102.0)	24.8	43.7	72.6	46.4	26.2	38	126	270
265	252	252	252	63.1	(101.0)	24.0	43.1	72.1	45.7	25.2	37	124	265
260	247	247	247	62.7	(101.0)	23.1	42.2	71.6	45.0	24.3	37	121	260
255	243	243	243	62.4	99.5	22.2	41.7	71.1	44.2	23.2	36	119	255
250	238	238	238	62.0	99.5	21.3	41.1	70.6	43.4	22.2	34	116	250
245	233	233	233	61.6	98.1	20.3	40.3	70.1	42.5	21.1	34	114	245
240	228	228	228	61.2	98.1	20.3	40.3	69.6	41.7	19.9	33	111	240
235	223	223	223	60.7	(18.0)	19.3	32	108	235
230	219	219	219	60.7	(18.0)	18.0	32	106	230
225	215	215	215	60.7	(15.7)	17.1	30	101	225
220	209	209	209	60.7	(15.7)	16.4	30	97	220
210	200	200	200	60.7	(13.4)	15.1	28	92	210
200	200	200	200	60.7	(11.0)	14.3	28	88	200
190	190	190	190	60.7	(8.5)	13.6	26	84	190
181	181	181	181	60.7	(8.5)	12.9	25	79	181
180	171	171	171	60.7	(6.0)	12.2	24	75	180
170	162	162	162	60.7	(3.0)	11.5	22	71	170
160	152	152	152	60.7	(0.0)	10.8	21	66	160
150	143	143	143	60.7	(0.0)	10.1	20	62	150
140	133	133	133	60.7	(0.0)	9.4	20	57	140
130	124	124	124	60.7	(0.0)	8.7	20	57	130
120	114	114	114	60.7	(0.0)	8.0	20	57	120
110	105	105	105	60.7	(0.0)	7.3	20	57	110
95	95	95	95	60.7	(0.0)	6.6	20	57	95
90	86	86	86	60.7	(0.0)	5.9	20	57	90
86	86	86	86	60.7	(0.0)	5.2	20	57	86
81	81	81	81	60.7	(0.0)	4.5	20	57	81

BIBLIOGRAPHY

1. Aitchison, L.: "Engineering Steels," MacDonald and Evans, London, 1921, 396 pp.
2. Almen, J. O.: Shot Blasting to Increase Fatigue Resistance, *SAE Trans.*, v. 51, 1943, pp. 248-268.
3. American Iron and Steel Institute: Possible Alternates for Nickel, Chromium, and Chromium-Nickel Constructional Alloy Steels, "Contributions to the Metallurgy of Steel," No. 5, The Institute, New York, Jan. 1942, 143 pp.
4. American Iron and Steel Institute: Supplementary National Emergency Steels NE 9400, 9500, and 9600 Series, "Contributions to the Metallurgy of Steel," No. 8, The Institute, New York, Sept. 1942, 89 pp.
5. American Society for Metals: "Metals Handbook," The Society, Cleveland, 1948 ed., 1444 pp.
6. American Society for Testing Materials: Standard Classification of Austenite Grain Size in Steels, *A.S.T.M. Standards*, 1946, Part I-A, Ferrous Metals, pp. 682-684.
7. American Society for Testing Materials: Tentative Method of End-Quench Test for Hardenability of Steel, *A.S.T.M. Standards*, 1946, Part I-A, Ferrous Metals, A255-46T, pp. 983-989.
8. American Welding Society: "Welding Handbook," The Society, New York, 1942, 1592 pp.
9. Antia, D. P., S. G. Fletcher, and M. Cohen: Structural Changes during the Tempering of High-Carbon Steel, *Trans. Am. Soc. Metals*, v. 32, 1944, pp. 290-332.
10. Arbuzov, M., and G. Kurdyumov: (The Form of Carbon in Tempered Steel), *J. Tech. Physics U.S.S.R.*, v. 10, 1940, pp. 1093-1100 (in Russian).
11. Asimow, M., and M. A. Grossmann: Hardening Characteristics of Various Shapes, *Trans. Am. Soc. Metals*, v. 28, 1940, pp. 949-985.
12. Asimow, M., W. F. Craig, and M. A. Grossmann: Correlation between Jominy Test and Quenched Round Bars, *SAE Trans.*, v. 49, 1941, pp. 283-292.
13. Austin, C. R.: Effect of Elements in Solid Solution on Hardness and Response to Heat Treatment of Iron Binary Alloys, *Trans. Am. Soc. Metals*, v. 31, 1943, pp. 321-339.

14. Austin, J. B., and M. J. Day: Chemical Equilibrium as a Guide in the Control of Furnace Atmospheres—A Review of Equilibrium Data, in "Controlled Atmospheres," American Society for Metals, Cleveland, 1942, pp. 20-56.
15. Austin, J. B.: The Effect of Changes in Condition of Carbides on Some Properties of Steel, *Trans. Am. Soc. Metals*, v. 38, 1947, pp. 28-69.
16. Bain, E. C., and Z. Jeffries: Cause of Red Hardness in High-Speed Steel, *Iron Age*, v. 112, 1923, pp. 805-810.
17. Bain, E. C.: Factors Affecting the Inherent Hardenability of Steel, *Trans. Am. Soc. Steel Treat.*, v. 20, 1932, pp. 385-428.
18. Bain, E. C.: Some Characteristics Common to Carbon and Alloy Steels, *Yearbook Am. Iron Steel Inst.*, 1934, pp. 86-128.
19. Bain, E. C.: "Functions of the Alloying Elements in Steel," American Society for Metals, Cleveland, 1939, 312 pp.
20. Boegehold, A. L.: Plain Carbon Steel—Its Utility for Automobiles, *Metal Progress*, v. 31, 1937, pp. 147-152.
21. Boegehold, A. L.: Advantages of Alloy Steels, *Metal Progress*, v. 31, 1937, pp. 265-269.
22. Boegehold, A. L.: Selection of Automotive Steel on the Basis of Hardenability, *SAE Trans.*, v. 52, 1944, pp. 472-485.
23. Boegehold, A. L.: Hardenability of NE 8600H Steels (Metal Progress Data Sheet), *Metal Progress*, v. 50, 1946, p. 1220-B.
24. Boyd, L. H., and J. Field: Calculation of the Standard End-Quench Hardenability Curve from Chemical Composition and Grain Size, "Contributions to the Metallurgy of Steel," No. 12, American Iron and Steel Institute, New York, 1946, 25 pp.
25. British Standards Institution: B. S. 971: Wrought Steels (carbon and alloy steels) T.A.C. 1-33 (Companion Document to B. S. 970, Dealing with Steels. En. 1-58), The Institution, London, 1941, 98 pp. (reissued 1944).
26. Brophy, G. R.: Cycle Annealing of Hypoeutectoid Steels, *Iron Age*, v. 156, 1945, Dec. 13, pp. 69-71.
27. Brophy, G. R., and A. J. Miller: An Appraisal of the Factor Method for Calculating the Hardenability of Steel from Composition, *Trans. Am. Inst. Min. Met. Eng.*, v. 167, 1946, pp. 654-669.
28. Burns, J. L., T. L. Moore, and R. S. Archer: Quantitative Hardenability, *Trans. Am. Soc. Metals*, v. 26, 1938, pp. 1-36.
29. Burns, J. L., and G. C. Riegel: Hardenability of Plain Carbon Steels, in "Hardenability of Alloy Steels," American Society for Metals, Cleveland, 1939, pp. 262-301.
30. Chiswick, H. H., and A. B. Greninger: Influence of Nickel, Molybdenum, Cobalt, and Silicon on the Kinetics and A_r'' Temperatures of the Austenite to Martensite Transformation in Steels, *Trans. Am. Soc. Metals*, v. 32, 1944, pp. 483-520.
31. Comstock, G. F., and F. S. Urban: Titanium in Steel, in "Metals Handbook," American Society for Metals, Cleveland, 1948, pp. 478-482.

32. Crafts, W., and J. L. Lamont: Some Effects of Deoxidizers in Low-Carbon 1.5 Per Cent Chromium Steel, *Trans. Am. Soc. Metals*, v. 27, 1939, pp. 268-288.
33. Crafts, W., J. J. Egan, and W. D. Forgeng: Formation of Inclusions in Steel Castings, *Trans. Am. Inst. Min. Met. Eng.*, v. 140, 1940, pp. 233-26.
34. Crafts, W., and C. M. Offenbauer: Carbides in Low-Chromium Steel *Trans. Am. Inst. Min. Met. Eng.*, v. 150, 1942, pp. 275-282.
35. Crafts, W., and J. L. Lamont: The Effect of Silicon on Hardenability, *Trans. Am. Inst. Min. Met. Eng.*, v. 154, 1943, pp. 386-394.
36. Crafts, W., and J. L. Lamont: Effect of Some Elements on Hardenability, *Trans. Am. Inst. Min. Met. Eng.*, v. 158, 1944, pp. 157-167.
37. Crafts, W., and J. L. Lamont: Addition Method for Calculating Rockwell C Hardness of the Jominy Hardenability Test, *Trans. Am. Inst. Min. Met. Eng.*, v. 167, 1946, pp. 698-718.
38. Crafts, W., and J. L. Lamont: Effect of Alloys in Steel on Resistance to Tempering, *Trans. Am. Inst. Min. Met. Eng.*, v. 172, 1947, pp. 222-243.
39. Crafts, W., and J. L. Lamont: The Izod Impact Strength of Heat-Treated Alloy Steel, *Trans. Am. Inst. Min. Met. Eng.*, v. 172, 1947, pp. 303-322.
40. Davenport, E. S., and E. C. Bain: Transformation of Austenite at Constant Subcritical Temperatures, *Trans. Am. Inst. Min. Met. Eng.*, v. 90, 1930, pp. 117-154.
41. Davenport, E. S.: Isothermal Transformation in Steels, *Trans. Am. Soc. Metals*, v. 27, 1939, pp. 837-886.
42. Davenport, E. S., R. A. Grange, and R. J. Hafsten: Influence of Austenite Grain Size upon Isothermal Transformation Behavior of SAE 4140 Steel, *Trans. Am. Inst. Min. Met. Eng.*, v. 145, 1941, pp. 301-314.
43. Digges, T. G.: Transformation of Austenite on Quenching High-Purity Iron-Carbon Alloys, *Trans. Am. Soc. Metals*, v. 28, 1940, pp. 575-607.
44. Edson, A. P.: [Discussion of paper by M. A. Grossmann] Hardenability Calculated from Chemical Composition, *Trans. Am. Inst. Min. Met. Eng.*, v. 150, 1942, pp. 255-257.
45. Ellis, O. W.: Pseudomorphs of Pearlite in Quenched Steel, *Trans. Am. Soc. Metals*, v. 32, 1944, pp. 270-289.
46. Elmendorf, H. J.: The Effect of Varying Amounts of Martensite upon the Isothermal Transformation of Austenite Remaining after Controlled Quenching, *Trans. Am. Soc. Metals*, v. 33, 1944, pp. 236-260.
47. Engel, E. H.: The Softening Rate of a Steel when Tempered from Different Initial Structures, *Trans. Am. Soc. Metals*, v. 27, 1939, pp. 1-17.
48. Esser, W., and H. Cornelius: Die Vorgänge beim Anlassen abgeschreckter Stähle (The Phenomena Underlying the Tempering of Quenched Steels), *Archiv f. d. Eisenhüttenwesen*, v. 7, 1933-1934 (1934), pp. 693-697.
49. Field, J.: Calculation of Jominy End-Quench Curve from Analysis, *Metal Progress*, v. 43, 1943, pp. 402-405.
50. Fletcher, S. G., and M. Cohen: The Effect of Carbon on the Tempering of Steel, *Trans. Am. Soc. Metals*, v. 32, 1944, pp. 333-362.

51. Fletcher, S. G., and M. Cohen: The Dimensional Stability of Steel, Part I—Subatmospheric Transformation of Retained Austenite, *Trans. Am. Soc. Metals*, v. 34, 1945, pp. 216–249.
52. French, H. J.: “The Quenching of Steels,” American Society for Steel Treating, Cleveland, 1930, 177 pp.
53. Funk, E. J., Jr., and D. Von Ludwig: A Critical Survey of Controlled Atmospheres, *Iron Age*, v. 158, 1946, Sep. 26, pp. 74–79.
54. Gensamer, M., E. B., Pearsall, W. S. Pellini, and J. R. Low, Jr.: The Tensile Properties of Pearlite, Bainite, and Spheroidite, *Trans. Am. Soc. Metals*, v. 30, 1942, pp. 983–1020.
55. Gill, J. P., R. S. Rose, G. A. Roberts, H. G. Johnstin, and R. B. George: “Tool Steels,” American Society for Metals, Cleveland, 1944, p. 290.
56. Gordon, P., and M. Cohen: The Transformation of Retained Austenite in High-Speed Steel at Subatmospheric Temperatures, *Trans. Am. Soc. Metals*, v. 30, 1942, pp. 569–591.
57. Grange, R. A., and J. M. Kiefer: Transformation of Austenite on Continuous Cooling and Its Relation to Transformation at Constant Temperature, *Trans. Am. Soc. Metals*, v. 29, 1941, pp. 85–116.
58. Grange, R. A., and T. M. Garvey: Factors Affecting the Hardenability of Boron-Treated Steels, *Trans. Am. Soc. Metals*, v. 37, 1946, pp. 136–191.
59. Grange, R. A., and H. M. Stewart: The Temperature Range of Martensite Formation, *Trans. Am. Inst. Min. Met. Eng.*, v. 167, 1946, pp. 467–501.
60. Grange, R. A.: Factors Influencing the Pearlitic Microstructure of Annealed Hypoeutectoid Steel, *Trans. Am. Soc. Metals*, v. 38, 1947, pp. 879–908.
61. Great Lakes Steel Corporation: “Properties and Characteristics of N-A-X 9100 Series,” The Corporation, Detroit, undated (1941?), unpagged.
62. Greninger, A. B., and A. R. Troiano: Kinetics of the Austenite to Martensite Transformation in Steel, *Trans. Am. Soc. Metals*, v. 28, 1940, pp. 537–574.
63. Greninger, A. B.: The Martensite Thermal Arrest in Iron-Carbon Alloys and Plain Carbon Steels, *Trans. Am. Soc. Metals*, v. 30, 1942, pp. 1–26.
64. Grossmann, M. A.: Shrinkage and Expansion of High-Speed Steel Due to Heat Treatment, *Chem. Met. Engineering*, v. 27, 1922, pp. 541–544.
65. Grossmann, M. A., M. Asimow, and S. F. Urban: Hardenability, Its Relation to Quenching, and Some Quantitative Data, in “Hardenability of Alloy Steels,” American Society for Metals, Cleveland, 1939, pp. 124–196.
66. Grossmann, M. A.: “Principles of Heat Treatment,” American Society for Metals, Cleveland, 1940, 244 pp.
67. Grossmann, M. A., and M. Asimow: Hardenability and Quenching, *Iron Age*, v. 145, 1940, April 25, pp. 25–29; May 2, pp. 39–45.
68. Grossmann, M. A.: Hardenability Calculated from Chemical Composition, *Trans. Am. Inst. Min. Met. Eng.*, v. 150, 1942, pp. 227–259.
69. Grossmann, M. A.: Toughness and Fracture of Hardened Steels, *Trans. Am. Inst. Min. Met. Eng.*, v. 167, 1946, pp. 39–79.

70. Hankins, G. A., and M. L. Becker: The Effect of Surface Conditions Produced by Heat Treatment on the Fatigue Resistance of Spring Steels, *J. Iron Steel Inst.*, v. 124, 1931, pp. 387-460.
71. Harder, O. E., and R. L. Dowdell: The Decomposition of the Austenitic Structure in Steels—Part II, *Trans. Am. Soc. Steel Treat.* v. 11, 1927, pp. 391-398.
72. Herty, C. H., Jr., D. L. McBride, and E. H. Hollenback: Which Grain Size?, *Trans. Am. Soc. Metals*, v. 25, 1937, pp. 297-314.
73. Hodge, J. M., and M. A. Orehoski: Hardenability Effects in Relation to the Percentage of Martensite, *Trans. Am. Inst. Min. Met. Eng.*, v. 167, 1946, pp. 502-512.
74. Hodge, J. M., and M. A. Orehoski: Relationship between Hardenability and Percentage of Martensite in Some Low-Alloy Steels, *Trans. Am. Inst. Min. Met. Eng.*, v. 167, 1946, pp. 627-642.
75. Hollomon, J. H., and L. D. Jaffe: Time-Temperature Relations in Tempering Steel, *Trans. Am. Inst. Min. Met. Eng.*, v. 162, 1945, pp. 223-249.
76. Hollomon, J. H., L. D. Jaffe, and M. R. Norton: Anisothermal Decomposition of Austenite, *Trans. Am. Inst. Min. Met. Eng.*, v. 167, 1946, pp. 419-441.
77. Hollomon, J. H.: Temper Brittleness, *Trans. Am. Soc. Metals*, v. 36, 1946, pp. 473-542.
78. Hollomon, J. H., and L. D. Jaffe: The Hardenability Concept, *Trans. Am. Inst. Min. Met. Eng.*, v. 167, 1946, pp. 601-616.
79. Hollomon, J. H., L. D. Jaffe, D. E. McCarthy, and M. R. Norton: The Effects of Microstructure on the Mechanical Properties of Steel, *Trans. Am. Soc. Metals*, v. 38, 1947, pp. 807-847.
80. Hostetter, H. E.: Determination of Most Efficient Alloy Combinations for Hardenability, *Trans. Am. Inst. Min. Met. Eng.*, v. 167, 1946, pp. 643-653.
81. Houdremont, E., H. Bennek, and H. Schrader: Härbarkeit und Anlassbeständigkeit von Stählen mit schwerlöslichen Sonderkarbiden (Hardenability and Resistance to Tempering of Steels with Difficultly Soluble Special Carbides), *Archiv f. d. Eisenhüttenwesen*, v. 6, 1932-1933 (1932), pp. 24-34.
82. [E. F.] Houghton and Co., Research Staff: "'Interrupted' Quenching in Salt," The Company, Philadelphia, undated, 11 pp.
83. Jackson, C. E., and A. L. Christenson: The Effect of Quenching Temperature on the Results of the End-Quench Hardenability Test, *Trans. Am. Inst. Min. Met. Eng.*, v. 158, 1944, pp. 125-137.
84. Jaffe, L. D., and J. H. Hollomon: Hardenability and Quench Cracking, *Trans. Am. Inst. Min. Met. Eng.*, v. 167, 1946, pp. 617-626.
85. Janitzky, E. J., and M. Baeyertz: The Marked Similarity in Tensile Properties of Several Heat-Treated SAE Steels, in "Metals Handbook," American Society for Metals, Cleveland, 1939 ed., pp. 515-518.
86. Johnson, F.: "Heat Treatment of Carbon Steels," Chemical Publishing Co., Inc., Brooklyn, N. Y., 1946, 204 pp.

87. Jominy, W. E., and A. L. Boegehold: A Hardenability Test for Carburizing Steel, *Trans. Am. Soc. Metals*, v. 26, 1938, pp. 574-606.
88. Jominy, W. E.: Hardenability Tests, in "Hardenability of Alloy Steels," American Society for Metals, Cleveland, 1939, pp. 66-94.
89. Jominy, W. E.: A Hardenability Test for Shallow-Hardening Steels, *Trans. Am. Soc. Metals*, v. 27, 1939, pp. 1072-1089.
90. Jominy, W. E.: Commercial Aspects of Hardenability Tests, *Metal Progress*, v. 38, 1940, pp. 685-690.
91. Klier, E. P., and T. Lyman: The Bainite Reaction in Hypoeutectoid Steels, *Trans. Am. Inst. Min. Met. Eng.*, v. 158, 1944, pp. 394-422.
92. Koebel, N. K.: Methods for Determining the Degree of Carburization or Decarburization and Evaluating Controlled Atmospheres, in "Controlled Atmospheres," American Society for Metals, Cleveland, 1942, pp. 128-158.
93. Kopecki, E. S.: The P-V Test—A New Hardenability Measure, *Iron Age*, v. 158, 1946, Nov. 14, pp. 66-69.
94. Kramer, I. R., R. H. Hafner, and S. L. Toleman: Effect of Sixteen Alloying Elements on Hardenability of Steel, *Trans. Am. Inst. Min. Met. Eng.*, v. 158, 1944, pp. 138-156.
95. Kramer, I. R., S. Siegel, and J. G. Brooks: Factors for the Calculation of Hardenability, *Trans. Am. Inst. Min. Met. Eng.*, v. 167, 1946, pp. 670-697.
96. Lamont, J. L.: How to Estimate Hardening Depth in Bars, *Iron Age*, v. 152, 1943, Oct. 14, pp. 64-70.
97. Liedholm, C. A.: Continuous Cooling Transformation Diagram from Modified End-Quench Method, *Metal Progress*, v. 45, 1944, pp. 94-99.
98. Manning, G. K.: End-Quench Hardenability versus Hardness of Quenched Rounds, *Metal Progress*, v. 50, 1946, pp. 647-652.
99. Manning, G. K., and C. H. Lorig: The Relationship between Transformation at Constant Temperature and Transformation during Cooling, *Trans. Am. Inst. Min. Met. Eng.*, v. 167, 1946, pp. 442-466.
100. Martin, A. G., and J. N. Pappas: Quenching—"Gun" Steel, Watertown Arsenal Laboratory Report No. 632/13, Nov. 5, 1945.
101. Mathews, J. A.: Austenite and Austenitic Steels, *Trans. Am. Inst. Min. Met. Eng.*, v. 71, 1925, pp. 568-596.
102. McMulkin, F. J.: Practical Tool Room Heat Treatment, *Iron Age*, v. 157, 1946, June 27, pp. 55-59.
103. McMullan, O. W.: A Hardenability Test for Low-Carbon and Shallow-Hardening Steels, *Trans. Am. Soc. Metals*, v. 35, 1945, pp. 584-608.
104. Morral, F. R.: Heat-Treating Diagrams—S or T-T-T Curves, *Metal Progress*, v. 48, 1945, pp. 818-831.
105. Morral, F. R.: Compilation of Isothermal Diagrams, *Wire and Wire Products*, v. 24, 1949, Jan., pp. 39-47.
106. Parker, C. M.: Selecting Steels by Hardenability Bands, *Materials and Methods*, v. 25, 1947, March 25, pp. 68-72.
107. Patton, W. G.: Mechanical Properties of NE, SAE, and Other Hardened Steels, *Metal Progress*, v. 43, 1943, pp. 726-733.

108. Payson, P., and W. Hodapp: Austempering of SAE Alloy Steels Not Always Advantageous, *Metal Progress*, v. 35, 1939, pp. 358-362.
109. Payson, P., W. L. Hodapp, and J. Leeder: The Spheroidizing of Steel by Isothermal Transformation, *Trans. Am. Soc. Metals*, v. 28, 1940, pp. 306-332.
110. Payson, P., and C. H. Savage: Martensite Reactions in Alloy Steels, *Trans. Am. Soc. Metals*, v. 33, 1944, pp. 261-280.
111. Peterson, R. E.: "Contributions to the Mechanics of Solids," The MacMillan Company, New York, 1938, pp. 179-183.
112. Post, C. B., O. V. Greene, and W. H. Fenstermacher: Hardenability of Shallow-Hardening Steels, *Trans. Am. Soc. Metals*, v. 30, 1942, pp. 1202-1254.
113. Post, C. B., M. C. Fetzer, and W. H. Fenstermacher: Air Hardenability of Steels, *Trans. Am. Soc. Metals*, v. 35, 1945, pp. 85-111.
114. Protheroe, H. T.: The Influence of Melting Conditions on the Physical Properties of Steel Castings, *J. Iron Steel Inst.*, v. 150, 1944, pp. 157P-182P.
115. Research Laboratory, United States Steel Corporation: "Atlas of Isothermal Transformation Diagrams," The Corporation, Pittsburgh, 1943, 103 pp.
116. Riegel, G. C.: How a Large Tractor Company Controls Quality of Purchased Material, *Iron Age*, v. 128, 1931, pp. 1426-1429.
117. Riegel, G. C.: [Discussion of Paper by H. Scott on] Factors Determining the Impact Resistance of Hardened Carbon Steels, *Trans. Am. Soc. Metals*, v. 22, 1934, pp. 1167-1169.
118. Roberts, G. A., and R. F. Mehl: The Mechanism and the Rate of Formation of Austenite from Ferrite-Cementite Aggregates, *Trans. Am. Soc. Metals*, v. 31, 1943, pp. 613-650.
119. Roberts, G. A., A. H. Grobe, and C. F. Moersch, Jr.: The Tempering of High-Alloy Tool Steels, *Trans. Am. Soc. Metals*, v. 39, 1947, pp. 521-548.
120. Rose, K.: Engineering File Facts No. 27, *Metals and Alloys*, v. 18, 1943, p. 1095.
121. Rowland, E. S., Jr., J. Welchner, and R. H. Marshall: The Effect of Several Variables on the Hardenability of High-Carbon Steels, *Trans. Am. Inst. Min. Met. Eng.*, v. 158, 1944, pp. 168-182.
122. Russell, T. F.: Some Mathematical Considerations on the Heating and Cooling of Steel, in "First Report of the Alloy Steels Research Committee," The Iron and Steel Institute, London, 1936, Special Report No. 14, Section IX, Part C, pp. 149-187 (156).
123. Sauveur, A.: "The Metallography and Heat Treatment of Iron and Steel," 4th ed., McGraw-Hill Book Company, Inc., New York, 1935, 531 pp.
124. Scott, H.: The Problem of Quenching Media for the Hardening of Steel, *Trans. Am. Soc. Metals*, v. 22, 1934, pp. 577-604.
125. Scott, H., and T. H. Gray: Dimensional Changes on Hardening High-Chromium Tool Steels, *Trans. Am. Soc. Metals*, v. 29, 1941, pp. 503-518.
126. Shepherd, B. F.: Inherent Hardenability Characteristics of Tool Steel, *Trans. Am. Soc. Metals*, v. 17, 1930, pp. 90-110.

127. Shepherd, B. F.: The P-F Characteristic of Steel, *Trans. Am. Soc. Metals*, v. 22, 1934, pp. 979-1016.
128. Shepherd, B. F.: Martempering, *Iron Age*, v. 151, 1943, Jan. 28, pp. 50-52; Feb. 4, pp. 45-48.
129. Shepherd, B. F.: Hardenability of Shallow-Hardening Steels Determined by the P-V Test, *Trans. Am. Soc. Metals*, v. 38, 1947, pp. 354-397.
130. Sims, C. E., and F. B. Dahle: Effect of Aluminum on the Properties of Medium-Carbon Cast Steel, *Trans. Am. Foundrymen's Assoc.*, v. 46, 1938, pp. 65-132.
131. Sisco, F. T.: "The Alloys of Iron and Carbon, Vol. II—Properties," McGraw-Hill Book Company, Inc., New York, 1937, pp. 462-469.
132. Sisco, F. T.: "Modern Metallurgy for Engineers," Pitman Publishing Corporation, New York, 2d ed., 1948, 499 pp.
133. [The] Society of Automotive Engineers and American Iron and Steel Institute: Hardenability of Alloy Steels, "Contributions to the Metallurgy of Steel," No. 11, The Society, New York, June 1947, 146 pp.
134. [The] Society of Automotive Engineers: "SAE Handbook," The Society, New York, 1948 ed., 877 pp.
135. Tobin, H., and R. L. Kenyon: Austenitic Grain Size of Eutectoid Steel, *Trans. Am. Soc. Metals*, v. 26, 1938, pp. 133-152.
136. Vilella, J. R.: "Metallographic Technique for Steel," American Society for Metals, Cleveland, 1938, 86 pp.
137. Welchner, J., E. S. Rowland, and J. E. Ubben: Effect of Time, Temperature, and Prior Structure on the Hardenability of Several Alloy Steels, *Trans. Am. Soc. Metals*, v. 32, 1944, pp. 521-552.
138. Wellauer, E. J.: Hardenability Test for Quenched and Tempered Steel, *Iron Age*, v. 158, 1946, Sep. 5, pp. 62-66.
139. Zimmerman, J. G., R. H. Aborn, and E. C. Bain: Some Effects of Small Additions of Vanadium to Eutectoid Steel, *Trans. Am. Soc. Metals*, v. 25, 1937, pp. 755-787.

NAME INDEX

(Item numbers in the Bibliography are in **boldface**; numbers of the pages where the reference is quoted follow the boldface numerals.)

- Aborn, R. H., **139**, 27
Aitchison, L., 1, 196
Almen, J. O., 2, 208
American Iron and Steel Institute, 24;
3, 113; 4, 113; **133**, 139, 141, 142,
143, 144, 235-246
American Iron and Steel Institute, Techni-
cal Committee on Alloy Steel, 140
American Society for Metals, 5, 15, 16,
24, 124, 125
American Society for Testing Materials,
6, 23; 7, 112, 113, 116
American Welding Society, 8, 218
Antia, D. P., 9, 148, 149
Arbuzov, M., 10, 148
Archer, R. S., **28**, 87, 88, 89, 90, 123, 124
Arnold, J. O., 5
Asimow, M., 11, 63; 11, 68, 96, 97, 122;
12, 120, 121; **65**, 63, 64, 92, 93, 94,
95, 96, 120; **67**, 63
Austin, C. R., 13, 85
Austin, J. B., 14, 30; 15, 171, 172
- Baeyerztz, M., **85**, 105, 187, 188, 189, 193,
194
Bain, E. C., 10; 16, 172; 17, 33, 34; **18**,
85; 19, 17, 18, 85, 149, 155, 156, 159,
175, 176, 199; **40**, 35; **139**, 27
Becker, M. L., 70, 208
Bennek, H., **81**, 172
Bergman, T. O., 4
Boegehold, A. L., 12, 118, 119; **20**, 28;
21, 28; **22**, 87, 88; **23**, 142, 143; **87**, 91,
111, 116, 117, 118
- Boyd, L. H., **24**, 100, 101, 102, 105, 129,
130
Brearley, H., 196
British Standards Institution, **25**, 206
Brooks, J. G., **95**, 104, 121, 221
Brophy, G. R., **26**, 40, 41; **27**, 121
Burns, J. L., **28**, 87, 88, 89, 99, 123, 124;
29, 99
- Chiswik, H. H., 30, 48
Christenson, A. L., **83**, 61
Cohen, M., 9, 148, 149; **50**, 150, 151, 155;
51, 48; **56**, 48
Comstock, G. F., 31, 86
Cornelius, H., **48**, 148, 149
Crafts, W., 12; **32**, 218, 224; **33**, 194; **34**,
173; **35**, 102, 121; **36**, 104, 121, 221;
37, 87, 88, 130, 132, 133, 134, 135,
136, 137, 139, 225; **38**, 134, 155, 156,
157, 158, 160, 161, 162, 163, 164,
165, 166, 167, 171, 172, 176, 181,
225; **39**, 134, 200, 201, 204
Craig, W. F., 12, 120, 121
- Dahle, F. B., 130, 194
Davenport, E. S., 10; **40**, 35; **41**, 36, 44,
46, 86, 87; **42**, 45, 46
Davy, H., 4
Day, M. J., 14, 30
Digges, T. G., **43**, 48
Dowdell, R. L., 71, 48
- Edson, A. P., **44**, 104
Egan, J. J., 33, 194

- Ellis, O. W., 45, 23
 Elmendorf, H. J., 46, 48
 Engel, E. H., 47, 153, 154
 Esser, W., 48, 148, 149
- Fenstermacher, W. H., 112, 123, 125;
 113, 123, 127
 Fetzer, M. C., 113, 123, 127
 Field, J., 12; 24, 100, 101, 102, 105, 129,
 130; 49, 89, 96, 129, 130, 131, 132,
 134, 220
 Fletcher, S. G., 9, 148, 149; 50, 150, 151,
 155; 51, 48
 Forging, W. D., 25, 39, 40, 42, 43; 33, 194
 French, H. J., 11, 54; 52, 55, 57, 58, 59,
 60, 61, 62
 Funk, E. J., Jr., 53, 208
- Garvey, T. M., 58, 107
 General Motors Company, Research
 Laboratory Division, 117
 Gensamer, M., 86; 54, 86
 George, R. B., 55, 150
 Gill, J. P., 55, 150
 Gordon, P., 56, 48
 Grange, R. A., 42, 45, 46; 57, 50, 51; 58,
 107; 59, 48; 60, 40, 216
 Gray, T. H., 125, 218
 Great Lakes Steel Corporation, 61, 224
 Greene, O. V., 112, 123, 125
 Greninger, A. B., 10; 30, 48; 62, 37, 47,
 48; 63, 48
 Grobe, A. H., 119, 174
 Grossmann, M. A., 11, 54; 11, 68, 96, 97,
 122; 12, 120, 121; 64, 218; 65, 63, 64,
 92, 93, 94, 95, 96, 120; 66, 55, 65, 66,
 89, 90, 198, 199; 67, 63; 68, 96, 99,
 100, 101, 102, 104, 105, 121, 128,
 221, 222; 69, 199, 204
 Guillet, L., 5
- Hadfield, R. A., 5
 Hafner, R. H., 94, 104, 121
 Hafsten, R. J., 42, 45, 46
 Hankins, G. A., 70, 208
 Harder, O. E., 71, 48
 Herty, C. H., Jr., 72, 99
 Heyn, E., 5
 Hodapp, W., 108, 199; 109, 40
 Hodge, J. M., 73, 105, 106, 121, 220; 74,
 98, 102, 105, 106, 220
 Hollenback, E. H., 72, 99
 Hollomon, J. H., 12; 75, 149, 176, 177,
 178, 180, 181; 76, 51; 77, 202, 203;
 78, 46, 102; 79, 193, 204, 205, 207,
 208; 84, 218
- Homer, 3
 Honda, K., 5
 Hostetter, H. E., 80, 221
 Houdremont, E., 81, 172
 Houghton [E. F.] and Co., Research
 Staff, 82, 63
 Howe, H. M., 5
- Jackson, C. E., 83, 61
 Jaffe, L. D., 12; 75, 149, 176, 177, 178,
 180, 181; 76, 51; 78, 46, 102; 79, 193,
 204, 205, 207, 208; 84, 218
 Janitzky, E. J., 12; 85, 105, 187, 188, 189,
 193, 194
 Jeffries, Z., 16, 172
 Johnson, F., 86, 28
 Johnstin, H. G., 55, 150
 Jominy, W. E., 12, 120; 87, 91, 111, 116,
 117, 118; 88, 112, 116, 118; 89, 120;
 90, 114, 115
- Kenyon, R. L., 135, 24
 Kiefer, J. M., 57, 50, 51
 Klier, E. P., 91, 152
 Koebel, N. K., 92, 31
 Kopecki, E. S., 93, 118
 Kramer, I. R., 94, 104, 121; 95, 104, 121,
 221
 Kurdyumov, G., 10, 148
- Lacy, C. E., 86
 Lamont, J. L., 12; 32, 218, 224; 35, 102,
 121; 36, 104, 121, 221; 37, 87, 88,
 130, 132, 133, 134, 135, 136, 137, 139,
 225; 38, 134, 155, 156, 157, 158, 160,
 161, 162, 163, 164, 165, 166, 167, 171,
 172, 176, 181, 225; 39, 134, 200, 201,
 204; 96, 69, 70, 72, 73, 74, 75, 76, 77,
 78, 79, 80, 81, 82, 83, 122
- Le Chatelier, H., 5
 Leeder, J., 109, 40
 Liedholm, C. A., 97, 50
 Lorig, C. H., 99, 51
 Low, J. R., Jr., 54, 86
 Lyman, T., 91, 152
- Manning, G. K., 98, 119; 99, 51
 Marshall, R. H., 121, 21
 Martens, A., 4, 5
 Martin, A. G., 100, 56
 Mathews, J. A., 101, 151
 McBride, D. L., 72, 99
 McCarthy, D. E., 79, 193, 204, 205, 207,
 208
 McMulkin, F. J., 102, 49, 50
 McMullan, O. W., 103, 123, 124

- Mehl, R. F., 118, 20, 21
 Miller, A. J., 27, 121
 Moersch, C. F., Jr., 119, 174
 Moore, T. L., 28, 87, 88, 89, 99, 123, 124
 Morral, F. R., 104, 47; 105, 46, 47
- Norton, M. R., 76, 51; 79, 193, 204, 205, 207, 208
- Offenhauer, C. M., 148; 34, 173
 Orehoski, M. A., 73, 105, 106, 121, 220; 74, 98, 102, 105, 106, 220
 Osmond, F., 5
- Pappas, J. N., 100, 56
 Parker, C. M., 106, 140
 Patton, W. G., 107, 105, 188, 189, 192, 193, 194, 197, 198
 Payson, P., 108, 199; 109, 40; 110, 48
 Pearsall, E. B., 54, 86
 Pellini, W. S., 54, 86
 Peterson, R. E., 111, 207
 Pliny, 3
 Post, C. B., 112, 123, 125; 113, 123, 127
 Protheroe, H. T., 114, 204
- Réaumur, R. A. F. de, 4
 Riegel, G. C., 29, 99; 116, 206; 117, 206
 Roberts, G. A., 55, 150; 118, 20, 21; 119, 174
 Roberts-Austen, W. C., 5
 Rose, K., 120, 29
 Rose, R. S., 55, 150
 Rosenhain, W., 5
 Rowland, E. S., Jr., 121, 21; 137, 22
 Ruer, R., 5
 Russell, T. F., 11, 54; 122, 63, 122
- Sauveur, A., 5; 123, 34
 Savage, C. H., 110, 48
 Schrader, H., 81, 172
 Scott, H., 54; 124, 56, 57, 116, 117; 125, 218
 Shepherd, B. F., 126, 123, 125; 127, 123, 125; 128, 49, 218; 129, 123, 126, 127
- Siegel, S., 95, 104, 121, 221
 Sims, C. E., 130, 194
 Sisco, F. T., 131, 207; 132, 24, 55, 87, 123, 154, 155
 [The] Society of Automotive Engineers, 133, 139, 141, 142, 143, 144, 235-246; 134, 19, 28, 112, 113, 115, 116, 119, 184, 185, 186, 189, 190, 195, 247-261
 [The] Society of Automotive Engineers, Iron and Steel Division, 141, 247
 [The] Society of Automotive Engineers, Iron and Steel Technical Committee, 124, 247
 Sorby, H. C., 4
 Stewart, H. M., 59, 48
- Tammann, G., 5
 Tchernoff, O., 4
 Tobin, H., 135, 24
 Toleman, S. L., 94, 104, 121
 Troiano, A. R., 10; 62, 37, 47, 48
- Ubben, J. E., 137, 22
 Union Carbide and Carbon Research Laboratories, 151
 United States Steel Corporation, Research Laboratory, 115, 37, 38
 Urban, S. F., 11; 31, 86; 65, 63, 64, 92, 93, 94, 95, 96, 120
- Vilella, J. R., 136, 25
 Von Ludwig, D., 53, 208
- War Engineering Board, Iron and Steel Committee, 141
 Weinman, E. W., 118, 119
 Welchner, J., 121, 21; 137, 22
 Wellauer, E. J., 12; 138, 169, 170, 171, 182, 220
 Wever, F., 17
- Zimmerman, J. G., 139, 27

SUBJECT INDEX

- AISI steels, composition, 247-255
- Alloying elements, addition units for
hardness, 132, 135
effect on isothermal transformation, 46
effect on structure and properties,
85-88
effect on tempered hardness, 154-164
explanation, 171-175
- Alloy steels (*see* Low-alloy steels)
- Alpha iron, 4, 7
- Aluminum, effect on hardening tempera-
ture, 17
- Annealing, effect on machinability, 40, 41
- Annealing cycle, 40, 41
- Annealing temperatures, 16
- Austempering, 42, 49
effect on impact resistance, 199
- Austenite, defined, 7
formation in carbon steels, 21
formation rate, 20
grain size of, determination, 23-26
importance, 26
temperatures for stability of, 16
effect of alloying elements, 17
transformation to bainite, 40-43
transformation to martensite, 40-43,
47-51
variables affecting, 48-51
transformation to pearlite, 38-40
- Austenite transformation, on continuous
cooling, 33, 34, 50
critical cooling rate, 35
effect of alloying elements, 34, 35, 46
effect of carbon, 44-46
effect of cooling rate, 34
effect of grain size, 44-46
isothermal, 35-38
methods of studying, 33-38
nucleation and growth, 43
time-temperature relations, 33
variables affecting, 7, 8
- Austenitizing temperatures, of carbon
and low-alloy steels, 19-22
effect on grain size, 26
- Bainite, formation, 40-43
hardness of, effect of tempering, 153
structure of, 40-43
- Bar diameter, critical, and ideal critical
diameter, 92-96
relation to Jominy test, 116-120
- Boron, effect on hardenability, 106-108
- Calculated hardenability (*see* Harden-
ability, calculated)
- Carbon, base hardness due to, 132-138
effect on austenite transformation,
44-46
effect on hardening temperature, 16
relation to ideal critical diameter, 101
relation to maximum hardness, 87
solubility in iron, 4, 7, 16
- Carbon steel, austenite formation, 21
austenitizing temperatures, 19
hardness, effect of tempering, 150-153
maximum hardness in quenching, 87
normalizing temperatures, 19
strength, effect of alloying elements,
85-88
structure, effect of alloying elements,
85
- Cementite, defined, 7
- Chromium, effect on eutectoid, 18
effect on hardening temperature, 17
effect on quenched hardness, 132, 135
effect on structure and properties of
carbon steel, 85-87
effect on tempering, 155-158, 163,
171-174
factor for hardenability, 102
- Cooling rates in quenching (*see* Quench-
ing)

- Copper, effect on structure and properties of carbon steel, 85-87
- Cracking in quenching, 23
- Critical cooling rate, defined, 8
- Critical diameter, determination, 92-95
index of hardenability, 92-95
(*See also* Ideal critical diameter)
- Elongation, relation to hardenability, 193-195
relation to tensile strength, 194-196
(*See also* Mechanical properties)
- End-quench hardenability test (*see* Jominy test)
- Endurance limit (*see* Fatigue strength)
- Eutectoid, composition and temperature, 17
effect of alloying elements, 18
(*See also* Pearlite)
- Fatigue strength, relation to other properties, 207
relation to structure, 207, 208
variables affecting, 208
- Ferrite, defined, 7
- Gamma iron, 4, 7
temperatures for stability, 16
- Gamma loop, 17
- Grain size, austenitic, determination, 23-26
importance, 26
effect on austenite transformation, 44-46
relation to ideal critical diameter, 101
- Hardenability, advantages of normalizing, 22
bar sizes, for 50% martensite, 98
calculated, accuracy of, 104
actual versus ideal critical diameter, 102
by addition method, 132-139
bar size and ideal diameter, 98
carbon versus 50% martensite, 104
deviation from actual, 131
example of, 103
50% martensite criterion, 98-102
Grossmann's method, 100
hardness versus carbon, 104
multiplying factors, 101-103
calculation of Jominy curve, 130-132
effect of cooling rate, 135-137
carbon-base hardness, 132-138
carbon content and initial hardness, 130
- Hardenability—*Continued*
composition of H steels, 235-237
critical diameter, 92-95
defined, 5, 6
determination by Jominy test, advantages, 113, 122
disadvantages, 122
importance of cooling rates, 116-120
importance of severity of quench, 120-122
method, 113-115
specimens, 113
typical Jominy curves, 114, 115
determination by Rockwell-Inch test, 124
determination by special tests, 123-127
effect of alloying elements, 85
effect of boron, 106-108
effect of carbide solubility, 20
effect on mechanical properties, 183-199
effect of prior structure, 22
effect of tempering, 152-154
evaluation of cooling rates, 10
history, 5
ideal critical diameter, 92-95
determination of, 96-99
and martensite, 98, 105-107
importance of full hardening, 105
index of, 92-95
martensite-base hardness, 132-138
mechanical properties and full or partial hardening, 105
nomographic chart for as-quenched hardness, 137
relation to elongation and reduction of area, 193-195
relation to hardness, 89-92, 183-187
relation to impact resistance, 198-200, 204
relation to tensile strength, 183-187
relation to yield strength, 187-192
of shallow-hardening steels, tests, 123-125
specifying Jominy hardenability, 115
and steel selection, 211-215
variables affecting, 6
- Hardenability bands, development, 139
limits for H steels, 237-246
maximum and minimum in, 142-145
precautions in use of, 145
use in specifications, 143-145
- Hardening, degree of, expressing, 90-92
depth of, effect of carbide solubility, 20
effectiveness of quench, 62-71
furnace atmosphere, effect of, 27

Hardening—Continued

- heating for, essentials, 14–16
- incomplete, effect on mechanical properties, 185–199
- maximum hardness attained, 87
- protective atmospheres, 29–31
- protective coatings, 28
- rate of heating for, 20–23
- salt baths for, 28
- stages in quenching, 56–58
- temperatures for, 16
- variables affecting, 9, 14
- warping and cracking, 23
- (See also Quenching)

Hardness, calculated, by addition method, 132–138

- from ideal critical diameter, 132–134
- of carbon steel, effect of alloying elements, 85–88
- conversions, 256–261
- maximum, effect of carbon content, 87
- of quenched steel, effect of tempering, 149–153
- relation to hardenability, 89–92
- relation to structure, 85–88
- relation to tensile strength, 183–187
- tempered, calculated by addition method, 157, 161–168
- calculated from ideal diameter, 168–171
- effect of alloying elements, 154–164
- effect of time and temperature, 175–181

Heat treatment, early history, 3–6

- (See also Annealing; Hardenability; Hardening; Normalizing; Quenching; Tempering)

Hot working, importance in steel selection, 215**H steels, band limits, 237–246**

- compositions, 235–237

Ideal critical diameter, calculated, relation to actual diameter, 102

- defined, 11
- determination of, 96
- for calculating hardenability, 96–100
- for calculating Jominy curve, 130–132
- for calculating percentage of martensite, 98, 105–107
- for calculating tempered hardness, 168–171
- from chemical composition, 99
- index of hardenability, 92–95
- relation to Jominy test, 120–122

Ideal quench, defined, 11**Impact resistance, calculation of, by addition method, 200–202**

- effect of austempering, 199
- relation to hardenability, 198–200, 204
- relation to tempered hardness, 200
- relation to tensile strength, 197, 204, 226–231
- significance, 205–207
- variables affecting, 198, 199
- (See also Mechanical properties)

Iron-carbon diagram, 16

- Isothermal annealing, 38, 40, 41
- Isothermal transformation, of austenite, 35–38, 49
- to bainite, 40–43
- effect of alloying elements, 46
- to pearlite, 38–40

Isothermal-transformation diagram, classification of steels, 46–47

- features, 36–38
- relation to continuous cooling, 33, 51
- types of, 46

Jominy curve, actual and calculated hardness, 134

- calculation of, by addition method, 132–139
- from ideal critical diameter, 130–132
- determination of quenching severity, 69–78
- effect of carbon content, 132–138
- effect of cooling rate on carbon-base hardness, 135–137
- relation to structure of martensite, 151, 152

Jominy test, advantages, 113, 122

- disadvantages, 122
- method of making, 113–115
- relation to cooling rates, 116–120
- oil and water, 119, 120
- specifying hardenability by, 115
- specimens, 113
- typical curves, 114, 115

Low-alloy steels, classes according to isothermal diagram, 47

- classification by strength, 232
- composition, of H steels, 235–237
- of SAE and AISI steels, 247–255
- hardenability-band limits, 237–246
- hardness and strength, effect of carbon, 185–187
- normalizing and austenitizing temperatures, 19
- selection, for ease in processing, 215–219

- Low-alloy steels, selection,—*Continued*
 for hardenability, 211-215
 for hot-working properties, 215
 importance of cost, 221-223, 233
 for machinability, 216, 217
 non-standard compositions, 220-224
 principles of, 219, 220
 standard compositions, 224-233
 temper brittleness, 202-204
 tempering, effect of alloying elements, 156-164
 tensile strength versus impact resistance, 226-231
- Machinability, effect of annealing, 40, 41
 and steel selection, 216, 217
- Manganese, effect on eutectoid, 18
 effect on hardening temperature, 17
 effect on quenched hardness, 132, 135
 effect on structure and properties of carbon steel, 85-87
 effect on tempering, 158, 161
 factor for hardenability, 102
- Martempering, 49
- Martensite, base hardness of steel due to, 132-138
 defined, 7
 determination of, from ideal critical diameter, 98, 105-107
 formation of, 34-38, 40-43, 47-51
 effect of composition, 48-51
 hardness of, effect of tempering, 149-153
 maximum, 87
 hardness and Jominy curve, 132-138
 heat evolution in tempering, 148
 M_s temperature, variables affecting, 48-51
 structure of, 40-43
 relation to Jominy curve, 151, 152
 three types, 151, 152
 tempering to avoid brittleness, 199
- Mechanical properties, effect of incomplete hardening, 185-199
 effect of rolling direction, 188-196
 effect of tempering, 154, 185, 198
 full and incomplete hardening, importance in steel selection, 211-215
 relation to hardenability, 105, 183-199
 (*See also* Elongation; Fatigue strength; Impact resistance; Reduction of area; Tensile strength; Yield strength)
- Metallography, beginning, 4
- Microscope, first use on steel, 4
- Molybdenum, effect on eutectoid, 18
 effect on hardening temperature, 17
 effect on quenched hardness, 132, 135
 effect on structure and properties of carbon steel, 85-87
 effect on temper brittleness, 203
 effect on tempering, 156-158, 164
 factor for hardenability, 102
- Nickel, effect on eutectoid, 18
 effect on hardening temperature, 17
 effect on quenched hardness, 132, 135
 effect on structure and properties of carbon steel, 85-87
 effect on tempering, 158, 163
 factor for hardenability, 102
- Normalizing, advantages for hardenability, 22
- Normalizing temperatures, for carbon and low-alloy steels, 16, 19
- Notch toughness (*see* Impact resistance)
- Nucleation and growth, 43
- Pearlite, defined, 8
 formation of, 38-40
 hardness of, effect of tempering, 153
 structure of, 38-40
- Phosphorus, effect on structure and properties of carbon steel, 85-87
- Plates, critical and ideal critical diameters, 92-97
- P-V hardenability test, 125-127
- Pyrometry, beginning, 5
- Quenching, bars, severity of quench, 64-71
 carbon steel, maximum hardness attained, 87
 cooling the surface, 56
 cooling-rate gradients, 54
 cooling rates, center and surface, 54
 and Jominy test, 116-120
 oil and water, 119, 120
 critical diameter (*see* Hardenability)
D_u, relation to *D*, 64-68
 effect of boron on hardness gradient, 107-109
 flats, severity of quench, 77
 formula for center cooling rates, 58
 French's method for determining rates, 58-62
 mechanism of cooling, 56
 methods of studying, 54
 plates, severity of quench, 64-68, 77
 severity (H) of, determination, 62-71
 from Jominy tests, 69-71

- Quenching, severity of,—*Continued*
 relation to bar diameter and martensite, 109
 relation to Jominy test, 120–122
 squares, severity of quench, 77
 structure and properties, relation of, 105
 (*See also* Hardening)
- Quenching mediums, cooling rates, oil and water, 57, 60–63
 effectiveness, 56, 62–71
- Quenching temperatures, effect of alloying elements, 17
 effect of carbon, 16
 (*See also* Austenitizing temperatures)
- Reduction of area, relation to hardenability, 193–195
 relation to tensile strength, 194–196
 (*See also* Mechanical properties)
- Rockwell-Inch hardenability test, 124
- SAE steels, composition, 247–255
- Salt baths, for hardening, 28
- Selection of steel, costs compared, 221–223, 233
 factors affecting hot working, 215
 factors determining, 210–213
 general principles, 219, 220
 machinability, 216, 217
 serviceability, 213–215
 steels of non-standard composition, 220–224
 steels of standard composition, 224–233
 variables in processing, 217–219
- Shepherd hardenability tests, 125, 126
- Silicon, effect on eutectoid, 18
 effect on hardening temperature, 17
 effect on quenched hardness, 132, 135
 effect on structure and properties of carbon steel, 85–87
 effect on tempering, 158, 159, 162
 factor for hardenability, 102
- Steel, selection of (*see* Selection of steel)
- Structure, of carbon steel, relation to hardness, 85–88
 of quenched steel, effect of tempering, 147–149
 relation to properties, 5, 8
- Temper brittleness, described, 202–204
 effect of cooling rate, 203, 204
 effect of testing temperature, 204
- Tempered hardness, calculated, effect of time, 175–177
 time-temperature relation, 177–181
 calculation by addition method, 161–168
 calculation from ideal diameter, 168–171
 effect of alloying elements, 154–164
 explanation, 171–175
 effect of time, 175–177
 effect of time and temperature, 175–181
 relation to impact resistance, 200
- Tempering, effect on hardness, 149–153
 effect of initial structure, 153
 effect on mechanical properties, 154, 185–187, 198, 199
 effect on structure, 147–149
 heat evolution in, 148
 stages of, 151–154
 steels of varying hardenability, 153
- Tempering temperature, effect on hardness, 151
- Tensile strength, conversions from hardness, 256–261
 estimation of, 183–186
 relation to elongation and reduction of area, 194–196
 relation to hardenability, 183–187
 relation to hardness, 183–187
 relation to impact resistance, 197, 204, 226–231
 relation to yield strength, 187–192
 variables affecting, 183–187
 (*See also* Mechanical properties)
- Titanium, effect on eutectoid, 18
- Tool steel, hardenability test for, 125–127
 hardness, effect of tempering, 150, 151
- T-T-T diagram (*see* Isothermal-transformation diagram)
- Tungsten, effect on eutectoid, 18
 effect on hardening temperature, 17
- Vanadium, effect on hardening temperature, 17
- Warping, in quenching, 23
- Yield ratio, defined, 187
 of incompletely hardened steels, 188–193
- Yield strength, defined, 187
 relation to hardenability, 187–192
 relation to tensile strength, 187–192
 (*See also* Mechanical properties)

